



EMI TEST REPORT

JQA APPLICATION NO. : 400-00548

Model No. : RM-SRX9010J

Type of Equipment : Remote Controller

Regulations Applied : CFR 47 FCC Rules and Regulations Part 15

FCC ID : GT3CSC002

Applicant : SMK Corporation

Address : 5-5, Togoshi 6-chome, Shinagawa-ku,
Tokyo 142-8511, Japan

Manufacture : SMK Corporation

Address : 5-5, Togoshi 6-chome, Shinagawa-ku,
Tokyo 142-8511, Japan

Received date of EUT : January 9, 2001

Final Judgment : Passed

TEST RESULTS IN THIS REPORT are obtained in use of equipment that is traceable to Electrotechnical Lab. of MITI Japan and Communications Research Lab. of MPT Japan.

The test results only respond to the tested sample. It is not allowed to copy this report even partly without the allowance of JQA EMC Engineering Dept. Testing Div.

TABLE OF CONTENTS

	Page
1 Documentation	
1.1 Test Regulation	<u>3</u>
1.2 General Information	<u>3</u>
1.3 Test Condition	<u>4 - 8</u>
1.4 EUT Modifications / Deviation from Standard	<u>9</u>
1.5 Test results	<u>10</u>
1.6 Summary	<u>11</u>
1.7 Test Configuration / Operation of EUT	<u>12</u>
1.8 EUT Arrangement(Drawing)	<u>13</u>
1.9 Preliminary Test and Test-setup (Drawings)	<u>14 - 19</u>
1.10 EUT Arrangement (Photographs)	<u>20 - 21</u>
2 Test Data	
2.1 AC Power Line Conducted Emission 0.45 MHz - 30 MHz	<u>N/A</u>
2.2 Radiated Emission (Electric Field)	<u>22 - 25</u>
2.3 Frequency Stability	<u>N/A</u>
2.4 Occupied Bandwidth	<u>26 - 27</u>

1 DOCUMENTATION**1.1 TEST REGULATION**

FCC Rules and Regulations Part 15 Subpart A and C (June 23, 1989) Intentional Radiators

Test procedure :

AC power line conducted emission, radiated emission, frequency stability and occupied bandwidth tests were performed according to the procedures in ANSI C63.4-1992.

1.2 GENERAL INFORMATION**1.2.1 Test facility :**

- 1) Test Facility located at EMC Engineering Dept. Testing Div. :
 - No.2 and 3 Anechoic Chambers(3 meters Site).
 - Shielded Enclosure.

Expiration date of FCC test facility filing : June 04, 2002

- 2) EMC Engineering Dept. Testing Div. is recognized under the National Voluntary Laboratory accreditation Program for satisfactory compliance established in title 15, Part 285 Code of Federal Regulations.

NVLAP Lab Code : 200189-0 (Effective through : June 30, 2001)

1.2.2 Description of the Equipment Under Test (EUT) :

- | | |
|--------------------------------------|---------------------------------------|
| 1) Type of Equipment | : Remote Controller |
| 2) Product Type | : Pre-Production |
| 3) Category | : Security/Remote Control Transmitter |
| 4) EUT Authorization | : Certification |
| 5) FCC ID | : GT3CSC002 |
| 6) Trade Name | : JVC |
| 7) Model No. | : RM-SRX9010J |
| 8) Operating Frequency Range | : 423.22 MHz |
| 9) Highest Frequency Used in the EUT | : 423.22 MHz |
| 10) Serial No. | : None |
| 11) Date of Manufacture | : - |
| 12) Power Rating | : DC 3.0V(Battery) |
| 13) EUT Grounding | : None |

1.2.3 Definitions for symbols used in this test report :

- x - indicates that the listed condition, standard or equipment is applicable for this report.
- indicates that the listed condition, standard or equipment is not applicable for this report.

1.3 TEST CONDITION

1.3.1 The measurement of the AC Power Line Conducted Emission

- was performed in the following test site.

- was not applicable.

Test location :

Safety Testing Center EMC Engineering Dept. Testing Div.
21-25, Kinuta 1-chome, Setagaya-ku, Tokyo 157-8573, Japan

- Shielded Enclosure

- Anechoic Chamber No. 2 (portable Type)

Used test instruments :

Type	Model No.	Manufacturer	Serial No.	Last Cal.	Interval
<input type="checkbox"/> - Test Receiver	ESH-2	Rohde & Schwarz	880370/016	Sep. 2000	1 Year
<input type="checkbox"/> - Test Receiver	ESH-3	Rohde & Schwarz	881460/030	June 2000	1 Year
<input type="checkbox"/> - LISN(for Peripheral)	KNW-407	Kyoritsu Electrical	8-833-6	Apr. 2000	1 Year
<input type="checkbox"/> - LISN(for EUT)	KNW-407	Kyoritsu Electrical	8-855-2	Apr. 2000	1 Year
<input type="checkbox"/> - LISN	KNW-407	Kyoritsu Electrical	8-757-1	Apr. 2000	1 Year
<input type="checkbox"/> - RF Cable	3D-2W	Fujikura	155-21-006E0	Apr. 2000	1 Year
<input type="checkbox"/> - RF Cable	3D-2W	Fujikura	155-21-007E0	Apr. 2000	1 Year
<input type="checkbox"/> - 50ohm Termination		SUHNER	154-06-501E0	Jan. 2000	1 Year
<input type="checkbox"/> - 50ohm Termination		SUHNER	154-06-502E0	Jan. 2000	1 Year

1.3.2 The measurement of the Radiated Emission(9 kHz - 30 MHz)

- was performed in the following test site.

- was not applicable.

Test location :

Safety Testing Center EMC Engineering Dept. Testing Div.
21-25, Kinuta 1-chome, Setagaya-ku, Tokyo 157-8573, Japan

- Anechoic Chamber No. 2 (3 meters)

- Anechoic Chamber No. 3 (3 meters)

Validation of Site Attenuation :

1) Last Confirmed Date : N/A

2) Interval : N/A

Used test instruments :

Type	Model No.	Manufacturer	Serial No.	Last Cal.	Interval
<input type="checkbox"/> - Test Receiver	ESH-2	Rohde & Schwarz	880370/016	Sep. 2000	1 Year
<input type="checkbox"/> - Antenna	HFH2-Z2	Rohde & Schwarz	881058/62	Nov 2000	1 Year

COPY

1.3.3 The measurement of the Radiated Emission(30 MHz - 1000 MHz)

- was performed in the following test site.
- was not applicable.

Test location :

Safety Testing Center EMC Engineering Dept. Testing Div.
 21-25, Kinuta 1-chome, Setagaya-ku, Tokyo 157-8573, Japan

- Anechoic Chamber No. 2 (3 meters)
- Anechoic Chamber No. 3 (3 meters)

Validation of Site Attenuation :

- 1) Last Confirmed Date :March, 2000
- 2) Interval :1 year

Used test instruments :

Type	Model No.	Manufacturer	Serial No.	Last Cal.	Interval
<input type="checkbox"/> - Test Receiver	ESH-2	Rohde & Schwarz	880370/016	Sep. 2000	1 Year
<input type="checkbox"/> - Test Receiver	ESV	Rohde & Schwarz	872148/039	May 2000	1 Year
<input checked="" type="checkbox"/> - Test Receiver	ESVS10	Rohde & Schwarz	826148/002	May 2000	1 Year
<input type="checkbox"/> - Test Receiver	ESVP	Rohde & Schwarz	881487/004	May 2000	1 Year
<input type="checkbox"/> - Test Receiver	ESVP	Rohde & Schwarz	881487/005	May 2000	1 Year
<input checked="" type="checkbox"/> - Antenna	KBA-511A	Kyoritsu Electrical	0-170-1	Nov. 2000	1 Year
<input type="checkbox"/> - Antenna	KBA-511A	Kyoritsu Electrical	0-201-13	Nov. 2000	1 Year
<input checked="" type="checkbox"/> - Antenna	KBA-611	Kyoritsu Electrical	0-147-14	Nov. 2000	1 Year
<input type="checkbox"/> - Antenna	KBA-611	Kyoritsu Electrical	0-210-5	Nov. 2000	1 Year
<input type="checkbox"/> - Biconical Antenna	BBA9106	Schwarzbeck	VHA91031150	May 2000	1 Year
<input type="checkbox"/> - Biconical Antenna	BBA9106	Schwarzbeck	11905078E0	May 2000	1 Year
<input type="checkbox"/> - Log-Periodic Antenna	UHALP9107	Schwarzbeck	11905079E0	May 2000	1 Year
<input type="checkbox"/> - Log-Periodic Antenna	UHALP9107	Schwarzbeck	11905110	May 2000	1 Year
<input checked="" type="checkbox"/> - RF Cable	5D-2W	Fujikura	155-21-001E0	Feb. 2000	1 Year
<input type="checkbox"/> - RF Cable	5D-2W	Fujikura	155-21-002E0	Feb. 2000	1 Year

1.3.4 The measurement of the Radiated Emission(Above 1000 MHz)

 x - was performed in the following test site.
 ___ - was not applicable.

Test location :

Safety Testing Center EMC Engineering Dept. Testing Div.
 21-25, Kinuta 1-chome, Setagaya-ku, Tokyo 157-8573, Japan

 x - No. 2 site (3 meters)
 ___ - No. 3 site (3 meters)

Validation of Site Attenuation :

1) Last Confirmed Date : N/A
 2) Interval : N/A

Used test instruments :

Type	Model No.	Manufacturer	Serial No.	Last Cal.	Interval
<u> x </u> - Spectrum Analyzer	8560E	Hewlett Packard	3240A00189	Nov. 2000	1 Year
<u> x </u> - Spectrum Analyzer	8566B	Hewlett Packard	2140A01091	Apr. 2000	1 Year
<u> x </u> - RF Pre-selector	85685A	Hewlett Packard	2648A00522	Apr. 2000	1 Year
<u> x </u> - Spectrum Analyzer	8566B	Hewlett Packard	2747A05855	June 2000	1 Year
<u> x </u> - RF Pre-selector	85685A	Hewlett Packard	2091A00933	June 2000	1 Year
<u> x </u> - Log-Periodic Antenna	HL 025	Rohde & Schwarz	340182/015	Nov. 2000	1 Year
<u> x </u> - RF Amplifier	DBP-0102N5334272B	DBS Microwave Inc.	012	Jun. 1999	1 Year
<u> x </u> - RF Amplifier	WJ-6882-814	Watkins-Johnson	0414	June 2000	1 Year
<u> x </u> - RF Amplifier	WJ-5315-556	Watkins-Johnson	106	June 2000	1 Year
<u> x </u> - RF Amplifier	WJ-5320-307	Watkins-Johnson	645	June 2000	1 Year
<u> x </u> - RF Cable(10m)	S 04272B	Suhner	155-21-011E0	May 2000	1 Year
<u> x </u> - RF Cable(2m)	SUCOFLEX 104	Suhner	155-21-012E0	May 2000	1 Year
<u> x </u> - RF Cable(1m)	SUCOFLEX 104	Suhner	155-21-013E0	May 2000	1 Year

1.3.5 The measurement of the Frequency Stability

- was performed.

- was not applicable.

Used test instruments :

Type	Model No.	Manufacturer	Serial No.	Last Cal.	Interval
<input type="checkbox"/> - Frequency Counter	53131A	Hewlett Packard	3546A11807	May 2000	1 Year
<input type="checkbox"/> - Oven	-	Ohnishi Co. Ltd.	-	Aug. 2000	1 Year
<input type="checkbox"/> - DC Power Supply	6628A	Hewlett Packard	3224A00284	July 2000	1 Year

1.3.6 The measurement of the Occupied Bandwidth

- was performed.

- was not applicable.

Used test instruments :

Type	Model No.	Manufacturer	Serial No.	Last Cal.	Interval
<input type="checkbox"/> - Spectrum Analyzer	8560E	Hewlett Packard	3240A00189	Nov. 2000	1 Year
<input type="checkbox"/> - Spectrum Analyzer	8566B	Hewlett Packard	2140A01091	Apr. 2000	1 Year
<input checked="" type="checkbox"/> - Spectrum Analyzer	8566B	Hewlett Packard	2747A05855	June 2000	1 Year
<input type="checkbox"/> - Function Generator	3325A	Hewlett Packard	2512A21776	May 2000	1 Year
<input type="checkbox"/> - FM Linear Detector	MS61A	Anritsu Corp.	M77486	Sep. 2000	1 Year
<input type="checkbox"/> - Level Meter	ML422C	Anritsu Corp.	M87571	June 2000	1 Year



1.4 EUT MODIFICATION / Deviation from Standard

1.4.1 EUT MODIFICATION

- No modifications were conducted by JQA to achieve compliance to Class B levels.
- To achieve compliance to Class B levels, the following changes were made by JQA during the compliance test.

The modifications will be implemented in all production models of this equipment.
--

Applicant :	Date :
-------------	--------

Typed Name :	Position :
--------------	------------

1.4.2 Deviation from Standard:

- No deviations from the standard described in clause 1.1.
- The following deviations were employed from the standard described in clause 1.1:

1.6 SUMMARY**General Remarks :**

The EUT was tested according to the requirements of FCC Rules and Regulations Part 15 Subpart A and C (June 23, 1989) under the test configuration, as shown in clause 1.7 to 1.10.

The conclusion for the test items which are required by the applied regulation is indicated under the final judgment.

Final Judgment :

The "as received" sample;

- x - fulfill the test requirements of the regulation mentioned on clause 1.1.
- fulfill the test requirements of the regulation mentioned on clause 1.1, but with certain qualifications.
- doesn't fulfill the test regulation mentioned on clause 1.1.

Begin of testing : January 9, 2001

End of testing : January 9, 2001

- JAPAN QUALITY ASSURANCE ORGANIZATION -
Approved by:

Signatories:
Issued by:



Masaaki Takahashi
Manager
JQA EMC Engineering Dept.



Shigeru Osawa
Assistant Manager
JQA EMC Engineering Dept.

1.7 TEST CONFIGURATION / OPERATION OF EUT**1.7.1 Test Configuration**

The equipment under test (EUT) consists of :

Item	Manufacturer	Model No.	FCC ID	Serial No.
Remote Controller	SMK Corporation	RM-SRX9010J	GT3CSC002	None

1.7.2 Operating condition

Power supply Voltage : 3.0 VDC(Battery)

The tests have been carried out under the transmitting condition.

COPY

1.8 EUT ARRANGEMENT (DRAWINGS)

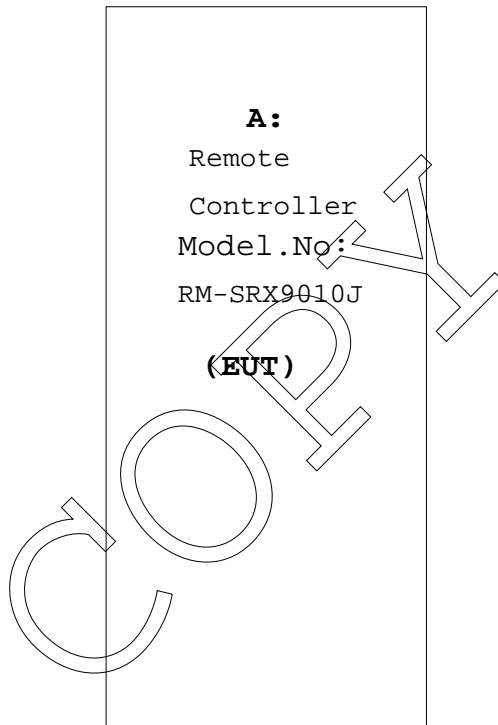

1.9 PRELIMINARY TEST AND TEST-SETUP (DRAWINGS)

1.9.1 AC Power Line Conducted Emission (450 kHz - 30 MHz) :

According to description of ANSI C63.4-1992 sec.13.1.3.1, the AC power line preliminary conducted emissions measurements were carried out.

The preliminary conducted measurements were performed using the spectrum analyzer to observe the emission characteristics of the EUT.

The EUT configuration, cable configuration and mode of operation were determined for producing the maximum level of emissions. These configurations were used for final AC power line conducted emissions measurements.

Shielded Enclosure

- Side View -

Vertical
Ground
Plane

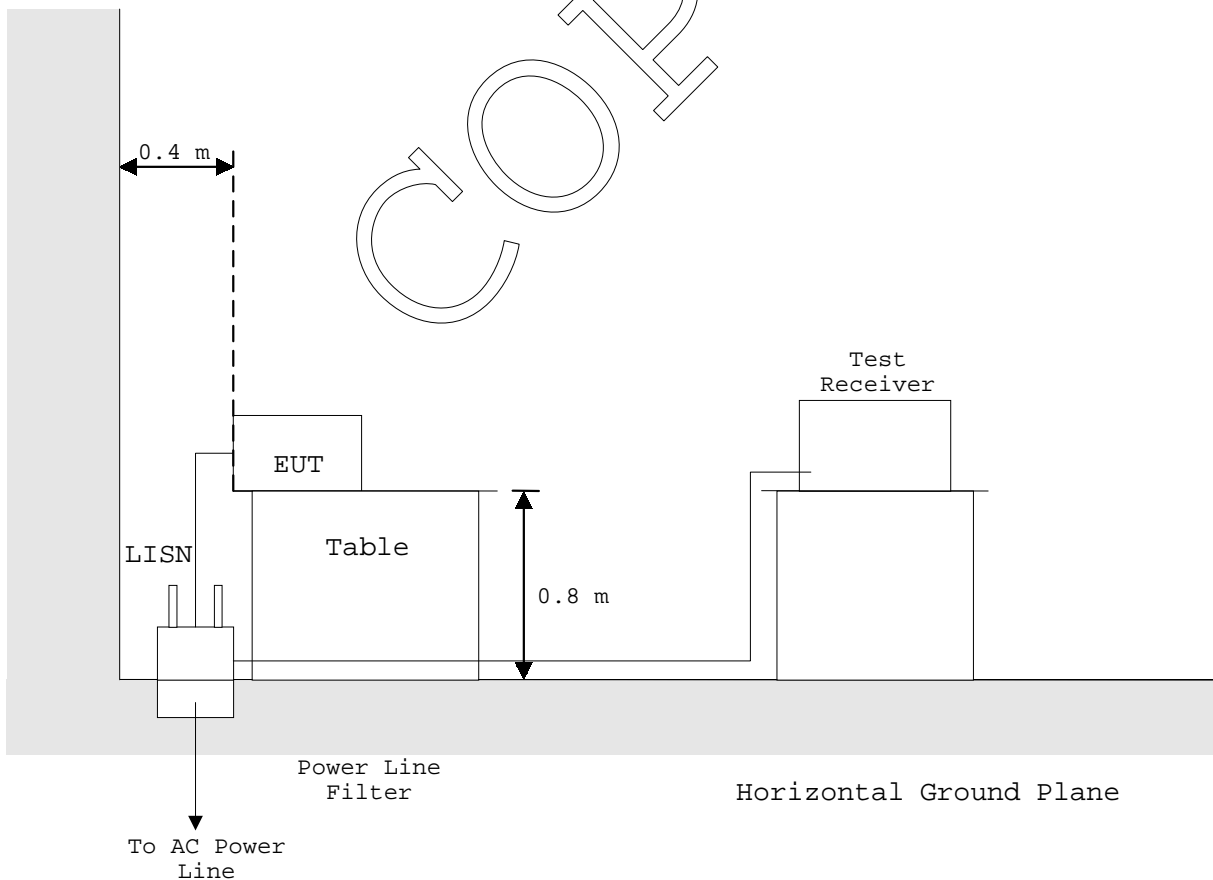

1.9.2 Radiated Emission (9 kHz - 30 MHz) :

According to description of ANSI C63.4-1992 sec.13.1.4.1, the preliminary radiated emissions measurement were carried out. The preliminary radiated measurements were performed at the measurement distance that specified for compliance to determine the emission characteristics of the EUT.

The EUT configuration, cable configuration and mode of operation were determined for producing the maximum level of emissions. These configurations were used for the final radiated emissions measurements.

- Side View -

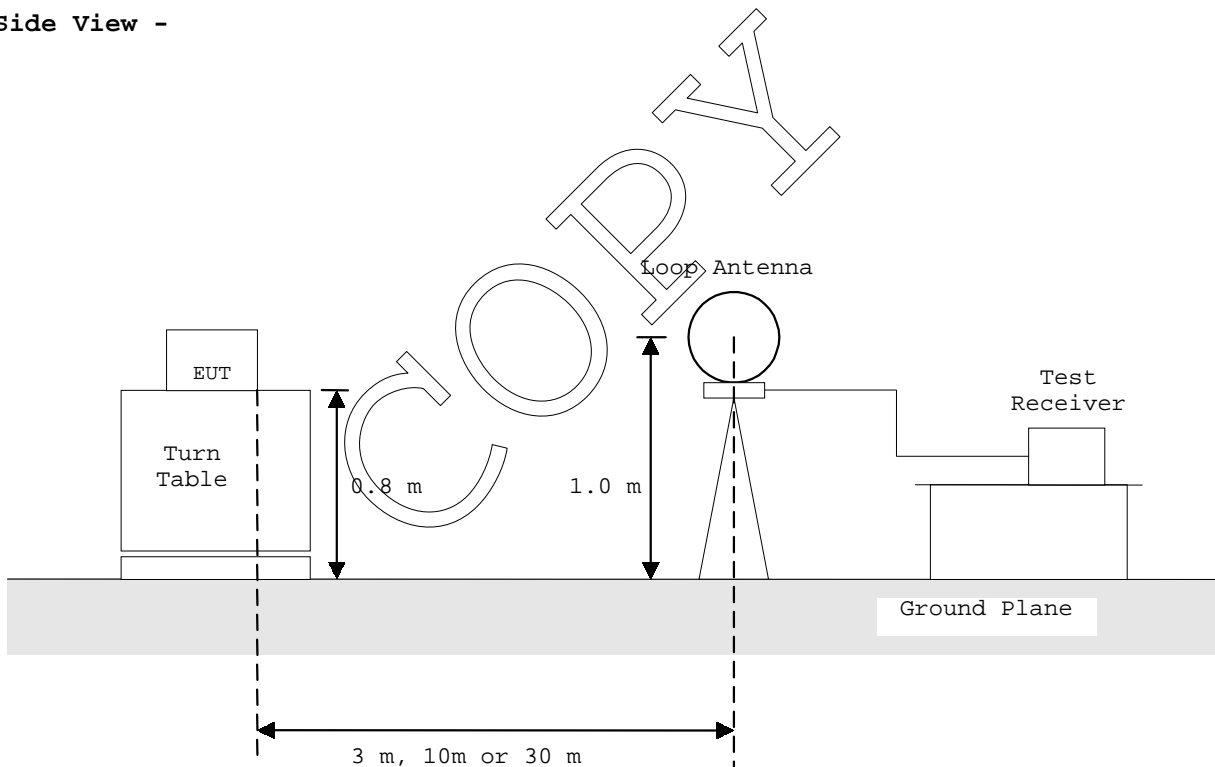

1.9.3 Radiated Emission (30 MHz - 1000 MHz) :

According to description of ANSI C63.4-1992 sec.13.1.4.1, the preliminary radiated emissions measurement were carried out. The preliminary radiated measurements were performed at the measurement distance that specified for compliance to determine the emission characteristics of the EUT.

The EUT configuration, cable configuration and mode of operation were determined for producing the maximum level of emissions. These configurations were used for the final radiated emissions measurements.

Anechoic Chamber

- Side View -

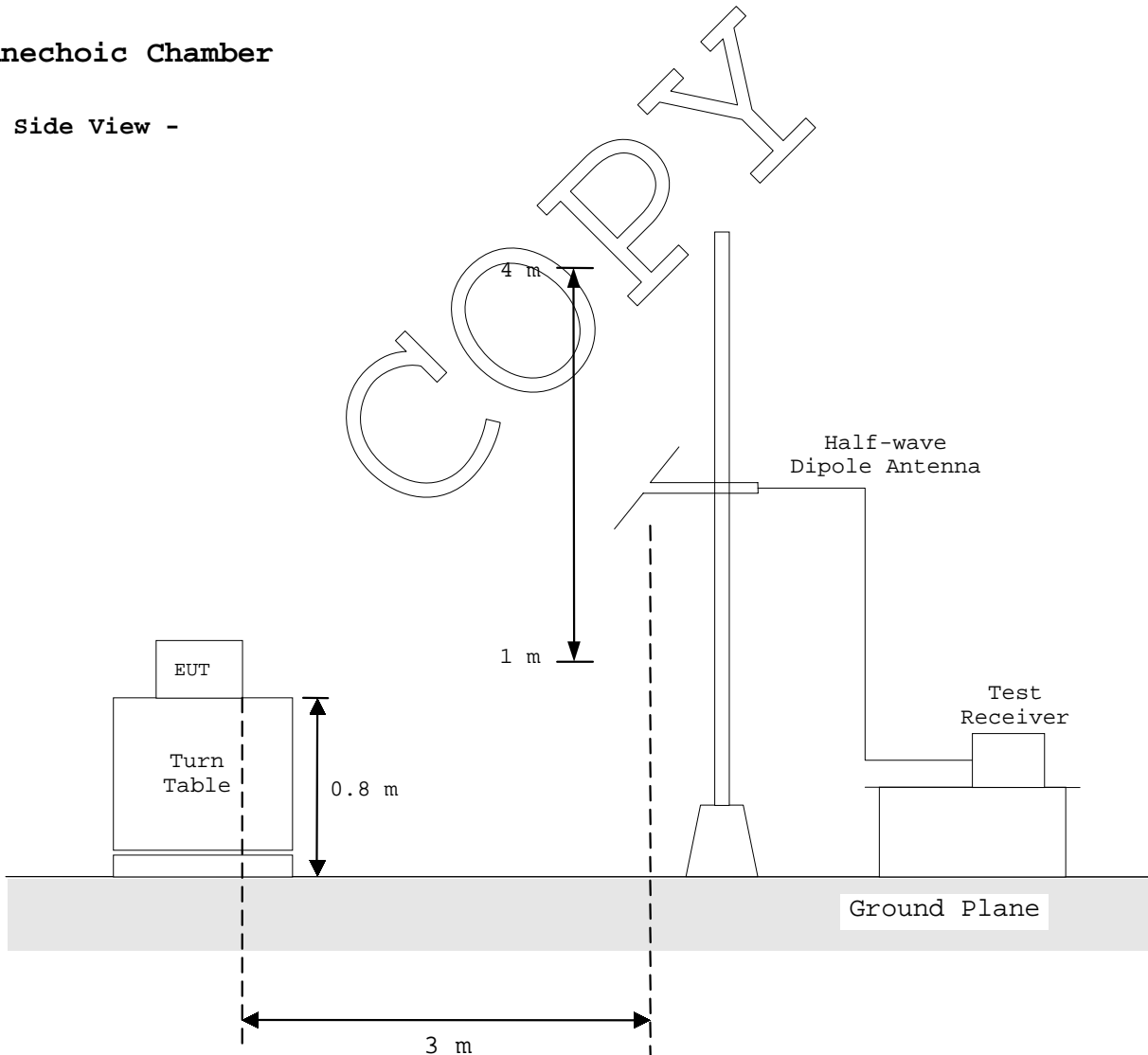

1.9.4 Radiated Emission (Above 1 GHz) :

According to description of ANSI C63.4-1992 sec.13.1.4.1, the preliminary radiated emissions measurements were carried out. The preliminary radiated measurements were performed at the measurement distance that specified for compliance to determine the emission characteristics of the EUT.

The EUT configuration, cable configuration and mode of operation were determined for producing the maximum level of emissions. These configurations were used for the final radiated emissions measurements.

Anechoic Chamber

- Side View -

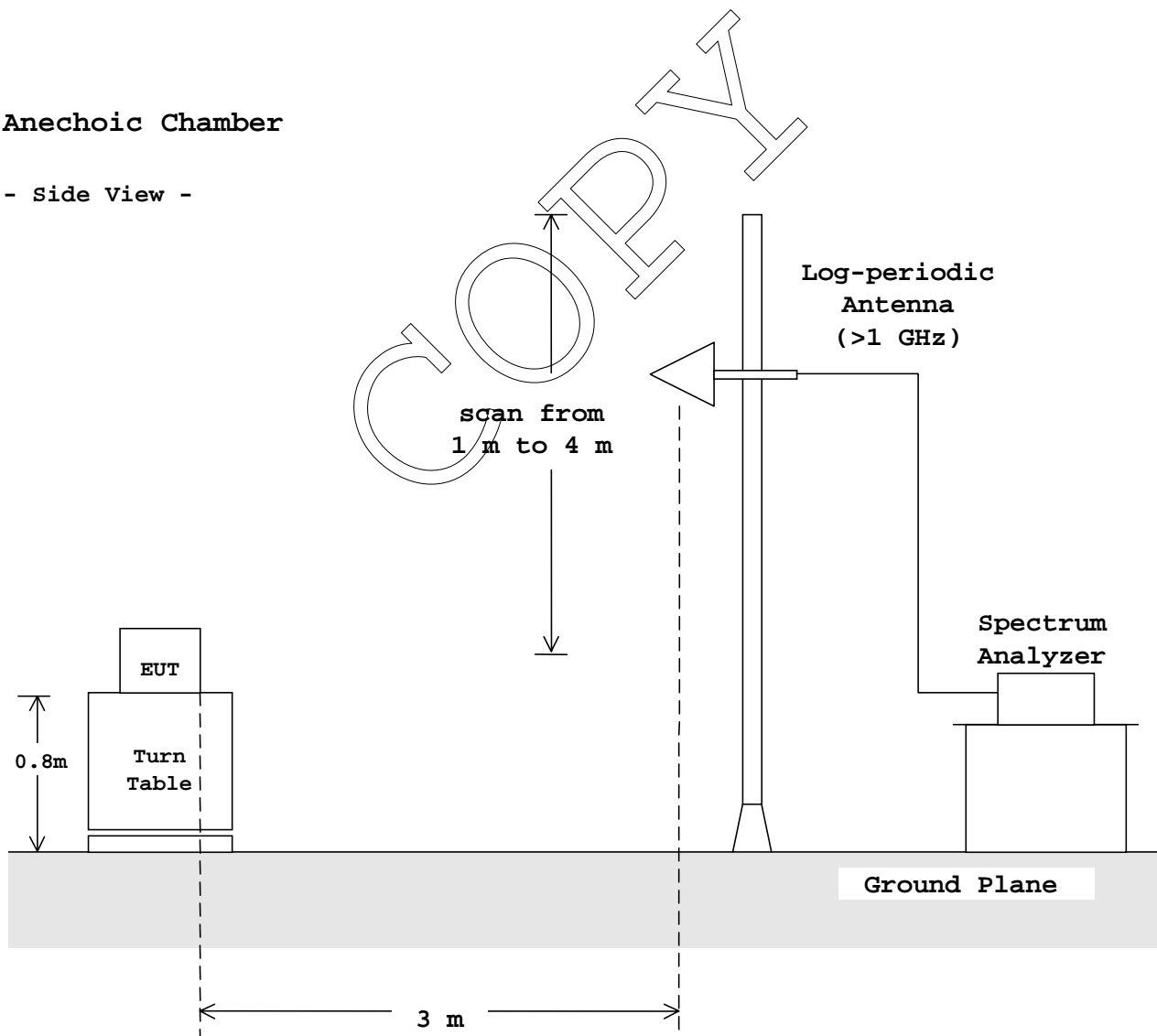

1.9.5 Frequency Stability :

According to description of ANSI C63.4-1992 sec.13.1.5 and sec.13.1.6, the frequency stability measurements were carried out. By using frequency counter with suitable RF amplifier, the carrier frequency of the transmitter under test was measured with a temperature variation of -20°C to $+50^{\circ}\text{C}$ at the normal supply voltage, and if required, with a variation in the primary voltage from 85 % to 115 % the rated supply voltage at the temperature of $+20^{\circ}\text{C}$.

These measurements were carried out after allow sufficient time (approximately 1 hour) for the temperature of the chamber to stabilize.

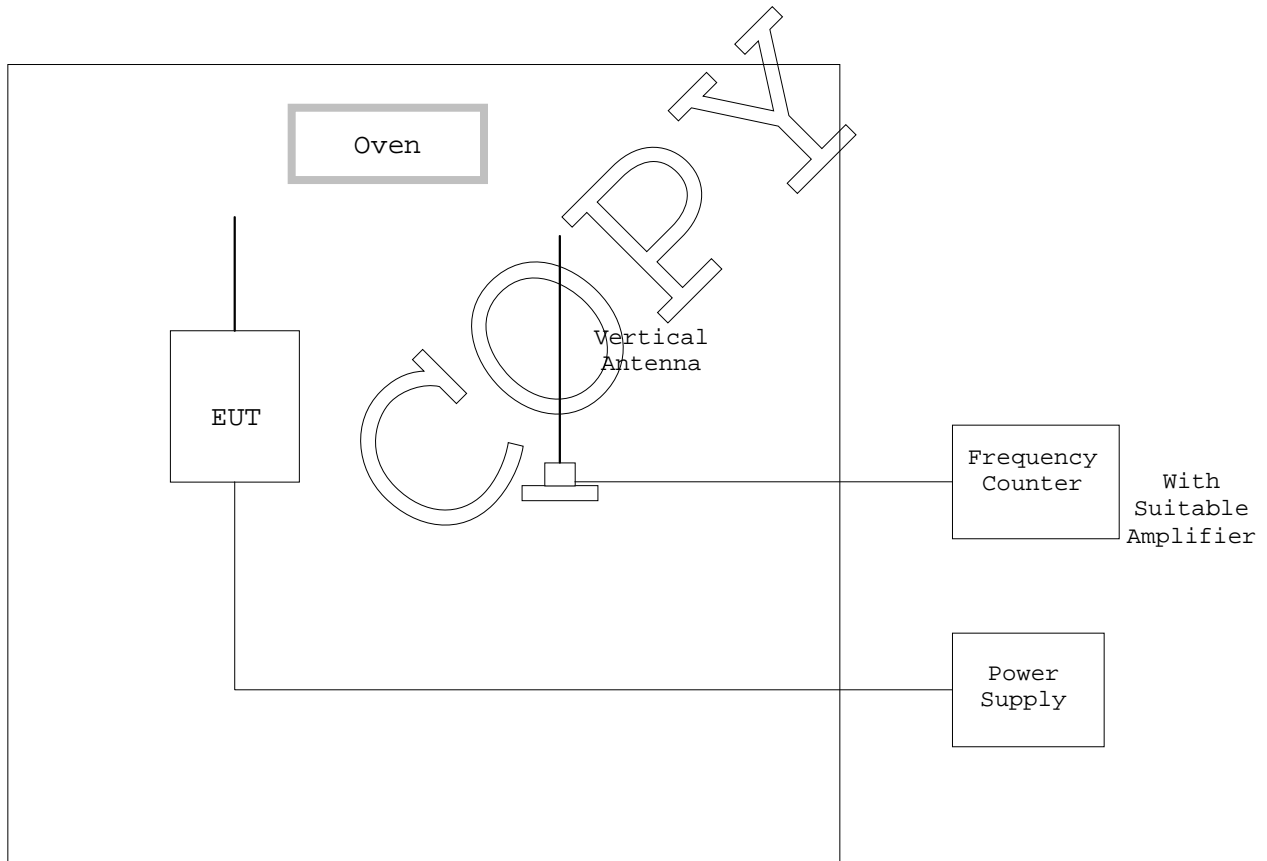

1.9.6 Occupied Bandwidth :

According to description of ANSI C63.4-1992 sec.13.1.7, the occupied bandwidth measurements were carried out. By using a spectrum analyzer with a vertical antenna for picking up the signal, the measurements of the emission were made under the transmitting modes of the EUT.

The resolution bandwidth of spectrum analyzer was set to the value specified in sec.13.1.7.

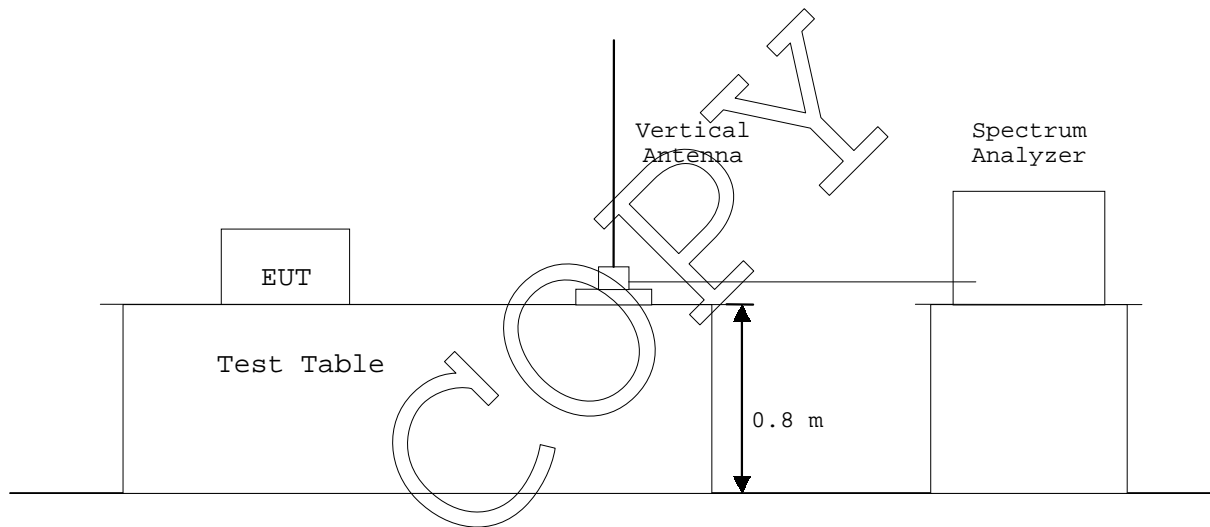

1.10 TEST ARRANGEMENT (PHOTOGRAPHS)

PHOTOGRAPHS OF EUT CONFIGURATION FOR RADIATED EMISSIONS MEASUREMENT

Photograph present configuration with maximum emission







TEST DATA

2.2 Radiated Emissions Measurement

Date : January 9, 2001

Temp. : 20 °C Humi. : 53 %

Operating Frequency : 423.22 MHz
 Distance of Measurement : 3.0 meters

Frequency (MHz)	Correction Factor (dB/m)	Meter Reading		Factor* (dB/m)	Limits (dBµV/m)	Field Strength at 3 m	
		Horiz. (dBµV)	Vert. (dBµV)			Horiz. (dBµV/m)	Vert. (dBµV/m)
Fundamental							
423.220	23.7	54.6	56.4	-13.4	80.5	64.9	66.7
Harmonics & other Frequency components							
846.440	31.4	24.4	24.7	-13.4	60.5	42.4	42.7
1269.660	26.8	29.9	30.3	-13.4	60.5	43.3	43.7
1692.880	30.4	32.9	36.8	-13.4	54.0**	49.9	53.8
2116.100	-13.8	74.5	71.8	-13.4	60.5	47.3	44.6
2539.320	-12.2	73.1	74.5	-13.4	60.5	47.5	48.9
2962.540	-10.3	68.6	67.3	-13.4	60.5	44.9	43.6
3385.760	-8.6	67.1	65.4	-13.4	60.5	45.1	43.4
3808.980	-7.0	62.8	61.3	-13.4	54.0**	42.4	40.9
4232.200	-5.6	56.3	54.9	-13.4	54.0**	37.3	35.9

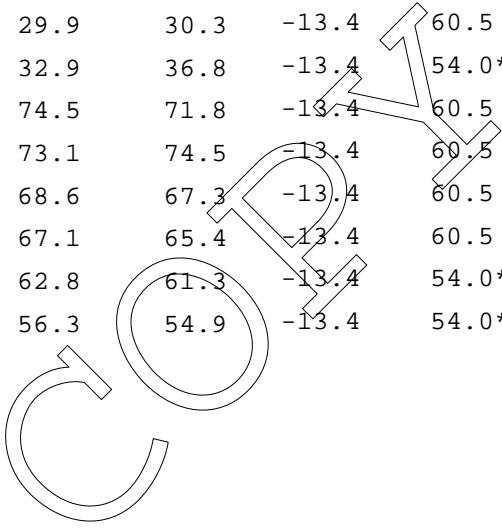

- Note: 1. The spectrum was checked from 30 MHz to tenth harmonics.
All emissions not listed were found to be more than 20 dB below the limits.
2. The symbol of "<" means "or less".
3. The cable loss and amplifier gain were included in the correction factor.
4. Sample calculation :
at 423.220 MHz
 $Cf + Mr + F = 23.7 + 56.4 - 13.4 = 66.7 \text{ dB}\mu\text{V/m}$
Where,
Cf = Correction Factor
Mr = Meter Reading
F = Peak to Average Factor
5. "***": The factor due to the pulsed waveform as shown in the attached sheet.
6. Measuring Instrument Setting:
Detector function Peak
IF Bandwidth : 1 MHz
7. "***": Restricted Bands

Tested by :

Shigeru Osawa
Testing Engineer

Radiated Fundamental & Spurious Emissions

FCC ID : GT3CSC002

Operating Frequency : 423.220 MHz

FUNDAMENTAL LIMITS [Sec.15.231(b)] : 10551uV/m

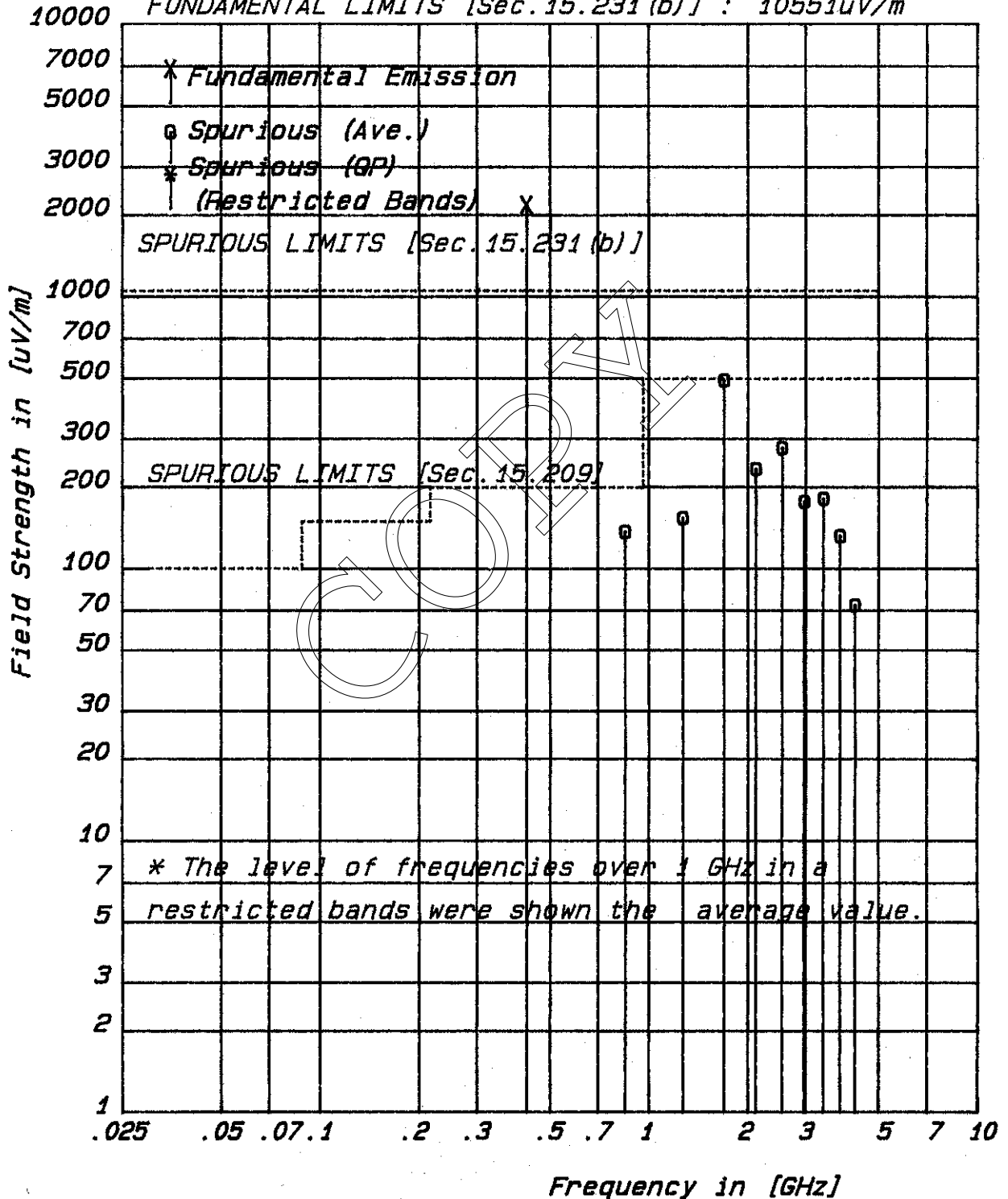

The encoded waveform in the time domain

FCC ID : GT3CSC002
Model : RM-SRX9010J

Mode of EUT : Transmit

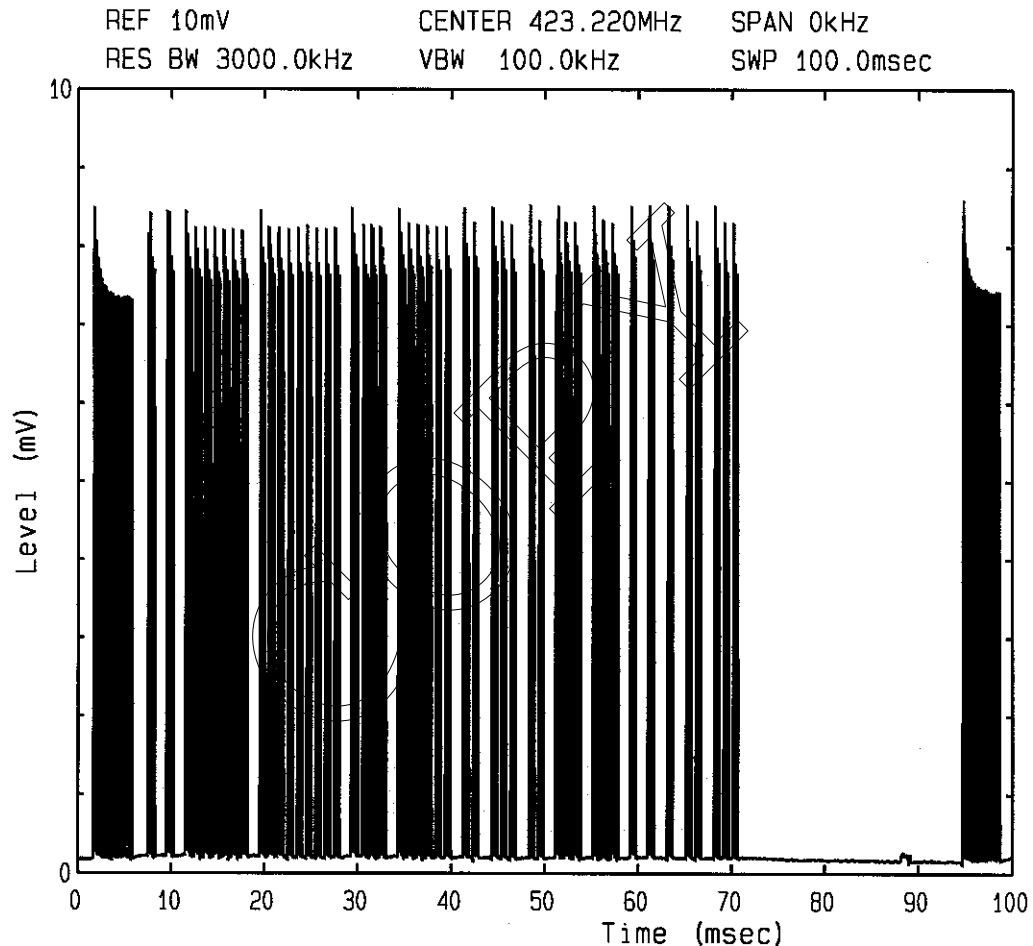

The above waveform indicates the case when field strength averaged over 100 milliseconds was maximum value. In order to obtain the peak to average factor, calculation of the period of total on-time was computed by personal computer. Results was obtained by following.

$$\begin{aligned} \text{Duty cycle} &= (\text{Maximum total on-time} / 100 \text{ msec}) \times 100 \\ &= (21.3 \text{ msec} / 100 \text{ msec}) \times 100 = 21.3 \% \end{aligned}$$

Therefore

$$\text{Factor is } 20 \log (0.2130) = -13.4 \text{ dB}$$

2.4 Occupied Bandwidth Measurement

Date : January 9, 2001
Temp.: 20 °C Humi.: 53 %

Measurements Results :

Specified Limits : 0.25 % of the fundamental frequency
423.22 MHz x 0.0025 = 1058.05 kHz

Refer to the attached graphs.

Tested by :

Shigeru Osawa

Shigeru Osawa
Testing Engineer

COPY

Emission Limitation

FCC ID : GT3CSC002
Model : RM-SRX9010J

Mode of EUT : Transmit

