

FCC/MELLON

DEC 28 1998



FACTORY CONTROL NO. : FVD-98-F031  
FCC ID. : GSS17027

**COPY**

**AKZO NOBEL**

---

# TEST REPORT

---

REPORT NUMBER : AKL-398205  
APPLICANT : MATSUSHITA ELECTRIC INDUSTRIAL CO.,LTD.  
MODEL NUMBER : VCDTS21419-1\*  
FCC ID : GSS17027  
REGULATION : FCC Part15B Class B  
Canada ICES-003 Class B

Conducted Emission Test  
Radiated Emission Test



NVLAP accreditation is valid only  
FCC Part15(Digital Devices),  
CISPR22, and AS/NZS 3548  
test reports.

Akzo Kashima Limited  
EMC Division  
Nagano Site

3226, Yokokawa, Tatsuno-machi, Kamiina-gun  
Nagano-ken, 399-0511 Japan

**TABLE OF CONTENTS**

---

	Page
SECTION 1. TEST CERTIFICATION.....	3
SECTION 2. CONCLUSION.....	4
SECTION 3. EQUIPMENT UNDER TEST.....	5
SECTION 4. SUPPORT EQUIPMENT USED.....	6
SECTION 5. CABLE (S) USED .....	7
SECTION 6. CONSTRUCTION OF EQUIPMENT .....	8
SECTION 7. OPERATING CONDITIONS.....	10
SECTION 8. TEST PROCEDURE(S) .....	11
SECTION 9. EVALUATION OF TEST RESULTS .....	15
SECTION 10. PHOTOGRAPHS OF MAXIMUM EMISSION SET-UP.....	31
SECTION 11. INSTRUMENTS USED FOR FINAL TEST.....	33
SECTION 12. UNCERTAINTY OF MEASUREMENT .....	34
SECTION 13. VALIDITY OF TEST REPORT .....	35
SECTION 14. DESCRIPTION OF TEST LABORATORY.....	36

---

## SECTION 1. TEST CERTIFICATION

## APPLICANT INFORMATION

Company : MATSUSHITA ELECTRIC INDUSTRIAL CO.,LTD.  
 Address : 6-4-1 Tsujidomotomachi, Fujisawa-shi, Kanagawa-ken,  
 251-0043 Japan  
 Telephone number : +81 466 35 1303  
 Fax number : +81 466 35 5557

## DESCRIPTION OF TEST ITEM

Kind of equipment : 17" Color CRT Display Monitor  
 Condition of equipment : Production  
 Type : Table-Top  
 Trademark : ViewSonic  
 FCC ID : GSS17027  
 Model number : VCDTS21419-1\*  
 Serial number : FP8420003

## TEST PERFORMED

Location : Nagano No. 3 Test Site (FCC File No. : 31040/SIT)  
 Test started : November 19, 1998  
 Test completed : November 20, 1998  
 Purpose of test : FCC Docket 87-389  
 and Canadian Interference-Causing Equipment Regulations  
 Regulation : FCC Part15B Class B and Canada ICES-003 Class B  
 Unintentional Radiators  
 Test setup : ANSI C63.4-1992

Report file number : AKL-398205

Report issue date : November 27, 1998

Test engineer : Chikai Akatsu

Report approved by : Yoshio Kowase  
 [Site Manager]

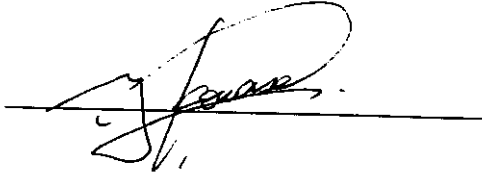
This equipment complies with above standard or regulation under the test condition or test configuration shown on this test report.

## SECTION 2. CONCLUSION

This test report clearly shows that the EUT is in compliance with the FCC Part 15B Class B specification and the Canada ICES-003 Class B specification.

Traceability to national standards of test result is achieved by means of calibration traceability to national standards.

The minimum margins to the limits are as follows:

### Conduction measurement

1600×1200(D-Sub 1.5m, 1.8m) mode 10.2 dB at 0.3761 MHz

### Radiation measurement

1600×1200(BNC) mode 1.6 dB at 112.37 MHz

Note : See Section 9 for details.

**SECTION 3. EQUIPMENT UNDER TEST**

The equipment under test (EUT) consisted of the following equipment.  
Indication in the following left side column corresponds to Section 6.

Symbol Item	Model No.	Serial No.	FCC ID / DoC	Manufacturer
A) CRT Display Monitor	VCDTS21419-1*	FP8420003	GSS17027	Matsushita

Power ratings of EUT : AC 100 - 240V, 50/60 Hz, 2.2A

DoC : Device for Declaration of Conformity

**3.1 Port(s)/Connector(s) :**

Port name	Connector type	Connector pin	Remarks
Video	Mimi D-Sub	15pin	
Video	BNC		R, G, B, H.sync, V.sync

**3.2 Oscillator(s)/Crystal(s) :**

Test mode (dot)	Dot clock frequency	Vertical frequency	Horizontal frequency	Remarks
640×480	25.17 MHz	60 Hz	31.5 kHz	
1600×1200	202.5 MHz	75 Hz	93.7 kHz	Highest Frequency

**SECTION 4. SUPPORT EQUIPMENT USED**

The EUT was supported by the following equipment during the test.  
Indication in the following left side column corresponds to Section 6.

Symbol Item	Model No.	Serial No.	FCC ID / DoC	Manufacturer
B) Computer	D4553A	SG73100685	DoC	Hewlett Packard
C) Keyboard	DFSX1B04ZASG	L4000091	C9SKB8720	Matsushita
D) Modem	C202A	010948	BKM552C202A	EPSON
E) Printer	P850A	1YLY193767	BKMP850A	EPSON
F) Mouse	C3751B	LZA72258684	DZL211029	Hewlett Packard
G) Video Card	Stealth 3D 3000/DIAMOND	None	FTUPCI30208	Diamond Multimedia System, Inc.
H) USB Pedestal	TY-LD64VSU	FX8620001	ACJ93312138	ViewSonic
I) USB Mouse	EMC-S3906	0000031	EW4ECM-S3906	MITSUMI ELECTRONICS CORP.
J) USB Mouse	EMC-S3906	0000036	EW4ECM-S3906	MITSUMI ELECTRONICS CORP.
K) USB Mouse	EMC-S3906	0000052	EW4ECM-S3906	MITSUMI ELECTRONICS CORP.
L) USB Mouse	EMC-S3906	0000065	EW4ECM-S3906	MITSUMI ELECTRONICS CORP.
M) AC Adapter	HOOC AA	020108	N.A.	EPSON

DoC : Device was tested and authorized under a Declaration of Conformity to the applicable FCC rules.

**SECTION 5. CABLE (S) USED**

The following cable(s) was used for the test.

Indication number in the following left side column corresponds to Section 6.

Number	Name	Length	Shield	Connector
1)	Video cable	1.50 m or 1.80 m	Yes	Metal
2)	Modem cable	2.00 m	Yes	Metal
3)	Centronics cable	2.00 m	Yes	Metal
4)	Mouse cable	1.80 m	Yes	Metal
5)	Keyboard cable	1.50 m	Yes	Metal
6)	BNC cable	1.80 m	Yes	Metal
7)	USB Data cable	1.80 m	Yes	Metal
8)	Mouse cable	1.80 m	Yes	Metal
9)	Mouse cable	1.80 m	Yes	Metal
10)	Mouse cable	1.80 m	Yes	Metal
11)	Mouse cable	1.80 m	Yes	Metal
12)	Power cord for USB	1.80 m	None	
13)	Power cord for EUT	1.80 m	None	
14)	Power cord for Computer	1.80 m	None	
15)	Power cord for Printer	1.80 m	None	
16)	Power cord for Modem	1.80 m	None	

Note :

- a. Two ferrite cores are permanently attached to Video cable.  
The applicant supplies this cable with EUT.

### SECTION 6. CONSTRUCTION OF EQUIPMENT

The construction of EUT during the test was as follows.

#### 6.1 D-Sub mode

System configuration

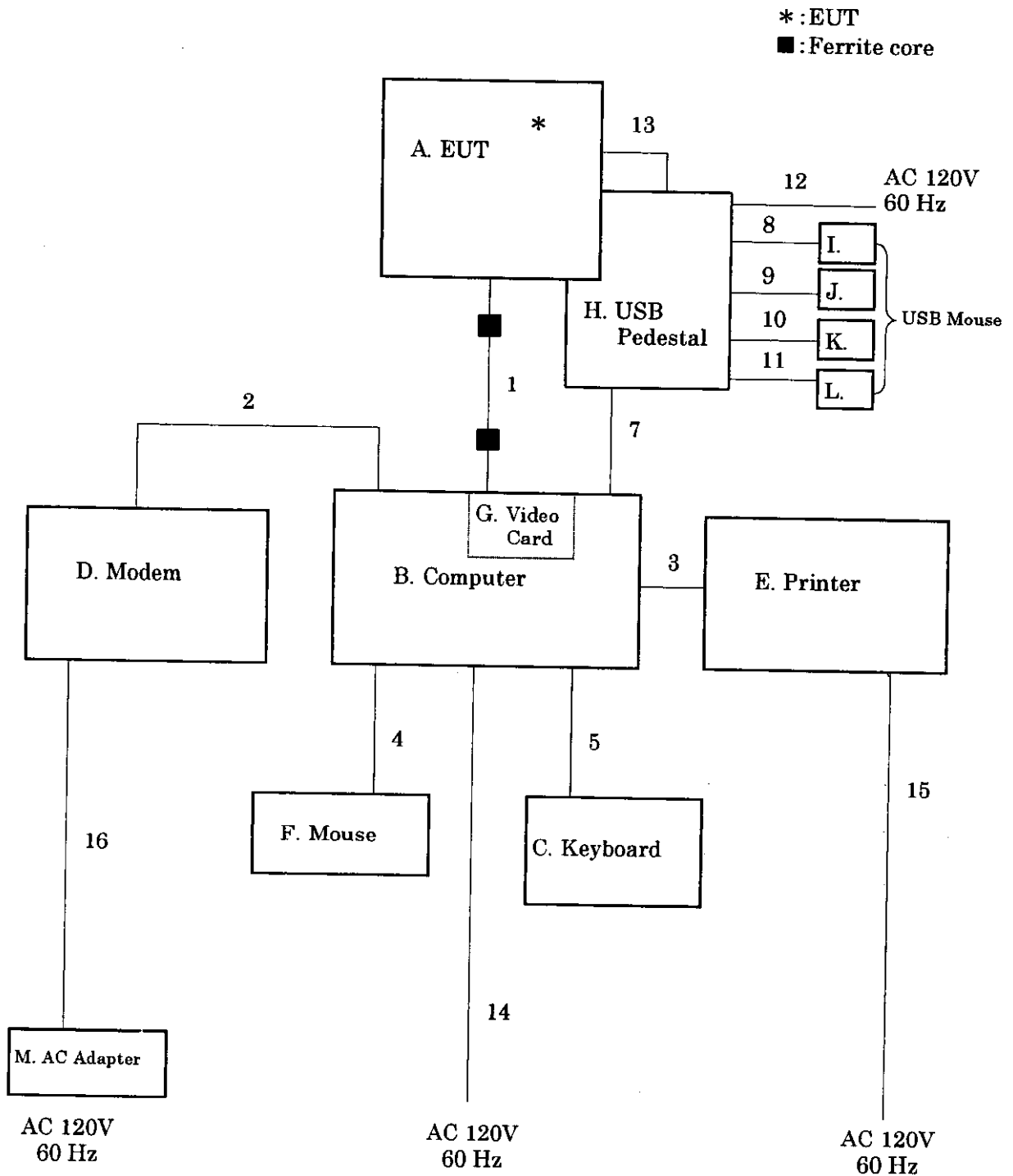

Symbols or numbers assigned to equipment or cables on this diagram are corresponded to the symbols or numbers assigned to equipment or cables on tables in Sections 3 to 5.



The construction of EUT during the test was as follows.

6.2 BNC mode

System configuration

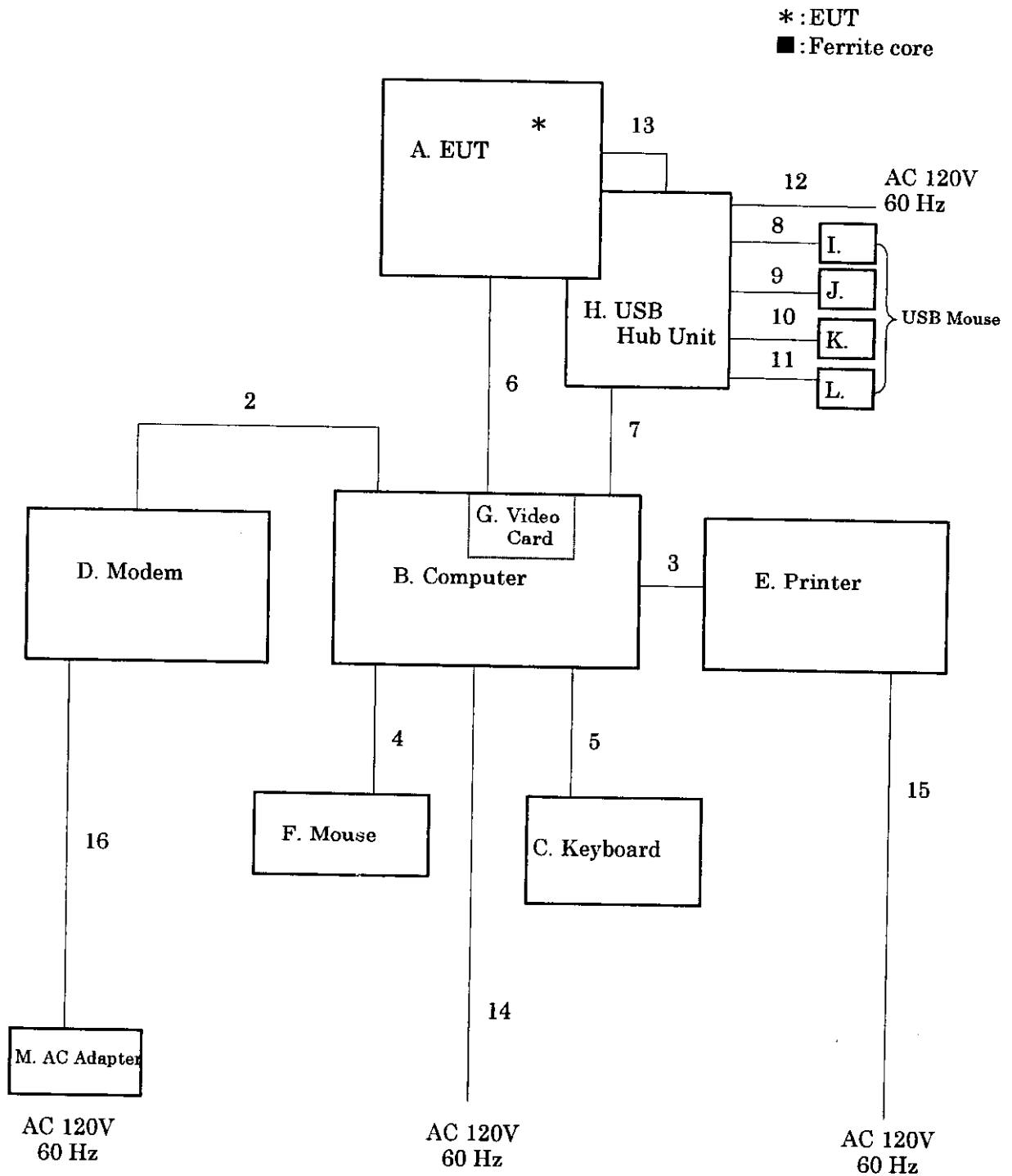

Symbols or numbers assigned to equipment or cables on this diagram are corresponded to the symbols or numbers assigned to equipment or cables on tables in Sections 3 to 5.

## SECTION 7. OPERATING CONDITIONS

The EUT was operated under the following conditions during the test.

### 7.1 Operating condition

The tests was carried out under 640×480 dots mode(BNC / D-Sub 1.5m / D-Sub 1.8m cable) and 1600×1200 dots mode(BNC / D-Sub 1.5m / D-Sub 1.8m cable). EUT was examined in the operating conditions that had maximum emissions.

### 7.2 Operating flow

Performed following operations continuously

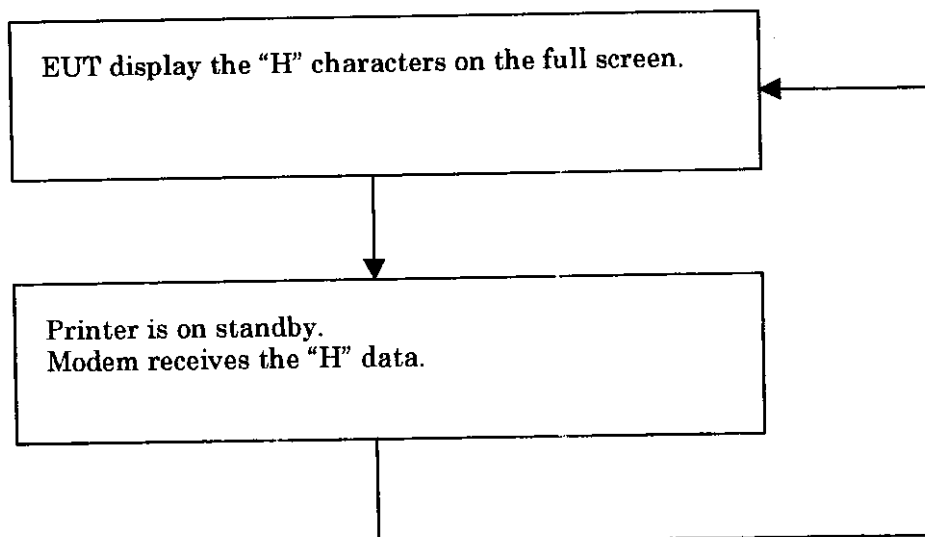

## SECTION 8. TEST PROCEDURE(S)

Tests were carried out under the following conditions.

Tests were carried out with no deviations from standards and test methods.

Subject	Test procedure	Measurement software	Scan frequency
Conducted Emission	Akzo Kashima Document number : 03-10-004	emiT Ver. 1,3,4,2	0.15 - 30 MHz
Radiated Emission	Akzo Kashima Document number : 03-10-003	emiT Ver. 1,3,4,2 emiT Ver. 1,3,4,3	30 - 1000 MHz 1000 - 2000 MHz

### Schema for the conducted measurement

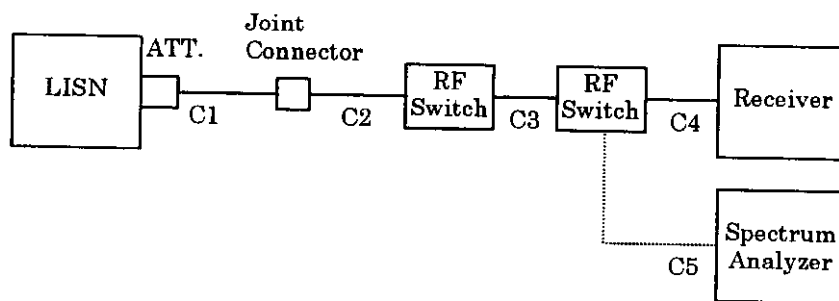

Abbreviations : LISN = Line Impedance Stabilization Network  
Line Impedance Stabilization Network(LISN) = Artificial Mains Network(A.M.N.)

Abbreviations : ATT. = Attenuator

### Schema for the radiated measurement

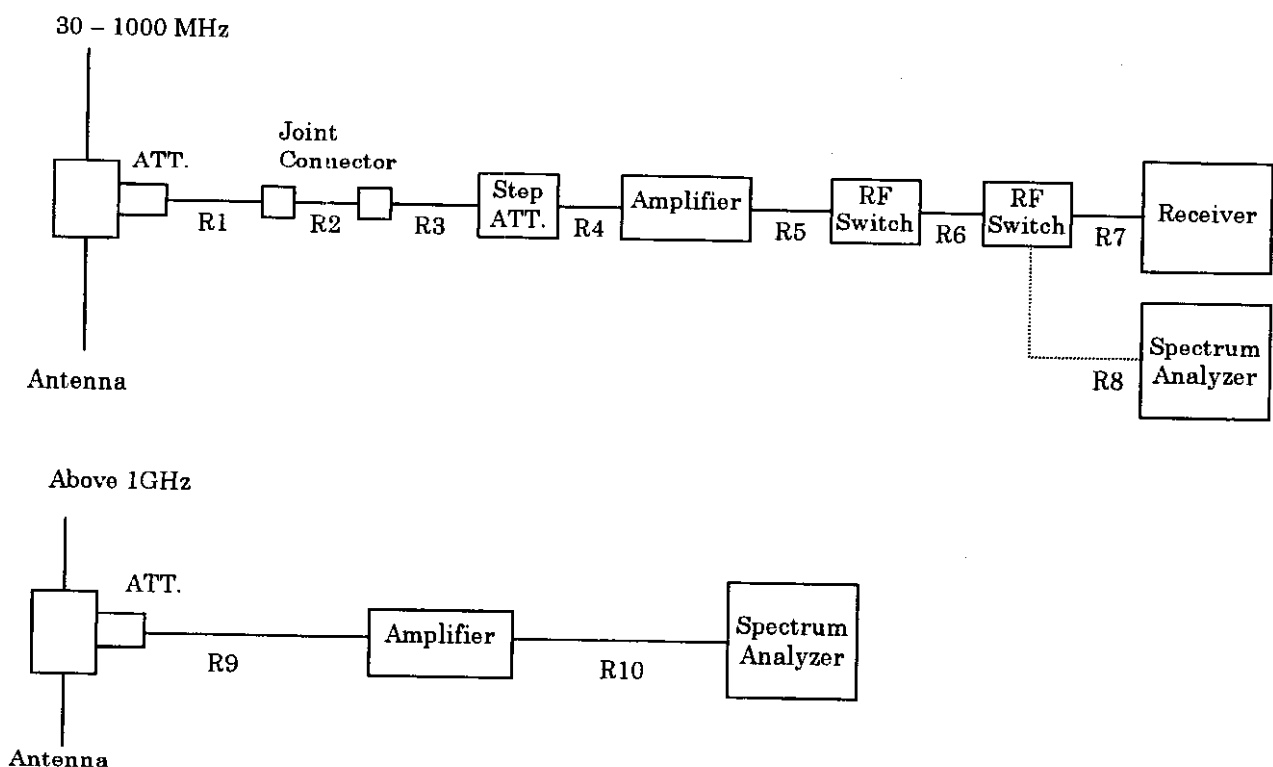

## Summary ;

### 8.1 Conducted Emission Test

#### 8.1.1 Equipment Setup

System configuration and Equipment setup are shown on Section 6 and Section 10.

##### 8.1.1.1 Table-Top Equipment

EUT is placed on the wooden table raised 0.8meter above the metal ground plane.

##### 8.1.1.2 Interconnecting Cables

Excess part of the interconnecting cables longer than 1 meter are bundled in the center. Cables that hang closer than 40 cm to the ground plane is folded back and forth forming bundle 30 to 40 cm long, hanging approx, in the middle between ground plane and table.

##### 8.1.1.3 AC Power Cord

AC power cord for EUT is connected to one LISN which is placed on top of ground plane. The LISN is placed in 80 cm from the nearest part of EUT chassis. The excess power cable is bundled in the center, or shortened to appropriate length. AC cables except from the EUT are connected second LISN.

#### 8.1.2 Measuring Instruments

Measuring instruments list and calibration schedule are shown on Section 11, and brief description are as follows;

##### 8.1.2.1 Spectrum Analyzer

The Spectrum analyzer is used for preliminary measurement.

##### 8.1.2.2 EMI Test Receiver

The Quasi-peak detector(Resolution bandwidth : 10 kHz) and average detector (Resolution bandwidth : 10 kHz) built in test receiver is used for final measurement. The test receiver is complied with the specification of the CISPR publication 16.

##### 8.1.2.3 LISN

The  $50\ \mu\text{H}/50\ \Omega$  LISN is used. The chassis of the LISN is bonded to the ground plane by the copper blade.

The lead to be tested is selectable by switch, and the terminals which are not connected to the EUT are terminated in  $50\ \Omega$  resistor termination.

#### 8.1.3 Test Procedure

##### 8.1.3.1 Preliminary Measurement

EUT is tested on all operating conditions.

The spectrum analyzer is controlled by the computer program to sweep regulation frequency, then spectrum chart are plotted out to detect the worst conditions in operating mode and/or configuration for the final test.

All leads other than safety ground are tested.

##### 8.1.3.2 Final Measurement

The EUT is operated in the worst condition where maximum emission is detected by the preliminary test. The equipment and cables are arranged or manipulated within the range of the test standard in the above condition.

The each spectrum to be tested are measured in quasi-peak and average (if necessary) using the test receiver.

## 8.2 Radiated Emission Test

### 8.2.1 Equipment Setup

System configuration and Equipment setup are shown on Section 6 and Section 10.

#### 8.2.1.1 Table-Top Equipment

EUT is placed on the wooden table raised 0.8meter above the metal ground plane(turntable).

#### 8.2.1.2 Interconnecting Cables

Excess part of the interconnecting cables longer than 1 meter are bundled in the center. Cables that hang closer than 40 cm to the ground plane is folded back and forth forming bundle 30 to 40 cm long, hanging approx, in the middle between ground plane and table.

### 8.2.2 Measuring Instruments

Measuring instruments list and calibration schedule are shown on Section 11, and brief description are as follows;

#### 8.2.2.1 Antennas

The broadband Bi-cog antenna is used for measurement on the frequency range 30 – 1000 MHz.

The Double ridged guide antenna is used for frequency higher than 1000 MHz. If uncertain result was obtained, the broadband antenna is replaced by the half wave length dipole, then measurement is carried out over again.

#### 8.2.2.2 Pre-amplifier

The broadband pre-amplifier is used for radiated emission measurement. The signal to noise ratio is improved by using pre-amplifier.

#### 8.2.2.3 Spectrum Analyzer

The spectrum analyzer is used for preliminary measurement of frequency range 30 – 1000 MHz, and also used for final measurement of higher than 1000 MHz (Resolution bandwidth : 1 MHz).

#### 8.2.2.4 EMI Test Receiver

The Quasi-peak detector(Resolution bandwidth : 120 kHz) built in test receiver is used for final measurement of the frequency 30 – 1000 MHz.

The test receiver is complied with the specification of the CISPR publication 16.

#### 8.2.2.5 Turntable

The turntable is capable for EUT weight and rotatable 0 to 360 degree horizontally by remote control in the test room.

#### 8.2.2.6 Antenna Mast

The antenna mast is attachable to all antennas described on clause 8.2.2.1 and antenna height is adjustable 1 to 4 meters continuously by remote control at the test room, and antenna polarization is also changed by the remote control.

### 8.2.3 Test Procedure

#### 8.2.3.1 Preliminary Measurement

EUT is tested on all operating conditions.

The spectrum analyzer is set max-hold mode and swept during turntable was rotated 0 to 360 degree. Then spectrum chart are plotted out to detect the worst conditions in configuration, operating mode, or ambient noise notation.

#### 8.2.3.2 Final Measurement

The EUT operated in the condition where maximum emission is detected in the preliminary test.

The turntable azimuth(EUT direction) and antenna height are adjusted the position so that maximum field strength is obtained for each frequency spectrum to be measured. The equipment and cables are arranged or manipulated within the range of the test standard in the above condition.

When the uncertain result was obtained, the measurement is retried by using the half wave dipole antenna instead of the broadband antenna.

SECTION 9. EVALUATION OF TEST RESULTS

9.1 Conducted Emission Test

9.1.1 640x480 (BNC)

**Akzo Kashima Limited**  
**Nagano No.3 Test Site**  
**INTERFERENCE CONDUCTION TEST**

APPLICANT : MATSUSHITA ELECTRIC INDUSTRIAL CO.,LTD.  
 EUT NAME : 17" Color CRT Display Monitor  
 MODEL NO. : VCDTS21419-1\*  
 SERIAL NO. : FP8420003  
 TEST MODE : 640x480 (BNC)  
 POWER SOURCE : AC120V/60Hz  
 DATE TESTED : Nov 20 1998  
 FILE NO. : AKL-398205  
 REGULATION : CISPR Pub.22:1993, A2:1996 CLASS B  
 TEST METHOD : CISPR Pub.22:1993, A2:1996

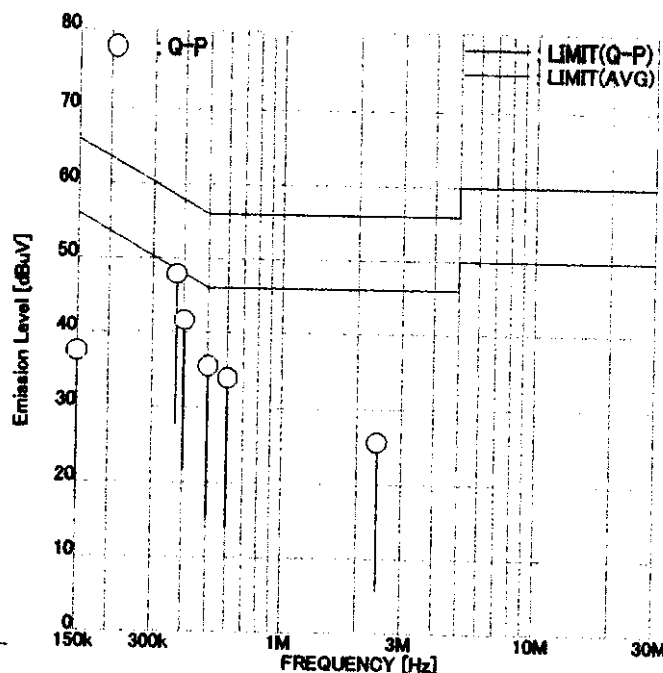

ENGINEER : Chikai Akatsu

FREQUENCY [MHz]	MODE	READING [dBuV]		FACTOR [dB]		EMISSION [dBuV]		LIMIT [dBuV]	MARGIN [dB]	
		Line1	Line2	Line1	Line2	Line1	Line2		Line1	Line2
1	0.1500 Q-P	29.0	<u>29.2</u>	8.2	8.2	37.2	<u>37.4</u>	66.0	28.8	<u>28.6</u>
2	0.3743 Q-P	<u>41.0</u>	40.9	6.8	6.8	<u>47.8</u>	47.7	58.4	<u>10.6</u>	10.7
3	0.4031 Q-P	<u>34.8</u>	32.4	6.8	6.8	<u>41.6</u>	39.2	57.8	<u>16.2</u>	18.6
4	0.5037 Q-P	<u>29.0</u>	27.7	6.5	6.5	<u>35.5</u>	34.2	56.0	<u>20.5</u>	21.8
5	0.6055 Q-P	26.6	<u>27.4</u>	6.5	6.5	33.1	<u>33.9</u>	56.0	22.9	<u>22.1</u>
6	2.4141 Q-P	18.3	<u>19.2</u>	6.5	6.5	24.8	<u>25.7</u>	56.0	31.2	<u>30.3</u>

Higher six points are underlined.

Other frequencies : Below the CISPR Pub.22:1993, A2:1996 CLASS B limit

Emission Level = Read + Factor(LISN,Pad,Cable)

9.1.2 640×480 (D-Sub 1.5m)

**Akzo Kashima Limited**  
**Nagano No.3 Test Site**  
**INTERFERENCE CONDUCTION TEST**

APPLICANT : MATSUSHITA ELECTRIC INDUSTRIAL CO.,LTD.  
 EUT NAME : 17"Color CRT Display Monitor  
 MODEL NO. : VCDTS21419-1\*  
 SERIAL NO. : FP8420003  
 TEST MODE : 640×480 (D-Sub 1.5m)  
 POWER SOURCE : AC120V/60Hz  
 DATE TESTED : Nov 20 1998  
 FILE NO. : AKL-398205  
 REGULATION : CISPR Pub.22:1993, A2:1996 CLASS B  
 TEST METHOD : CISPR Pub.22:1993, A2:1996

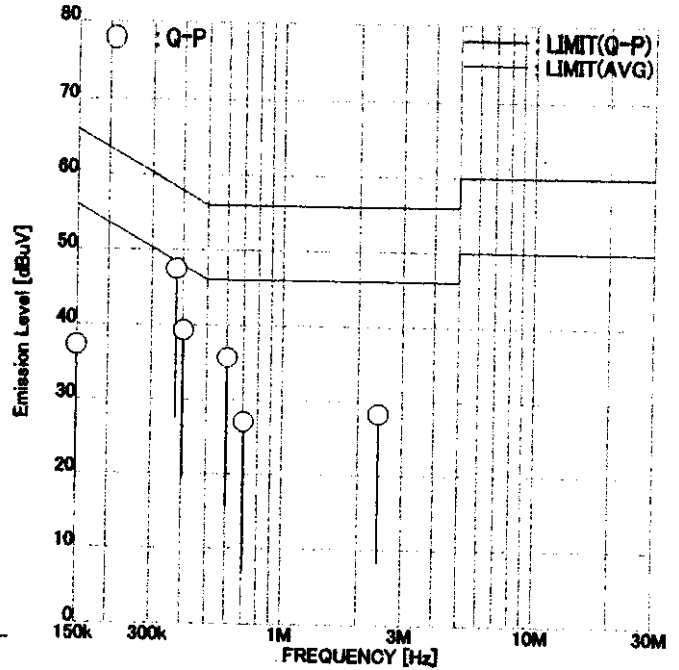

*Chikai Akatsu*

ENGINEER :

Chikai Akatsu

	FREQUENCY [MHz]	MODE	READING [dBuV]		FACTOR [dB]		EMISSION [dBuV]		LIMIT [dBuV]	MARGIN [dB]	
			Line1	Line2	Line1	Line2	Line1	Line2		Line1	Line2
1	0.1500	Q-P	28.7	<u>29.0</u>	8.2	8.2	36.9	<u>37.2</u>	66.0	29.1	<u>28.8</u>
2	0.3761	Q-P	40.5	<u>40.6</u>	6.8	6.8	47.3	<u>47.4</u>	58.4	11.1	<u>11.0</u>
3	0.4035	Q-P	32.4	<u>32.4</u>	6.8	6.8	39.2	<u>39.2</u>	57.8	18.6	<u>18.6</u>
4	0.6047	Q-P	27.3	<u>29.1</u>	6.5	6.5	33.8	<u>35.6</u>	56.0	22.2	<u>20.4</u>
5	0.7052	Q-P	<u>20.5</u>	<u>20.5</u>	6.5	6.5	<u>27.0</u>	<u>27.0</u>	56.0	29.0	<u>29.0</u>
6	2.4192	Q-P	21.5	<u>21.7</u>	6.5	6.5	28.0	<u>28.2</u>	56.0	28.0	<u>27.8</u>

Higher six points are underlined.

Other frequencies : Below the CISPR Pub.22:1993, A2:1996 CLASS B limit

Emission Level = Read + Factor(LISN,Pad,Cable)



9.1.3 640×480 (D-Sub 1.8m)

# Akzo Kashima Limited

## Nagano No.3 Test Site

### INTERFERENCE CONDUCTION TEST

APPLICANT : MATSUSHITA ELECTRIC INDUSTRIAL CO.,LTD.  
 EUT NAME : 17" Color CRT Display Monitor  
 MODEL NO. : VCDTS21419-1\*  
 SERIAL NO. : FP8420003  
 TEST MODE : 640×480 (D-Sub 1.8m)  
 POWER SOURCE : AC120V/60Hz  
 DATE TESTED : Nov 20 1998  
 FILE NO. : AKL-398205  
 REGULATION : CISPR Pub.22:1993, A2:1996 CLASS B  
 TEST METHOD : CISPR Pub.22:1993, A2:1996

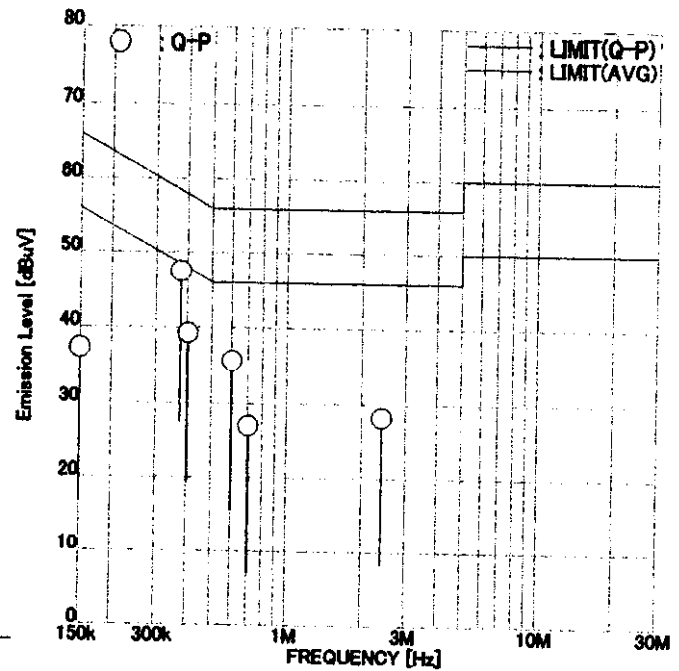

ENGINEER :

Chikai Akatsu

	FREQUENCY [MHz]	MODE	READING [dBuV]		FACTOR [dB]		EMISSION [dBuV]		LIMIT [dBuV]	MARGIN [dB]	
			Line1	Line2	Line1	Line2	Line1	Line2		Line1	Line2
1	0.1500	Q-P	28.7	<u>29.0</u>	8.2	8.2	36.9	<u>37.2</u>	66.0	29.1	<u>28.8</u>
2	0.3761	Q-P	40.5	<u>40.6</u>	6.8	6.8	47.3	<u>47.4</u>	58.4	11.1	<u>11.0</u>
3	0.4035	Q-P	<u>32.4</u>	<u>32.4</u>	6.8	6.8	<u>39.2</u>	<u>39.2</u>	57.8	18.6	<u>18.6</u>
4	0.6047	Q-P	27.3	<u>29.1</u>	6.5	6.5	33.8	<u>35.6</u>	56.0	22.2	<u>20.4</u>
5	0.7052	Q-P	<u>20.5</u>	<u>20.5</u>	6.5	6.5	<u>27.0</u>	<u>27.0</u>	56.0	<u>29.0</u>	<u>29.0</u>
6	2.4192	Q-P	21.5	<u>21.7</u>	6.5	6.5	28.0	<u>28.2</u>	56.0	28.0	<u>27.8</u>

Higher six points are underlined.

Other frequencies : Below the CISPR Pub.22:1993, A2:1996 CLASS B limit

Emission Level = Read + Factor(LISN,Pad,Cable)

9.1.4 1600×1200 (BNC)

**Akzo Kashima Limited**  
**Nagano No.3 Test Site**  
**INTERFERENCE CONDUCTION TEST**

APPLICANT : MATSUSHITA ELECTRIC INDUSTRIAL CO.,LTD.  
 EUT NAME : 17" Color CRT Display Monitor  
 MODEL NO. : VCDTS21419-1\*  
 SERIAL NO. : FP842003  
 TEST MODE : 1600×1200 (BNC)  
 POWER SOURCE : AC120V/60Hz  
 DATE TESTED : Nov 19 1998  
 FILE NO. : AKL-398205  
 REGULATION : CISPR Pub.22:1993, A2:1996 CLASS B  
 TEST METHOD : CISPR Pub.22:1993, A2:1996

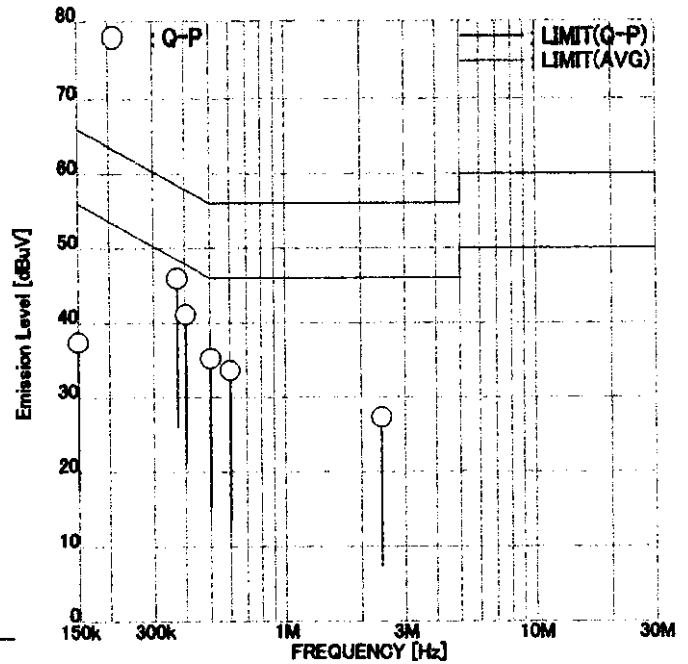

ENGINEER :   
 Chikai Akatsu

FREQUENCY [MHz]	MODE	READING [dBuV]		FACTOR [dB]		EMISSION [dBuV]		LIMIT [dBuV]	MARGIN [dB]		
		Line1	Line2	Line1	Line2	Line1	Line2		Line1	Line2	
1	0.1500	Q-P	<u>29.2</u>	28.7	8.2	8.2	<u>37.4</u>	36.9	66.0	<u>28.6</u>	29.1
2	0.3726	Q-P	<u>39.1</u>	<u>39.1</u>	6.8	6.8	<u>45.9</u>	<u>45.9</u>	58.4	<u>12.5</u>	<u>12.5</u>
3	0.4018	Q-P	<u>34.3</u>	31.9	6.8	6.8	<u>41.1</u>	38.7	57.8	<u>16.7</u>	19.1
4	0.5043	Q-P	<u>28.7</u>	27.4	6.5	6.5	<u>35.2</u>	33.9	56.0	<u>20.8</u>	22.1
5	0.6032	Q-P	26.3	<u>27.1</u>	6.5	6.5	32.8	<u>33.6</u>	56.0	23.2	<u>22.4</u>
6	2.4198	Q-P	<u>20.8</u>	20.6	6.5	6.5	<u>27.3</u>	27.1	56.0	<u>28.7</u>	28.9

Higher six points are underlined.  
 Other frequencies : Below the CISPR Pub.22:1993, A2:1996 CLASS B limit  
 Emission Level = Read + Factor(LISN,Pad,Cable)

9.1.5 1600×1200 (D-Sub 1.5m)

**Akzo Kashima Limited**  
**Nagano No.3 Test Site**  
**INTERFERENCE CONDUCTION TEST**

APPLICANT : MATSUSHITA ELECTRIC INDUSTRIAL CO.,LTD.  
 EUT NAME : 17" Color CRT Display Monitor  
 MODEL NO. : VCDTS21419-1\*  
 SERIAL NO. : FP8420003  
 TEST MODE : 1600×1200 (D-Sub 1.5m)  
 POWER SOURCE : AC120V/60Hz  
 DATE TESTED : Nov 19 1998  
 FILE NO. : AKL-398205  
 REGULATION : CISPR Pub.22:1993, A2:1996 CLASS B  
 TEST METHOD : CISPR Pub.22:1993, A2:1996

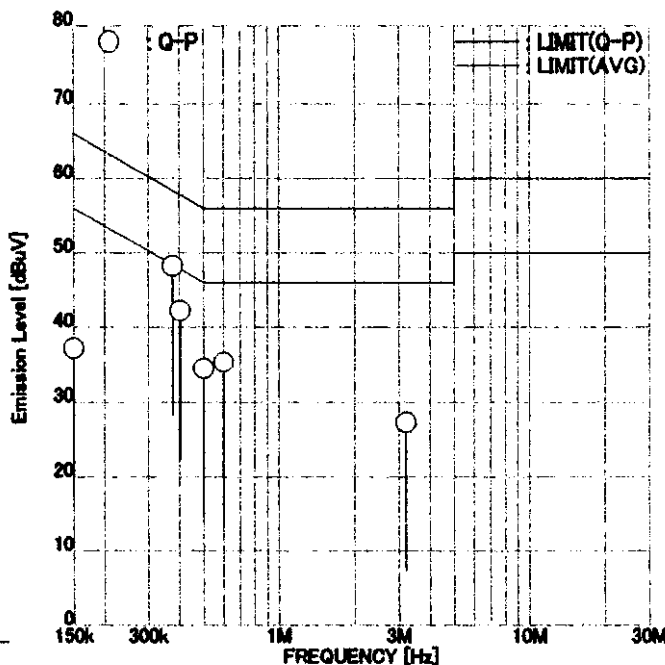

ENGINEER : Chikai Akatsu

	FREQUENCY [MHz]	MODE	READING [dBuV]		FACTOR [dB]		EMISSION [dBuV]		LIMIT [dBuV]	MARGIN [dB]	
			Line1	Line2	Line1	Line2	Line1	Line2		Line1	Line2
1	0.1500	Q-P	<u>29.0</u>	<u>29.0</u>	8.2	8.2	<u>37.2</u>	<u>37.2</u>	66.0	<u>28.8</u>	<u>28.8</u>
2	0.3761	Q-P	<u>41.4</u>	<u>41.4</u>	6.8	6.8	<u>48.2</u>	<u>48.2</u>	58.4	<u>10.2</u>	<u>10.2</u>
3	0.4026	Q-P	<u>35.4</u>	<u>32.9</u>	6.8	6.8	<u>42.2</u>	<u>39.7</u>	57.8	<u>15.6</u>	<u>18.1</u>
4	0.5011	Q-P	<u>28.0</u>	<u>26.6</u>	6.5	6.5	<u>34.5</u>	<u>33.1</u>	56.0	<u>21.5</u>	<u>22.9</u>
5	0.6015	Q-P	<u>27.8</u>	<u>28.8</u>	6.5	6.5	<u>34.3</u>	<u>35.3</u>	56.0	<u>21.7</u>	<u>20.7</u>
6	3.2105	Q-P	<u>20.2</u>	<u>20.8</u>	6.5	6.5	<u>26.7</u>	<u>27.3</u>	56.0	<u>29.3</u>	<u>28.7</u>

Higher six points are underlined.  
 Other frequencies : Below the CISPR Pub.22:1993, A2:1996 CLASS B limit  
 Emission Level = Read + Factor(LISN,Pad,Cable)

9.1.6 1600×1200 (D-Sub 1.8m)

**Akzo Kashima Limited**  
**Nagano No.3 Test Site**  
**INTERFERENCE CONDUCTION TEST**

APPLICANT : MATSUSHITA ELECTRIC INDUSTRIAL CO.,LTD.  
 EUT NAME : 17" Color CRT Display Monitor  
 MODEL NO. : VCDTS21419-1\*  
 SERIAL NO. : FP8420003  
 TEST MODE : 1600×1200 (D-Sub 1.8m)  
 POWER SOURCE : AC120V/60Hz  
 DATE TESTED : Nov 20 1998  
 FILE NO. : AKL-398205  
 REGULATION : CISPR Pub.22:1993, A2:1996 CLASS B  
 TEST METHOD : CISPR Pub.22:1993, A2:1996

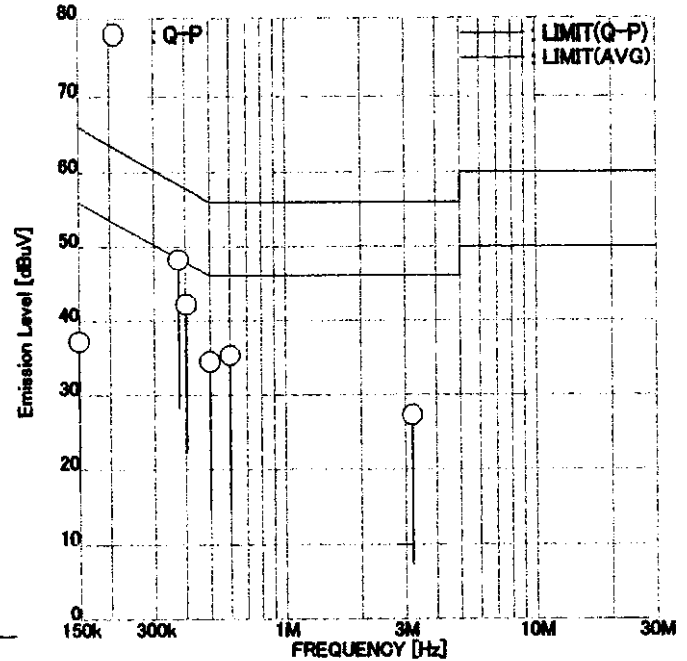

ENGINEER : Chikai Akatsu

FREQUENCY [MHz]	MODE	READING [dBuV]		FACTOR [dB]		EMISSION [dBuV]		LIMIT [dBuV]	MARGIN [dB]		
		Line1	Line2	Line1	Line2	Line1	Line2		Line1	Line2	
1	0.1500	Q-P	<u>29.0</u>	<u>29.0</u>	8.2	8.2	<u>37.2</u>	<u>37.2</u>	66.0	<u>28.8</u>	<u>28.8</u>
2	0.3761	Q-P	<u>41.4</u>	<u>41.4</u>	6.8	6.8	<u>48.2</u>	<u>48.2</u>	58.4	<u>10.2</u>	<u>10.2</u>
3	0.4026	Q-P	<u>35.4</u>	<u>32.9</u>	6.8	6.8	<u>42.2</u>	<u>39.7</u>	57.8	<u>15.6</u>	<u>18.1</u>
4	0.5011	Q-P	<u>28.0</u>	<u>26.6</u>	6.5	6.5	<u>34.5</u>	<u>33.1</u>	56.0	<u>21.5</u>	<u>22.9</u>
5	0.6015	Q-P	<u>27.8</u>	<u>28.8</u>	6.5	6.5	<u>34.3</u>	<u>35.3</u>	56.0	<u>21.7</u>	<u>20.7</u>
6	3.2105	Q-P	<u>20.2</u>	<u>20.8</u>	6.5	6.5	<u>26.7</u>	<u>27.3</u>	56.0	<u>29.3</u>	<u>28.7</u>

Higher six points are underlined.  
 Other frequencies : Below the CISPR Pub.22:1993, A2:1996 CLASS B limit  
 Emission Level = Read + Factor(LISN,Pad,Cable)

## 9.2 Radiated Emission Test

## 9.2.1 640×480 (BNC)

## Akzo Kashima Limited

### Nagano No.3 Test Site

#### INTERFERENCE RADIATION TEST

APPLICANT : MATSUSHITA ELECTRIC INDUSTRIAL CO.,LTD.  
 EUT NAME : 17" Color CRT Display Monitor  
 MODEL NO. : VCDTS21419-1\*  
 SERIAL NO. : FP8420003  
 TEST MODE : 640×480 (BNC)  
 POWER SOURCE : AC120V/60Hz  
 DATE TESTED : Nov 19 1998  
 FILE NO. : AKL-398205  
 REGULATION : CISPR Pub.22:1993, A2:1996 CLASS B  
 TEST METHOD : CISPR Pub.22:1993, A2:1996  
 DISTANCE : 10.0 [m]  
 TEMPERATURE : 16.0 [°C]  
 HUMIDITY : 61.0 [%]

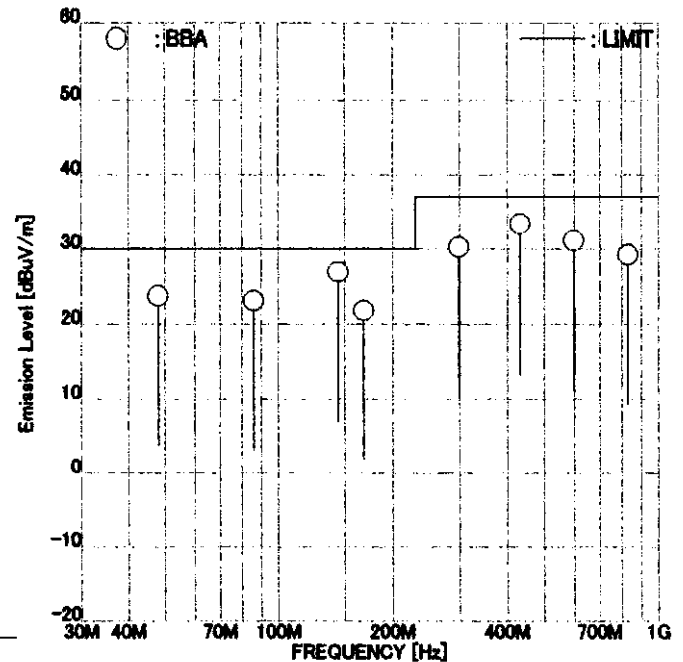

ENGINEER :  Chikai Akatsu

FREQUENCY [MHz]	ANT.	READING [dBuV]		FACTOR [dB]		EMISSION [dBuV/m]		LIMIT [dBuV/m]	MARGIN [dB]		
		Hori	Vert	Hori	Vert	Hori	Vert		Hori	Vert	
1	48.00	BBA	-	<u>35.6</u>	-11.9	-11.9	-	<u>23.7</u>	30.0	-	<u>6.3</u>
2	85.90	BBA	-	<u>41.0</u>	-17.9	-17.9	-	<u>23.1</u>	30.0	-	<u>6.9</u>
3	144.02	BBA	-	<u>43.1</u>	-16.2	-16.2	-	<u>26.9</u>	30.0	-	<u>3.1</u>
4	168.00	BBA	-	<u>36.7</u>	-14.9	-14.9	-	<u>21.8</u>	30.0	-	<u>8.2</u>
5	299.14	BBA	<u>39.3</u>	-	-9.1	-9.1	<u>30.2</u>	-	37.0	<u>6.8</u>	-
6	432.06	BBA	<u>40.1</u>	-	-6.8	-6.8	<u>33.3</u>	-	37.0	<u>3.7</u>	-
7	598.29	BBA	-	<u>35.2</u>	-4.1	-4.1	-	<u>31.1</u>	37.0	-	<u>5.9</u>
8	830.95	BBA	28.6	-	0.6	0.6	29.2	-	37.0	7.8	-

Higher six points are underlined.

Other frequencies : Below the CISPR Pub.22:1993, A2:1996 CLASS B limit

Emission Level = Read + Factor(Antenna, Antenna Pad, Cable, Preamp)

ANT. : Used antenna(BBA = Broadband antenna, DIP = Dipole antenna)

9.2.2 640×480 (D-Sub 1.5m)

**Akzo Kashima Limited**  
**Nagano No.3 Test Site**  
**INTERFERENCE RADIATION TEST**

APPLICANT : MATSUSHITA ELECTRIC INDUSTRIAL CO.,LTD.  
 EUT NAME : 17"Color CRT Display Monitor  
 MODEL NO. : VCDTS21419-1\*  
 SERIAL NO. : FP8420003  
 TEST MODE : 640×480 (D-Sub 1.5m)  
 POWER SOURCE : AC120V/60Hz  
 DATE TESTED : Nov 19 1998  
 FILE NO. : AKL-398205  
 REGULATION : CISPR Pub.22:1993, A2:1996 CLASS B  
 TEST METHOD : CISPR Pub.22:1993, A2:1996  
 DISTANCE : 10.0 [m]  
 TEMPERATURE : 16.0 [°C]  
 HUMIDITY : 61.0 [%]

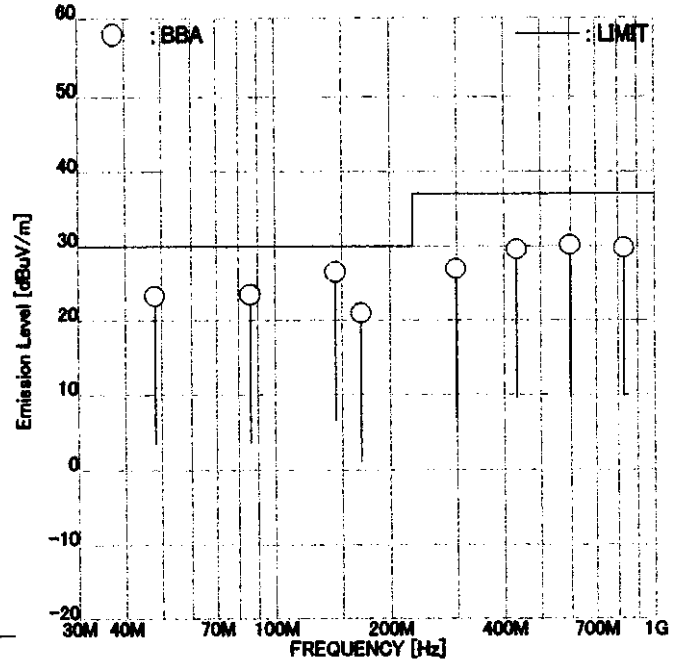

ENGINEER :   
 Chikai Akatsu

FREQUENCY [MHz]	ANT.	READING [dBuV]		FACTOR [dB]		EMISSION [dBuV/m]		LIMIT [dBuV/m]		MARGIN [dB]	
		Hori	Vert	Hori	Vert	Hori	Vert	Hori	Vert	Hori	Vert
1	48.00	BBA	-	<u>35.2</u>	-11.9	-11.9	-	<u>23.3</u>	30.0	-	<u>6.7</u>
2	85.90	BBA	-	<u>41.4</u>	-17.9	-17.9	-	<u>23.5</u>	30.0	-	<u>6.5</u>
3	144.02	BBA	-	<u>42.7</u>	-16.2	-16.2	-	<u>26.5</u>	30.0	-	<u>3.5</u>
4	168.00	BBA	-	<u>35.9</u>	-14.9	-14.9	-	<u>21.0</u>	30.0	-	<u>9.0</u>
5	299.14	BBA	36.0	-	-9.1	-9.1	26.9	-	37.0	10.1	-
6	432.06	BBA	<u>36.3</u>	-	-6.8	-6.8	<u>29.5</u>	-	37.0	<u>7.5</u>	-
7	598.29	BBA	-	<u>34.2</u>	-4.1	-4.1	-	<u>30.1</u>	37.0	-	<u>6.9</u>
8	830.95	BBA	<u>29.1</u>	-	0.6	0.6	<u>29.7</u>	-	37.0	<u>7.3</u>	-

Higher six points are underlined.

Other frequencies : Below the CISPR Pub.22:1993, A2:1996 CLASS B limit

Emission Level = Read + Factor(Antenna, Antenna Pad, Cable, Preamp)

ANT. : Used antenna(BBA = Broadband antenna, DIP = Dipole antenna)

9.2.3 640×480 (D-Sub 1.8m)

**Akzo Kashima Limited**  
**Nagano No.3 Test Site**  
**INTERFERENCE RADIATION TEST**

APPLICANT : MATSUSHITA ELECTRIC INDUSTRIAL CO.,LTD.  
 EUT NAME : 17" Color CRT Display Monitor  
 MODEL NO. : VCDTS21419-1\*  
 SERIAL NO. : FP8420003  
 TEST MODE : 640×480 (D-Sub 1.8m)  
 POWER SOURCE : AC120V/60Hz  
 DATE TESTED : Nov 19 1998  
 FILE NO. : AKL-398207  
 REGULATION : CISPR Pub.22:1993, A2:1996 CLASS B  
 TEST METHOD : CISPR Pub.22:1993, A2:1996  
 DISTANCE : 10.0 [m]  
 TEMPERATURE : 16.0 [°C]  
 HUMIDITY : 61.0 [%]

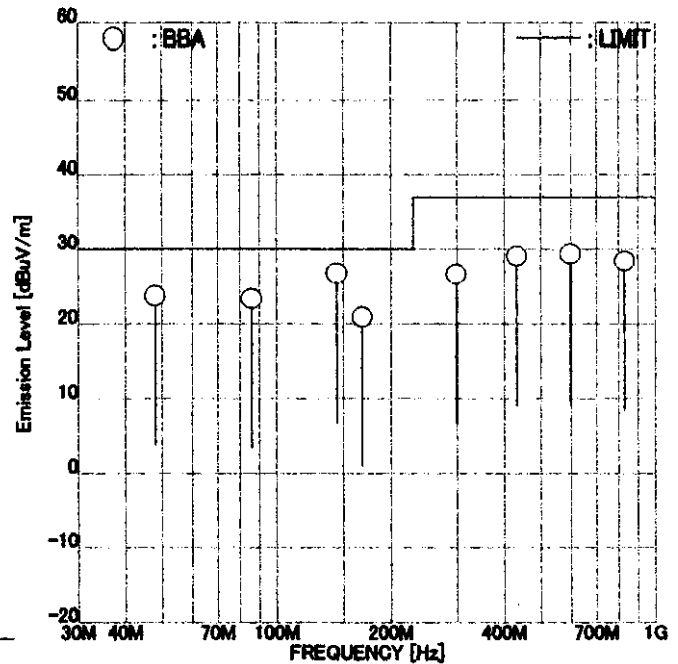

ENGINEER :   
 Chikai Akatsu

FREQUENCY [MHz]	ANT.	READING [dBuV]		FACTOR [dB]		EMISSION [dBuV/m]		LIMIT [dBuV/m]	MARGIN [dB]	
		Hori	Vert	Hori	Vert	Hori	Vert		Hori	Vert
1	48.00 BBA	-	<u>35.6</u>	-11.9	-11.9	-	<u>23.7</u>	30.0	-	<u>6.3</u>
2	85.90 BBA	-	<u>41.2</u>	-17.9	-17.9	-	<u>23.3</u>	30.0	-	<u>6.7</u>
3	144.02 BBA	-	<u>42.9</u>	-16.2	-16.2	-	<u>26.7</u>	30.0	-	<u>3.3</u>
4	168.00 BBA	-	<u>35.8</u>	-14.9	-14.9	-	<u>20.9</u>	30.0	-	<u>9.1</u>
5	299.14 BBA	35.7	-	-9.1	-9.1	26.6	-	37.0	10.4	-
6	432.06 BBA	<u>35.8</u>	-	-6.8	-6.8	<u>29.0</u>	-	37.0	<u>8.0</u>	-
7	598.29 BBA	-	<u>33.4</u>	-4.1	-4.1	-	<u>29.3</u>	37.0	-	<u>7.7</u>
8	830.95 BBA	<u>27.8</u>	-	0.6	0.6	<u>28.4</u>	-	37.0	<u>8.6</u>	-

Higher six points are underlined.  
 Other frequencies : Below the CISPR Pub.22:1993, A2:1996 CLASS B limit  
 Emission Level = Read + Factor(Antenna, Antenna Pad, Cable, Preamp)  
 ANT. : Used antenna(BBA = Broadband antenna, DIP = Dipole antenna)

9.2.4 30 - 1000 MHz 1600×1200 (BNC)

# Akzo Kashima Limited

## Nagano No.3 Test Site

### INTERFERENCE RADIATION TEST

APPLICANT : MATSUSHITA ELECTRIC INDUSTRIAL CO.,LTD.  
 EUT NAME : 17" Color CRT Display Monitor  
 MODEL NO. : VCDTS21419-1\*  
 SERIAL NO. : FP8420003  
 TEST MODE : 1600×1200 (BNC)  
 POWER SOURCE : AC120V/60Hz  
 DATE TESTED : Nov 19 1998  
 FILE NO. : AKL-398205  
 REGULATION : CISPR Pub.22:1993, A2:1996 CLASS B  
 TEST METHOD : CISPR Pub.22:1993, A2:1996  
 DISTANCE : 10.0 [m]  
 TEMPERATURE : 16.0 [°C]  
 HUMIDITY : 61.0 [%]

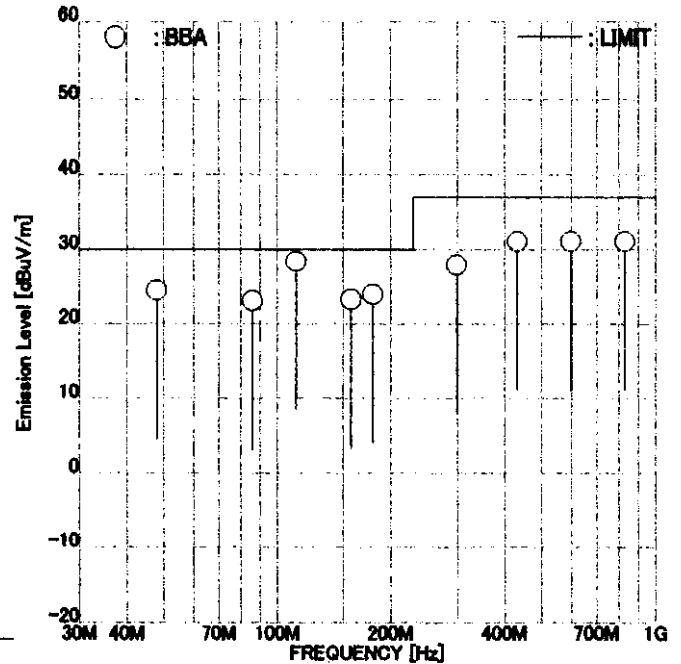

ENGINEER :

Chikai Akatsu

FREQUENCY [MHz]	ANT.	READING [dBuV]		FACTOR [dB]		EMISSION [dBuV/m]		LIMIT [dBuV/m]	MARGIN [dB]	
		Hori	Vert	Hori	Vert	Hori	Vert		Hori	Vert
1	48.00 BBA	-	<u>36.3</u>	-11.9	-11.9	-	<u>24.4</u>	30.0	-	<u>5.6</u>
2	85.90 BBA	-	<u>40.9</u>	-17.9	-17.9	-	<u>23.0</u>	30.0	-	<u>7.0</u>
3	112.37 BBA	-	<u>42.4</u>	-14.0	-14.0	-	<u>28.4</u>	30.0	-	<u>1.6</u>
4	157.32 BBA	-	<u>39.8</u>	-16.6	-16.6	-	<u>23.2</u>	30.0	-	<u>6.8</u>
5	179.79 BBA	<u>38.7</u>	-	-14.8	-14.8	<u>23.9</u>	-	30.0	<u>6.1</u>	-
6	299.14 BBA	37.0	-	-9.1	-9.1	27.9	-	37.0	9.1	-
7	432.06 BBA	<u>37.9</u>	-	-6.8	-6.8	<u>31.1</u>	-	37.0	<u>5.9</u>	-
8	598.29 BBA	-	<u>35.2</u>	-4.1	-4.1	-	<u>31.1</u>	37.0	-	<u>5.9</u>
9	830.95 BBA	<u>30.5</u>	-	0.6	0.6	<u>31.1</u>	-	37.0	<u>5.9</u>	-

Higher six points are underlined.

Other frequencies : Below the CISPR Pub.22:1993, A2:1996 CLASS B limit

Emission Level = Read + Factor(Antenna, Antenna Pad, Cable, Preamp)

ANT. : Used antenna(BBA = Broadband antenna, DIP = Dipole antenna)



9.2.5 Above 1 GHz 1600×1200 (BNC)

**Akzo Kashima Limited**  
**Nagano No.3 Test Site**  
**INTERFERENCE RADIATION TEST**

APPLICANT : MATSUSHITA ELECTRIC INDUSTRIAL CO.,LTD.  
 EUT NAME : 17"Color CRT Display Monitor  
 MODEL NO. : VCDTS21419-1\*  
 SERIAL NO. : FP8420003  
 TEST MODE : 1600×1200 (BNC)  
 POWER SOURCE : AC120V/60Hz  
 DATE TESTED : Nov 19 1998  
 FILE NO. : AKL-398205  
 REGULATION : FCC Part15B CLASS B  
 TEST METHOD : ANSI C63.4-1992  
 DISTANCE : 3.0 [m]  
 TEMPERATURE : 16.0 [°C]  
 HUMIDITY : 61.0 [%]

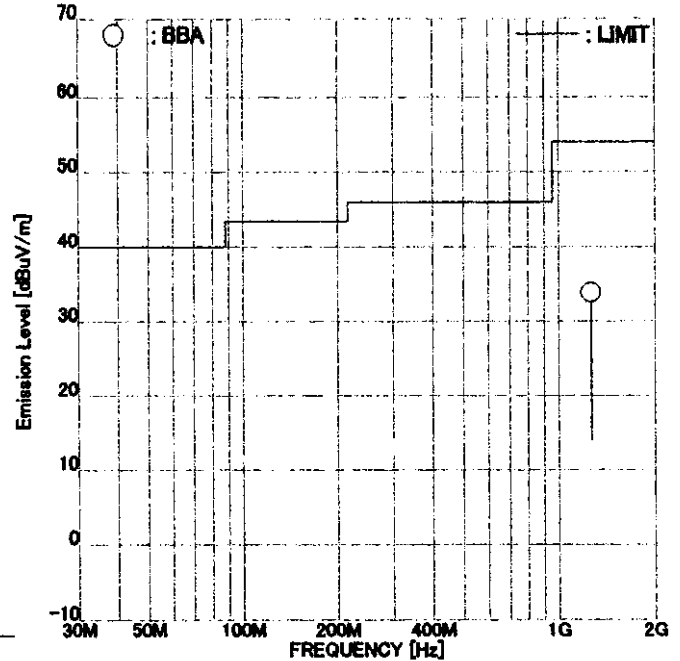

ENGINEER :   
 Chikai Akatsu

FREQ	ANT.	READING [dBuV]		FACTOR [dB]		EMISSION [dBuV/m]		LIMIT [dBuV/m]	MARGIN [dB]	
		Hori	Vert	Hori	Vert	Hori	Vert		Hori	Vert
1	1263.00 BBA	30.4	<u>30.7</u>	3.2	3.2	33.6	<u>33.9</u>	54.0	20.4	<u>20.1</u>

Higher six points are underlined.  
 Other frequencies : Below the FCC Part15B CLASS B limit  
 Emission Level = Read + Factor(Antenna, Antenna Pad, Cable, Preamp)  
 ANT. : Used antenna(BBA = Broadband antenna, DIP = Dipole antenna)

9.2.6 30 - 1000 MHz 1600x1200 (D-Sub 1.5m)

**Akzo Kashima Limited**  
**Nagano No.3 Test Site**  
**INTERFERENCE RADIATION TEST**

APPLICANT : MATSUSHITA ELECTRIC INDUSTRIAL CO.,LTD.  
 EUT NAME : 17" Color CRT Display Monitor  
 MODEL NO. : VCDTS21419-1\*  
 SERIAL NO. : FP8420003  
 TEST MODE : 1600x1200 (D-Sub 1.5m)  
 POWER SOURCE : AC120V/60Hz  
 DATE TESTED : Nov 19 1998  
 FILE NO. : AKL-398205  
 REGULATION : CISPR Pub.22:1993, A2:1996 CLASS B  
 TEST METHOD : CISPR Pub.22:1993, A2:1996  
 DISTANCE : 10.0 [m]  
 TEMPERATURE : 16.0 [°C]  
 HUMIDITY : 61.0 [%]

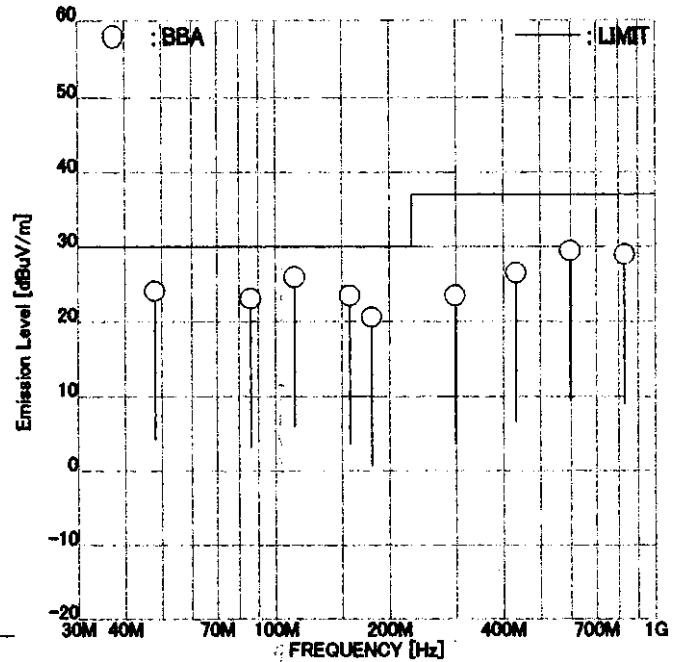

ENGINEER : Chikai Akatsu

FREQUENCY [MHz]	ANT.	READING [dBuV]		FACTOR [dB]		EMISSION [dBuV/m]		LIMIT [dBuV/m]	MARGIN [dB]	
		Hori	Vert	Hori	Vert	Hori	Vert		Hori	Vert
1	48.00 BBA	-	<u>36.0</u>	-11.9	-11.9	-	<u>24.1</u>	30.0	-	<u>5.9</u>
2	85.90 BBA	-	<u>41.0</u>	-17.9	-17.9	-	<u>23.1</u>	30.0	-	<u>6.9</u>
3	112.37 BBA	-	<u>39.9</u>	-14.0	-14.0	-	<u>25.9</u>	30.0	-	<u>4.1</u>
4	157.32 BBA	-	<u>40.1</u>	-16.6	-16.6	-	<u>23.5</u>	30.0	-	<u>6.5</u>
5	179.79 BBA	35.4	-	-14.8	-14.8	20.6	-	30.0	9.4	-
6	299.14 BBA	32.6	-	-9.1	-9.1	23.5	-	37.0	13.5	-
7	432.06 BBA	33.3	-	-6.8	-6.8	26.5	-	37.0	10.5	-
8	598.29 BBA	-	<u>33.5</u>	-4.1	-4.1	-	<u>29.4</u>	37.0	-	<u>7.6</u>
9	830.95 BBA	<u>28.3</u>	-	0.6	0.6	<u>28.9</u>	-	37.0	<u>8.1</u>	-

Higher six points are underlined.  
 Other frequencies : Below the CISPR Pub.22:1993, A2:1996 CLASS B limit  
 Emission Level = Read + Factor(Antenna, Antenna Pad, Cable, Preamp)  
 ANT. : Used antenna(BBA = Broadband antenna, DIP = Dipole antenna)

9.2.7 Above 1 GHz 1600×1200 (D-Sub 1.5m)

**Akzo Kashima Limited**  
**Nagano No.3 Test Site**  
**INTERFERENCE RADIATION TEST**

APPLICANT : MATSUSHITA ELECTRIC INDUSTRIAL CO.,LTD.  
 EUT NAME : 17" Color CRT Display Monitor  
 MODEL NO. : VCDTS21419-1\*  
 SERIAL NO. : FP8420003  
 TEST MODE : 1600×1200 (D-Sub 1.5m)  
 POWER SOURCE : AC120V/60Hz  
 DATE TESTED : Nov 19 1998  
 FILE NO. : AKL-398205  
 REGULATION : FCC Part15B CLASS B  
 TEST METHOD : ANSI C63.4-1992  
 DISTANCE : 3.0 [m]  
 TEMPERATURE : 16.0 [°C]  
 HUMIDITY : 61.0 [%]

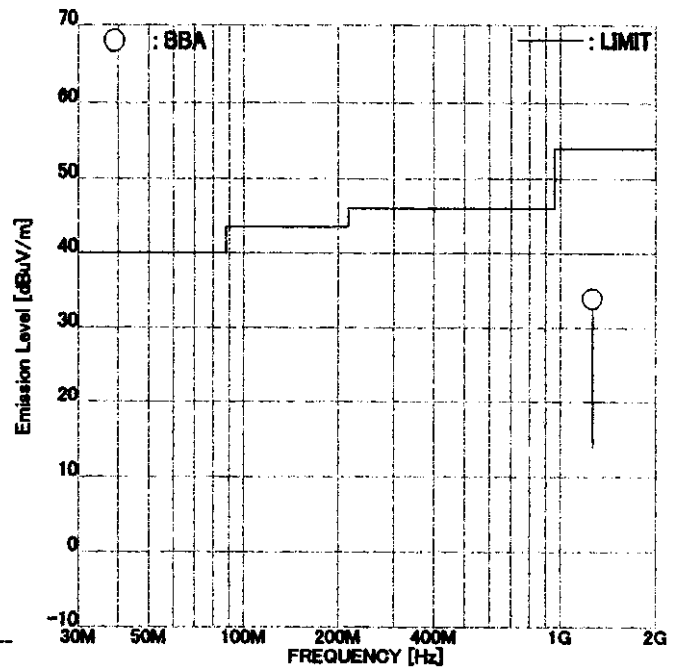

ENGINEER : Chikai Akatsu

FREQUENCY [MHz]	ANT.	READING [dBuV]		FACTOR [dB]		EMISSION [dBuV/m]		LIMIT [dBuV/m]	MARGIN [dB]		
		Hori	Vert	Hori	Vert	Hori	Vert		Hori	Vert	
1	1263.00	BBA	30.1	<u>30.7</u>	3.2	3.2	33.3	<u>33.9</u>	54.0	20.7	<u>20.1</u>

Higher six points are underlined.  
 Other frequencies : Below the FCC Part15B CLASS B limit  
 Emission Level = Read + Factor(Antenna, Antenna Pad, Cable, Preamp)  
 ANT. : Used antenna(BBA = Broadband antenna, DIP = Dipole antenna)

9.2.8 30 - 1000 MHz 1600×1200 (D-Sub 1.8m)

**Akzo Kashima Limited**  
**Nagano No.3 Test Site**  
**INTERFERENCE RADIATION TEST**

APPLICANT : MATSUSHITA ELECTRIC INDUSTRIAL CO.,LTD.  
 EUT NAME : 17"Color CRT Display Monitor  
 MODEL NO. : VCDTS21419-1\*  
 SERIAL NO. : FP8420003  
 TEST MODE : 1600×1200 (D-Sub 1.8m)  
 POWER SOURCE : AC120V/60Hz  
 DATE TESTED : Nov 19 1998  
 FILE NO. : AKL-398205  
 REGULATION : CISPR Pub.22:1993, A2:1996 CLASS B  
 TEST METHOD : CISPR Pub.22:1993, A2:1996  
 DISTANCE : 10.0 [m]  
 TEMPERATURE : 16.0 [°C]  
 HUMIDITY : 61.0 [%]

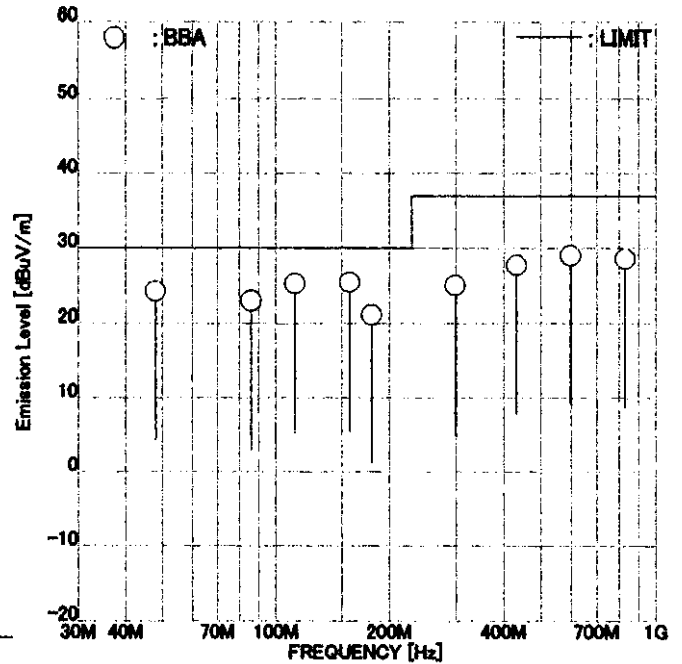

ENGINEER : Chikai Akatsu

FREQUENCY [MHz]	ANT.	READING [dBuV]		FACTOR [dB]		EMISSION [dBuV/m]		LIMIT [dBuV/m]	MARGIN [dB]	
		Hori	Vert	Hori	Vert	Hori	Vert		Hori	Vert
1	48.00 BBA	-	<u>36.1</u>	-11.9	-11.9	-	<u>24.2</u>	30.0	-	<u>5.8</u>
2	85.90 BBA	-	<u>40.8</u>	-17.9	-17.9	-	<u>22.9</u>	30.0	-	<u>7.1</u>
3	112.37 BBA	-	<u>39.2</u>	-14.0	-14.0	-	<u>25.2</u>	30.0	-	<u>4.8</u>
4	157.32 BBA	-	<u>42.0</u>	-16.6	-16.6	-	<u>25.4</u>	30.0	-	<u>4.6</u>
5	179.79 BBA	35.9	-	-14.8	-14.8	21.1	-	30.0	8.9	-
6	299.14 BBA	34.1	-	-9.1	-9.1	25.0	-	37.0	12.0	-
7	432.06 BBA	34.5	-	-6.8	-6.8	27.7	-	37.0	9.3	-
8	598.29 BBA	-	<u>33.1</u>	-4.1	-4.1	-	<u>29.0</u>	37.0	-	<u>8.0</u>
9	830.95 BBA	<u>28.0</u>	-	0.6	0.6	<u>28.6</u>	-	37.0	<u>8.4</u>	-

Higher six points are underlined.  
 Other frequencies : Below the CISPR Pub.22:1993, A2:1996 CLASS B limit  
 Emission Level = Read + Factor(Antenna, Antenna Pad, Cable, Preamp)  
 ANT. : Used antenna(BBA = Broadband antenna, DIP = Dipole antenna)

9.2.9 Above 1 GHz 1600×1200 (D-Sub 1.8m)

**Akzo Kashima Limited**  
**Nagano No.3 Test Site**  
**INTERFERENCE RADIATION TEST**

APPLICANT : MATSUSHITA ELECTRIC INDUSTRIAL CO.,LTD.  
 EUT NAME : 17" Color CRT Display Monitor  
 MODEL NO. : VCDTS21419-1\*  
 SERIAL NO. : FP8420003  
 TEST MODE : 1600×1200 (D-Sub 1.8m)  
 POWER SOURCE : AC120V/60Hz  
 DATE TESTED : Nov 19 1998  
 FILE NO. : AKL-398205  
 REGULATION : FCC Part15B CLASS B  
 TEST METHOD : ANSI C63.4-1992  
 DISTANCE : 3.0 [m]  
 TEMPERATURE : 16.0 [°C]  
 HUMIDITY : 61.0 [%]

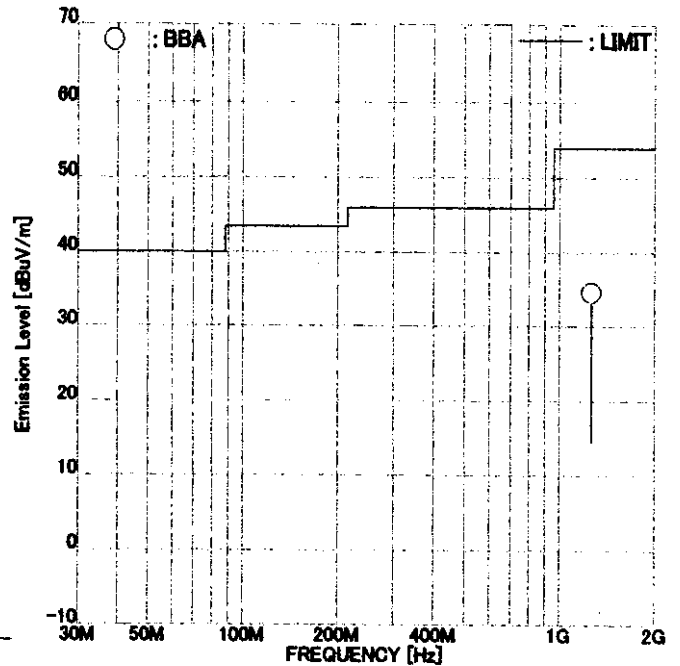

ENGINEER : Chikai Akatsu

FREQUENCY [MHz]	ANT.	READING [dBuV]		FACTOR [dB]		EMISSION [dBuV/m]		LIMIT [dBuV/m]	MARGIN [dB]		
		Hori	Vert	Hori	Vert	Hori	Vert		Hori	Vert	
1	1263.00	BBA	30.2	<u>31.3</u>	3.2	3.2	33.4	<u>34.5</u>	54.0	20.6	<u>19.5</u>

Higher six points are underlined.  
 Other frequencies : Below the FCC Part15B CLASS B limit  
 Emission Level = Read + Factor(Antenna, Antenna Pad, Cable, Preamp)  
 ANT. : Used antenna(BBA = Broadband antenna, DIP = Dipole antenna)

### 9.3 Sample Calculations

#### 9.3.1 Conducted Emission

---

Example @ 0.3761 MHz

$$\begin{array}{rcl} \text{Emission Level} & = & \text{Meter Reading} & 41.4 \text{ dBuV} \\ & & + \text{Factor} & + \underline{6.8 \text{ dB}} \\ & & & = 48.2 \text{ dBuV} \end{array}$$

$$\begin{array}{rcl} \text{Margin} & = & \text{Limit} & 58.4 \text{ dBuV} \\ & & - \text{Emission Level} & - \underline{48.2 \text{ dBuV}} \\ & & & = 10.2 \text{ dB} \end{array}$$

---

Factor = LISN Factor + Cable Loss + Pad Loss

#### 9.3.2 Radiated Emission

---

Example @ 112.37 MHz

$$\begin{array}{rcl} \text{Emission Level} & = & \text{Meter Reading} & 42.4 \text{ dBuV} \\ & & + \text{Factor} & - \underline{14.0 \text{ dB}} \\ & & & = 28.4 \text{ dBuV/m} \end{array}$$

$$\begin{array}{rcl} \text{Margin} & = & \text{Limit} & 30.0 \text{ dBuV/m} \\ & & - \text{Emission Level} & - \underline{28.4 \text{ dBuV/m}} \\ & & & = 1.6 \text{ dB} \end{array}$$

---

Factor = Antenna Factor + Cable Loss - Amplifier Gain + Pad Loss  
- Distance Conversion Factor

## SECTION 11. INSTRUMENTS USED FOR FINAL TEST

Instrument	Model No.	Serial No.	Manufacturer	Last cal. date	Period
LISN	ESH2-Z5	892377/022	ROHDE & SCHWARZ	Jul.13, 98	1 Year
	KNW-407	8-1395-4	KYORITSU	Sep. 3, 98	1 Year
6dB Attenuator	CFA-01	N3	TAMAGAWA	May.28, 98	1 Year
Coaxial cable	5D-2W (5.5 m)	C1	AKZO	Oct.26, 98	1 Year
Coaxial cable	5D-2W (1.6 m)	C2	AKZO	Oct.26, 98	1 Year
Coaxial cable	5D-2W (0.7 m)	C3	AKZO	Oct.26, 98	1 Year
Coaxial cable	5D-2W (1.6 m)	C4	AKZO	Oct.26, 98	1 Year
Broad Band antenna	LPB-2513/A	1092	A.R.A.	May.27, 98	1 Year
3dB Attenuator	8491A	34733	HEWLETT PACKARD	Jan.21, 98	1 Year
6dB Attenuator	8491A	36306	HEWLETT PACKARD	Jan.21, 98	1 Year
Step Attenuator	8494B	2812A15596	HEWLETT PACKARD	Oct.26, 98	1 Year
Amplifier	8447D	2727A05731	HEWLETT PACKARD	Jan.21, 98	1 Year
Coaxial cable	5D-2W (15.0 m)	R1	AKZO	Oct.26, 98	1 Year
Coaxial cable	5D-2W (8.0 m)	R2	AKZO	Oct.26, 98	1 Year
Coaxial cable	5D-2W (1.6 m)	R3	AKZO	Oct.26, 98	1 Year
Coaxial cable	5D-2W (0.4 m)	R4	AKZO	Oct.26, 98	1 Year
Coaxial cable	5D-2W (0.4 m)	R5	AKZO	Oct.26, 98	1 Year
Coaxial cable	5D-2W (0.7 m)	R6	AKZO	Oct.26, 98	1 Year
Coaxial cable	5D-2W (1.3 m)	R7	AKZO	Oct.26, 98	1 Year
Test receiver	ESS	844362/007	ROHDE & SCHWARZ	May.18, 98	1 Year
RF Switch	ACX-150-1	C03301501	AKZO	Oct.26, 98	1 Year
Double Ridged antenna	3115	5044	EMCO	Feb. 3, 98	1 Year
Amplifier	83051A	3332A00329	HEWLETT PACKARD	Oct.10, 98	1 Year
Coaxial cable	SUCOFLEX (6.0 m)	R9 (13272/2)	SUHNER	Jul. 1, 98	1 Year
Coaxial cable	SUCOFLEX (1.0 m)	R10 (13271/2)	SUHNER	Jul. 1, 98	1 Year
Spectrum Analyzer	8564E	3643A00665	HEWLETT PACKARD	Mar.30, 98	1 Year
Site Attenuation				Apr. 3, 98	1 Year

Note : Test instruments are calibrated according to Quality Manual and Calibration Rules of EMC division.

**SECTION 12. UNCERTAINTY OF MEASUREMENT****Uncertainty of measurement**

The uncertainty of the measurements performed for this report lies:

Radiated emission at 3m  
Above 1 GHz .....  $\pm 3.9$  dB

Radiated emission at 10m  
30 MHz – 1000 MHz .....  $\pm 3.7$  dB

Conducted emission  
9 kHz – 30 MHz .....  $\pm 1.8$  dB

These figures indicate the uncertainty of the measurements when the same staff performs the test with the same testing equipment and facility.

The uncertainty of the measurements when a different staff with different equipment and facility are under study.

Please note that these uncertainty are not reflected to the compliance judgement of the test results in this report.



**SECTION 13. VALIDITY OF TEST REPORT**

- 13.1 The test result of this report is effective for equipment under test itself and under the test configuration described on the report.
- 13.2 This test report does not assure that whether the test result taken in other testing laboratory is compatible or reproducible to the test result on this report or not.
- 13.3 Copying of this report without permission is prohibited.

## SECTION 14. DESCRIPTION OF TEST LABORATORY

### 14.1 Outline of Akzo Kashima Limited, EMC Division

Akzo Kashima Ltd. was established in 1975 for manufacturing specialty chemicals. The shares are owned by Akzo Nobel KK (70%), the country organization in Japan for Akzo Novel nv., and TOSOH Corporation (30%), one of the leading petrochemical manufacturers in Japan. Akzo Nobel, headquartered in the Netherlands, is one of the world's leading companies in selected areas of chemicals, coatings, healthcare products and fibers with work force of approximately 70,000 people in over 50 countries.

In 1984, in order to respond to the growing testing demand, in particular, for FCC filing, Akzo Kashima started EMI testing business, installing the first open air test site in Kashima, Ibaraki prefecture. Further the business has been expanded by installing additional testing facilities not only in Kashima but also in other areas such as Shizuoka, Nagano, Kanagawa and Tochigi. As results, Akzo Kashima has now 16 open air test sites and 4 anechoic chambers for EMI/EMC testing. As the largest EMC testing laboratory in number of testing facilities and staffs, EMC Division has been organized separately in the company and independently operated in conformity with the requirements of ISO Guide 25 (EN 45000) for its competency as a testing laboratory.

Akzo Kashima EMC Division is the first foreign private laboratory accredited by NVLAP, National Voluntary Laboratory Accreditation Program-NIST, USA. The division has been certified, authorized and/or filed as a competent testing laboratory by various testing organizations/authorities as described below.

### 14.2 Filing, certification, authorization and accreditation list

<u>EMI/EMC testing</u>		<u>Telecommunications terminal testing</u>	
FCC	(USA)	FCC	(USA)
NVLAP	(USA)	NVLAP	(USA)
NEMKO	(Norway)	NATA	(Australia)
VCCI	(Japan)	IC	(Canada)
NMi	(The Netherlands)		
TÜV PRODUCT SERVICE	(Germany)		

Note : NVLAP accreditation does not constitute any product endorsement by NVLAP or any agent of the U.S. Government.