



SPORTON International Inc.

No. 52, Hwa Ya 1st Rd., Kwei-Shan Hsiang, TaoYuan Hsien, Taiwan, R.O.C.
Ph: 886-3-327-3456 / FAX: 886-3-327-0973 / www.sporton.com.tw

FCC RADIO TEST REPORT

Applicant's company	ViewSonic Corporation
Applicant Address	381 Brea Canyon Rd. Walnut, CA. 91789, U.S.A.
FCC ID	GSS-VS10418M
Manufacturer's company	Universal Scientific Industrial Co., LTD (Nan Kang Plant)
Manufacturer Address	330, Kung-Yeh Road, Nan-Kang Industrial District, Nan-Tou, Taiwan

Product Name	Pocket PC (PDA)
Brand Name	ViewSonic
Model Name	VS10418
Test Rule Part(s)	47 CFR FCC Part 15 Subpart C § 15.247
Test Freq. Range	2400 ~ 2483.5MHz
Receive Date	Dec. 16, 2005
Test Date	Dec. 30, 2005
Submission Type	Original Equipment



Statement

The test result in this report refers exclusively to the presented test model / sample.

Without written approval of SPORTON International Inc., the test report shall not be reproduced except in full.

The measurements and test results shown in this test report were made in accordance with the procedures and found in compliance with the limit given in **ANSI C63.4-2003** and **47 CFR FCC Part 15 Subpart C**.

The test equipment used to perform the test is calibrated and traceable to NML/ROC.



Lab Code: 200079-0



Table of Contents

1. CERTIFICATE OF COMPLIANCE	1
2. SUMMARY OF THE TEST RESULT	2
3. GENERAL INFORMATION	3
3.1. Product Details.....	3
3.2. Accessories.....	3
3.3. Table for Filed Antenna.....	4
3.4. Table for Carrier Frequencies	4
3.5. Table for Test Modes.....	4
3.6. Table for Testing Locations.....	5
3.7. Table for Supporting Units	5
3.8. Table for Parameters of Test Software Setting	5
3.9. Test Configurations	6
4. TEST RESULT	8
4.1. AC Power Line Conducted Emissions Measurement.....	8
4.2. Maximum Peak Output Power Measurement	15
4.3. Hopping Channel Separation Measurement	17
4.4. Number of Hopping Frequency Measurement.....	22
4.5. Dwell Time Measurement.....	24
4.6. Radiated Emissions Measurement	31
4.7. Band Edge Emissions Measurement	45
4.8. Antenna Requirements	48
5. LIST OF MEASURING EQUIPMENTS	49
6. SPORTON COMPANY PROFILE.....	51
6.1. Test Location.....	51
7. CERTIFICATE OF NVLAP ACCREDITATION.....	52
APPENDIX A. PHOTOGRAPHS OF EUT.....	A1 ~ A57
APPENDIX B. TEST PHOTOS.....	B1 ~ B4



History of This Test Report

Original Issue Date: Jan. 02, 2006

Report No.: FR5D1601

- No additional attachment.
- Additional attachment were issued as following record:

Attachment No.	Issue Date	Description

1. CERTIFICATE OF COMPLIANCE

Product Name : Pocket PC (PDA)
Brand Name : ViewSonic
Model Name : VS10418
Applicant : ViewSonic Corporation
Test Rule Part(s) : 47 CFR FCC Part 15 Subpart C § 15.247

Sporton International as requested by the applicant to evaluate the EMC performance of the product sample received on Dec. 16, 2005 would like to declare that the tested sample has been evaluated and found to be in compliance with the tested rule parts. The data recorded as well as the test configuration specified is true and accurate for showing the sample's EMC nature.



Wayne Hsu / Supervisor
Sporton International Inc.

2. SUMMARY OF THE TEST RESULT

Applied Standard: 47 CFR FCC Part 15 Subpart C				
Part	Rule Section	Description of Test	Result	Under Limit
4.1	15.207	AC Power Line Conducted Emissions	Complies	10.90 dB
4.2	15.247(b)(1)	Maximum Peak Conducted Output Power	Complies	29.67 dB
4.3	15.247(a)(1)	Hopping Channel Separation	Complies	-
4.4	15.247(b)(1)	Number of Hopping Frequency	Complies	-
4.5	15.247(a)(1)	Dwell Time	Complies	-
4.6	15.247(d)	Radiated Emissions	Complies	5.93 dB
4.7	15.247(d)	Band Edge Emissions	Complies	7.16 dB
4.8	15.203	Antenna Requirements	Complies	-

Test Items	Uncertainty	Remark
AC Power Line Conducted Emissions	±2.26dB	Confidence levels of 95%
Maximum Peak Conducted Output Power	±0.5dB	Confidence levels of 95%
Hopping Channel Separation / Dwell Time	±6.25×10 ⁻⁷	Confidence levels of 95%
Radiated Emissions / Band Edge Emissions	±3.72dB	Confidence levels of 95%

3. GENERAL INFORMATION

3.1. Product Details

Items	Description
Radio Type	Intentional Transceiver
Power Type	Power Adapter & Battery
Interface Type	Please refer to user's manual
Modulation	FHSS (GFSK)
Data Rate (Mbps)	1
Frequency Range	2400 ~ 2483.5MHz
Channel Number	79
Channel Band Width (99%)	856.00 MHz
Conducted Output Power	0.33 dBm
Carrier Frequencies	Please refer to section 3.4
Antenna	Please refer to section 3.3

3.2. Accessories

- Desktop cradle (also called dock) with battery charging and communication
- Camera for snapshots
- Car adapter cradle
- Avalon RF
- Extended battery with extended back cover
- AC power dongle
- Belt clip
- Hand strap
- Fingerprint sensor

3.3. Table for Filed Antenna

Ant.	Antenna Type	Connector	Gain (dBi)	Remark
1	Integrated Antenna	NA	2.29	Bluetooth

3.4. Table for Carrier Frequencies

Frequency Band	Channel No.	Frequency
2400~2483.5MHz	0	2402 MHz
	1	2403 MHz
	:	:
	38	2440 MHz
	39	2441 MHz
	40	2442 MHz
	:	:
	77	2479 MHz
	78	2480 MHz

3.5. Table for Test Modes

Investigation has been done on all the possible configurations for searching the worst cases. The following table is a list of the test modes shown in this test report.

Test Items	Mode	Data Rate	Channel	Antenna
AC Power Conducted Emissions	Normal Link Adapter +RS232 / Cradle)	1 Mbps	Hopping 0~78	1
Max. Conducted Output Power	GFSK	1 Mbps	0/39/78	NA
Hopping Channel Separation	GFSK	1 Mbps	0~1/39~40/77~78	NA
Number of Hopping Frequency	GFSK	1 Mbps	0~78	NA
Dwell Time	DH1/DH3/DH5	1 Mbps	0/39/78	NA
Radiated Emissions Below 1GHz	GFSK	1 Mbps	39	1
Radiated Emissions Above 1GHz Band Edge Emissions	GFSK	1 Mbps	0/39/78	1

3.6. Table for Testing Locations

Test Site No.	Site Category	Location	FCC Reg. No.	IC File No.	VCCI Reg. No
03CH03-HY	SAC	Hwa Ya	101377	IC 4088	-
CO04-HY	Conduction	Hwa Ya	101377	IC 4088	-
TH01-HY	OVEN Room	Hwa Ya	-	-	-

Open Area Test Site (OATS); Semi Anechoic Chamber (SAC); Fully Anechoic Chamber (FAC).

Please refer section 6 for Test Site Address.

3.7. Table for Supporting Units

Support Unit	Brand	Model	FCC ID
P.C.	COMPAQ	Evo D380MX	DoC
LCD Monitor	VIEWSONIC	VLCDS0104-3W	DoC
Mouse (PS2)	COMPAQ	M-S69	DoC
Keyboard (PS2)	COMPAQ	6511-VA	DoC
Printer	EPSON	EPSON STYLUS C61	DoC
USB 2.0HDD	TeraSys	F12-UF	DoC
Keyboard	IBM	SK-8815	DoC

3.8. Table for Parameters of Test Software Setting

During testing, Channel & Power Controlling Software provided by the customer was used to control the operating channel as well as the output power level. The RF output power selection is for the setting of RF output power expected by the customer and is going to be fixed on the firmware of the final end product.

Power Parameters of Bluetooth

Test Software Version	WM-BG-MR		
Frequency	2402 MHz	2441 MHz	2480 MHz
Power Parameters	53	53	53

3.9. Test Configurations

3.9.1. Radiation Emissions Test Configuration

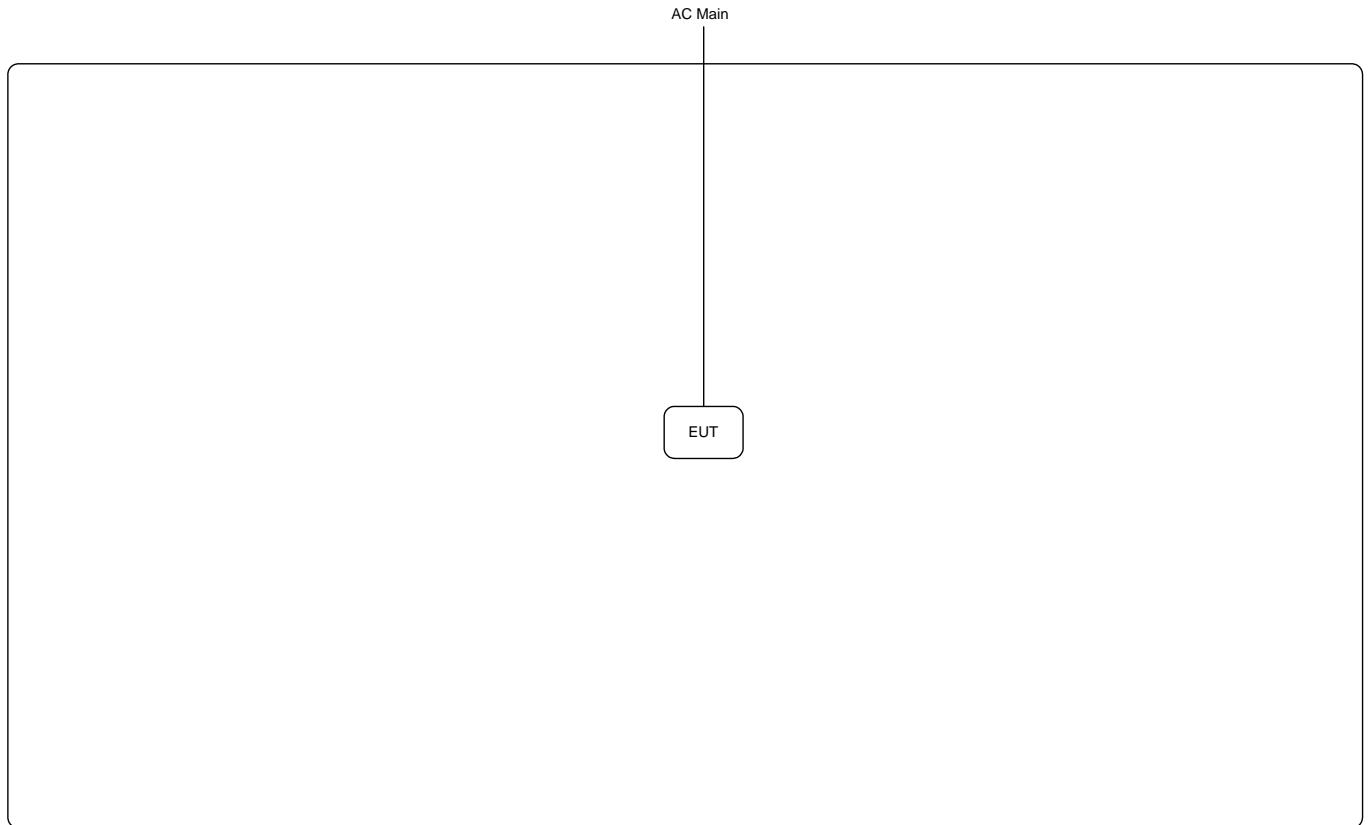

3.9.2. AC Power Line Conduction Emissions Test Configuration

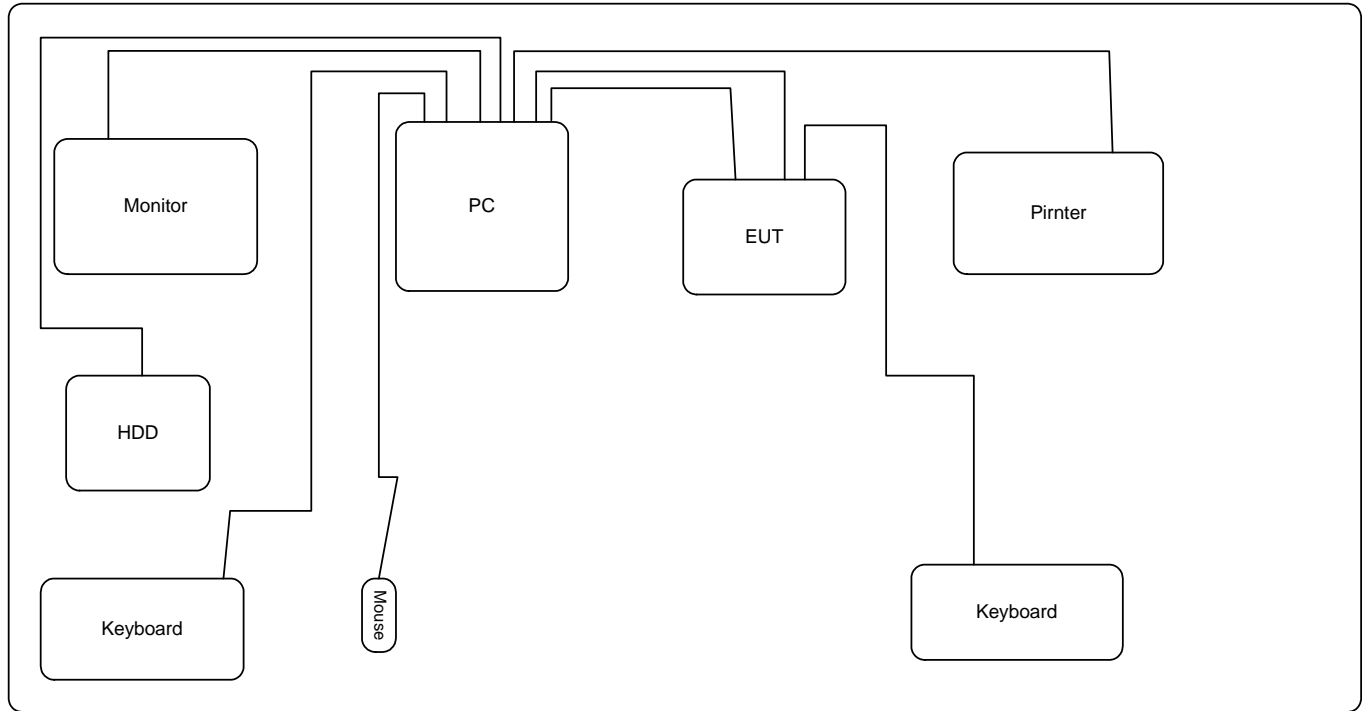

4. TEST RESULT

4.1. AC Power Line Conducted Emissions Measurement

4.1.1. Limit

For a Low-power Radio-frequency Device which is designed to be connected to the AC power line, the radio frequency voltage that is conducted back onto the AC power line on any frequency or frequencies within the band 150 kHz to 30 MHz shall not exceed below limits table.

Frequency (MHz)	QP Limit (dBuV)	AV Limit (dBuV)
0.15~0.5	66~56	56~46
0.5~5	56	46
5~30	60	50

4.1.2. Measuring Instruments and Setting

Please refer to section 5 in this report. The following table is the setting of the receiver.

Receiver Parameters	Setting
Attenuation	10 dB
Start Frequency	0.15 MHz
Stop Frequency	30 MHz
IF Bandwidth	9 KHz

4.1.3. Test Procedures

1. Configure the EUT according to ANSI C63.4. The EUT or host of EUT has to be placed 0.4 meter far from the conducting wall of the shielding room and at least 80 centimeters from any other grounded conducting surface.
2. Connect EUT or host of EUT to the power mains through a line impedance stabilization network (LISN).
3. All the support units are connected to the other LISNs. The LISN should provide 50uH/50ohms coupling impedance.
4. The frequency range from 150 KHz to 30 MHz was searched.
5. Set the test-receiver system to Peak Detect Function and Specified Bandwidth with Maximum Hold Mode.
6. The measurement has to be done between each power line and ground at the power terminal.

4.1.4. Test Setup Layout

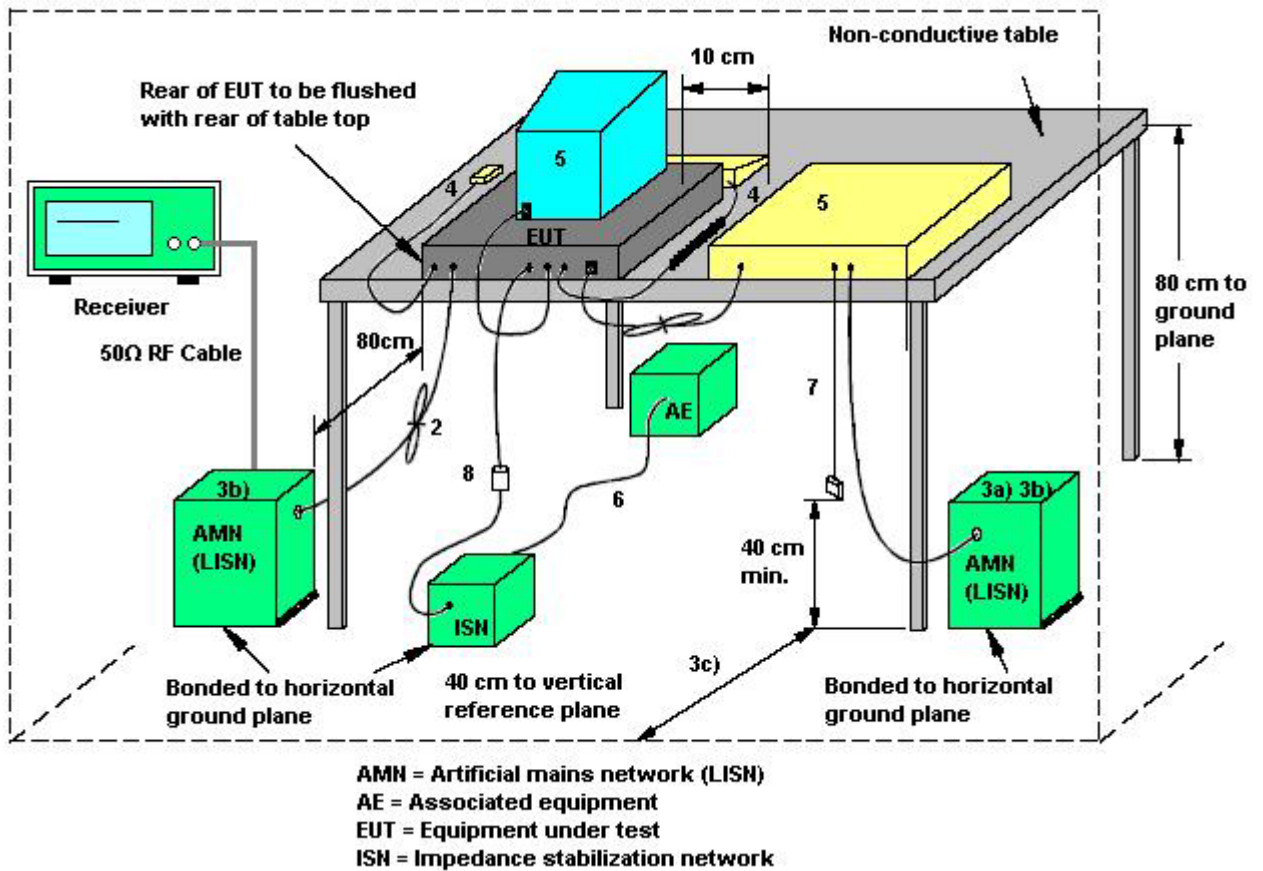

1. If cables, which hang closer than 40 cm to the horizontal metal groundplane, cannot be shortened to appropriate length, the excess shall be folded back and forth forming a bundle 30 cm to 40 cm long.
2. Excess mains cord shall be bundled in the centre or shortened to appropriate length.
3. EUT is connected to one artificial mains network (AMN). All AMNs and ISNs may alternatively be connected to a vertical reference plane or metal wall.
4. All other units of a system are powered from a second AMN. A multiple outlet strip can be used for multiple mains cords.
5. AMN and ISN are 80 cm from the EUT and at least 80 cm from other units and other metal planes.
6. Mains cords and signal cables shall be positioned for their entire lengths, as far as possible, at 40 cm from the vertical reference plane.
7. Cables of hand operated devices, such as keyboards, mice, etc. shall be placed as for normal usage.
8. Peripherals shall be placed at a distance of 10 cm from each other and from the controller, except for the monitor which, if this is an acceptable installation practice, shall be placed directly on the top of the controller.
9. I/O signal cable intended for external connection.
10. The end of the I/O signal cables which are not connected to an AE may be terminated, if required, using correct terminating impedance.
11. If used, the current probe shall be placed at 0,1 m from the ISN.

4.1.5. Test Deviation

There is no deviation with the original standard.

4.1.6. EUT Operation during Test

The EUT was placed on the test table and programmed in normal function.

4.1.7. Results of AC Power Line Conducted Emissions Measurement

Temperature	20°C	Humidity	50%
Test Engineer	Sam	Phase	Line
Configuration	Dongle Mode		

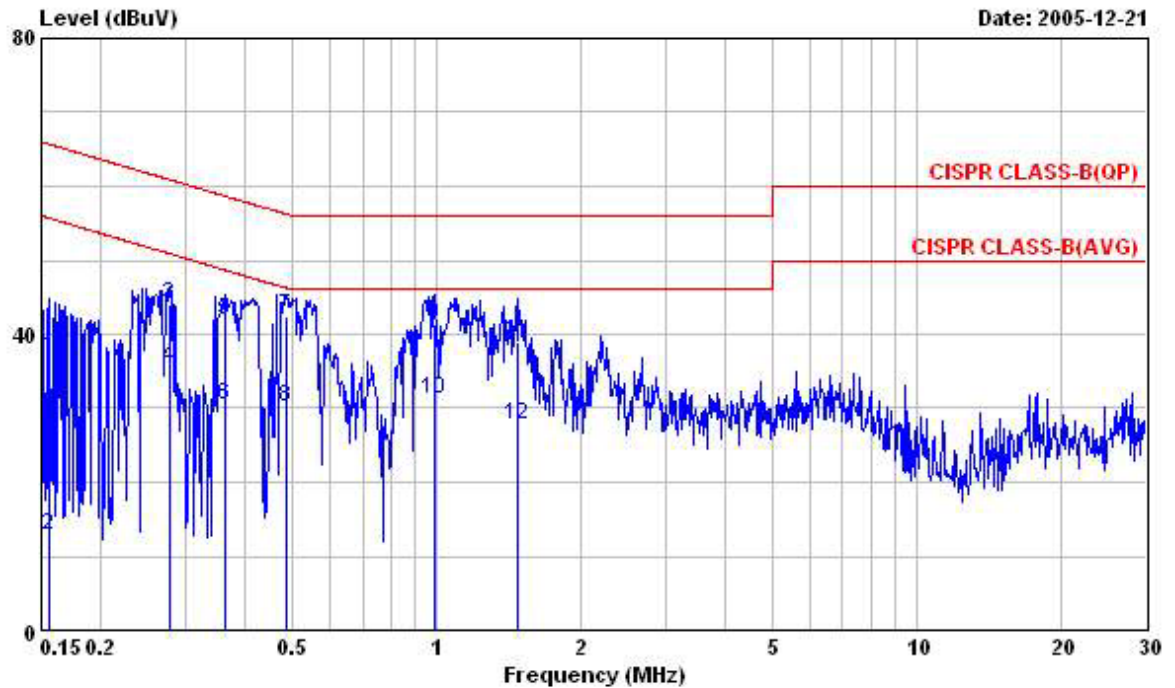

	Freq	Level	Over Limit	Limit Line	Read Level	Factor	Cable Loss	LISN Factor	Remark
	MHz	dBuV	dB	dBuV	dBuV	dB	dB	dB	
1	0.156	36.79	-28.88	65.67	36.69	0.10	0.00	0.10	QP
2	0.156	12.67	-43.00	55.67	12.57	0.10	0.00	0.10	Average
3	0.279	43.89	-16.96	60.85	43.74	0.15	0.05	0.10	QP
4	0.279	35.44	-15.41	50.85	35.29	0.15	0.05	0.10	Average
5	0.363	41.94	-16.72	58.66	41.84	0.10	0.00	0.10	QP
6	0.363	30.40	-18.26	48.66	30.30	0.10	0.00	0.10	Average
7	0.486	42.41	-13.83	56.24	42.31	0.10	0.00	0.10	QP
8	0.486	30.15	-16.09	46.24	30.05	0.10	0.00	0.10	Average
9	0.989	41.36	-14.64	56.00	41.16	0.20	0.10	0.10	QP
10	0.989	31.10	-14.90	46.00	30.90	0.20	0.10	0.10	Average
11	1.470	39.00	-17.00	56.00	38.89	0.11	0.01	0.10	QP
12	1.470	27.73	-18.27	46.00	27.62	0.11	0.01	0.10	Average

Temperature	20°C	Humidity	50%
Test Engineer	Sam	Phase	Neutral
Configuration	Dongle Mode		

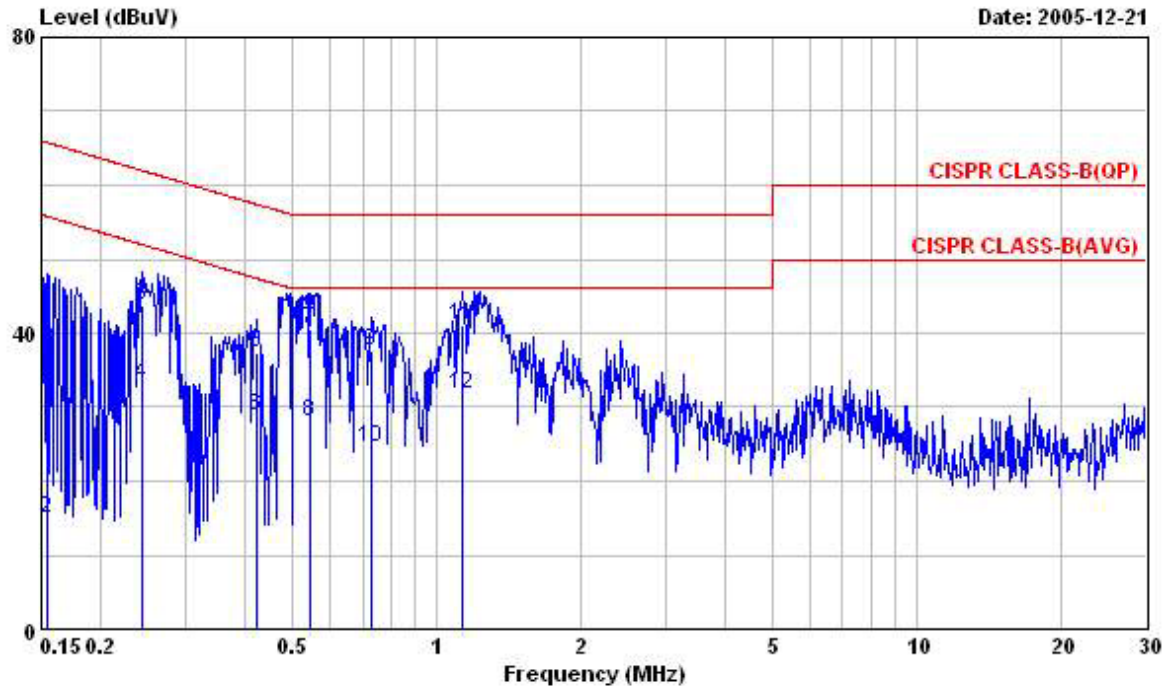

	Freq	Level	Over Limit	Limit Line	Read Level	Factor	Cable Loss	LISN Factor	Remark
	MHz	dBuV	dB	dBuV	dBuV	dB	dB	dB	
1	0.154	39.84	-25.94	65.78	39.74	0.10	0.00	0.10	QP
2	0.154	14.83	-40.95	55.78	14.73	0.10	0.00	0.10	Average
3	0.243	43.69	-18.30	61.99	43.49	0.20	0.10	0.10	QP
4	0.243	33.02	-18.97	51.99	32.82	0.20	0.10	0.10	Average
5	0.421	37.21	-20.22	57.43	37.06	0.15	0.05	0.10	QP
6	0.421	28.92	-18.51	47.43	28.77	0.15	0.05	0.10	Average
7	0.544	40.64	-15.36	56.00	40.53	0.11	0.01	0.10	QP
8	0.544	27.99	-18.01	46.00	27.88	0.11	0.01	0.10	Average
9	0.731	37.70	-18.30	56.00	37.56	0.14	0.04	0.10	QP
10	0.731	24.56	-21.44	46.00	24.42	0.14	0.04	0.10	Average
11	1.130	41.00	-15.00	56.00	40.83	0.17	0.07	0.10	QP
12	1.130	31.76	-14.24	46.00	31.59	0.17	0.07	0.10	Average

Note:

Level = Read Level + LISN Factor + Cable Loss.

Temperature	20°C	Humidity	50%
Test Engineer	Sam	Phase	Line
Configuration	Cradle Mode		

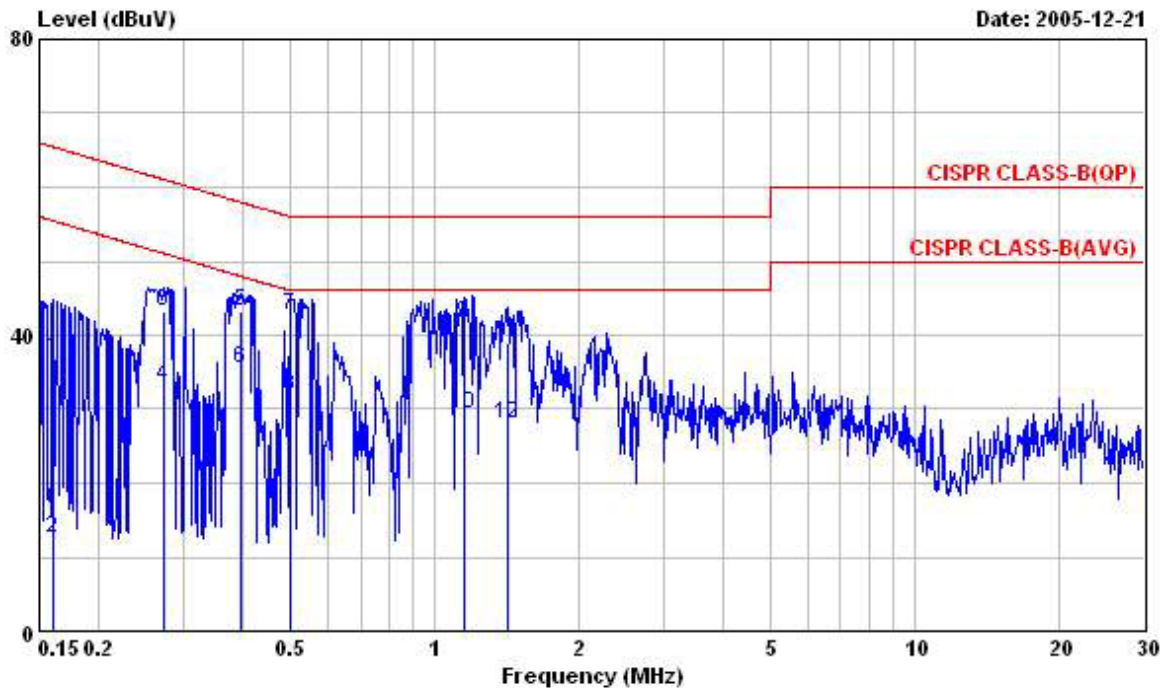

	Freq	Level	Over Limit	Limit Line	Read Level	Factor	Cable Loss	LISN Factor	Remark
	MHz	dBuV	dB	dBuV	dBuV	dB	dB	dB	
1	0.161	36.73	-28.68	65.41	36.63	0.10	0.00	0.10	QP
2	0.161	12.52	-42.89	55.41	12.42	0.10	0.00	0.10	Average
3	0.272	43.16	-17.90	61.06	43.01	0.15	0.05	0.10	QP
4	0.272	33.10	-17.96	51.06	32.95	0.15	0.05	0.10	Average
5	0.393	43.28	-14.72	58.00	43.08	0.20	0.10	0.10	QP
6 [ⓑ]	0.393	35.39	-12.61	48.00	35.19	0.20	0.10	0.10	Average
7	0.502	42.79	-13.21	56.00	42.69	0.10	0.00	0.10	QP
8	0.502	31.74	-14.26	46.00	31.64	0.10	0.00	0.10	Average
9	1.150	41.57	-14.43	56.00	41.41	0.16	0.06	0.10	QP
10	1.150	29.21	-16.79	46.00	29.05	0.16	0.06	0.10	Average
11	1.420	39.06	-16.94	56.00	38.95	0.11	0.01	0.10	QP
12	1.420	27.88	-18.12	46.00	27.77	0.11	0.01	0.10	Average

Temperature	20°C	Humidity	50%
Test Engineer	Sam	Phase	Neutral
Configuration	Cradle Mode		

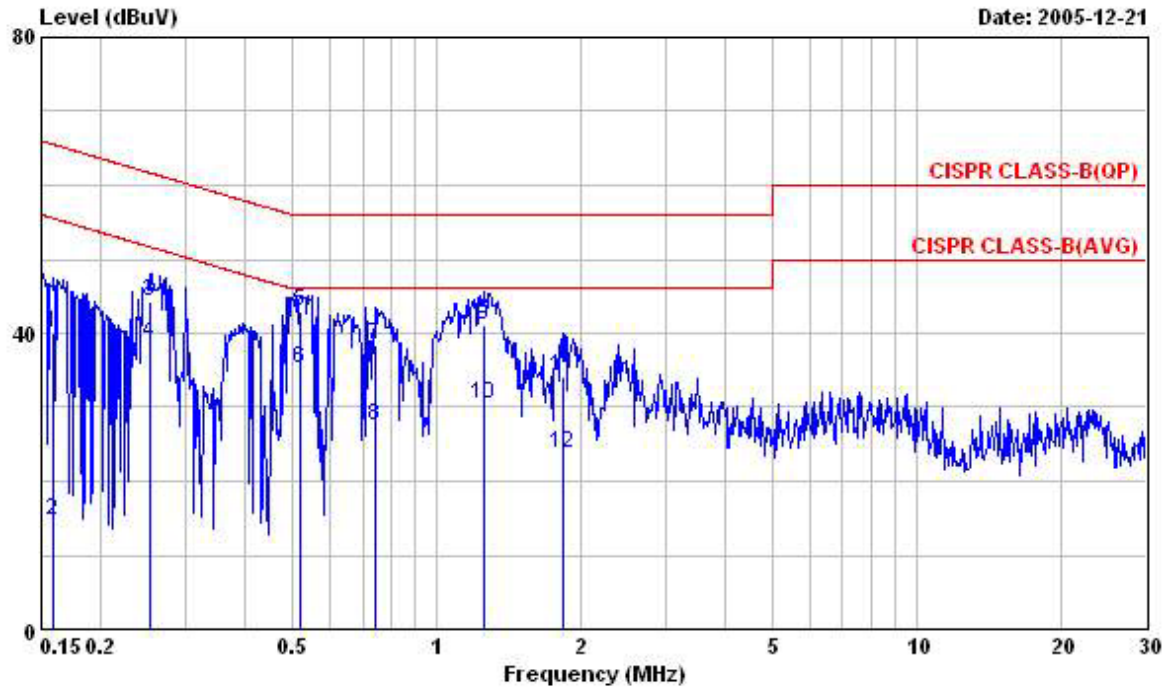

	Freq	Level	Over Limit	Limit Line	Read Level	Cable Factor	Cable Loss	LISN Factor	Remark
	MHz	dBuV	dB	dBuV	dBuV	dB	dB	dB	
1	0.159	39.94	-25.58	65.52	39.84	0.10	0.00	0.10	QP
2	0.159	14.57	-40.95	55.52	14.47	0.10	0.00	0.10	Average
3	0.253	44.18	-17.48	61.66	43.98	0.20	0.10	0.10	QP
4	0.253	38.56	-13.10	51.66	38.36	0.20	0.10	0.10	Average
5	0.521	42.89	-13.11	56.00	42.79	0.10	0.00	0.10	QP
6 @	0.521	35.10	-10.90	46.00	35.00	0.10	0.00	0.10	Average
7	0.743	38.43	-17.57	56.00	38.28	0.15	0.05	0.10	QP
8	0.743	27.36	-18.64	46.00	27.21	0.15	0.05	0.10	Average
9	1.250	41.00	-15.00	56.00	40.85	0.15	0.05	0.10	QP
10	1.250	30.42	-15.58	46.00	30.27	0.15	0.05	0.10	Average
11	1.840	34.03	-21.97	56.00	33.93	0.10	0.00	0.10	QP
12	1.840	23.83	-22.17	46.00	23.73	0.10	0.00	0.10	Average

Note:

Level = Read Level + LISN Factor + Cable Loss.

4.2. Maximum Peak Output Power Measurement

4.2.1. Limit

For frequency hopping systems operating in the 2400-2483.5 MHz band employing at least 75 non-overlapping hopping channels, the limit for peak output power is 30dBm. The limited has to be reduced by the amount in dB that the gain of the antenna exceed 6dBi. In case of point-to-point operation, the limit has to be reduced by 1dB for every 3dB that the directional gain of the antenna exceeds 6dBi.

4.2.2. Measuring Instruments and Setting

Please refer to section 5 in this report. The following table is the setting of the power meter.

Power Meter Parameter	Setting
Filter No.	Auto
Measurement time	0.135 s ~ 26 s
Used Peak Sensor	NRV-Z32 (model 04)

4.2.3. Test Procedures

1. The transmitter output (antenna port) was connected to the power meter.
2. Turn on the EUT and power meter and then record the peak power value.
3. Repeat above procedures on all channels needed to be tested.

4.2.4. Test Setup Layout

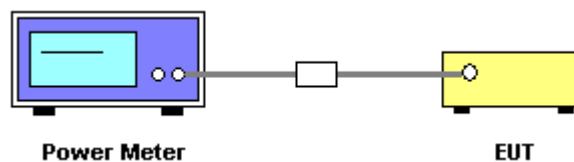

4.2.5. Test Deviation

There is no deviation with the original standard.

4.2.6. EUT Operation during Test

The EUT was programmed to be in continuously transmitting mode.

4.2.7. Test Result of Maximum Peak Output Power

Temperature	20°C	Humidity	50%
Test Engineer	Sam Lee	Configurations	FHSS (GFSK)

Channel	Frequency	Conducted Power (dBm)	Max. Limit (dBm)	Result
0	2402 MHz	0.21	30.00	Complies
39	2441 MHz	0.33	30.00	Complies
78	2480 MHz	0.32	30.00	Complies

4.3. Hopping Channel Separation Measurement

4.3.1. Limit

Frequency hopping systems shall have hopping channel carrier frequencies separated by a minimum of 25 kHz or the 20 dB bandwidth of the hopping channel, whichever is greater. Alternatively, frequency hopping systems operating in the 2400-2483.5 MHz band may have hopping channel carrier frequencies that are separated by 25 kHz or two-thirds of the 20 dB bandwidth of the hopping channel, whichever is greater.

4.3.2. Measuring Instruments and Setting

Please refer to section 5 in this report. The following table is the setting of Spectrum Analyzer.

Spectrum Parameter	Setting
Attenuation	Auto
Span Frequency	> Measurement Bandwidth or Channel Separation
RB	30 kHz (20dB Bandwidth) / 100 kHz (Channel Separation)
VB	100 kHz (20dB Bandwidth) / 300 kHz (Channel Separation)
Detector	Peak
Trace	Max Hold
Sweep Time	Auto

4.3.3. Test Procedures

1. The transmitter output (antenna port) was connected to the spectrum analyser in peak hold mode.
2. The resolution bandwidth of 30 kHz and the video bandwidth of 100 kHz were utilised for 20 dB bandwidth measurement.
3. The resolution bandwidth of 100 kHz and the video bandwidth of 300 kHz were utilised for channel separation measurement.

4.3.4. Test Setup Layout

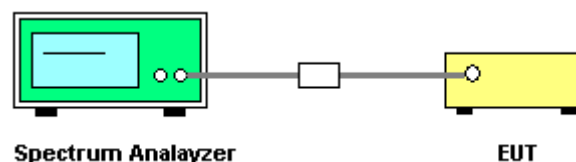

4.3.5. Test Deviation

There is no deviation with the original standard.

4.3.6. EUT Operation during Test

The EUT was programmed to be in continuously transmitting mode.

4.3.7. Test Result of Hopping Channel Separation

Temperature	20°C	Humidity	50%
Test Engineer	Sam Lee	Configurations	FHSS (GFSK)

Frequency	Ch. Separation (MHz)	20dB Bandwidth (kHz)	99% Occupied Bandwidth (kHz)	Result
2402 MHz	1.00	828.00	856.00	Complies
2441 MHz	1.00	828.00	852.00	Complies
2480 MHz	1.00	832.00	852.00	Complies

Ch. Separation Limits: >20dB bandwidth or >2/3 of 20dB bandwidth

20 dB Bandwidth Plot on Channel 0 / 2402 MHz

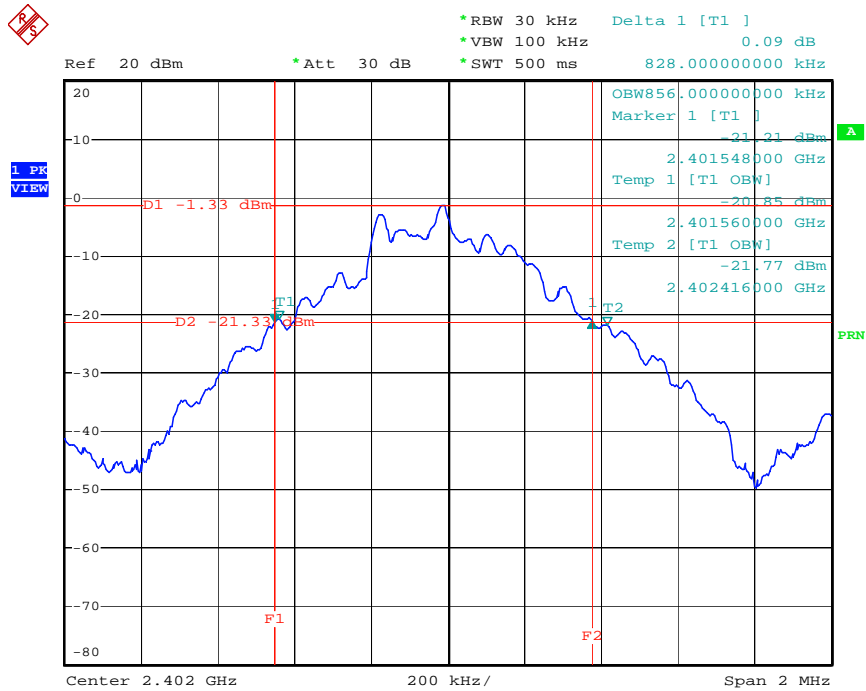

Date: 18.OCT.2005 17:12:37

20 dB Bandwidth Plot on Channel 39 / 2441 MHz

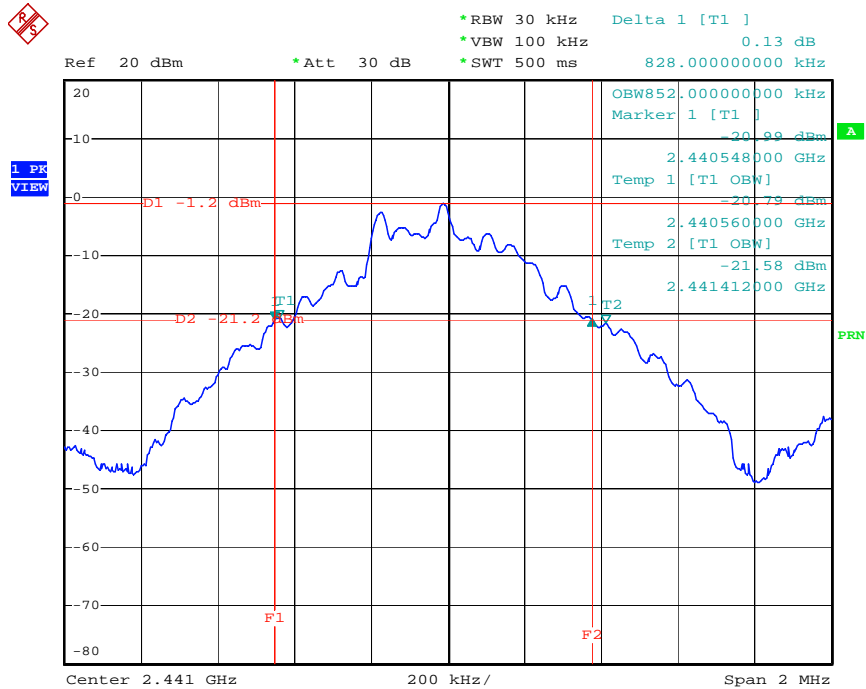

Date: 18.OCT.2005 17:11:16

20 dB Bandwidth Plot on Channel 78 / 2480 MHz

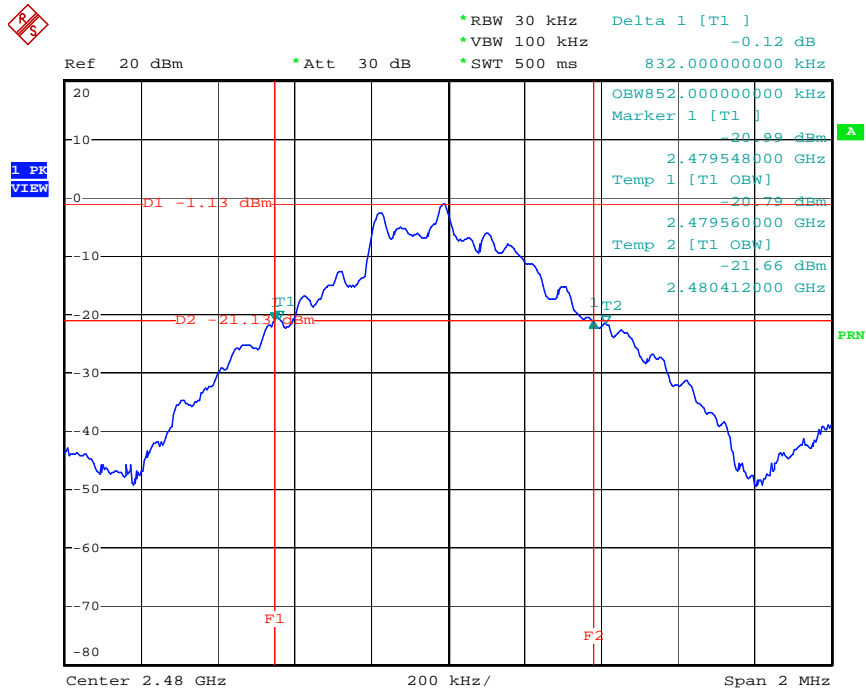

Date: 18.OCT.2005 17:08:02

Channel Separation Plot on Channel 0~1 / 2402 MHz ~ 2403 MHz

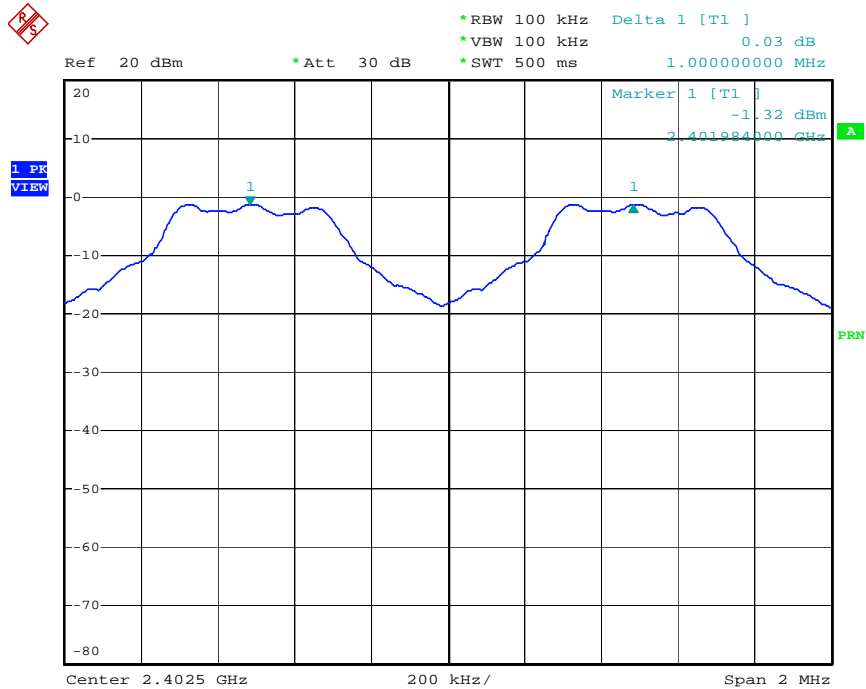

Date: 18.OCT.2005 17:15:09

Channel Separation Plot on Channel 39~40 / 2441 MHz ~ 2442 MHz

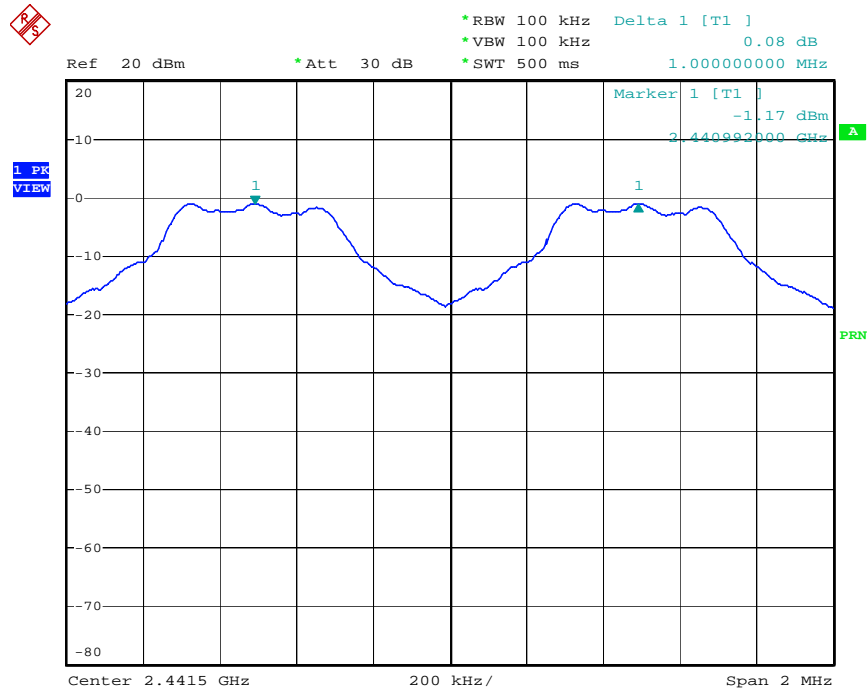

Date: 18.OCT.2005 17:16:15

Channel Separation Plot on Channel 77~78 / 2479 MHz ~ 2480 MHz

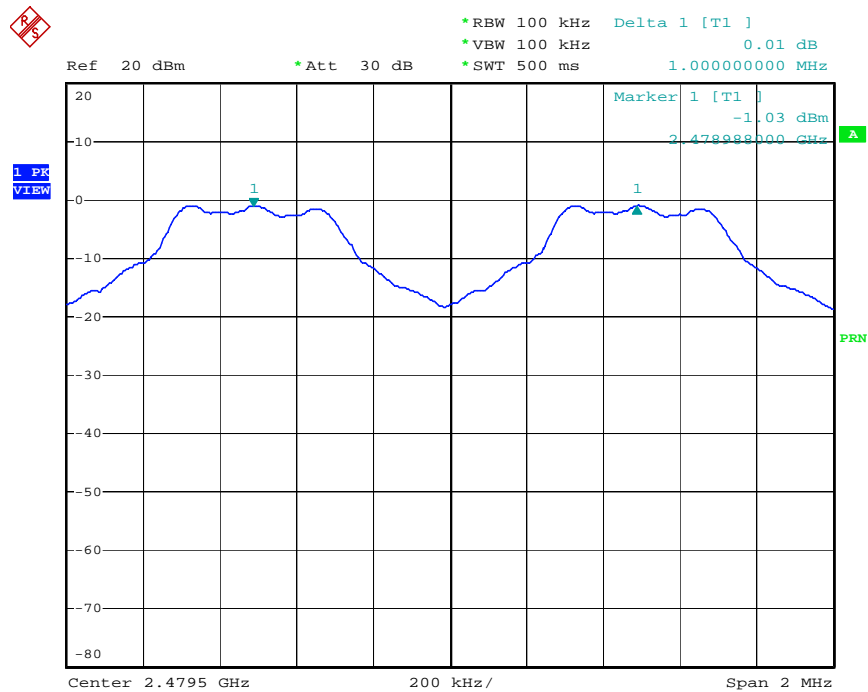

Date: 18.OCT.2005 17:17:35

4.4. Number of Hopping Frequency Measurement

4.4.1. Limit

For frequency hopping systems operating in the 2400-2483.5 MHz band employing at least 75 non-overlapping hopping channels.

4.4.2. Measuring Instruments and Setting

Please refer to section 5 in this report. The following table is the setting of the Spectrum Analyzer.

Spectrum Parameters	Setting
Attenuation	Auto
Span Frequency	> Operating Frequency Range
RB	100 kHz
VB	100 kHz
Detector	Peak
Trace	Max Hold
Sweep Time	Auto

4.4.3. Test Procedures

1. The transmitter output (antenna port) was connected to the spectrum analyser in peak hold mode.
2. The resolution bandwidth of 100 kHz and the video bandwidth of 100 kHz were utilised.
3. Observe frequency hopping in 2400MHz~2483.5MHz, there are at least 75 non-overlapping channels.

4.4.4. Test Setup Layout

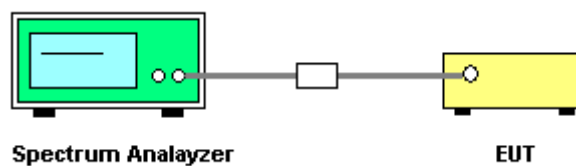

4.4.5. Test Deviation

There is no deviation with the original standard.

4.4.6. EUT Operation during Test

The EUT was programmed to be in continuously transmitting mode.

4.4.7. Test Result of Number of Hopping Frequency

Temperature	20°C	Humidity	50%
Test Engineer	Sam Lee	Configurations	FHSS (GFSK)

Modulation Type	Channel No.	Frequency (MHz)	Hopping Ch. (Channels)	Min. Limit (Channels)	Test Result
GFSK	0 ~ 78	2402 ~ 2480	79	75	Complies

Number of Hopping Channel Plot on Channel 0~78 / 2402 MHz ~ 2480 MHz

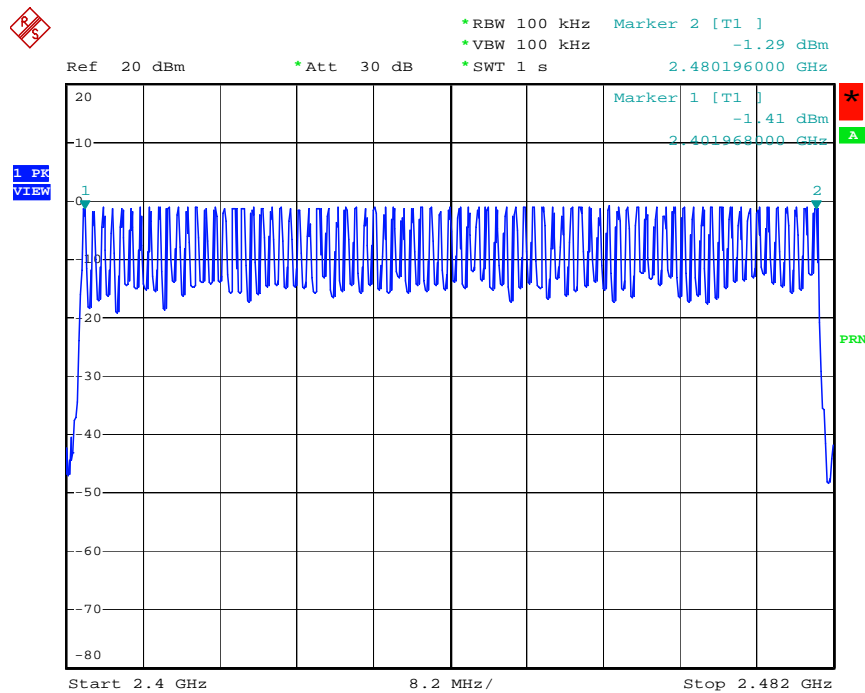

Date: 18.OCT.2005 17:21:52

4.5. Dwell Time Measurement

4.5.1. Limit

Frequency hopping systems in the 2400-2483.5 MHz band shall use at least 15 channels. The average time of occupancy on any channel shall not be greater than 0.4 seconds within a period of 0.4 seconds multiplied by the number of hopping channels employed.

4.5.2. Measuring Instruments and Setting

Please refer to section 5 in this report. The following table is the setting of Spectrum Analyzer.

Spectrum Parameter	Setting
Attenuation	Auto
Span Frequency	0 MHz
RB	1000 kHz
VB	1000 kHz
Detector	Peak
Trace	Single Trigger

4.5.3. Test Procedures

1. The transmitter output (antenna port) was connected to the spectrum analyser
2. Set RBW of spectrum analyzer to 1000kHz and VBW to 1000kHz.
3. Use a video trigger with the trigger level set to enable triggering only on full pulses.
4. Sweep Time is more than once pulse time.
5. Set the center frequency on any frequency would be measure and set the frequency span to zero span.
6. Measure the maximum time duration of one single pulse.
7. Set the EUT for DH5, DH3 and DH1 packet transmitting.
8. Measure the maximum time duration of one single pulse.
9. DH5 Packet permit maximum $1600 / 79 / 6 = 3.37$ hops per second in each channel (5 time slots RX, 1 time slot TX). So, the dwell time is the time duration of the pulse times $3.37 \times 31.6 = 106.6$ within 31.6 seconds
10. DH3 Packet permit maximum $1600 / 79 / 4 = 5.06$ hops per second in each channel (3 time slots RX, 1 time slot TX). So, the dwell time is the time duration of the pulse times $5.06 \times 31.6 = 160$ within 31.6 seconds.
11. DH1 Packet permit maximum $1600 / 79 / 2 = 10.12$ hops per second in each channel (1 time slot RX, 1 time slot TX). So, the dwell time is the time duration of the pulse times $10.12 \times 31.6 = 320$ within 31.6 seconds.

4.5.4. Test Setup Layout

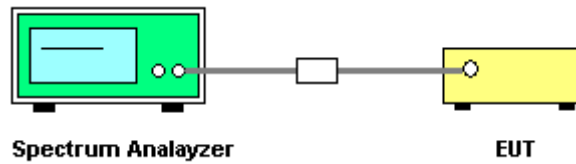

4.5.5. Test Deviation

There is no deviation with the original standard.

4.5.6. EUT Operation during Test

The EUT was programmed to be in continuously transmitting mode.

4.5.7. Test Result of Dwell Time

Temperature	20°C	Humidity	50%
Test Engineer	Sam Lee	Configurations	FHSS (GFSK)

Data Packet	Frequency	Pulse Duration (ms)	Dwell Time (s)	Limits (s)	Test Result
DH5	2402 MHz	3.1200	0.3328	0.4000	Complies
DH3	2402 MHz	1.8600	0.2976	0.4000	Complies
DH1	2402 MHz	0.6000	0.1920	0.4000	Complies
DH5	2441 MHz	3.1200	0.3328	0.4000	Complies
DH3	2441 MHz	1.8600	0.2976	0.4000	Complies
DH1	2441 MHz	0.6000	0.1920	0.4000	Complies
DH5	2480 MHz	3.1200	0.3328	0.4000	Complies
DH3	2480 MHz	1.8600	0.2976	0.4000	Complies
DH1	2480 MHz	0.6000	0.1920	0.4000	Complies

DH5 Dwell Time Plot on Channel 0 / 2402 MHz

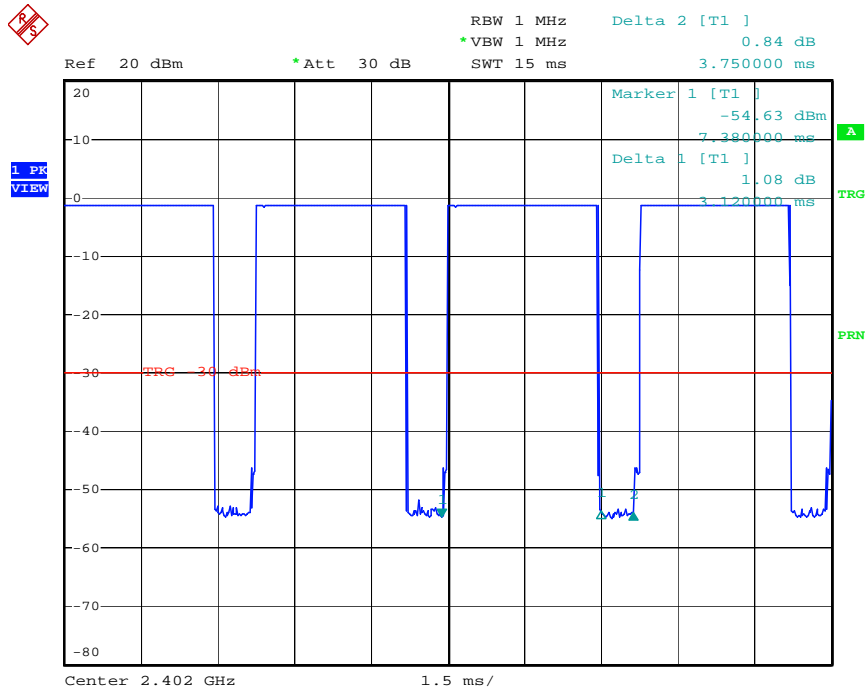

Date: 18.OCT.2005 17:26:34

DH3 Dwell Time Plot on Channel 0 / 2402 MHz

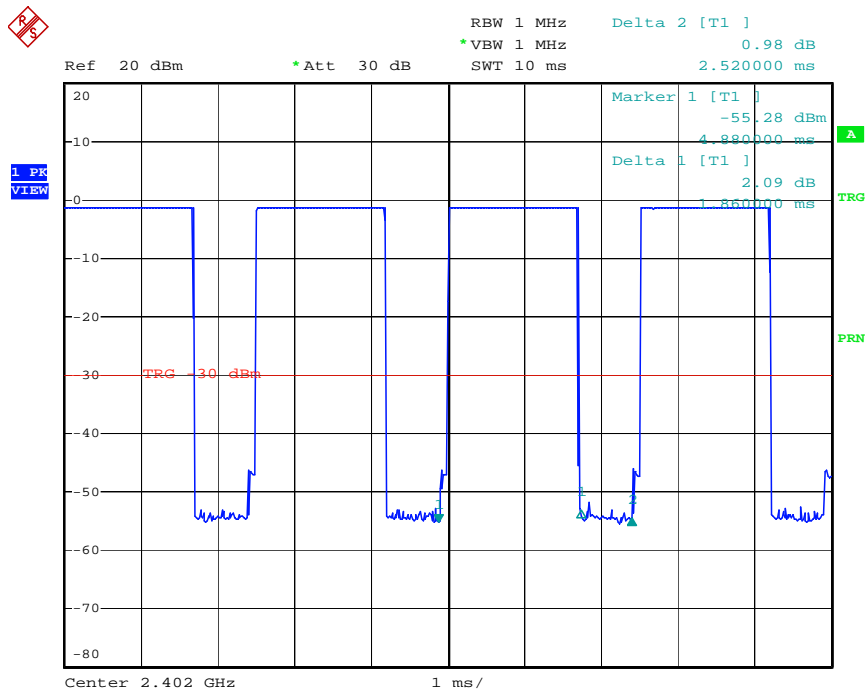

Date: 18.OCT.2005 17:25:22

DH1 Dwell Time Plot on Channel 0 / 2402 MHz

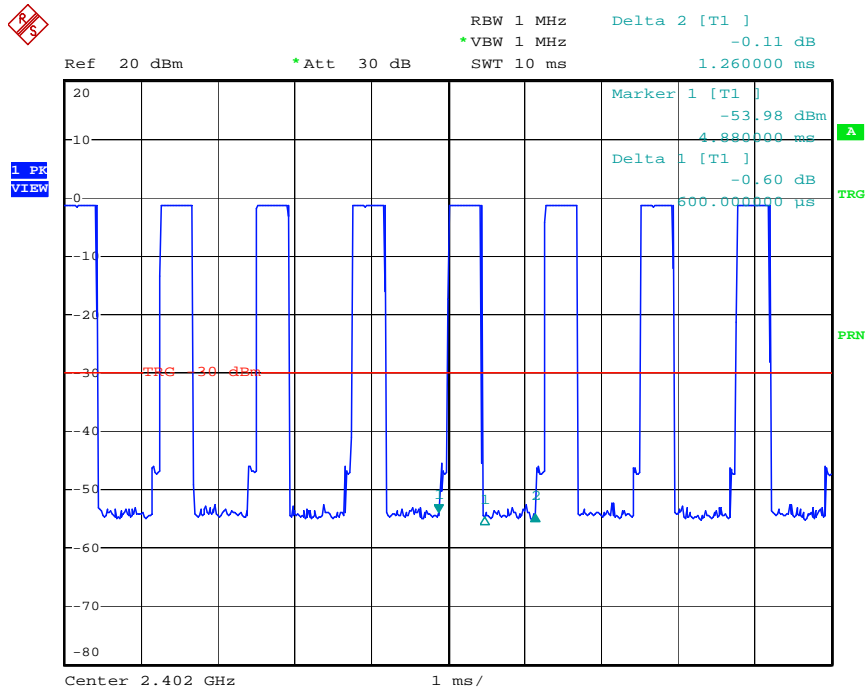

Date: 18.OCT.2005 17:24:43

DH5 Dwell Time Plot on Channel 39 / 2441 MHz

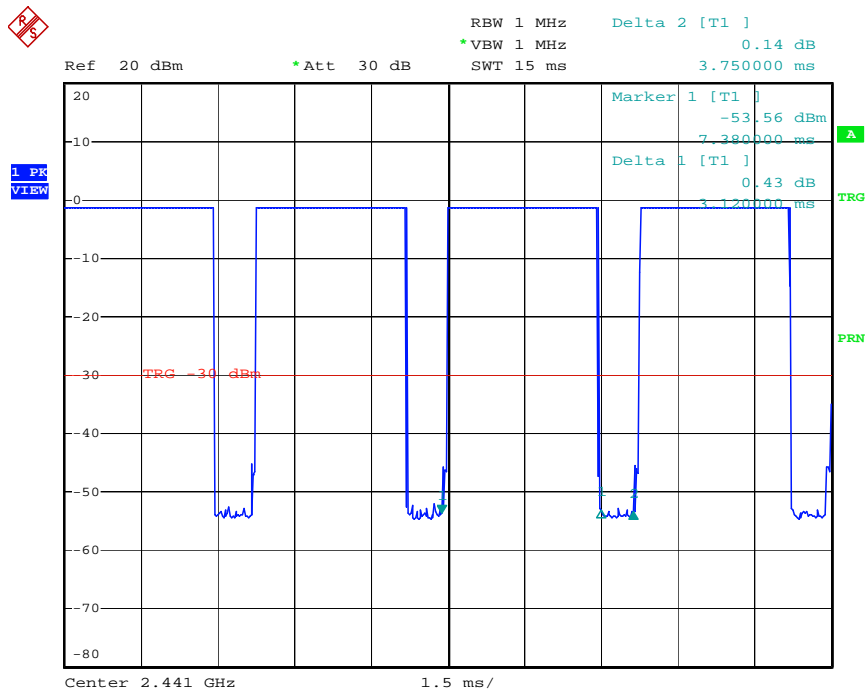

Date: 18.OCT.2005 17:28:56

DH3 Dwell Time Plot on Channel 39 / 2441 MHz

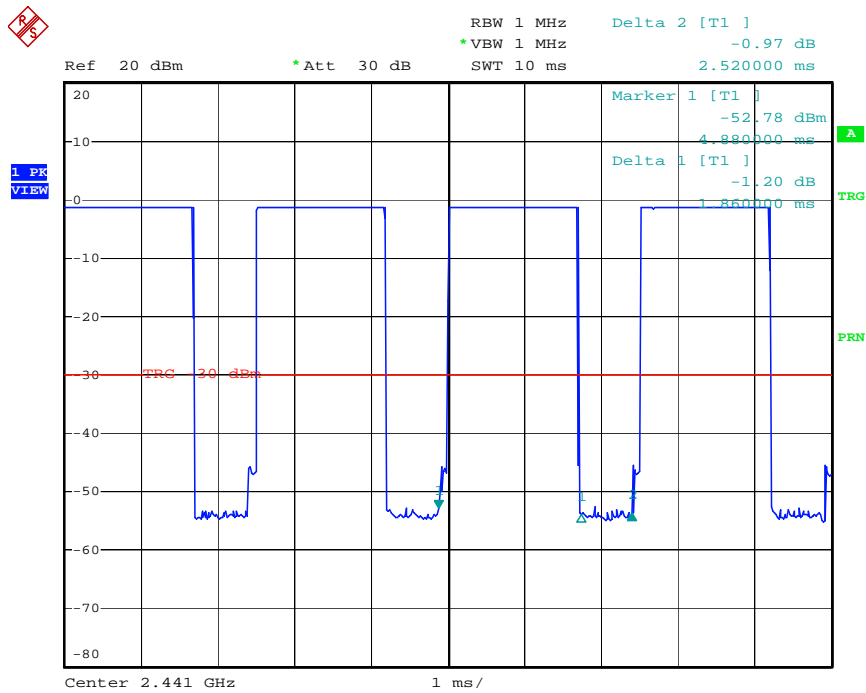

Date: 18.OCT.2005 17:28:12

DH1 Dwell Time Plot on Channel 39 / 2441 MHz

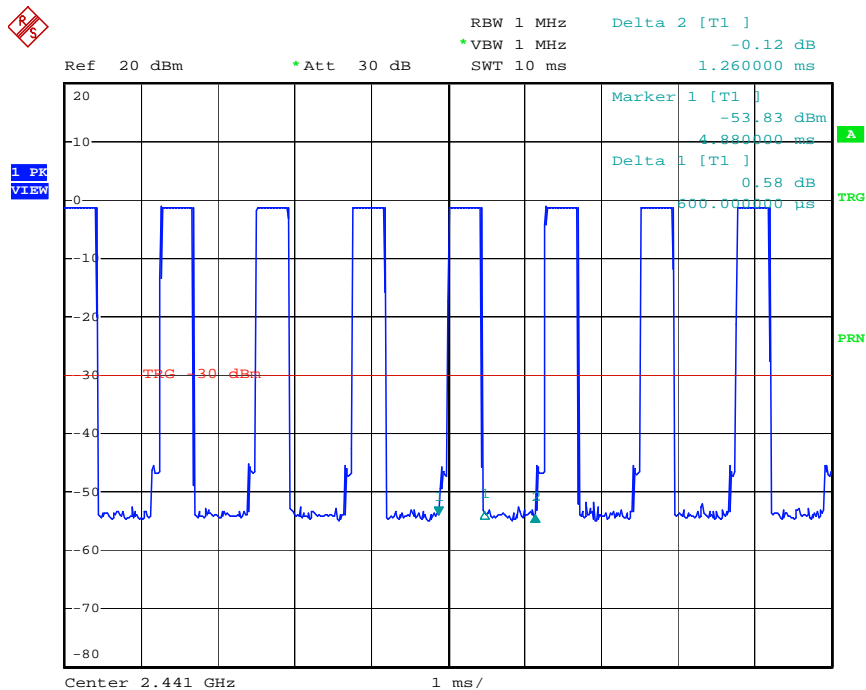

Date: 18.OCT.2005 17:27:34

DH5 Dwell Time Plot on Channel 78 / 2480 MHz

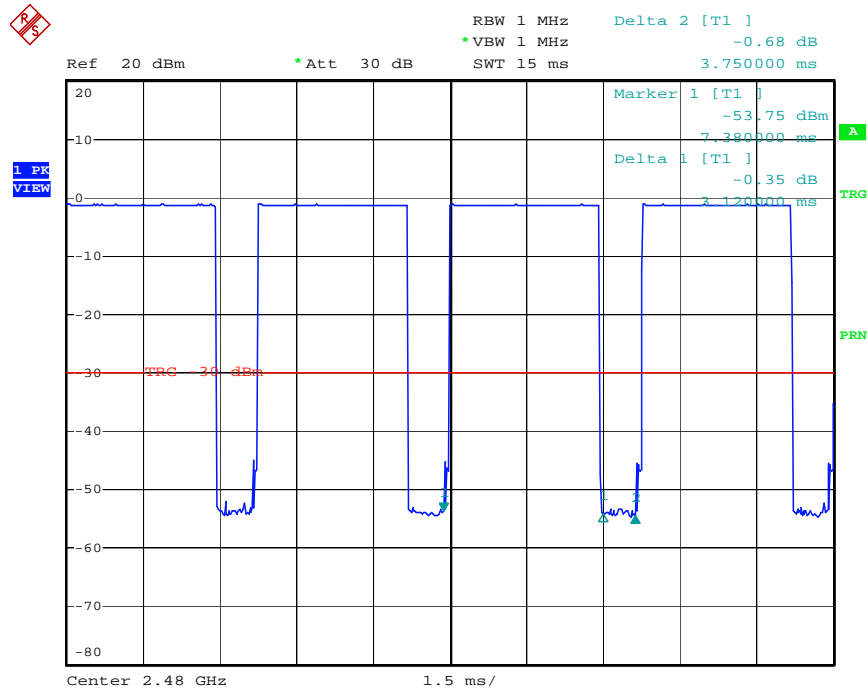

Date: 18.OCT.2005 17:31:24

DH3 Dwell Time Plot on Channel 78 / 2480 MHz

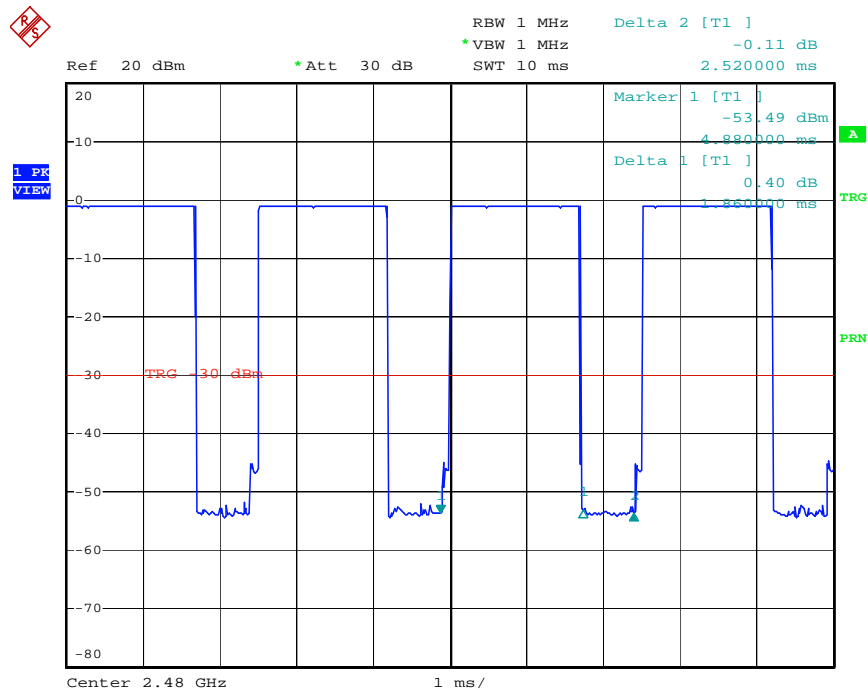

Date: 18.OCT.2005 17:30:42

DH1 Dwell Time Plot on Channel 78 / 2480 MHz

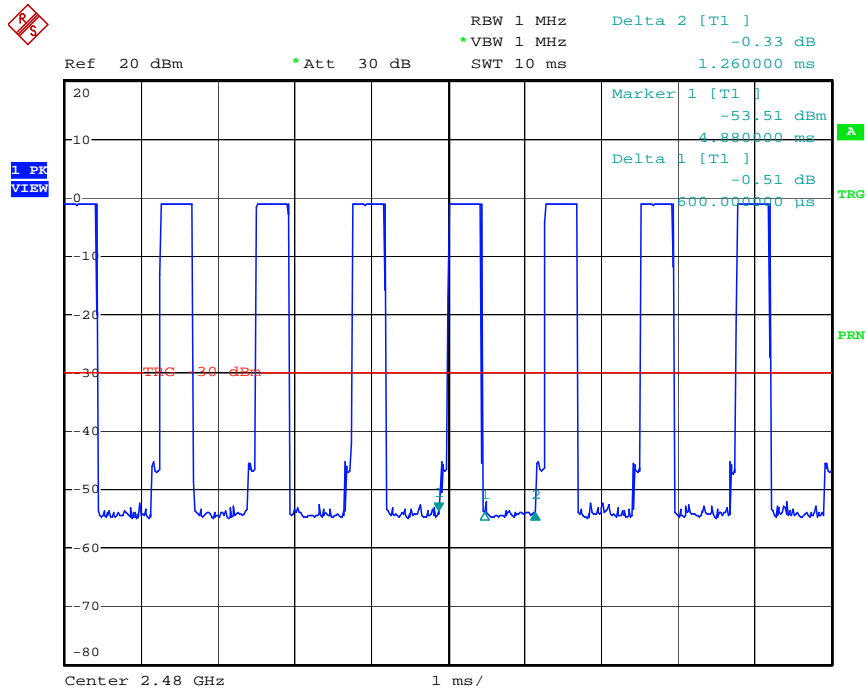

Date: 18.OCT.2005 17:29:54

4.6. Radiated Emissions Measurement

4.6.1. Limit

20dBc in any 100 kHz bandwidth outside the operating frequency band. In case the emission fall within the restricted band specified on 15.205(a), then the 15.209(a) limit in the table below has to be followed.

Frequencies (MHz)	Field Strength (micorvolts/meter)	Measurement Distance (meters)
0.009~0.490	2400/F(KHz)	300
0.490~1.705	24000/F(KHz)	30
1.705~30.0	30	30
30~88	100	3
88~216	150	3
216~960	200	3
Above 960	500	3

4.6.2. Measuring Instruments and Setting

Please refer to section 5 in this report. The following table is the setting of spectrum analyzer and receiver.

Spectrum Parameter	Setting
Attenuation	Auto
Start Frequency	1000 MHz
Stop Frequency	10th carrier harmonic
RB / VB (emission in restricted band)	1MHz / 1MHz for Peak, 1 MHz / 10Hz for Average
RB / VB (other emission)	100KHz / 100KHz for peak

Receiver Parameter	Setting
Attenuation	Auto
Start ~ Stop Frequency	9kHz~150kHz / RB 200Hz for QP
Start ~ Stop Frequency	150kHz~30MHz / RB 9kHz for QP
Start ~ Stop Frequency	30MHz~1000MHz / RB 120kHz for QP

4.6.3. Test Procedures

1. Configure the EUT according to ANSI C63.4. The EUT was placed on the top of the turntable 0.8 meter above ground. The phase center of the receiving antenna mounted on the top of a height-variable antenna tower was placed 3 meters far away from the turntable.
2. Power on the EUT and all the supporting units. The turntable was rotated by 360 degrees to determine the position of the highest radiation.
3. The height of the broadband receiving antenna was varied between one meter and four meters above ground to find the maximum emissions field strength of both horizontal and vertical polarization.
4. For each suspected emissions, the antenna tower was scan (from 1 M to 4 M) and then the turntable was rotated (from 0 degree to 360 degrees) to find the maximum reading.
5. Set the test-receiver system to Peak or CISPR quasi-peak Detect Function with specified bandwidth under Maximum Hold Mode.
6. For emissions above 1GHz, use 1MHz VBW and RBW for peak reading. Then 1MHz RBW and 10Hz VBW for average reading in spectrum analyzer.
7. When the radiated emissions limits are expressed in terms of the average value of the emissions, and pulsed operation is employed, the measurement field strength shall be determined by averaging over one complete pulse train, including blanking intervals, as long as the pulse train does not exceed 0.1 seconds. As an alternative (provided the transmitter operates for longer than 0.1 seconds) or in cases where the pulse train exceeds 0.1 seconds, the measured field strength shall be determined from the average absolute voltage during a 0.1 second interval during which the field strength is at its maximum value.
8. If the emissions level of the EUT in peak mode was 3 dB lower than the average limit specified, then testing will be stopped and peak values of EUT will be reported, otherwise, the emissions which do not have 3 dB margin will be repeated one by one using the quasi-peak method for below 1GHz.
9. For testing above 1GHz, the emissions level of the EUT in peak mode was lower than average limit (that means the emissions level in peak mode also complies with the limit in average mode), then testing will be stopped and peak values of EUT will be reported, otherwise, the emissions will be measured in average mode again and reported.
10. In case the emission is lower than 30MHz, loop antenna has to be used for measurement and the recorded data should be QP measured by receiver. High – Low scan is not required in this case.

4.6.4. Test Setup Layout

For radiated emissions below 30MHz

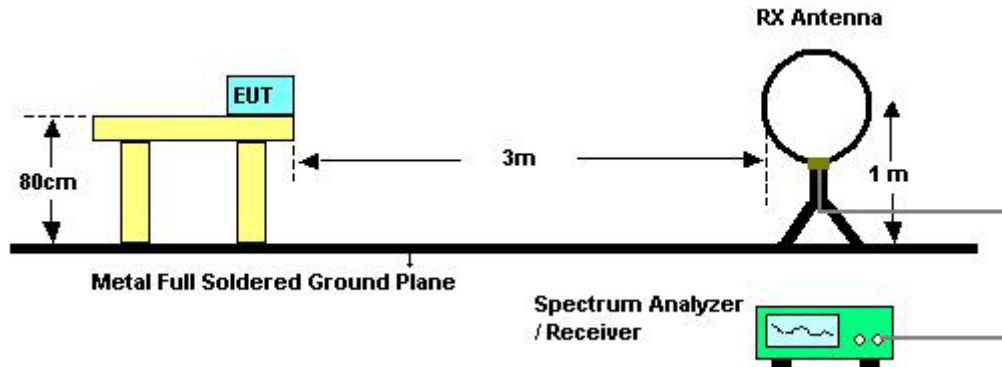

For radiated emissions above 30MHz

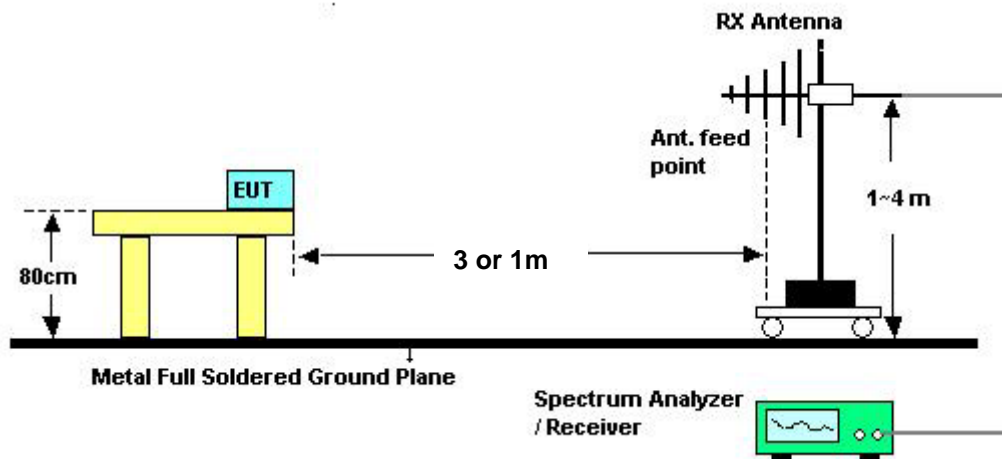

Above 10 GHz shall be extrapolated to the specified distance using an extrapolation factor of 20 dB/decade from 3m to 1m.

Distance extrapolation factor = $20 \log(\text{specific distance [3m]} / \text{test distance [1m]})$ (dB);

Limit line = specific limits (dBuV) + distance extrapolation factor [9.54 dB].

4.6.5. Test Deviation

There is no deviation with the original standard.

4.6.6. EUT Operation during Test

The EUT was programmed to be in continuously transmitting mode.

4.6.7. Results of Radiated Emissions (9kHz~30MHz)

Temperature	25°C	Humidity	54%
Test Engineer	Vic Xiao	Configurations	channel 39

Freq. (MHz)	Level (dBuV)	Over Limit (dB)	Limit Line (dBuV)	Remark
-	-	-	-	See Note

Note:

The amplitude of spurious emissions which are attenuated by more than 20 dB below the permissible value has no need to be reported.

Distance extrapolation factor = $40 \log(\text{specific distance} / \text{test distance})$ (dB);

Limit line = specific limits (dBuV) + distance extrapolation factor.

4.6.8. Results of Radiated Emissions (30MHz~1GHz)

Temperature	25°C	Humidity	54%
Test Engineer	Vic Xiao	Configurations	channel 39

Horizontal

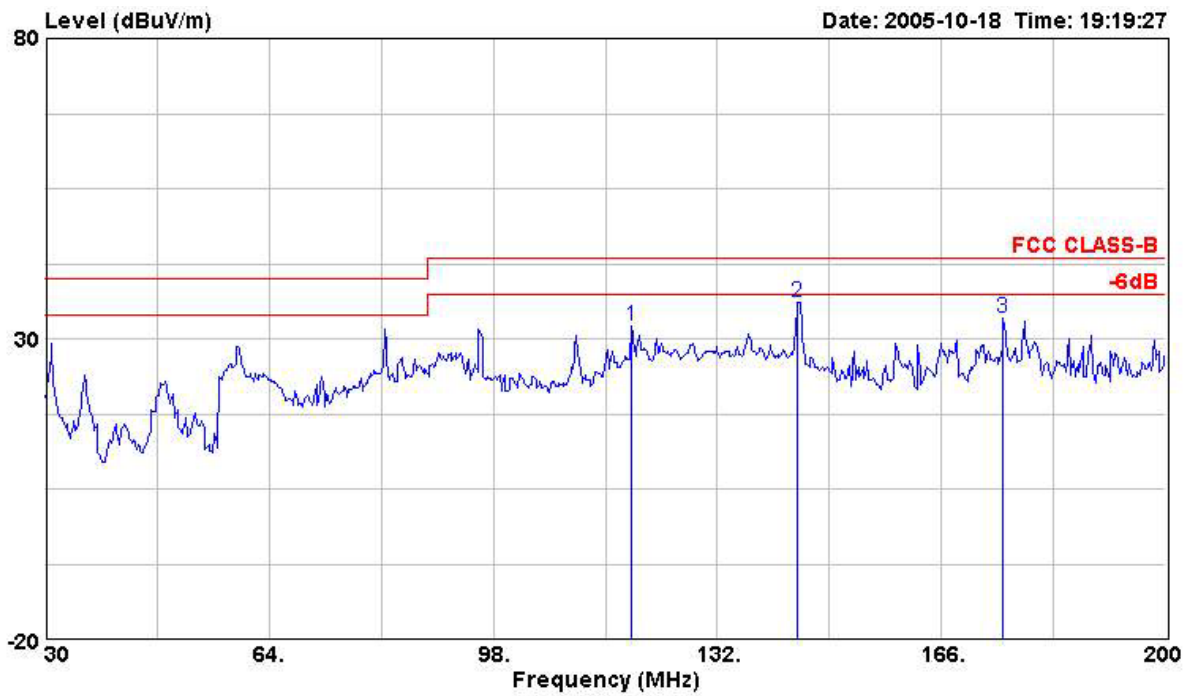

	Freq	Level	Over Limit	Read Level	Limit Line	Cable Loss	Antenna Factor	Preamp Factor	Remark	Table Pos	Ant Pos
	MHz	dBuV/m	dB	dBuV	dBuV/m	dB	dB/m	dB		deg	cm
1	118.910	32.04	-11.46	49.50	43.50	1.08	11.75	30.28	Peak	---	---
2	144.070	36.07	-7.43	53.21	43.50	1.18	12.31	30.64	Peak	---	---
3	175.350	33.44	-10.06	47.93	43.50	1.28	14.20	29.96	Peak	---	---

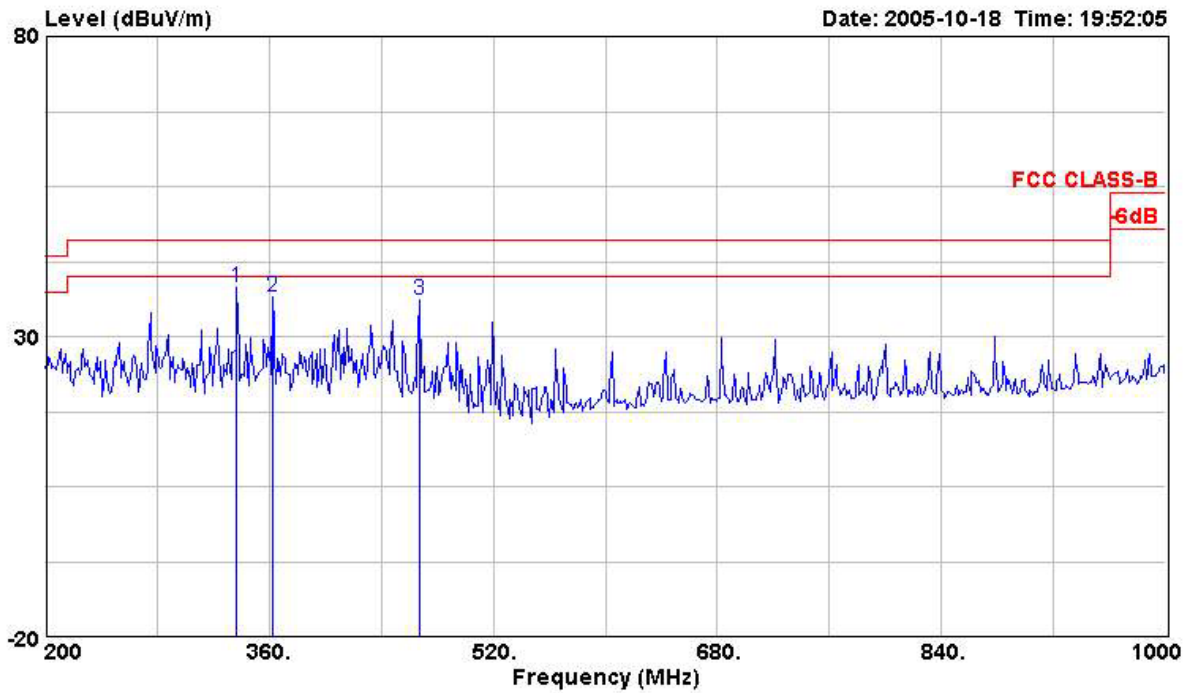

	Freq	Level	Over	Read	Limit	CableAntenna	Preamp	Remark	Table	Ant
	MHz	dBuV/m	dB	dBuV	dBuV/m	dB	dB/m	dB	deg	cm
1	336.800	38.14	-7.86	52.38	46.00	1.78	14.91	30.92	Peak	---
2	362.400	36.62	-9.38	49.87	46.00	1.82	15.67	30.74	Peak	---
3	467.200	36.09	-9.91	48.97	46.00	2.13	16.26	31.27	Peak	---

Vertical

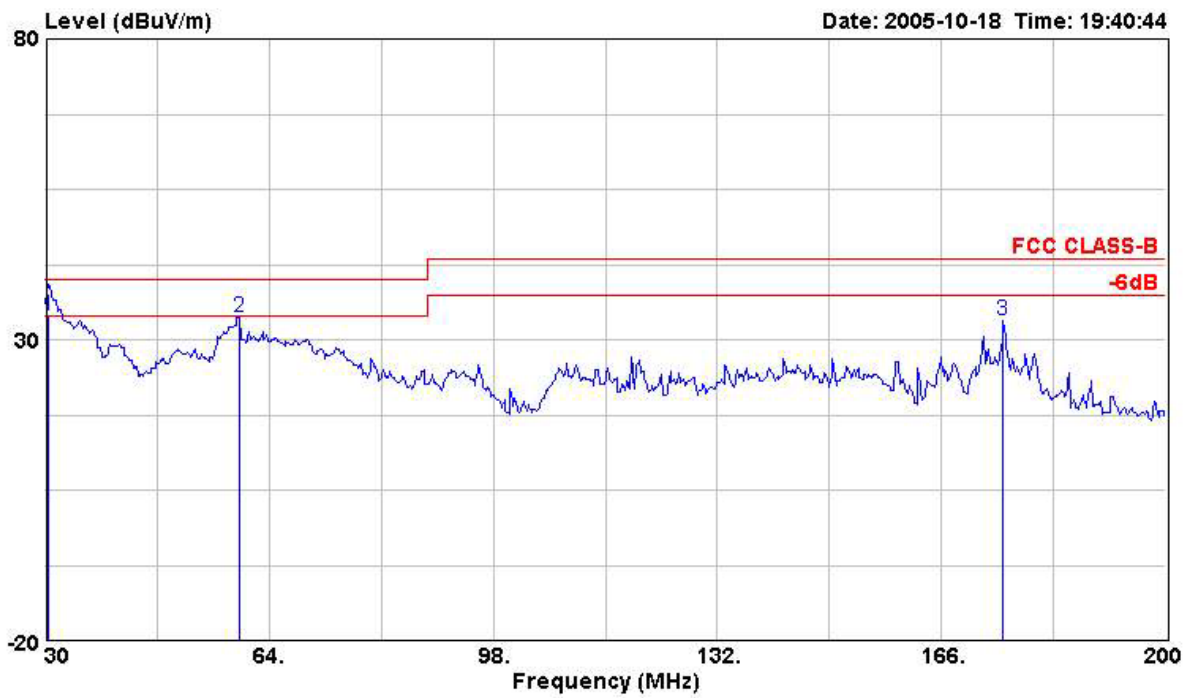

	Freq	Level	Over Limit	Read Level	Limit Line	Cable Loss	Antenna Factor	Preamp Factor	Remark	Table Pos	Ant Pos
	MHz	dBuV/m	dB	dBuV	dBuV/m	dB	dB/m	dB		deg	cm
1	30.510	34.07	-5.93	50.85	40.00	0.57	12.92	30.28	Average	---	---
2	59.580	33.71	-6.29	52.78	40.00	0.75	10.53	30.35	Peak	---	---
3	175.350	33.06	-10.44	47.55	43.50	1.28	14.20	29.96	Peak	---	---

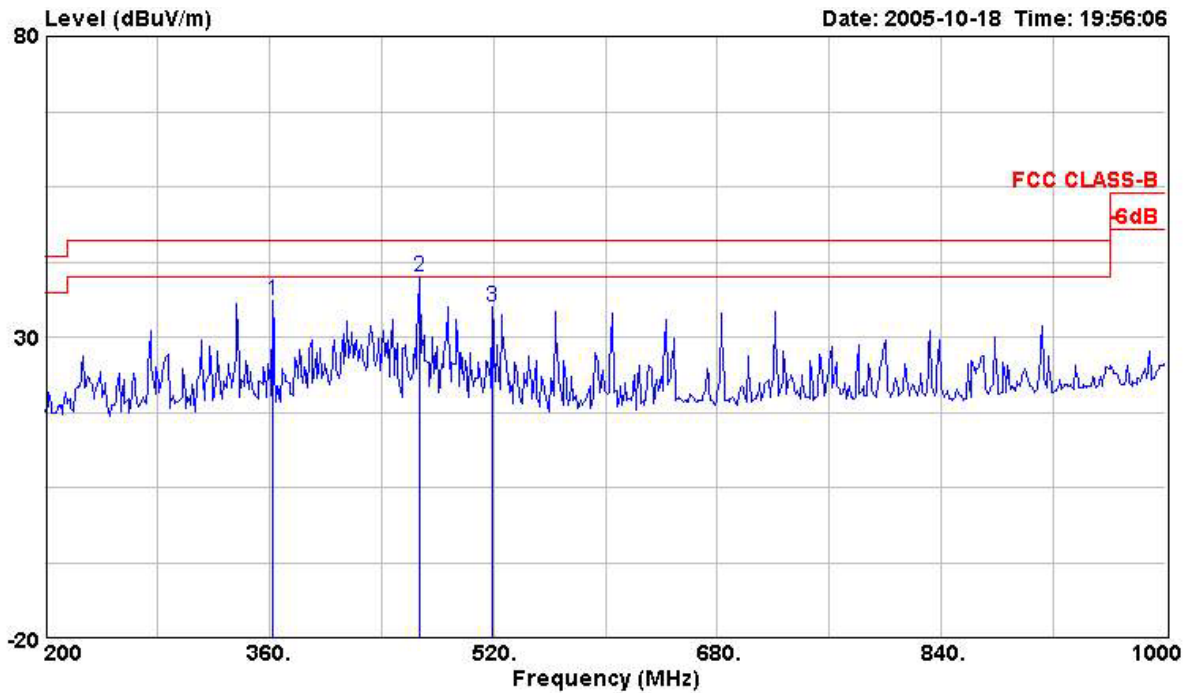

	Freq	Level	Over	Read	Limit	Cable	Antenna	Preamp	Remark	Table	Ant
	MHz	dBUV/m	Limit	Level	Line	Loss	Factor	Factor		Pos	Pos
			dB	dBuV	dBUV/m	dB	dB/m	dB		deg	cm
1	362.400	35.99	-10.01	49.24	46.00	1.82	15.67	30.74	Peak	---	---
2	467.200	39.90	-6.10	52.78	46.00	2.13	16.26	31.27	Peak	---	---
3	519.200	35.08	-10.92	46.88	46.00	2.20	16.87	30.87	Peak	---	---

Note:

The amplitude of spurious emissions which are attenuated by more than 20 dB below the permissible value has no need to be reported.

Emission level (dBUV/m) = 20 log Emission level (uV/m).

Corrected Reading: Antenna Factor + Cable Loss + Read Level - Preamp Factor = Level.

Pol. : V is Vertical Polarization ; H is Horizontal Polarization.

4.6.9. Results for Radiated Emissions (1GHz~10th Harmonic)

Temperature	25°C	Humidity	54%
Test Engineer	Vic Xiao	Configurations	channel 0

Horizontal

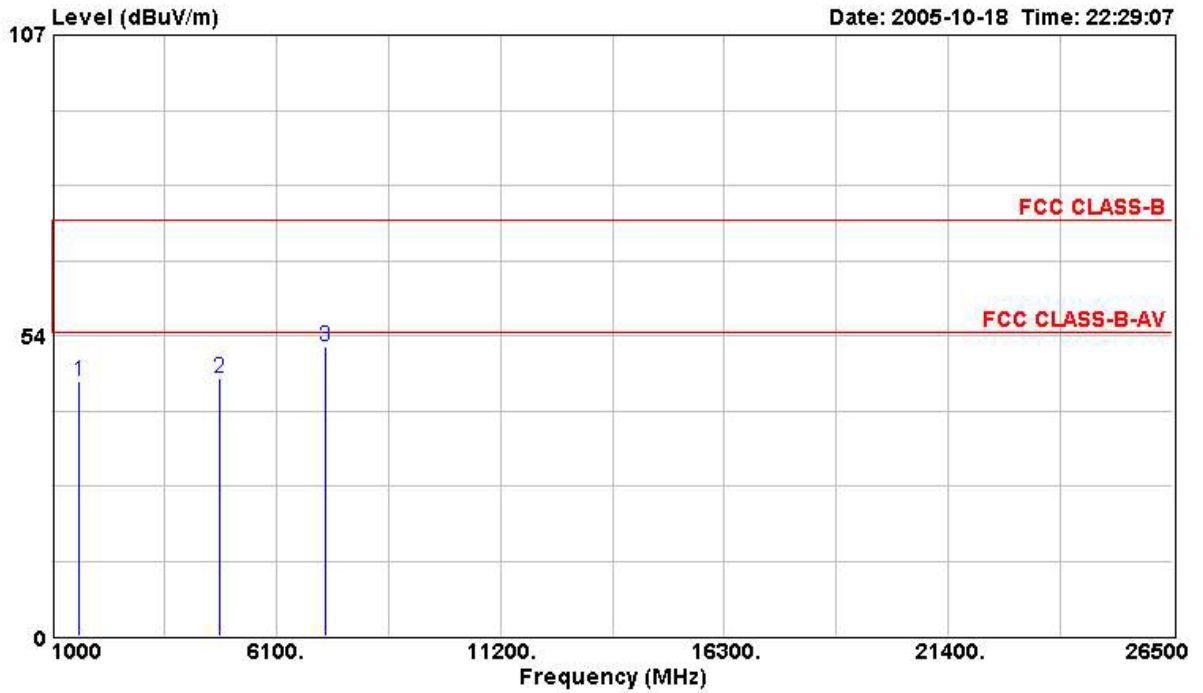

	Freq	Level	Over	Read	Limit	Cable	Antenna	Preamp	Remark	Table	Ant
	MHz	dBUV/m	Limit	Level	Line	Loss	Factor	Factor		Pos	Pos
			dB	dBuV	dBUV/m	dB	dB/m	dB		deg	cm
1	1596.000	45.27	-28.73	50.89	74.00	1.62	25.74	32.98	Peak	---	---
2	4804.000	45.88	-28.12	42.23	74.00	3.10	33.10	32.54	PEAK	---	---
3	7206.000	51.53	-22.47	43.89	74.00	4.10	35.90	32.35	PEAK	---	---

Vertical

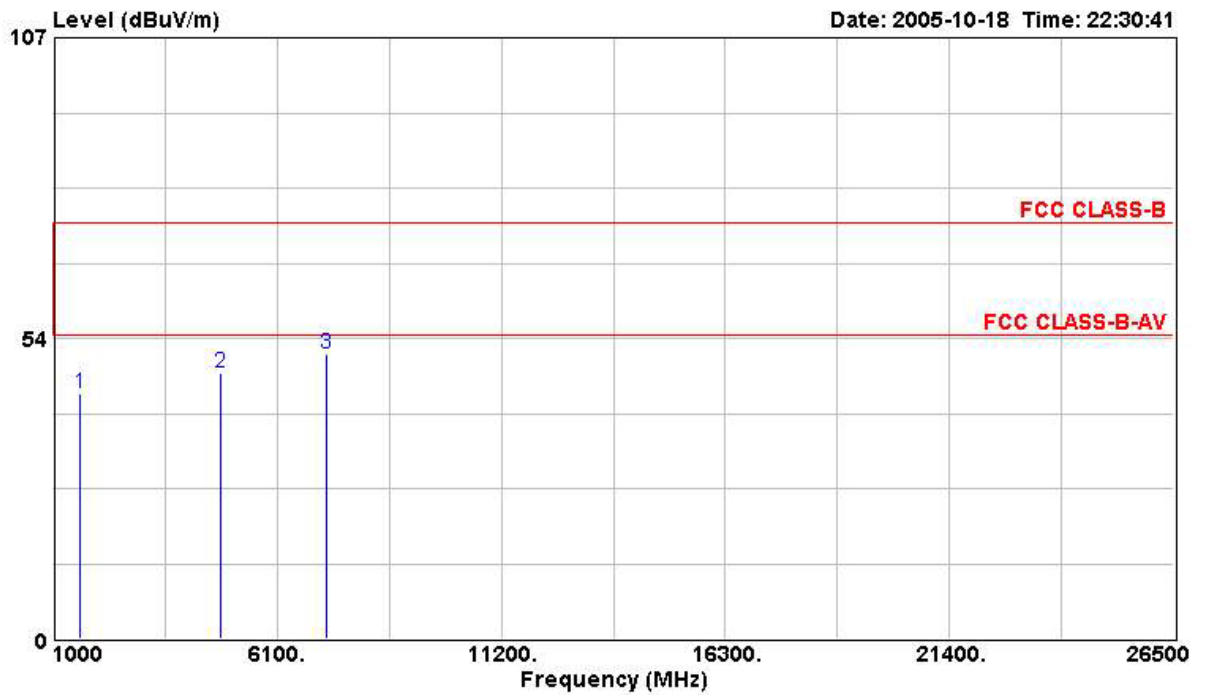

	Freq	Level	Over	Read	Limit	CableAntenna	Preamp	Remark	Table	Ant
	MHz	dBuV/m	Limit	Level	Line	Loss	Factor	Factor	Pos	Pos
			dB	dBuV	dBuV/m	dB	dB/m	dB	deg	cm
1	1596.000	43.53	-30.47	49.15	74.00	1.62	25.74	32.98	---	---
2	4804.000	47.40	-26.60	43.74	74.00	3.10	33.10	32.54	---	---
3	7206.000	50.69	-23.31	43.05	74.00	4.10	35.90	32.35	---	---

Temperature	25°C	Humidity	54%
Test Engineer	Vic Xiao	Configurations	channel 39

Horizontal

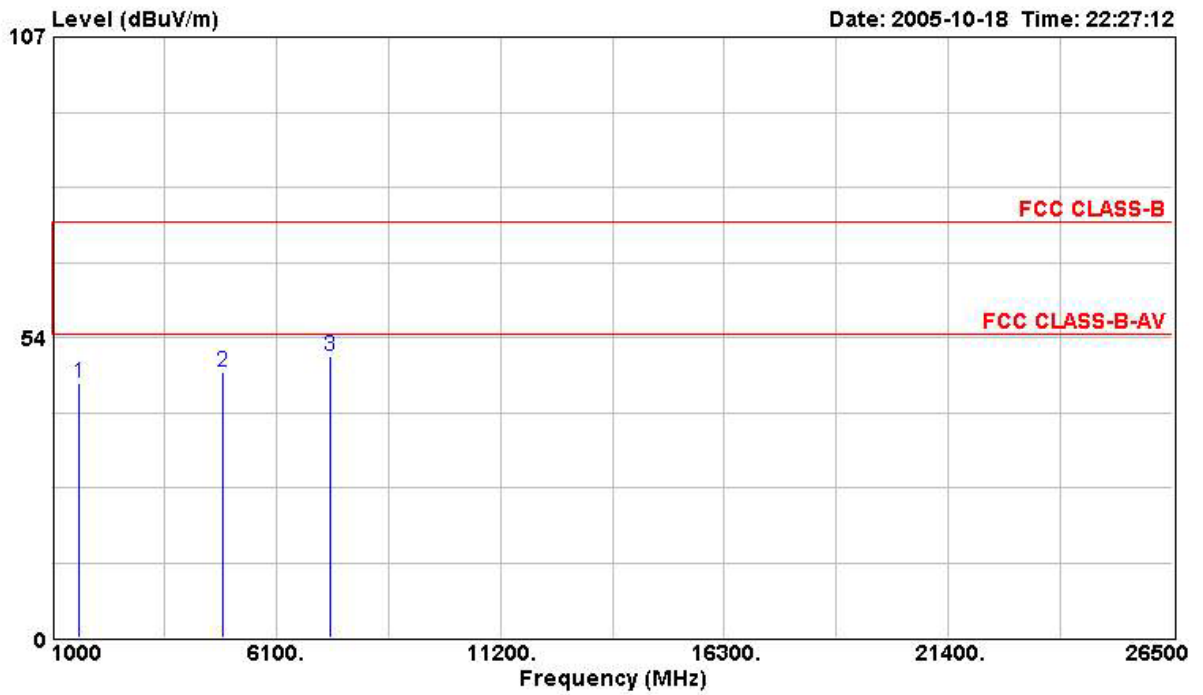

	Freq	Level	Over Limit	Read Level	Limit Line	Cable Loss	Antenna Factor	Preamp Factor	Remark	Table Pos	Ant Pos
	MHz	dBUV/m	dB	dBuV	dBUV/m	dB	dB/m	dB		deg	cm
1	1596.000	45.36	-28.64	50.98	74.00	1.62	25.74	32.98	Peak	---	---
2	4882.000	47.27	-26.73	43.49	74.00	3.11	33.21	32.55	PEAK	---	---
3	7323.000	50.04	-23.96	42.40	74.00	4.06	36.19	32.61	PEAK	---	---

Vertical

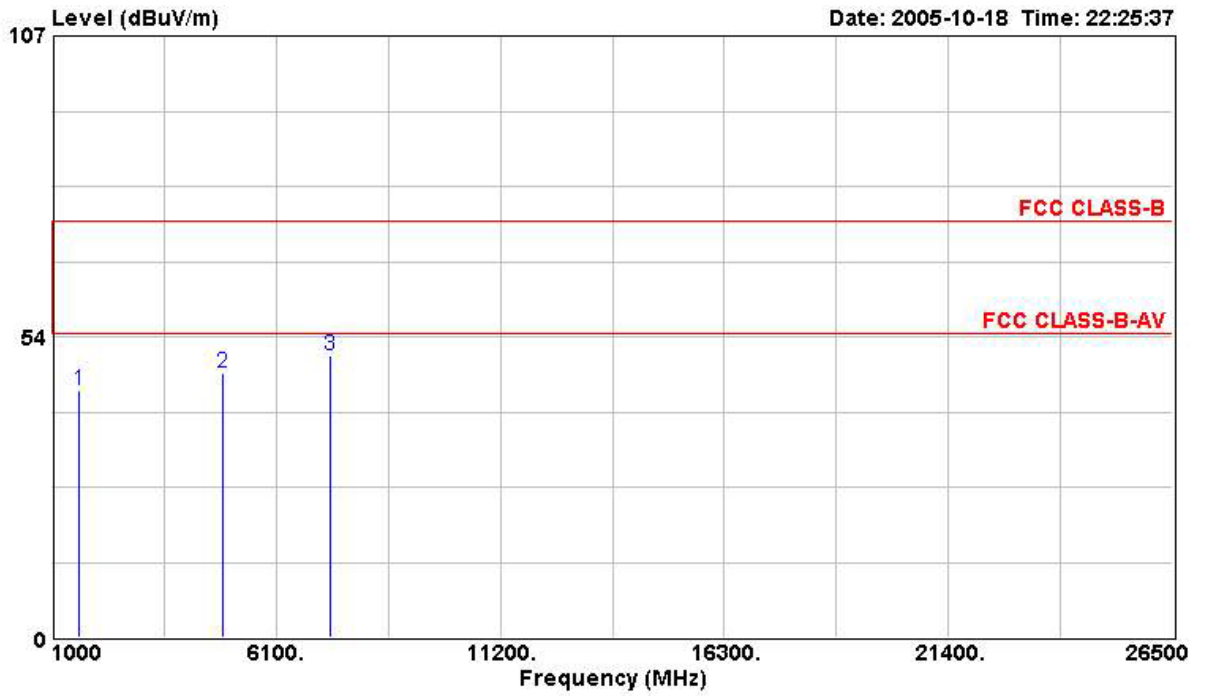

	Freq	Level	Over Limit	Read Level	Limit Line	CableAntenna Loss	Antenna Factor	Preamp Factor	Remark	Table Pos	Ant Pos
	MHz	dBUV/m	dB	dBuV	dBUV/m	dB	dB/m	dB		deg	cm
1	1596.000	44.06	-29.94	49.68	74.00	1.62	25.74	32.98	Peak	---	---
2	4882.000	46.95	-27.05	43.18	74.00	3.11	33.21	32.55	PEAK	---	---
3	7323.000	50.03	-23.97	42.39	74.00	4.06	36.19	32.61	PEAK	---	---



Temperature	25°C	Humidity	54%
Test Engineer	Vic Xiao	Configurations	channel 78

Horizontal

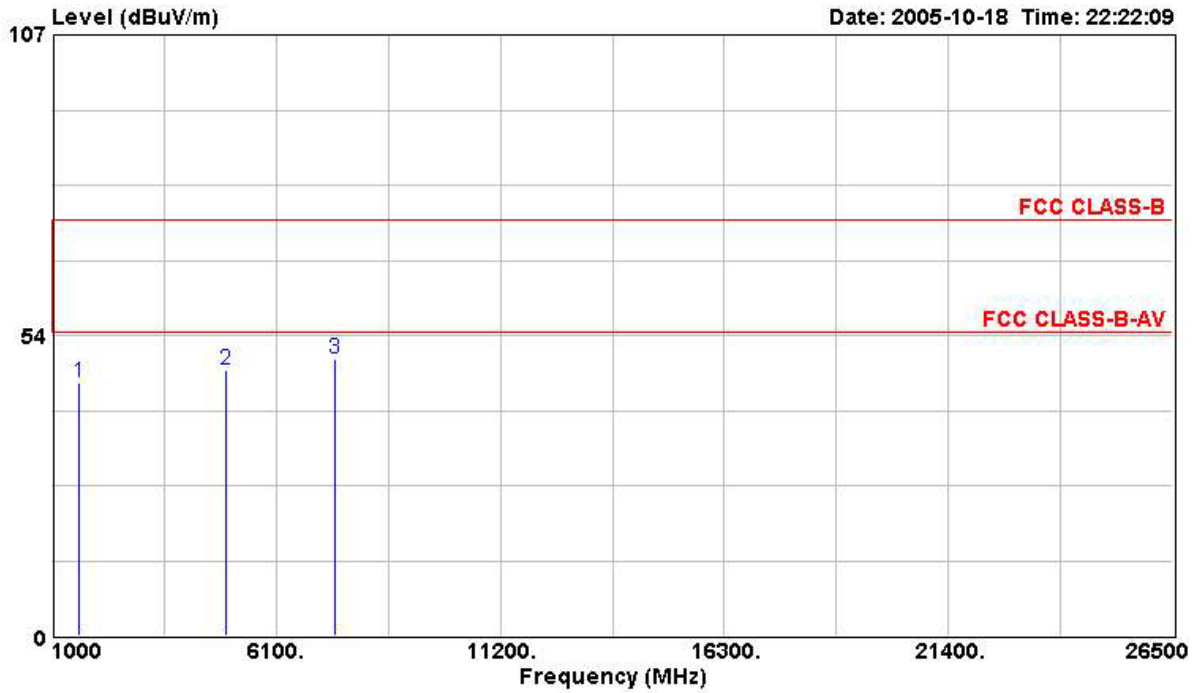

	Freq	Level	Over Limit	Read Level	Limit Line	Cable Loss	Antenna Factor	Preamp Factor	Remark	Table Pos	Ant Pos
	MHz	dBUV/m	dB	dBuV	dBUV/m	dB	dB/m	dB		deg	cm
1	1596.000	45.10	-28.90	50.72	74.00	1.62	25.74	32.98	Peak	---	---
2	4960.000	47.29	-26.71	43.36	74.00	3.13	33.34	32.56	PEAK	---	---
3	7440.000	49.18	-24.82	41.55	74.00	4.02	36.48	32.87	PEAK	---	---

Vertical

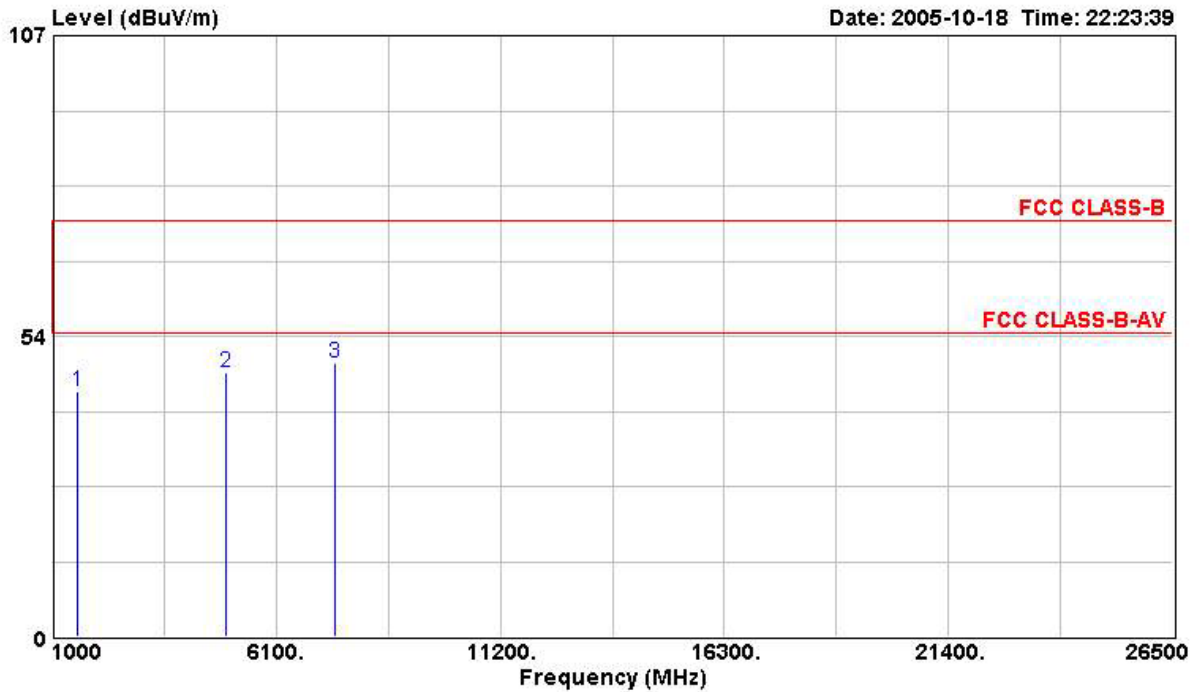

	Freq	Level	Over Limit	Read Level	Limit Line	Cable Loss	Antenna Factor	Preamp Factor	Remark	Table Pos	Ant Pos
	MHz	dBuV/m	dB	dBuV	dBuV/m	dB	dB/m	dB		deg	cm
1	1590.000	43.53	-30.47	49.15	74.00	1.62	25.74	32.98	Peak	---	---
2	4960.000	46.93	-27.07	43.00	74.00	3.13	33.34	32.56	PEAK	---	---
3	7440.000	48.79	-25.21	41.16	74.00	4.02	36.48	32.87	PEAK	---	---

Note:

The amplitude of spurious emissions which are attenuated by more than 20 dB below the permissible value has no need to be reported.

Emission level (dBUV/m) = 20 log Emission level (uV/m).

Corrected Reading: Antenna Factor + Cable Loss + Read Level - Preamp Factor = Level.

Pol. : V is Vertical Polarization ; H is Horizontal Polarization.

4.7. Band Edge Emissions Measurement

4.7.1. Limit

20dBc in any 100 kHz bandwidth outside the operating frequency band. In case the emission fall within the restricted band specified on 15.205(a), then the 15.209(a) limit in the table below has to be followed.

Frequencies (MHz)	Field Strength (micorvolts/meter)	Measurement Distance (meters)
0.009~0.490	2400/F(KHz)	300
0.490~1.705	24000/F(KHz)	30
1.705~30.0	30	30
30~88	100	3
88~216	150	3
216~960	200	3
Above 960	500	3

4.7.2. Measuring Instruments and Setting

Please refer to section 5 in this report. The following table is the setting of the spectrum analyzer.

Spectrum Parameter	Setting
Attenuation	Auto
Span Frequency	100 MHz
RB / VB (emission in restricted band)	1MHz / 1MHz for Peak, 1 MHz / 10Hz for Average
RB / VB (other emission)	100 KHz /100 KHz for Peak

4.7.3. Test Procedures

1. The test procedure is the same as section 4.5.3, only the frequency range investigated is limited to 100MHz around bandedges.
2. In case the emission is fail due to the used RB/VB is too wide, marker-delta method of FCC Public Notice DA00-705 will be followed.

4.7.4. Test Setup Layout

This test setup layout is the same as that shown in section 4.6.4.

4.7.5. Test Deviation

There is no deviation with the original standard.

4.7.6. EUT Operation during Test

The EUT was programmed to be in continuously transmitting mode.

4.7.7. Test Result of Band Edge Emissions

For Emission in Restricted Band

Temperature	25°C	Humidity	54%
Test Engineer	Vic Xiao	Configurations	channel 0

Freq	Level	Over Limit	Read Level	Limit Line	CableAntenna Loss	Antenna Factor	Preamp Factor	Remark	Table Pos	Ant Pos
MHz	dBuV/m	dB	dBuV	dBuV/m	dB	dB/m	dB		deg	cm
2390.000	45.93	-8.07	15.44	54.00	2.28	28.21	0.00	Average	---	---
2390.000	54.31	-19.69	23.82	74.00	2.28	28.21	0.00	Peak	---	---

Temperature	25°C	Humidity	54%
Test Engineer	Vic Xiao	Configurations	channel 78

Freq	Level	Over Limit	Read Level	Limit Line	CableAntenna Loss	Antenna Factor	Preamp Factor	Remark	Table Pos	Ant Pos
MHz	dBuV/m	dB	dBuV	dBuV/m	dB	dB/m	dB		deg	cm
2483.500	55.22	-18.78	24.51	74.00	2.34	28.37	0.00	Peak	---	---
2483.500	46.84	-7.16	16.13	54.00	2.34	28.37	0.00	Average	---	---

Note:

Emission level (dBuV/m) = 20 log Emission level (uV/m).

Corrected Reading: Antenna Factor + Cable Loss + Read Level - Preamp Factor = Level.

Receiving maximum band edge emissions are Vertical Polarization.

For Emission not in Restricted Band

Low Band Edge Plot on Channel 0 / 2402 MHz

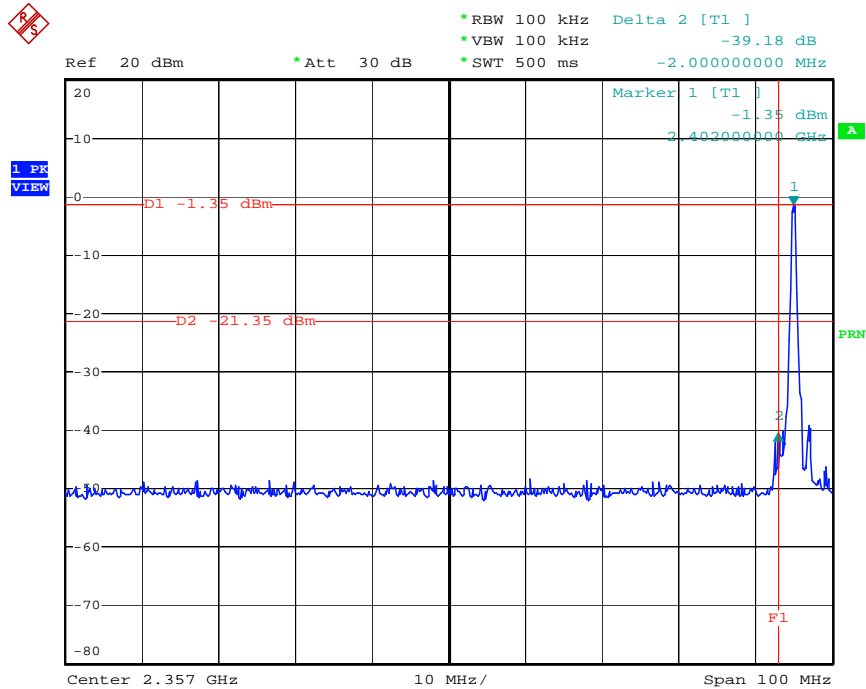

Date: 18.OCT.2005 17:13:58

High Band Edge Plot on Channel 78 / 2480 MHz

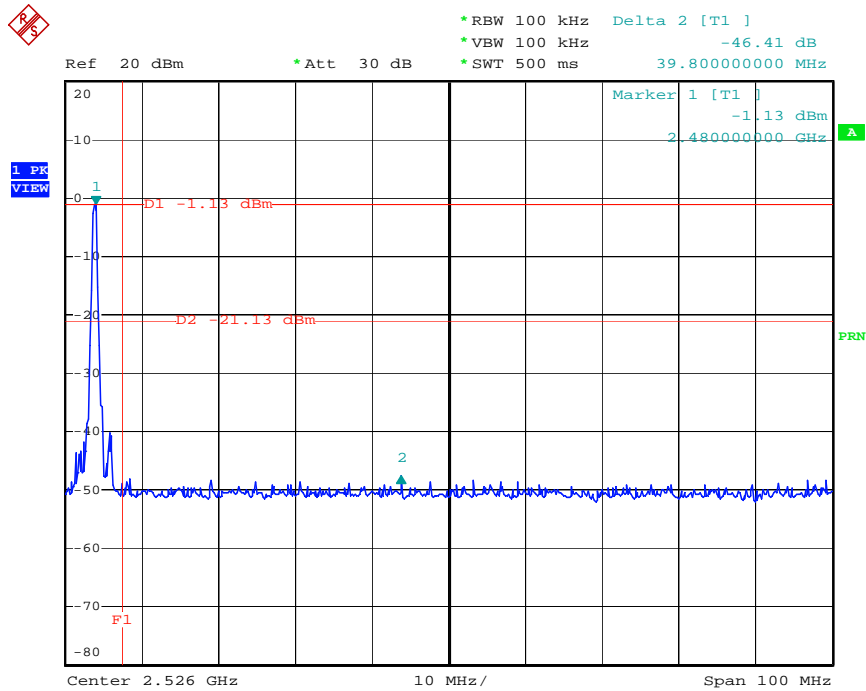

Date: 18.OCT.2005 17:09:26

4.8. Antenna Requirements

4.8.1. Limit

Except for special regulations, the Low-power Radio-frequency Devices must not be equipped with any jacket for installing an antenna with extension cable. An intentional radiator shall be designed to ensure that no antenna other than that furnished by the responsible party shall be used with the device. The use of a permanently attached antenna or of an antenna that uses a unique coupling to the intentional radiator shall be considered sufficient to comply with the provisions of this Section. The manufacturer may design the unit so that the user can replace a broken antenna, but the use of a standard antenna jack or electrical connector is prohibited. Further, this requirement does not apply to intentional radiators that must be professionally installed.

4.8.2. Antenna Connector Construction

Please refer to section 3.3 in this test report, all antenna connectors comply with the requirements.

5. LIST OF MEASURING EQUIPMENTS

Instrument	Manufacturer	Model No.	Serial No.	Characteristics	Calibration Date	Remark
EMC Receiver	R&S	ESCS 30	100174	9kHz – 2.75GHz	Feb. 16, 2005	Conduction (CO04-HY)
LISN	MessTec	NNB-2/16Z	2001/009	9kHz – 30MHz	Apr. 26, 2005	Conduction (CO04-HY)
LISN (Support Unit)	EMCO	3810/2NM	9708-1839	9kHz – 30MHz	Mar. 14, 2005	Conduction (CO04-HY)
RF Cable-CON	UTIFLEX	3102-26886-4	CB049	9kHz – 30MHz	Apr. 20, 2005	Conduction (CO04-HY)
EMI Filter	LINDGREN	LRE-2030	2651	< 450 Hz	N/A	Conduction (CO04-HY)
3m Semi Anechoic Chamber	SIDT FRANKONIA	SAC-3M	03CH03-HY	30 MHz - 1 GHz 3m	Jun. 16, 2005	Radiation (03CH03-HY)
Amplifier	SCHAFFNER	CPA9231A	18667	9 kHz - 2 GHz	Jan. 10, 2005	Radiation (03CH03-HY)
Amplifier	Agilent	8449B	3008A02120	1 GHz - 26.5 GHz	May 31, 2005	Radiation (03CH03-HY)
Amplifier	MITEQ	AMF-6F-260400	923364	26.5 GHz - 40 GHz	Jan. 05, 2004*	Radiation (03CH03-HY)
Spectrum Analyzer	R&S	FSP40	100004/040	9 kHz - 40 GHz	Sep. 30, 2005	Radiation (03CH03-HY)
Loop Antenna	R&S	HFH2-Z2	860004/001	9 kHz - 30 MHz	May 24, 2004*	Radiation (03CH03-HY)
Biconical Antenna	SCHWARZBECK	VHBB 9124	301	30 MHz - 200 MHz	Jul. 22, 2005	Radiation (03CH03-HY)
Log Antenna	SCHWARZBECK	VUSLP 9111	221	200 MHz - 1 GHz	Jul. 22, 2005	Radiation (03CH03-HY)
Horn Antenna	EMCO	3115	6741	1 GHz - 18 GHz	Apr. 22, 2005	Radiation (03CH03-HY)
Horn Antenna	SCHWARZBECK	BBHA9170	BBHA9170154	15 GHz - 40 GHz	Jun. 09, 2004*	Radiation (03CH03-HY)
RF Cable-R03m	Jye Bao	RG142	CB021	30 MHz - 1 GHz	Feb. 22, 2005	Radiation (03CH03-HY)
RF Cable-HIGH	SUHNER	SUCOFLEX 106	03CH03-HY	1 GHz - 40 GHz	Dec.01, 2005	Radiation (03CH03-HY)
Turn Table	HD	DS 420	420/650/00	0 - 360 degree	N/A	Radiation (03CH03-HY)
Antenna Mast	HD	MA 240	240/560/00	1 m - 4 m	N/A	Radiation (03CH03-HY)
Spectrum analyzer	R&S	FSP40	100116	9kHz ~ 40GHz	Jan. 28, 2005	Conducted (TH01-HY)
Power meter	R&S	NRVS	100444	DC ~ 40GHz	Jul. 06, 2005	Conducted (TH01-HY)
Power sensor	R&S	NRV-Z55	100049	DC ~ 40GHz	Jul. 06, 2005	Conducted (TH01-HY)
Power Sensor	R&S	NRV-Z32	100057	30MHz ~ 6GHz	Apr. 28, 2005	Conducted (TH01-HY)
AC power source	HPC	HPA-500W	HPA-9100024	AC 0 ~ 300V	Apr. 21, 2005	Conducted (TH01-HY)
Temp. and Humidity Chamber	KSON	THS-C3L	612	N/A	Oct. 01, 2005	Conducted (TH01-HY)
RF CABLE-1m	Jye Bao	RG142	CB034-1m	20MHz ~ 7GHz	Jan. 01, 2005	Conducted (TH01-HY)



Instrument	Manufacturer	Model No.	Serial No.	Characteristics	Calibration Date	Remark
RF CABLE-2m	Jye Bao	RG142	CB035-2m	20MHz ~ 1GHz	Jan. 01, 2005	Conducted (TH01-HY)
Oscilloscope	Tektronix	TDS1012	CO38515	100MHz / 1GS/s	Apr. 15, 2005	Conducted (TH01-HY)
Data Generator	Tektronix	DG2030	063-2920-50	0.1Hz~400MHz	Jun. 02, 2005	Conducted (TH01-HY)

※ Calibration Interval of instruments listed above is one year.

* Calibration Interval of instruments listed above is two year.

6. SPORTON COMPANY PROFILE

SPORTON Lab. was established in 1986 with one shielded room: the first private EMI test facility, offering local manufacturers an alternative EMI test facility apart from ERSO. In 1988, one 3M and 10M/3M open area test site were setup and also obtained official accreditation from FCC, VCCI and NEMKO. In 1993, a Safety laboratory was founded and obtained accreditation from UL of USA, CSA of Canada and TUV (Rhineland & PS) of Germany. In 1995, one EMC lab, including EMI and EMS test facilities was setup. In 1997, SPORTON Group has provided financial expense to relocate the headquarter to Orient Scientific Park in Taipei Hsien to offer more comprehensive, more qualified and better service to local suppliers and manufactures. In 1999, Safety Group and Component Group were setup. In 2001, SPORTON has established 3M/10M chamber in Hwa Ya Technology Park.

6.1. Test Location

SHIJR	ADD : 6Fl., No. 106, Sec. 1, Shintai 5th Rd., Shijr City, Taipei, Taiwan 221, R.O.C. TEL : 02-2696-2468 FAX : 02-2696-2255
HWA YA	ADD : No. 52, Hwa Ya 1st Rd., Kwei-Shan Hsiang, Tao Yuan Hsien, Taiwan, R.O.C. TEL : 03-327-3456 FAX : 03-318-0055
LINKOU	ADD : No. 30-2, Dingfu Tsuen, Linkou Shiang, Taipei, Taiwan 244, R.O.C TEL : 02-2601-1640 FAX : 02-2601-1695
DUNGHU	ADD : No. 3, Lane 238, Kangle St., Neihu Chiu, Taipei, Taiwan 114, R.O.C. TEL : 02-2631-4739 FAX : 02-2631-9740
JUNGHE	ADD : 7Fl., No. 758, Jungjeng Rd., Junghe City, Taipei, Taiwan 235, R.O.C. TEL : 02-8227-2020 FAX : 02-8227-2626
NEIHU	ADD : 4Fl., No. 339, Hsin Hu 2 nd Rd., Taipei 114, Taiwan, R.O.C. TEL : 02-2794-8886 FAX : 02-2794-9777
JHUBEI	ADD : No.8, Lane 728, Bo-ai St., Jhubei City, Hsinchu County 302, Taiwan, R.O.C. TEL : 03-656-9065 FAX : 03-656-9085

7. CERTIFICATE OF NVLAP ACCREDITATION

United States Department of Commerce
National Institute of Standards and Technology

NVLAP[®]

Certificate of Accreditation

SPORTON INTERNATIONAL, INC.
TAIPEI HSIEN 221
TAIWAN

*is recognized by the National Voluntary Laboratory Accreditation Program
for satisfactory compliance with criteria set forth in NIST Handbook 150:2001,
all requirements of ISO/IEC 17025:1999, and relevant requirements of ISO 9002:1994.
Accreditation is awarded for specific services, listed on the Scope of Accreditation, for:*

ELECTROMAGNETIC COMPATIBILITY AND TELECOMMUNICATIONS

December 31, 2005
Effective through

For the National Institute of Standards and Technology
NVLAP Lab Code: 200079-0



ISO/IEC 17025:1999
ISO 9002:1994

DEPARTMENT OF COMMERCE
UNITED STATES OF AMERICA

NVLAP-01C (06-01)