

*V38r Rugged Handheld  
with Rugged Handheld 2003  
Operating System*



**Hardware Guide**

Copyright © 2005 by ViewSonic Corporation. All rights reserved.

ViewSonic and the three birds logo are registered trademarks of ViewSonic Corporation.

Intel XScale is a trademark or registered trademark of Intel Corporation or its subsidiaries in the United States and other countries. Bluetooth is a trademark owned by its proprietor and used by Intel Corporation under license.

Microsoft, Windows, the Microsoft Internet Explorer logo graphic, ActiveSync, PowerPoint, Outlook, DirectX, DirectSound, Pocket Word, MSN, Pocket Excel, Pocket Internet Explorer, Microsoft Exchange, and the Windows logo are either registered trademarks or trademarks of Microsoft Corporation in the United States and/or other countries. ClearVue is a trademark of the Westtek Corporation.

Corporate names and trademarks are the property of their respective companies.

Disclaimer: ViewSonic Corporation shall not be liable for technical or editorial errors or omissions contained herein; nor for incidental or consequential damages resulting from furnishing this material, or the performance or use of this product.

In the interest of continuing product improvement, ViewSonic Corporation reserves the right to change product specifications without notice. Information in this document may change without notice.

No part of this document may be copied, reproduced, or transmitted by any means, for any purpose without prior written permission from ViewSonic Corporation.

### For Your Records

<b>Model Name:</b>	<b>ViewSonic PPC V38r</b>
<b>Model Number:</b>	<b>VS10418</b>
<b>Document Number:</b>	<b>V38r_PPC_UG_ENG Rev. 1A 21-Jan-05</b>
<b>Serial Number:</b>	_____
<b>Purchase Date:</b>	_____

### Product disposal at end of product life

ViewSonic is concerned about the preservation of our environment. Please dispose of this product properly at the end of its useful life. Your local waste disposal company may provide information about proper disposal.

For Your Records .....	i
------------------------	---

## **Chapter 1: Introduction**

Package Contents .....	1
Optional Accessories .....	2
Features .....	2
Software Installed .....	3
Parts of the V38r .....	4
Front and Bottom Views .....	4
Back and Top Views .....	6
Side Views .....	8
Initial Setup .....	9
Battery & Power Properties .....	11
For More Information .....	14
Introducing the Stylus .....	15
Moving Windows .....	15
Calibrating the Touch Screen .....	16
Adjusting the Stylus Double-tap Rate .....	17
Using the Stylus .....	17

## **Chapter 2: Using your V38r**

Today Screen .....	18
Status Icons .....	19
Navigation Bar and Command Bar .....	20
Running Programs .....	21
Pop-up Menus .....	22
Notifications .....	23
Entering Information .....	23
Entering Text Using the Input Panel .....	24
Show/Hide the Input Panel .....	24
Block Recognizer .....	25
Soft Keyboard.....	26
Letter Recognizer .....	26
Transcriber .....	26
Writing on the Screen .....	27
Drawing on the Screen .....	30
Recording a Message .....	31
Recording Formats .....	32
Using My Text .....	33

## Chapter 3: Managing Your V38r

Managing Power .....	34
Smart Power Management .....	35
Smart Battery .....	35
Power Manager .....	35
Power-Saving Tips .....	36
Managing Memory .....	36
Storage and Program Memory .....	36
Memory Cards .....	37
SD Memory Capabilities .....	38
SDRAM Memory Allocation .....	38
Antenna Signal Properties .....	39
Finding and Organizing Information .....	39
Customizing Your V38r .....	41
Setting a Password .....	42
Adding or Removing Programs .....	42
Adding Programs .....	42
Removing Programs .....	43
Backing Up Data .....	43
Using Backup .....	44
Backing up data using Backup .....	44
Restoring data using Backup .....	45

## Chapter 4: Microsoft ActiveSync

Using Microsoft ActiveSync .....	46
Synchronizing Data .....	47
Connecting to Your PC .....	48
Connecting by USB Cable .....	48
Connecting by Infrared .....	48

## Chapter 5: Pocket Outlook

Scheduling Appointments/Meetings .....	49
Creating an Appointment .....	50
Using the Summary Screen .....	51
Creating Meeting Requests .....	51
Managing Contacts .....	52
Finding a Contact .....	54
Using the Summary Screen .....	55

Tasks: Keeping a To Do List .....	56
Creating a Task .....	57
Using the Summary Screen .....	58
Notes: Capturing Thoughts and Ideas .....	59
Creating a Note .....	59
Inbox: Sending and Receiving Email .....	60
Synchronizing Email Messages .....	60
Using the Message List .....	61
Managing Email Messages and Folders .....	64

## **Chapter 6: Companion Programs**

Pocket Word .....	65
Using Pocket Word .....	65
Tips for Working in Pocket Word .....	66
Pocket Excel .....	66
Tips for Working in Pocket Excel .....	67
Windows Media Player for Rugged Handheld .....	68
Microsoft Reader .....	69
Getting Books onto Your V38r .....	69
Using the Library .....	70
Reading a Book .....	71
Using Reader Features .....	72
Removing a Book .....	73
Other Programs .....	73

## **Chapter 7: Pocket Internet Explorer**

Using Pocket Internet Explorer .....	74
Viewing Mobile Favorites and Channels .....	75
Browsing the Internet .....	75
The Mobile Favorites Folder .....	76
Favorite Links .....	76
Mobile Favorites .....	76
Conserving Memory .....	77
Using AvantGo Channels .....	78

## Chapter 8: Getting Connected

Connecting to a Network or the Internet .....	79
Using an Infrared Connection .....	80
Sending Information .....	80
Receiving Information .....	80

## Chapter 9: Troubleshooting and Maintenance

Reset the V38r .....	81
Cold Reset .....	81
Warm Reset .....	81
Firmware Image Upgrade .....	81
Restoring Factory Defaults .....	82
Power Problems .....	83
Memory Problems .....	84
Screen Problems .....	86
V38r Connection Problems .....	87
USB Dock/Cradle Connection Problems .....	87
Infrared Connection Problems .....	87
Care and Maintenance .....	88
General Guidelines .....	88
Travel Guidelines .....	88
Customer Support .....	89

## Chapter 10: Appendix

Regulatory and Safety Information .....	90
Class B Regulations .....	90
European Regulatory Notice .....	91
Battery Replacement .....	91
About the AC Adapter .....	92
About Electrostatic Discharge .....	92
Electrostatic Discharge Warning .....	92
The Dock/Cradle .....	93
Commercially Available Accessories .....	94
External USB Keyboard and Mouse .....	94
Limited Warranty .....	95
Specifications .....	96

# Chapter 1: Introduction

Congratulations on purchasing the **ViewSonic V38r**. The **V38r** is a **Windows®** powered Rugged Handheld that enables you to keep your most important business and personal information up-to-date and close at hand. This chapter introduces you to the internal and external components of the V38r and gets the unit setup.

## Package Contents

When you unpack the contents of the V38r, verify that you have all of the items listed below.

- The **ViewSonic V38r** with attached front cover
- Quick Start Guide
- *V38r* battery
- AC power adapter
- USB cable
- Stylus (1)
- Stylus tether (1) detached
- Communication and power dongle with one USB-A mini and one USB-B ports and a serial (RS232) port with power input
- V38r Companion CD

Go to the Help and Support Center on your PC for details on using Microsoft software. **This manual only covers using the ViewSonic V38r hardware.**

## Optional Accessories

The following optional accessories are available from ViewSonic:

- Desktop cradle (also called dock) with battery charging and communication
- WLAN/Bluetooth (depending on model)
- Camera for snapshots (depending on model)
- Car adapter cradle
- Avalon RF
- RFID
- Extended battery with extended back cover
- AC power dongle
- Belt clip
- Hand strap
- Fingerprint sensor (depending on model)
- Flip cover

## Features

- V38r Rugged Handheld
- Dock/cradle connector for optional cradle for input devices
- Wireless 802.11g
- 1D CCD Bar-Code scanner
- Standard joy stick
- SD card slot for extended memory
- Rechargeable battery (Lithium Ion)
- Color display and touch screen
- Synchronize data between desktop/laptop computer and your V38r
- Microphone to record messages, internal speaker
- Fingerprint sensor (depending on model)



# Software Installed

The following software is already installed on the **V38r PPC 2003**:

- Internet Explorer
- Windows Explorer
- Media Player
- MS WordPad
- Solitaire
- Microsoft Inbox
- Microsoft ActiveSync\*
- Microsoft File Viewers
  - MS Excel Viewer
  - MS Image Viewer
  - MS PDF Viewer
  - MS PowerPoint Viewer
  - MS Word Viewer

Your company's software development department most likely already installed and set up all software necessary for your **V38r** to perform its designated function(s) in the field.

\* If you want to synchronize your **V38r** with your PC, download the latest **ActiveSync** from the Microsoft website to your PC. **ActiveSync** may be on a CD that came with your **V38r** depending on the model. For detailed instructions, look for the step in this guide to **Install MS ActiveSync on your PC**.

# Parts of the V38r

The illustrations on the next few pages introduce you to the various buttons, connectors, ports, and other features of your V38r.



Go to the Help and Support Center on your PC for details on using Microsoft software. **This manual only covers using the ViewSonic V38r hardware.**

## Front and Bottom Views

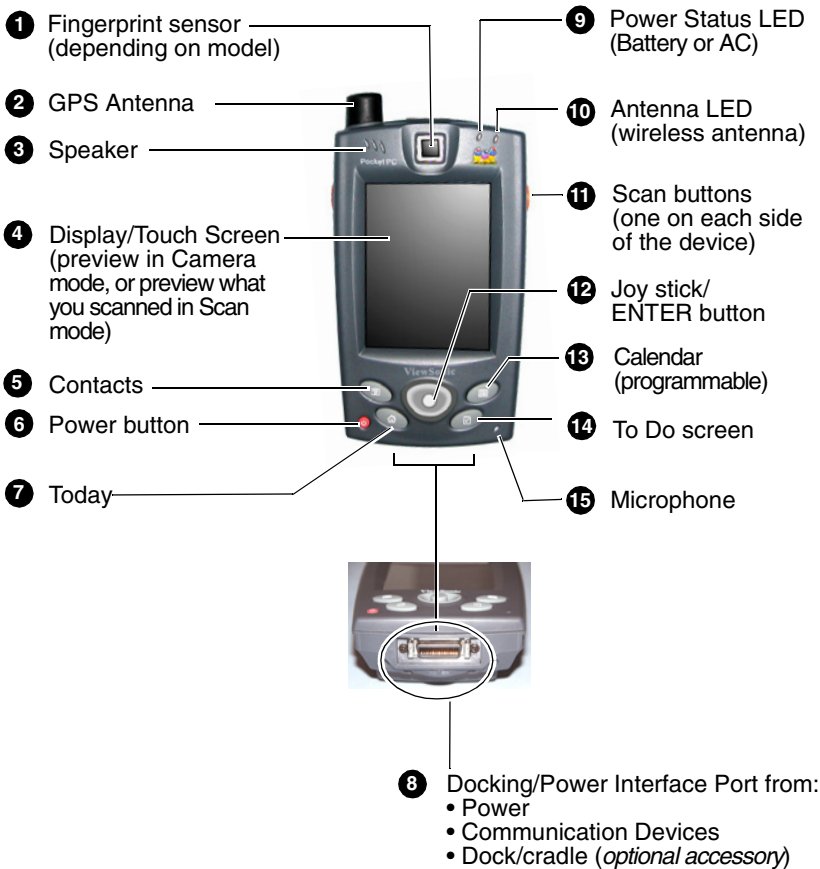

Ref	Part	Description
1	<b>Fingerprint sensor</b>	(programmable button) used for fingerprint recognition. Availability depends on model.
2	<b>Antenna</b>	GPS (Global Positioning System) antenna.
3	<b>Speaker</b>	Internal speaker sends out music or audible reminders and alerts.
4	<b>Display</b>	/Touch Screen (preview in Camera mode, or preview what you scanned in Scan mode)
5	<b>Contacts</b>	Keep track of your friends, family, colleagues, and associates with phone numbers, email addresses, etc.
6	<b>Power button</b>	Turns the V38r On or Off. When turned off, the unit is in suspend mode for up to 5 minutes while changing batteries.
7	<b>Today</b>	The main screen on the desktop. select something from the Today screen to add or change the details about tasks, etc.
8	<b>IN port</b>	(programmable button). Signal coming into the V38r from AC power source, communication devices, or the optional dock/cradle.
9	<b>Power Status LED</b>	Charging the battery and AC power.
10	<b>Antenna LED</b>	Wireless antenna LED.
11	<b>Scan button</b>	Bar Code Scan.
12	<b>Navigation</b>	Joy stick/ENTER button. Move up, down, left, or right in a document.
13	<b>Calendar</b>	(programmable button) a quick way to run the <b>Calendar</b> program. See the section in this guide on <b>Pocket Outlook</b> to schedule appointments, meetings, manage your <b>Contacts</b> list, keep a <b>To Do</b> list, make <b>Notes</b> .
14	<b>To Do</b>	Your <b>To Do</b> list.
15	<b>Microphone</b>	Records sound and/or voice messages. See the section in this guide on <b>Recording a Message</b> .

# Back and Top Views



<b>Ref</b>	<b>Feature</b>	<b>Description</b>
<b>1</b>	<b>Barcode scanner</b>	1 D CCD
<b>2</b>	<b>Stylus slot</b>	Store the stylus here.
<b>3</b>	<b>Camera shutter release or scan</b>	One of two buttons to take a picture or scan. Press both buttons at the same time - one on each side of the V38r.
<b>4</b>	<b>Back cover</b>	This example shows a flat back cover to cover a standard battery. The extended battery is bigger and has a bigger cover.
<b>5</b>	<b>1.3M camera</b>	CMOS camera. In camera mode, press the left and right "SCAN" buttons to snap pictures. Pictures can be viewed in portrait mode and saved to SD card.
<b>6</b>	<b>Camera shutter release or scan</b>	Take a picture or scan. Press the two buttons at the same time - one on each side of the V38r.
<b>7</b>	<b>Camera flash ON/OFF</b>	Turns camera flash on and off.
<b>8</b>	<b>Unlock icon</b>	Turn the release latch to the unlock icon to unlock the cover to the battery compartment.
<b>9</b>	<b>Release button for back cover</b>	Locks and unlocks back cover to the battery compartment.
<b>10</b>	<b>Lock icon</b>	Turn the release latch to the lock icon to lock the cover to the battery compartment.

## Side Views



Ref	Part	Description
1	<b>Camera shutter release or scan button</b>	In camera mode, press the left/right SCAN buttons to snap a picture and save the picture to an SD card.
2	<b>Camera shutter release or scan button</b>	In camera mode, press the left/right SCAN buttons to snap a picture and save the picture to an SD card.
3	<b>SD slot cover</b>	SD (Secure Digital) card slot for extended memory.
4	<b>Screw to release SD slot cover</b>	Releases cover to SD card slot.
5	<b>IrDA</b>	Infrared Communication.

# Initial Setup

Your V38r features powerful software and hardware allowing you to connect to your PC to view and edit files, wirelessly send/receive e-mail, and explore the World Wide Web. This section shows you how to get started.



Go to the Help and Support Center on your PC for details on using Microsoft software. **This manual only covers using the ViewSonic V38r hardware.**

## 1 Install the battery

If the battery is already in the V38r when you open the package, go to Step 2. If not, then remove the back cover by turning the latch counterclockwise as shown below. Slide the battery into the battery compartment lining up the pin connections. Replace the back cover and tighten the latch clockwise.



Unlock latch



Align the pin connections



Back cover for standard battery



Lock latch

## 2 Remove the front cover

Pinch and slide the cover off the front of the V38r as shown. The cover is attached, so just let it hang loose.



Two hands



One-handed:  
push up with thumb



## 3 Plug into AC power

**Caution:** Use only the cords that came with your V38r. Pinch the sides of the AC power dongle while plugging the dongle into the port on the bottom of the V38r as shown below. Attach the dongle to the AC power dongle and the AC power dongle into an AC power wall outlet.

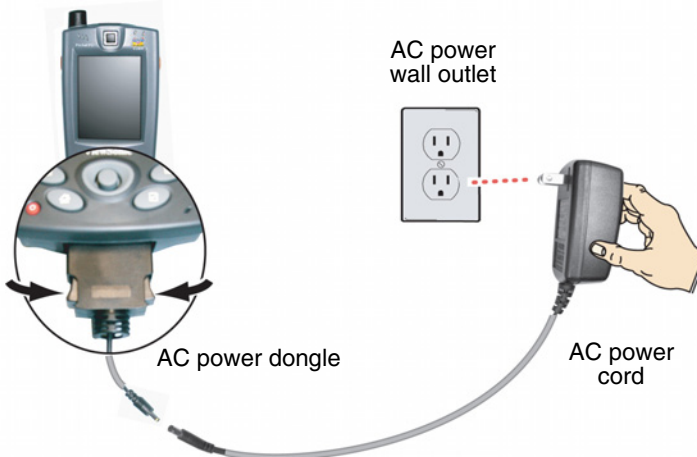



# Battery & Power Properties

Your *V38r* has three possible power sources, AC (using the AC power dongle or the optional dock/cradle) or battery. Only use the dongle(s) and/or cable(s) that came in the package.

**CAUTION:** Replace only with one of the following *V38r* series batteries:

Standard Battery part number: BAT-001

Extended Battery part number: BAT-002 (4 hours added life)



**Initial Charging:** Failure to fully charge the battery overnight before turning on the *V38r* for the first time may reduce the overall service life of the battery.

The *V38r* recharges in approximately two (2) to (3) three hours while not in use and four (4) hours while in use. Normally, *V38r* operates on battery power alone. A fully charged battery can last up to four (4) hours depending on power consumption factors such as the screen's brightness setting.

If the battery is left unattended too long, it may discharge completely. Complete discharge may damage the battery's ability to recharge properly.



**Storage:** If you are not using the *V38r* on a daily basis, store the unit by plugging it into an AC outlet

Remove the back cover by turning the latch counterclockwise then take the battery out. **CAUTION:** Removing the battery can cause the loss of content not saved in the Persistent Storage folder. Before removing the battery, we strongly recommend that you do one of the following:

- Drag any changed files you want to protect to the *V38r*'s Persistent Storage folder (under My Computer), then press the Power button (to turn the *V38r* off/Suspend Mode) before removing the old battery.

Or,

- Plug the AC Power Cord into the *V38r* before removing the old battery to prevent a disruptive interruption of power.

Or,

- Press the Power button to put the *V38r* in Suspend Mode, remove the old battery, and insert the replacement battery quickly. The *backup battery* (permanently installed) will prevent an interruption of power, providing a maximum of five (5) minutes of power while in Suspend Mode.

## 4 Charge the battery overnight

Before using the V38r for the first time, charging the battery overnight is best to ensure the battery is fully charged. After the battery is fully charged the first time, you can charge, recharge, and/or operate your V38r with available AC power using the AC power dongle.

## 5 Turn the power on

Press the **Power Button**. The **Power Status LED** turns green.

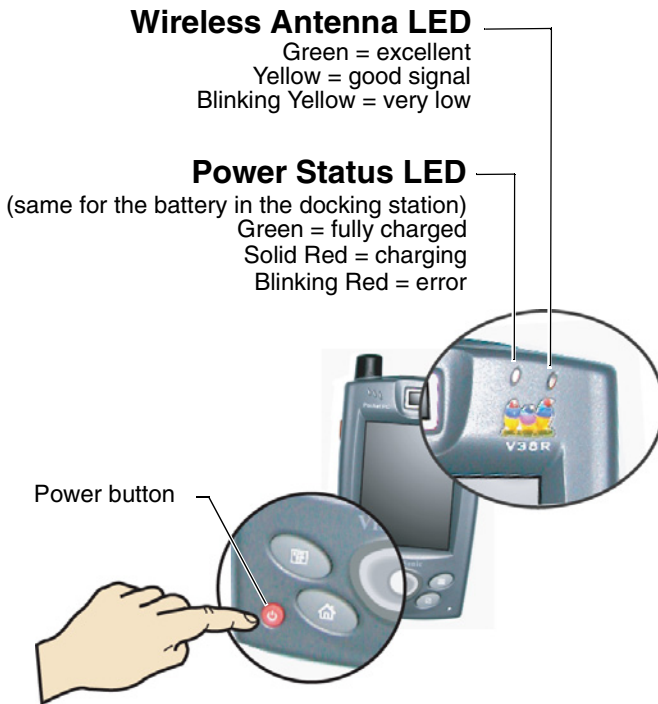

To determine the main battery's current charge level, double-tap the Power icon in the Control Panel window under My Computer. The Power Properties window opens to Battery Status. Battery Status displays the percentage of power left in your main battery and rates the quality of your external power connection and backup battery as either Good, Low, or Very Low.

## 6 Install MS ActiveSync on your PC

**Microsoft ActiveSync** enables you to synchronize and update the data between your PC and your **V38r**. **ActiveSync** is already installed on your **V38r** but needs to be installed on your PC.

**IMPORTANT:** Before installing **ActiveSync**, make sure Microsoft Outlook is installed on your PC. If not, you can install **Outlook 2002** from the provided **ViewSonic V38r Companion CD**.

- 1 Turn on your PC.
- 2 Insert the **Microsoft ActiveSync Utility CD** (depending on model) into the CD-ROM drive of your PC. Or download **ActiveSync** from the Microsoft website. The **ActiveSync** installation screen should open immediately. If not, double-click **Setup.exe** and go to Step 3.
- 3 Click the arrow on the first screen to enter the main screen. Click **Start Here**, then click **Install ActiveSync**. Click **Install** to start the installation.
- 4 When prompted, connect your V38r to your PC as shown below:
  - (1) Plug the dongle with the USB port into the V38r.
  - (2) Plug the USB cable into the USB port on the dongle.
  - (3) Connect the AC adapter to the power connector on the USB plug.
  - (4) Connect the USB cable to your PC. The **Found New Hardware Wizard** appears.

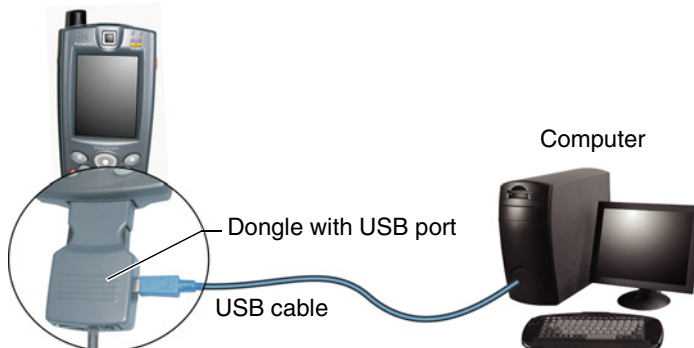

- 5 Follow the on-screen instructions to synchronize the **V38r** with your PC. After the first synchronization, the data you have stored on your PC, such as **Calendar**, **Contacts**, and **Tasks**, is copied to your **V38r**. You're now ready to take it along with you when you go. *For more information on **ActiveSync**, see the **MS ActiveSync** section in this guide.*

## For More Information

For information on:	See this source
Operating the <b>V38r</b>	<b>V38r Hardware Guide</b> (a PDF file on the <b>ViewSonic V38r Companion CD</b> .)
Programs on your <b>V38r</b>	<b>V38r Hardware Guide</b> and Help on your PC.
Additional programs that can be installed on your <b>V38r</b>	<b>ViewSonic V38r Companion CD</b>
Connecting to and synchronizing with a PC	<b>V38r Hardware Guide</b> or online Help. Tap <b>Help</b> on the <b>Start</b> menu to view Help.
ViewSonic Customer Support	Customer Support section in the <b>Appendix</b> of this guide
Troubleshooting	See the <b>Troubleshooting</b> chapter later in this guide
Last-minute updates and technical information	The <b>Read Me</b> files in the " <b>Microsoft ActiveSync</b> " folder on your PC or the <b>ViewSonic V38r Companion CD</b>
The latest on Windows Powered devices	The Microsoft Mobile Devices Web site: <a href="http://www.microsoft.com/mobile/">www.microsoft.com/mobile/</a>

# Introducing the Stylus

Use the stylus to “tap” or “double-tap” on an application icon and to select items on the menu. The stylus is also used to “type” on the Input Panel and to write notes when in handwriting recognition mode. The stylus that is supplied with your *V38r* is designed for your screen. Using other pointers could damage your screen and may void the warranty.



When not in use, you can conveniently place your stylus in the storage slot located on the top edge of your *V38r*. To keep from losing the stylus, attach the stylus tether that came in the package to the bracket on the back of the *V38r*.

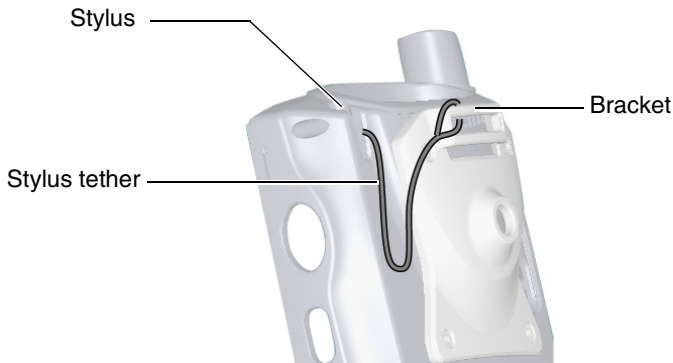

## Moving Windows

- 1 To move a window on the screen, press on the Window’s title-bar gently with the stylus.
- 2 Drag the window slowly to a new location.

## Calibrating the Touch Screen

If your touch screen is not responding accurately to taps with the stylus, you can recalibrate the screen as follows.

- 1 Tap **Windows Start**.
- 2 Tap the **Settings** button > **Control Panel** icon > **Stylus** > **Stylus Properties** > **Calibration** > **Recalibrate** (the crosshairs appear).
- 3 Follow the on-screen instructions to place the stylus on a cross-hair. Rather than just tapping the screen, hold the stylus in place for a second or two as directed until the program responds. Repeat this at each corner of the screen.
- 4 When finished, tap the screen. Re-calibration is complete.

## Adjusting the Stylus Double-tap Rate

The double-tap rate can also be adjusted in the **Settings** window:

- 1 Tap **Windows Start**.
- 2 Tap the **Settings** button > **Control Panel** icon > **Stylus** > **Stylus Properties** > double-tap on the checkerboard graphic to set your double tap rate.
- 3 Close the **Settings** window.
- 4 To save your settings, press the **Power** button which puts the **V38r** into Suspend mode. Wait momentarily. Press the **Power** button again and resume working.

## Using the Stylus

Use the stylus to navigate and select objects on the V38r touch-screen. You can extend the stylus to hold it more comfortably.

- **Tap:** Touch the screen once with the stylus to open items and select options.
- **Drag:** Hold the stylus on the screen and drag across the screen to select text and images. Drag in a list to select multiple items.
- **Press and hold:** Press and hold the stylus on an item to see a list of actions available for that item. On the pop-up menu that appears, tap the action you want to perform.



# Chapter 2: Using your V38r

This chapter introduces you to the basics of working with programs and documents on your **V38r**.

## Today Screen

When you turn on your **V38r** for the first time each day (or after four hours of inactivity), you will see the **Today** screen. On the **Today screen**, you can see at a glance important information for the day: current date, appointments, activities, new email, and create new documents.



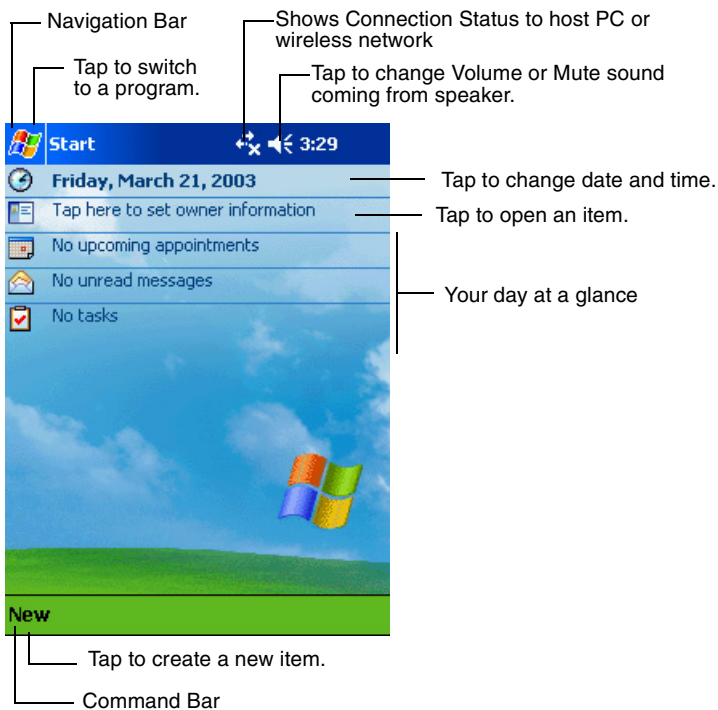





You can also display the **Today** screen by tapping  and then tapping **Today**.





## Status Icons

- When the Today screen is displayed, you may see the following status icons on the Command bar or Navigation bar. In most cases, you can tap a status icon to display the associated control panel or more information related to the item.
- For example, tap  to see information about the battery status.

Icon	Meaning
	Active Connection: there is an active connection to host PC or wireless network.
	Inactive Connection: there is not an active connection to host PC or wireless network.
	Speaker is On.
	Speaker is Off.
	Main battery is low.
	Main battery is very low.
	Main battery is fully charged.
	Synchronization is beginning or ending.

# Navigation Bar and Command Bar

The Navigation bar is located at the top of the screen. It displays the active program and current time, and allows you to switch programs and close screens.

The Navigation bar and Start menu:

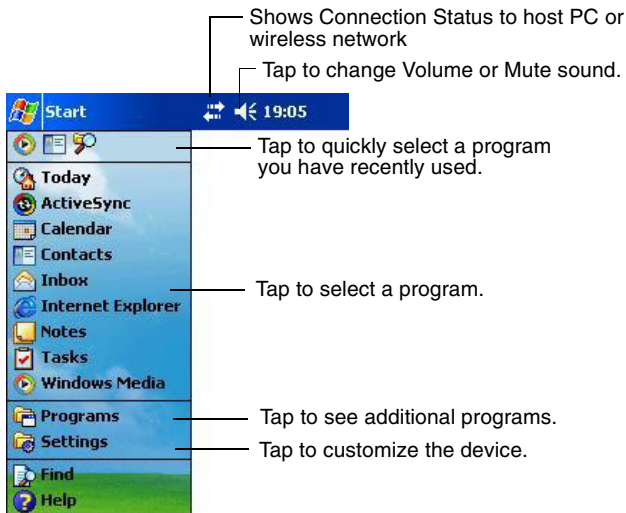

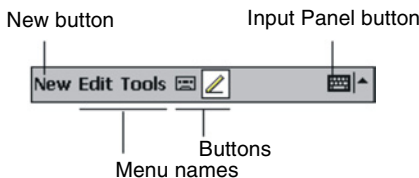

Use the Command bar at the bottom of the screen to perform tasks in programs. The Command bar includes menu names, buttons, and the Input Panel button. To create a new item in the current program, tap **New**. To see the name of a button, press and hold the stylus on the button. Drag the stylus off the button so that the command is not carried out.

## The Command bar:











# Running Programs

Depending on the program you want to run, you can:

- Tap  or tap **Start** at the top of the screen and select from the menu. (You can customize which programs you see on this menu. For information, see section "Customizing Your V38r" in Chapter 3).
- Tap  and then tap **Programs** to access additional programs. Tap the icon to run the program.
- Press program buttons on the front of your V38r to open the program. The icons on the buttons identify the programs they are associated with. (You can customize which programs are associated with the buttons. For information, see the section "Customizing Your V38r" in this guide).

The following table contains a partial list of the program icons on your V38r.

Icon	Program	Description
	ActiveSync	Synchronize information between your V38r and PC.
	Calendar	Keep track of your appointments and create meeting requests.
	Contacts	Keep track of your friends and colleagues.
	Inbox	Send and receive email messages.
	Pocket Internet Explorer	Browse Web and WAP (Wide Area Protocol) sites, and download new programs and files from the Internet.
	Notes	Create handwritten or typed notes, drawings, and recordings.
	Tasks	Keep track of your tasks.
	Pocket Excel	Create new workbooks or view and edit Excel workbooks created on your PC.
	Pocket Word	Create new documents or view and edit Word documents created on your PC.

# Pop-up Menu

With pop-up menus, you can quickly choose an action for an item. For example, you can use the pop-up menu in the contact list to quickly delete a contact, make a copy of a contact, or send an email message to a contact. The actions in the pop-up menu vary from program to program. To access a pop-up menu, press and hold the stylus on the name of the item that you want to perform the action on.

When the menu appears, lift the stylus, then tap the action you want to perform. Or tap anywhere outside the menu to close the menu without performing an action.

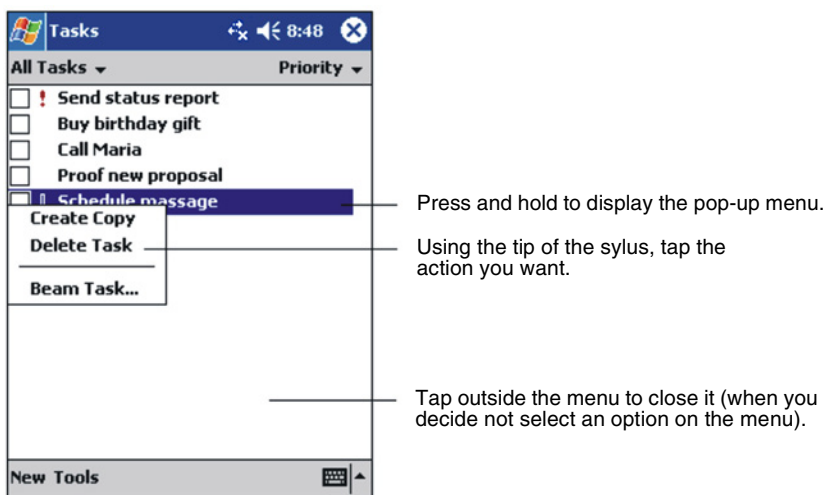

# Notifications

Your V38r reminds you in a variety of ways when you have something to do. For example, if you have set up an appointment in Calendar, a task with a due date in Tasks, or an alarm in Clock, you will be notified in any of the following ways:

- A message appears on the screen.
- A sound, which you can specify, is played.
- The notification LED flashes.

To choose reminder types and sounds for your V38r, tap **Settings** on the **Start** menu. On the **Personal** tab, tap **Sounds & Notifications**.

# Entering Information

You have several options for entering new information:

- Use the Input Panel to enter typed text, either by using the soft (on-screen) keyboard or other input methods.
- Write directly on the screen.
- Draw pictures on the screen.
- Speak into the microphone to record a message. For more information on using the microphone, see the section on "Recording a Message".

# Entering Text Using the Input Panel

Use the Input Panel to enter information in any program on your V38r.

You can either type using the soft (on-screen) keyboard or write using the Block Recognizer or Letter Recognizer. In any case, the characters appear as typed text on the screen.

## Show/Hide the Input Panel

To show or hide the Input Panel, tap the **Input Panel** button. Tap the arrow next to the Input Panel button to see your choices.

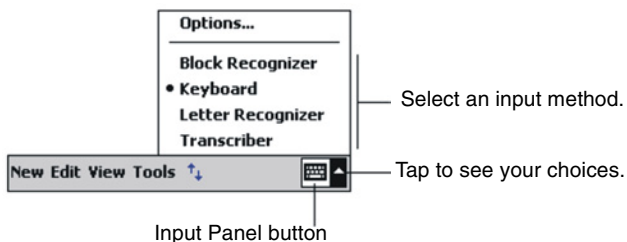

When you use the Input Panel, your V38r anticipates the word you are typing or writing and displays it above the Input Panel. When you tap the displayed word, it is inserted into your text at the insertion point. The more you use your V38r, the more words it learns to anticipate.

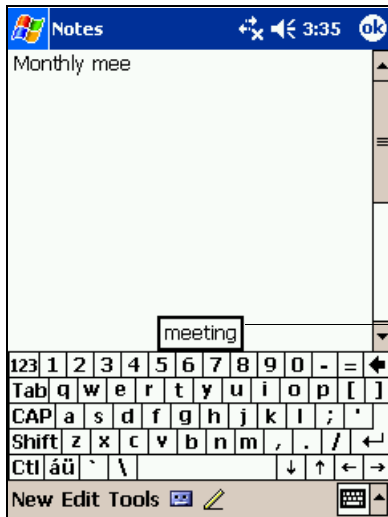

Tap here if this is the right word.

**NOTE:** To change word suggestion options, such as the number of words suggested at one time, tap **Settings** on the **Start** menu. On the **Personal** tab, tap **Input**, then tap the **Word Completion** tab.

### Block Recognizer

With Block Recognizer, you can use the stylus to input characters and words.

To type with Block Recognizer:

- 1 Tap the arrow next to the Input Panel button, and then tap **Block Recognizer**.
- 2 Write a letter in the box.

When you write a letter, it is converted to typed text that appears on the screen. For specific instructions on using Block Recognizer, open Block Recognizer, and then tap the question mark (?) next to the writing area.

## Soft Keyboard

The Soft Keyboard is an on-screen keyboard displayed at the bottom of the screen.

To type with the soft keyboard:

- 1 Tap the arrow next to the Input Panel button, and then tap **Keyboard**.
- 2 On the keyboard that is displayed, tap the keys with your stylus.

## Letter Recognizer

With Letter Recognizer, you can write letters using the stylus just as you would use a pen on paper.

To type with Letter Recognizer:

- 1 Tap the arrow next to the Input Panel button, and then tap **Letter Recognizer**.
- 2 Write a letter in the box.

When you write a letter, it is converted to typed text that appears on the screen. For specific instructions on using Letter Recognizer, open Letter Recognizer and then tap the question mark next to the writing area.

## Transcriber

With Transcriber you can write anywhere on the screen using the stylus just as you would on paper. Unlike Letter Recognizer and Block Recognizer, you can write a sentence or more of information; then, you pause and let Transcriber change the written characters to typed characters.

To type with Transcriber:

- 1 Tap the arrow next to the Input Panel button, and then tap **Transcriber**.
- 2 Write anywhere on the screen.

For specific instructions on using Transcriber, open Transcriber and then tap the question mark in the lower-right corner of the screen.



## Writing on the Screen

In any program that accepts writing—such as the Notes program and the **Notes** tab in **Calendar**, **Contacts**, and **Tasks**—you can use your stylus to write directly on the screen. Write the way you do on paper. You can edit and format what you have written and convert the information to text later.

To write on the screen, tap the **Pen** button to switch from tapping to writing mode. This action displays lines on the screen to help you write.

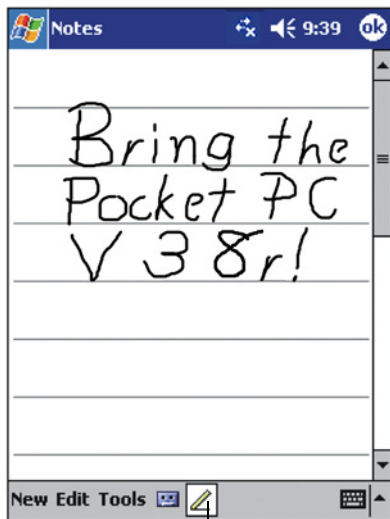

Tap the **Pen** button and use your stylus like a pen.

Some programs that accept writing may not have the **Pen** button. See the documentation for that program to find out how to switch to writing mode.

If you want to edit or format writing, you must select it first. To select writing:

- 1 Press and hold the stylus next to the text you want to select until the insertion point appears.
- 2 Without lifting, drag the stylus across the text you want to select.

If you write accidentally on the screen, tap **Tools**, then **Undo**, and try again. You can also select text by tapping the **Pen** button to deselect it and then dragging the stylus across the screen.

You can cut, copy, and paste written text in the same way you work with typed text: press and hold the stylus on the selected words and then tap an editing command on the pop-up menu, or tap the command on the **Edit** menu. To convert writing to text, tap **Recognize** on the **Tools** menu.

If you want to convert only certain words, select them before tapping **Recognize** on the **Tools** menu (or press and hold the selected words and then tap **Recognize** on the pop-up menu). If a word is not recognized, it is left as writing.

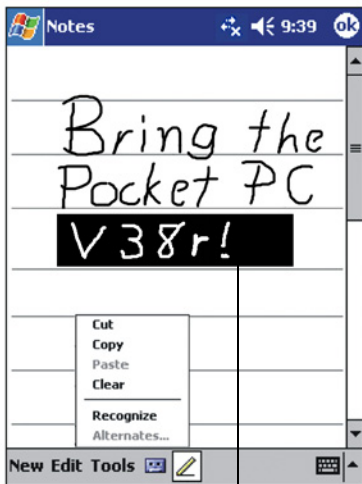

Select the text you want to convert and tap **Recognize** on the Pop-up menu.

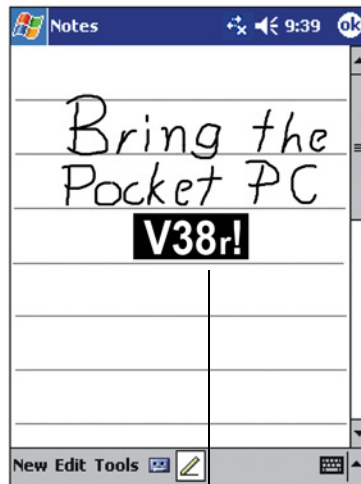

Your handwriting is turned into text.

If the conversion is incorrect, you can select different words from a list of alternates or return to the original writing. To do so, press and hold the incorrect word (tap one word at a time). On the pop-up menu, tap **Alternates**.

A menu with a list of alternate words appears. Tap the word you want to use, or tap the writing at the top of the menu to return to the original writing.

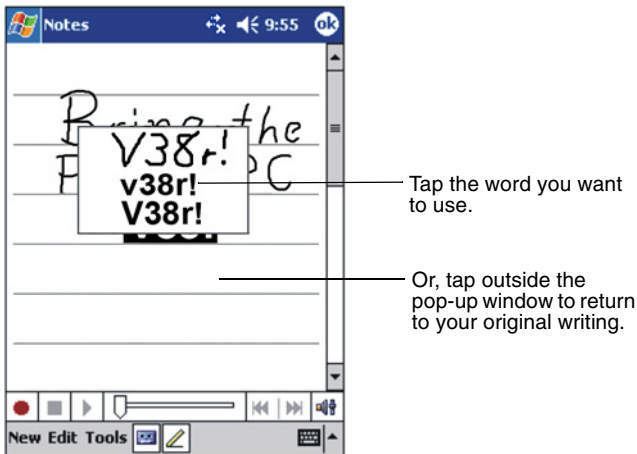

Some tips for getting good recognition are listed below:

- Write on the lines and draw descenders below the line. Write the cross of the "t" and apostrophes below the top line so that they are not confused with the word above. Write periods and commas above the line.

For better recognition, use the **Tools** menu to increase the zoom level to 300%.

- Write the letters of a word close together and leave big gaps between words.
- Hyphenated words, foreign words that use special characters such as accents, and some punctuation cannot be converted.
- If you add writing to a word to change it (such as changing a "3" to an "8") after you attempt to recognize the word, the writing you add will not be included if you attempt to recognize the writing again.

## Drawing on the Screen

You can draw on the screen in the same way that you write on the screen. The difference between writing and drawing on the screen is how you select items and how they can be edited. For example, selected drawings can be resized, while writing cannot.

To create a drawing, cross three ruled lines on your first stroke. A drawing box appears. Drawings that do not cross three ruled lines will be treated as writing.

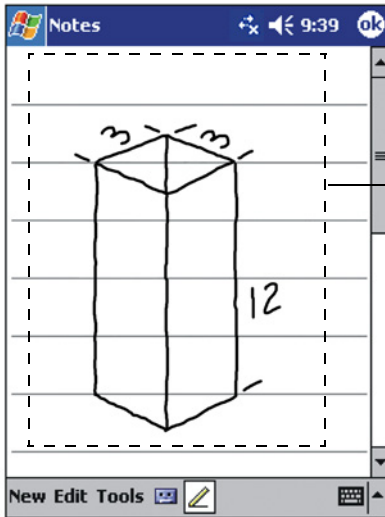

The drawing box indicates the boundaries of the drawing.

You may want to change the zoom level so that you can more easily work on or view your drawing. Tap **Tools**, then choose a zoom level.

If you want to edit or format a drawing, you must select it first.

To select a drawing, press and hold the stylus on the drawing until the selection handle appears. To select multiple drawings, deselect the Pen button and then drag to select the drawings you want.

You can cut, copy, and paste selected drawings by pressing and holding the selected drawing and then tapping an editing command on the pop-up menu, or by tapping the command on the **Edit** menu. To resize a drawing, make sure the Pen button is not selected, and then drag a selection handle.

## Recording a Message

In any program where you can write or draw on the screen, you can also quickly capture thoughts, reminders, and phone numbers by recording a message. In **Calendar**, **Tasks**, and **Contacts**, you can include a recording in the **Notes** tab. In the Notes program, you can either create a stand-alone recording or include a recording in a written note. If you want to include the recording in a note, open the note first. In the Inbox program, you can add a recording to an email message.

To create a recording:

- 1 Hold the **V38r**'s microphone about three inches from your mouth.
- 2 Press and hold the record button on the left side of the unit. If the speaker is not muted, a beep indicates that your V38r is recording.
- 3 While holding down the record button, speak into the microphone.
- 4 To stop recording, release the record button. Two beeps will sound. The new recording appears in the note list or as an embedded icon.

**NOTE:** You can also make a recording by tapping the **Record** button on the Recording toolbar.

To play a recording:

- Tap it in the list or tap its icon in the note.

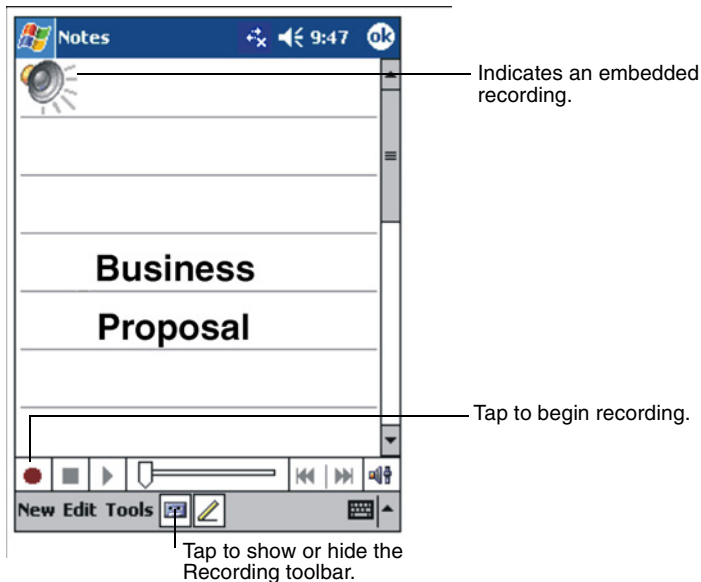

## Recording Formats

Your V38r supports several formats for voice notes. The formats vary in both the quality of the recording and the size of the sound file. When selecting a recording format, you should consider the quality you need as well as how much storage memory the recording will use on your V38r.

Not all recording formats are compatible with other software or computers. If you will share your recordings with others or transfer a recording to your PC, be sure to choose a recording format that is supported by the software used to play recordings on the other computer.

To select a recording format:

- 1 On the **Start** menu, tap **Settings**, and then tap the **Input** icon.
- 2 On the **Options** tab in the Input control panel, select a voice recording format from the drop-down list.

The list of recording formats on your V38r indicates the sample rate, whether the format is stereo or mono, and how much storage memory is required per second of recording. You may

need to experiment with different sample rates and formats to determine which format best suits your voice.

## Using My Text

When using Inbox, use My Text to quickly insert preset or frequently used messages into the text entry area. To insert a message, tap **My Text**, and then tap a message.

**NOTE:** After inserting a My Text message, you can add text to it before you send the message.

To edit a My Text message, on the **Tools** menu, tap **Edit My Text Messages**. Select the message you wish to edit and make desired changes.

# Chapter 3: Managing Your V38r

This chapter tells you how to effectively manage power and memory, and how to add/remove programs and back up your data.

## Managing Power

It is important to maintain a continuous power supply to the V38r to prevent data or files stored in RAM from being damaged. Your V38r can operate either on external AC power or internal battery power. Note that you will lose any information, programs or settings that you have added if the battery completely runs out of power.

A fully charged battery should provide power for up to 4 hours of use. The operating time of a fully charged battery depends on how you are using the V38r. Using some functions, such as some of the multimedia features or a Secure Digital memory card, may consume extra battery power.

You should recharge the battery when a warning of low power is displayed on your V38r, or the V38r will turn off automatically. You will need to connect the V38r to external AC power for charging before you can use it again.

See Chapter 1 for information about powering on your V38r.

To check the remaining power:

- 1 On the **Start** menu, tap **Settings**.
- 2 On the **System** tab, tap the **Power** icon.

The remaining power is displayed on a status bar in the Power control panel.



# Smart Power Management

Power management utilities are supplied with your V38r that provide you options that help prolong the battery's operating time. To access these utilities, do the following:

- 1 Tap , then tap **Settings**.
- 2 Tap **System** tab, then tap **Advanced Settings**.

Under Advanced Settings there are three tabs: **System**, **Smart Battery**, and **Power Manager**. Descriptions for these options are provided below.

## System

This screen provides system information. It does not contain any control options.

## Smart Battery

Option	Description
<b>Auto</b> (default setting)	This mode automatically adjusts the CPU speed according to the need of the current operation.
<b>Low Performance</b>	This mode prolongs the battery life by minimizing the CPU's performance.
<b>High Performance</b>	This mode enhances battery life by improving the CPU's performance.
<b>Superior Performance</b>	This mode decreases the battery life, resulting from maximum CPU performance.

## Power Manager

Option	Description
You can also select the events that wake up your <b>V38r</b> from <b>Sleep Mode</b> : <b>NOTE:</b> For each of the three options below the default setting is "checked."	
<b>Application Buttons</b>	If this option is checked, you can wake up your V38r by pressing one of these four application buttons on the front of your <b>V38r</b> : <b>Note</b> , <b>Calendar</b> , <b>Contacts</b> , or <b>Task</b> .
<b>Record Button</b>	If this option is checked, you can wake up your V38r by pressing the <b>Record</b> button on the V38r.
<b>SD/MMC Card Insertion/Removal</b>	If this option is checked, you can wake up your <b>V38r</b> by inserting or removing an SD card.

## Power-Saving Tips

Follow these suggestions to maximize the battery's operating time:

- **Turn off the backlight.** Press and hold the power button to turn off the backlight, or use the Backlight control panel to set the backlight to turn off automatically after a short period of inactivity.
- **Suspend frequently.** Use the Power control panel to shorten the length of continuous idle time before your V38r auto-suspends. Press the power button to turn off your V38r when it is not in use, even for a short time.
- **Always use AC power when connecting your V38r to your PC.** Note that your V38r will not auto-suspend while it is connected.
- **Turn off sounds.** Use the Sounds & Notifications control panel to turn off all but the most necessary system sounds.
- **Avoid using memory card accessories while on battery power.** Some memory cards use considerable power and will quickly drain your battery.
- **Do not "listen" for infrared transfers.** Although you can set your Rugged Handheld to constantly monitor the IR port for files sent from other devices, doing so will quickly drain your batteries.

## Managing Memory

Your V38r uses two kinds of memory: storage and program memory (RAM), and optional memory cards.

### Storage and Program Memory

RAM (Random Access Memory) on your V38r is shared between storage memory and program memory. "Storage memory" is used to store the data you create and additional programs you install. "Program memory" is used to run programs on your V38r. Your V38r automatically manages the allocation between storage and program memory. However, in some situations, such as when the memory is running out, your V38r may not be able to automatically adjust the allocation.

## Memory Cards

Memory cards are small, removable flash storage cards that enable you to expand the memory of your V38r. You can use memory cards for backup storage, archives, or to transfer large files to other devices. Your V38r supports Secure Digital memory cards. Memory cards can be purchased from a variety of third-party vendors.

# SD Memory Capabilities

Your V38r has an SD card slot which accepts an SD (Secure Digital) memory card. You can purchase an SD card to expand the memory capacity and capabilities of your V38r.

To insert an SD memory card:

- 1 Slide the end of the card with the chipped corner into the SD slot on the side of the V38r.
- 2 Push the card into the slot until it clicks into place.
- 3 To remove an SD memory card, press the card. When the card pops out slightly, you can pull it out.

## SDRAM Memory Allocation

The V38r has 64 MB of SDRAM memory:

- For the USA and European models: 27.5 MB is used by the Rugged Handheld 2003 Operating System, applications, and drivers.
- For the Asian models: 35.5 MB is used by the Rugged Handheld 2003 Operating System, applications, and drivers.
- The remaining memory is available for user applications and file storage: 36.5MB for the USA and Europe V38r models and 28.5MB for the Asian V38r models.

### Memory Map for 64MB SDRAM:

Description	USA and European Models	Asian Models
Flash ROM Image allocated for Rugged Handheld 2003 Operating System and applications	24.0 MB	32.0 MB
Drivers	3.5 MB	3.5 MB
Available for user applications and file storage	36.5 MB	28.5 MB
<b>Total Memory</b>	<b>64.0 MB</b>	<b>64.0 MB</b>

**NOTE:** The USA and Europe V38r models have an additional 36 MB of Flash ROM memory available for file storage called "My Flash Disk."

The Asian V38r models have an additional 31 MB of Flash ROM memory available for file storage. This additional Flash ROM is smaller because the Asian operating systems require more space.

## Antenna Signal Properties

Your *V38r* can use a wireless radio signal standard called the 802.11b/g standard to communicate with a local 802.11b/g standard network connected to a modem. The quality of your radio connection signal can be weakened by excessive distance and by intervening materials such as walls and furnishings. If the wireless connection seems to work intermittently, check the quality of your wireless connection.

## Finding and Organizing Information

The Find feature on your V38r helps you quickly locate information.

To find a file, on the **Start** menu, tap **Find**. Enter the text you want to find, select a data type, and then tap **Go** to start the search.

**NOTE:** To quickly find information that is taking up storage space on your V38r, select **Larger than 64KB** under **Type**.

You can also use the File Explorer to find files on your V38r and to organize these files into folders. On the **Start** menu, tap **Programs**, and then tap **File Explorer**.

Tap to change folders.

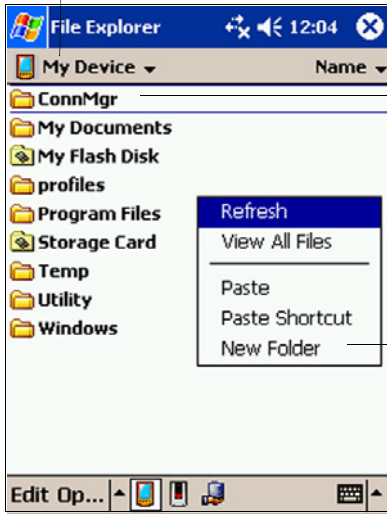

— Select the sort order for the list.

— Tap the folder name to open it.

— Press and hold to create a new folder.

# Customizing Your V38r

You can customize the settings of the V38r to your own preferences.

Tap **Start**, then tap **Settings**. You can tap any of the icons on the **Personal**, **System**, or **Connections** tabs to customize your V38r. The customization options are as follows:

	Options	Description
<b>PERSONAL</b>	<b>Buttons</b>	Assigns your favorite programs to the program buttons, and sets the repeat rate of the scroll dial.
	<b>Input</b>	Sets the settings related to Block Recognizer, soft keyboard, Letter Recognizer and Transcriber input methods.
	<b>Menus</b>	Selects the items that appear on the <b>Start</b> menu and the <b>New</b> menu on the <b>Today</b> screen.
	<b>Owner Information</b>	Saves your personal information.
	<b>Password</b>	Sets the password to your V38r to protect the stored data.
	<b>Sounds &amp; Notifications</b>	Sets the conditions and types of the sounds, system volume, and ways of notifications.
	<b>Today</b>	Sets the items that appear on the Today screen.
<b>SYSTEM</b>	<b>About</b>	Shows information about the version of the operating system, the name of the Rugged Handheld, and copyrights.
	<b>Backlight</b>	Adjusts the backlight of the display.
	<b>Clock</b>	Sets the current time and alarm.
	<b>Memory</b>	Adjusts the allocation of data and program storage.
	<b>Power</b>	Shows the remaining battery and external AC power, and set the time for the V38r to turn off automatically.
	<b>Regional Settings</b>	Sets the region of your location, and formats for number, currency, time and date.
	<b>Remove Programs</b>	Removes programs pre-installed in RAM.
	<b>Screen</b>	Realigns the touch screen for accurate taps.

# Setting a Password

A password can safeguard your V38r against unauthorized use. To set your password:

- 1 Tap **Start**, tap **Settings**, then tap the **Password** icon on the **Password** tab.
- 2 Tap the digits or characters to set your password. You can set a four-digit password, or a long password containing a combination of at least seven characters, digits or punctuation.
- 3 You can set the time for the V38r to prompt for a password after idling.
- 4 Tap **OK**.

# Adding or Removing Programs

## Adding Programs

You can add even more functionality to your V38r by installing additional software and programs. A wide variety of software is available for Windows Powered Rugged Handhelds, ranging from custom business applications and system utilities to games and entertainment. Some programs are available from software vendors or on the Web.

Install only programs designed specifically to run on a Rugged Handheld personal digital assistant and/or a Windows Powered Rugged Handheld. You cannot run programs designed for Windows on your V38r. In addition, you may need a version of the program designed specifically for the **X-Scale** processor used by your V38r.

Install software to your V38r by first loading the installation files onto your PC. Use ActiveSync on your PC to transfer and install programs to the storage memory (RAM) in your V38r.



## Removing Programs

To free storage memory on your V38r, you can remove programs you no longer use. Only programs that are stored in RAM can be removed.

Programs pre-installed in Flash ROM cannot be removed; however, these programs do not use storage memory.

To remove a program:

- 1 On the **Start** menu, tap **Settings**.
- 2 On the **System** tab, tap **Remove Programs**.
- 3 Select the program in the list, and then tap **Remove**.

**NOTE:** If the program does not appear in the list of installed programs, use **File Explorer** on your **V38r**. Locate the program, press and hold the stylus on the program, and then tap **Delete** on the pop-up menu.

## Backing Up Data

To prevent loss of data, you should back up your **V38r** frequently. Your **V38r** comes with two programs for backing up data:

- **Microsoft ActiveSync.** **ActiveSync** enables you to back up data to your PC. You can back up all data on your V38r, or only your PIM databases (**Calendar**, **Contacts**, and **Tasks**). You can set **ActiveSync** to back up automatically each time you connect, or you can back up manually, whenever you choose. For more information, see **ActiveSync Help** on your PC.
- **Backup** enables you to back up all data stored in the internal (RAM) memory on your **V38r**. You can save the backup file on an optional Secure Digital memory card.

## Using Backup

Backup gives you added flexibility in backing up your valuable data. With Backup, you can back up all data in RAM. You can save the backup file to an optional SD memory card, so you can safeguard your data even while you are traveling or away from your PC.

**NOTE:** An internal storage device called “My Flash Disk” is included. When using Backup, you can choose this disk as your target backup device.

### Backing up data using Backup

- 1 Close all running applications and insert a memory card.
- 2 Disconnect your V38r from your PC.
- 3 On the **Start** menu on your V38r, tap **Programs** and then tap the **Backup** icon.
- 4 Tap **Backup**, then tap **Next**.
- 5 Tap your preference of storage media for backing up your data, then tap **Next**.
- 6 Tap the item you want to back up, then tap **Next**.
- 7 Tap **Backup**, then tap **Yes** to start the backup process.
- 8 Remove the memory card after the backup is complete.

### CAUTION:

- **Never delete the backup file in the memory card. If the backup file is deleted, the backup data will be lost and cannot be restored.**
- **When you use the backup file to restore information, information on your V38r is replaced with the information stored in the backup file. If you have created files on your V38r since the last backup and do not want to delete these files during the restore process, move the files from your V38r to your PC--or to an optional memory card--before restoring the information.**

### Restoring data using Backup

- 1 Close all running applications and insert a memory card with the backup data.
- 2 Disconnect your V38r from your PC.
- 3 On the **Start** menu tap **Programs**, then tap the **Backup** icon.
- 4 Tap **Restore**, then tap **Yes**.
- 5 Tap your preference of storage media for restoring your data, then tap **Next**.
- 6 Tap the item you want to restore, then tap **Next**.
- 7 Tap **Restore**, then tap **Yes** to start the restore process.
- 8 Remove the memory card after the restore process is complete, and reset your V38r.

**IMPORTANT:** When you restore data, your V38r must have the same regional settings that it had when you completed the backup; otherwise, you will not be able to restore the files. To change regional settings, on the **Start** menu, tap **Settings**, and then tap the **Regional Settings** icon on the **System** tab. Select your region from the drop-down list.

# Chapter 4: Microsoft ActiveSync

This chapter tells you what the **Microsoft ActiveSync** program is and what you need to do to use it.

## Using Microsoft ActiveSync

**NOTE:** ActiveSync is already installed on your V38r. You need to install ActiveSync on your PC. (For information on installing ActiveSync, see Step 5 of the Quick Start procedure in Chapter 1, “Installing **Microsoft ActiveSync**.”)

**Microsoft ActiveSync** allows you to synchronize the information on your PC with information on your V38r. Synchronization compares the data on the two sides and updates both computers with the most recent information. For example, you can:

- Keep your Pocket Outlook Contacts, Calendar, and Tasks databases up-to date by synchronizing your V38r with Microsoft Outlook data on your PC.

**IMPORTANT:** Outlook must be installed on your PC in order to synchronize your email data.



- Synchronize email messages in your V38r Inbox with email messages in Microsoft Outlook on your PC.
- Synchronize **Microsoft Word** and **Microsoft Excel** files between your V38r and PC. Your files will be automatically converted to the correct format.

With **ActiveSync**, you can also:

- Back up and restore your V38r data.
- Copy (rather than synchronize) files between your V38r and PC.
- Add and remove programs on your V38r.

## Synchronizing Data

Once you have created a synchronization partnership and completed the first synchronization, you can initiate synchronization from your V38r. Follow this procedure:

- 1 Connect your V38r to your PC. (See "Connecting to Your PC" in this chapter.)
- 2 On your V38r, tap , and then tap **ActiveSync**.
- 3 Tap  to begin synchronization.

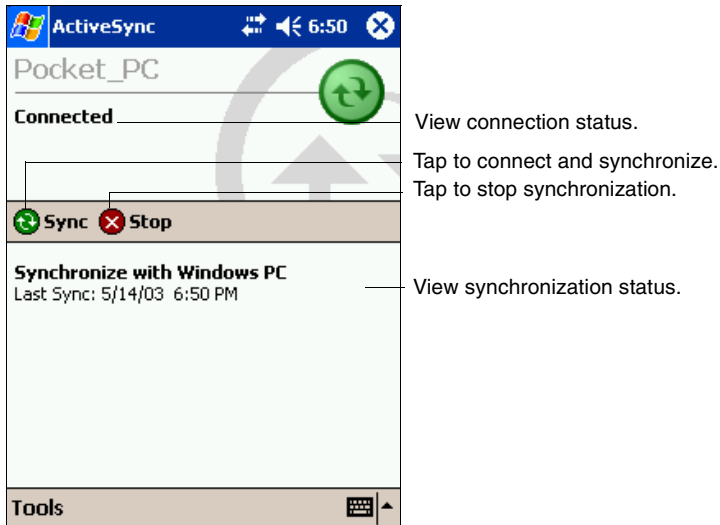

By default, ActiveSync does not automatically synchronize all types of information. Use ActiveSync options to turn synchronization on and off for specific information types. You can:

- Control when synchronization occurs by selecting a synchronization mode. For example, you can synchronize continually while the V38r is connected or only when you choose the synchronize command.
- Select which information types are synchronized and control how much data is synchronized. For example, you can choose how many weeks of past appointments you want synchronized.

For information on setting ActiveSync options and using ActiveSync on your PC, see ActiveSync Help on the PC. For information on using ActiveSync in your V38r, see ActiveSync Help on the V38r.

## Connecting to Your PC

**CAUTION: Do not shut down or restart your PC while your V38r is connected. Turn off your V38r or disconnect the USB cable before you shut down your PC.**

### Connecting by USB Cable

**CAUTION: Before you connect your V38r to the USB synchronization cable, be sure of the following: your PC is on, you have installed ActiveSync on your PC, and ActiveSync is configured to allow a USB connection.**

For connection instructions, see the section "Installing Microsoft ActiveSync" in this guide.

### Connecting by Infrared

You can use the IR port to synchronize data with your PC, in place of using the cable.

IR ports can be found on many notebook computers; however, on a PC, you may need to install and configure an IR port. To install the port, follow the manufacturer's instructions.

For complete instructions on connecting to your PC by infrared, refer to ActiveSync Help on your PC.

# Chapter 5: Pocket Outlook

This chapter introduces you to the basics of Microsoft Pocket Outlook, including Calendar, Contacts, Tasks, Notes and Inbox.

## Scheduling Appointments/Meetings

Use Calendar to schedule appointments, including meetings and other events.

You can check your appointments in one of several views (Agenda, Day, Week, Month, and Year) and easily switch views by using the **View** menu.

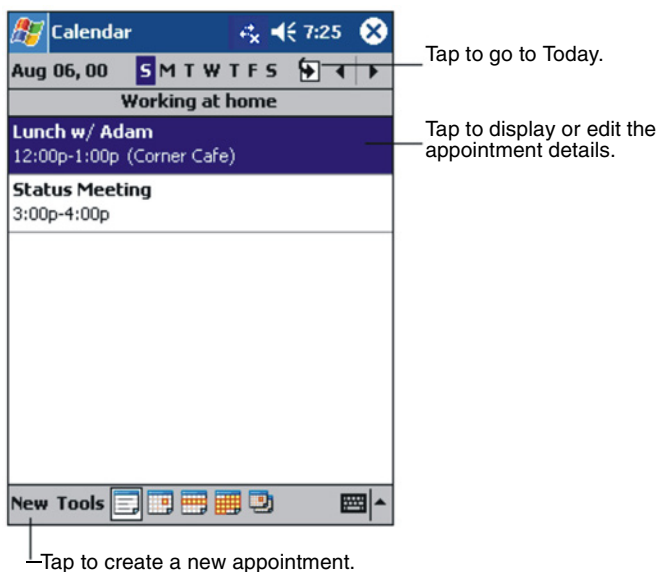

**NOTE:** You can customize the Calendar display (for example, change the first day of the week), by tapping **Options** on the **Tools** menu.

# Creating an Appointment

- 1 In Day or Week view, tap the desired date and time for the appointment.
- 2 Tap **New**.

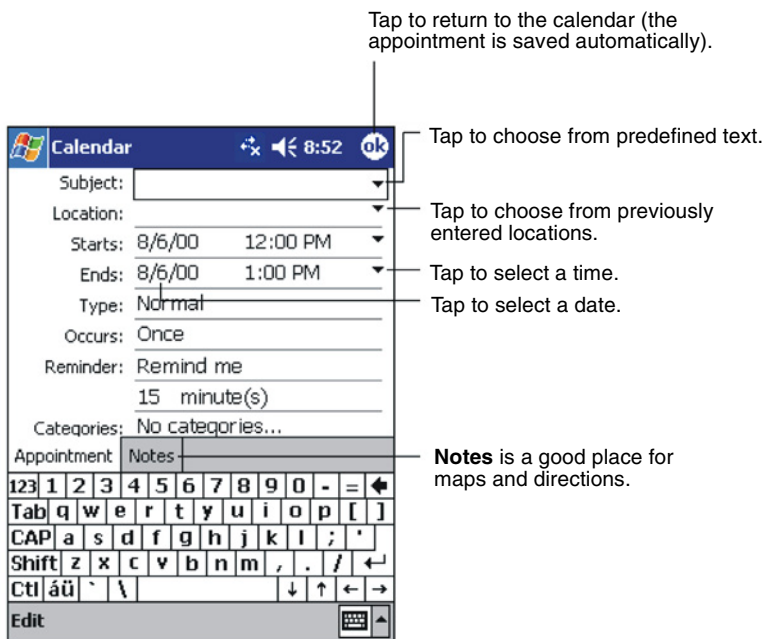

- 3 When using the Input panel, tap first to select the field, and then enter a description and a location.
- 4 If needed, tap the date and time to change them.
- 5 Enter other desired information. You will need to hide the Input panel to see all available fields.
- 6 To add notes, tap the **Notes** tab. You can enter text, draw, or create a recording. For more information on creating notes, see "Notes: Capturing Thoughts and Ideas" later in this chapter.
- 7 Tap **OK** to return to Calendar.

**NOTE:** If you select **Remind me** in an appointment, your V38r will remind you according to the options set in the Sounds & Notifications control panel.



## Using the Summary Screen

When you tap an appointment in Calendar, a summary screen displays. To change the appointment, tap **Edit**.

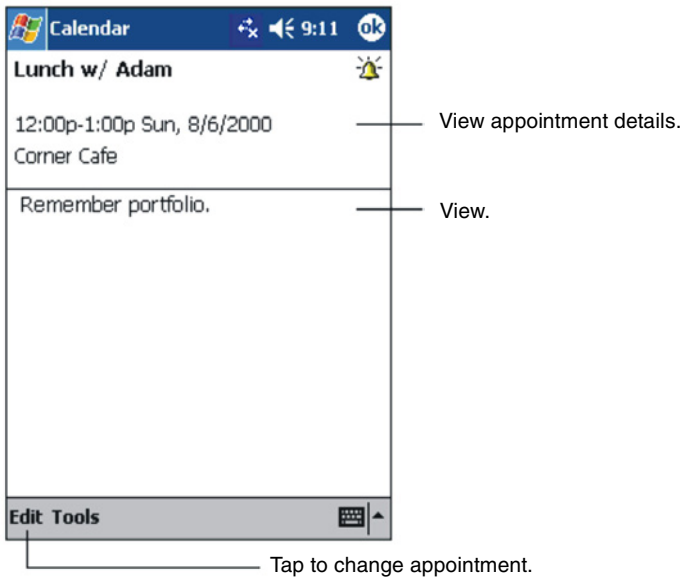

## Creating Meeting Requests

You can use Calendar to set up meetings with users of Outlook or Pocket Outlook. The meeting notice will be created automatically and sent either when you synchronize Inbox or when you connect to your email server. Indicate how you want meeting requests sent by tapping **Tools** and then **Options**. If you send and receive email messages through ActiveSync, select **ActiveSync**.

To schedule a meeting:

- 1 Create an appointment.
- 2 In the appointment details, hide the Input panel, and then tap **Attendees**.
- 3 From the list of email addresses in Contacts, select the meeting attendees.

The meeting notice is created automatically and placed in the Outbox folder. For more information on sending and receiving meeting requests, see Calendar Help and Inbox Help on your V38r.

# Managing Contacts

Contacts maintains a list of your friends and colleagues so that you can easily find the information you are looking for, whether you are at home or on the road. Using the IR port on the V38r, you can quickly share Contacts information with users of Rugged Handhelds and other mobile devices.

Select the category of contacts you want to display in the list.

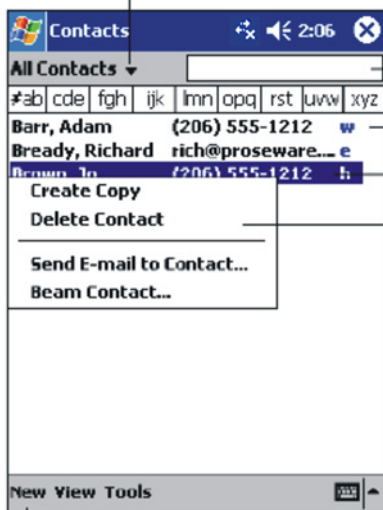

Tap and enter part of a name to quickly find it in the list.

Tap to see additional phone numbers and e-mail addresses.

Tap to display or edit the contact details.

Press and hold to display a pop-up menu of actions.

Tap to create a new record.

**NOTE:** To change the way information is displayed in the list, tap **Tools** then tap **Options**.

## 1 Tap **New**.

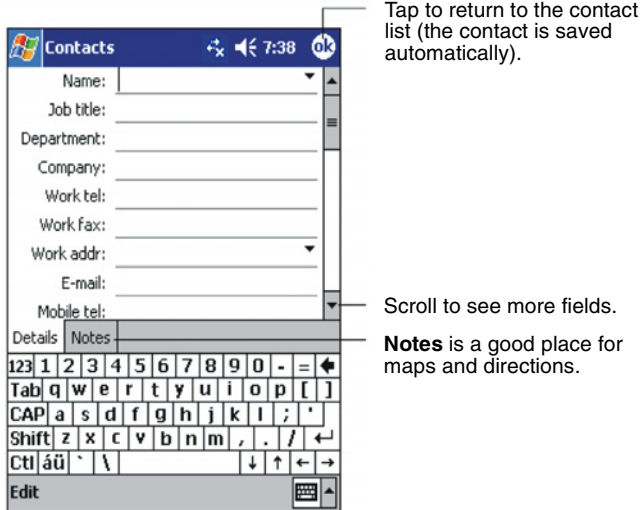

- 2 Using the Input panel, enter a name and other contact information. You will need to scroll down to see all available fields.
- 3 To assign the contact to a category, scroll to and tap **Categories** then select a category from the list. In the contact list, you can display contacts by category.
- 4 To add notes, tap the **Notes** tab. You can enter text, draw, or create a recording. For more information on creating notes, see "Notes: Capturing Thoughts and Ideas" later in this chapter.
- 5 Tap **OK** to return to the contact list.

## Finding a Contact

There are four ways to find a contact:

- On the **Start** menu, tap **Find**, enter the contact name, select **Contacts** for the type, and then tap **Go**.
- In the contact list, enter a contact name in the box under the Navigation bar.

To show all contacts again, clear text from the box or tap the button to the right of the box.

- In the contact list, tap the category list (labeled **All Contacts** by default) then select the type of contact that you want displayed. To show all contacts again, select **All Contacts**. To view a contact not assigned to a category, select **None**.
- To view the names of companies your contacts work for, in the contact list, tap **View** then tap **By Company**. The number of contacts that work for that company will be displayed to the right of the company name.

## Using the Summary Screen

When you tap a contact in the contact list, a summary screen displays. To change the contact information, tap **Edit**.

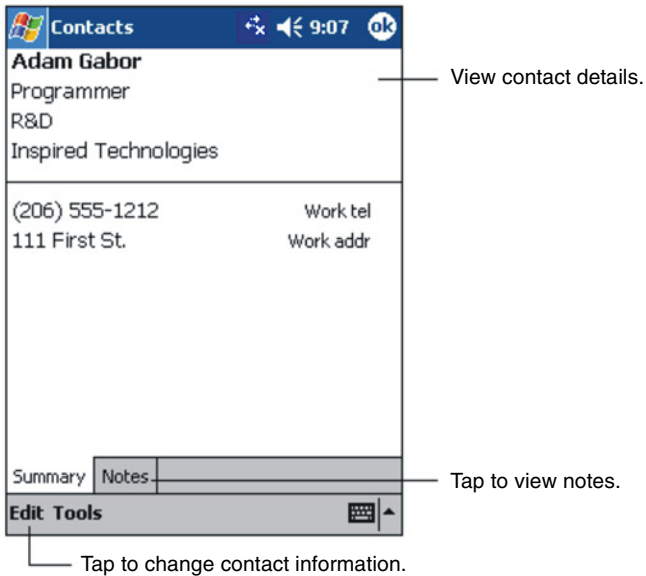

# Tasks: Keeping a To Do List

Use Tasks to keep track of what you have to do.

Select the category of tasks you want to display in the list.

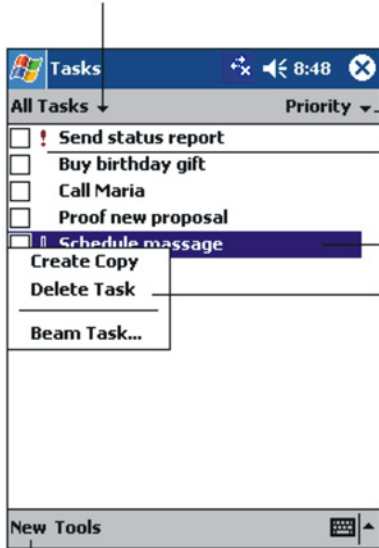

Select the sort order of the list.

! Indicates high priority.

Tap to display or edit the task details.

Press and hold to display a pop-up menu of actions.

Tap to create a new task.

# Creating a Task

## 1 Tap **New**.

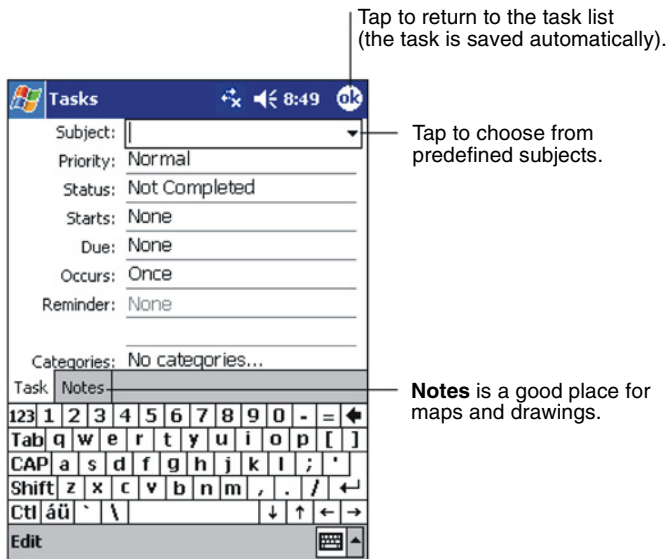

## 2 Using the Input panel, enter a description.

## 3 You can enter a start date and due date, or enter other information by first tapping the field. If the Input panel is open, you will need to hide it to see all available fields.

## 4 To assign the task to a category, tap **Categories**, then select a category from the list. In the task list, you can display tasks by category.

## 5 To add notes, tap the **Notes** tab. You can enter text, draw, or create a recording. For more information on creating notes, see "Notes: Capturing Thoughts and Ideas" later in this chapter.

## 6 Tap **OK** to return to the task list.

## Using the Summary Screen

When you tap a task in the task list, a summary screen displays. To change the task, tap **Edit**.

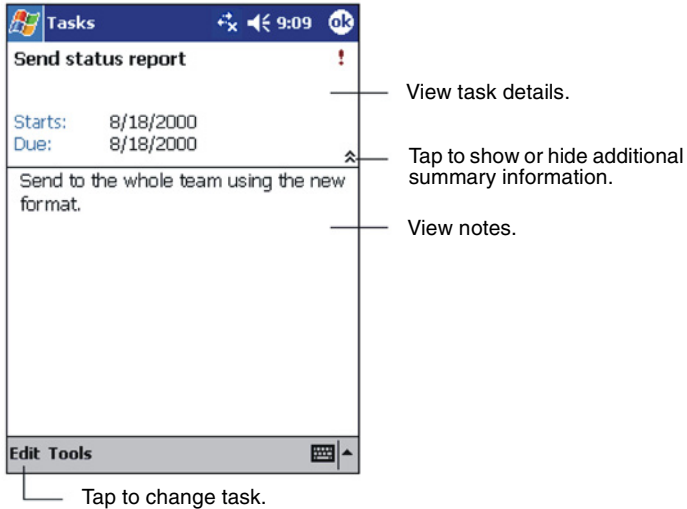



# Notes: Capturing Thoughts and Ideas

Quickly capture thoughts, reminders, ideas, drawings, and phone numbers with Notes. You can create a written note or a recording. You can also include a recording in a note. If a note is already open when you create the recording, it will be included in the note as an icon. If the note list is displayed, the recording will be created as a stand-alone recording.

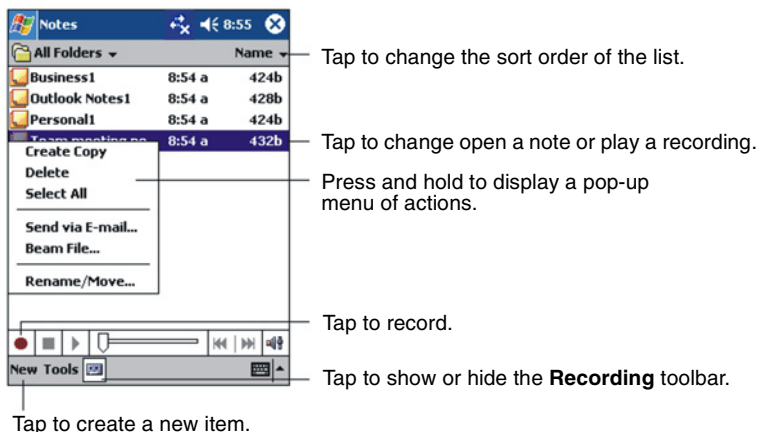

## Creating a Note

- 1 Tap **New**.
- 2 Create your note by writing, drawing, typing, or recording. For more information about using the Input panel, writing and drawing on the screen, and creating recordings, see the section on "Entering Information" in this guide.

# Inbox: Sending and Receiving Email

Use the Inbox to send and receive e-mail messages with Microsoft Outlook on your PC.

## Synchronizing Email Messages

Email messages can be synchronized as part of the general synchronization process. To do this, you need to enable Inbox synchronization in ActiveSync. For information on enabling Inbox synchronization, see ActiveSync Help on the PC.

During synchronization:

- Messages are copied from the mail folders of Exchange or Outlook on your PC to the ActiveSync folder in Inbox on your V38r.
- Email messages in the Outbox folder on your V38r are transferred to Exchange or Outlook, and then sent from those programs.
- Email messages in subfolders must be selected in ActiveSync on your PC in order to be transferred.

# Using the Message List

Messages you receive are displayed in the message list. By default, the most recently received messages are displayed first in the list.

Select the Internet Service Provider and the folder you want to display.

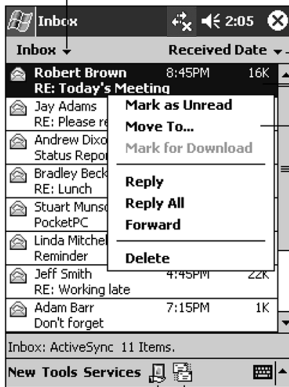

Select the sort order for messages.

Tap to open a message.

Press and hold to display a pop-up menu of actions.

Tap to connect, and to send and receive e-mail.

Tap to connect to the selected Internet Service Provider.

When you receive a message, tap it to open it. Unread messages are displayed in bold.

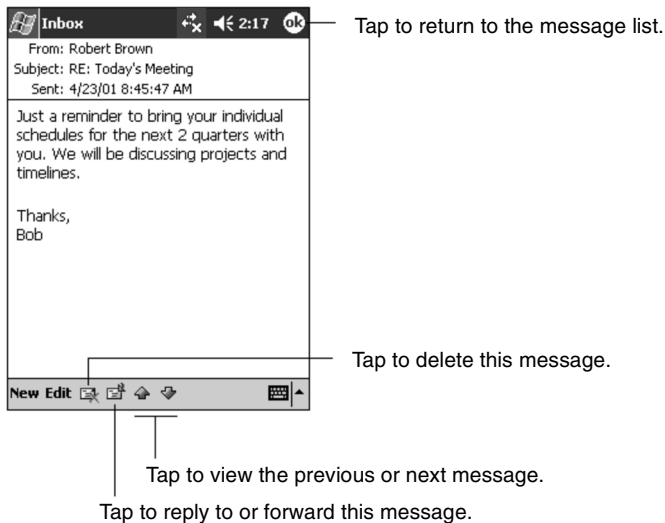

**IMPORTANT:** When you synchronize with your PC, by default, you will receive messages from the last three days only, the first 100 lines of each new message, and file attachments of less than 100 KB in size. The original messages remain on your PC.

To compose a message, do the following:

- 1 Tap **New**.
- 2 In the **To** field, enter an email of one or more recipients, separating them with a semicolon, or select a name from the contact list by tapping the **Address Book** button. All email addresses entered in the email fields in Contacts appear in the Address Book.

Tap to send the message.

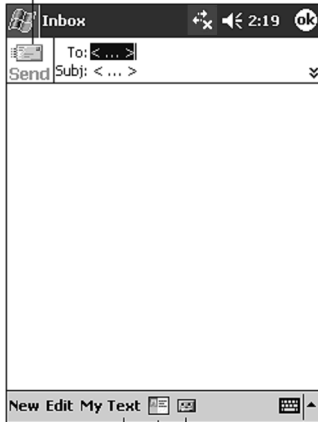

Tap to show or hide the complete header.

- Tap to show or hide the recording toolbar.
- Tap to display the Address Book.
- Tap to insert common (frequently used) messages.

- 3 Compose your message. To enter preset or frequently used messages, tap **My Text** and select a message.
- 4 Tap **Send** when you have finished the message. If you are working offline, the message is moved to the Outbox folder and is sent the next time you connect. The message is placed in the Outbox folder on your device.

## Managing Email Messages and Folders

By default, messages are displayed in one of five folders for each service you have created: Inbox, Deleted Items, Drafts, Outbox, and Sent Items. The Deleted Items folder contains messages that were deleted from the V38r.

The behavior of the Deleted and Sent Items folders depends on the options you have chosen. In the message list, tap **Tools** then tap **Options**. On the **Message** tab, select your options.

If you want to organize messages into additional sub-folders, tap **Tools**, then tap **Manage Folders** to create new folders. To move a message to another folder, in the message list, press and hold the message then tap **Move** on the pop-up menu.

# Chapter 6: Companion Programs

This chapter tells you about Microsoft Pocket Word and Microsoft Pocket Excel.

## Pocket Word

Microsoft Pocket Word works with Microsoft Word on your PC to give you easy access to copies of your documents. You can create new documents on your V38r or you can copy documents from your PC.

**IMPORTANT:** Synchronize documents between your PC and your V38r regularly so that you have the most up-to-date content in both locations.

## Using Pocket Word

- 1 On the **Start**, tap **Programs** and then tap the **Pocket Word** icon.
- 2 Type the name of a document in the file list or tap **New** to open a blank document.

**NOTE:** To open a template rather than a blank document, select a template for new documents. Tap on the **Tools** menu, tap **Options**, then browse to select the default template. When you tap **New**, the template appears with appropriate text and formatting already provided.

You can open only one document at a time; when you open a second document, you will be asked to save the first. You can save a document you create or edit in a variety of formats, including Pocket Word (.psw), Rich Text Format (.rtf), and Plain Text (.txt).

You can enter information in Pocket Word in four modes: writing, drawing, typing, and recording. Use the **View** menu to switch between modes. Each mode has its own toolbar which you can show or hide by tapping the **Show/Hide Toolbar** button on the Command bar.

- **Typing Mode.** Use the Input panel to enter typed text into the document with the soft keyboard. For more information on entering typed text, see "Entering Information" in Chapter 2.

- **Writing Mode.** In writing mode, use your stylus to write directly on the screen. Ruled lines are displayed as a guide, and the zoom magnification is greater than in typing mode to allow you to write more easily. For more information on writing and selecting writing, see “Entering Information” in Chapter 2.

**NOTE:** Written words are converted to graphics (metafiles) when a Pocket Word document is converted to a Word document on your PC.

- **Drawing mode.** In drawing mode, use your stylus to draw on the screen. Gridlines appear as a guide. When you lift your stylus off the screen after the first stroke, you will see a drawing box indicating the boundaries of the drawing. Every subsequent stroke within or touching the drawing box becomes part of the drawing. For more information on drawing and selecting drawings, see “Entering Information” in Chapter 2.
- **Recording mode.** Use recording mode to embed a recording into your document. Recordings are saved as WAV files. For more information on recording, see “Entering Information” in Chapter 2.

## Tips for Working in Pocket Word

- You can change the zoom magnification by tapping **View** and then tapping **Zoom**. Then select the percentage you want. Select a higher percentage to enter text and a lower one to see more of your document.
- If you are opening a Word document created on a PC, select **Wrap to Window** on the **View** menu so that you can see the entire document.

## Pocket Excel

Microsoft Pocket Excel works with Microsoft Excel on your PC to give you easy access to copies of your workbooks. You can create new workbooks in your V38r, or you can copy workbooks from your PC to your V38r. Synchronize workbooks between your PC and your V38r so that you have the most up-to-date content in both locations. Pocket Excel provides fundamental spreadsheet tools, such as formulas, functions, sorting, and filtering, which enable you to create simple workbooks, such as expense reports and mileage logs.



- 1 On the **Start** menu, tap **Programs** and then tap the **Pocket Excel** icon.
- 2 Tap the name of a workbook in the file list or tap **New** to open a blank workbook.

You can open only one workbook at a time; when you open a second workbook, you will be asked to save the first. You can save a workbook you have created or edit in a variety of formats, including Pocket Excel (.pxl) and Excel (.xls).

## Tips for Working in Pocket Excel

- View in full-screen mode to see as much of your worksheet as possible. Tap **View** and then tap **Full Screen**. To exit full-screen mode, tap **Restore**.
- If your workbook contains sensitive information, you can protect it with a password. To do so, open the workbook, tap **Edit**, and then tap **Password**.
- Show or hide window elements. Tap **View**, then tap the elements you want to show or hide.
- Freeze panes on a worksheet. First, select the cell where you want to freeze panes. Tap **View** and then tap **Freeze Panes**. You might want to freeze the top and furthest left panes in a worksheet to keep row and column labels visible as you scroll through a sheet.
- Split panes to view different areas of a large worksheet. Tap **View** and then tap **Split**. Then drag the split bar to where you want it. To remove the split, tap **View** and then tap **Remove Split**.
- Show and hide rows and columns. To hide a row or column, select a cell in the row or column you want to hide, tap **Format**, tap **Column**, then tap **Hide**. To show a hidden row or column, tap **Tools**, tap **Go To**, then type a reference that is in the hidden row or column. Tap **Format**, then tap **Row** or **Column**, then tap **Unhide**.

# Windows Media Player for Rugged Handheld

Use Microsoft Windows Media Player for V38r to play digital audio and video files that are stored on your V38r or on a network. To switch to Windows Media Player for V38r, tap  and tap **Windows Media**.

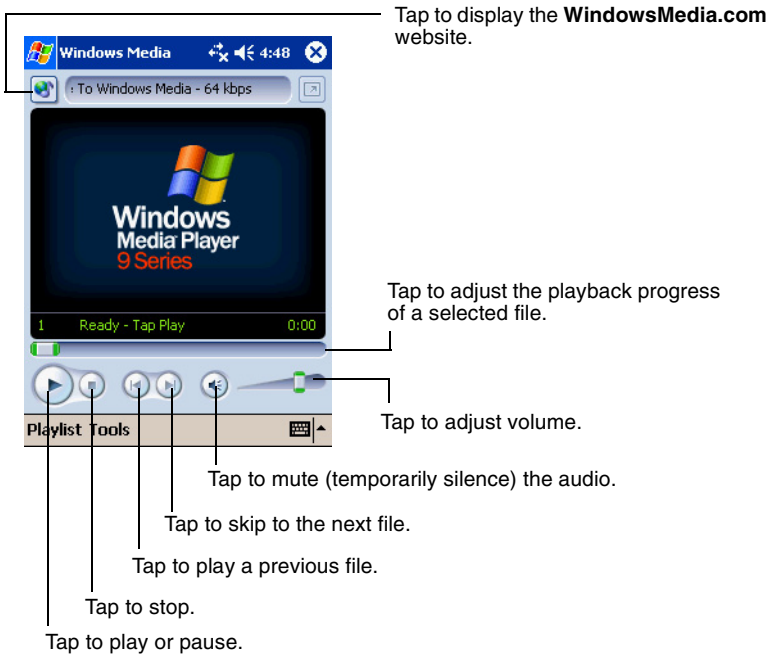

Use Microsoft Windows Media Player on your PC to copy digital audio and video files to your V38r. You can play Windows Media and MP3 files on your V38r.

For more information about using Windows Media Player, tap , then tap **Help**.

# Microsoft Reader

Use Microsoft Reader to read eBooks on your V38r. Download books to your PC from your favorite eBook Web site. Use ActiveSync to copy the book files to your activated V38r. The books appear in the Reader Library, where you can tap them in the list to open them.

**NOTE:** Before you can use Microsoft Reader, you must activate it from the Microsoft activation site (<http://das.microsoft.com/activate>). Follow the directions given at the Microsoft site.

Each book consists of a cover page, an optional table of contents, and the pages of the book. You can:

- Page through the book by using the scroll dial on your V38r or by tapping the page number on each page.
- Annotate the book with highlighting, bookmarks, notes, and drawings.
- Search for text or look up definitions for words.

The Guidebook contains all the information you need to use the software. To open the Guidebook, tap **Help** on the Reader command bar. Or, on a book page, press and hold on the book title, and then tap **Help** on the pop-up menu.

To switch to Microsoft Reader, tap , tap **Programs**, then tap **Microsoft Reader**.

## Getting Books onto Your V38r

You can download book files from the Web. Just visit your favorite eBook retailer and follow the instructions to download the book files.

Sample books and a dictionary are also included in the MSReader folder on the Companion CD.

Use ActiveSync to download the files from your PC to your activated V38r as described in the Read Me file in the MSReader folder.

## Using the Library

The Library is your Reader home page. The home page displays a list of all books stored on your V38r or storage card.

To open the Library:

- On the Reader command bar, tap **Library**.
- On a book page, tap the book title, and tap **Library**, on the pop-up menu.

To open a book, tap its title in the Library list.

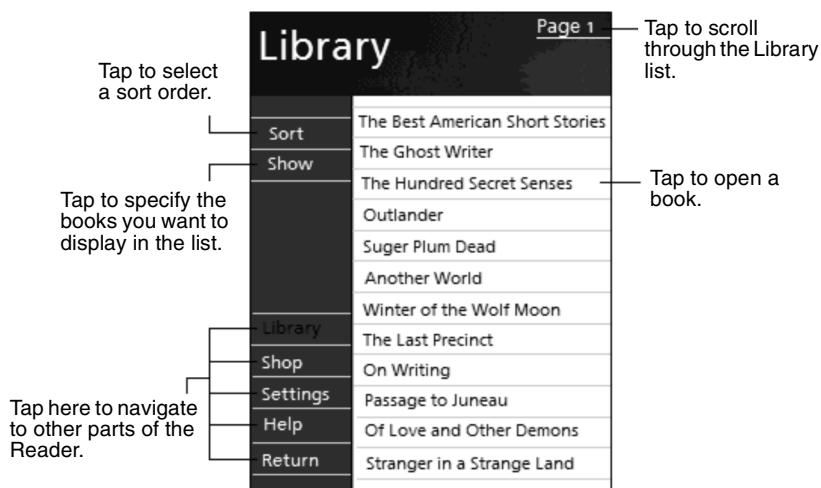

# Reading a Book

Each book consists of a cover page, an optional table of contents, and the pages of the book. Navigation options are listed in the bottom portion of the cover page.

The first time you open a book, you will probably want to go to the first page or to the table of contents, if there is one. Subsequently, whenever you open the book, you automatically go to the last page read.

In addition to the text, each book page includes a page number and book title.

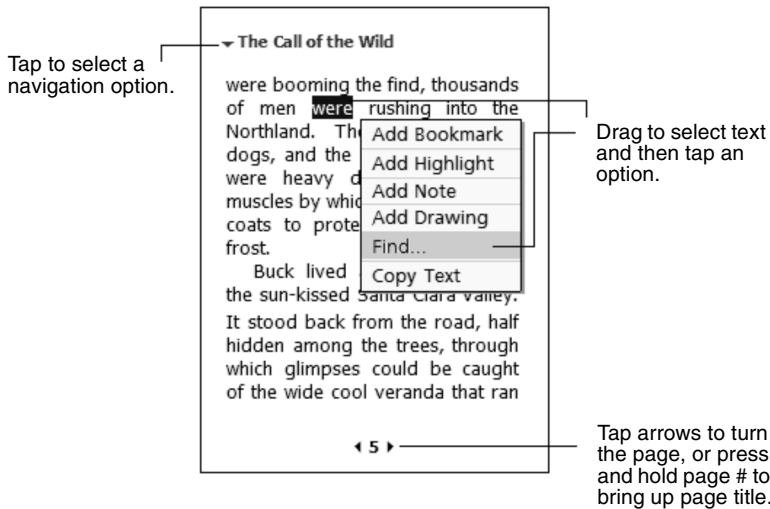

You can also page through a book by using the scroll dial on your V38r.

## Using Reader Features

Reading a book electronically gives you several options not available with paper books. These options are available from any book page.

Select text by dragging across the text on the page. Then, tap an option on the pop-up menu, as described here.

- **Search for Text.** Find text in a book by tapping **Find** on the pop-up menu. Enter the word you want to search for, and tap the desired Find option. Reader highlights found text on the page. To close Find, tap outside the box. To return to your original page, tap the title, then tap **Return** on the pop-up menu.
- **Copy Text.** You can copy text from books that support this feature into any program that accepts text. On a book page, select the text you want to copy. Then, tap **Copy Text** on the pop-up menu. The text can be pasted into the program of your choice.
- **Bookmarks.** When you add a bookmark to a book, a color-coded bookmark icon appears in the right margin. You can add multiple bookmarks to a book. Then, from anywhere in the book, tap the bookmark icon to go to the bookmarked page.
- **Highlights.** When you highlight text, it appears with a colored background.
- **Notes.** When you attach a note to text, you enter the text in a note pad that appears on top of the book page. A Note icon displays in the left margin. To show or hide the note, tap the icon.
- **Drawings.** When you add a drawing, a Drawing icon appears in the bottom-left corner of the page and drawing tools appear across the bottom of the page. Draw by dragging your stylus.

**NOTE:** To see a list of a book's annotations, including bookmarks, highlights, text notes, and drawings, tap **Annotations Index** on the book's cover page. You can tap an entry in the list to go to the annotated page.

## Removing a Book

When you finish reading a book, you can delete it to conserve space on your V38r. If a copy of the book is stored on your PC, you can download it again at any time.

To remove a book from your V38r, press and hold the title in the Library list, and then tap **Delete** on the pop-up menu.

## Other Programs

The following programs are permanently installed in your V38r:

Program	How to Access the Program
<b>Infrared Receiver</b>	On the <b>Start</b> menu, tap <b>Programs</b> and then tap the <b>Infrared Receive</b> icon. Infrared Receive establishes the connection between your V38r and the IR device.
<b>Terminal Services</b>	On the <b>Start</b> menu, tap <b>Programs</b> and then tap the <b>Terminal Services</b> icon. Terminal Services allows you to access the programs and documents in a Windows NT server type PC that is running Terminal Services.
<b>Backup</b>	To determine if your company has registered your device with the V38r web service and has any software download ready for you, you can run the RDMUpdate.exe file on your V38r. On the <b>Start</b> menu, tap <b>Programs</b> and then tap the <b>Backup</b> icon. Backup enables you to back up all data stored in the internal (RAM) memory on your V38r. For more information, see section "Backing up Data" in this guide.

# Chapter 7: Pocket Internet Explorer

This chapter tells you about Microsoft Pocket Internet Explorer, Mobile Favorites Folder and AvantGo Channels.

## Using Pocket Internet Explorer

Use Microsoft Pocket Internet Explorer to view Web pages by doing the following:

- During synchronization with your PC, download your favorite links and mobile favorites that are stored in the Mobile Favorites subfolder in Internet Explorer on the PC.

To start Pocket Internet Explorer:

- On the **Start** menu, tap **Internet Explorer**. The Pocket Internet Explorer home page:

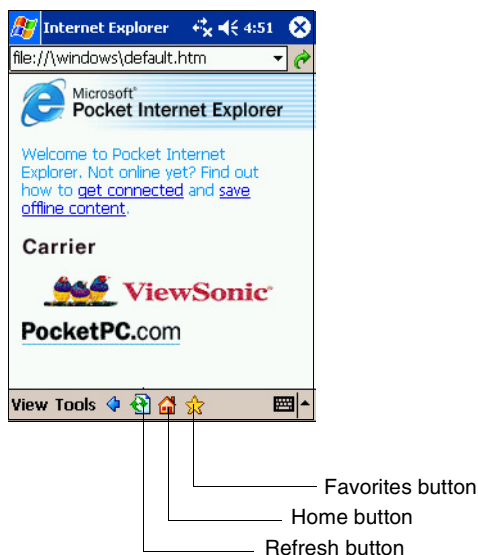



## Viewing Mobile Favorites and Channels

- 1 Tap the **Favorites** button to display your list of favorites.
- 2 In the list, tap the page you want to view.

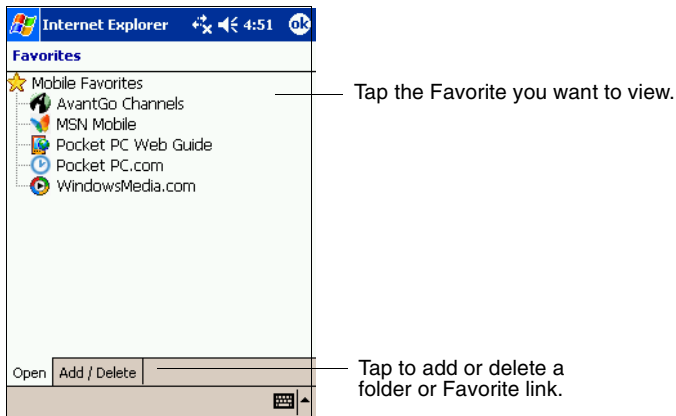

You will see the page that was downloaded the last time you synchronized with your PC. If the page is not on your V38r, it will be dimmed in the Favorites list. You will need to synchronize with your PC again to download the page to your V38r, or connect to the Internet to view the page.

## Browsing the Internet

To connect and start browsing, do one of the following:

- Tap the **Favorites** button, and then tap the favorite you want to view.
- Tap **View**, and then tap **Address Bar**. In the address bar that appears at the top of the screen, enter the Web address you want to visit and then tap **Go**. Tap the arrow to choose from previously entered addresses.

# The Mobile Favorites Folder

Only items stored in the Mobile Favorites subfolder in the Favorites folder in Internet Explorer on your PC will be synchronized with your Rugged Handheld. This folder is created automatically when you install ActiveSync.

## Favorite Links

During synchronization, the list of favorite links in the Mobile Favorites folder on your PC is synchronized with Pocket Internet Explorer on your V38r. Both computers are updated with changes made to either list each time you synchronize. Unless you mark the favorite link as a mobile favorite, only the link (and not the page) will be downloaded to your V38r, and you must connect to your ISP or network to view the content. For more information on synchronization, see ActiveSync Help on your PC.

## Mobile Favorites

If you are using Microsoft Internet Explorer 5 or later on your PC, you can download mobile favorites to your V38r. When you synchronize your PC and V38r, the content of your mobile favorites is downloaded to your V38r so that you can view pages while you are not connected to your ISP or your network.

Use the Internet Explorer plug-in installed with ActiveSync to create mobile favorites quickly.

To create a mobile favorite:

- 1 In Internet Explorer on your PC, click **Tools**, and then click **Create**.
  - To change the link name, enter a new name in the Name box.
  - To change how often the mobile favorite is updated, select a desired update schedule under **Update**.
- 2 Click **OK**. Internet Explorer downloads the latest version of the page to your PC.
- 3 If you want to download the pages that are linked to the mobile favorite you just created, right-click the mobile favorite and then click **Properties**. On the **Download** tab, specify the number of links deep you want to download. To

conserve memory on your V38r, download only one level of links.

- 4 Synchronize your V38r and PC. Mobile favorites that are stored in the Mobile Favorites folder in Internet Explorer are downloaded to your V38r.

**NOTE:** If you do not specify an updated schedule, you must manually download content to keep the information updated on your PC and V38r. Before synchronizing in Internet Explorer or your PC, click **Synchronize** on the **Tools** menu. You will see the last time content was downloaded to your PC, and you can manually download if needed.

**NOTE:** You can add a button to the Internet Explorer toolbar for creating mobile favorites. In Internet Explorer on your PC, on the **View** menu, click **Toolbars**, and then click **Customize**.

## Conserving Memory

Mobile favorites take up storage memory on your V38r. Follow these tips to minimize the amount of memory used:

- Use ActiveSync settings to turn off pictures and sounds for the Mobile Favorites information type or to stop some mobile favorites from being downloaded to your V38r. For more information, see ActiveSync Help.
- Limit the number of downloaded linked pages. In Internet Explorer on the PC, right-click the mobile favorite you want to change, and then click **Properties**. On the **Download** tab, specify 0 or 1 for the number of linked pages you want to download.

# Using AvantGo Channels

AvantGo is a free interactive service that gives you access to personalized content and thousands of popular Web sites. You subscribe to AvantGo channels directly from your V38r. Then you synchronize your V38r with your PC or connect to the Internet to download the content. For more information, visit the **AvantGo** Web site:

**[http://www.avantgo.com/frontdoor/learn\\_more.html](http://www.avantgo.com/frontdoor/learn_more.html)**

To sign up for AvantGo:

- 1 In ActiveSync options on the PC, turn on synchronization for the AvantGo information type.
- 2 In Pocket Internet Explorer on your V38r, tap the **Favorites** button to display your list of favorites.
- 3 Tap the **AvantGo Channels** link.
- 4 Tap the **Activate** button.
- 5 Follow the directions on the screen. You will need to synchronize your V38r with your PC, and then tap the **My Channels** button to complete the AvantGo setup.

When synchronization is complete, tap the **AvantGo Channels** link in your list of favorites to see a few of the most popular channels. To add or remove channels, tap the **Add** or **Remove** link.

# Chapter 8: Getting Connected

This chapter explains how to connect your **V38r** to the Internet or to a network using a wireless connection. This chapter also explains how to connect with other mobile devices or to your PC using an infrared (IR) connection.

## Connecting to a Network or the Internet

You will need a Network Encryption key from your IT Administrator for this procedure.

- 1 Click **Start** > click **Settings** > click the **System** tab at the bottom of the screen > **VBC Utility** > click **YES** to enable the Wireless Card.
- 2 Wait for the list of wireless **APs (Access Point)** to appear. If you do not see the AP that you want, click **Settings**. Select the **AP** that is available.
- 3 The **Network Key** screen appears. Enter the web encryption from your Administrator. Click the **Network Key** tab.
- 4 Clear the box next to "**The key is provided for me automatically.**" Then, enter your network key in the network key field.
- 5 Click **OK** at the top of the screen. Wait a few seconds till you see the symbol at the top of the screen that looks like a beacon as shown on the right to indicate the status. Also, notice the status bar at the bottom of the screen.



## Using an Infrared Connection

An infrared (IR) connection will allow you use your V38r to exchange information (such as contacts and appointments) with other mobile devices as well as your PC. (For more information, see “**Using Microsoft ActiveSync**” in Chapter 4.)

Use the infrared (IR) port on the V38r to exchange (send/receive) files with another mobile device.

### Sending Information

- 1 Switch to the program in which you created the item you want to send, then locate the item in the list.
- 2 Align the IR ports so that they are unobstructed and within a close range.

**CAUTION:** If the devices are too far apart or if something blocks the path between the two ports, data might not be sent or received correctly.

- 3 Press and hold the item, then tap **Beam Item** on the pop-up menu.

**NOTE:** You can also send items, but not folders, from File Explorer. Press and hold the item you want to send, then tap **Beam File** on the pop-up menu.

### Receiving Information

- 1 Align the IR ports so that they are unobstructed and within a close range.
- 2 Tap , tap **Programs**, then tap **Infrared Receive**.
- 3 Have the owner of the other device send the information to you. Your **V38r** will automatically receive it.

# Chapter 9: Troubleshooting and Maintenance

This chapter gives solutions to common V38r problems you may encounter when using the device. It also provides guidelines on taking care of your V38r.

**NOTE:** If you encounter a problem you cannot solve, contact your reseller or ViewSonic Customer Support. See the "Customer Support" section at the end of this chapter.

## Reset the V38r

**CAUTION:** *You lose all customization in DRAM (like files, programs, and settings) with a Cold or Warm reset. As a precaution, before removing the battery, we recommend that you drag any changed files that you want to protect to the device's **Permanent Storage** folder.*

### Cold Reset

If your **V38r** locks up or does not respond to the stylus, remove the main battery. Open and remove the back cover by turning the latch as shown on page 9. Then take out the battery.

### Warm Reset

A warm reset may be required on rare occasions where your V38r completely locks up. To do a warm reset, press and hold both the **POWER BUTTON** and the **HOME** button for four (4) seconds.

### Firmware Image Upgrade

From time to time ViewSonic may offer a firmware image upgrade for V38r hardware users. For current information visit our web site at [viewsonic.com](http://viewsonic.com) or check with your IT Administrator.

# Restoring Factory Defaults

In some cases, you may need to restore your V38r to the factory default settings by clearing the memory (RAM) from your V38r like when the following happens.

- When your V38r does not respond after being reset.
- When you forget your password.

Clearing the memory means all data you have entered in RAM, including all files, system settings, and additional programs you have installed, will be erased. (Programs installed to ROM at the factory are not affected.)

## CAUTION:

- **To ensure the integrity of your data if it becomes necessary to clear the memory, you are advised to regularly back up to your PC (using ActiveSync), or to an optional SD card (using the backup application). For more information on backing up data, see the "Backing Up Data" section in this guide.**
- **Do not remove the battery unless it is necessary. If you remove the battery door, all data is lost.**

To clear the memory from your V38r:

- 1 Disconnect all cables, including the AC adapter, from your **V38r**.
- 2 To clear memory, do a hard reset on the back of the unit and remove the main and backup battery. For more information, see the section **Reset the V38r** in this guide.

**IMPORTANT:** If the battery runs completely out of power and is not re-charged in time, the memory of your V38r will be cleared.



# Power Problems

## **Power does not turn on when using battery power**

- The remaining battery power may be too low to run your V38r. Connect the AC adapter to your V38r and to external AC power. Then, turn on your V38r. (Charge the battery whenever possible to avoid running out of battery power and thus losing data.)





## **Battery runs out of power quickly**

- You might be using your V38r in ways that drain power quickly. For more information, see the section "Managing Power" in this guide for tips on saving power.

# Memory Problems

If a warning message of not enough memory appears due to a memory allocation problem, try the following to free memory on your V38r.

**CAUTION: Be discreet when you delete files. Deleting files of which the function is unknown can cause programs or features to malfunction. It is recommended that you create a backup before deleting files.**

- Delete files you no longer need. Tap , **Programs**, and then **File Explorer**. Press and hold the file you wish to delete, then tap **Delete** on the pop-up menu. To find your largest files, tap  then **Find**. In the **Type** list, tap **Larger than 64KB**, then tap **Go**.
- Remove programs you no longer need. Tap , and then **Settings**. Tap **System** tab, then tap **Remove Programs**. Tap the program you want to remove then tap **Remove**.
- In Internet Explorer options, delete all files then clear history. In Internet Explorer, tap **Tools** then **Options**. Tap **Delete Files** then **Clear History**.
- If you are copying files from a computer or other device to your V38r, try adjusting the slider in the Memory setting. Tap  then **Settings**. Tap **System** tab, then tap **Memory**. Check to see if you can manually move the slider before copying files.

Stop programs you are not currently using. In most cases, programs automatically stop to free needed memory. However, in some situations, such as when confirmation dialog boxes are waiting for a user response, the program may not be able to automatically stop. To check the state of your active programs, tap  then **Settings**. Tap **System** tab, tap **Memory**, then **Running Programs**. Tap the program you want to view then tap **Activate**. Close any open windows or messages and return the program to list view. If this does not work, you can stop the program manually. First, make sure that your work is saved by closing open items and return the program to list view. Then, stop the program by tapping **Stop** or **Stop All** on the **Running Programs** tab.

Reset your V38r as described earlier in this chapter.

**If you have an SD card, move data to the SD card as follows:**

- Tap , **Programs**, then **File Explorer**. Press and hold the file you want to move, then tap **Cut**. Browse to My Documents folder in the SD card folder, tap **Edit**, then **Paste**. Files stored in folders other than My Documents or stored in subfolders within subfolders in My Documents may not show up in the list view of some programs. When using Notes, Pocket Word, or Pocket Excel, you can also move files by opening the item then tapping **Tools** or **Edit** then **Rename/Move**.

Files stored in folders other than My Documents or stored in subfolders within subfolders in My Documents may not show up in the list view of some programs. When using Notes, Pocket Word, or Pocket Excel, you can also move files by opening the item then tapping **Tools** or **Edit** then **Rename/Move**.

# Screen Problems

## Screen is off

If the screen does not respond, even after you press the power button, try the following until the problem is solved:

- Connect the AC adapter to your V38r and to external AC power, then
- Reset your V38r as described in "Resetting Your V38r" earlier in this chapter.

## Screen responds slowly

- Make sure that your V38r is not running out of battery power or running many active programs. If the problem still exists, reset your V38r as described in "Resetting Your V38r" earlier in this chapter.

## Screen freezes

- Reset your V38r as described in "Resetting Your V38r" earlier in this chapter.

## Screen is hard to read

- Make sure that the backlight of the display is on.
- Move to a location with enough light.
- If you are having a hard time reading a document on the screen, try adjusting the zoom percentage or text size.
  - In Notes, tap **Tools**, then select a zoom percentage.
  - In Pocket Word and Pocket Excel, tap **View**, tap **Zoom**, then select a zoom Percentage.
  - In Pocket Internet Explorer, tap **View**, tap **Text Size**, then select a size.
  - In Calendar, Contacts, and Tasks, tap **Tools**, tap **Options**, then select **Use large font**.

## Inaccurate response to stylus taps

Realign the touch screen. Tap , then tap **Settings**. Tap **System** tab, then tap **Align Screen**. If you cannot realign the touch screen, turn off the V38r. Press and hold the scroll dial, then press the power button to turn on the V38r. You should now be able to start the touch screen alignment process.

# V38r Connection Problems

## USB Dock/Cradle Connection Problems

- Make sure that you installed the correct version of **ActiveSync** on your desktop PC. Install the version **ActiveSync** included with your **V38r**.
- Make sure that your V38r and your desktop PC are turned on.
- Make sure that you do not have any other active connections.
- When using the USB cradle, make sure that your V38r is properly seated.
- Make sure that the cable is securely plugged into the USB port on your desktop PC. Connect the USB cable directly to your desktop PC — do not run the cable through a USB hub.
- Make sure that the USB connection is enabled in ActiveSync on your desktop PC. If the USB connection is already enabled, disable the USB connection, close the Connection Settings window, and then reopen and re-enable the USB connection.
- Reset your V38r before connecting the USB cable. (See “Resetting Your V38r” earlier in this chapter.) Always disconnect your V38r before you restart your desktop PC.
- Connect only one V38r or personal digital assistant to your desktop PC at a time.

## Infrared Connection Problems

- Transfer only one file, or no more than 25 contact cards, at a time.
- Position the IR ports so that they line up at a distance less than 20 cm (8 inches) but more than 5 cm (2 inches) apart.
- Make sure that there are no obstacles between the two IR ports.
- Adjust the room lighting. Some types of light interfere with IR communications. Try moving to a different location or turning off some lights.

# Care and Maintenance

Taking good care of your V38r will ensure trouble-free operation and reduce the risk of damage to your V38r.

## General Guidelines

- Keep your V38r away from excessive moisture and extreme temperatures.
- Avoid exposing your V38r to direct sunlight or strong ultraviolet light for extended periods of time.
- Do not place anything on top of your V38r as this may damage the display.
- Do not drop your V38r.
- Store your V38r in a protective case when not in use.
- The screen surface is easily scratched. Use only the stylus to tap on the screen. Avoid touching it with your fingers, pens, or pencils.
- Never clean your V38r with the power on. Use a soft, lint-free cloth moistened with water to wipe the screen and the exterior of your V38r.
- Never use paper towels to clean the screen.

## Travel Guidelines

- Before traveling with your V38r, back up your data. As an added precaution, bring along a backup copy.
- Turn off your V38r and disconnect all external devices.
- Make sure that the battery is fully charged.
- Take the AC adapter with you. Use the AC adapter as the power source and as a battery-recharger.
- Hand-carry your V38r in a protective case.
- Consult the airlines first before using your V38r on the plane. You need to be very careful when using electronic devices during the flight.
- If you plan to travel abroad with your V38r, consult your dealer for the appropriate AC adapter for use in your country of destination.

# Customer Support

For technical support or product service, see the table below or contact your reseller.

## IMPORTANT:

- **You will need to provide the product serial number (on the back of the V38r).**
- **Before sending the V38r out for service, be sure to back up all data and remove all third party software. See the Data Loss Disclaimer in the Appendix**

Country/Region	Website / Email	T = Telephone F = FAX
United States	<a href="http://www.viewsonic.com/support">www.viewsonic.com/support</a> <a href="mailto:vstech@viewsonic.com">vstech@viewsonic.com</a>	<b>T:</b> (800) 688-6688 <b>F:</b> (909) 468-1202
Canada	<a href="http://www.viewsonic.com/support">www.viewsonic.com/support</a> <a href="mailto:vstech@viewsonic.com">vstech@viewsonic.com</a>	<b>T:</b> (800) 688-6688 <b>F:</b> (909) 468-1202

## **Chapter 10: Appendix**

### **Regulatory and Safety Information**

#### **USA**

This equipment has been tested and found to comply with the limits for a Class B digital device, pursuant to Part 15 of the FCC Rules. These limits are designed to provide reasonable protection against harmful interference in a residential installation. This equipment generates, uses and can radiated radio frequency energy and, if not installed and used in accordance with the instructions, may cause harmful interference to radio communications. However, there is no guarantee that interference will not occur in a particular installation. If this equipment does cause harmful interference to radio or television reception, which can be determined by turning the equipment off and on, the user is encouraged to try to correct the interference by one or more of the following measures:

- Reorient or relocate the receiving antenna.
- Increase the separation between the equipment and receiver.
- Connect the equipment into an outlet on a circuit different from that to which the receiver is connected.
- Consult the dealer or an experienced radio/TV technician for help.

Changes or modifications not expressly approved by the party responsible for compliance could void the user's authority to operate the equipment.

This device and its antenna(s) must not be co-located or operating in conjunction with any other antenna or transmitter.

This EUT is compliance with SAR for general population /uncontrolled exposure limits in ANSI/IEEE C95.1-1999 and had been tested in accordance with the measurement methods and procedures specified in OET Bulletin 65 Supplement C.

This equipment complies with FCC radiation exposure limits set forth for an uncontrolled environment. In order to avoid the possibility of exceeding the FCC radio frequency exposure limits, human proximity to the antenna shall not be less than 1.5cm during normal operation.

#### **Canada**

This Class B digital apparatus meets all requirements of the Canada Interference-Causing equipment regulations.

Cet appareil numérique de Classe B respecte toutes les exigences du Règlement Canadien sur le matériel brouilleur.



## European Regulatory Notice

Products with the **CE** mark comply with both the Electromagnetic Compatibility Directive (89/336/EEC) and the Low Voltage Directive (73/23/EEC) - as mandated by Directive 93/68/ECC - issued by the Commission of the European Community.

Compliance with these directives implies conformity to the following European standards:

<b>EN55022:</b>	<b>Radio disturbance characteristics</b>
<b>EN55024:</b>	<b>Immunity characteristics</b>
<b>EN6100-3-2:</b>	<b>Limits for harmonic current emissions</b>
<b>EN6100-3-3:</b>	<b>Limitation of voltage fluctuation and flicker in low-voltage supply system</b>
<b>EN60950:</b>	<b>Product Safety</b>

## Battery Replacement

The device has two batteries: one is under the back cover as shown on page 9. The other battery is a Lithium Ion battery inside the device. The Lithium Ion battery maintains system configuration information.

If the device does not maintain system configuration, **do not attempt to replace the internal Lithium Ion battery yourself.** Doing so may void the warranty. This battery can only be replaced by authorized ViewSonic technician. Contact **ViewSonic** for service contact information. See the Specifications in this guide for part numbers.

## About the AC Adapter

**CAUTION:** Only use the AC adapter (Achme/AM138B05S07) supplied with your Rugged Handheld V38r. Using another type of AC adapter will result in malfunction and/or danger.

**IMPORTANT:** This product is intended to be supplied with a Listed Power Unit marked "LPS" and output rated 5V/3A.

The AC adapter is designed to ensure your personal safety and to be compatible with this equipment. Please follow these guidelines:

- Do not use the adapter in a high moisture environment. Never touch the adapter when your hands or feet are wet.
- Allow adequate ventilation around the adapter. Avoid locations with restricted airflow.
- Connect the adapter to a proper power source. The voltage and grounding requirements are found on the product case and/or packaging.
- Do not use the adapter if the cord becomes damaged.
- Do not attempt to service the unit. There are no serviceable parts inside. Replace the unit if it is damaged or exposed to excess moisture.

## About Electrostatic Discharge

### Electrostatic Discharge Warning

Electrostatic discharges can interfere with the normal functioning of electronic devices. Your Rugged Handheld can behave abnormally owing to such an event, resulting in the possible data corruption or loss of unsaved data. To recover from this, reset your Rugged Handheld as described in this User Guide.

**NOTE:** To avoid losing data due to electrostatic discharges or other types of events, it is recommended that you regularly save and backup data as described in this User Guide.

# Optional Accessories

## The Dock/Cradle

The optional V38r dock/cradle permits easy connectivity to external USB devices, AC power, multi-pack charging, and serial communications. To use the cradle, plug the cradle into AC power and place the V38r in the cradle. **IMPORTANT:** When mounted in the cradle, the V38r's external USB port become inactive.

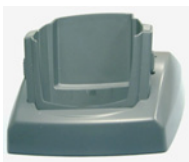

Optional dock/  
cradle



V38r mounted  
in the dock

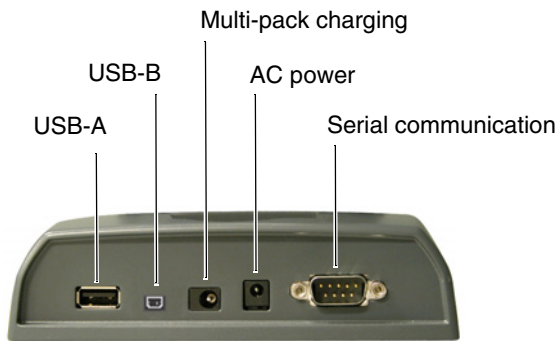

Back of dock/cradle

# Commercially Available Accessories

## External USB Keyboard and Mouse

You can attach a USB external keyboard or mouse to the cradle's USB-A port or the communication dongle.

# Limited Warranty

## Rugged Handheld Products

### What the warranty covers:

ViewSonic® warrants its Rugged Handheld products to be free from defects in material and workmanship during the warranty period. If a Rugged Handheld product proves to be defective in material or workmanship during the warranty period, ViewSonic will, at its sole option, repair or replace the product with a like product. Replacement product or parts may include remanufactured or refurbished parts or components. ViewSonic provides no warranty for the third party software included with the product. For specific warranty information, please see the EULAs included with the product. ViewSonic does not warrant that software will meet your requirements or that operation of software will be uninterrupted or error free. VIEWSONIC AND ITS SUPPLIERS DISCLAIM ALL WARRANTIES AND CONDITIONS, EITHER EXPRESS OR IMPLIED, INCLUDING, BUT NOT LIMITED TO, IMPLIED WARRANTIES OF MERCHANTABILITY, FITNESS FOR A PARTICULAR PURPOSE, AND NON-INFRINGEMENT.

### How long the warranty is effective:\*

ViewSonic Rugged Handhelds are warranted for one (1) year for all parts (except software) and one (1) year for all labor from the date of the first consumer purchase.

### Who the warranty protects:

This warranty is valid only for the first consumer purchaser.

### What the warranty does not cover:

1. Software
2. Any product on which the serial number has been defaced, modified or removed.
3. Damage, deterioration or malfunction resulting from:
  - a. Accident, misuse, neglect, fire, water, lightning, or other acts of nature, unauthorized product modification, or failure to follow instructions supplied with the product.
  - b. Repair or attempted repair by anyone not authorized by ViewSonic.
  - c. Damage to or loss of any programs, data or removable storage media.
  - d. Software or data loss occurring during repair or replacement.
  - e. Any damage of the product due to shipment.
  - f. Removal or installation of the product.
  - g. Causes external to the product, such as electrical power fluctuations or failure.
  - h. Use of supplies or parts not meeting ViewSonic's specifications.
  - i. Normal wear and tear.
  - j. Any other cause which does not relate to a product defect.
4. Removal, installation, and set-up service charges.

### How to get service:

1. For information about receiving service under warranty, contact ViewSonic Customer Support. You will need to provide your product's serial number.
2. To obtain service under warranty, you will be required to provide (a) the original dated sales slip, (b) your name, (c) your address, (d) a description of the problem, and (e) the serial number of the product.
3. Take or ship the product freight prepaid in the original container to an authorized ViewSonic service center or ViewSonic.
4. For additional information or the name of the nearest ViewSonic service center, contact ViewSonic.

### Limitation of implied warranties:

THERE ARE NO WARRANTIES, EXPRESS OR IMPLIED, WHICH EXTEND BEYOND THE DESCRIPTION CONTAINED HEREIN INCLUDING THE IMPLIED WARRANTY OF MERCHANTABILITY AND FITNESS FOR A PARTICULAR PURPOSE.

### Exclusion of damages:

VIEWSONIC'S LIABILITY IS LIMITED TO THE COST OF REPAIR OR REPLACEMENT OF THE PRODUCT. VIEWSONIC SHALL NOT BE LIABLE FOR:

1. DAMAGE TO OTHER PROPERTY CAUSED BY ANY DEFECTS IN THE PRODUCT, DAMAGES BASED UPON INCONVENIENCE, LOSS OF USE OF THE PRODUCT, LOSS OF DATA, LOSS OF TIME, LOSS OF PROFITS, LOSS OF BUSINESS OPPORTUNITY, LOSS OF GOODWILL, INTERFERENCE WITH BUSINESS RELATIONSHIPS, OR OTHER COMMERCIAL LOSS, EVEN IF ADVISED OF THE POSSIBILITY OF SUCH DAMAGES.
2. ANY OTHER DAMAGES, WHETHER INCIDENTAL, CONSEQUENTIAL OR OTHERWISE.
3. ANY CLAIM AGAINST THE CUSTOMER BY ANY OTHER PARTY.

### Effect of state law:

This warranty gives you specific legal rights, and you may also have other rights which vary from state to state. Some states do not allow limitations on implied warranties and/or do not allow the exclusion of incidental or consequential damages, so the above limitations and exclusions may not apply to you.

### Sales outside the U.S.A. and Canada:

For warranty information and service on ViewSonic products sold outside of the U.S.A. and Canada, contact ViewSonic or your local ViewSonic dealer.

\* **For Europe:** This Limited Warranty is effective in Europe for two (2) years for all parts (except software) and two (2) years for all labor from the date of the first consumer purchase.

ViewSonic Rugged Handheld Warranty (V1.0)

Release Date: September 9, 2002

# Specifications

Processor	Intel® XScale® 416MHz CPU with 64MB flash	
OS	Microsoft® PPC2003 (included)	
Memory	64MB SDRAM (expandable to 128MB)	
Display	240x320 transfective TFT panel 256K colors (3.5" diagonal) Contrast Ratio: 5:1 (B/L off); 80:1 (B/L on) Brightness: Typical 90 nits (with touch panel)	
Touch Screen	4-wire resistive type Punch life: 1M cycles with 250g force, 2 times/sec Stroke life: 100K cycles with 250g force, repeat 1 inch Hardness: 3H	
SD Memory Slot	User accessible SD slot on the left side of unit	
Cradle	Support USB, and one serial RS232 port Part Number: CDLE-001	
Dimensions	145mm (L) x 83mm (W) x 32mm (H) 50mm (H) in the imager side	
Weight	<500g including battery pack and standard Expansion hatch cover, excluding Scanner engine and WWAN solution	
Communication	IrDA (SIR 115 kbps)	
Wireless Communication	WLAN 802.11b/g standard or Avalon RF link	
Integrated Antenna	For WLAN, BT and WWAN	
Batteries	Standard battery	3.7V, 1800mAh removal battery pack. Up to 3 hours life (depending on use and configuration) Part Number: BAT-001
	Extended battery-optional	3.7V, 3600mAh removable battery pack. Over 8 hours operation with full WLAN/BT connection
	Backup battery-internal	7.2V 40mAh Ni-MH ... <b>TBD</b> Part Number: BAT-002

Power Consumption	15 w total
Environment	Operation: 14° F - 113° F (-10° C - 45° C) non-condensing humidity, 0 - 3,000 meters  Storage: -4° F - 158° F (-20° C - 70° C), 10% - 85% non-condensing humidity, 0 - 12,000 meters
1-D Imager	1-D CCD Image engine
Fingerprint	Support Authentec AES3400
Miscellaneous	DC power jack; cradle, Internal Speaker, Mic, Stylus, Stylus Tether, protective front cover
Regulatory Approvals	FCC, UL, CE Mark and Radio Country Approvals: US/Canada, R&TTE
<i>Basic Software</i>	Windows PPC2003 Internet Explorer Windows Explorer Media Player MS WordPad Solitaire Microsoft ActiveSync  Microsoft Inbox Microsoft File Viewers MS Excel Viewer MS Image Viewer MS PDF Viewer MS PowerPoint Viewer MS Word Viewer
RF module option	Avalon RF Sub-system to support non-line of sight range is 4 miles with conditions
Echo cancelling option	Hardware echo cancelling for VoIP
HHP IT4010 option	2-D barcode engine for PDF417 decoding
Miscellaneous Part Numbers	Clip-001 AC Adapter—001

# Data Loss Disclaimer

Before sending the V38r out for service, be sure to backup all data and remove all third party software.

With respect to all service provided, it is your responsibility to backup the contents of your V38r, including any data you have stored or software you have installed on the V38r. It is likely that the contents of your V38r will be lost in the course of service and ViewSonic will not be responsible for any damage to or loss of any programs, data or other information stored on any media or any part of any Product serviced hereunder.

IF DURING THE REPAIR OF THE PRODUCT THE CONTENTS OF THE V38r ARE ALTERED, DELETED, OR IN ANY WAY MODIFIED, VIEWSONIC IS NOT RESPONSIBLE WHATSOEVER. YOUR PRODUCT WILL BE RETURNED TO YOU CONFIGURED AS ORIGINALLY PURCHASED (SUBJECT TO AVAILABILITY OF SOFTWARE).

Be sure to remove all third party hardware, software, features, parts, options, alterations, and attachments not warranted by ViewSonic prior to sending the product to ViewSonic for service. ViewSonic is not liable for any loss or damage to these items.



**ViewSonic Corporation**