

FCC TEST REPORT

CATEGORY : Portable
PRODUCT NAME : Pocket PC
FCC ID. : GSS-VS10418
FILING TYPE : Certification
BRAND NAME : ViewSonic
MODEL NAME : VS10418

APPLICANT : **ViewSonic Corporation**
381 Brea Canyon Rd., Walnut, CA. 91789, U.S.A

MANUFACTURER : **Universal Scientific Industrial Co., Ltd**
135, Lane 351, Taiping Road, Sec.1, Tsao Tune, Nan-Tou,
Taiwan

ISSUED BY : **SPORTON INTERNATIONAL INC.**
6F, No. 106, Sec. 1, Hsin Tai Wu Rd., His Chih, Taipei Hsien,
Taiwan, R.O.C.

Statements:

The test result in this report refers exclusively to the presented test model / sample.
Without written approval of SPORTON International Inc., the test report shall not be reproduced except in full.

Certificate or Test Report could not be used by the applicant to claim the product endorsement by CNLA and any agency of U.S. government.

The test equipment used to perform the test is calibrated and traceable to NML/ROC or NIST/USA.



1190
ILAC MRA



Table of Contents

HISTORY OF THIS TEST REPORT	II
CERTIFICATE OF COMPLIANCE.....	III
1. GENERAL DESCRIPTION OF EQUIPMENT UNDER TEST.....	1
1.1. Applicant	1
1.2. Manufacturer	1
1.3. Basic Description of Equipment under Test.....	1
1.4. Features of Equipment under Test	1
1.5. Antenna Description.....	2
1.6. Table for Carrier Frequencies.....	3
2. TEST CONFIGURATION OF THE EQUIPMENT UNDER TEST	4
2.1. Connection Diagram of Test System	4
2.2. The Test Mode Description.....	5
2.3. Description of Test Supporting Units	5
3. GENERAL INFORMATION OF TEST	6
3.1. Test Facility	6
3.2. Standards for Methods of Measurement.....	6
3.3. DoC Statement	6
3.4. Frequency Range Investigated	6
3.5. Test Distance	6
3.6. Test Software.....	6
4. LIST OF MEASUREMENTS	8
4.1. Summary of the Test Results.....	8
5. TEST RESULT	10
5.1. Test of 6dB Spectrum Bandwidth	10
5.2. Test of Maximum Peak Output Power (WLAN)	15
5.3. Test of Peak Power Spectral Density	17
5.4. Test of Hopping Channel Bandwidth	22
5.5. Test of Hopping Channel Separation.....	25
5.6. Test of Number of Hopping Frequency.....	28
5.7. Test of Test of Dwell Time of Each Frequency	30
5.8. Test of Maximum Peak Output Power (Bluetooth).....	36
5.9. Test of Band Edges Emission.....	38
5.10. Test of AC Power Line Conducted Emission.....	44
5.11. Test of Spurious Radiated Emission.....	55
5.12. Antenna Requirements	85
6. LIST OF MEASURING EQUIPMENTS USED.....	86
7. COMPANY PROFILE.....	88
7.1. Certificate of Accreditation	88
7.2. Test Location	88
8. CNLA CERTIFICATE OF ACCREDITATION	89
APPENDIX A. PHOTOGRAPHS OF EUT	A1 ~ A43



CERTIFICATE OF COMPLIANCE

with

47 CFR FCC Part 15 Subpart C

PRODUCT NAME : Pocket PC

BRAND NAME : ViewSonic

MODEL NAME : VS10418

APPLICANT : **ViewSonic Corporation**

381 Brea Canyon Rd., Walnut, CA. 91789, U.S.A

MANUFACTURER : **Universal Scientific Industrial Co., Ltd**

135, Lane 351, Taiping Road, Sec.1, Tsao Tunc, Nan-Tou,
Taiwan

I **HEREBY** CERTIFY THAT:

The measurements shown in this test report were made in accordance with the procedures given in ANSI C63.4-2003 and all test are performed according to 47 CFR FCC Part 15 Subpart C. Testing was carried out on Jan. 18, 2005 at SPORTON International Inc. LAB.

A handwritten signature in blue ink, appearing to read 'Alan Lane', is written over a horizontal line.

Dr. Alan Lane

Vice General Manager
Sporton International Inc.



1. General Description of Equipment under Test

1.1. Applicant

ViewSonic Corporation

381 Brea Canyon Rd., Walnut, CA. 91789, U.S.A

1.2. Manufacturer

Universal Scientific Industrial Co., Ltd

135, Lane 351, Taiping Road, Sec.1, Tsao Tunc, Nan-Tou, Taiwan

1.3. Basic Description of Equipment under Test

This product is an Pocket PC with WLAN 802.11b/g and Bluetooth function. The technical data has been listed on section " Features of Equipment under Test ". A cradle is also provided for battery charge and it offers an USB interface to make the EUT be able to communicate with the computer. Getting through the signal interface of the Pocket PC, the battery can be charged by the cradle. Accessories for RS232 or USB are available for connection with the computer. Two kinds of transmitters built in EUT. But there can't transmit at the same time.

1.4. Features of Equipment under Test

802.11b/g part

Items	Description
Type of Modulation	DSSS (CCK / DQPSK / DBPSK) OFDM (64QAM / 16QAM / DQPSK / DBPSK)
Number of Channels	11
Frequency Band	2412MHz ~ 2462 MHz
Carrier Frequency	See section 1.6 for details
Data Rate	1, 2, 5.5, 11 Mbps – DSSS 54, 48,36, 24,18,12, 6 Mbps - OFDM
Channel Bandwidth	15 MHz (DSSS), 18 MHz (802.11g)
Max. Conducted Output Power	DSSS : 15.70 dBm ; OFDM : 21.70 dBm
Antenna Type	See section 1.5 for details
Communication Type	Half-Duplex
Testing Duty Cycle	100.00%
Test Power Source	110.00V AC from Adaptor
Temperature Range (Operating)	-10 ~ 55 °C

Bluetooth part

Items	Description
Type of Modulation	GFSK
Number of Channels	79
Frequency Band	2402MHz ~ 2480MHz
Carrier Frequency	See section 1.6 for details
Data Rate	1Mbps
Channel Bandwidth	1MHz
Max. Conducted Output Power	-2.10 dBm
Antenna Type	See section 1.5 for details
Testing Duty Cycle	46.40%
Power Rating (DC/AC, Voltage)	5 VDC from 100~240 VAC power adapter
Adapter	5VDC , 12VDC adapter
Test Power Source	110.00V AC
Temperature Range (Operating)	-10 ~ 55 °C

PRODUCT NAME	MODEL NAME
Cradle	VS10418
Dongle	VS10418

1.5. Antenna Description

802.11b/g part

No.	Antenna Type	Gain (dBi)
1	PIFA Antenna	3.00

Bluetooth part

No.	Antenna Type	Gain (dBi)
1	CHIP Antenna	2.24



1.6. Table for Carrier Frequencies

802.11b/g part

Channel	Frequency	Channel	Frequency	Channel	Frequency	Channel	Frequency
01	2412 MHz	05	2432 MHz	09	2452 MHz	-	-
02	2417 MHz	06	2437 MHz	10	2457 MHz	-	-
03	2422 MHz	07	2442 MHz	11	2462 MHz	-	-
04	2427 MHz	08	2447 MHz	-	-	-	-

Bluetooth part

Channel	Frequency	Channel	Frequency	Channel	Frequency	Channel	Frequency
00	2402 MHz	20	2422 MHz	40	2442 MHz	60	2462 MHz
01	2403 MHz	21	2423 MHz	41	2443 MHz	61	2463 MHz
02	2404 MHz	22	2424 MHz	42	2444 MHz	62	2464 MHz
03	2405 MHz	23	2425 MHz	43	2445 MHz	63	2465 MHz
04	2406 MHz	24	2426 MHz	44	2446 MHz	64	2466 MHz
05	2407 MHz	25	2427 MHz	45	2447 MHz	65	2467 MHz
06	2408 MHz	26	2428 MHz	46	2448 MHz	66	2468 MHz
07	2409 MHz	27	2429 MHz	47	2449 MHz	67	2469 MHz
08	2410 MHz	28	2430 MHz	48	2450 MHz	68	2470 MHz
09	2411 MHz	29	2431 MHz	49	2451 MHz	69	2471 MHz
10	2412 MHz	30	2432 MHz	50	2452 MHz	70	2472 MHz
11	2413 MHz	31	2433 MHz	51	2453 MHz	71	2473 MHz
12	2414 MHz	32	2434 MHz	52	2454 MHz	72	2474 MHz
13	2415 MHz	33	2435 MHz	53	2455 MHz	73	2475 MHz
14	2416 MHz	34	2436 MHz	54	2456 MHz	74	2476 MHz
15	2417 MHz	35	2437 MHz	55	2457 MHz	75	2477 MHz
16	2418 MHz	36	2438 MHz	56	2458 MHz	76	2478 MHz
17	2419 MHz	37	2439 MHz	57	2459 MHz	77	2479 MHz
18	2420 MHz	38	2440 MHz	58	2460 MHz	78	2480 MHz
19	2421 MHz	39	2441 MHz	59	2461 MHz		

2. Test Configuration of the Equipment under Test

2.1. Connection Diagram of Test System

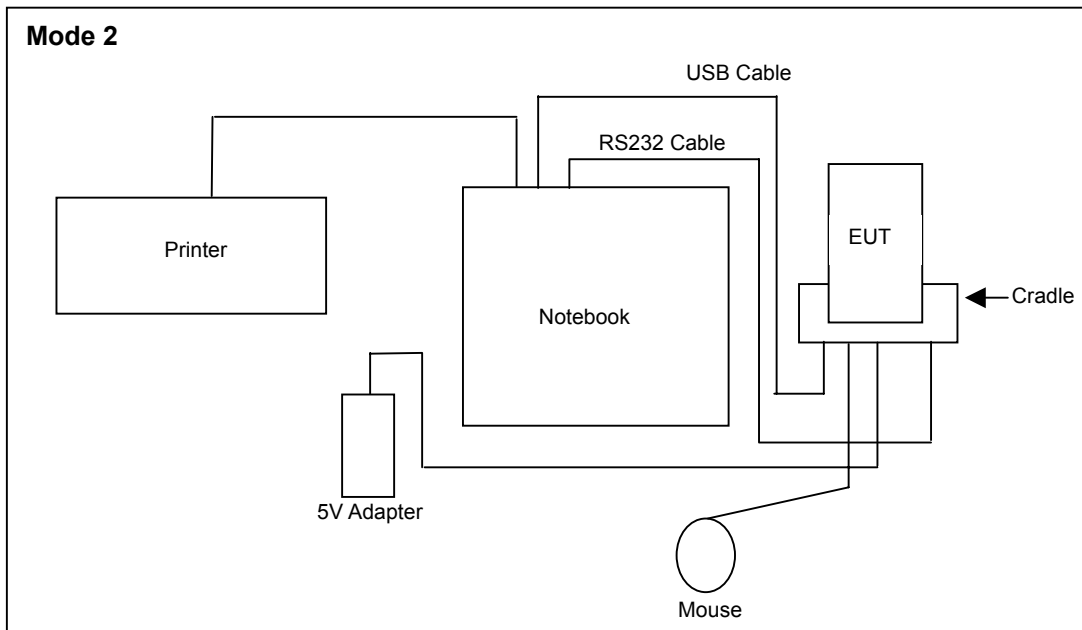
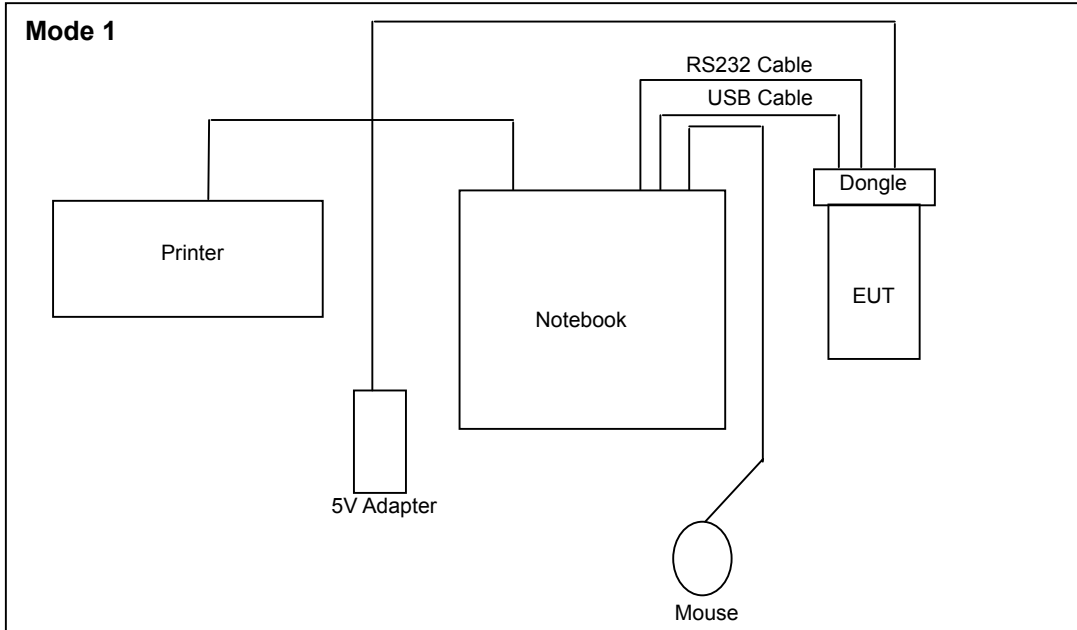

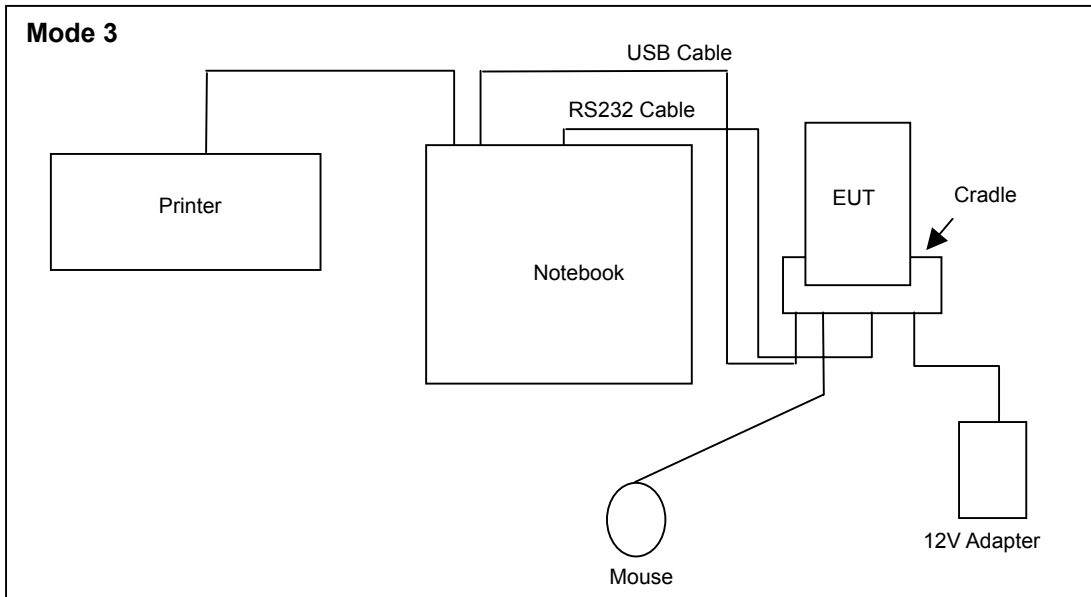

2.2. The Test Mode Description

1. For DSSS modulation, CCK (11 Mbps) is the worst case on all test items.
2. For OFDM modulation, BPSK (6 Mbps) is the worst case on all test items.
3. For Bluetooth function, GFSK modulation is the worst case on all test items.
4. According to ANSI C63.4-2003: Frequency range of EUT is more than 10 MHz, we have to test the lowest, middle and highest channels of EUT.
5. Spurious emission test shall not consider co-location situation, because WLAN and Bluetooth couldn't transmit at the same time.
6. Spurious emission below 1GHz is independent of channel selection difference of modulation type, there will be effect on test results, so only channel 11 with OFDM modulation and channel 78 with GFSK modulation were tested.
7. 2 test configurations was verified. 1st Conf.: EUT was plugged in cradle and the cradle was powered by adapter and connected with computer via the USB cable (Cradle Mode). 2nd Conf.: EUT was without cradle and powered by adapter and connected with computer. The test result of configurations are shown in this test report since they are the worst case(W/O Cradle Mode).
8. During AC conduction emission, independent of channel selection, difference of modulation types, there will be no effect on test results. So only channel 78 with GFSK modulation was tested. The following test modes were performed for conduction test:
 - Mode 1: PDA with 5V Adapter
 - Mode 2: PDA + Cradle with 5V Adapter
 - Mode 3: PDA + Cradle with 12V Adapter

2.3. Description of Test Supporting Units

Support unit	Brand	Model No.	Serial No.	FCC ID	Data cable (m)
Notebook	DELL	PP01L	SP0005	DoC	-
Printer	EPSON	STYLUS COLOR 680	SP0016	DoC	1
Mouse	IBM	MDZ800	SP0047	DoC	1.7



3. General Information of Test

3.1. Test Facility

Test Site Location : No. 52, Hwa Ya 1st Rd., Hwa Ya Technology Park, Kwei-Shan Hsiag, Tao Yuan Hsien, Taiwan, R.O.C.
: TEL 886-3-327-3456
: FAX 886-3-318-0055

Test Site No : 03CH03-HY / TH01-HY / CO04-HY

3.2. Standards for Methods of Measurement

Here is the list of the standards followed in this test report.

ANSI C63.4-2003
47 CFR FCC Part 15 Subpart C

3.3. DoC Statement

This EUT is also classified as a device of computer peripheral Class B which DoC has to be followed. It has been verified according to the rule of 47 CFR part 15 Subpart B, and found that all the requirements has been fulfilled.

3.4. Frequency Range Investigated

Radiated emission test: from 30 MHz to 10th carrier harmonic

3.5. Test Distance

The test distance of radiated emission (30MHz~1GHz) test from antenna to EUT is 3 M.
The test distance of radiated emission (1GHz~10th carrier harmonic) test from antenna to EUT is 3 M.

3.6. Test Software

During testing, Channel & Power Controlling Software: This was provided by the manufacturer and is able to let the test engineer select the operating channel as well as the RF output power. The parameters for channel selection is trying to offer the test engineer the ability to fix the operating channel for testing, both normal data and continuously transmitting modes are allowed, and that for RF output power selection is for the setting of RF output power expected by the customer and is going to be fixed on the firmware of the final end product.



Power Parameter Table

802.11b/g part

Test Software Version	CONTTX V1.0
Power Set CH01 / DSSS	TX Power
Power Set CH06 / DSSS	TX Power
Power Set CH11 / DSSS	TX Power
Power Set CH01 / OFDM	TX Power
Power Set CH06 / OFDM	TX Power
Power Set CH11 / OFDM	TX Power

Bluetooth part

Test Software Version	CMU 200 (Connected Test Mode)
Power Set CH00 / GFSK	TX power
Power Set CH39 / GFSK	TX Power
Power Set CH78 / GFSK	TX Power



4. List of Measurements

4.1. Summary of the Test Results

Applied Standard: 47 CFR FCC Part 15 Subpart C For 802.11b/g part			
Paragraph	FCC Section	Description of Test	Result
5.1	15.247(a)(2)	6dB Spectrum Bandwidth	Pass
5.2	15.247(b)(3)	Maximum Peak Output Power	Pass
5.3	15.247(e)	Peak Power Spectral Density	Pass
5.9	15.247(d)	Band Edges Emission	Pass
5.10	15.207	AC Power Line Conducted Emission	Pass
5.11	15.247(d)	Spurious Radiated Emission	Pass
5.12	15.203/15.247(b)/(c)	Antenna Requirement	Pass



Applied Standard: 47 CFR Part 15 and Part 2 For Bluetooth part			
Paragraph	FCC Rule	Description of Test	Result
5.4	15.247(a)(1)	Hopping Channel Bandwidth	Pass
5.5	15.247(a)(1)	Hopping Channel Separation	Pass
5.6	15.247(b)(1)	Number of Hopping Frequency Used	Pass
5.7	15.247(a)(1)(iii)	Dwell Time of Each Frequency	Pass
5.8	15.247(b)(1)	Maximum Peak Output Power	Pass
5.9	15.247(d)	Band Edges Emission	Pass
5.10	15.207	AC Power Line Conducted Emission	Pass
5.11	15.247(d)	Spurious Radiated Emission	Pass
5.12	15.203/15.247(b)/(c)	Antenna Requirement	Pass

5. Test Result

5.1. Test of 6dB Spectrum Bandwidth

5.1.1. Applicable Standard

Section 15.247(a)(2): For digital modulation systems, the minimum 6 dB bandwidth shall be at least 500 kHz.

5.1.2. Measuring Instruments

Item 18 of the table is on section 6.

5.1.3. Description of Major Test Instruments Setting

- Spectrum Analyzer : R&S FSP40
- Attenuation : Auto
- Center Frequency : 2412 MHz / 2437 MHz / 2462 MHz
- Span Frequency : > 6dB Bandwidth
- RB : 100 kHz
- VB : 100 kHz
- Detector : Peak
- Trace : Max Hold
- Sweep Time : Auto

5.1.4. Test Procedures

1. The transmitter output was connected to the spectrum analyzer through an attenuator.
2. Set RBW of spectrum analyzer to 100KHz and VBW to 100KHz. Trace to Max hold and Detector PK.
3. The spectrum width with level higher than 6dB below the peak level.
4. Repeat above 1~3 points for the middle and highest channel of the EUT.

5.1.5. Test Setup Layout

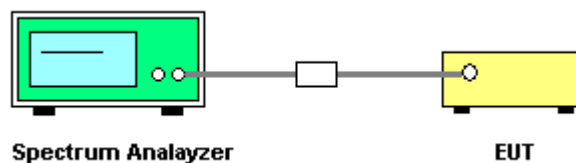

5.1.6. Test Criteria

All test results complied with the requirements of Section 15.247(a)(2). Measurement Uncertainty is 1×10^{-5} .



5.1.7. Test Result

- Temperature: 24°C
- Relative Humidity: 54%
- Duty Cycle of the Equipment During the Test: 100.00%
- Test Engineer: Sam Lee

Modulation Type	Channel No.	Frequency (MHz)	6dB Bandwidth (MHz)	Min. Limit (MHz)
DSSS	01	2412 MHz	13.00	0.5
DSSS	06	2437 MHz	13.00	0.5
DSSS	11	2462 MHz	13.00	0.5
OFDM	01	2412 MHz	16.44	0.5
OFDM	06	2437 MHz	16.40	0.5
OFDM	11	2462 MHz	16.44	0.5



Modulation Type: DSSS (Channel 01) :

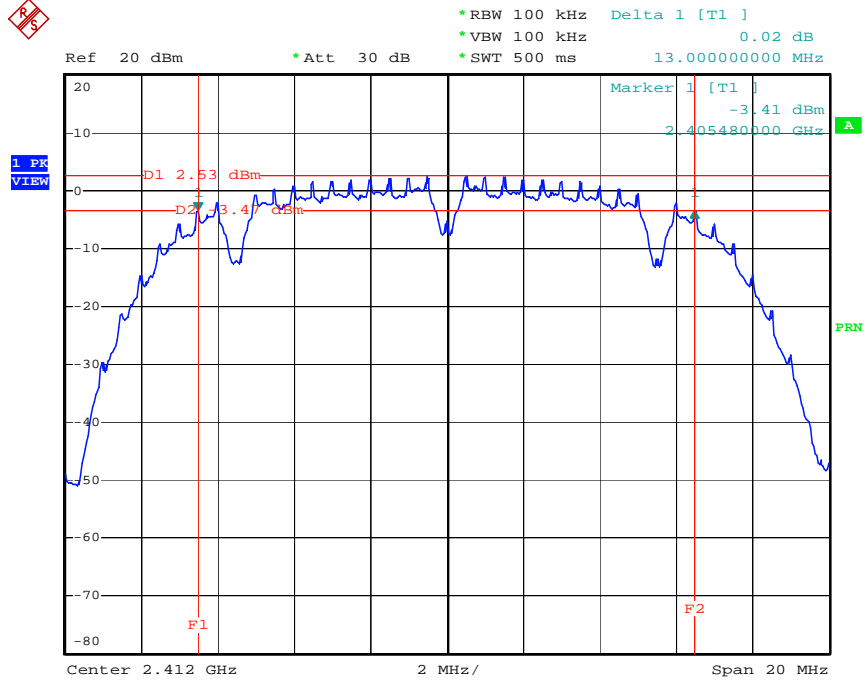

Date: 11.JAN.2005 15:57:20

Modulation Type: DSSS (Channel 06) :

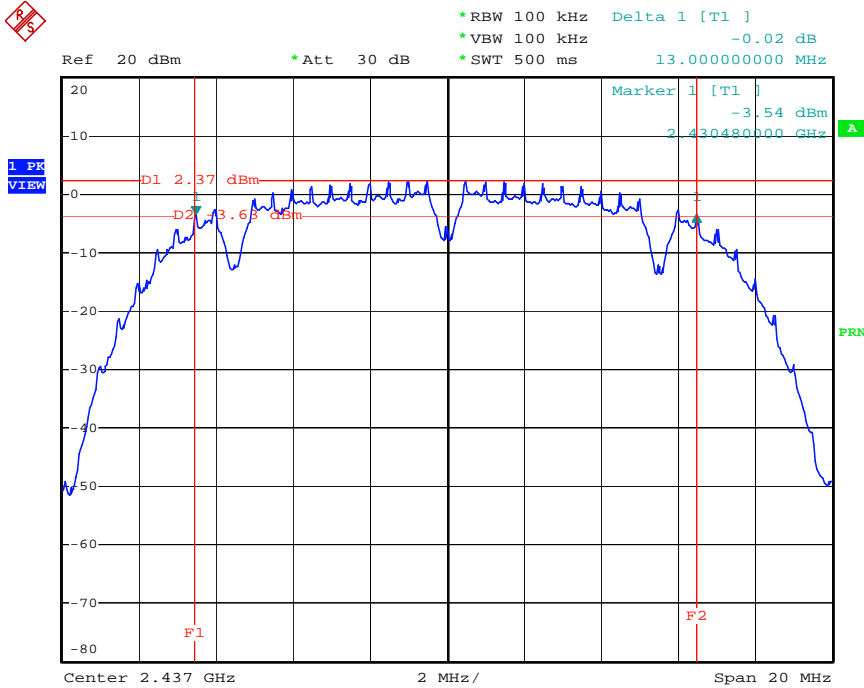

Date: 11.JAN.2005 16:00:51

Modulation Type: DSSS (Channel 11) :

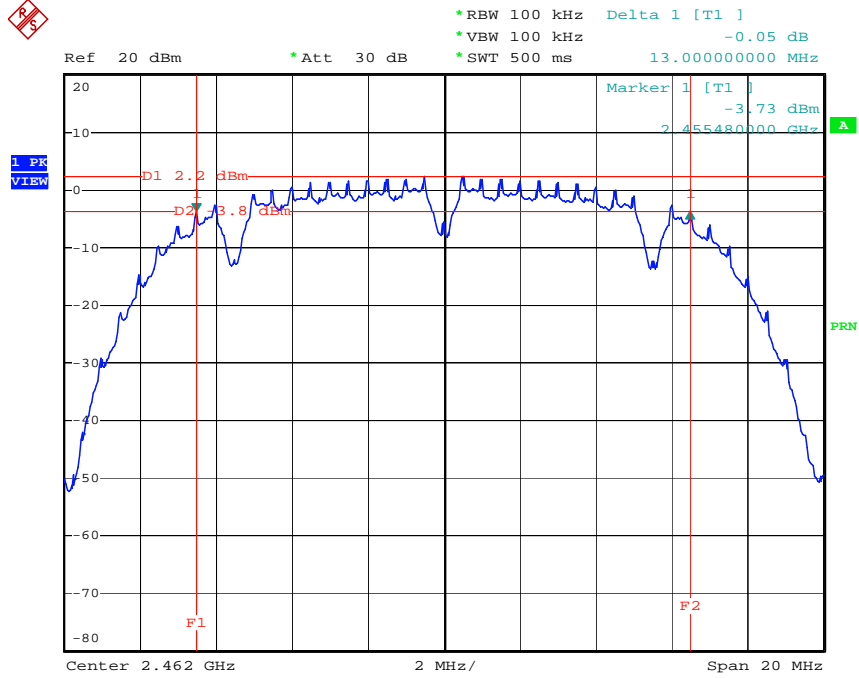

Date: 11.JAN.2005 16:02:04

Modulation Type: OFDM (Channel 01) :

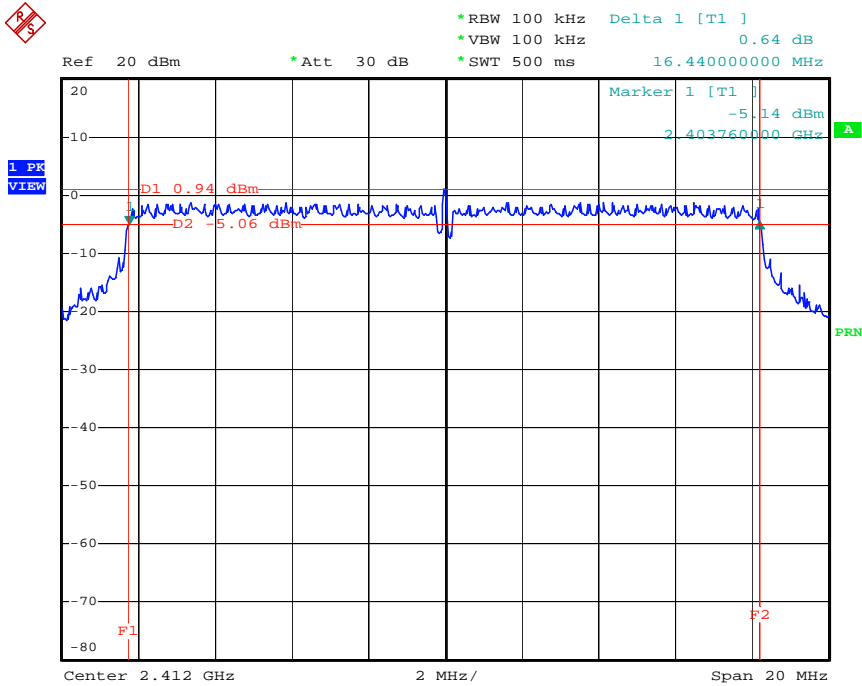

Date: 11.JAN.2005 15:06:19



Modulation Type: OFDM (Channel 06) :

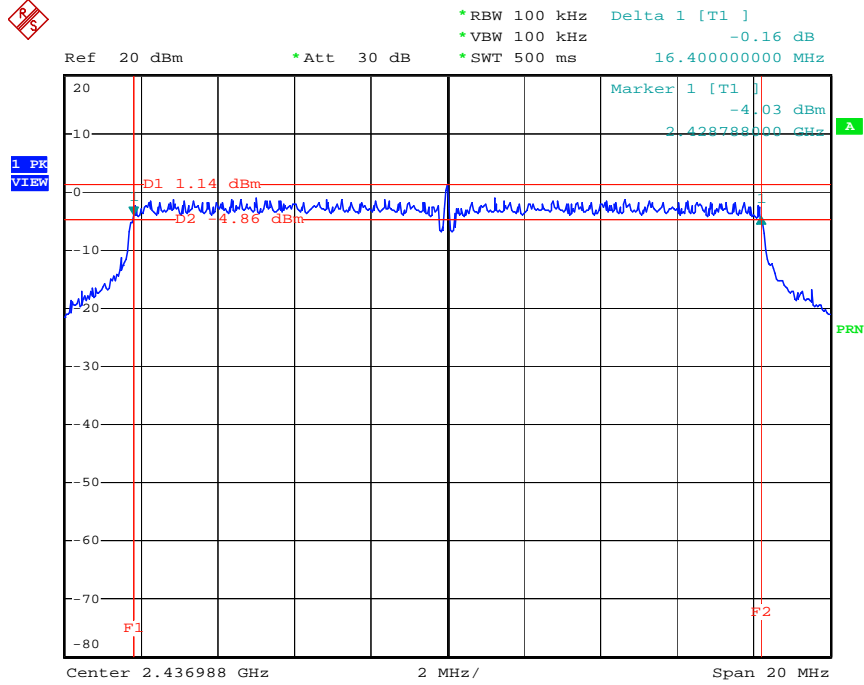

Date: 11.JAN.2005 15:16:09

Modulation Type: OFDM (Channel 11) :

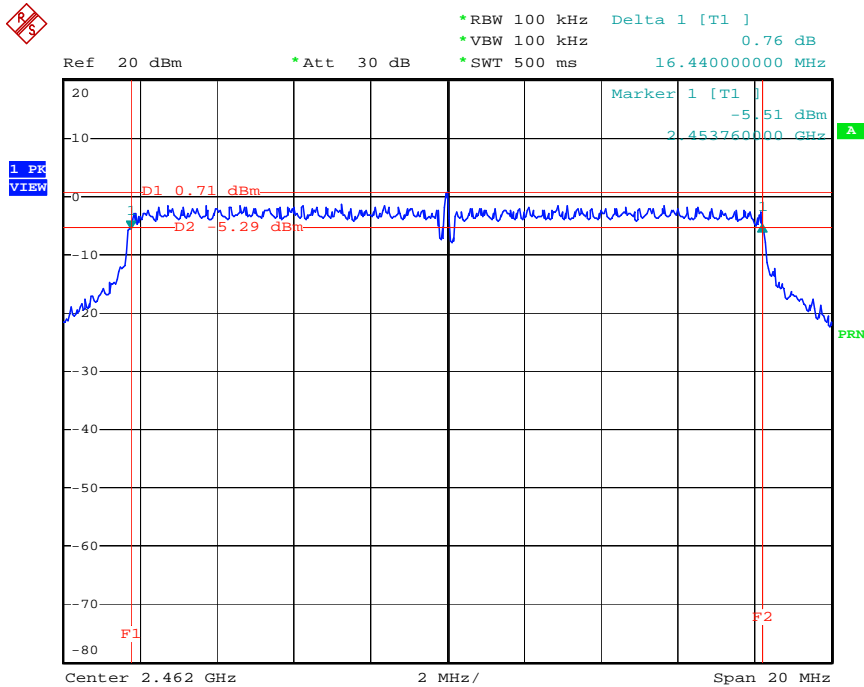

Date: 11.JAN.2005 15:17:27

5.2. Test of Maximum Peak Output Power (WLAN)

5.2.1. Applicable Standard

Section 15.247(b)(3): The maximum peak output power shall not exceed 1 watt (30dBm). Except as shown below, if transmitting antennas of directional gain greater than 6 dBi are used the peak output power from the intentional radiator shall be reduced below the above stated values by the amount in dB that the directional gain of the antenna exceeds 6 dBi.

5.2.2. Measuring Instruments

Item 19, 21 of the table are on section 6.

5.2.3. Test Procedures and Test Instruments Setting

1. The transmitter output was connected to the peak power meter through an attenuator.
2. Peak power meter parameter set to auto attenuator and filter is the same as.
3. Repeated the 1 for the middle and highest channel of the EUT.

5.2.4. Test Setup Layout

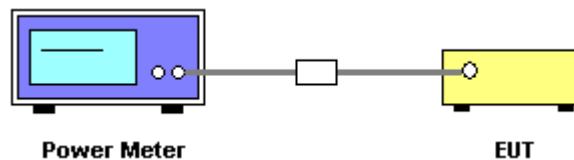

5.2.5. Test Criteria

All test results complied with the requirements of Section 15.247(b)(3). Measurement Uncertainty is 1.5dB.

5.2.6. Test Result of Conducted Power

- Temperature: 24°C
- Relative Humidity: 54%
- Duty Cycle of the Equipment During the Test: 100.00%
- Test Engineer: Sam Lee

Modulation Type	Channel No.	Frequency (MHz)	Output Power (dBm)	Limits (dBm)
DSSS	01	2412 MHz	15.70	30
DSSS	06	2437 MHz	15.50	30
DSSS	11	2462 MHz	15.30	30
OFDM	01	2412 MHz	21.70	30
OFDM	06	2437 MHz	21.50	30
OFDM	11	2462 MHz	21.20	30



5.2.7. Test Result of EIRP Power

- Temperature: 24°C
- Relative Humidity: 54%
- Duty Cycle of the Equipment During the Test: 100.00%
- Test Engineer: Sam Lee

Antenna No.	Gain (dBi)	Modulation Type	Channel No.	Frequency (MHz)	Power (dBm)	Limits (dBm)
1	3.00	DSSS	01	2412 MHz	18.70	36
1	3.00	DSSS	06	2437 MHz	18.50	36
1	3.00	DSSS	11	2462 MHz	18.30	36
1	3.00	OFDM	01	2412 MHz	24.70	36
1	3.00	OFDM	06	2437 MHz	24.50	36
1	3.00	OFDM	11	2462 MHz	24.20	36

5.3. Test of Peak Power Spectral Density

5.3.1. Applicable Standard

Section 15.247(e): For digital modulation systems, the peak power spectral density conducted from the intentional radiator to the antenna shall not be greater than 8 dBm in any 3 kHz band during any time interval of continuous transmission.

5.3.2. Measuring Instruments

Item 18 of the table is on section 6.

5.3.3. Description of Major Test Instruments Setting

- Spectrum Analyzer : R&S FSP40
- Attenuation : Auto
- Center Frequency : 2412 MHz / 2437 MHz / 2462 MHz
- Span Frequency : 1.5MHz
- RB : 3 kHz
- VB : 30 kHz
- Detector : Peak
- Trace : Max Hold
- Sweep Time : 500s

5.3.4. Test Procedures

1. The transmitter output is connected to the spectrum analyzer through an attenuator.
2. Set RBW of spectrum analyzer to 3kHz and VBW to 30kHz. Set Detector to Peak, Trace to Max Hold.
3. Mark the frequency with maximum peak power as the center of the display of the spectrum
4. Set the span to 1.5MHz and the sweep time to 500s and record the maximum peak value.
5. Repeated the 1~4 for the middle and highest channel of the EUT.

5.3.5. Test Setup Layout

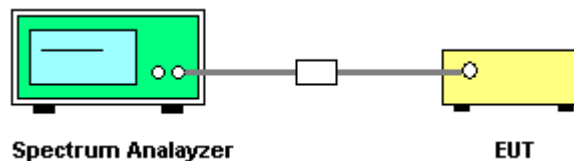

5.3.6. Test Criteria

All test results complied with the requirements of Section 15.247(e). Measurement Uncertainty is 1.5dB.



5.3.7. Test Result

- Temperature: 24°C
- Relative Humidity: 54%
- Duty Cycle of the Equipment During the Test: 100.00%
- Test Engineer: Sam Lee

Modulation Type	Channel No.	Frequency (MHz)	Power Density (dBm)	Limits (dBm)
DSSS	01	2412 MHz	-11.83	8
DSSS	06	2437 MHz	-11.84	8
DSSS	11	2462 MHz	-12.13	8
OFDM	01	2412 MHz	-1.03	8
OFDM	06	2437 MHz	-1.13	8
OFDM	11	2462 MHz	-1.29	8



Modulation Type: DSSS (Channel 01) :

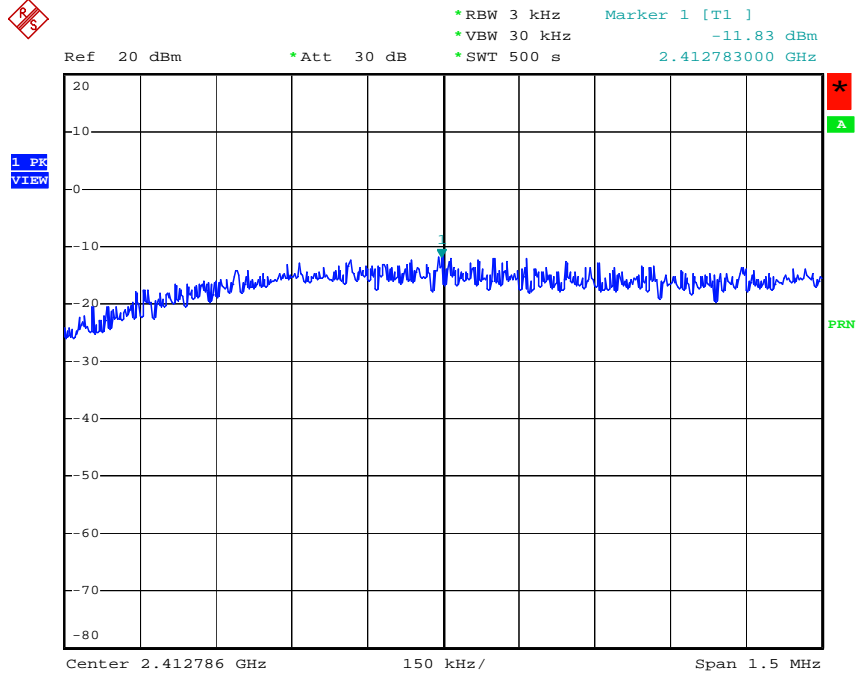

Date: 11.JAN.2005 15:58:35

Modulation Type: DSSS (Channel 06) :

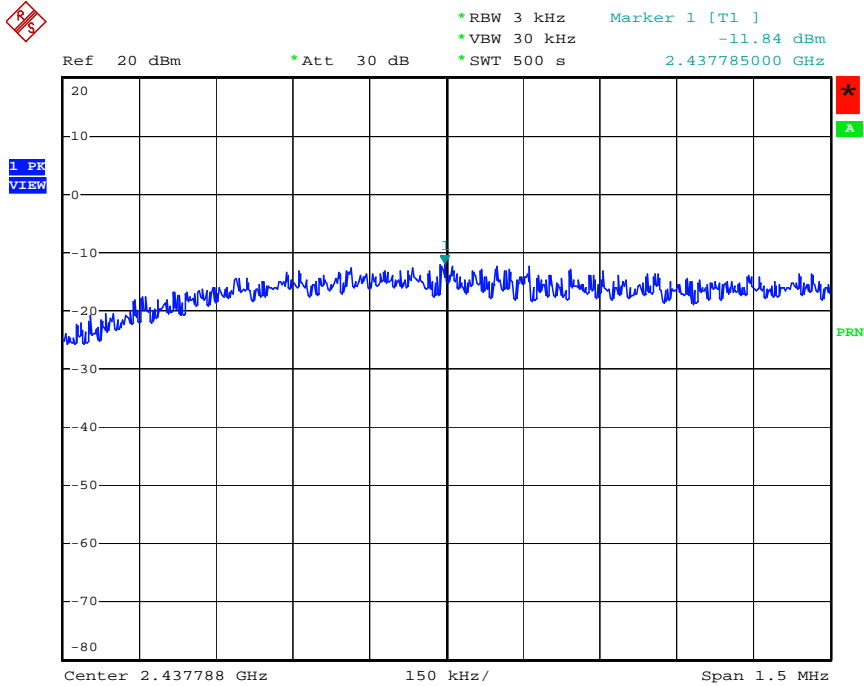

Date: 11.JAN.2005 15:59:20



Modulation Type: DSSS (Channel 11) :

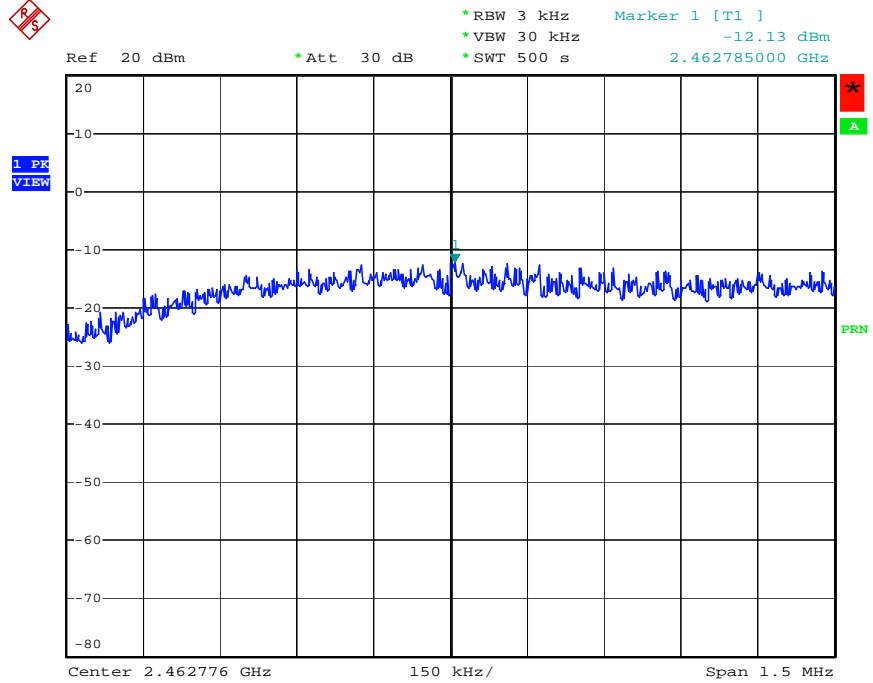

Date: 11.JAN.2005 16:04:41

Modulation Type: OFDM (Channel 01) :

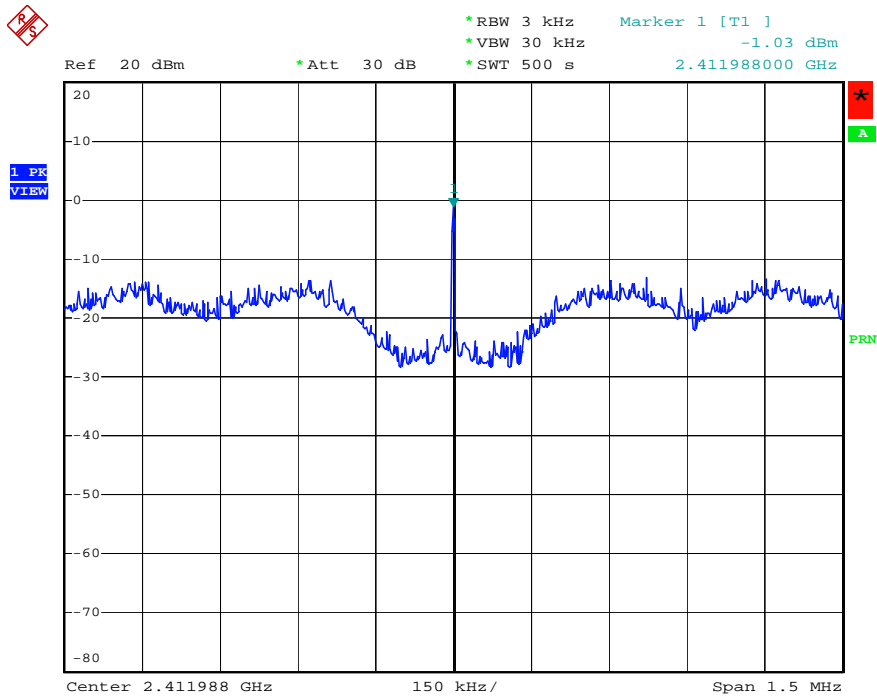

Date: 11.JAN.2005 15:12:46



Modulation Type: OFDM (Channel 06) :

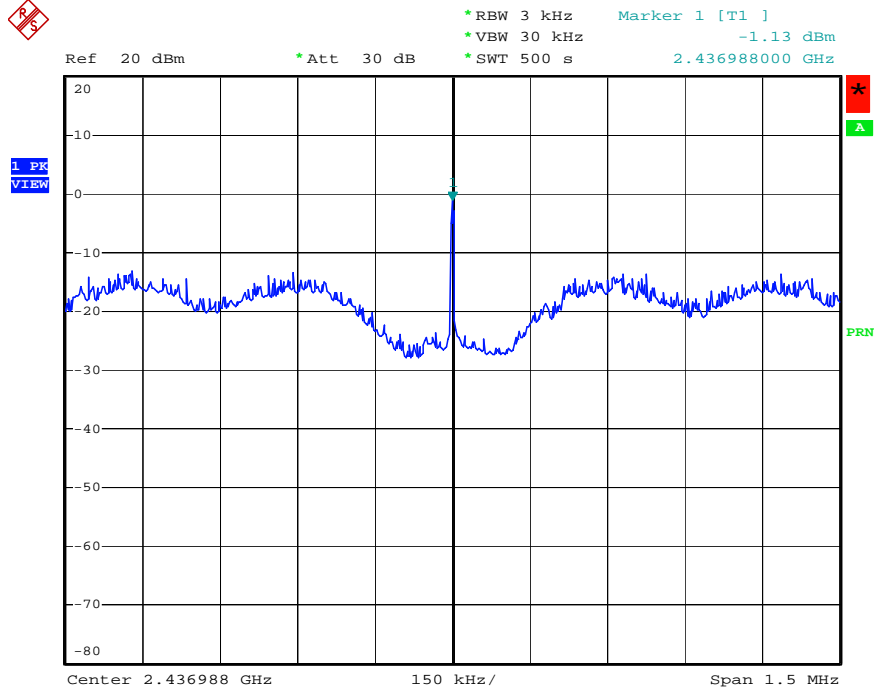

Date: 11.JAN.2005 15:13:32

Modulation Type: OFDM (Channel 11) :

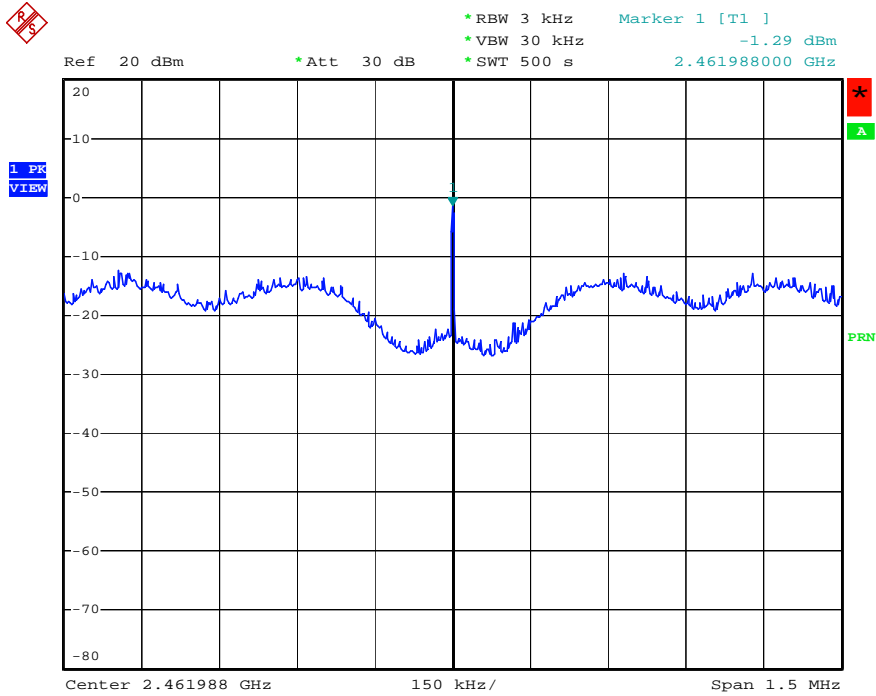

Date: 11.JAN.2005 15:20:50

5.4. Test of Hopping Channel Bandwidth

5.4.1. Applicable Standard

Section 15.247(a)(1): Frequency hopping systems shall have hopping channel carrier frequencies separated by a minimum of 25 kHz or the 20 dB bandwidth of the hopping channel, whichever is greater.

5.4.2. Measuring Instruments

Item 18 of the table is on section 6.

5.4.3. Description of Major Test Instruments Setting

- Spectrum Analyzer : R&S FSP40
- Attenuation : Auto
- Center Frequency : 2402 MHz / 2441 MHz / 2480 MHz
- Span Frequency : > 20dB Bandwidth
- RB : 30 kHz
- VB : 100 kHz
- Detector : Peak
- Trace : Max Hold
- Sweep Time : Auto

5.4.4. Test Procedures

1. The transmitter output was connected to the spectrum analyzer through an attenuator.
2. Set RBW of spectrum analyzer to 30KHz and VBW to 100KHz.
3. Set Detector to Peak, Trace to Max Hold and Sweep Time is Auto.
4. The spectrum width with level higher than 20dB below the peak level.
5. Repeat above 1~3 points for the middle and highest channel of the EUT.

5.4.5. Test Setup Layout

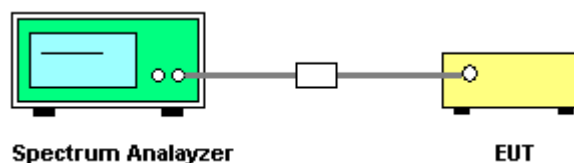

5.4.6. Test Criteria

All test results complied with the requirements of Section 15.247(a)(1). Measurement Uncertainty is 1×10^{-5} .

5.4.7. Test Result

- Temperature: 24°C
- Relative Humidity: 54%
- Duty Cycle of the Equipment During the Test: 46.60 %
- Test Engineer: Sam Lee

Modulation Type	Channel No.	Frequency (MHz)	20dB Bandwidth (kHz)	Min. Limit (kHz)
GFSK	00	2402 MHz	921.00	25
GFSK	39	2441 MHz	912.00	25
GFSK	78	2480 MHz	927.00	25

Modulation Type: GFSK (Channel 00) :

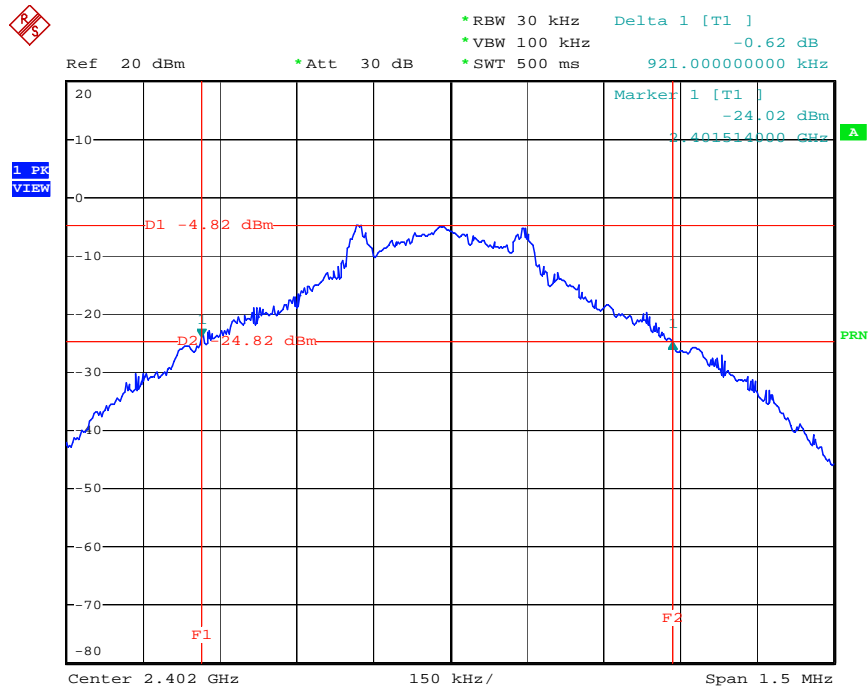

Date: 11.JAN.2005 17:58:37



Modulation Type: GFSK (Channel 39) :

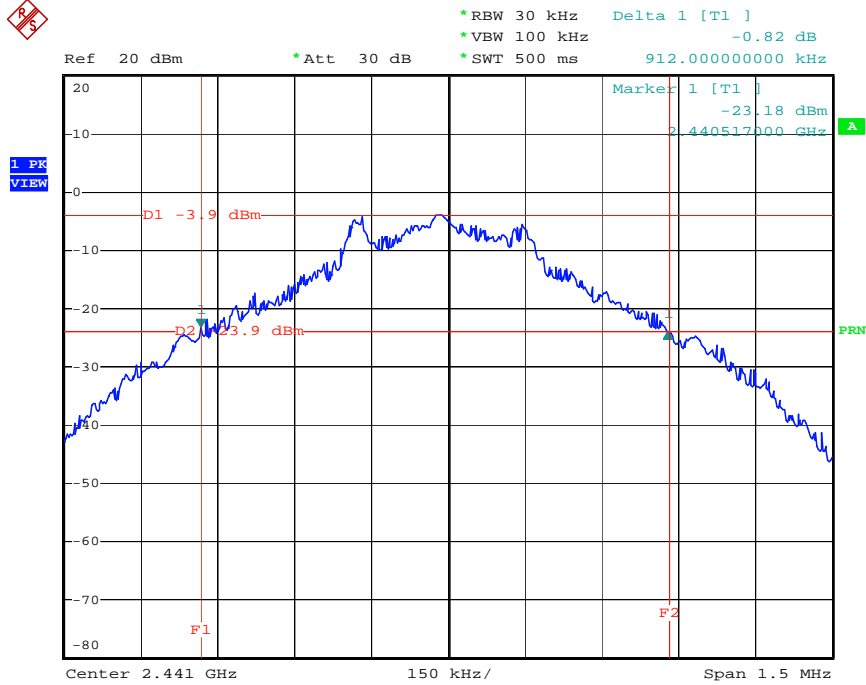

Date: 11.JAN.2005 17:11:21

Modulation Type: GFSK (Channel 78) :

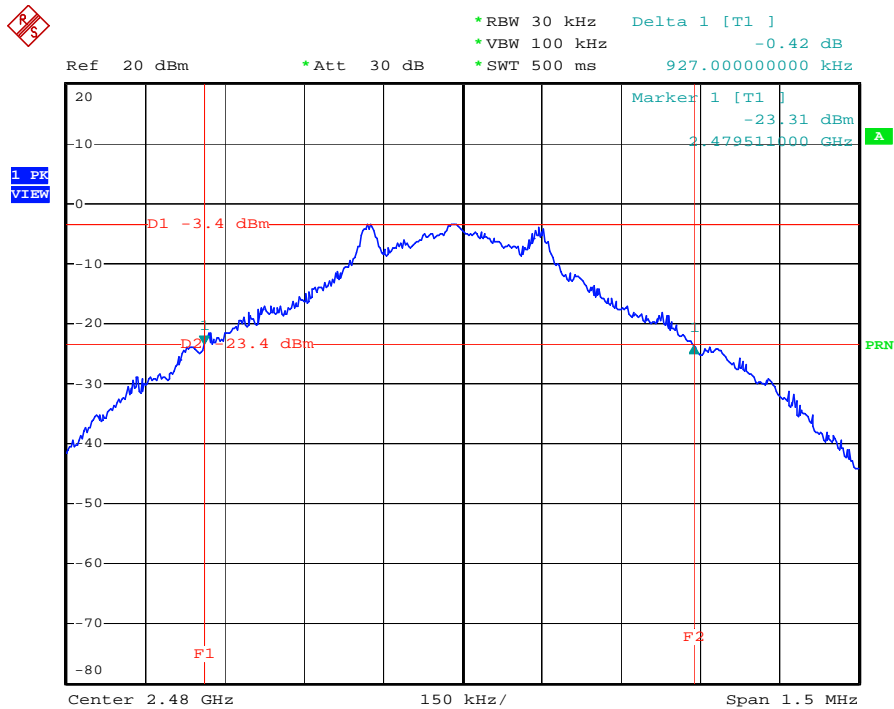

Date: 11.JAN.2005 16:58:11

5.5. Test of Hopping Channel Separation

5.5.1. Applicable Standard

Section 15.247(a)(1): Frequency hopping systems shall have hopping channel carrier frequencies separated by a minimum of 25 kHz or the 20 dB bandwidth of the hopping channel, whichever is greater.

5.5.2. Measuring Instruments

Item 18 of the table is on section 6.

5.5.3. Description of Major Test Instruments Setting

- Spectrum Analyzer : R&S FSP40
- Attenuation : Auto
- Center Frequency : 2402 MHz / 2441 MHz / 2480 MHz
- Span Frequency : > One time channel separation
- RB : 100 kHz
- VB : 100 kHz
- Detector : Peak
- Trace : Max Hold
- Sweep Time : Auto

5.5.4. Test Procedures

1. The transmitter output was connected to the spectrum analyzer through an attenuator.
2. Set RBW of spectrum analyzer to 100KHz and VBW to 100KHz.
3. Set Detector to Peak, Trace to Max Hold and Sweep Time is Auto.
4. The Hopping Channel Separation is defined as the separation between 2 neighboring hopping frequencies.
5. Repeat above 1~3 points for the middle and highest channel of the EUT.

5.5.5. Test Setup Layout

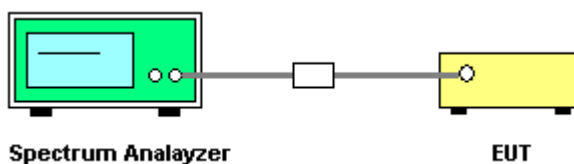

5.5.6. Test Criteria

All test results complied with the requirements of Section 15.247(a)(1). Measurement Uncertainty is 1×10^{-5} .



5.5.7. Test Result

- Temperature: 24°C
- Relative Humidity: 54%
- Duty Cycle of the Equipment During the Test: 46.60 %
- Test Engineer: Sam Lee

Modulation Type	Channel No.	Frequency (MHz)	Hopping Channel Separation (kHz)	Min. Limit (kHz)
GFSK	00	2402 MHz	1000	921.00
GFSK	39	2441 MHz	1000	912.00
GFSK	78	2480 MHz	1000	927.00

Modulation Type: GFSK (Channel 00) :

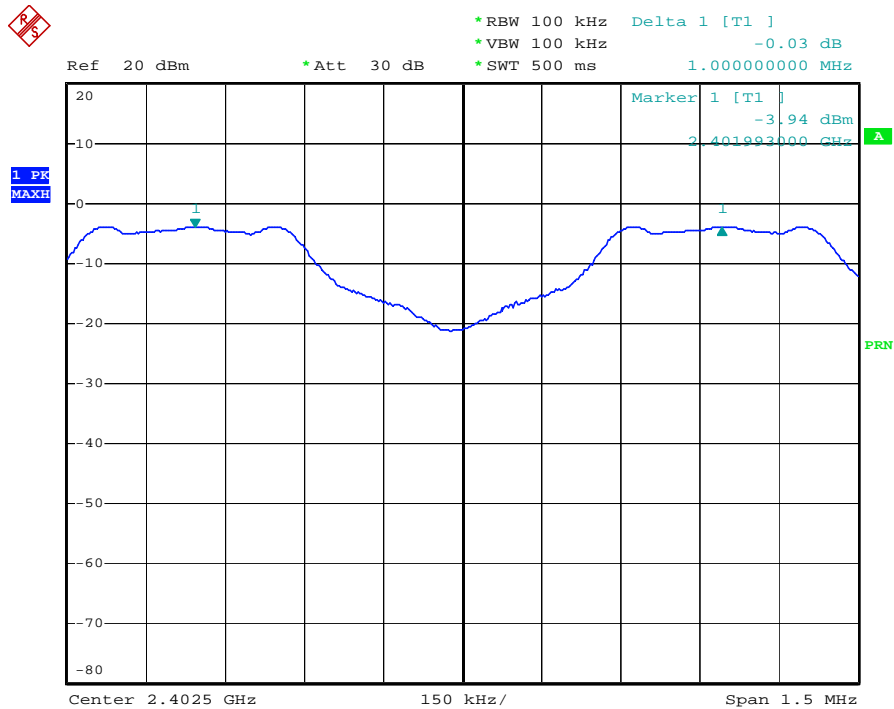

Date: 11.JAN.2005 17:16:10



Modulation Type: GFSK (Channel 39) :

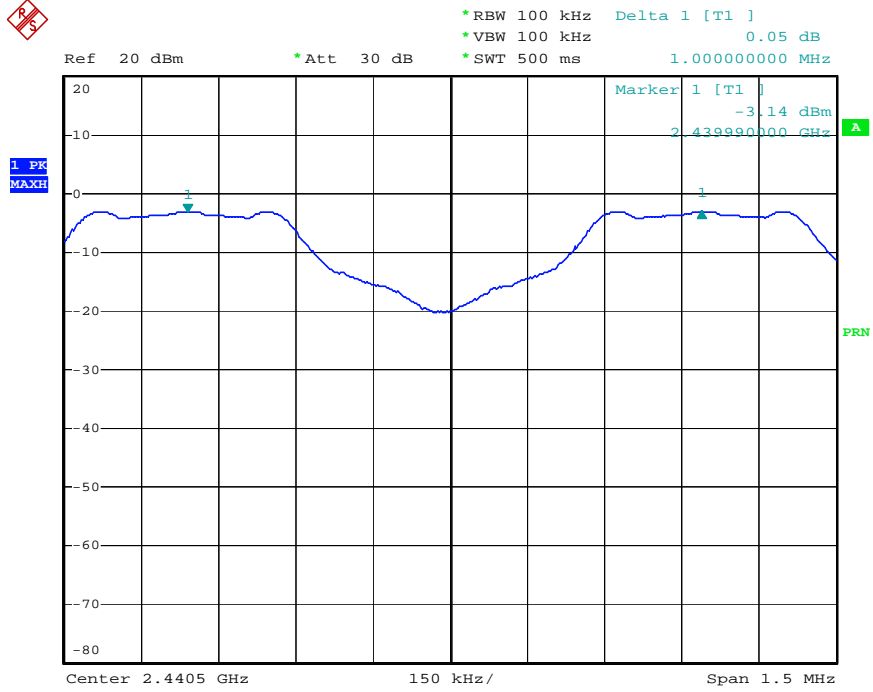

Date: 11.JAN.2005 17:15:01

Modulation Type: GFSK (Channel 78) :

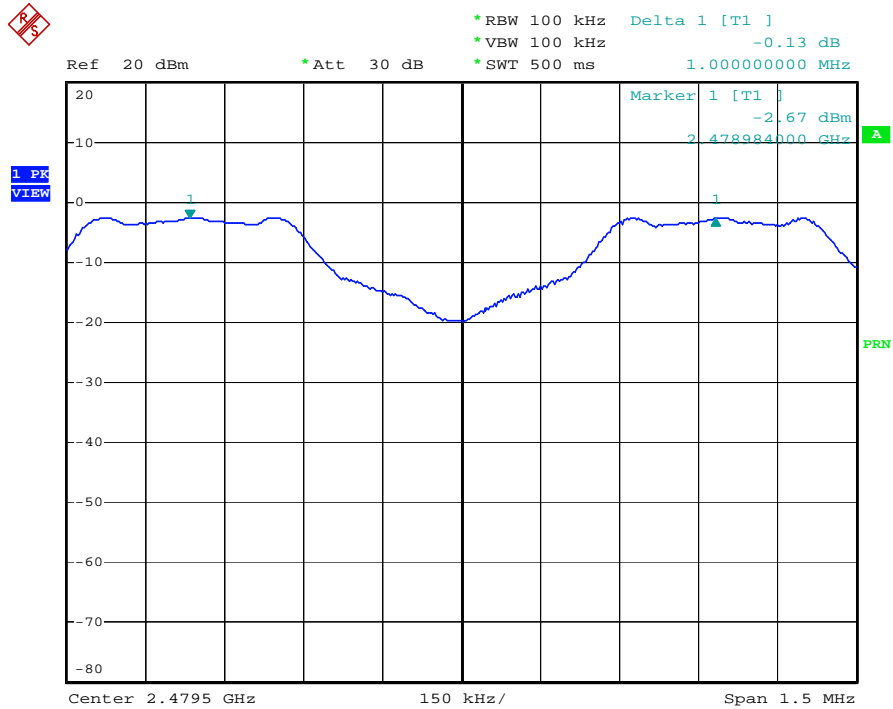

Date: 11.JAN.2005 17:03:54

5.6. Test of Number of Hopping Frequency

5.6.1. Applicable Standard

Section 15.247(b)(1): For frequency hopping systems operating in the 2400-2483.5 MHz band employing at least 75 non-overlapping hopping channels.

5.6.2. Measuring Instruments

Item 18 of the table is on section 6.

5.6.3. Description of Major Test Instruments Setting

- Spectrum Analyzer : R&S FSP40
- Attenuation : Auto
- Center Frequency : 2402 MHz ~ 2480 MHz
- Span Frequency : > Operation frequency range
- RB : 100 kHz
- VB : 100 kHz

5.6.4. Test Procedures

1. The transmitter output was connected to the spectrum analyzer through an attenuator.
2. Set RBW of spectrum analyzer to 100KHz and VBW to 100KHz.
3. Set Detector to Peak, Trace to Max Hold and Sweep Time is Auto.
4. Observe frequency hopping in 2400MHz~2483.5MHz, there are at least 75 non-overlapping channels.
5. Repeat above 1~3 points for the middle and highest channel of the EUT.

5.6.5. Test Setup Layout

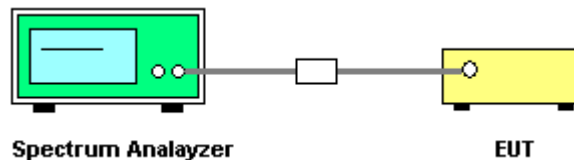

5.6.6. Test Criteria

All test results complied with the requirements of Section 15.247(b)(1). Measurement Uncertainty is 1×10^{-5} .

5.6.7. Test Result

- Temperature: 24°C
- Relative Humidity: 54%
- Duty Cycle of the Equipment During the Test: 46.60 %
- Test Engineer: Sam Lee

Modulation Type	Channel No.	Frequency (MHz)	Number of Hopping Ch. (Channels)	Min. Limit (Channels)
GFSK	00 ~78	2402 MHz ~ 2480 MHz	79	75



Modulation Type: GFSK (Channel 01 ~ Channel 78) :

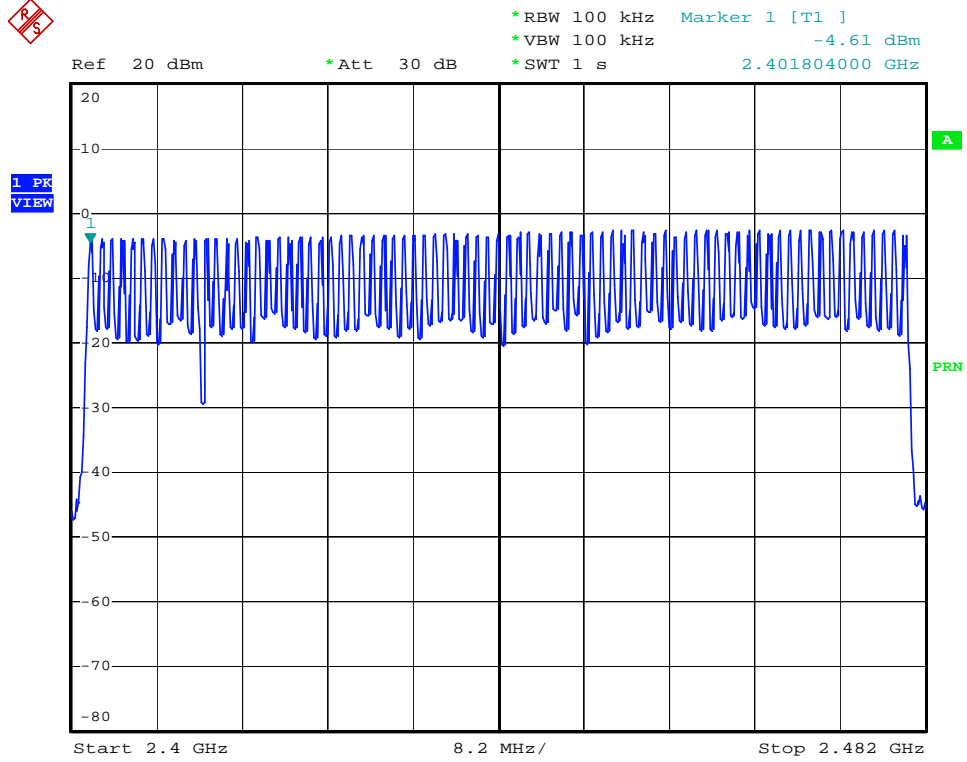

Date: 11.JAN.2005 17:53:25

5.7. Test of Test of Dwell Time of Each Frequency

5.7.1. Applicable Standard

Section 15.247(a)(1)(iii): For frequency hopping systems operating in the 2400-2483.5 MHz band employing at least 75 non-overlapping hopping channels.

5.7.2. Measuring Instruments

Item 18 of the table is on section 6.

5.7.3. Description of Major Test Instruments Setting

- Spectrum Analyzer : R&S FSP40
- Attenuation : Auto
- Center Frequency : 2402 MHz / 2441 MHz / 2480 MHz
- Span Frequency : 0MHz
- RB : 100 kHz
- VB : 100 kHz
- Detector : Peak
- Trigger : Video
- Sweep Time : > One pulse time

5.7.4. T Test Procedures and Test Instruments Setting

1. The transmitter output was connected to the spectrum analyzer through an attenuator.
2. Set RBW of spectrum analyzer to 1000kHz and VBW to 1000kHz.
3. Set Detector to Peak, Trace to Max Hold and Sweep Time is more than once pulse time.
4. Set the center frequency on any frequency would be measure and set the frequency span to zero span.
5. Set the EUT for DH5, DH3 and DH1 packet transmitting.
6. Measure the maximum time duration of one single pulse.
7. DH5 Packet permit maximum 3.37 hops per second in each channel. So, the dwell time is the time duration of the pulse times 106.6 within 31.6 seconds.
8. DH3 Packet permit maximum 5.06 hops per second in each channel. So, the dwell time is the time duration of the pulse times 160 within 31.6 seconds.
9. DH1 Packet permit maximum 10.12 hops per second in each channel. So, the dwell time is the time duration of the pulse times 320 within 31.6 seconds.

5.7.5. Test Setup Layout

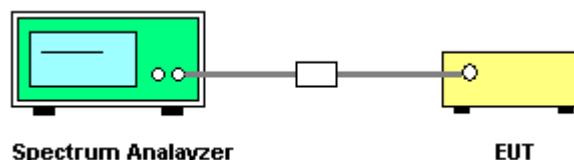

5.7.6. Test Criteria

All test results complied with the requirements of Section 15.247(a)(1)(iii). Measurement Uncertainty is 1×10^{-5} .

5.7.7. Test Result

- Temperature: 24°C
- Relative Humidity: 54%
- Duty Cycle of the Equipment During the Test: 46.60 %
- Test Engineer: Sam Lee

Data Packet	Frequency (MHz)	Pulse Duration (ms)	Dwell Time (s)	Limits (s)
DH5	2402 MHz	2.9800	0.3179	0.4
DH3	2402 MHz	1.7200	0.2752	0.4
DH1	2402 MHz	0.4600	0.1472	0.4
DH5	2441 MHz	2.9800	0.3179	0.4
DH3	2441 MHz	1.7200	0.2752	0.4
DH1	2441 MHz	0.4600	0.1472	0.4
DH5	2480 MHz	2.9800	0.3179	0.4
DH3	2480 MHz	1.7200	0.2752	0.4
DH1	2480 MHz	0.4600	0.1472	0.4

DH5 Modulation Type: GFSK (Channel 00) :

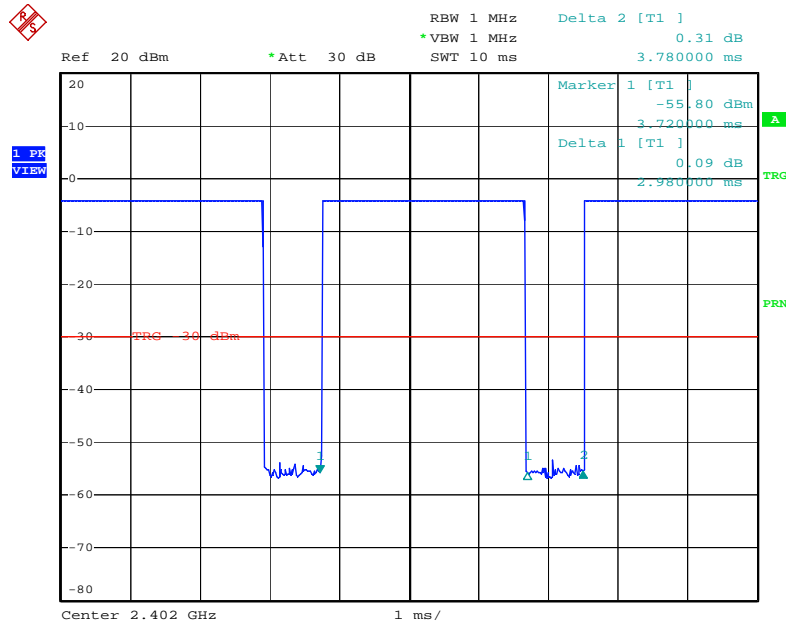

Date: 11.JAN.2005 17:40:24



DH3 Modulation Type: GFSK (Channel 00) :

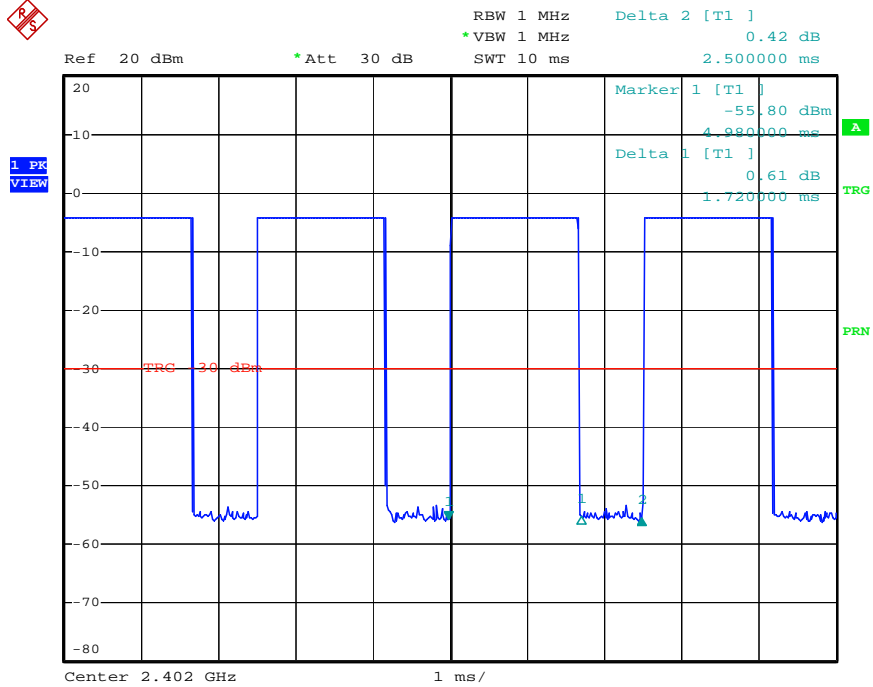

Date: 11.JAN.2005 17:37:39

DH1 Modulation Type: GFSK (Channel 00) :

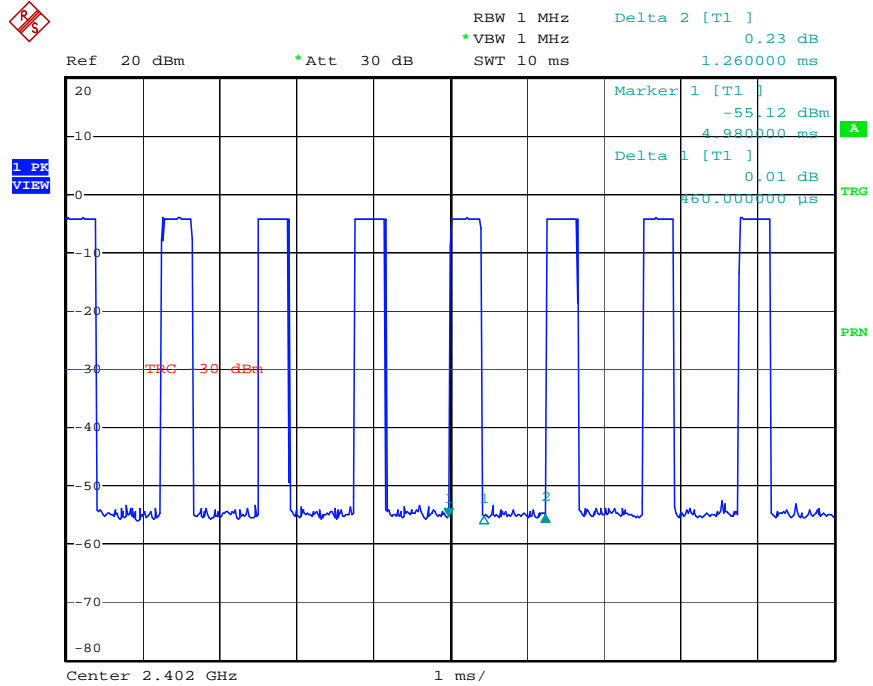

Date: 11.JAN.2005 17:24:35



DH5 Modulation Type: GFSK (Channel 39) :

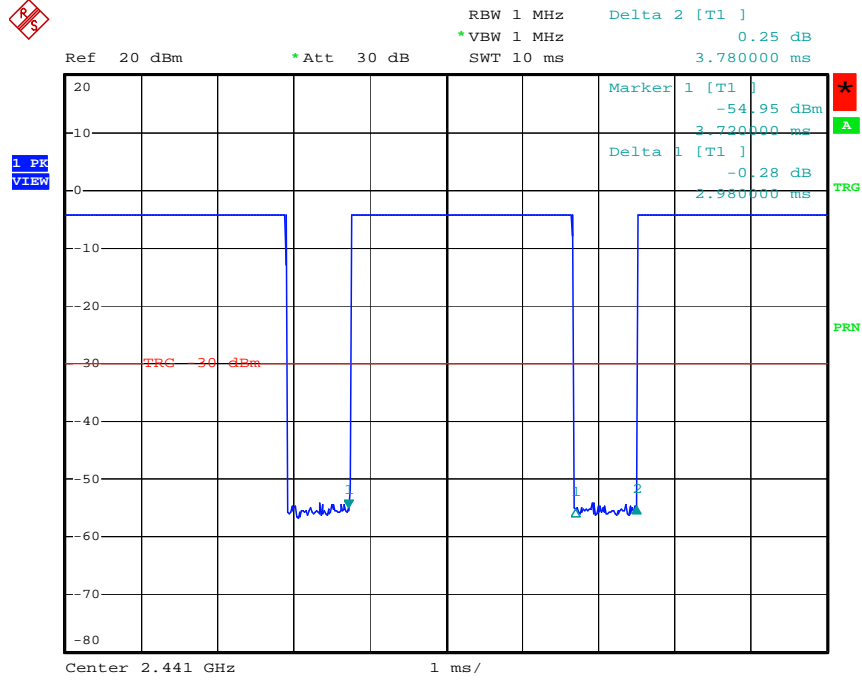

Date: 11.JAN.2005 17:41:16

DH3 Modulation Type: GFSK (Channel 39) :

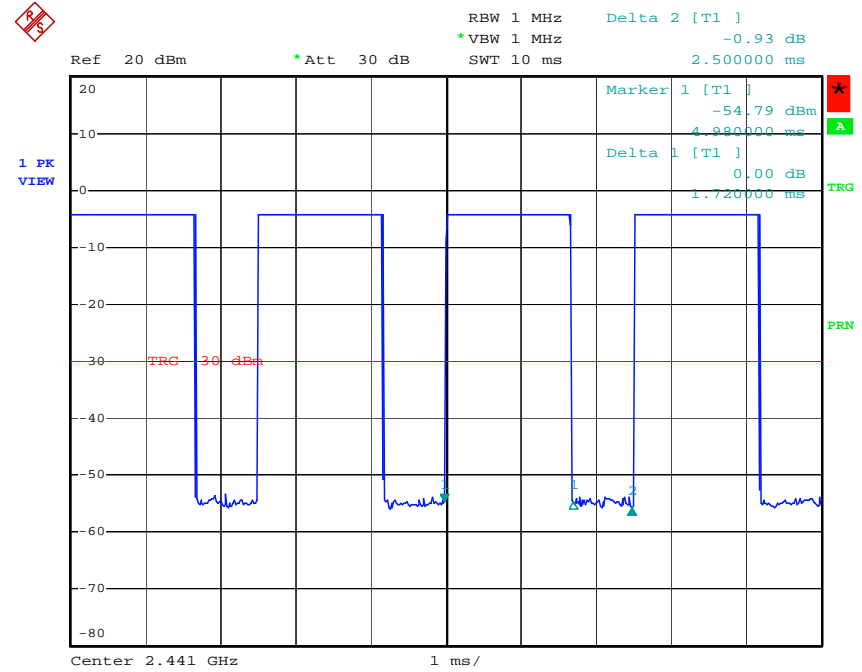

Date: 11.JAN.2005 17:38:19

DH1 Modulation Type: GFSK (Channel 39) :

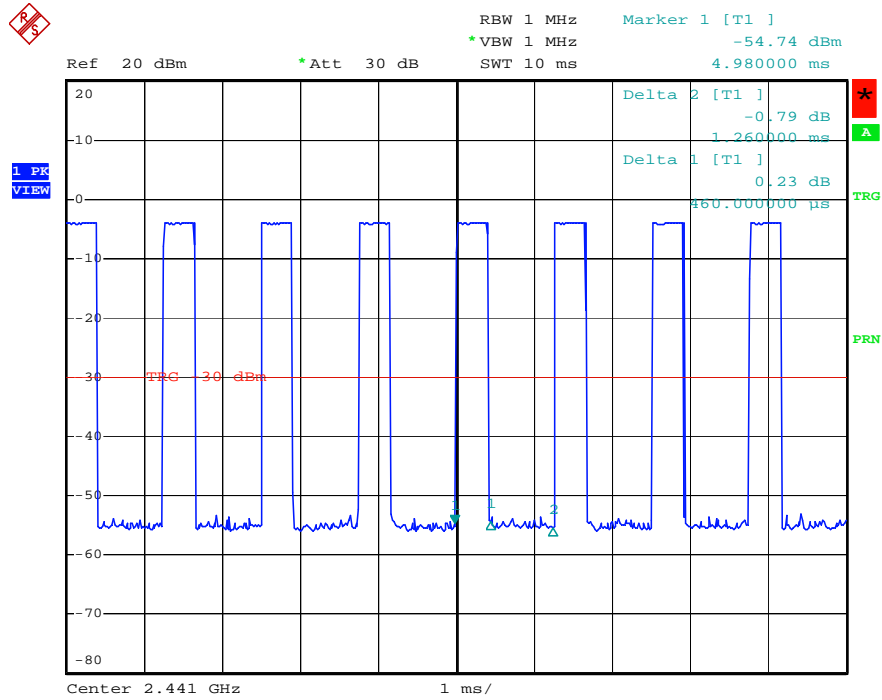

Date: 11.JAN.2005 17:26:33

DH5 Modulation Type: GFSK (Channel 78) :

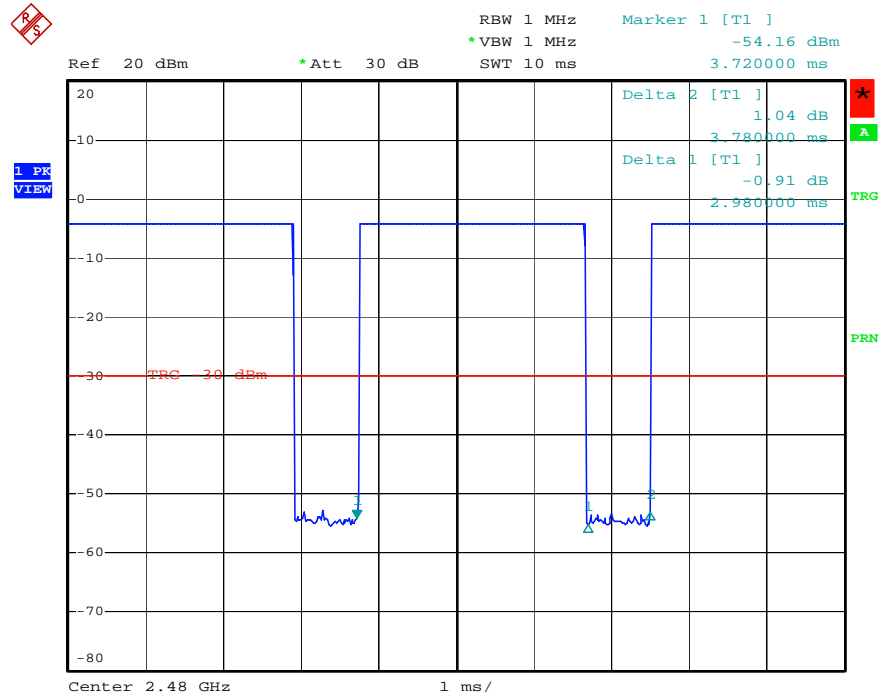

Date: 11.JAN.2005 17:42:18



DH3 Modulation Type: GFSK (Channel 78) :

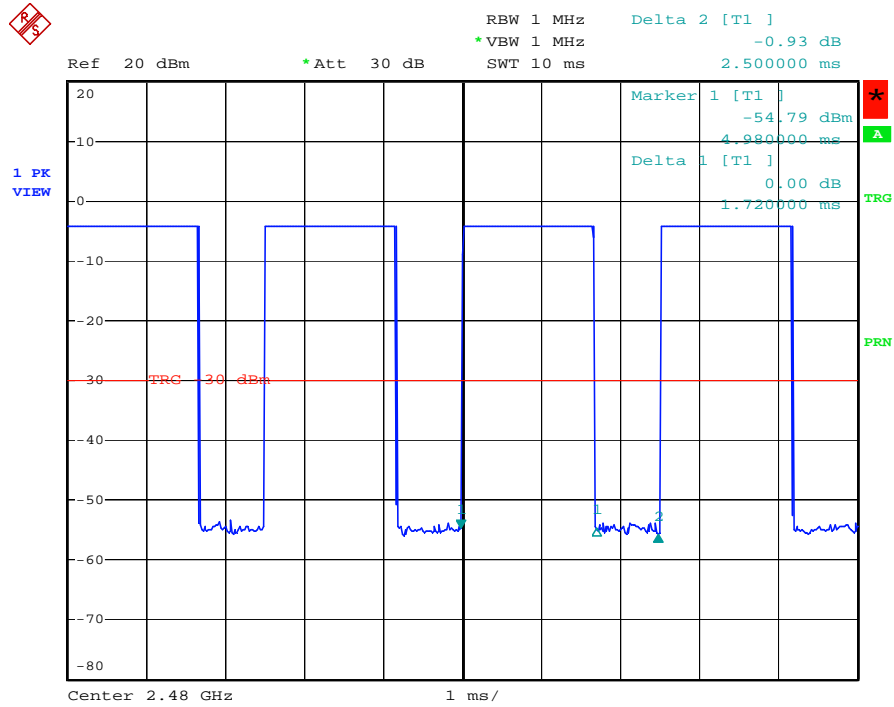

Date: 11.JAN.2005 17:38:56

DH1 Modulation Type: GFSK (Channel 78) :

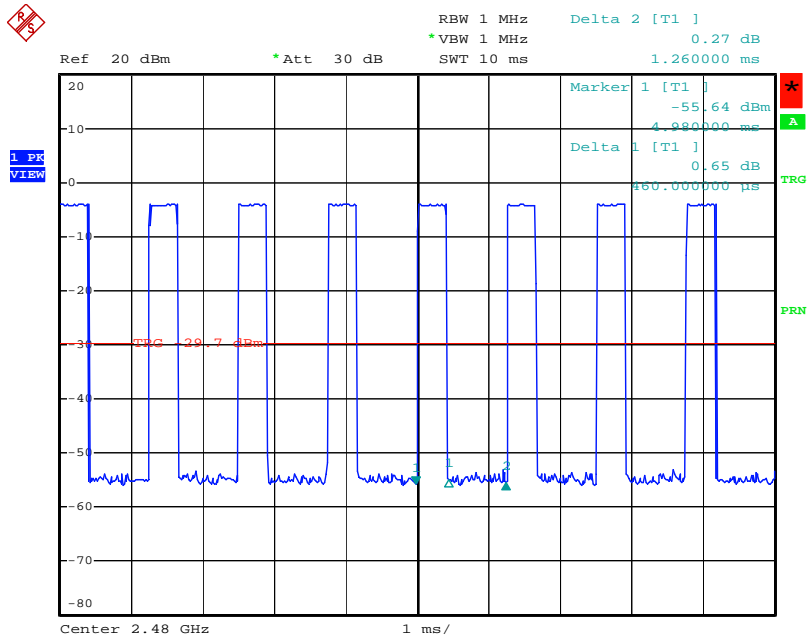

Date: 11.JAN.2005 17:25:14

5.8. Test of Maximum Peak Output Power (Bluetooth)

5.8.1. Applicable Standard

Section 15.247(b)(1): For frequency hopping systems operating in the 2400-2483.5 MHz band employing at least 75 non-overlapping hopping channels and The maximum peak output power shall not exceed 1 watt.

5.8.2. Measuring Instruments

Item 19, 21 of the table is on section 6.

5.8.3. Test Procedures and Test Instruments Setting

1. The transmitter output was connected to the peak power meter and recorded the peak value.
2. Peak power meter parameter set to auto attenuator and filter is the same as.
3. Repeated the 1 for the middle and highest channel of the EUT.

5.8.4. Test Setup Layout

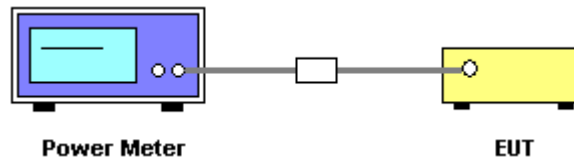

5.8.5. Test Criteria

All test results complied with the requirements of Section 15.247(b)(1). Measurement Uncertainty is 1.5dB.

5.8.6. Test Result of Conducted Peak Power

- Temperature: 24°C
- Relative Humidity: 54%
- Duty Cycle of the Equipment During the Test: 46.64 %
- Test Engineer: Sam Lee

Modulation Type	Channel No.	Frequency (MHz)	Output Power (dBm)	Limits (dBm)
GFSK	00	2402 MHz	-3.00	30
GFSK	39	2441 MHz	-2.10	30
GFSK	78	2480 MHz	-2.80	30



5.8.7. Test Result of EIRP Power

- Temperature: 24°C
- Relative Humidity: 54%
- Duty Cycle of the Equipment During the Test: 46.64 %
- Test Engineer: Sam Lee

Antenna No.	Gain (dBi)	Modulation Type	Channel No.	Frequency (MHz)	Power (dBm)	Limits (dBm)
1	2.24	GFSK	00	2402 MHz	-0.76	36
1	2.24	GFSK	39	2441 MHz	0.14	36
1	2.24	GFSK	78	2480 MHz	-0.56	36

5.9. Test of Band Edges Emission

5.9.1. Applicable Standard

Section 15.247(d): In any 100 kHz bandwidth outside the frequency band in which the spread spectrum or digitally modulated intentional radiator is operating, the radio frequency power that is produced by the intentional radiator shall be at least 20 dB below that in the 100 kHz bandwidth within the band that contains the highest level of the desired power, based on either an RF conducted or a radiated measurement. In addition, radiated emissions that fall in the restricted bands, as defined in Section 15.205, must also comply with the radiated emission limits specified in Section 15.209.

5.9.2. Measuring Instruments

Item 6~17 of the table is on section 6 for radiated measurement.
Item 18 of the table is on section 6 for conducted measurement.

5.9.3. Description of Major Test Instruments Setting

- Spectrum Analyzer : R&S FSP40 (Conducted Measurement)
 - Attenuation : Auto
 - Center Frequency : 2412 MHz / 2462 MHz
 - Span Frequency : 100MHz
 - RB : 100 kHz
 - VB : 100 kHz
 - Detector : Peak
 - Trace : Max Hold
 - Sweep Time : Auto

- Spectrum Analyzer : R&S FSP40 (Radiated Measurement)
 - Attenuation : Auto
 - Center Frequency : 2412 MHz / 2462 MHz
 - Span Frequency : 100MHz
 - RB : 1 MHz for PK value / 1 MHz for AV value
 - VB : 1 MHz for PK value / 10 Hz for AV value
 - Detector : Peak
 - Trace : Max Hold
 - Sweep Time : Auto

5.9.4. Test Procedures and Test Instruments Setting

Conducted Measurement

1. The transmitter is set to the lowest channel.
2. The transmitter output was connected to the spectrum analyzer via a cable and cable loss is used as the offset of the spectrum analyzer.
3. Set both RBW and VBW of spectrum analyzer to 100KHz with convenient frequency span including 100MHz bandwidth from lower band edge. Then detector set to peak and max hold this trace.
4. The lowest band edges emission was measured and recorded.
5. The transmitter set to the highest channel and repeated 2~4.

Radiated Measurement

1. Configure the EUT according to ANSI C63.4.
2. The turntable was rotated by 360 degrees to determine the position of the highest radiation.
3. The height of the broadband receiving antenna was varied between one meter and four meters above ground to find the maximum emission field strength of both horizontal and vertical polarization.
4. For band edge emission, the antenna tower was scan (from 1 M to 4 M) and then the turn table was rotated (from 0 degree to 360 degrees) to find the maximum reading.
5. For band edge emission in restriction bands, use 10Hz VBW and 1MHz RBW for reading under AV and use 1MHz VBW and 1 MHz RBW for reading under PK.

5.9.5. Test Setup

Radiated Method

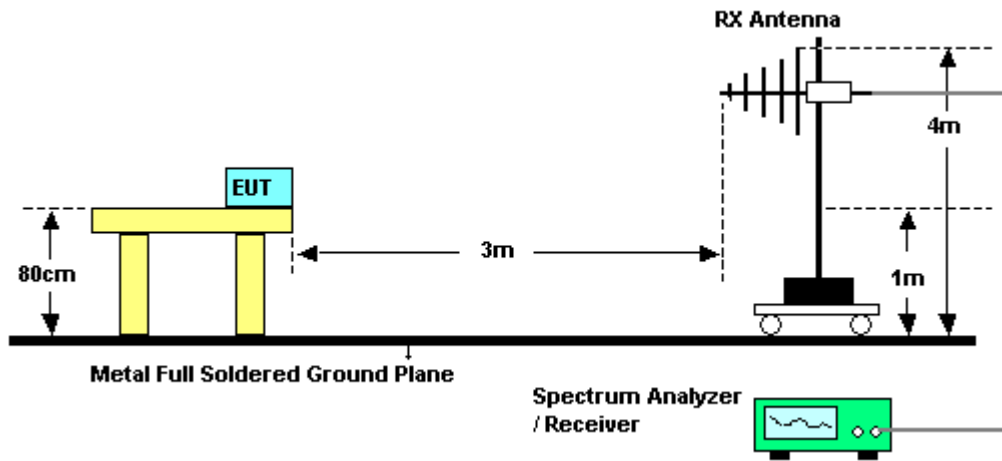

Conducted Method

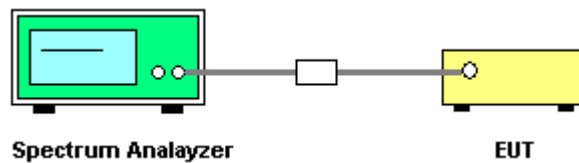

5.9.6. Test Criteria

All test results complied with the requirements of Section 15.247(d). Measurement Uncertainty is 2.26dB.



5.9.7. Test Result of Radiated

- Temperature: 24°C
- Relative Humidity: 54%
- Duty Cycle of the Equipment During the Test: 100.00%
- Test Engineer: Sam Lee

802.11b/g part

Modulation Type	Test Channel	Freq. (MHz)	Level* (dBuV/m)	Margin (dB)	Limit (dBuV/m)	Trace (PK/AV)
DSSS	01	2389.80	55.80	-18.20	74	PK
DSSS	01	2389.80	46.86	-7.14	54	AV
DSSS	11	2484.61	55.13	-18.87	74	PK
DSSS	11	2484.61	44.77	-9.23	54	AV
OFDM	01	2389.99	68.97	-5.03	74	PK
OFDM	01	2389.99	48.93	-5.07	54	AV
OFDM	11	2483.66	61.33	-12.67	74	PK
OFDM	11	2483.66	44.96	-9.04	54	AV

Level*: The max field strength in the restricted bands.

Bluetooth part

Modulation Type	Test Channel	Freq. (MHz)	Level* (dBuV/m)	Margin (dB)	Limit (dBuV/m)	Trace (PK/AV)
GFSK	00	2389.61	53.69	-20.31	74	PK
GFSK	00	2389.61	41.16	-12.84	54	AV
GFSK	78	2483.66	55.06	-18.94	74	PK
GFSK	78	2483.66	44.05	-9.95	54	AV

Level*: The max field strength in the restricted bands.

Test Result of Conducted (802.11b/g part)

Modulation Type: DSSS (Channel 01) :

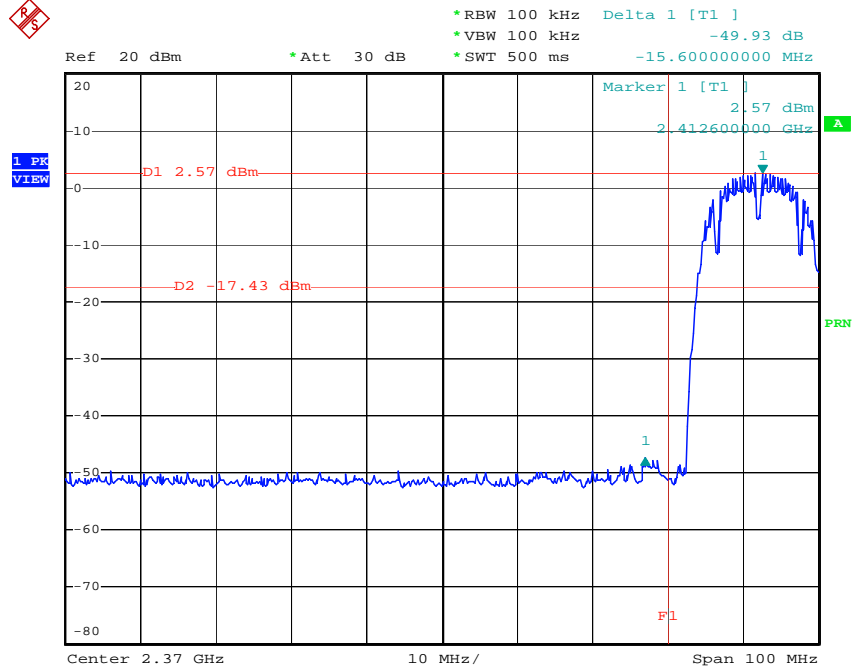

Date: 11.JAN.2005 15:55:45

5.9.8. Modulation Type: DSSS (Channel 11) :

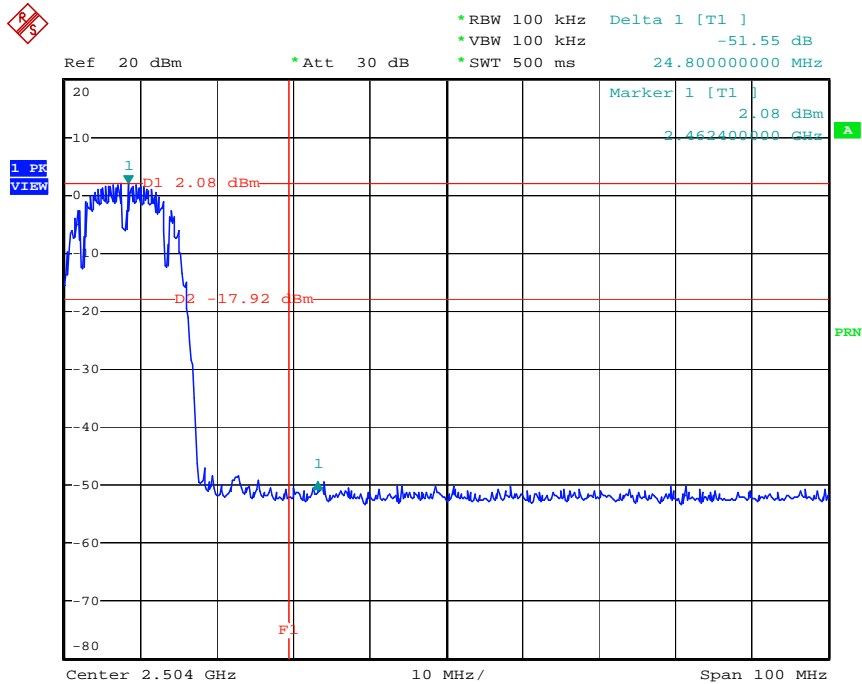

Date: 11.JAN.2005 16:03:34

Modulation Type: OFDM (Channel 01) :

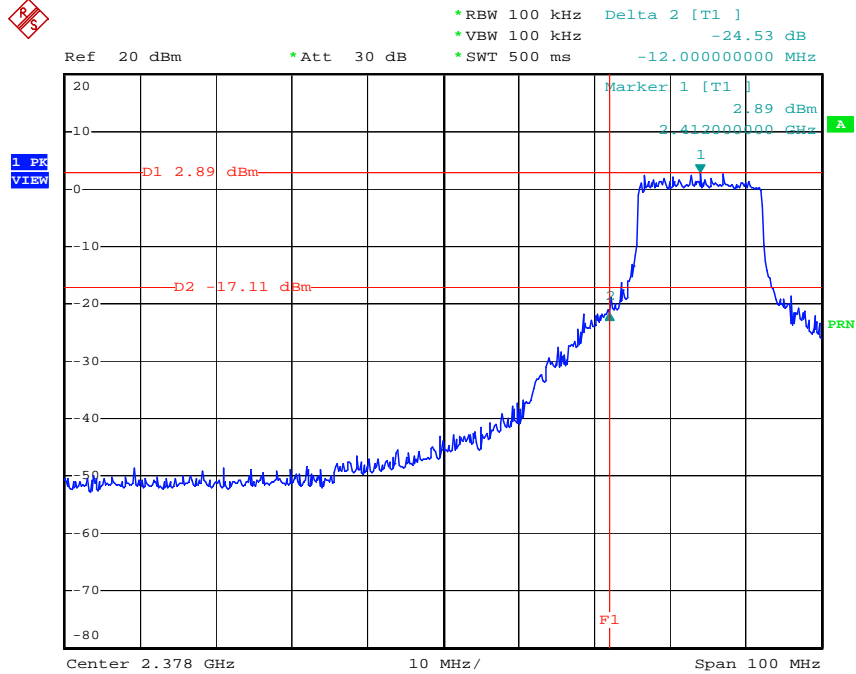

Date: 17.JAN.2005 14:43:39

5.9.9. Modulation Type: OFDM (Channel 11) :

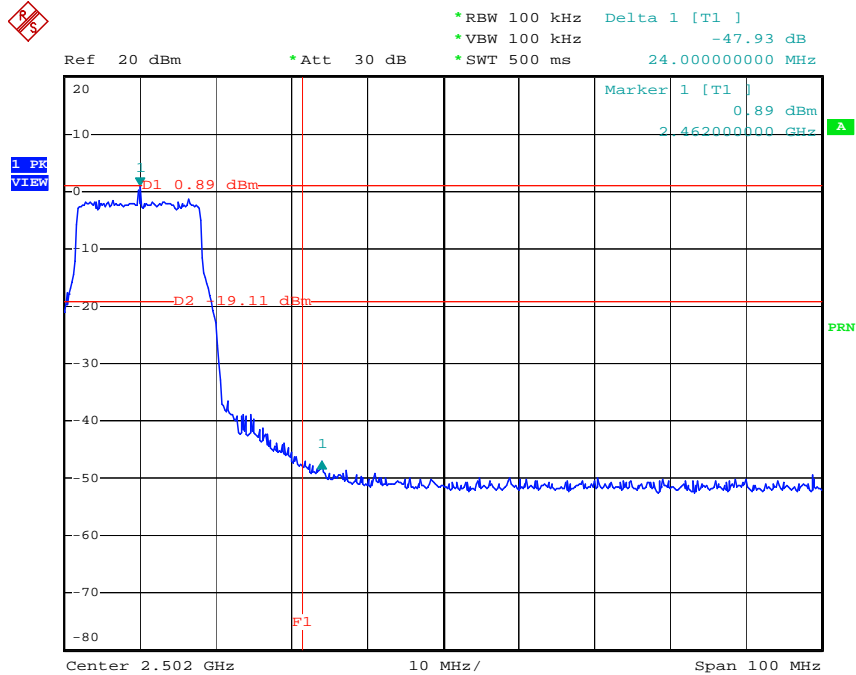

Date: 11.JAN.2005 15:53:14

Test Result of Conducted (Bluetooth part)

Modulation Type: GFSK (Channel 00) :

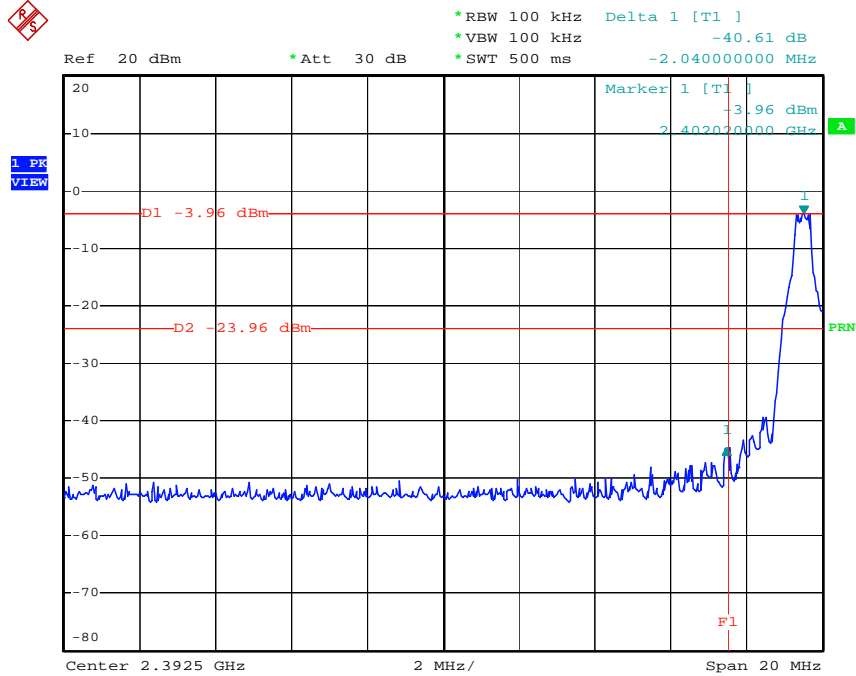

Date: 11.JAN.2005 17:18:06

5.9.10. Modulation Type: GFSK (Channel 78) :

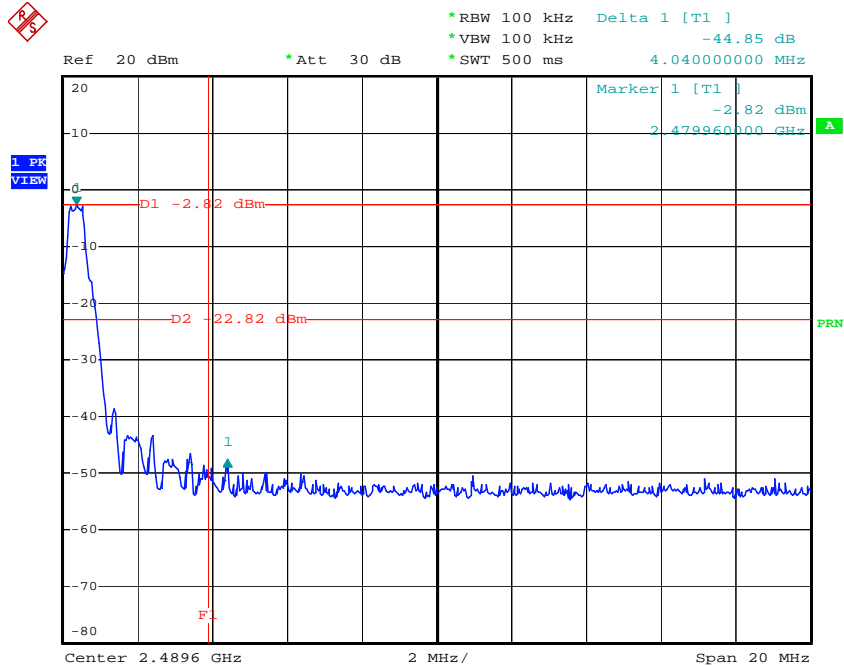

Date: 11.JAN.2005 17:48:02

5.10. Test of AC Power Line Conducted Emission

5.10.1. Applicable Standard

Section 15.247: For a Low-power Radio-frequency Device is designed to be connected to the AC power line, the radio frequency voltage that is conducted back onto the AC power line on any frequency or frequencies within the band 150 kHz to 30 MHz shall not exceed below limits table.

Frequency (MHz)	QP Limit (dBuV)	AV Limit (dBuV)
0.15~0.5	66~56	56~46
0.5~5	56	46
5~30	60	50

5.10.2. Measuring Instruments

Please reference item 1~5 in chapter 6 for the instruments used for testing.

5.10.3. Description of Major Test Instruments Setting

- Test Receiver : R&S ESCS 30
- Attenuation : 10 dB
- Start Frequency : 0.15 MHz
- Stop Frequency : 30 MHz
- IF Bandwidth : 9 KHz

5.10.4. Test Procedures

1. Configure the EUT according to ANSI C63.4.
2. The EUT has to be placed 0.4 meter far from the conducting wall of the shielding room and at least 80 centimeters from any other grounded conducting surface.
3. Connect EUT to the power mains through a line impedance stabilization network (LISN)
4. All the support units are connected to the other LISNs. The LISN should provide 50uH/ 50ohms coupling impedance.
5. The frequency range from 150 KHz to 30 MHz was searched.
6. Use the Channel & Power Controlling software to make the EUT working on selected channel and expected output power, then use the "H" Patter Generator software to make the supporting equipments stay on working condition.
7. Set the test-receiver system to Peak Detect Function and Specified Bandwidth with Maximum Hold Mode.
8. The measurement has to be done between each power line and ground at the power terminal for each RF channel. Only one RF channel has to be investigated since this test is independent with the RF channel selection.

5.10.5. Test Setup Layout

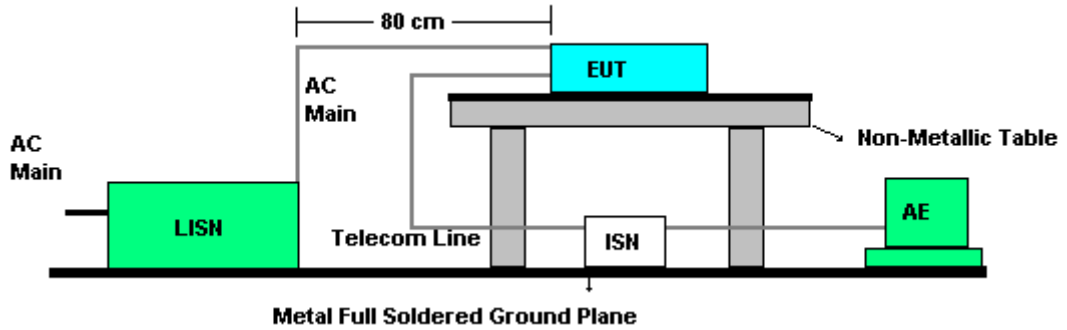

5.10.6. Test Criteria

All test results complied with the requirements of Section 15.247. Measurement Uncertainty is 2.54dB.



5.10.7. Test Result of Conducted Emission for CH 78 / 2480 MHz

- Test Mode : Mode 1
- Temperature: 24°C
- Relative Humidity: 54%
- Test Engineer: Sky Wu

Line to Ground

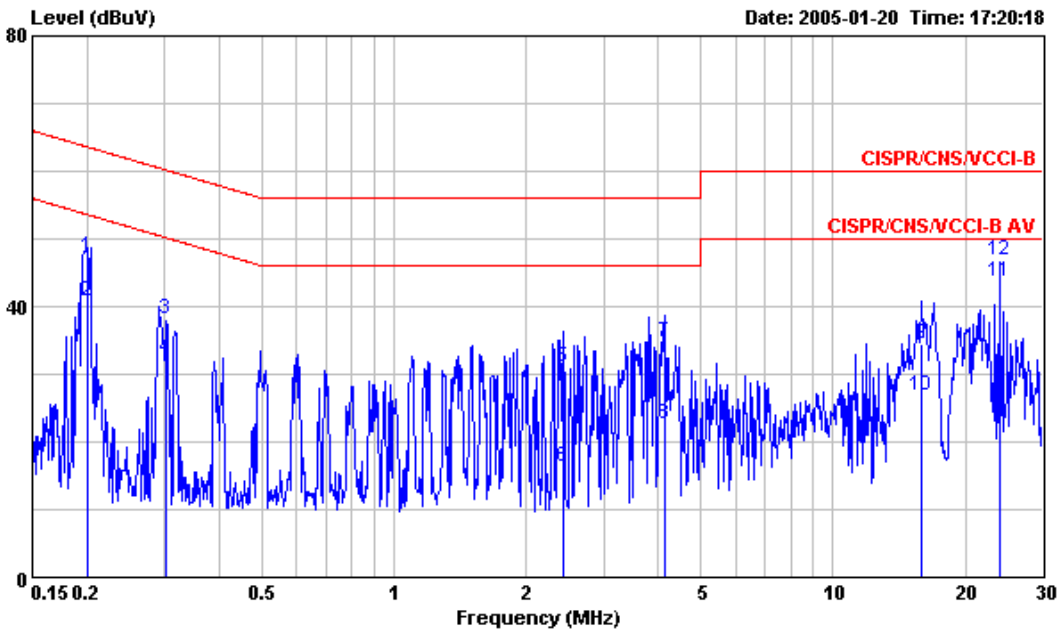

	Freq	Level	Over Limit	Limit Line	Read Level	LISN Factor	Cable Loss	Remark
	MHz	dBuV	dB	dBuV	dBuV	dB	dB	
1	0.2007830	47.35	-16.23	63.58	47.09	0.06	0.20	QP
2	0.2007830	40.80	-12.78	53.58	40.54	0.06	0.20	Average
3	0.3017290	38.27	-21.93	60.20	37.89	0.06	0.32	QP
4	0.3017290	32.31	-17.89	50.20	31.93	0.06	0.32	Average
5	2.420	30.93	-25.07	56.00	30.55	0.14	0.24	QP
6	2.420	16.40	-29.60	46.00	16.02	0.14	0.24	Average
7	4.140	34.73	-21.27	56.00	34.22	0.21	0.30	QP
8	4.140	22.68	-23.32	46.00	22.17	0.21	0.30	Average
9	15.887	34.50	-25.50	60.00	33.63	0.23	0.64	QP
10	15.887	26.85	-23.15	50.00	25.98	0.23	0.64	Average
11	23.876	43.71	-6.29	50.00	43.01	0.31	0.39	Average
12	23.876	46.92	-13.08	60.00	46.22	0.31	0.39	QP



Neutral to Ground

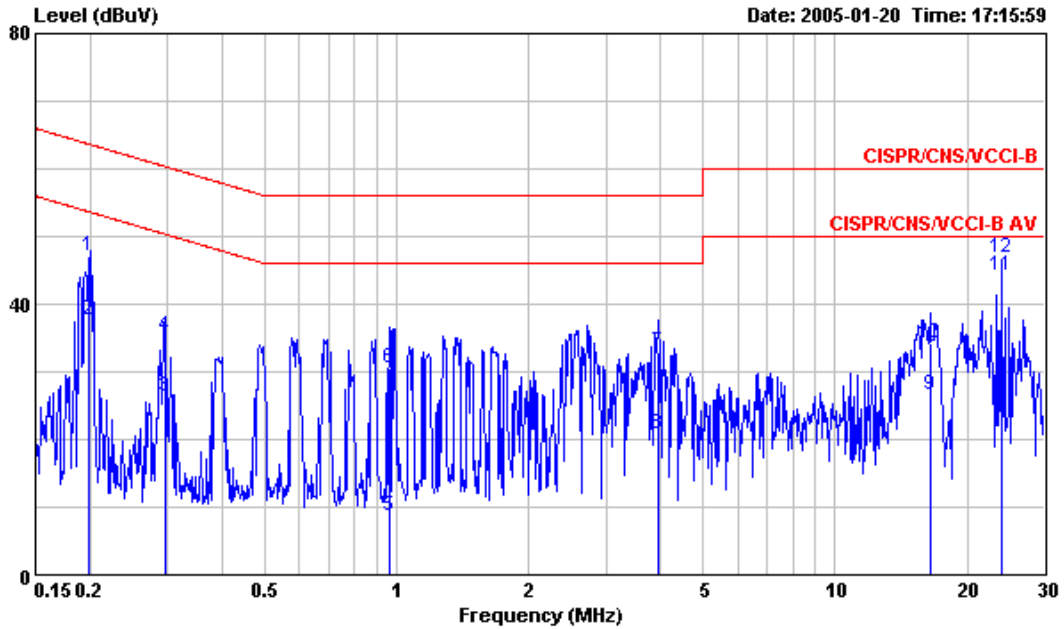

	Freq	Level	Over Limit	Limit Line	Read Level	LISN Factor	Cable Loss	Remark
	MHz	dBuV	dB	dBuV	dBuV	dB	dB	
1	0.1984060	47.21	-16.47	63.68	46.89	0.11	0.21	QP
2	0.1984060	37.56	-16.12	53.68	37.24	0.11	0.21	Average
3	0.2965330	26.32	-24.02	50.34	25.89	0.11	0.32	Average
4	0.2965330	35.32	-25.02	60.34	34.89	0.11	0.32	QP
5	0.9645610	8.73	-37.27	46.00	7.85	0.23	0.65	Average
6	0.9645610	30.60	-25.40	56.00	29.72	0.23	0.65	QP
7	3.941	33.01	-22.99	56.00	32.48	0.23	0.30	QP
8	3.941	20.78	-25.22	46.00	20.25	0.23	0.30	Average
9	16.491	26.61	-23.39	50.00	25.71	0.36	0.54	Average
10	16.491	34.31	-25.69	60.00	33.41	0.36	0.54	QP
11	23.878	44.30	-5.70	50.00	43.40	0.51	0.39	Average
12	23.878	46.90	-13.10	60.00	46.00	0.51	0.39	QP

Note:

Corrected Reading: Probe (LISN / ISN) Factor + Cable Loss + Read Level = Level.

- Test Mode : Mode 2
- Temperature: 24°C
- Relative Humidity: 54%
- Test Engineer: Sky Wu

Line to Ground

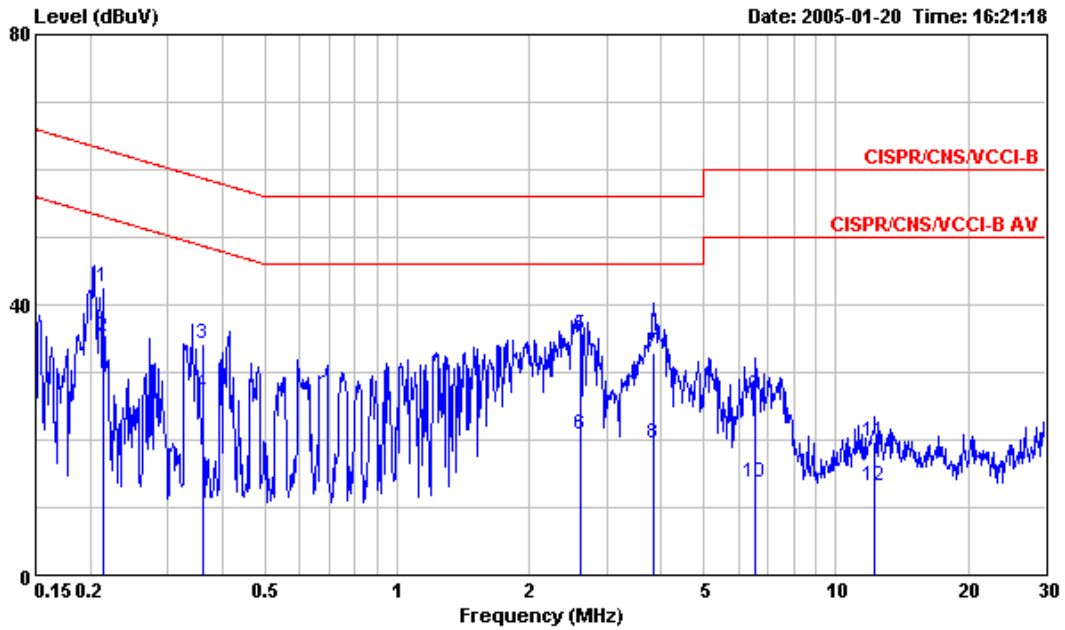

	Freq	Level	Over Limit	Limit Line	Read Level	LISN Factor	Cable Loss	Remark
	MHz	dBuV	dB	dBuV	dBuV	dB	dB	
1	0.2138680	42.51	-20.54	63.05	42.23	0.06	0.22	QP
2	0.2138680	35.36	-17.69	53.05	35.08	0.06	0.22	Average
3	0.3597770	34.33	-24.40	58.73	33.98	0.06	0.29	QP
4	0.3597770	26.79	-21.94	48.73	26.44	0.06	0.29	Average
5	2.610	35.47	-20.53	56.00	35.07	0.15	0.25	QP
6	2.610	20.76	-25.24	46.00	20.36	0.15	0.25	Average
7	3.841	32.83	-23.17	56.00	32.33	0.20	0.30	QP
8	3.841	19.53	-26.47	46.00	19.03	0.20	0.30	Average
9	6.521	26.62	-33.38	60.00	26.16	0.21	0.25	QP
10	6.521	13.77	-36.23	50.00	13.31	0.21	0.25	Average
11	12.250	19.77	-40.23	60.00	18.60	0.21	0.96	QP
12	12.250	13.15	-36.85	50.00	11.98	0.21	0.96	Average



Neutral to Ground

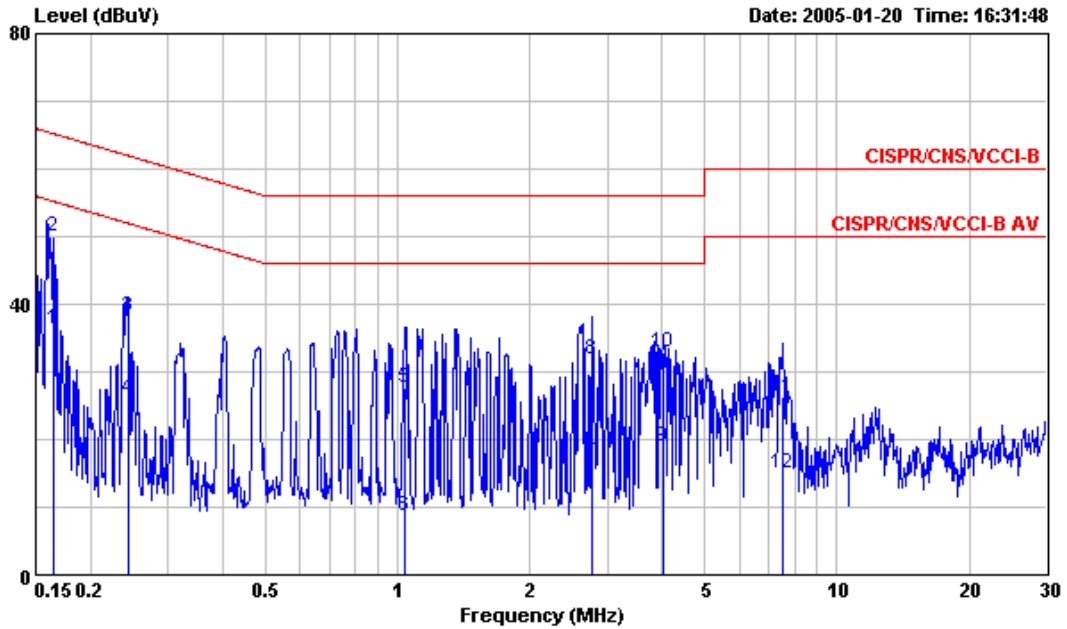

	Freq	Level	Over Limit	Limit Line	Read Level	LISN Factor	Cable Loss	Remark
	MHz	dBuV	dB	dBuV	dBuV	dB	dB	
1	0.1647570	36.24	-18.98	55.22	35.70	0.11	0.43	Average
2	0.1647570	50.01	-15.21	65.22	49.47	0.11	0.43	QP
3	0.2429280	38.04	-23.96	62.00	37.67	0.11	0.26	QP
4	0.2429280	25.94	-26.06	52.00	25.57	0.11	0.26	Average
5	1.041	27.71	-28.29	56.00	26.87	0.23	0.61	QP
6	1.041	8.57	-37.43	46.00	7.73	0.23	0.61	Average
7	2.781	16.67	-29.33	46.00	16.18	0.23	0.26	Average
8	2.781	31.95	-24.05	56.00	31.46	0.23	0.26	QP
9	4.031	18.98	-27.02	46.00	18.45	0.23	0.30	Average
10	4.031	32.97	-23.03	56.00	32.44	0.23	0.30	QP
11	7.530	26.39	-33.61	60.00	25.83	0.30	0.26	QP
12	7.530	15.07	-34.93	50.00	14.51	0.30	0.26	Average

Note:

Corrected Reading: Probe (LISN / ISN) Factor + Cable Loss + Read Level = Level.

- Test Mode : Mode 3
- Temperature: 24°C
- Relative Humidity: 54%
- Test Engineer: Sky Wu

Line to Ground

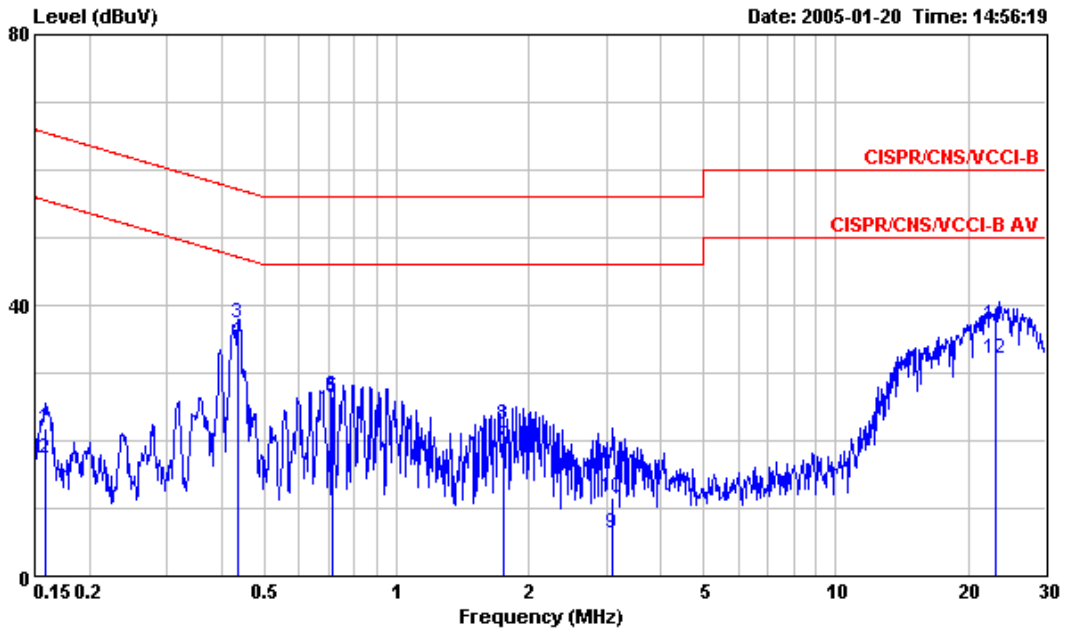

	Freq	Level	Over Limit	Limit Line	Read Level	LISN Factor	Cable Loss	Remark
	MHz	dBuV	dB	dBuV	dBuV	dB	dB	
1	0.1590020	21.78	-43.74	65.52	21.25	0.06	0.47	QP
2	0.1590020	17.42	-38.10	55.52	16.89	0.06	0.47	Average
3	0.4363890	37.24	-19.89	57.13	36.93	0.06	0.25	QP
4	0.4363890	34.77	-12.36	47.13	34.46	0.06	0.25	Average
5	0.7146910	26.28	-19.72	46.00	25.45	0.11	0.72	Average
6	0.7146910	26.69	-29.31	56.00	25.86	0.11	0.72	QP
7	1.751	19.10	-26.90	46.00	18.69	0.11	0.30	Average
8	1.751	22.34	-33.66	56.00	21.93	0.11	0.30	QP
9	3.111	6.30	-39.70	46.00	5.86	0.17	0.27	Average
10	3.111	11.50	-44.50	56.00	11.06	0.17	0.27	QP
11	23.021	37.00	-23.00	60.00	36.30	0.31	0.39	QP
12	23.021	32.16	-17.84	50.00	31.46	0.31	0.39	Average



Neutral to Ground

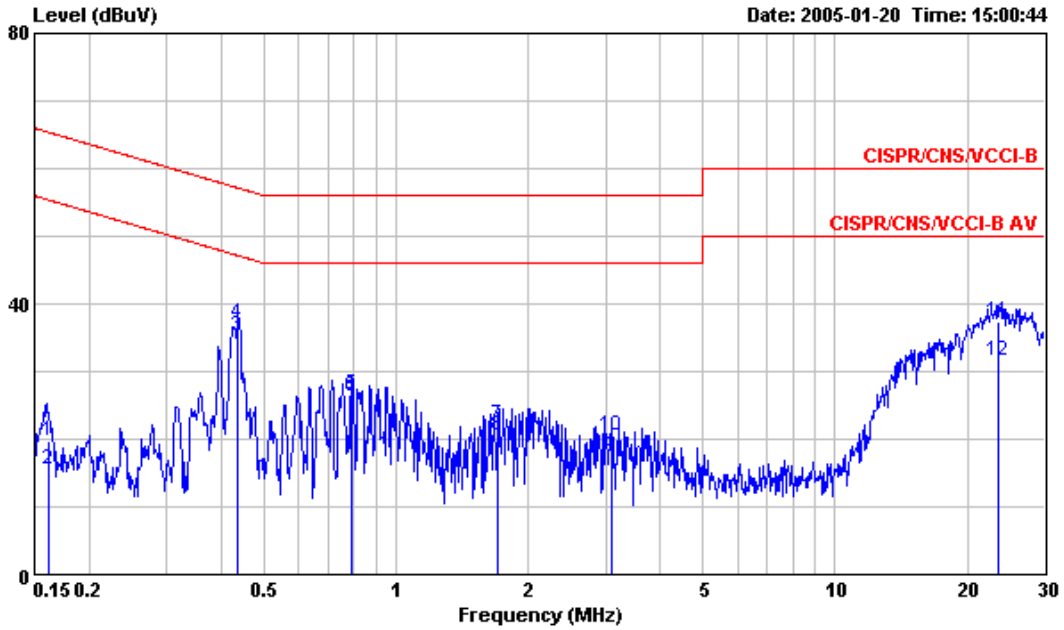

	Freq	Level	Over Limit	Limit Line	Read Level	LISN Factor	Cable Loss	Remark
	MHz	dBuV	dB	dBuV	dBuV	dB	dB	
1	0.1611270	19.80	-45.61	65.41	19.24	0.11	0.45	QP
2	0.1611270	15.60	-39.81	55.41	15.04	0.11	0.45	Average
3	0.4363890	35.23	-11.90	47.13	34.87	0.11	0.25	Average
4	0.4363890	37.11	-20.02	57.13	36.75	0.11	0.25	QP
5	0.7930790	26.63	-29.37	56.00	25.70	0.23	0.70	QP
6	0.7930790	26.26	-19.74	46.00	25.33	0.23	0.70	Average
7	1.707	22.12	-33.88	56.00	21.57	0.23	0.32	QP
8	1.707	20.53	-25.47	46.00	19.98	0.23	0.32	Average
9	3.096	17.39	-28.61	46.00	16.89	0.23	0.27	Average
10	3.096	20.64	-35.36	56.00	20.14	0.23	0.27	QP
11	23.462	37.33	-22.67	60.00	36.44	0.50	0.39	QP
12	23.462	31.65	-18.35	50.00	30.76	0.50	0.39	Average

Note:

Corrected Reading: Probe (LISN / ISN) Factor + Cable Loss + Read Level = Level.

5.10.8. Photographs of Conducted Emission Test Configuration

Mode 1

FRONT VIEW



REAR VIEW



Mode 2

FRONT VIEW

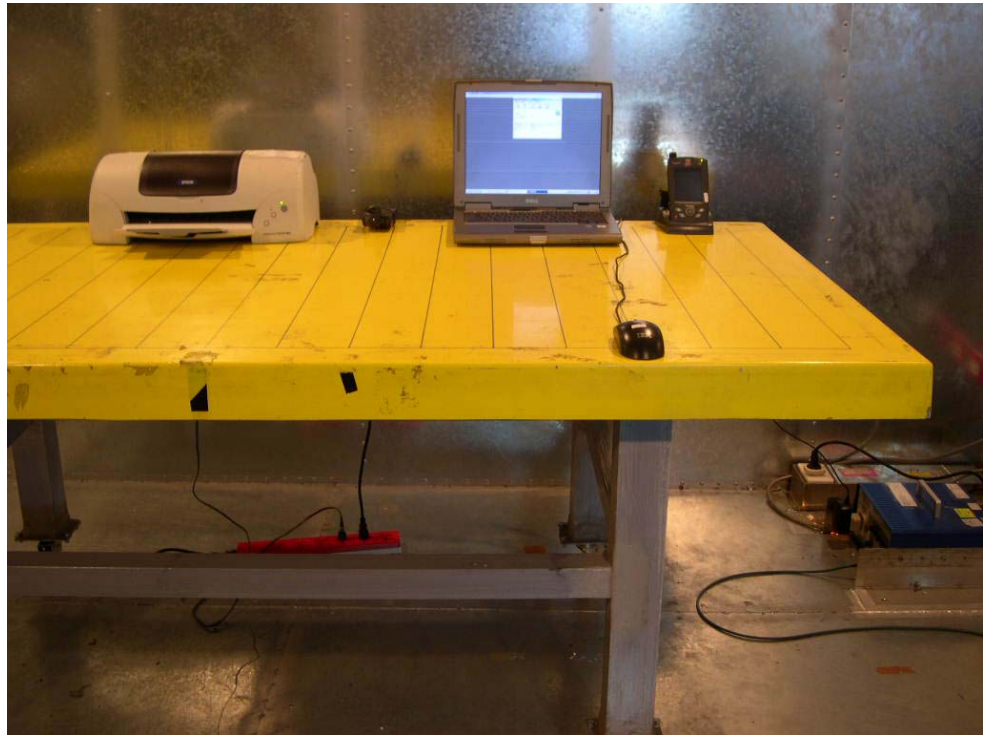

REAR VIEW



Mode 3

FRONT VIEW



REAR VIEW



5.11. Test of Spurious Radiated Emission

5.11.1. Applicable Standard

Section 15.247(d): In any 100 kHz bandwidth outside the frequency band in which the spread spectrum or digitally modulated intentional radiator is operating, the radio frequency power that is produced by the intentional radiator shall be at least 20 dB below that in the 100 kHz bandwidth within the band that contains the highest level of the desired power, based on either an RF conducted or a radiated measurement. In addition, radiated emissions that fall in the restricted bands, as defined in Section 15.205, must also comply with the radiated emission limits specified in Section 15.209.

5.11.2. Measuring Instruments

Please reference item 1~17 in chapter 6 for the instruments used for testing.

5.11.3. Description of Major Test Instruments Setting

- Spectrum Analyzer : R&S FSP40
 - Attenuation : Auto
 - Start Frequency : 1000 MHz
 - Stop Frequency : 10th carrier harmonic
 - RB / VB : 1 MHz / 1MHz for Peak
 - RB / VB : 1 MHz / 10Hz for Average

- Test Receiver : R&S ESCS 30
 - Attenuation : Auto
 - Start Frequency : 30 MHz
 - Stop Frequency : 1000 MHz
 - RB : 120 KHz for QP or PK

5.11.4. Test Procedures

1. Configure the EUT according to ANSI C63.4.
2. The EUT was placed on the top of the turntable 0.8 meter above ground.
3. The phase center of the receiving antenna mounted on the top of a height-variable antenna tower was placed 3 meters far away from the turntable.
4. Power on the EUT and all the supporting units.
5. The turntable was rotated by 360 degrees to determine the position of the highest radiation.
6. The height of the broadband receiving antenna was varied between one meter and four meters above ground to find the maximum emission field strength of both horizontal and vertical polarization.
7. For each suspected emission, the antenna tower was scan (from 1 M to 4 M) and then the turntable was rotated (from 0 degree to 360 degrees) to find the maximum reading.
8. Set the test-receiver system to Peak or CISPR quasi-peak Detect Function with specified bandwidth under Maximum Hold Mode.
9. For emission above 1GHz, use 1MHz VBW and RBW for peak reading. Then 1MHz RBW and 10Hz VBW for average reading in spectrum analyzer.

10. If the emission level of the EUT in peak mode was 3 dB lower than the average limit specified, then testing will be stopped and peak values of EUT will be reported, otherwise, the emissions which do not have 3 dB margin will be repeated one by one using the quasi-peak method for below 1GHz and average method for above the 1GHz. the reported.
11. For testing above 1GHz, the emission level of the EUT in peak mode was 20dB higher than average limit (that means the emission level in peak mode also complies with the limit in average mode), then testing will be stopped and peak values of EUT will be reported, otherwise, the emissions will be measured in average mode again and reported.

5.11.5. Test Setup Layout

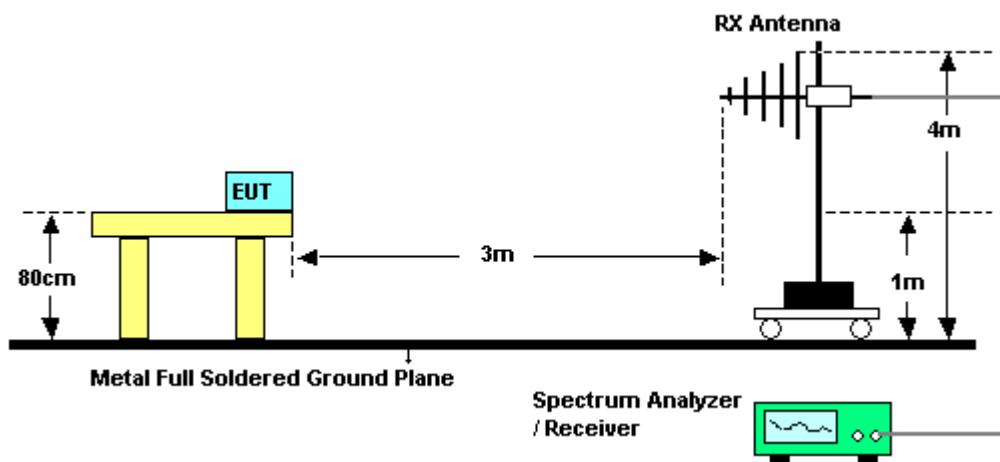

5.11.6. Test Criteria

All test results complied with the requirements of Section 15.247(d). Measurement Uncertainty is 2.26dB.



5.11.7. Test Results for CH 11 / 2462 MHz (for emission below 1GHz)

- Cradle Mode
- Modulation Type: OFDM
- Temperature: 24°C
- Relative Humidity: 54%
- Duty Cycle of the Equipment During the Test: 100.00%
- Test Engineer: Ted Chiu

(A) Polarization: Horizontal

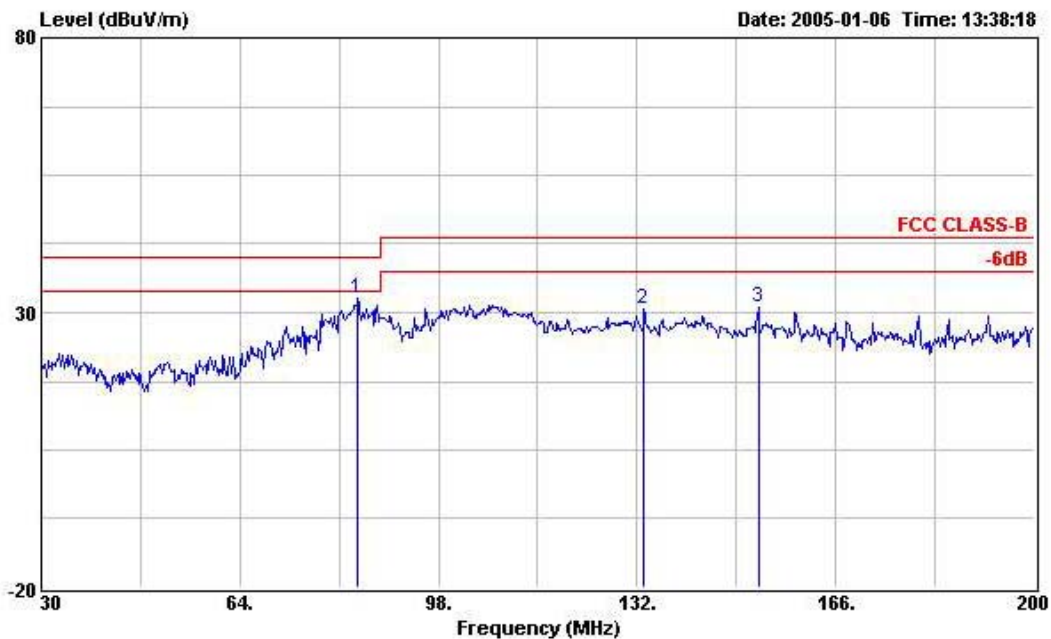

	Freq	Level	Over Limit	Limit Line	Read Level	Probe Factor	Cable Loss	Preamp Factor	Remark	Ant Pos	Table Pos
	MHz	dBuV/m	dB	dBuV/m	dBuV	dB	dB	dB		cm	deg
1	84.230	32.64	-7.36	40.00	50.88	9.08	0.00	27.32	Peak	---	---
2	133.190	30.74	-12.76	43.50	45.45	12.42	0.00	27.13	Peak	---	---
3	152.740	30.92	-12.58	43.50	45.91	12.10	0.00	27.09	Peak	---	---

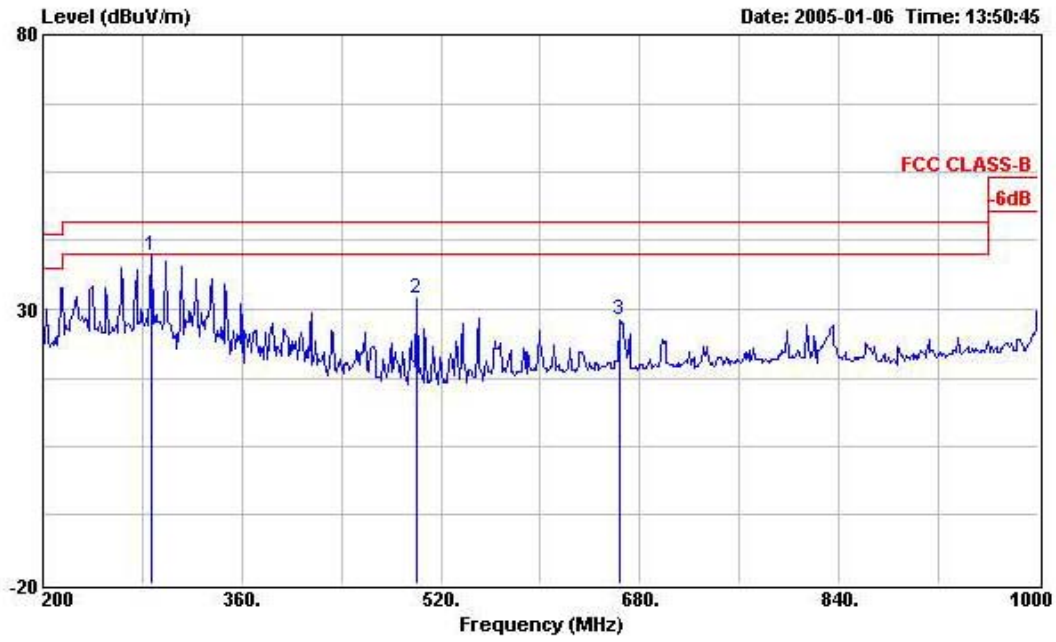

	Freq	Level	Over	Limit	Read	Probe	Cable	Preamp	Remark	Ant	Table
	MHz	dBuV/m	dB	dBuV/m	dBuV	dB	dB	dB		cm	deg
1	288.000	39.77	-6.23	46.00	52.87	13.46	0.00	26.56	Peak	---	---
2	500.000	31.84	-14.16	46.00	43.94	16.00	0.00	28.10	Peak	---	---
3	663.200	28.02	-17.98	46.00	35.64	20.59	0.00	28.21	Peak	---	---



(B) Polarization: Vertical

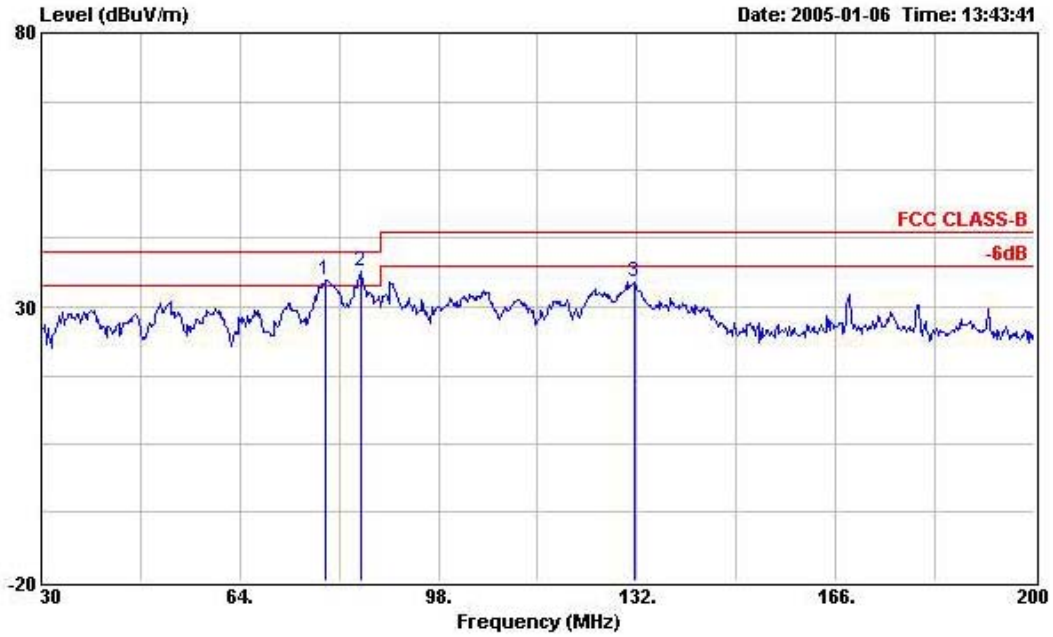

	Freq	Level	Over Limit	Limit Line	Read Level	Probe Factor	Cable Loss	Preamp Factor	Remark	Ant Pos	Table Pos
	MHz	dBuV/m	dB	dBuV/m	dBuV	dB	dB	dB		cm	deg
1	78.790	35.01	-4.99	40.00	52.84	9.54	0.00	27.37	Peak	---	---
2	84.740	36.55	-3.45	40.00	54.84	9.03	0.00	27.32	Peak	---	---
3	131.660	34.53	-8.97	43.50	49.29	12.38	0.00	27.14	Peak	---	---

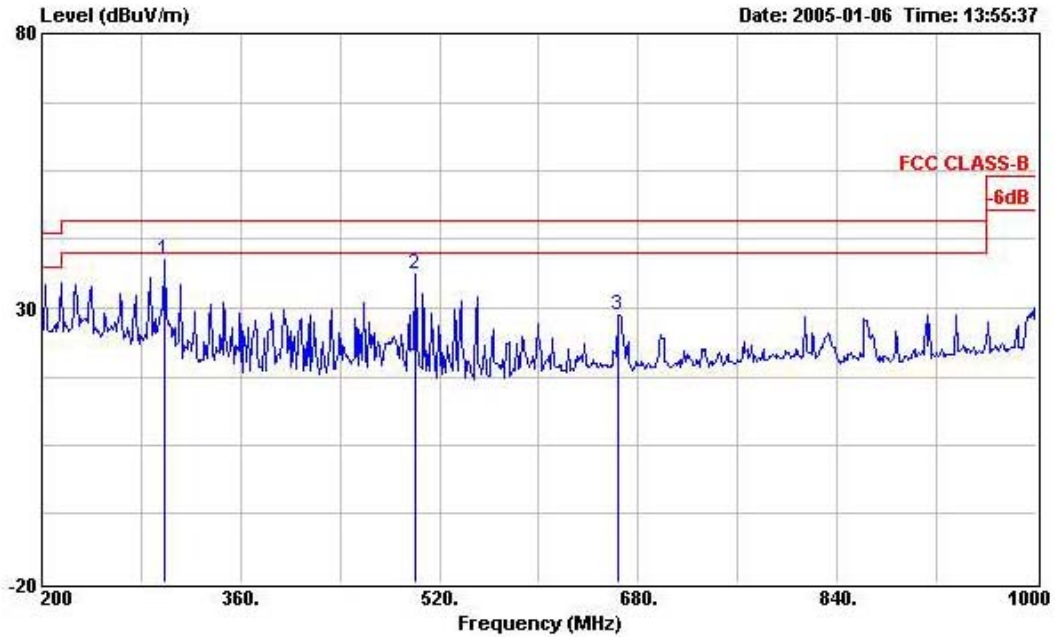

	Freq	Level	Over Limit	Limit Line	Read Level	Probe Factor	Cable Loss	Preamp Factor	Remark	Ant Pos	Table Pos
	MHz	dBuV/m	dB	dBuV/m	dBuV	dB	dB	dB		cm	deg
1	298.400	38.86	-7.14	46.00	51.62	13.75	0.00	26.51	Peak	---	---
2	500.000	36.03	-9.97	46.00	48.13	16.00	0.00	28.10	Peak	---	---
3	663.200	28.77	-17.23	46.00	36.39	20.59	0.00	28.21	Peak	---	---

Note:

Emission level (dBuV/m) = 20 log Emission level (uV/m)

Corrected Reading: Probe Factor + Cable Loss + Read Level - Preamp Factor = Level



5.11.8. Test Results for CH 01 / 2412 MHz (for emission above 1GHz)

- Modulation Type: DSSS
- Temperature: 24°C
- Relative Humidity: 54%
- Duty Cycle of the Equipment During the Test: 100.00%
- Test Engineer: Ted Chiu

(A) Polarization: Horizontal

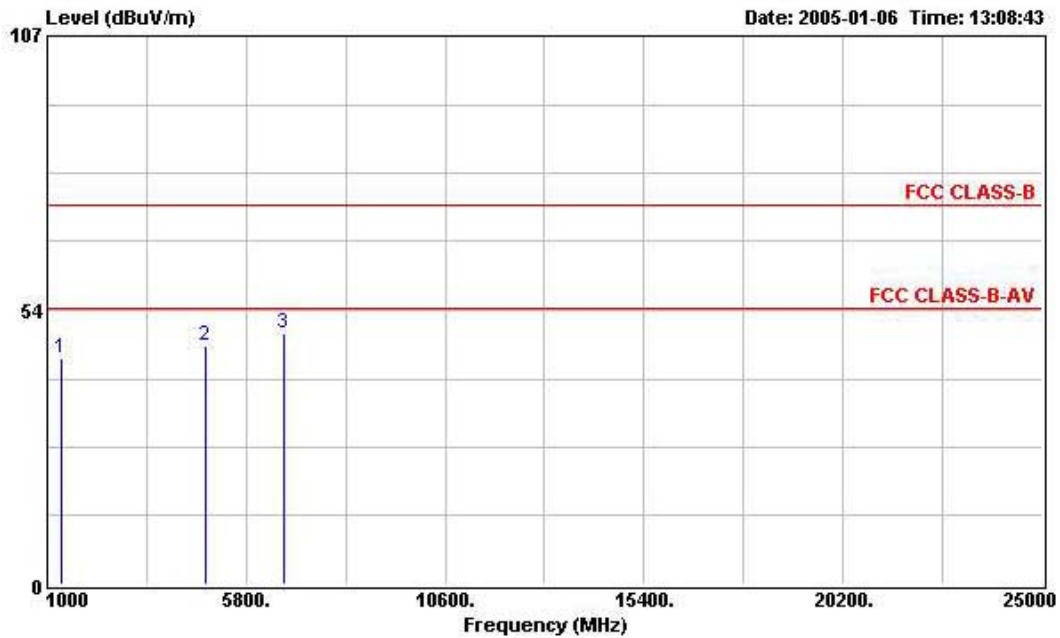

	Freq	Level	Over	Limit	Read	Probe	Cable	Preamp	Remark	Ant	Table
	MHz	dBuV/m	Limit	Line	Level	Factor	Loss	Factor		Pos	Pos
			dB	dBuV/m	dBuV	dB	dB	dB		cm	deg
1	1332.000	44.13	-29.87	74.00	57.12	24.82	1.39	39.20	Peak	---	---
2	4824.000	46.58	-27.42	74.00	50.92	32.96	2.84	40.14	Peak	---	---
3	6728.000	49.00	-25.00	74.00	50.50	34.66	3.47	39.63	Peak	---	---



(B) Polarization: Vertical

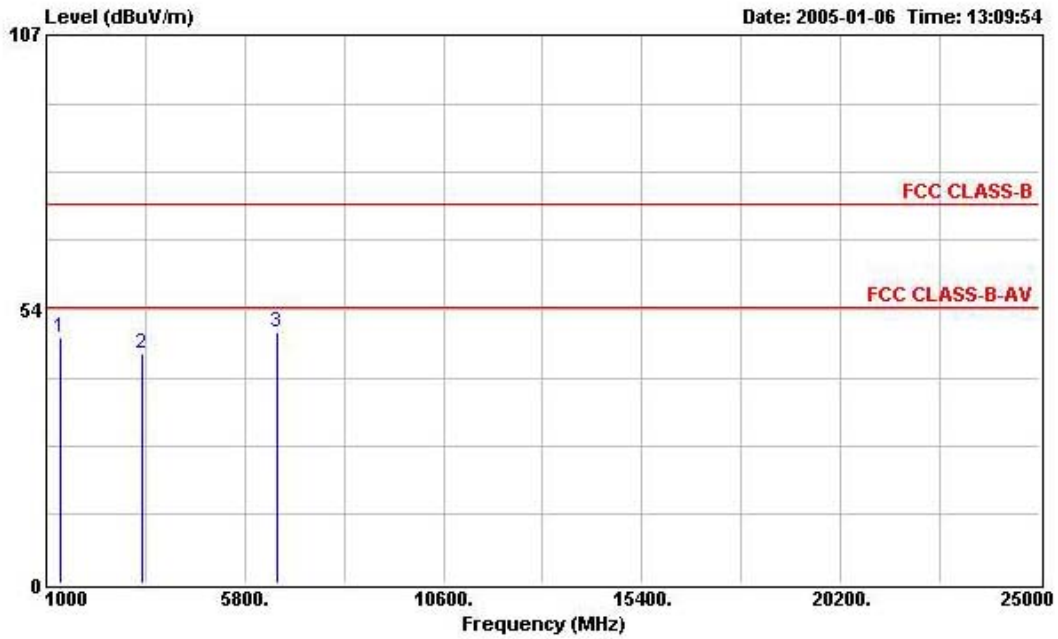

	Freq	Level	Over	Limit	Read	Probe	Cable	Preamp	Remark	Ant	Table
	MHz	dBuV/m	Limit	Line	Level	Factor	Loss	Factor		Pos	Pos
			dB	dBuV/m	dBuV	dB	dB	dB		cm	deg
1	1332.000	47.86	-26.14	74.00	60.85	24.82	1.39	39.20	Peak	---	---
2	3336.000	44.92	-29.08	74.00	50.87	30.82	2.30	39.07	Peak	---	---
3	6600.000	49.13	-24.87	74.00	50.93	34.44	3.43	39.67	Peak	---	---

Note:

Emission level (dBuV/m) = 20 log Emission level (uV/m)

Corrected Reading: Probe Factor + Cable Loss + Read Level - Preamp Factor = Level



- Modulation Type: OFDM
- Temperature: 24°C
- Relative Humidity: 54%
- Duty Cycle of the Equipment During the Test: 100.00%
- Test Engineer: Ted Chiu

(A) Polarization: Horizontal

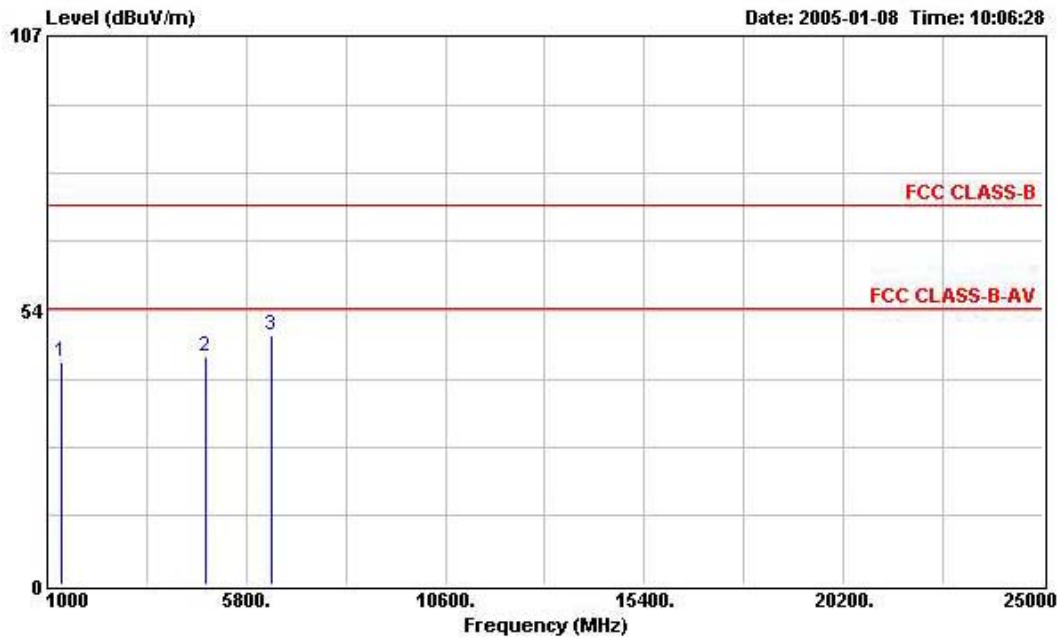

	Freq	Level	Over	Limit	Read	Probe	Cable	Preamp	Remark	Ant	Table
	MHz	dBuV/m	Limit	Line	Level	Factor	Loss	Factor		Pos	Pos
			dB	dBuV/m	dBuV	dB	dB	dB		cm	deg
1	1328.000	43.26	-30.74	74.00	56.25	24.82	1.39	39.20	Peak	---	---
2	4824.000	44.54	-29.46	74.00	48.88	32.96	2.84	40.14	Peak	---	---
3	6416.000	48.55	-25.45	74.00	50.62	34.27	3.38	39.72	Peak	---	---



(B) Polarization: Vertical

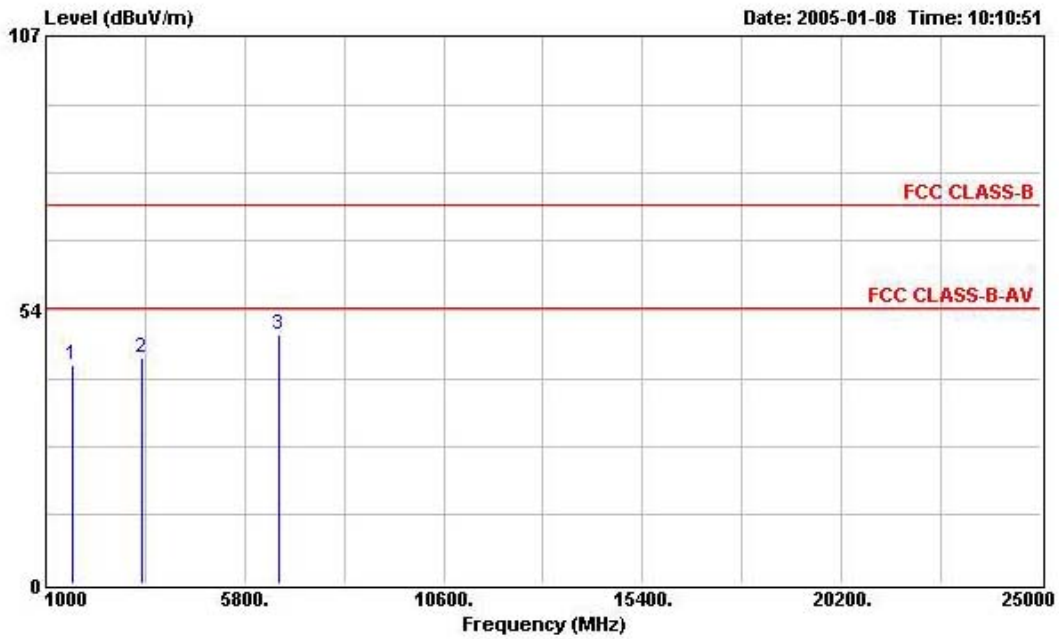

	Freq	Level	Over	Limit	Read	Probe	Cable	Preamp	Remark	Ant	Table
	MHz	dBuV/m	dB	dBuV/m	dBuV	dB	dB	dB		cm	deg
1	1660.000	42.61	-31.39	74.00	54.46	25.94	1.55	39.34	Peak	---	---
2	3328.000	44.19	-29.81	74.00	50.14	30.82	2.30	39.07	Peak	---	---
3	6644.000	48.67	-25.33	74.00	50.37	34.52	3.44	39.66	Peak	---	---

Note:

Emission level (dBuV/m) = 20 log Emission level (uV/m)

Corrected Reading: Probe Factor + Cable Loss + Read Level - Preamp Factor = Level



5.11.9. Test Results for CH 06 / 2437 MHz (for emission above 1GHz)

- Modulation Type: DSSS
- Temperature: 24°C
- Relative Humidity: 54%
- Duty Cycle of the Equipment During the Test: 100.00%
- Test Engineer: Ted Chiu

(A) Polarization: Horizontal

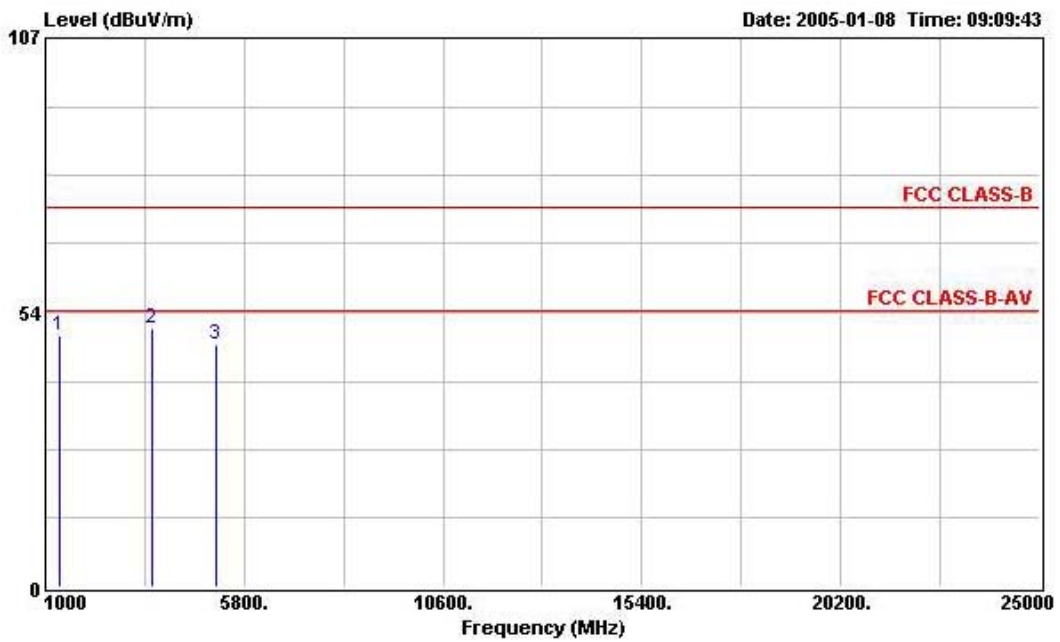

	Freq	Level	Over	Limit	Read	Probe	Cable	Preamp	Remark	Ant	Table
	MHz	dBuV/m	Limit	Line	Level	Factor	Loss	Factor		Pos	Pos
			dB	dBuV/m	dBuV	dB	dB	dB		cm	deg
1	1332.000	48.85	-25.15	74.00	61.84	24.82	1.39	39.20	Peak	---	---
2	3564.000	50.21	-23.79	74.00	55.45	31.38	2.37	38.99	Peak	---	---
3	5136.000	47.33	-26.67	74.00	50.98	33.49	2.97	40.11	Peak	---	---



(B) Polarization: Vertical

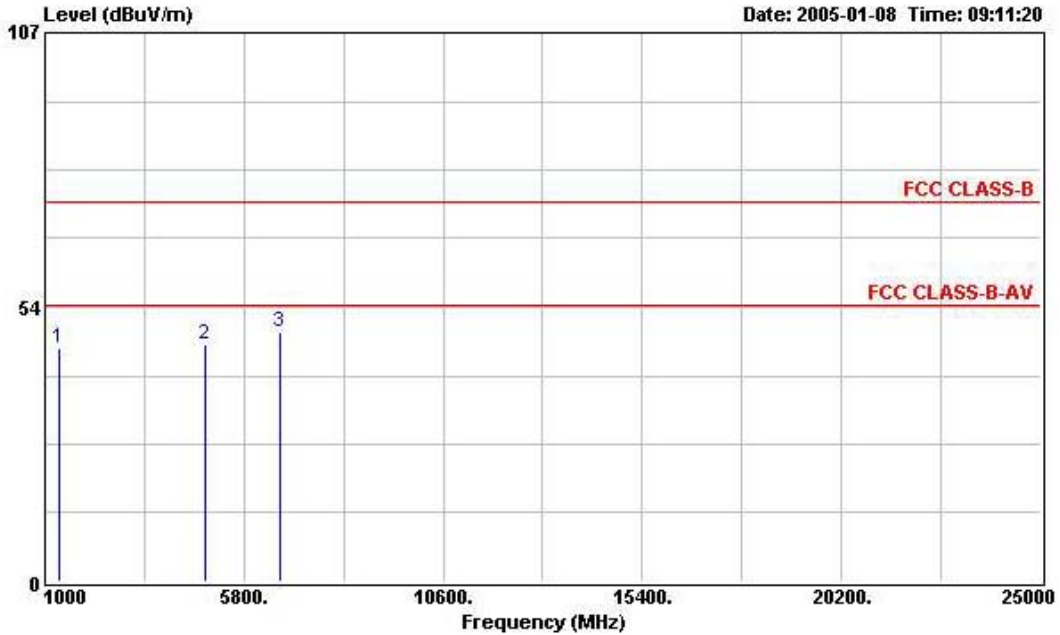

	Freq	Level	Over	Limit	Read	Probe	Cable	Preamp	Remark	Ant	Table
	MHz	dBuV/m	Limit	Line	Level	Factor	Loss	Factor		Pos	Pos
			dB	dBuV/m	dBuV	dB	dB	dB		cm	deg
1	1332.000	45.40	-28.60	74.00	58.39	24.82	1.39	39.20	Peak	---	---
2	4876.000	46.32	-27.68	74.00	50.48	33.11	2.87	40.14	Peak	---	---
3	6676.000	48.58	-25.42	74.00	50.23	34.55	3.45	39.65	Peak	---	---

Note:

Emission level (dBUV/m) = 20 log Emission level (uV/m)

Corrected Reading: Probe Factor + Cable Loss + Read Level - Preamp Factor = Level



- Modulation Type: OFDM
- Temperature: 24°C
- Relative Humidity: 54%
- Duty Cycle of the Equipment During the Test: 100.00%
- Test Engineer: Ted Chiu

(A) Polarization: Horizontal

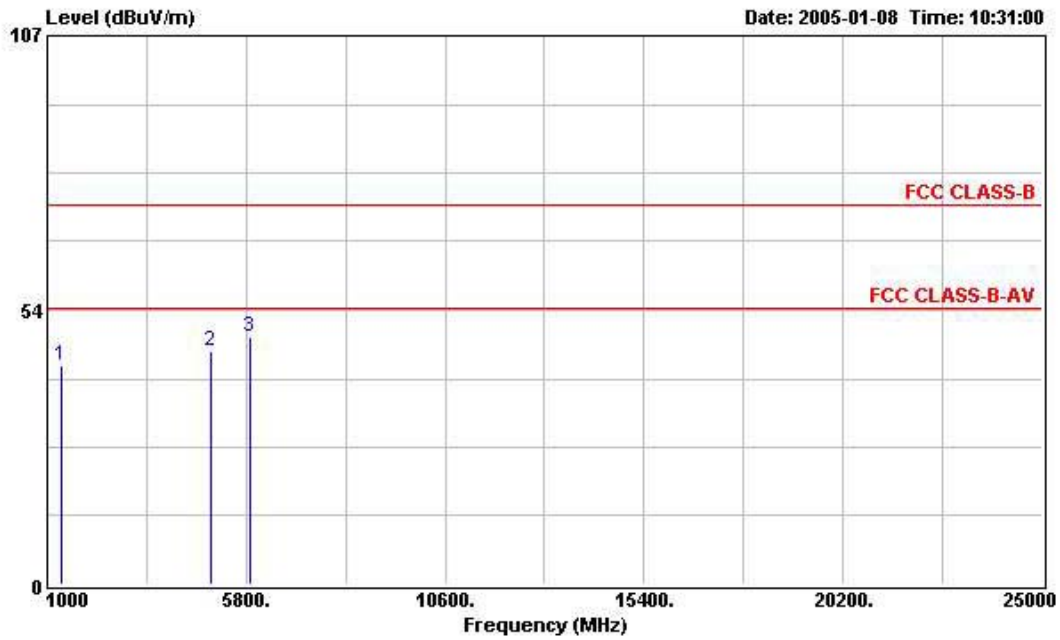

	Freq	Level	Over Limit	Limit Line	Read Level	Probe Factor	Cable Loss	Preamp Factor	Remark	Ant Pos	Table Pos
	MHz	dBuV/m	dB	dBuV/m	dBuV	dB	dB	dB		cm	deg
1	1328.000	42.88	-31.12	74.00	55.87	24.82	1.39	39.20	Peak	---	---
2	4948.000	45.51	-28.49	74.00	49.55	33.21	2.90	40.15	Peak	---	---
3	5912.000	48.23	-25.77	74.00	50.78	34.08	3.24	39.87	Peak	---	---



(B) Polarization: Vertical

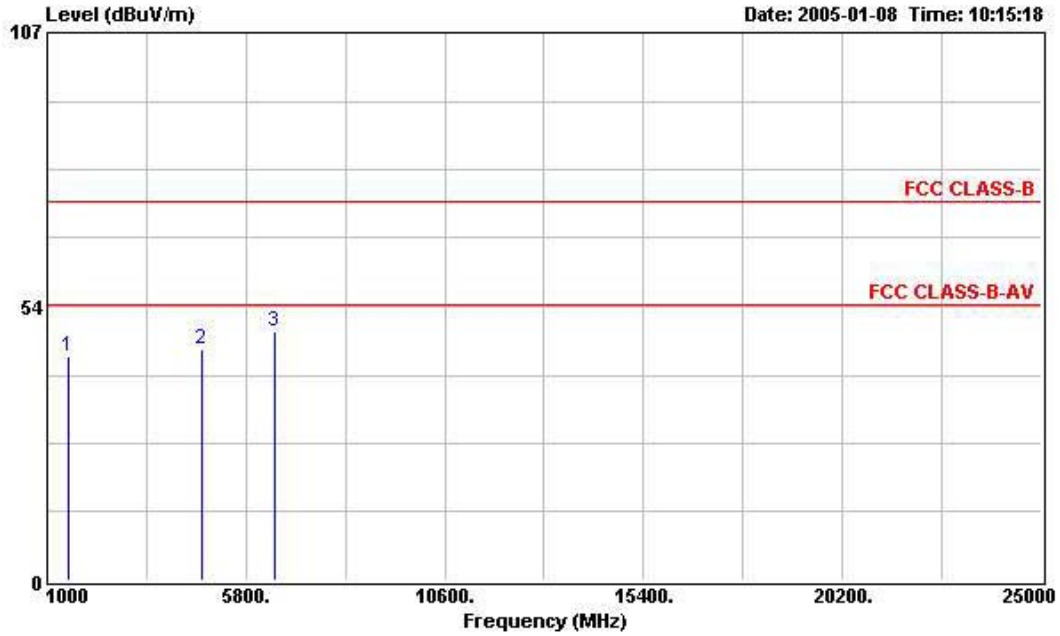

	Freq	Level	Over	Limit	Read	Probe	Cable	Preamp	Remark	Ant	Table
	MHz	dBuV/m	Limit	Line	Level	Factor	Loss	Factor		Pos	Pos
			dB	dBuV/m	dBuV	dB	dB	dB		cm	deg
1	1500.000	43.82	-30.18	74.00	56.35	25.18	1.47	39.18	Peak	---	---
2	4740.000	45.02	-28.98	74.00	49.51	32.83	2.81	40.13	Peak	---	---
3	6488.000	48.48	-25.52	74.00	50.49	34.29	3.40	39.70	Peak	---	---

Note:

Emission level (dBuV/m) = 20 log Emission level (uV/m)

Corrected Reading: Probe Factor + Cable Loss + Read Level - Preamp Factor = Level



5.11.10. Test Results for CH 11 / 2462 MHz (for emission above 1GHz)

- Modulation Type: DSSS
- Temperature: 24°C
- Relative Humidity: 54%
- Duty Cycle of the Equipment During the Test: 100.00%
- Test Engineer: Ted Chiu

(A) Polarization: Horizontal

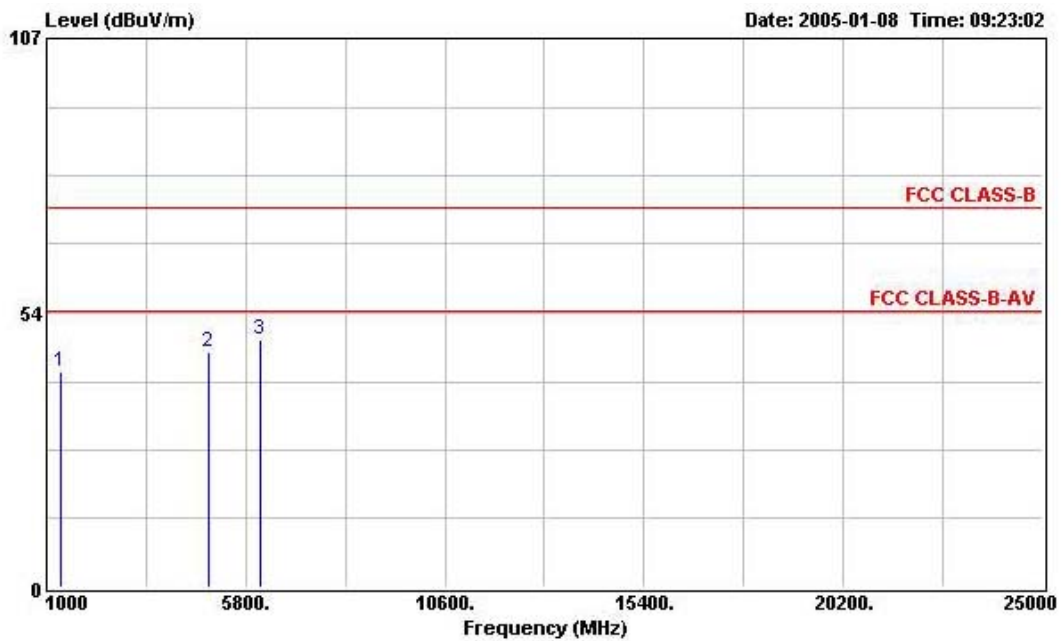

	Freq	Level	Over	Limit	Read	Probe	Cable	Preamp	Remark	Ant	Table
	MHz	dBuV/m	Limit	Line	Level	Factor	Loss	Factor		Pos	Pos
			dB	dBuV/m	dBuV	dB	dB	dB		cm	deg
1	1332.000	42.12	-31.88	74.00	55.11	24.82	1.39	39.20	Peak	---	---
2	4928.000	45.92	-28.08	74.00	49.96	33.21	2.90	40.15	Peak	---	---
3	6156.000	48.36	-25.64	74.00	50.69	34.17	3.30	39.80	Peak	---	---



(B) Polarization: Vertical

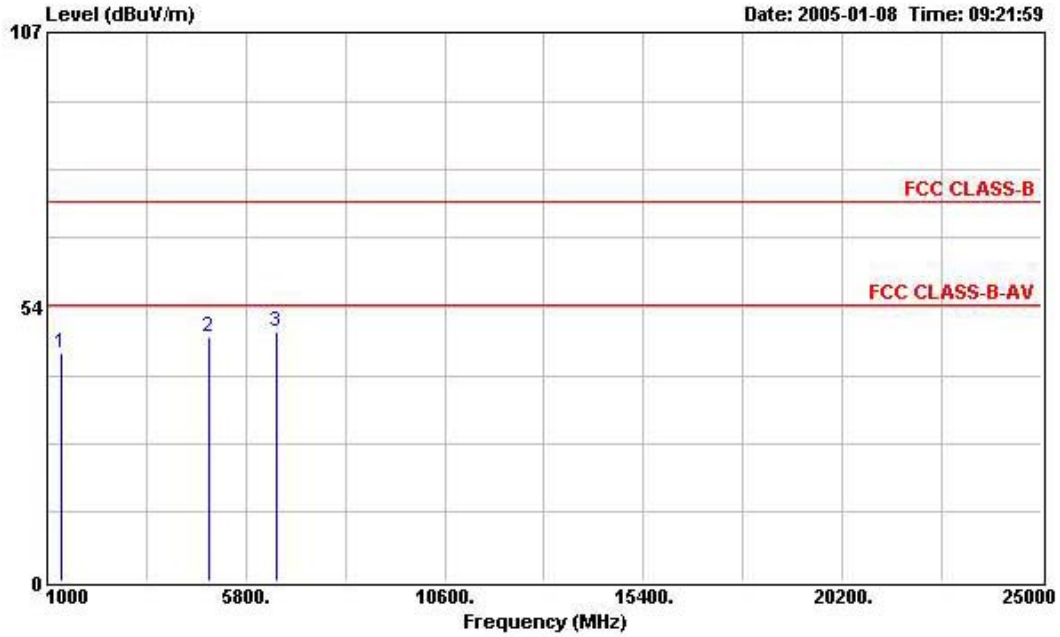

	Freq	Level	Over Limit	Limit Line	Read Level	Probe Factor	Cable Loss	Preamp Factor	Remark	Ant Pos	Table Pos
	MHz	dBuV/m	dB	dBuV/m	dBuV	dB	dB	dB		cm	deg
1	1332.000	44.38	-29.62	74.00	57.37	24.82	1.39	39.20	Peak	---	---
2	4928.000	47.70	-26.30	74.00	51.74	33.21	2.90	40.15	Peak	---	---
3	6548.000	48.49	-25.51	74.00	50.41	34.36	3.41	39.69	Peak	---	---

Note:

Emission level (dBUV/m) = 20 log Emission level (uV/m)

Corrected Reading: Probe Factor + Cable Loss + Read Level - Preamp Factor = Level



- Modulation Type: OFDM
- Temperature: 24°C
- Relative Humidity: 54%
- Duty Cycle of the Equipment During the Test: 100.00%
- Test Engineer: Ted Chiu

(A) Polarization: Horizontal

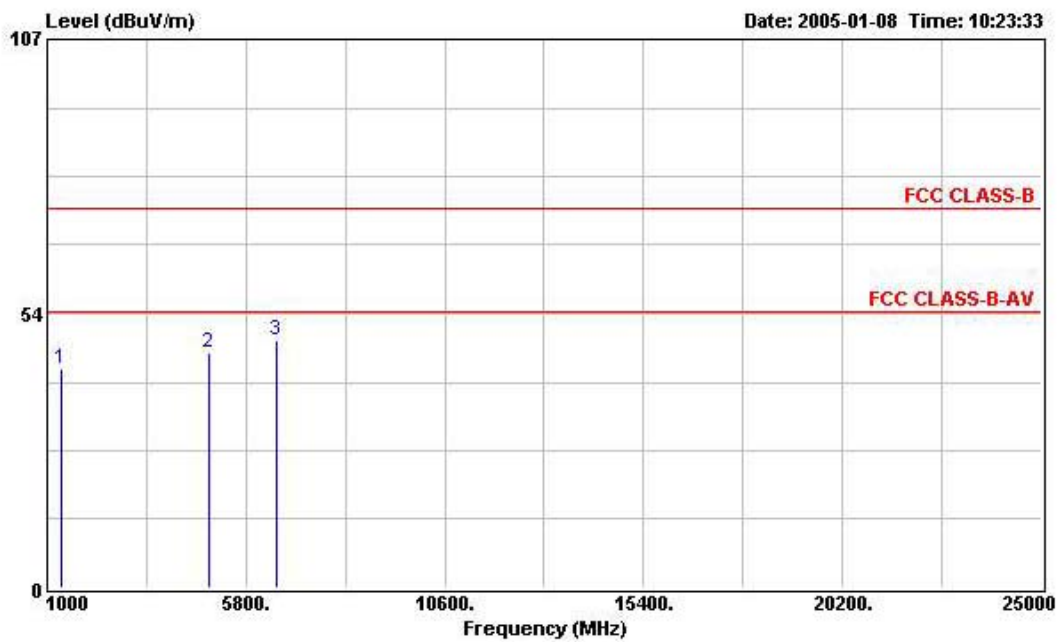

	Freq	Level	Over	Limit	Read	Probe	Cable	Preamp	Remark	Ant	Table
	MHz	dBuV/m	Limit	Line	Level	Factor	Loss	Factor		cm	deg
			dB	dBuV/m	dBuV	dB	dB	dB			
1	1328.000	42.68	-31.32	74.00	55.67	24.82	1.39	39.20	Peak	---	---
2	4924.000	46.00	-28.00	74.00	50.04	33.21	2.90	40.15	Peak	---	---
3	6520.000	48.14	-25.86	74.00	50.09	34.33	3.41	39.69	Peak	---	---



(B) Polarization: Vertical

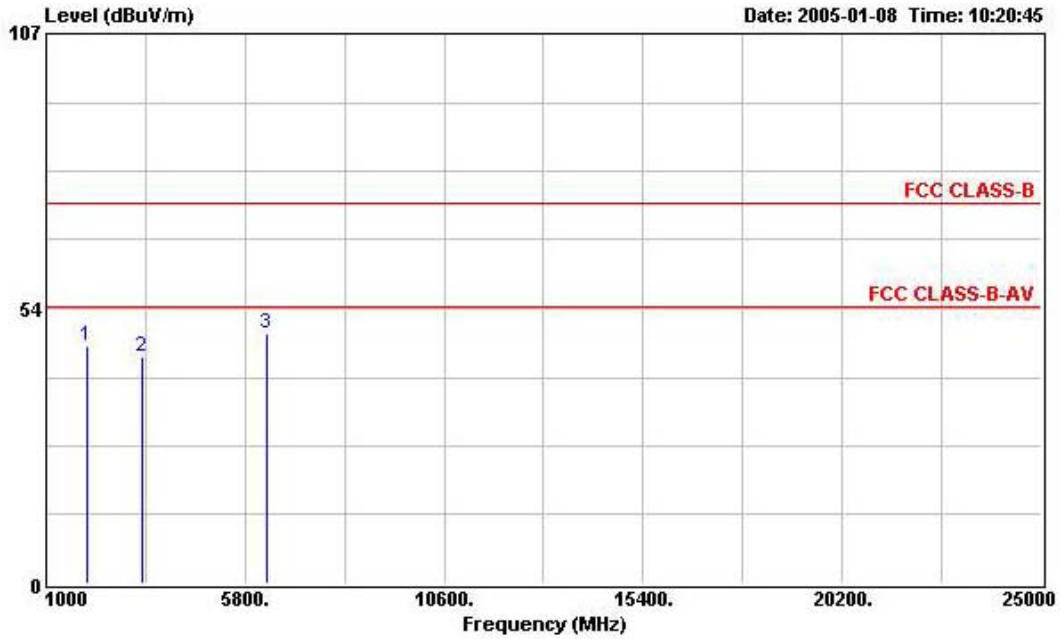

	Freq	Level	Over	Limit	Read	Probe	Cable	Preamp	Remark	Ant	Table
	MHz	dBuV/m	Limit	Line	Level	Factor	Loss	Factor		Pos	Pos
			dB	dBuV/m	dBuV	dB	dB	dB		cm	deg
1	2000.000	46.15	-27.85	74.00	56.68	27.40	1.72	39.65	Peak	---	---
2	3336.000	44.05	-29.95	74.00	50.00	30.82	2.30	39.07	Peak	---	---
3	6320.000	48.51	-25.49	74.00	50.68	34.23	3.35	39.75	Peak	---	---

Note:

Emission level (dBuV/m) = 20 log Emission level (uV/m)

Corrected Reading: Probe Factor + Cable Loss + Read Level - Preamp Factor = Level



5.11.11. Test Results for CH 78 / 2480MHz (for emission below 1GHz)

- W/O Cradle Mode
- Modulation Type: GFSK
- Temperature: 24°C
- Relative Humidity: 54%
- Duty Cycle of the Equipment During the Test: 46.64 %
- Test Engineer: Ted Chiu

(A) Polarization: Horizontal

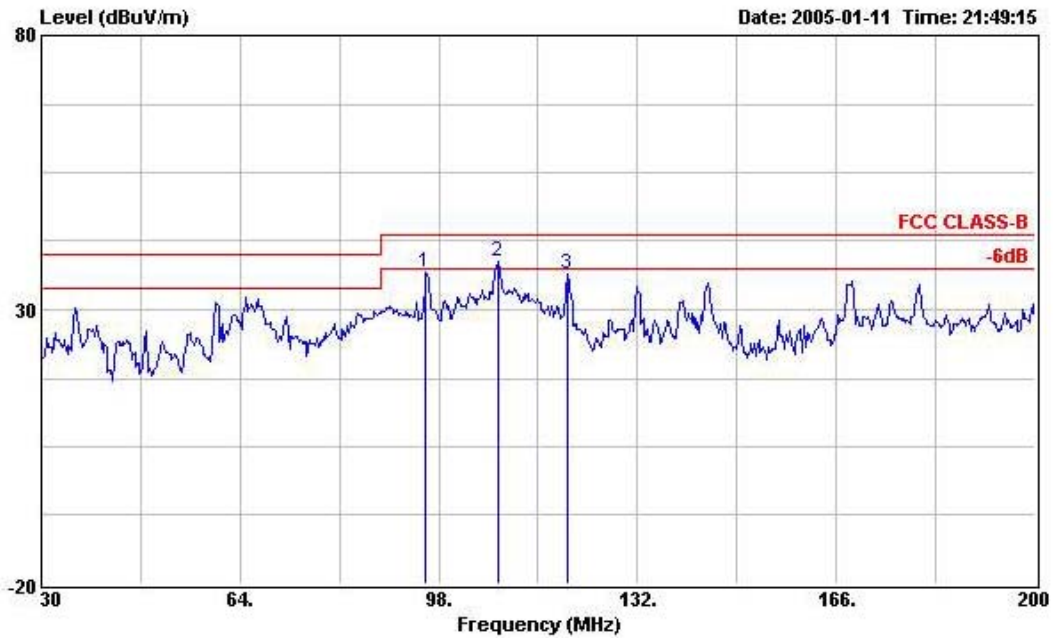

	Freq	Level	Over Limit	Limit Line	Read Level	Probe Factor	Cable Loss	Preamp Factor	Remark	Ant Pos	Table Pos
	MHz	dBuV/m	dB	dBuV/m	dBuV	dB	dB	dB		cm	deg
1	95.790	36.70	-6.80	43.50	53.46	8.79	1.68	27.23	Peak	---	---
2	108.030	38.71	-4.79	43.50	53.90	10.14	1.85	27.18	Peak	---	---
3	120.100	36.62	-6.88	43.50	49.92	11.90	1.96	27.16	Peak	---	---

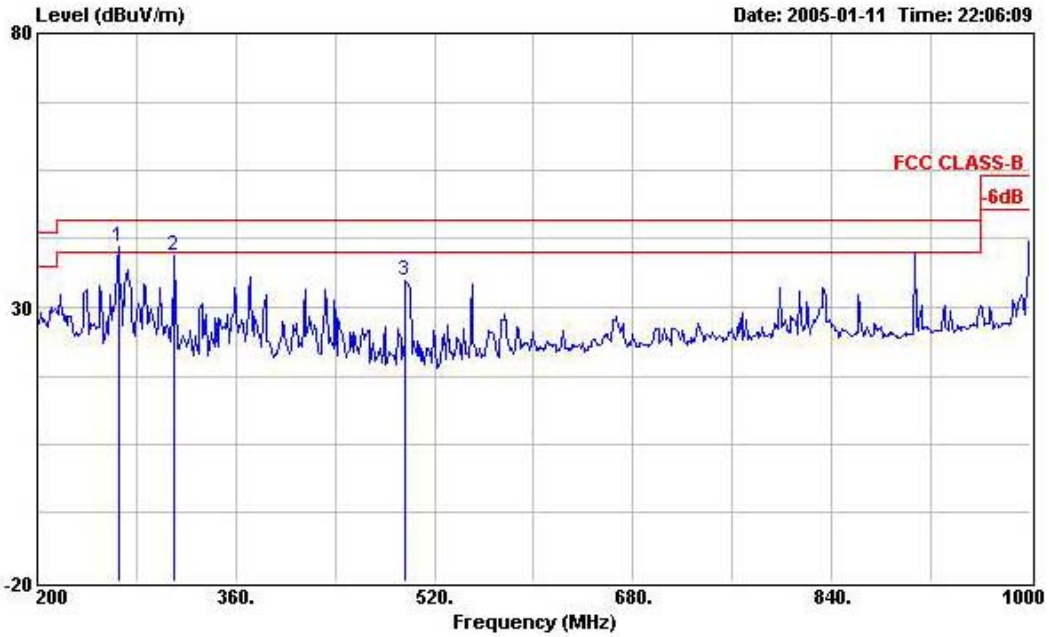

	Freq	Level	Over Limit	Limit Line	Read Level	Probe Factor	Cable Loss	Preamp Factor	Remark	Ant Pos	Table Pos
	MHz	dBuV/m	dB	dBuV/m	dBuV	dB	dB	dB		cm	deg
1	265.600	41.11	-4.89	46.00	52.08	12.77	2.93	26.67	Peak	---	---
2	310.400	39.57	-6.43	46.00	48.94	14.12	3.14	26.63	Peak	---	---
3	496.800	34.74	-11.26	46.00	42.93	16.03	3.87	28.09	Peak	---	---



(B) Polarization: Vertical

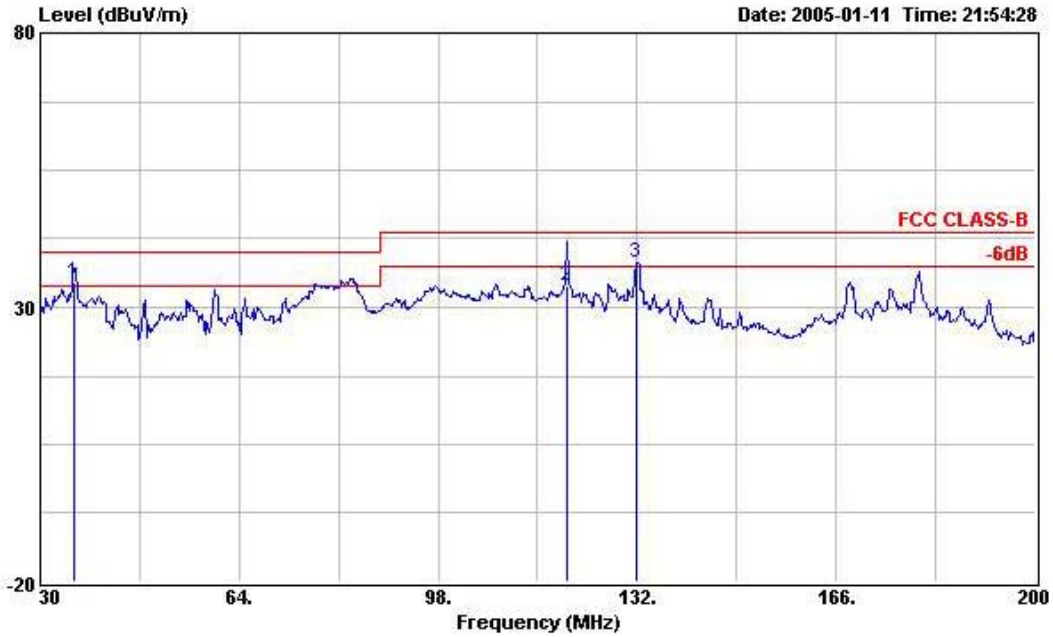

	Freq	Level	Over Limit	Limit Line	Read Level	Probe Factor	Cable Loss	Preamp Factor	Remark	Ant Pos	Table Pos
	MHz	dBuV/m	dB	dBuV/m	dBuV	dB	dB	dB		cm	deg
1	35.780	34.58	-5.42	40.00	48.99	12.02	1.03	27.46	QP	---	---
2	120.100	33.79	-9.71	43.50	47.09	11.90	1.96	27.16	QP	---	---
3	131.830	38.26	-5.24	43.50	50.96	12.38	2.06	27.14	Peak	---	---

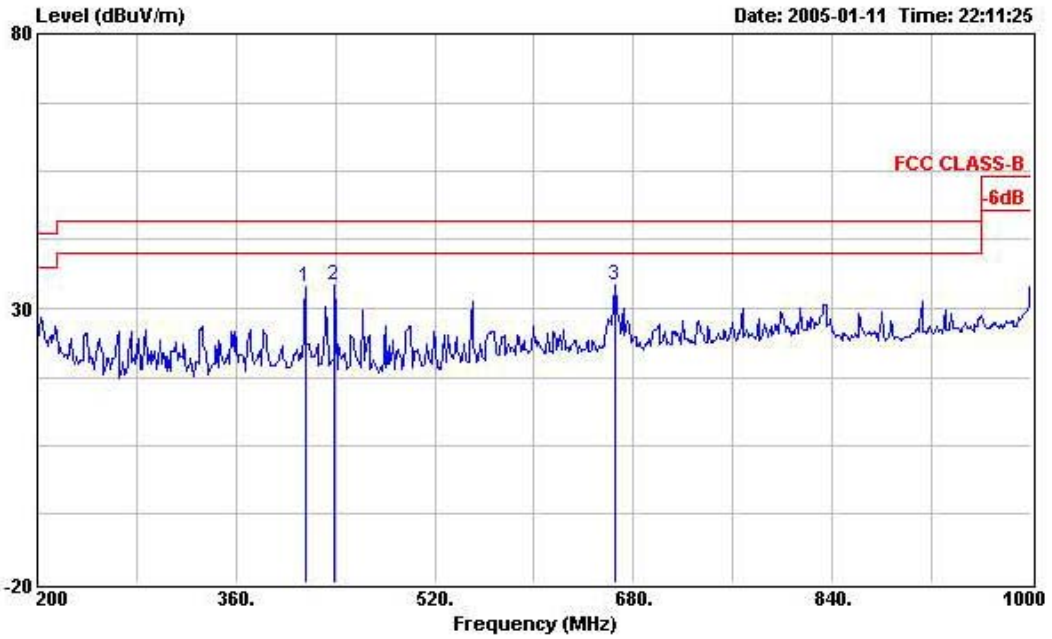

	Freq	Level	Over Limit	Limit Line	Read Level	Probe Factor	Cable Loss	Preamp Factor	Remark	Ant Pos	Table Pos
	MHz	dBuV/m	dB	dBuV/m	dBuV	dB	dB	dB		cm	deg
1	416.000	33.90	-12.10	46.00	41.44	16.67	3.55	27.76	Peak	---	---
2	439.200	34.21	-11.79	46.00	41.94	16.49	3.64	27.86	Peak	---	---
3	665.600	34.10	-11.90	46.00	37.05	20.60	4.65	28.20	Peak	---	---

Note:

Emission level (dBuV/m) = 20 log Emission level (uV/m)

Corrected Reading: Probe Factor + Cable Loss + Read Level - Preamp Factor = Level



5.11.12. Test Results for CH 00 / 2402 MHz (for emission above 1GHz)

- Modulation Type: GFSK
- Temperature: 24°C
- Relative Humidity: 54%
- Duty Cycle of the Equipment During the Test: 46.64 %
- Test Engineer: Ted Chiu

(A) Polarization: Horizontal

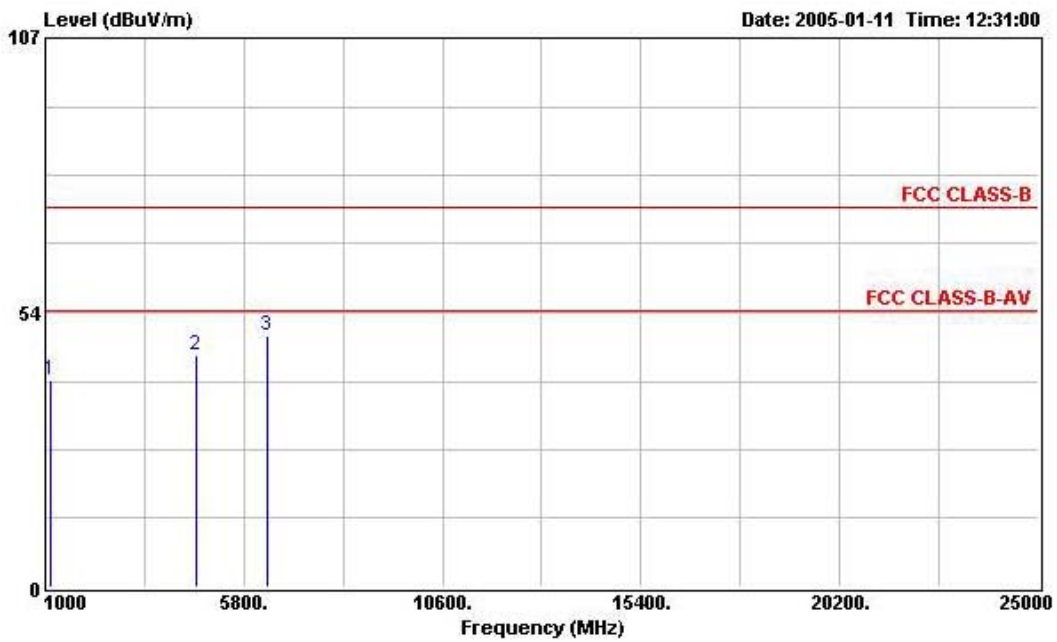

	Freq	Level	Over	Limit	Read	Probe	Cable	Preamp	Remark	Ant	Table
	MHz	dBuV/m	Limit	Line	Level	Factor	Loss	Factor		Pos	Pos
			dB	dBuV/m	dBuV	dB	dB	dB		cm	deg
1	1124.000	40.32	-33.68	74.00	53.85	24.42	1.28	39.23	Peak	---	---
2	4664.000	45.28	-28.72	74.00	49.92	32.71	2.78	40.13	Peak	---	---
3	6368.000	48.88	-25.12	74.00	51.00	34.25	3.37	39.74	Peak	---	---



(B) Polarization: Vertical

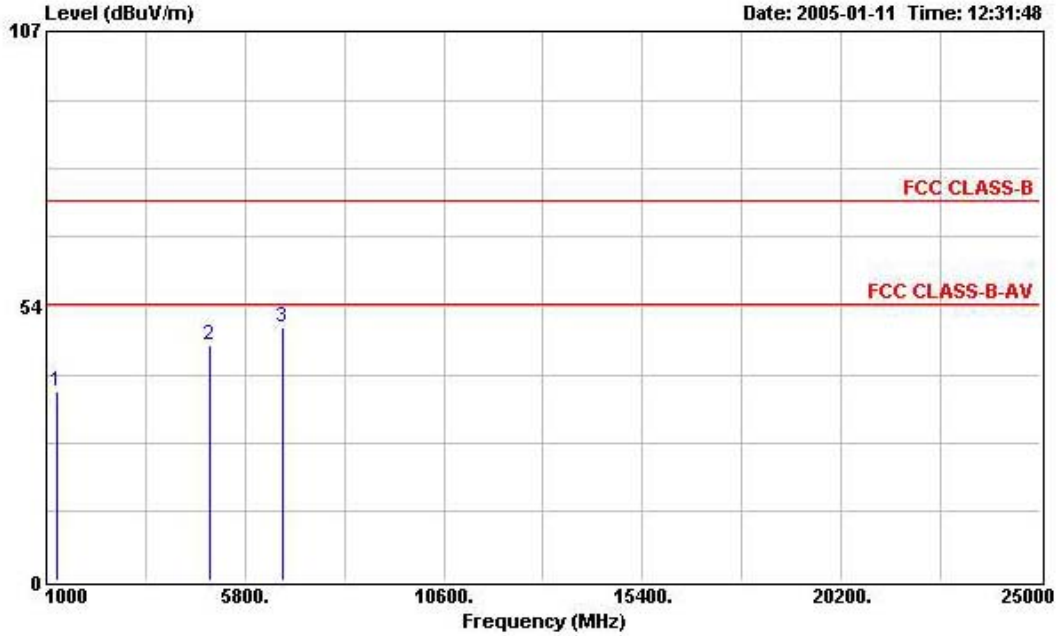

	Freq	Level	Over Limit	Limit Line	Read Level	Probe Factor	Cable Loss	Preamp Factor	Remark	Ant Pos	Table Pos
	MHz	dBuV/m	dB	dBuV/m	dBuV	dB	dB	dB		cm	deg
1	1248.000	36.84	-37.16	74.00	50.08	24.63	1.34	39.21	Peak	---	---
2	4952.000	46.03	-27.97	74.00	50.03	33.24	2.91	40.15	Peak	---	---
3	6712.000	49.46	-24.54	74.00	51.00	34.63	3.46	39.63	Peak	---	---

Note:

Emission level (dBuV/m) = 20 log Emission level (uV/m)

Corrected Reading: Probe Factor + Cable Loss + Read Level - Preamp Factor = Level



5.11.13. Test Results for CH 39 / 2441 MHz (for emission above 1GHz)

- Modulation Type: GFSK
- Temperature: 24°C
- Relative Humidity: 54%
- Duty Cycle of the Equipment During the Test: 46.64 %
- Test Engineer: Ted Chiu

(A) Polarization: Horizontal

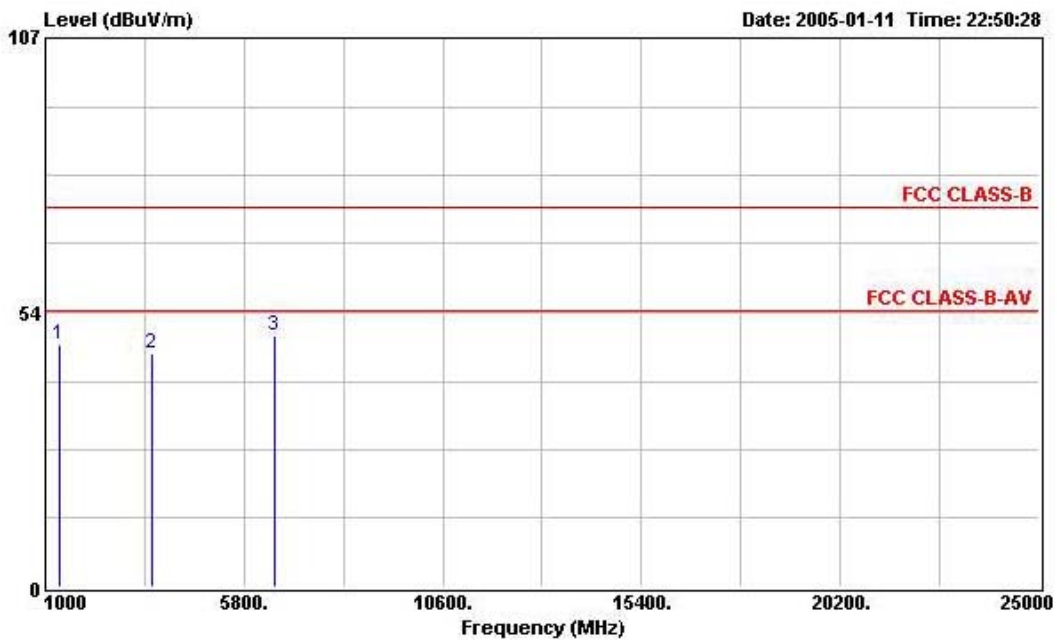

	Freq	Level	Over	Limit	Read	Probe	Cable	Preamp	Remark	Ant	Table
	MHz	dBuV/m	Limit	Line	Level	Factor	Loss	Factor		Pos	Pos
			dB	dBuV/m	dBuV	dB	dB	dB		cm	deg
1	1328.000	47.28	-26.72	74.00	60.27	24.82	1.39	39.20	Peak	---	---
2	3592.000	45.61	-28.39	74.00	50.82	31.42	2.38	39.01	Peak	---	---
3	6544.000	49.02	-24.98	74.00	50.94	34.36	3.41	39.69	Peak	---	---



(B) Polarization: Vertical

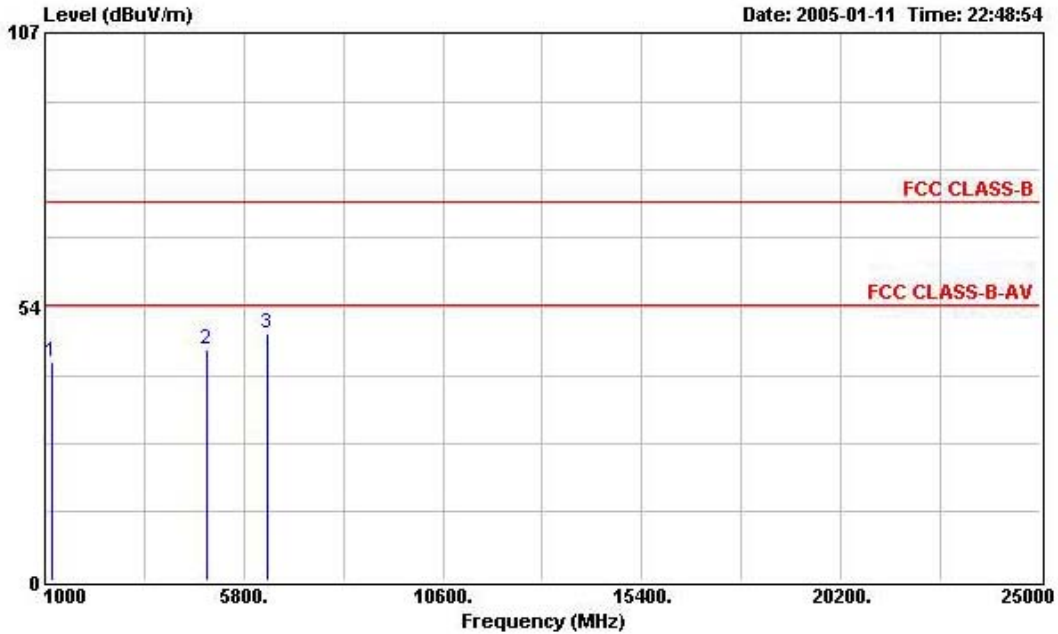

	Freq	Level	Over	Limit	Read	Probe	Cable	Preamp	Remark	Ant	Table
	MHz	dBuV/m	Limit	Line	Level	Factor	Loss	Factor		Pos	Pos
			dB	dBuV/m	dBuV	dB	dB	dB		cm	deg
1	1164.000	42.57	-31.43	74.00	55.97	24.51	1.31	39.22	Peak	---	---
2	4920.000	45.22	-28.78	74.00	49.33	33.14	2.89	40.14	Peak	---	---
3	6380.000	48.46	-25.54	74.00	50.58	34.25	3.37	39.74	Peak	---	---

Note:

Emission level (dBuV/m) = 20 log Emission level (uV/m)

Corrected Reading: Probe Factor + Cable Loss + Read Level - Preamp Factor = Level



5.11.14. Test Results for CH 78 / 2480 MHz (for emission above 1GHz)

- Modulation Type: GFSK
- Temperature: 24°C
- Relative Humidity: 54%
- Duty Cycle of the Equipment During the Test: 46.64 %
- Test Engineer: Ted Chiu

(A) Polarization: Horizontal

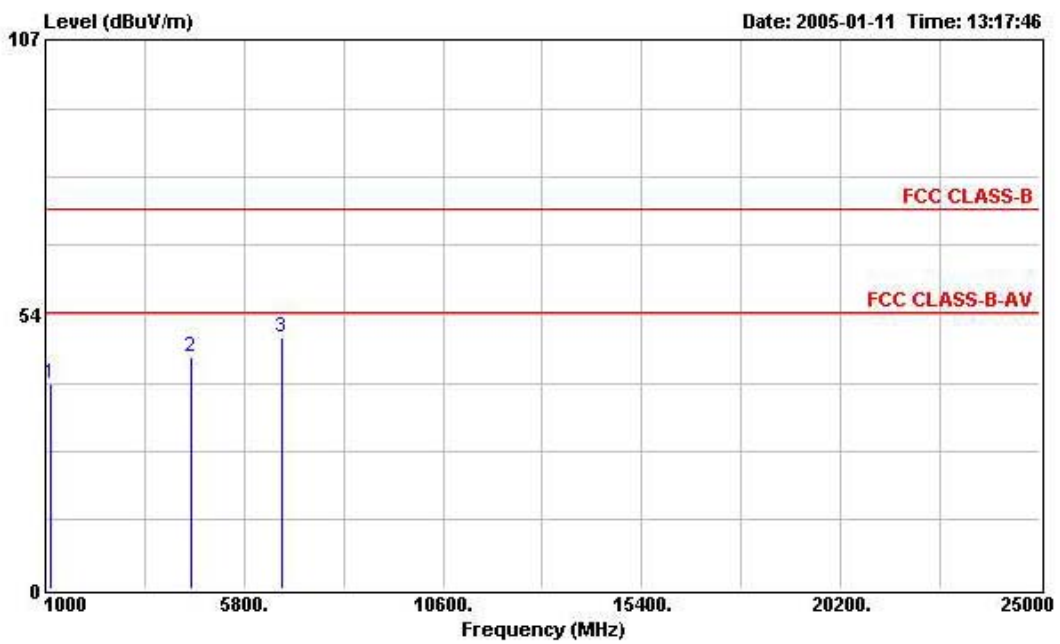

	Freq	Level	Over	Limit	Read	Probe	Cable	Preamp	Remark	Ant	Table
	MHz	dBuV/m	Limit	Line	Level	Factor	Loss	Factor		Pos	Pos
			dB	dBuV/m	dBuV	dB	dB	dB		cm	deg
1	1124.000	39.95	-34.05	74.00	53.48	24.42	1.28	39.23	Peak	---	---
2	4508.000	45.09	-28.91	74.00	50.10	32.40	2.71	40.12	Peak	---	---
3	6700.000	49.04	-24.96	74.00	50.58	34.63	3.46	39.63	Peak	---	---



(B) Polarization: Vertical

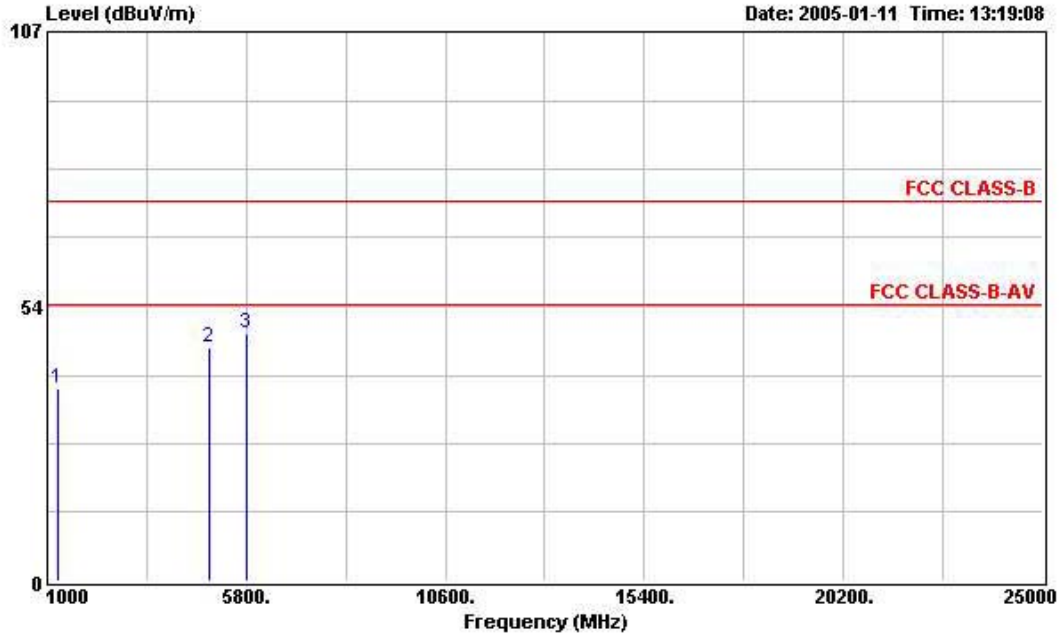

	Freq	Level	Over Limit	Limit Line	Read Level	Probe Factor	Cable Loss	Preamp Factor	Remark	Ant Pos	Table Pos
	MHz	dBuV/m	dB	dBuV/m	dBuV	dB	dB	dB		cm	deg
1	1248.000	37.37	-36.63	74.00	50.61	24.63	1.34	39.21	Peak	---	---
2	4896.000	45.48	-28.52	74.00	49.64	33.11	2.87	40.14	Peak	---	---
3	5816.000	48.45	-25.55	74.00	51.08	34.07	3.20	39.90	Peak	---	---

Note:

Emission level (dBuV/m) = 20 log Emission level (uV/m)

Corrected Reading: Probe Factor + Cable Loss + Read Level - Preamp Factor = Level

5.11.15. Photographs of Radiated Emission Test Configuration

Cradle Mode

FRONT VIEW

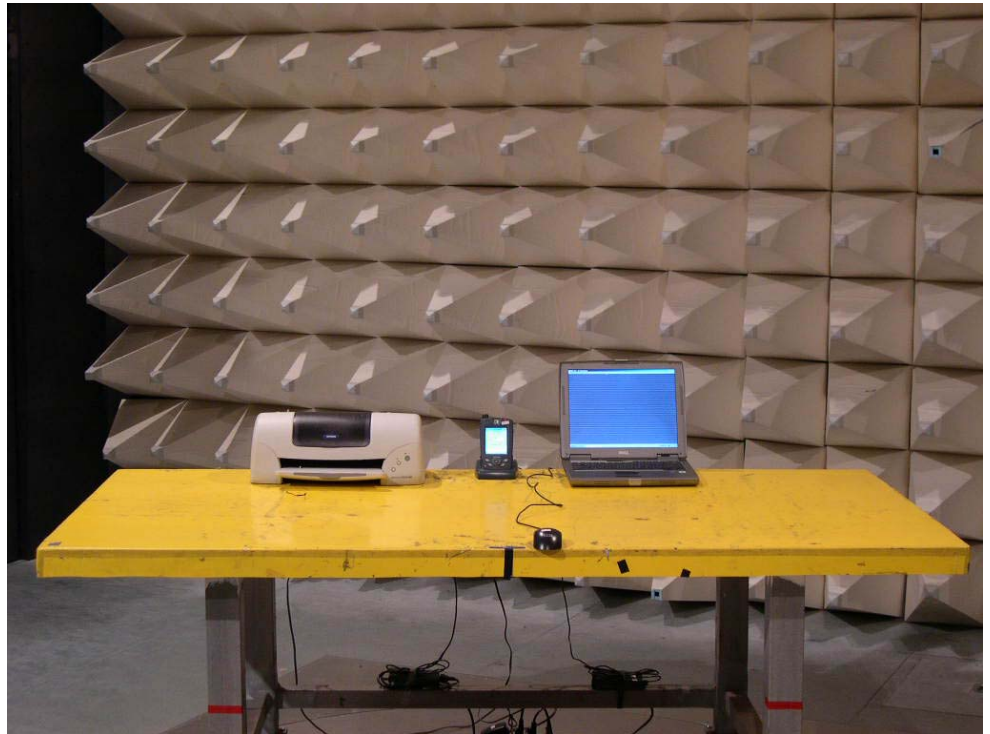

REAR VIEW

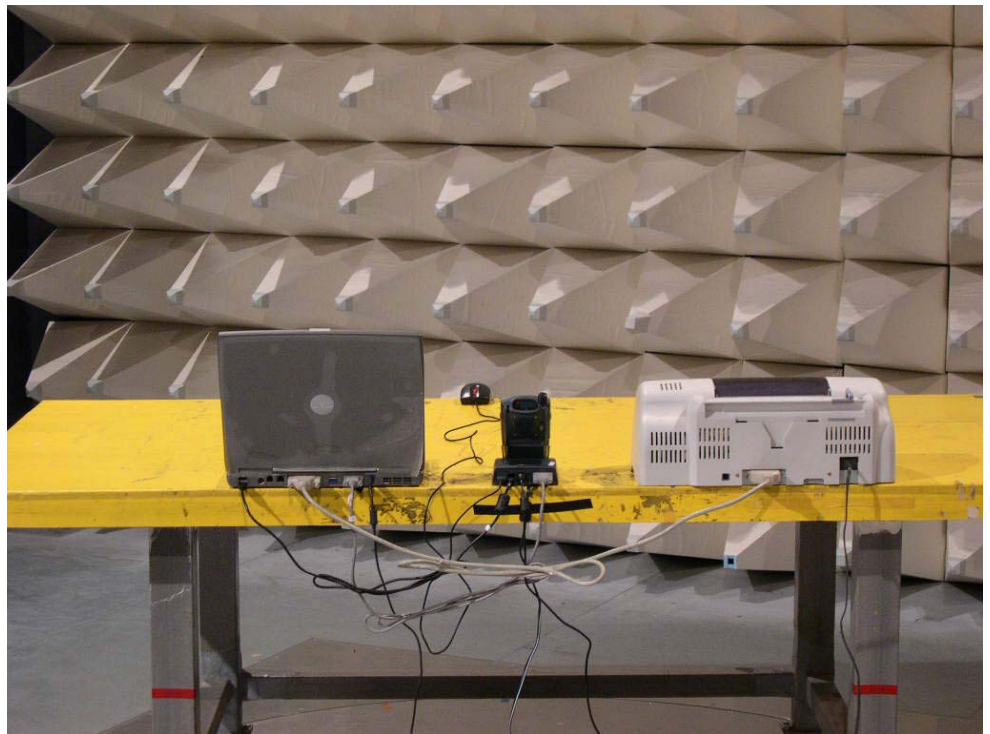

W/O Cradle Mode

FRONT VIEW

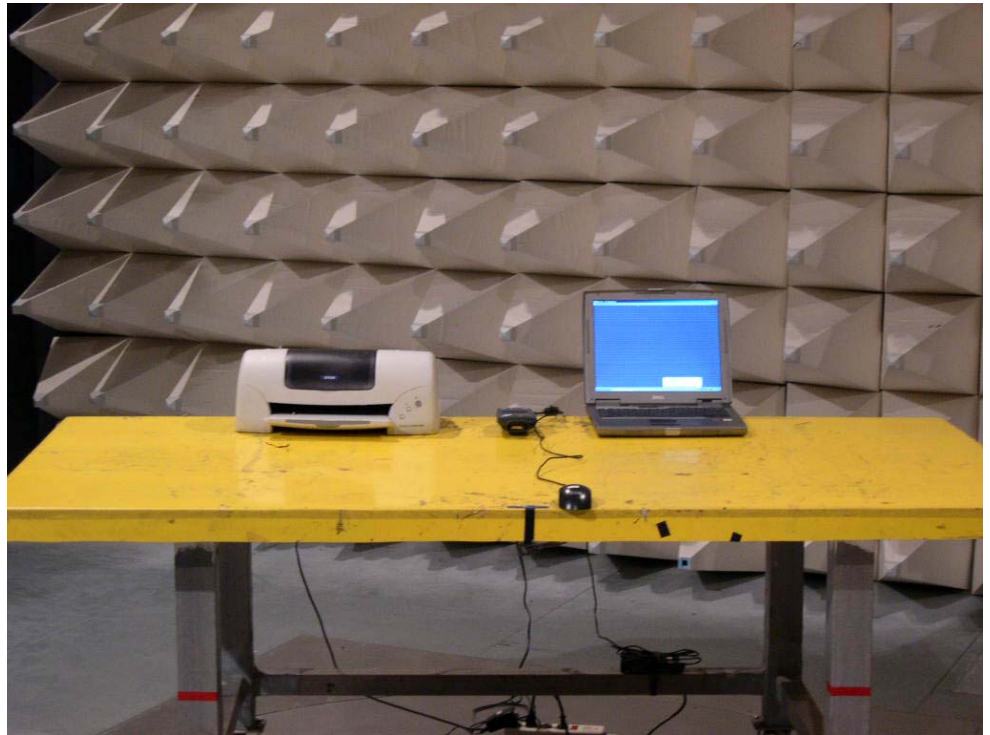

REAR VIEW

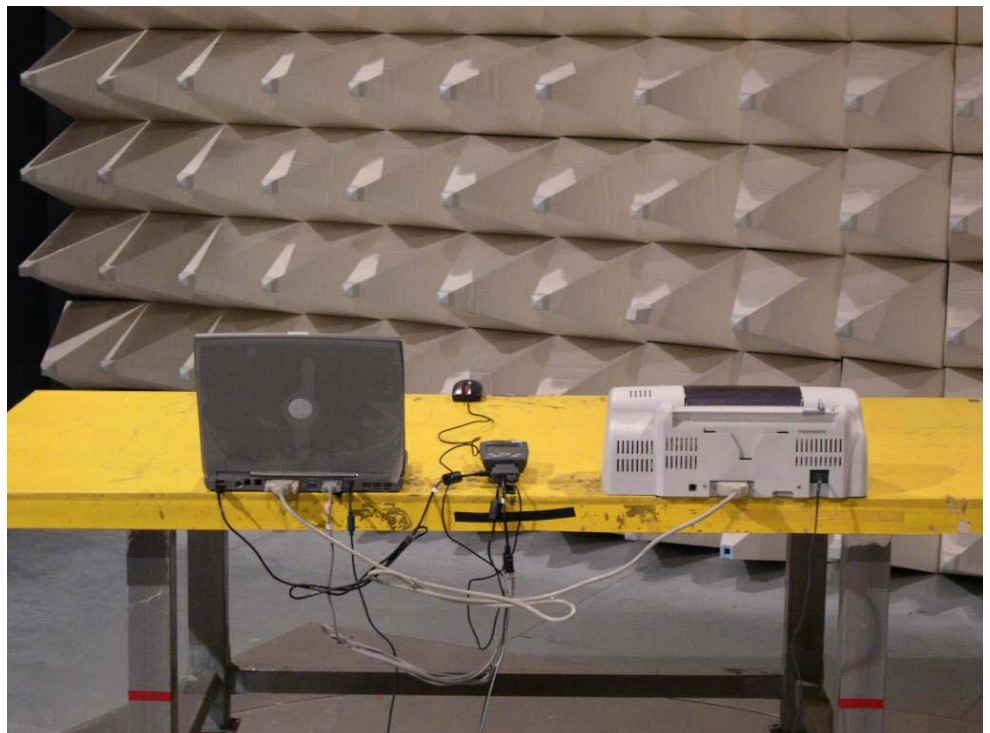



5.12. Antenna Requirements

5.12.1. Standard Applicable

Section 15.203:

An intentional radiator shall be designed to ensure that no antenna other than that furnished by the responsible party shall be used with the device. The use of a permanently attached antenna or of an antenna that uses a unique coupling to the intentional radiator shall be considered sufficient to comply with the provisions of this Section. The manufacturer may design the unit so that a broken antenna can be replaced by the user, but the use of a standard antenna jack or electrical connector is prohibited.

Section 15.247(b)/(c):

If transmitting antennas of directional gain greater than 6 dBi are used, the peak output power from the intentional radiator shall be reduced by the amount in dB that the directional gain of the antenna exceeds 6 dBi.

If the intentional radiator is used exclusively for fixed, point-to-point operations may employ transmitting antennas with directional gain greater than 6 dBi provided the maximum peak output power of the intentional radiator is reduced by 1 dB for every 3 dB that the directional gain of the antenna exceeds 6 dBi.

5.12.2. Antenna Connected Construction

There is no antenna connector for integral chip antenna and PIFA antenna.

5.12.3. Antenna Gain

All antennas gain of EUT are less than 6dBi. Therefore peak conducted power limit shall not be degraded any more. Antenna report of manufacturer will have more detail antenna gain or antenna pattern.

5.12.4. Test Criteria

All test results complied with the requirements of Section 15.247(b)(c).

6. List of Measuring Equipments Used

Items	Instrument	Manufacturer	Model No.	Serial No.	Characteristics	Calibration Date	Remark
1	EMC Receiver	R&S	ESCS 30	100174	9 KHz – 2.75 GHz	Feb. 16, 2004	Conduction (CO04-HY)
2	LISN	MessTec	NNB-2/16Z	2001/004	9 KHz – 30 MHz	Jun. 09, 2004	Conduction (CO04-HY)
3	LISN (Support Unit)	MessTec	NNB-2/16Z	99041	9 KHz – 30 MHz	Apr. 27, 2004	Conduction (CO04-HY)
4	EMI Filter	LINDGREN	LRE-2030	2651	< 450 Hz	N/A	Conduction (CO04-HY)
5	RF Cable-CON	UTIFLEX	3102-26886-4	CB044	9KHz~30MHz	Apr. 21, 2004	Conduction (CO04-HY)
6	3m Semi Anechoic Chamber	SIDT FRANKONIA	SAC-3M	03CH03-HY	30MHz~1GHz 3m	Jun. 21, 2004	Radiation (03CH03-HY)
7	Spectrum analyzer	R&S	FSP40	100004	9KHZ~40GHz	Aug. 31, 2004	Radiation (03CH03-HY)
8	Amplifier	HP	8447D	2944A09072	100KHz – 1.3GHz	Nov. 10, 2004	Radiation (03CH03-HY)
9	Biconical Antenna	SCHWARZBECK	VHBB 9124	301	30MHz – 200MHz	Jul. 28, 2004	Radiation (03CH03-HY)
10	Log Antenna	SCHWARZBECK	VUSLP 9111	221	200MHz -1GHz	Jul. 28, 2004	Radiation (03CH03-HY)
11	RF Cable-R03m	Jye Bao	RG142	CB021	30MHz~1GHz	Dec. 02, 2004	Radiation (03CH03-HY)
12	Amplifier	MITEQ	AFS44	849984	100MHz~26.5GHz	Mar. 26, 2004	Radiation (03CH03-HY)
13	Horn Antenna	EMCO	3115	6741	1GHz – 18GHz	Apr. 07, 2004	Radiation (03CH03-HY)
14	Turn Table	HD	DS 420	420/650/00	0 ~ 360 degree	N/A	Radiation (03CH03-HY)
15	Antenna Mast	HD	MA 240	240/560/00	1 m - 4 m	N/A	Radiation (03CH03-HY)
16	Horn Antenna	Schwarzbeck	BBHA9170	154	18GHz~40GHz	Jun. 09, 2004	Radiation (03CH03-HY)
17	RF Cable-HIGH	Jye Bao	RG142	CB030-HIGH	1GHz~29.5GHz	Dec. 04, 2004	Radiation (03CH03-HY)

※ Calibration Interval of instruments listed above is one year.



Items	Instrument	Manufacturer	Model No.	Serial No.	Characteristics	Calibration Date	Remark
18	Spectrum analyzer	R&S	FSP30	100023	9KHZ~30GHZ	Aug. 02, 2004	Conducted (TH01-HY)
19	Power meter	R&S	NRVS	100444	DC~40GHz	Jun. 15, 2004	Conducted (TH01-HY)
20	Power sensor	R&S	NRV-Z55	100049	DC~40GHz	Jun. 15, 2004	Conducted (TH01-HY)
21	Power Sensor	R&S	NRV-Z32	100057	30MHz-6GHz	Jun. 15, 2004	Conducted (TH01-HY)
22	AC power source	HPC	HPA-500W	HPA-9100024	AC 0~300V	Jun. 16, 2004	Conducted (TH01-HY)
23	AC power source	G.W.	GPC-6030D	C671845	DC 1V~60V	Nov. 05, 2004	Conducted (TH01-HY)
24	Temp. and Humidity Chamber	KSON	THS-C3L	612	N/A	Oct. 01, 2004	Conducted (TH01-HY)
25	RF CABLE-1m	Jye Bao	RG142	CB034-1m	20MHz~7GHz	Jan. 01, 2004	Conducted (TH01-HY)
26	RF CABLE-2m	Jye Bao	RG142	CB035-2m	20MHz~1GHz	Jan. 01, 2004	Conducted (TH01-HY)

※ Calibration Interval of instruments listed above is one year.

7. Company Profile

SPORTON Lab. was established in 1986 with one shielded room: the first private EMI test facility, offering local manufacturers an alternative EMI test facility apart from ERSO. In 1988, one 3M and 10M/3M open area test site were setup and also obtained official accreditation from FCC, VCCI and NEMKO. In 1993, a Safety laboratory was founded and obtained accreditation from UL of USA, CSA of Canada and TUV (Rhineland & PS) of Germany. In 1995, one EMC lab, including EMI and EMS test facilities was setup. In 1997, SPORTON Group has provided financial expense to relocate the headquarter to Orient Scientific Park in Taipei Hsien to offer more comprehensive, more qualified and better service to local suppliers and manufactures. In 1999, Safety Group and Component Group were setup. In 2001, SPORTON has established 3M/10M chamber in Hwa Ya Technology Park.

7.1. Certificate of Accreditation

Taiwan	BSMI, CNLA, DGT
USA	FCC, NVLAP, UL
EU	Nemko, TUV
Japan	VCCI
Canada	Industry Canada

7.2. Test Location

SHIJR	ADD : 6Fl., No. 106, Sec. 1, Shintai 5th Rd., Shijr City, Taipei, Taiwan 221, R.O.C. TEL : 02-2696-2468 FAX : 02-2696-2255
HWA YA	ADD : No. 52, Hwa Ya 1st Rd., Hwa Ya Technology Park, Kwei-Shan Hsiang, Tao Yuan Hsien, Taiwan, R.O.C. TEL : 03-327-3456 FAX : 03-318-0055
LINKOU	ADD : No. 30-2, Dingfu Tsuen, Linkou Shiang, Taipei, Taiwan 244, R.O.C TEL : 02-2601-1640 FAX : 02-2601-1695
DUNGHU	ADD : No. 3, Lane 238, Kangle St., Neihu Chiu, Taipei, Taiwan 114, R.O.C. TEL : 02-2631-4739 FAX : 02-2631-9740
JUNGHE	ADD : 7Fl., No. 758, Jungjeng Rd., Junghe City, Taipei, Taiwan 235, R.O.C. TEL : 02-8227-2020 FAX : 02-8227-2626
NEIHU	ADD : 4Fl., No. 339, Hsin Hu 2 nd Rd., Taipei 114, Taiwan, R.O.C. TEL : 02-2794-8886 FAX : 02-2794-9777

8. CNLA Certificate of Accreditation

Test Lab. : Sporton International Inc.
Accreditation Number : 1190
Originally Accredited : 2003/12/15
Effective Period : 2003/12/15~2006/12/14
Accredited Scope : 47 CFR FCC Part 15 Subpart C (9kHz~40GHz)



Taiwan Accreditation Foundation
Chinese National Laboratory Accreditation
Certificate of Accreditation

Accreditation Criteria: ISO 17025
Accreditation Number: 1190
Organization/Laboratory: EMC & Wireless Communications Laboratory, Sporton International Inc.
Originally Accredited: December 15, 2003
Effective Period: December 15, 2003 To December 14, 2006
Accredited Scope: Electrical Testing Field, 7 items, details shown in the following pages.
Specific Accreditation Program: Recognition and Approval of Designated Laboratory for Commodities Inspection

President, Taiwan Accreditation Foundation
Date: July 19, 2004

(This document is invalid unless accompanied by all 4 pages)

CNLA-ZL03191E Page 1 of 4