









Label & Label location

| | |
|---|---|
| <p>MODEL : DPD1334-STQ-Q01 S/No.:  XXXXXXXXXXXXXXXXXXXX</p> | <p> LITEMAX[®] LITEMAX ELECTRONICS INC.</p> <p>INPUT : DC12V , 2A Max MODEL : DPD1334-STQ-Q01 S/No.:  XXXXXXXXXXXXXXXXXXXX</p> <p>FCC ID : GQO-DPD1334</p> |
| <p>MODEL : DPD1334-STQ-Q01 S/No.:  XXXXXXXXXXXXXXXXXXXX</p> | |
| <p><small>This device complies with Part 15 of the FCC Rules. Operation is subject to the following two conditions: (1) this device may not cause harmful interference, and (2) this device must accept any interference received, including interference that may cause undesired operation of the device.</small></p> | |

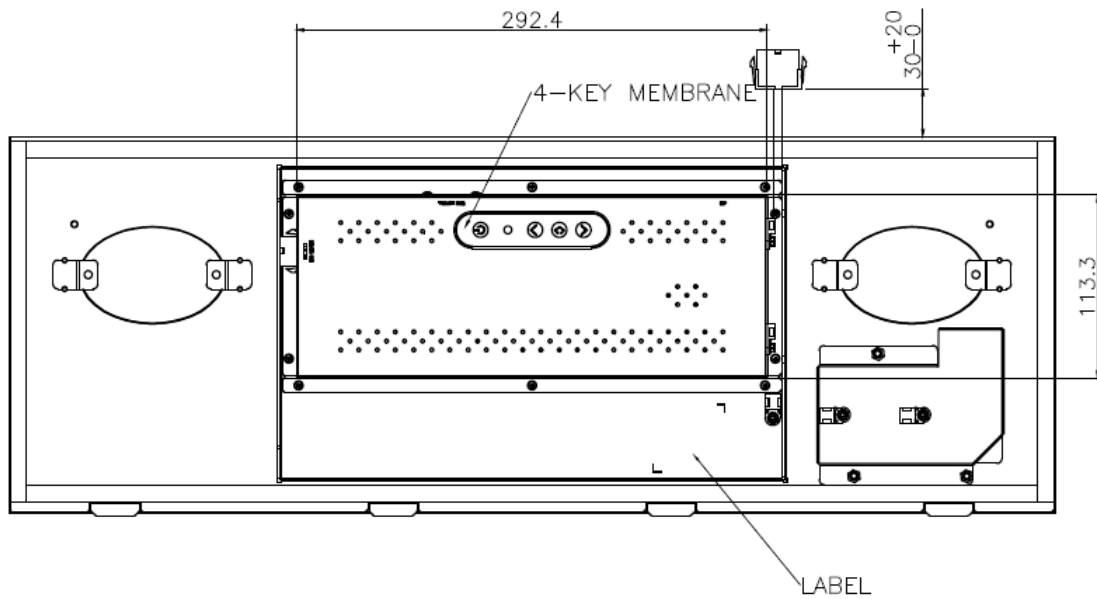

| | |
|--|--|
| MODEL : DPD1334-STQ-Q01 S/No.:  XXXXXXXXXXXXXXXXXXXX |  LITEMAX [®] LITEMAX ELECTRONICS INC. |
| MODEL : DPD1334-STQ-Q01 S/No.:  XXXXXXXXXXXXXXXXXXXX | |
| <small> This device complies with Part 15 of the FCC Rules. Operation is subject to the following two conditions: (1) This device may not cause harmful interference, and (2) This device must accept any interference received, including interference that may cause undesired operation of the device. </small> | INPUT : DC12V, 2A Max MODEL : DPD1334-STQ-Q01 S/No.:  XXXXXXXXXXXXXXXXXXXX FCC ID : GQO-DPD1334 |