



RADIO TEST REPORT

Report No.: STS2302103W01

Issued for

GEMMY INDUSTRIES (HK)LIMITED BVI

Unit No.301 on 3rd Floor, East Ocean Centre, No.98
Kowloon Hong Kong

Product Name:	Orchestra of Lights-Pathway Stakes
Brand:	Gemmy
Model Number:	881585
Series Model(s):	881584
FCC ID:	GPO881585
Test Standard:	FCC Part 15.249

Any reproduction of this document must be done in full. No single part of this document may be reproduced without permission from STS, All Test Data Presented in this report is only applicable to presented Test sample.

Shenzhen STS Test Services Co., Ltd.
A 1/F, Building B, Zhuoke Science Park, No.190 Chongqing Road, HepingShequ
Fuyong Sub-District, Bao'an District, Shenzhen, Guang Dong, China
TEL: +86-755 3688 6288 FAX: +86-755 3688 6277 E-mail:sts@stsapp.com





TEST RESULT CERTIFICATION

Applicant's Name: GEMMY INDUSTRIES (HK)LIMITED BVI
Address.....: Unit No.301 on 3rd Floor, East Ocean Centre, No.98 Kowloon Hong Kong
Manufacture's Name: GEMMY INDUSTRIES (HK)LIMITED BVI
Address.....: Unit No.301 on 3rd Floor, East Ocean Centre, No.98 Kowloon Hong Kong
Factory's Name.....: 1. ZAIXING ELECTRONIC (SHENZHEN) CO., LTD.
2. DYNATECH CO., LTD.
3. XINGYU ELECTRONIC (HUIZHOU) CO., LTD.
4. YUQI ELECTRONIC (HUAIBEI) CO., LTD.
5. YUAN HONG COMPANY LIMITED
6. DYNATECH LIGHTING TECHNOLOGY CO., LTD.
Address.....: 1. No. 1 and 3, 1st Road Yang Yong, Tangxiayong Community, Yanluo Street, Bao'an District, Shenzhen City, Guangdong Province, China
2. 259-261 Xincheng Road, Qiaotou Town, Dongguan, Guangdong, China
3. Hengjiangwei Village, Yihe Town, Boluo County, Huizhou City, Guangdong Province, China
4. 32 fengguan road, xiangshan district, Huaibei city, Anhui province, China
5. No. 3 Street, My Xuan A Industrial Zone, My Xuan Ward, Phu My Town, Ba Ria-Vung Tau province, Vietnam
6. GIGA RESOURCE SPECIAL ECONOMIC ZONE, NATIONAL ROAD NO.1, DERM POU VILLAGE, KANDIENG REAY COMMUNE, SVAY TEAP DISTRICT, SVAY RIENG PROVINCE, CAMBODIA

Product Description

Product Name: Orchestra of Lights-Pathway Stakes
Brand: Gemmy
Model Number.....: 881585
Series Model(s): 881584
Test Standards.....: FCC Part15.249
Test Procedure: ANSI C63.10-2013

This device described above has been tested by STS, the test results show that the equipment under test (EUT) is in compliance with the FCC requirements. And it is applicable only to the tested sample identified in the report.
This report shall not be reproduced except in full, without the written approval of STS, this document only be altered or revised by STS, personal only, and shall be noted in the revision of the document.

Date of Test.....:
Date of receipt of test item.....: 23 Feb. 2023
Date of performance of tests ..: 23 Feb. 2023 ~ 28 Feb. 2023
Date of Issue.....: 28 Feb. 2023
Test Result: **Pass**



Testing Engineer : *Chris chen*

(Chris Chen)

Technical Manager : *Sean she*

(Sean she)

Authorized Signatory : *Bovey yang*

(Bovey Yang)





Table of Contents	Page
1. SUMMARY OF TEST RESULTS	6
1.1 TEST FACTORY	7
1.2 MEASUREMENT UNCERTAINTY	7
2. GENERAL INFORMATION	8
2.1 GENERAL DESCRIPTION OF THE EUT	8
2.2 DESCRIPTION OF THE TEST MODES	9
2.3 TEST SOFTWARE AND POWER LEVEL	9
2.4 BLOCK DIGRAM SHOWING THE CONFIGURATION OF SYSTEM TESTED	10
2.5 DESCRIPTION OF NECESSARY ACCESSORIES AND SUPPORT UNITS	11
2.6 EQUIPMENTS LIST FOR ALL TEST ITEMS	12
3. EMC EMISSION TEST	13
3.1 CONDUCTED EMISSION MEASUREMENT	13
3.2 RADIATED EMISSION MEASUREMENT	17
4. BANDWIDTH TEST	31
4.1 TEST PROCEDURE	31
4.2 TEST SETUP	31
4.3 EUT OPERATION CONDITIONS	31
4.4 TEST RESULTS	32
5. ANTENNA REQUIREMENT	34
5.1 STANDARD REQUIREMENT	34
5.2 EUT ANTENNA	34
APPENDIX- PHOTOS OF TEST SETUP	35



Revision History

Rev.	Issue Date	Report NO.	Effect Page	Contents
00	28 Feb. 2023	STS2302103W01	ALL	Initial Issue





1. SUMMARY OF TEST RESULTS

Test procedures according to the technical standards:

FCC Part 15.249 , Subpart C			
Standard Section	Test Item	Judgment	Remark
15.207	Conducted Emission	Pass	
15.203	Antenna Requirement	Pass	
15.249	Radiated Spurious Emission	Pass	
15.249	Radiated Band Edge Emission	Pass	
15.249	Field Strength of fundamental	Pass	
15.215(c)	20dB Bandwidth	Pass	

NOTE:

- (1) 'N/A' denotes test is not applicable in this Test Report.
- (2) All tests are according to ANSI C63.10-2013.

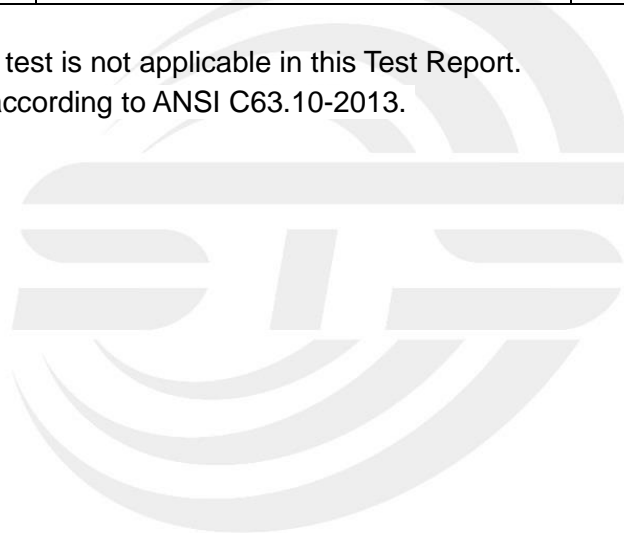



1.1 TEST FACTORY

SHENZHEN STS TEST SERVICES CO., LTD

Add. : A 1/F, Building B, Zhuoke Science Park, No.190 Chongqing Road, HepingShequ, Fuyong Sub-District, Bao'an District, Shenzhen, Guang Dong, China

FCC test Firm Registration Number: 625569

IC test Firm Registration Number: 12108A

A2LA Certificate No.: 4338.01

1.2 MEASUREMENT UNCERTAINTY

The reported uncertainty of measurement $y \pm U$, where expanded uncertainty U is based on a standard uncertainty multiplied by a coverage factor of $k=2$, providing a level of confidence of approximately **95 %**.

No.	Item	Uncertainty
1	RF output power, conducted	$\pm 1.197\text{dB}$
2	Unwanted Emissions, conducted	$\pm 2.896\text{dB}$
3	All emissions, radiated 9K-30MHz	$\pm 3.84\text{dB}$
4	All emissions, radiated 30M-1GHz	$\pm 3.94\text{dB}$
5	All emissions, radiated 1G-6GHz	$\pm 4.59\text{dB}$
6	All emissions, radiated >6G	$\pm 5.22\text{dB}$
7	Conducted Emission (9KHz-150KHz)	$\pm 2.14\text{dB}$
8	Conducted Emission (150KHz-30MHz)	$\pm 2.54\text{dB}$



2. GENERAL INFORMATION

2.1 GENERAL DESCRIPTION OF THE EUT

Product Name	Orchestra of Lights-Pathway Stakes								
Brand	Gemmy								
Model Number	881585								
Series Model(s)	881584								
Model Difference	Only the appearance color is different, the working circuit principle is the same.								
Product Description	<p>The EUT is a Orchestra of Lights-Pathway Stakes</p> <table border="1"><tr><td>Operation Frequency:</td><td>2420-2465 MHz</td></tr><tr><td>Modulation Type:</td><td>GFSK</td></tr><tr><td>Antenna Type:</td><td>Internal</td></tr><tr><td>Antenna Gain(Peak):</td><td>4dBi</td></tr></table> <p>Based on the application, features, or specification exhibited in User Manual, the EUT is considered as an ITE/Computing Device. More details of EUT technical specification, please refer to the User Manual.</p>	Operation Frequency:	2420-2465 MHz	Modulation Type:	GFSK	Antenna Type:	Internal	Antenna Gain(Peak):	4dBi
Operation Frequency:	2420-2465 MHz								
Modulation Type:	GFSK								
Antenna Type:	Internal								
Antenna Gain(Peak):	4dBi								
Channel List	Please refer to the Note 3.								
Rating	Input: AC 120V								
Hardware version number	N/A								
Software version number	N/A								
Connecting I/O Port(s)	Please refer to the Note 1.								

Note:

1. For a more detailed features description, please refer to the manufacturer's specifications or the User Manual.
2. For the antenna information refer to the manufacturer provided report. Antenna information in this report is applicable only to the tested sample identified in the report. Due to the incorrect antenna information, a series of problems such as the accuracy of the test results will be borne by the customer.
- 3.

Channel List					
Channel	Frequency (MHz)	Channel	Frequency (MHz)	Channel	Frequency (MHz)
1	2420	2	2443	3	2465



2.2 DESCRIPTION OF THE TEST MODES

For conducted test items and radiated spurious emissions

Each of these EUT operation mode(s) or test configuration mode(s) mentioned below was evaluated respectively.

Pretest Mode	Description	Data/Modulation
Mode 1	TX Low channel	GFSK
Mode 2	TX Mid channel	GFSK
Mode 3	TX High channel	GFSK

Note:

(1) All above mode have been measurement, only worst data was reported.

(2) We have be tested for all avaiable U.S. voltage and frequencies(For 120V,50/60Hz and 240V, 50/60Hz) for which the device is capable of operation, and the worst case of 120V,50/60Hz is shown in the report.

For AC Conducted Emission

Test Case	
AC Conducted Emission	Mode 4 : Keeping TX

2.3 TEST SOFTWARE AND POWER LEVEL

During testing channel & power controlling software provided by the customer was used to control the operating channel as well as the output power level.

RF Function	Type	Mode Or Modulation type	ANT Gain(dBi)	Power Class	Software For Testing
Other SRD	2.4G	GFSK	4	Default	The EUT has signal transmission when it is powered on

2.4 BLOCK DIGRAM SHOWING THE CONFIGURATION OF SYSTEM TESTED

During testing channel & power controlling software provided by the customer was used to control the operating channel as well as the output power level. The RF output power selection is for the setting of RF output power expected by the customer and is going to be fixed on the firmware of the final end product power parameters.

Radiated Spurious Emission Test

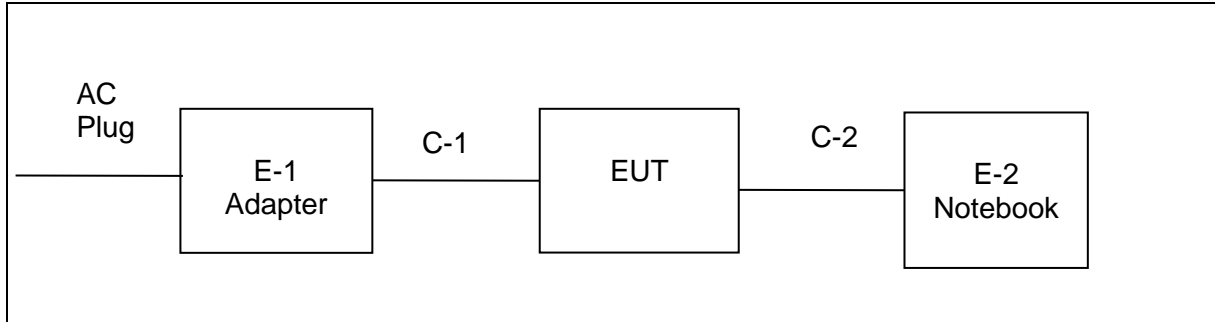

Conducted Emission Test

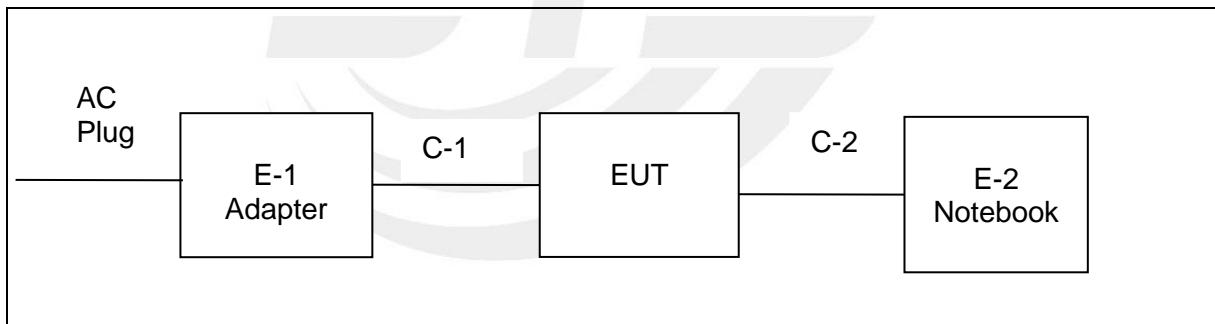



2.5 DESCRIPTION OF NECESSARY ACCESSORIES AND SUPPORT UNITS

The EUT has been tested as an independent unit together with other necessary accessories or support units. The following support units or accessories were used to form a representative test configuration during the tests.

Necessary accessories

Item	Equipment	Mfr/Brand	Model/Type No.	Length	Note
E-1	Adapter	N/A	N/A	N/A	N/A
C-1	DC Cable	N/A	N/A	65cm	NO

Support units

Item	Equipment	Mfr/Brand	Model/Type No.	Length	Note
E-2	Notebook	LENOVO	ThinkPad E470	N/A	N/A
C-2	USB Cable	N/A	N/A	150cm	NO

Note:

- (1) The support equipment was authorized by Declaration of Confirmation.
- (2) For detachable type I/O cable should be specified the length in cm in 『Length』 column.



2.6 EQUIPMENTS LIST FOR ALL TEST ITEMS

RF Radiation Test Equipment					
Kind of Equipment	Manufacturer	Type No.	Serial No.	Last Calibration	Calibrated Until
Temperature & Humidity	SW-108	SuWei	N/A	2022.03.02	2023.03.01
Pre-Amplifier (0.1M-3GHz)	EM	EM330	060665	2022.07.04	2023.07.03
Pre-Amplifier (1G-18GHz)	SKET	LNPA-01018G-45	SK2018080901	2022.09.29	2023.09.28
Pre-mpifier (18G-40G)	SKET	LNPA_1840-50	SK2018101801	2022.07.23	2023.07.22
Positioning Controller	MF	MF-7802	MF-780208587	N/A	N/A
Signal Analyzer	R&S	FSV 40-N	101823	2022.09.29	2023.09.28
Switch Control Box	N/A	N/A	N/A	N/A	N/A
Filter Box	BALUN Technology	SU319E	BL-SZ1530051	N/A	N/A
Active loop Antenna	ZHINAN	ZN30900C	16035	2022.03.02	2023.03.01
Bilog Antenna	TESEQ	CBL6111D	34678	2022.09.30	2024.09.29
Horn Antenna	SCHWARZBECK	BBHA 9120D	02014	2021.10.11	2023.10.10
Horn Antenna	A-INFOMW	LB-180400-KF	J211020657	2021.09.28	2023.09.27
Antenna Mast	MF	MFA-440H	N/A	N/A	N/A
Turn Table	MF	SC100_1	60531	N/A	N/A
AC Power Source	APC	KDF-11010G	F214050035	N/A	N/A
DC Power Supply	Zhaoxin	RXN 605D	20R605D11010081	N/A	N/A
Test SW	EZ-EMC	Ver.STSLAB-03A1 RE			
Conduction Test equipment					
Kind of Equipment	Manufacturer	Type No.	Serial No.	Last calibration	Calibrated until
Test Receiver	R&S	ESCI	101427	2022.09.29	2023.09.28
LISN	R&S	ENV216	101242	2022.09.28	2023.09.27
LISN	EMCO	3810/2NM	23625	2022.09.28	2023.09.27
Temperature & Humidity	HH660	Mieo	N/A	2022.09.30	2023.09.29
Test SW	EZ-EMC	Ver.STSLAB-03A1 CE			
RF Connected Test					
Kind of Equipment	Manufacturer	Type No.	Serial No.	Last calibration	Calibrated until
Signal Analyzer	Agilent	N9020A	MY51510623	2022.03.01	2023.02.28
Switch control box	MW	MW100-RFCB	N/A	N/A	N/A
Temperature & Humidity	HH660	Mieo	N/A	2022.09.30	2023.09.29
Test SW	MW	MTS 8310_2.0.0.0			

3. EMC EMISSION TEST

3.1 CONDUCTED EMISSION MEASUREMENT

3.1.1 POWER LINE CONDUCTED EMISSION LIMITS

Operating frequency band. In case the emission fall within the restricted band specified on Part 15.249 limit in the table below has to be followed.

FREQUENCY (MHz)	Quasi-peak	Average
0.15 -0.5	66 - 56 *	56 - 46 *
0.50 -5.0	56.00	46.00
5.0 -30.0	60.00	50.00

Note:

- (1) The tighter limit applies at the band edges.
- (2) The limit of “ * ” marked band means the limitation decreases linearly with the logarithm of the frequency in the range.

The following table is the setting of the receiver

Receiver Parameters	Setting
Attenuation	10 dB
Start Frequency	0.15 MHz
Stop Frequency	30 MHz
IF Bandwidth	9 kHz

3.1.2 TEST PROCEDURE

- a. The EUT was 0.8 meters from the horizontal ground plane and 0.4 meters from the vertical ground plane with EUT being connected to the power mains through a line impedance stabilization network (LISN). All other support equipments powered from additional LISN(s). The LISN provide 50 Ohm/ 50uH of coupling impedance for the measuring instrument.
- b. Interconnecting cables that hang closer than 40 cm to the ground plane shall be folded back and forth in the center forming a bundle 30 to 40 cm long.
- c. I/O cables that are not connected to a peripheral shall be bundled in the center. The end of the cable may be terminated, if required, using the correct terminating impedance. The overall length shall not exceed 1 m.
- d. LISN at least 80 cm from nearest part of EUT chassis.
- e. For the actual test configuration, please refer to the related Item –EUT Test Photos.

3.1.3 TEST SETUP

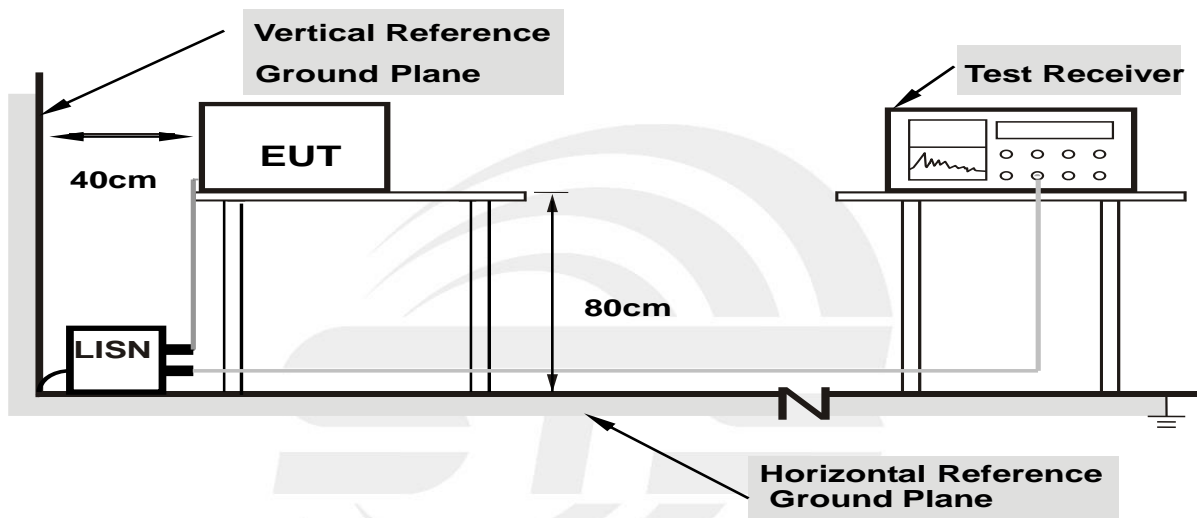

- Note: 1.Support units were connected to second LISN.**
2.Both of LISNs (AMN) are 80 cm from EUT and at least 80 from other units and other metal planes

3.1.4 EUT OPERATING CONDITIONS

The EUT was configured for testing in a typical fashion (as a customer would normally use it). The EUT has been programmed to continuously transmit during test. This operating condition was tested and used to collect the included data.



3.1.5 TEST RESULT

Temperature:	21.7(C)	Relative Humidity:	42%RH
Test Voltage:	AC 120V/60Hz	Phase:	L
Test Mode:	Mode 4		

No.	Frequency (MHz)	Reading (dBUV)	Correct Factor(dB)	Result (dBUV)	Limit (dBUV)	Margin (dB)	Remark
1	0.2060	44.42	10.34	54.76	63.37	-8.61	QP
2	0.2060	29.95	10.34	40.29	53.37	-13.08	AVG
3	0.5220	38.98	10.52	49.50	56.00	-6.50	QP
4	0.5220	23.89	10.52	34.41	46.00	-11.59	AVG
5	0.7260	40.14	10.35	50.49	56.00	-5.51	QP
6	0.7260	27.12	10.35	37.47	46.00	-8.53	AVG
7	11.4140	38.57	11.35	49.92	60.00	-10.08	QP
8	11.4140	28.01	11.35	39.36	50.00	-10.64	AVG
9	17.3140	36.71	12.27	48.98	60.00	-11.02	QP
10	17.3140	21.85	12.27	34.12	50.00	-15.88	AVG
11	28.3860	40.72	12.83	53.55	60.00	-6.45	QP
12	28.3860	24.42	12.83	37.25	50.00	-12.75	AVG

Remark:

1. All readings are Quasi-Peak and Average values.
2. Margin = Result (Result =Reading + Factor)–Limit

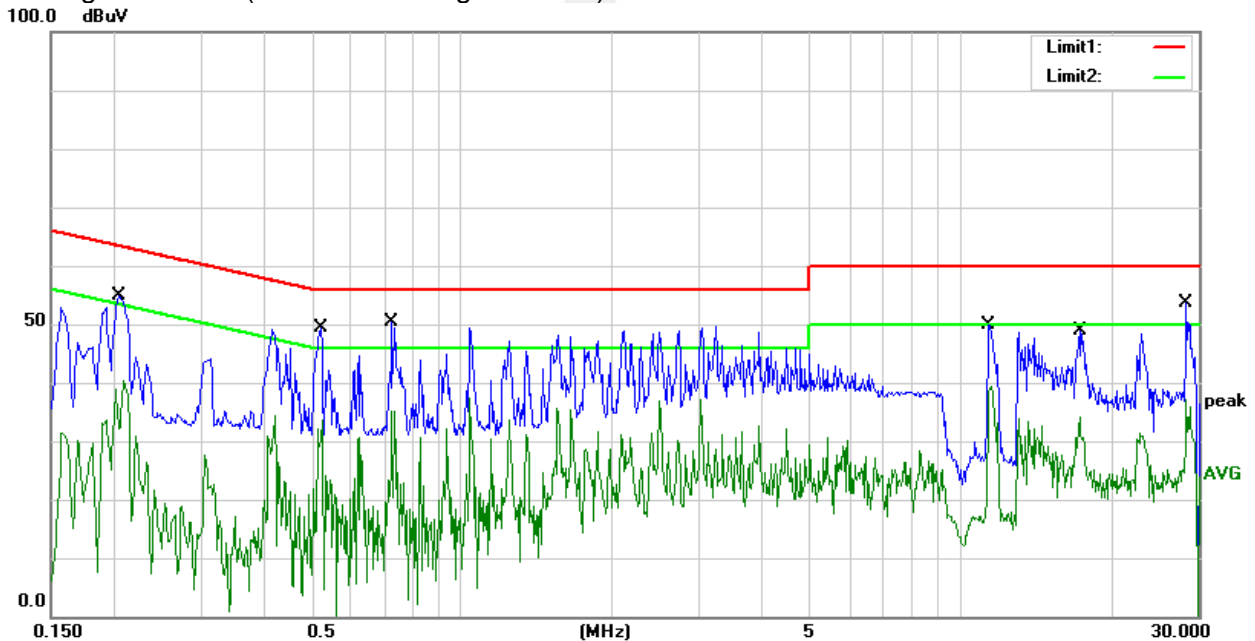



Temperature:	21.7(C)	Relative Humidity:	42%RH
Test Voltage:	AC 120V/60Hz	Phase:	N
Test Mode:	Mode 4		

No.	Frequency (MHz)	Reading (dBuV)	Correct Factor(dB)	Result (dBuV)	Limit (dBuV)	Margin (dB)	Remark
1	0.2100	37.81	10.44	48.25	63.21	-14.96	QP
2	0.2100	20.27	10.44	30.71	53.21	-22.50	AVG
3	0.4140	41.27	10.56	51.83	57.57	-5.74	QP
4	0.4140	26.79	10.56	37.35	47.57	-10.22	AVG
5	0.5180	40.85	10.48	51.33	56.00	-4.67	QP
6	0.5180	27.85	10.48	38.33	46.00	-7.67	AVG
7	1.3500	36.20	10.33	46.53	56.00	-9.47	QP
8	1.3500	22.37	10.33	32.70	46.00	-13.30	AVG
9	11.5940	36.79	11.13	47.92	60.00	-12.08	QP
10	11.5940	24.69	11.13	35.82	50.00	-14.18	AVG
11	28.4060	40.67	13.04	53.71	60.00	-6.29	QP
12	28.4060	26.14	13.04	39.18	50.00	-10.82	AVG

Remark:

1. All readings are Quasi-Peak and Average values.
2. Margin = Result (Result =Reading + Factor)–Limit

100.0 dBuV

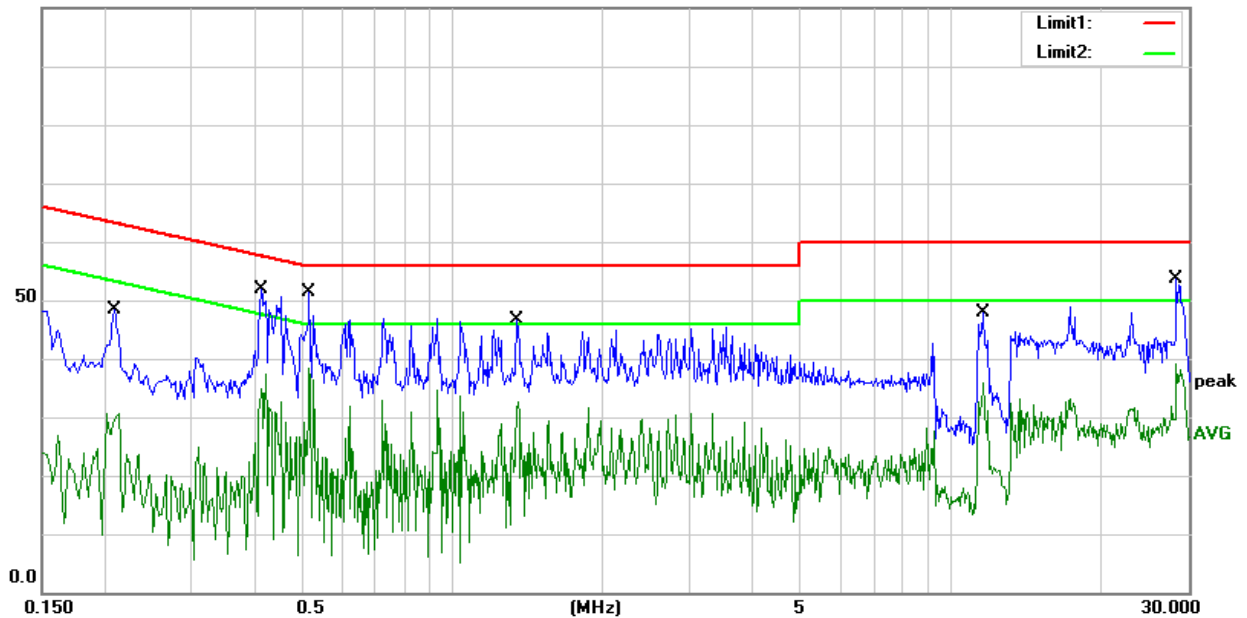

3.2 RADIATED EMISSION MEASUREMENT

3.2.1 RADIATED EMISSION LIMITS

20dBc in any 100 kHz bandwidth outside the operating frequency band. In case the emission fall within the restricted band specified on Part 15.249 and the Part 15.209(a) limit in the table below has to be followed.

Standard FCC 15.209

Frequencies (MHz)	Field Strength (micorvolts/meter)	Measurement Distance (meters)
0.009~0.490	2400/F(KHz)	300
0.490~1.705	24000/F(KHz)	30
1.705~30.0	30	30
30~88	100	3
88~216	150	3
216~960	200	3
960~1000	500	3
Above 1000	Other:74.0 dB(μV)/m (Peak) 54.0 dB(μV)/m (Average)	3

Standard FCC 15.249

Frequency of Emission (MHz)	Field Strength of fundamental (millivolts /meter)	Field Strength of Harmonics (microvolts/meter)
900~928	50	500
2400~2483.5	50	500
5725~5875	50	500
24000~242500	250	2500

Notes:

- (1) Emissions radiated outside of the specified frequency bands, except for harmonics, shall be attenuated by at least 50 dB below the level of the fundamental or to the general radiated emission limits in Section 15.209, whichever is the lesser attenuation.

Spectrum Parameter	Setting
Detector	Peak/AV
Attenuation	Auto
Start Frequency	1000 MHz
Stop Frequency	10th carrier harmonic
RB (emission in restricted band)	>20BW
VB (emission in restricted band)	=3xRB

Receiver Parameter	Setting
Attenuation	Auto
Start ~ Stop Frequency	9kHz~90kHz / RB 200Hz for PK & AV
	90kHz~110kHz / RB 200Hz for QP
	110kHz~490kHz / RB 200Hz for PK & AV
	490kHz~30MHz / RB 9kHz for QP
	30MHz~1000MHz / RB 120kHz for QP

3.2.2 TEST PROCEDURE

- a. The measuring distance of 3m shall be used for measurements. The EUT was placed on the top of a rotating table 0.8 meter above the ground at a 3 meter semi-anechoic chamber. The table was rotated 360 degrees to determine the position of the highest radiation (Below 1GHz)
- b. The measuring distance of 3m shall be used for measurements. The EUT was placed on the top of a rotating table 1.5 meter above the ground at a 3 meter semi-anechoic chamber. The table was rotated 360 degrees to determine the position of the highest radiation (Above 1GHz)
- c. The height of the test antenna shall vary between 1m to 4m. Both horizontal and vertical polarization of the antenna are set to make the measurement.
- d. The initial step in collecting radiated emission data is a receive peak detector mode. Pre-scanning the measurement frequency range. Significant peaks are then marked and then Quasi Peak detector mode re-measured.
- e. All readings are peak unless otherwise stated QP in column of Note. Peak denotes that the Peak reading complies with the QP limits and then QP Mode measurement didn't perform (Below 1GHz)
- f. All readings are Peak mode value unless otherwise stated AVG in column of Note. If the Peak mode measured value complies with the Peak limits and lower than AVG Limits, the EUT shall be deemed to meet Peak & AVG limits and then only Peak mode was measured, but AVG mode didn't perform. (Above 1GHz)
- g. For the actual test configuration, please refer to the related Item –EUT Test Photos.
Note: Both horizontal and vertical antenna polarities were tested and performed pretest to three orthogonal axes. The worst case emissions were reported.

3.2.3 DEVIATION FROM TEST STANDARD

No deviation

3.2.4 TEST SETUP

(A) Radiated Emission Test-Up Frequency Below 30MHz

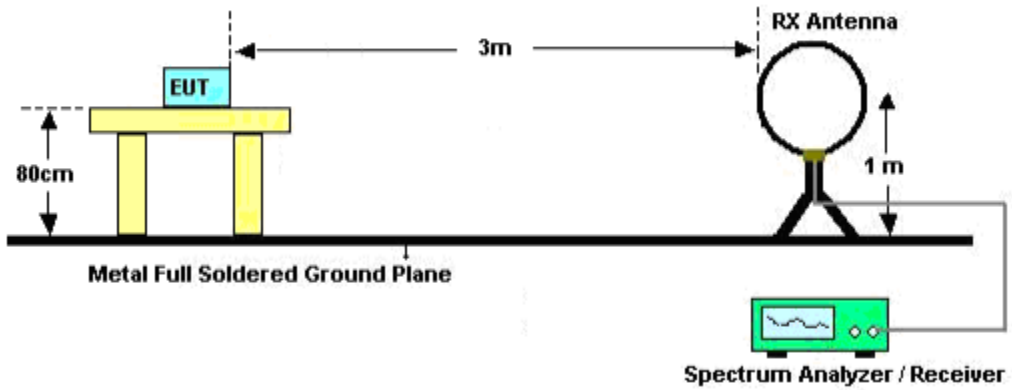

(B) Radiated Emission Test-Up Frequency 30MHz~1GHz

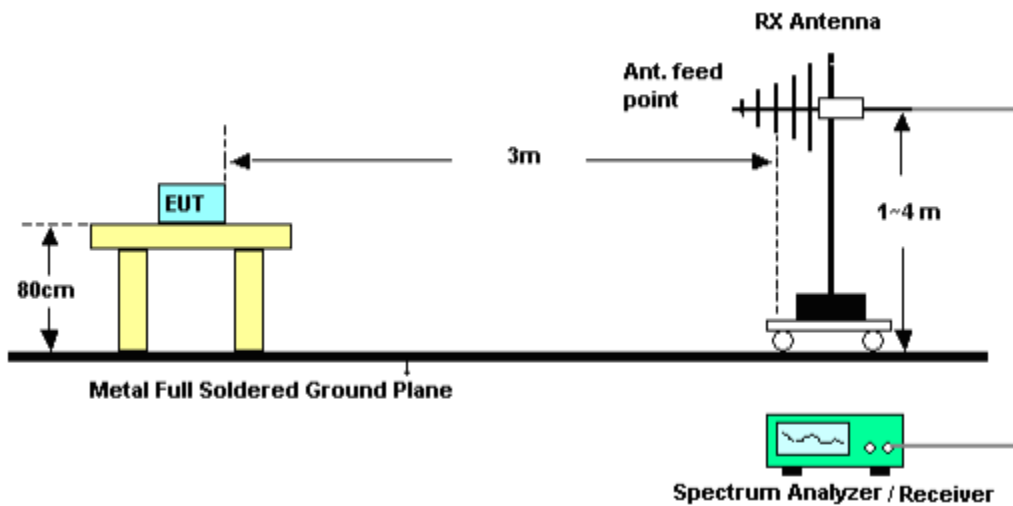

(C) Radiated Emission Test-Up Frequency Above 1GHz

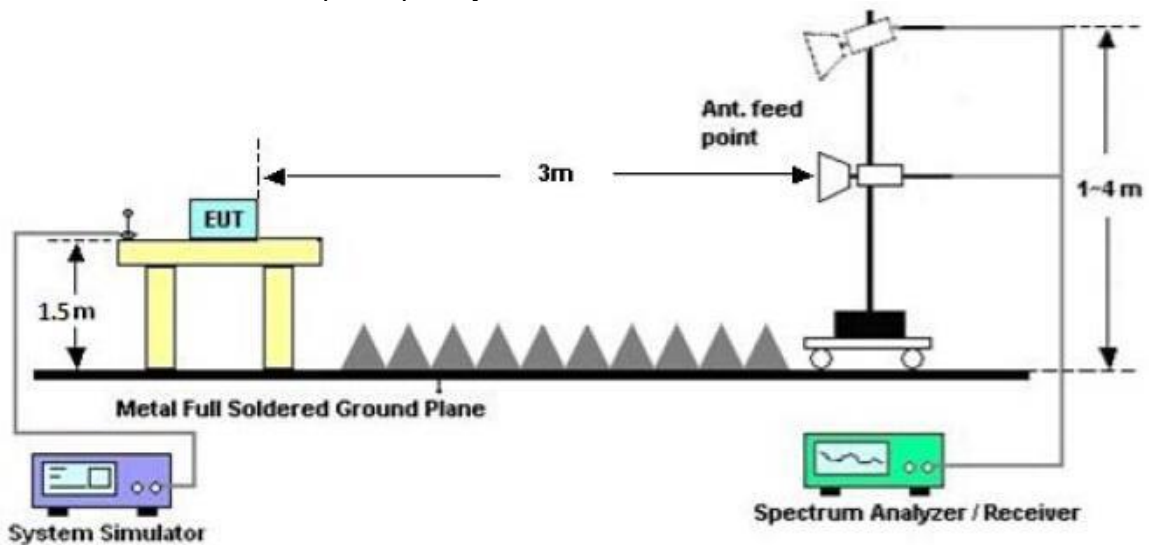



3.2.5 FIELD STRENGTH CALCULATION

The field strength is calculated by adding the Antenna Factor and Cable Factor and subtracting the Amplifier Gain and Duty Cycle Correction Factor (if any) from the measured reading. The basic equation with a sample calculation is as follows:

Margin=PL-PK L or AL- AV L; Margin only shown the worst case.

Where

PR = Peak Reading

AR = Average Reading

PL = Peak Level

AL = Average Level

AF = Antenna Factor

PK L = Peak Limit

AV L = AV Limit

For example

Frequency	PR	AR	AF	PL	AL	PK L	AV L	Margin
(MHz)	(dB μ V/m)	(dB μ V/m)	(dB)	(dB μ V/m)	(dB μ V/m)	(dB μ V/m)	(dB μ V/m)	(dB)
2178	40.23	30.31	9.83	50.06	40.14	74.00	54.00	-13.86





3.2.6 EUT OPERATING CONDITIONS

The EUT tested system was configured as the statements of 2.4 Unless otherwise a special operating condition is specified in the follows during the testing.

Below 30 MHz

Temperature:	23.1(C)	Relative Humidity:	60%RH
Test Voltage:	AC 120V/60Hz	Polarization:	---
Test Mode:	TX Mode		

Freq. (MHz)	Reading (dBuV/m)	Limit (dBuV/m)	Margin (dB)	State P/F
--	--	--	--	PASS
--	--	--	--	PASS

NOTE:

The amplitude of spurious emissions which are attenuated by more than 20dB below the permissible value has no need to be reported.

Distance extrapolation factor = $40 \log(\text{specific distance}/\text{test distance})$ (dB);

Limit line = specific limits(dBuv) + distance extrapolation factor.

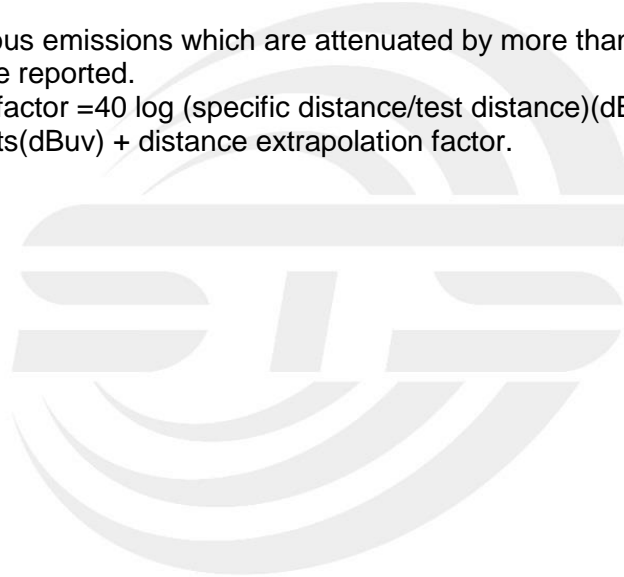



Between 30MHz – 1000 MHz Radiation Spurious

Temperature:	23.1(C)	Relative Humidity:	60%RH
Test Voltage:	AC 120V/60Hz	Phase:	Horizontal
Test Mode:	Mode 1/2/3 (Mode 3 worst mode)		

No.	Frequency (MHz)	Reading (dBuV)	Correct Factor(dB/m)	Result (dBuV/m)	Limit (dBuV/m)	Margin (dB)	Remark
1	59.1000	49.89	-25.73	24.16	40.00	-15.84	peak
2	166.7700	46.58	-19.49	27.09	43.50	-16.41	peak
3	344.2800	42.43	-13.26	29.17	46.00	-16.83	peak
4	456.8000	39.90	-9.53	30.37	46.00	-15.63	peak
5	733.2500	31.14	-2.35	28.79	46.00	-17.21	peak
6	834.1300	29.46	-0.59	28.87	46.00	-17.13	peak

Remark:

1. Margin = Result (Result =Reading + Factor)–Limit

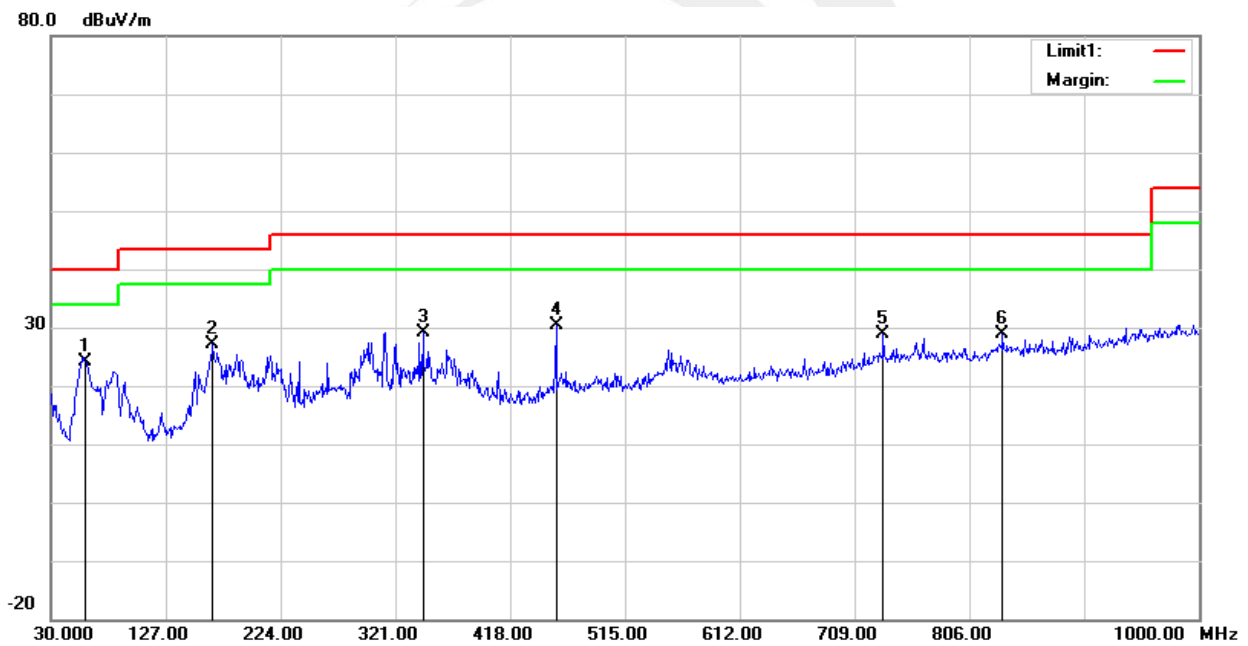



Temperature:	23.1(C)	Relative Humidity:	60%RH
Test Voltage:	AC 120V/60Hz	Phase:	Vertical
Test Mode:	Mode 1/2/3 (Mode 3 worst mode)		

No.	Frequency (MHz)	Reading (dBuV)	Correct Factor(dB/m)	Result (dBuV/m)	Limit (dBuV/m)	Margin (dB)	Remark
1	56.1900	55.24	-25.30	29.94	40.00	-10.06	peak
2	312.2700	38.37	-14.36	24.01	46.00	-21.99	peak
3	455.8300	32.23	-9.55	22.68	46.00	-23.32	peak
4	667.2900	29.56	-4.64	24.92	46.00	-21.08	peak
5	778.8400	29.81	-2.23	27.58	46.00	-18.42	peak
6	902.0300	34.27	-0.40	33.87	46.00	-12.13	peak

Remark:

1. Margin = Result (Result =Reading + Factor)–Limit

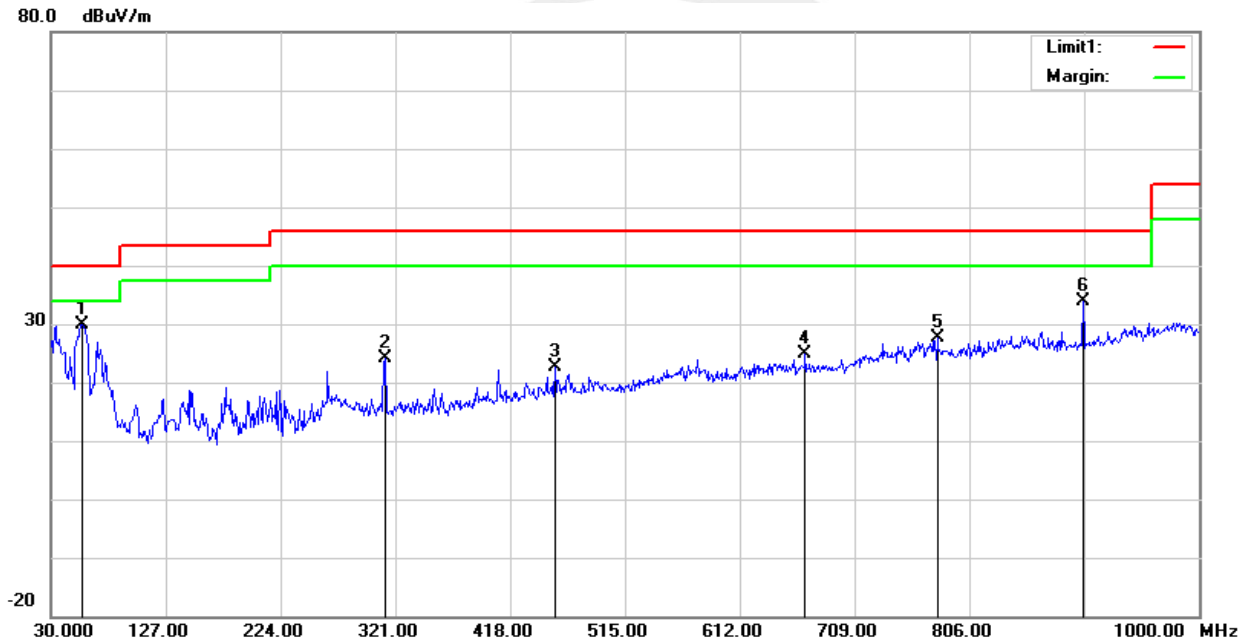



Above 1G Radiation Spurious

PK
2420MHz

Frequency	Meter Reading	Detector	Amplifier	Loss	Antenna Factor	Orrected Factor	Corrected Amplitude	Limit	Margin	RX Antenna Polar
(MHz)	(dB μ V/m)	(PK/QP/AV)	(dB)	(dB)	(dB/m)	(dB)	(dB μ V/m)	(dB μ V/m)	(dB)	(H/V)
4840.07	62.57	PK	50.33	8.84	31.22	-10.27	52.30	74	-21.70	H
4840.07	62.17	PK	50.33	8.84	31.22	-10.27	51.90	74	-22.10	V
7260.27	59.80	PK	55.48	9.31	34.05	-12.12	47.68	74	-26.32	H
7260.27	58.40	PK	55.48	9.31	34.05	-12.12	46.28	74	-27.72	V
9680.10	62.81	PK	59.13	9.89	36.99	-12.25	50.56	74	-23.44	H
9680.10	62.23	PK	59.13	9.89	36.99	-12.25	49.98	74	-24.02	V

2443MHz

Frequency	Meter Reading	Detector	Amplifier	Loss	Antenna Factor	Orrected Factor	Corrected Amplitude	Limit	Margin	RX Antenna Polar
(MHz)	(dB μ V/m)	(PK/QP/AV)	(dB)	(dB)	(dB/m)	(dB)	(dB μ V/m)	(dB μ V/m)	(dB)	(H/V)
4886.11	62.93	PK	50.33	8.84	31.22	-10.27	52.66	74	-21.34	H
4886.11	62.37	PK	50.33	8.84	31.22	-10.27	52.10	74	-21.90	V
7329.09	59.87	PK	55.48	9.31	34.05	-12.12	47.75	74	-26.25	H
7329.09	58.46	PK	55.48	9.31	34.05	-12.12	46.34	74	-27.66	V
9771.91	62.98	PK	59.13	9.89	36.99	-12.25	50.73	74	-23.27	H
9771.91	62.21	PK	59.13	9.89	36.99	-12.25	49.96	74	-24.04	V

2465MHz

Frequency	Meter Reading	Detector	Amplifier	Loss	Antenna Factor	Orrected Factor	Corrected Amplitude	Limit	Margin	RX Antenna Polar
(MHz)	(dB μ V/m)	(PK/QP/AV)	(dB)	(dB)	(dB/m)	(dB)	(dB μ V/m)	(dB μ V/m)	(dB)	(H/V)
4930.07	63.02	PK	50.33	8.84	31.22	-10.27	52.75	74	-21.25	H
4930.07	62.38	PK	50.33	8.84	31.22	-10.27	52.11	74	-21.89	V
7395.07	59.83	PK	55.48	9.31	34.05	-12.12	47.71	74	-26.29	H
7395.07	58.30	PK	55.48	9.31	34.05	-12.12	46.18	74	-27.82	V
9860.16	62.98	PK	59.13	9.89	36.99	-12.25	50.73	74	-23.27	H
9860.16	62.09	PK	59.13	9.89	36.99	-12.25	49.84	74	-24.16	V

The peak value is less than the AV limit, so AV data does not need to be tested



Duty cycle

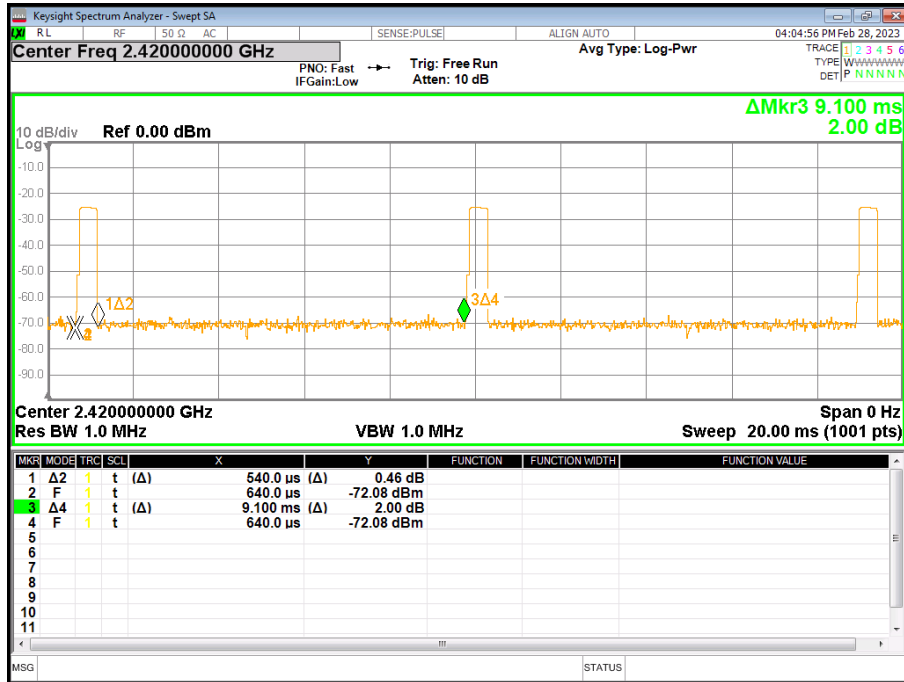

Ton (ms)	Tp (ms)	Duty Factor
0.54	9.1	-24.53

Note: Duty Factor=20*LOG10(1/(Ton/Tp))



(Radiation Band edge)

Low channel
Horizontal

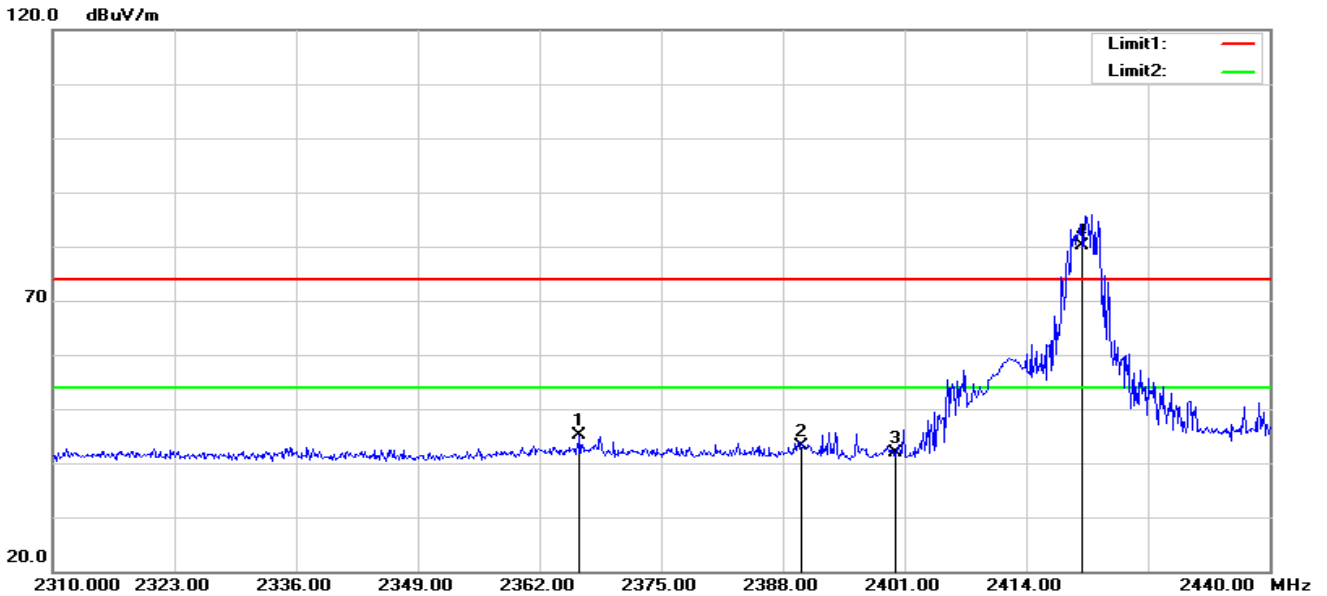

No.	Frequency (MHz)	Reading (dBuV)	Correct Factor(dB/m)	Result (dBuV/m)	Limit (dBuV/m)	Margin (dB)	Remark
1	2366.290	41.06	3.99	45.05	74.00	-28.95	peak
2	2390.000	38.87	4.34	43.21	74.00	-30.79	peak
3	2400.000	37.30	4.49	41.79	74.00	-32.21	peak

Fundamental Frequency

No.	Frequency (MHz)	Reading (dBuV)	Correct Factor(dB/m)	Duty cycle Factor(dB/m)	Result (dBuV/m)	Limit (dBuV/m)	Margin (dB)	Remark
4	2420.000	75.70	4.50	-	80.2	114	-33.8	peak
5	2420.000	75.70	4.50	-24.53	55.67	94	-38.33	AVG



Vertical

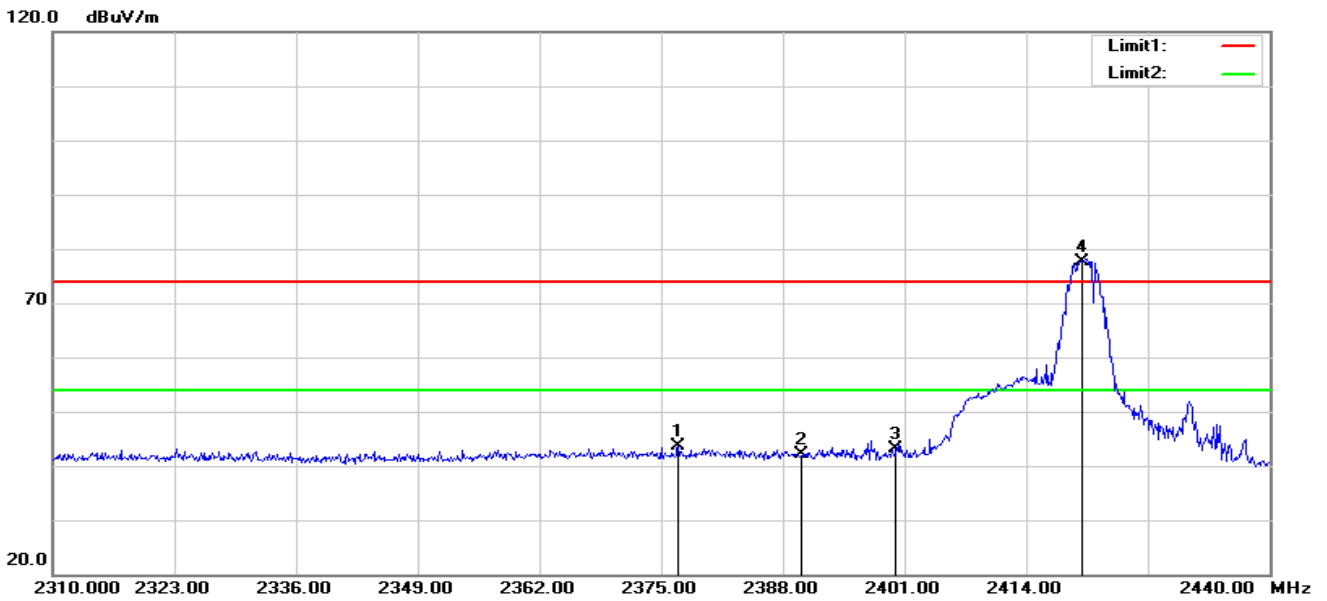

No.	Frequency (MHz)	Reading (dBuV)	Correct Factor(dB/m)	Result (dBuV/m)	Limit (dBuV/m)	Margin (dB)	Remark
1	2376.820	39.44	4.14	43.58	74.00	-30.42	peak
2	2390.000	37.80	4.34	42.14	74.00	-31.86	peak
3	2400.000	38.58	4.49	43.07	74.00	-30.93	peak

Fundamental Frequency

No.	Frequency (MHz)	Reading (dBuV)	Correct Factor(dB/m)	Duty cycle Factor(dB/m)	Result (dBuV/m)	Limit (dBuV/m)	Margin (dB)	Remark
4	2420.000	73.17	4.50	-	77.67	114	-36.33	peak
5	2420.000	73.17	4.50	-24.53	53.14	94	-40.86	AVG



Mid channel
Horizontal

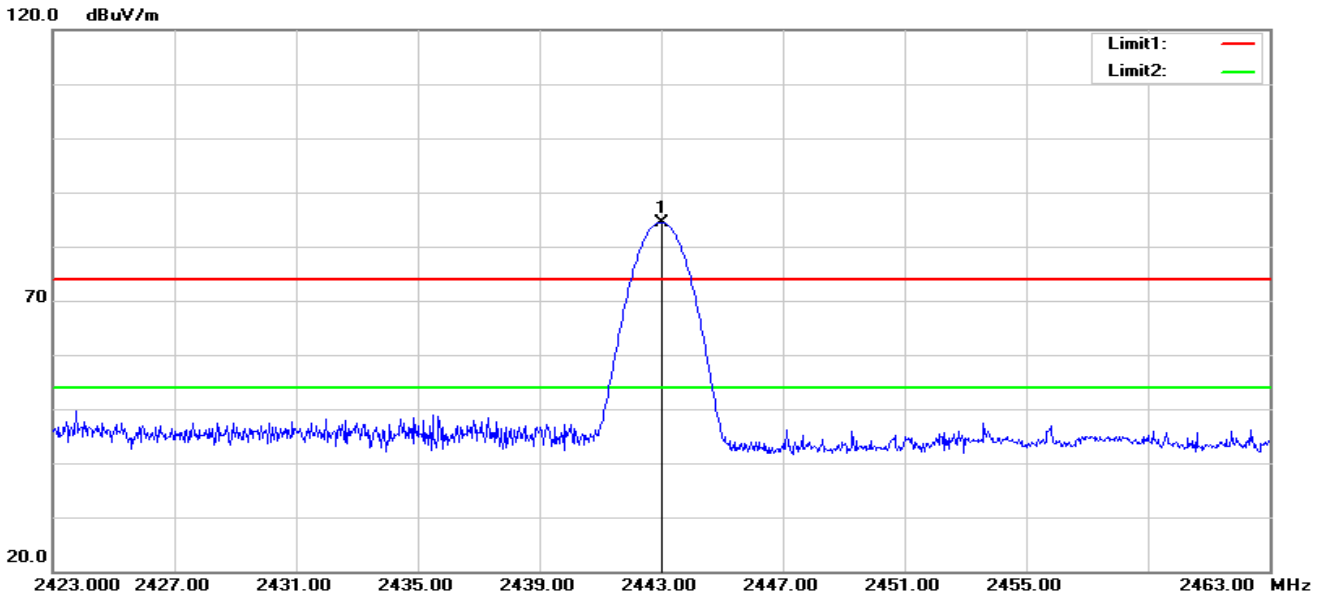

No.	Frequency (MHz)	Reading (dBuV)	Correct Factor(dB/m)	Duty cycle Factor(dB/m)	Result (dBuV/m)	Limit (dBuV/m)	Margin (dB)	Remark
1	2443.000	79.93	4.52	-	84.45	114	-29.55	peak
2	2443.000	79.93	4.52	-24.53	59.92	94	-34.08	AVG

Vertical

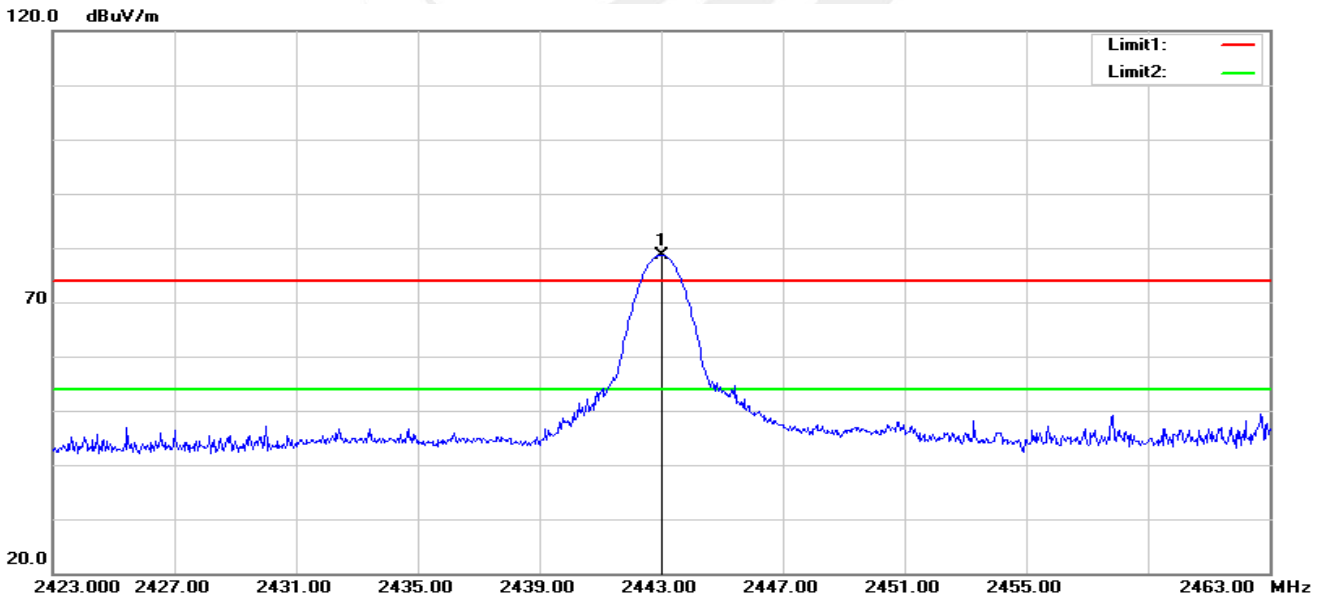

No.	Frequency (MHz)	Reading (dBuV)	Correct Factor(dB/m)	Duty cycle Factor(dB/m)	Result (dBuV/m)	Limit (dBuV/m)	Margin (dB)	Remark
1	2443.000	74.18	4.52	-	78.7	114	-35.3	peak
2	2443.000	74.18	4.52	-24.53	54.17	94	-39.83	AVG



High channel Horizontal

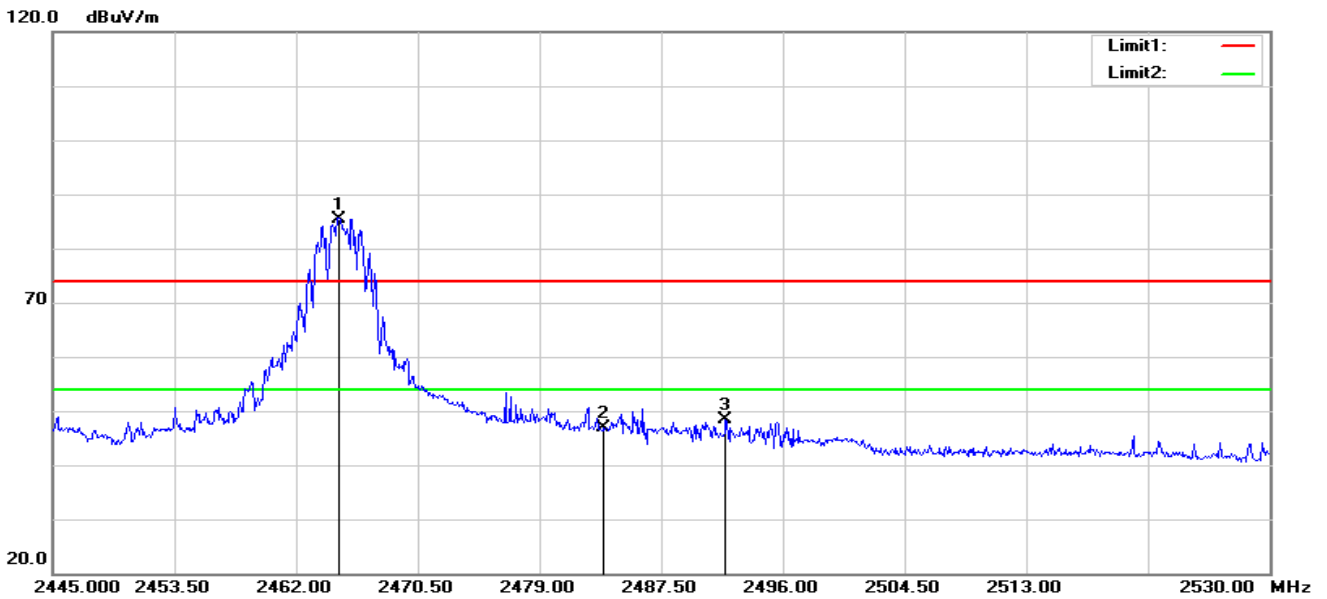

No.	Frequency (MHz)	Reading (dBuV)	Correct Factor(dB/m)	Result (dBuV/m)	Limit (dBuV/m)	Margin (dB)	Remark
2	2483.500	42.17	4.60	46.77	74.00	-27.23	peak
3	2492.005	43.63	4.63	48.26	74.00	-25.74	peak

Fundamental Frequency

No.	Frequency (MHz)	Reading (dBuV)	Correct Factor(dB/m)	Duty cycle Factor(dB/m)	Result (dBuV/m)	Limit (dBuV/m)	Margin (dB)	Remark
1	2465.000	80.92	4.56	-	85.48	114	-28.52	peak
4	2465.000	80.92	4.56	-24.53	60.95	94	-33.05	AVG



Vertical

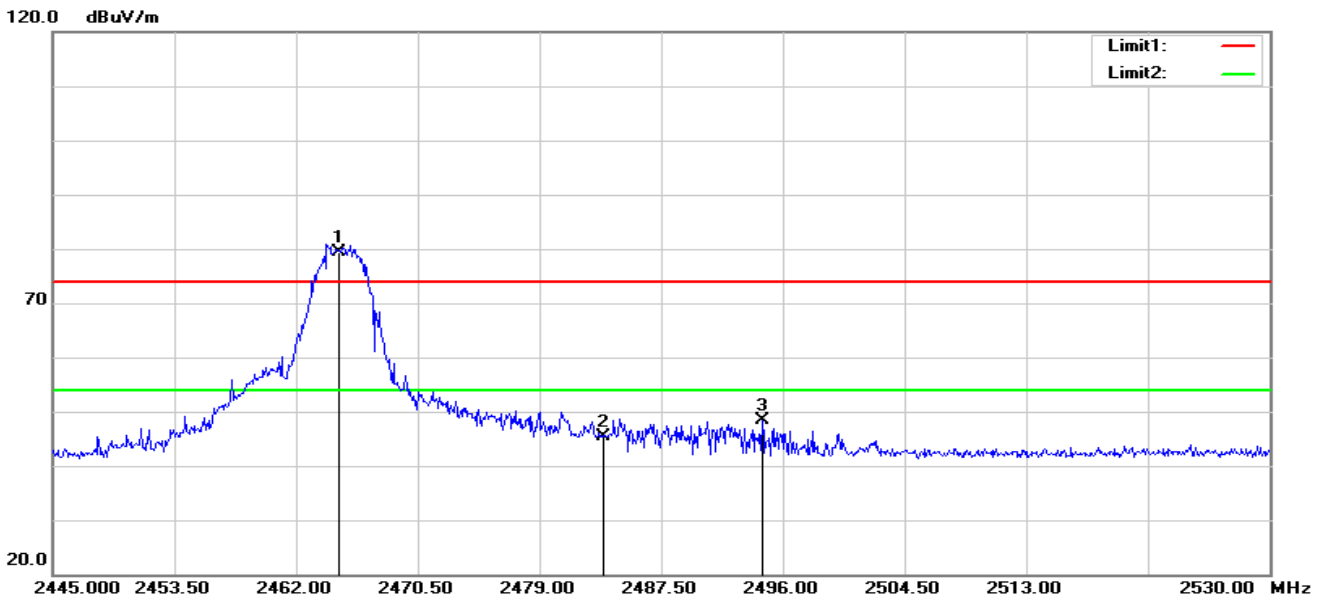

No.	Frequency (MHz)	Reading (dBuV)	Correct Factor(dB/m)	Result (dBuV/m)	Limit (dBuV/m)	Margin (dB)	Remark
2	2483.500	40.72	4.60	45.32	74.00	-28.68	peak
3	2494.555	43.81	4.63	48.44	74.00	-25.56	peak

Fundamental Frequency

No.	Frequency (MHz)	Reading (dBuV)	Correct Factor(dB/m)	Duty cycle Factor(dB/m)	Result (dBuV/m)	Limit (dBuV/m)	Margin (dB)	Remark
1	2465.000	74.81	4.56	-	79.37	114	-34.63	peak
4	2465.000	74.81	4.56	-24.53	54.84	94	-39.16	AVG

4. BANDWIDTH TEST

4.1 TEST PROCEDURE

- a. The EUT was directly connected to the spectrum analyzer and antenna output port as show in the block diagram below.
- b. Spectrum Setting : RBW= 1% to 5% OBW, VBW \geq RBW, Sweep time = Auto.

4.2 TEST SETUP



4.3 EUT OPERATION CONDITIONS

TX mode.





4.4 TEST RESULTS

Temperature:	25 °C	Relative Humidity:	50%
Test Voltage:	AC 120V/60Hz		

Test Channel	Frequency(MHz)	20 dB Bandwidth(MHz)	99% Bandwidth(MHz)
CH01	2420	2.499	2.6574
CH02	2443	2.327	2.5453
CH03	2465	1.866	2.2337

Low Channel

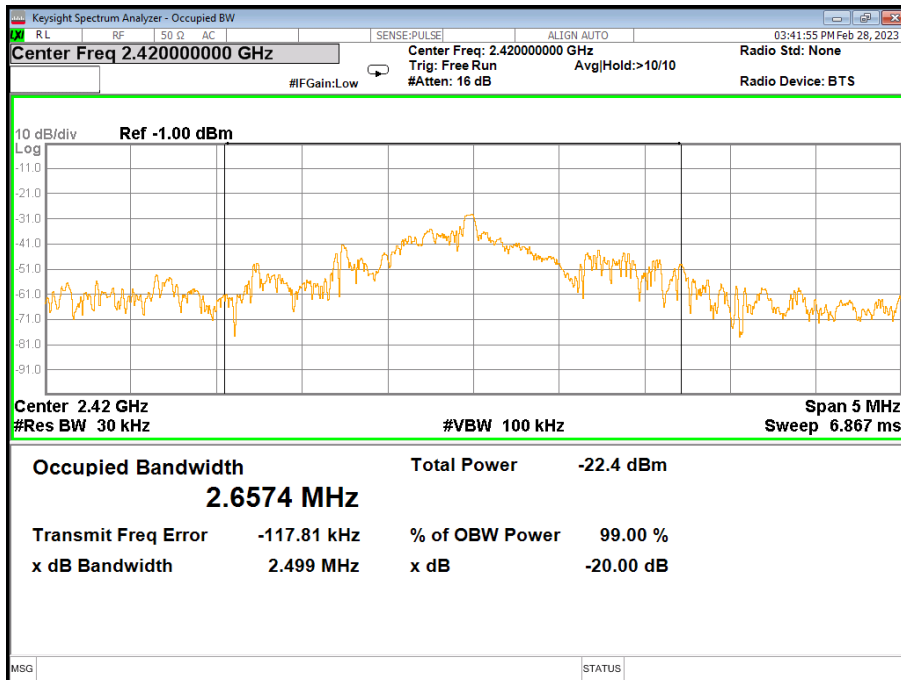



Mid Channel

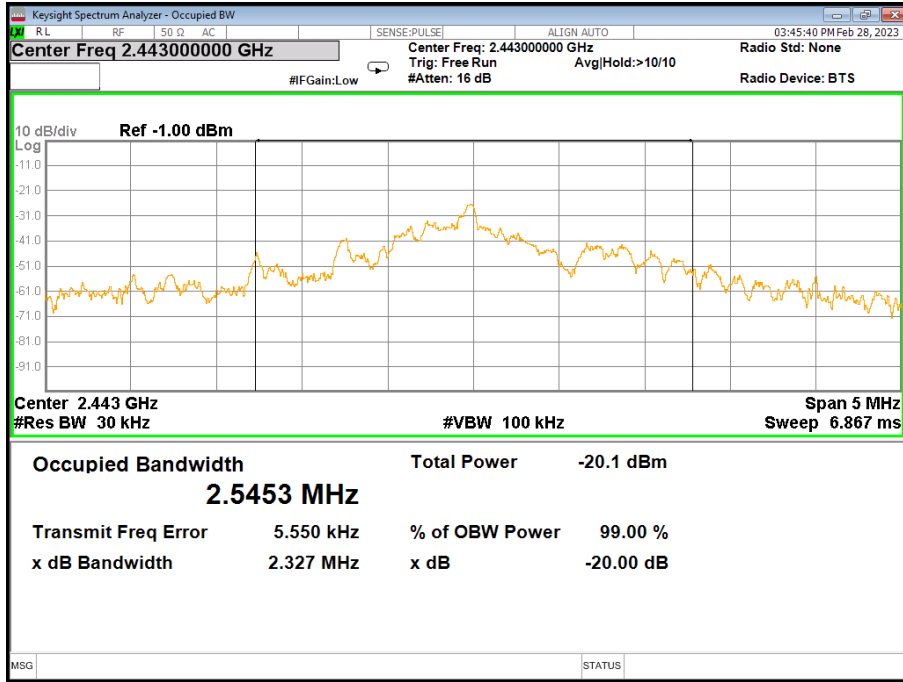

High Channel

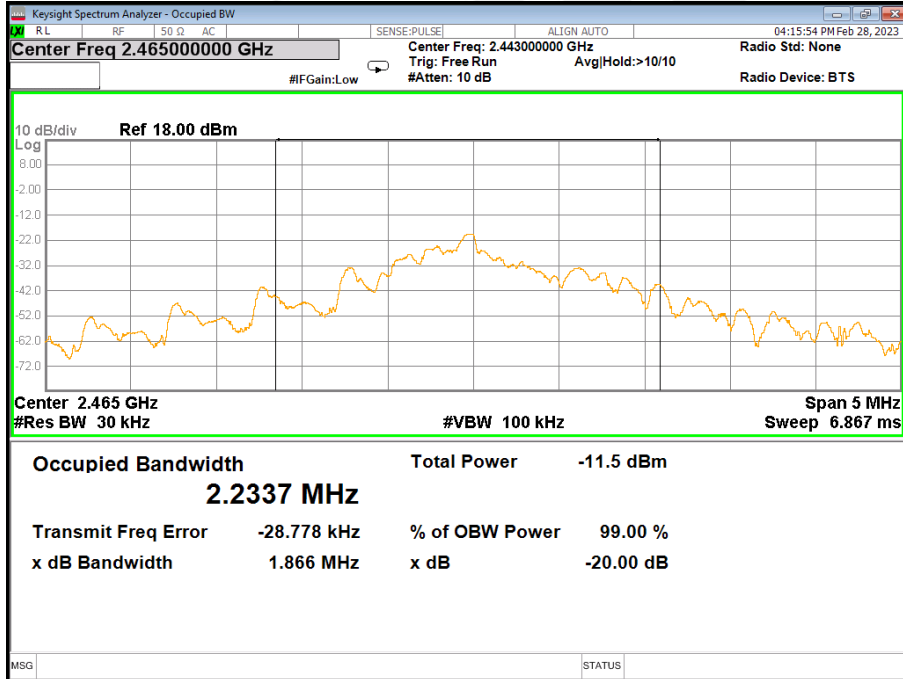



5. ANTENNA REQUIREMENT

5.1 STANDARD REQUIREMENT

According to the FCC Part 15 Paragraph 15.203, an intentional radiator shall be designed to ensure that no antenna other than that furnished by the responsible party shall be used with the device.

5.2 EUT ANTENNA

The EUT antenna is Internal Antenna.It conforms to the standard requirements.





APPENDIX- PHOTOS OF TEST SETUP

Note: See test photos in setup photo document for the actual connections between Product and support equipment.

*****END OF THE REPORT*****

