



## RADIO TEST REPORT

Report No.: STS2203049W01

Issued for

GEMMY INDUSTRIES (HK)LIMITED BVI

Unit No.301 on 3rd Floor, East Ocean Centre, No.98, Hong Kong

<b>Product Name:</b>	Orchestra of Lights- Pathway Stakes
<b>Brand Name:</b>	N/A
<b>Model Name:</b>	880108
<b>Series Model:</b>	N/A
<b>FCC ID:</b>	GPO880108
<b>Test Standard:</b>	FCC Part 15.249

Any reproduction of this document must be done in full. No single part of this document may be reproduced without permission from STS, All Test Data Presented in this report is only applicable to presented Test sample.

Shenzhen STS Test Services Co., Ltd.  
A 1/F, Building B, Zhuoke Science Park, No.190 Chongqing Road, HepingShequ  
Fuyong Sub-District, Bao'an District, Shenzhen, Guang Dong, China  
TEL: +86-755 3688 6288 FAX: +86-755 3688 6277 E-mail: sts@stsapp.com





TEST RESULT CERTIFICATION

Applicant's Name .....: GEMMY INDUSTRIES (HK)LIMITED BVI
Address .....: Unit No.301 on 3rd Floor, East Ocean Centre, No.98, Hong Kong

Manufacture's Name .....: GEMMY INDUSTRIES (HK)LIMITED BVI
Address .....: Unit No.301 on 3rd Floor, East Ocean Centre, No.98, Hong Kong

Product Description

Product Name .....: Orchestra of Lights- Pathway Stakes
Brand Name .....: N/A
Model Name .....: 880108
Series Model .....: N/A

Test Standards.....: FCC Part15.249
Test Procedure .....: ANSI C63.10-2013

This device described above has been tested by STS, the test results show that the equipment under test (EUT) is in compliance with the FCC requirements. And it is applicable only to the tested sample identified in the report.
This report shall not be reproduced except in full, without the written approval of STS, this document only be altered or revised by STS, personal only, and shall be noted in the revision of the document.

Date of Test .....:
Date of receipt of test item .....: 07 Mar. 2022
Date of performance of tests ...: 07 Mar. 2022 ~ 13 Apr. 2022
Date of Issue .....: 13 Apr. 2022
Test Result.....: Pass

Testing Engineer : [Signature: Chris Chen]

(Chris Chen)

Technical Manager : [Signature: Sean She]

(Sean she)

Authorized Signatory : [Signature: Bovey Yang]

(Bovey Yang)





<b>Table of Contents</b>	<b>Page</b>
<b>1. SUMMARY OF TEST RESULTS</b>	<b>5</b>
1.1 TEST FACTORY	6
1.2 MEASUREMENT UNCERTAINTY	6
<b>2. GENERAL INFORMATION</b>	<b>7</b>
2.1 GENERAL DESCRIPTION OF THE EUT	7
2.2 DESCRIPTION OF THE TEST MODES	8
2.3 TEST SOFTWARE AND POWER LEVEL	8
2.4 BLOCK DIGRAM SHOWING THE CONFIGURATION OF SYSTEM TESTED	9
2.5 DESCRIPTION OF NECESSARY ACCESSORIES AND SUPPORT UNITS	10
2.6 EQUIPMENTS LIST FOR ALL TEST ITEMS	11
<b>3. EMC EMISSION TEST</b>	<b>13</b>
3.1 CONDUCTED EMISSION MEASUREMENT	13
3.2 RADIATED EMISSION MEASUREMENT	17
<b>4. BANDWIDTH TEST</b>	<b>36</b>
4.1 TEST PROCEDURE	36
4.2 TEST SETUP	36
4.3 EUT OPERATION CONDITIONS	36
4.4 TEST RESULTS	37
<b>5. ANTENNA REQUIREMENT</b>	<b>39</b>
5.1 STANDARD REQUIREMENT	39
5.2 EUT ANTENNA	39
<b>APPENDIX- PHOTOS OF TEST SETUP</b>	<b>40</b>



**Revision History**

Rev.	Issue Date	Report NO.	Effect Page	Contents
00	13 Apr. 2022	STS2203049W01	ALL	Initial Issue





## 1. SUMMARY OF TEST RESULTS

Test procedures according to the technical standards:

FCC Part 15.249 , Subpart C			
Standard Section	Test Item	Judgment	Remark
15.207	Conducted Emission	Pass	
15.203	Antenna Requirement	Pass	
15.249	Radiated Spurious Emission	Pass	
15.249	Radiated Band Edge Emission	Pass	
15.249	Field Strength of fundamental	Pass	
15.215(c)	20dB Bandwidth	Pass	

NOTE:

- (1) 'N/A' denotes test is not applicable in this Test Report.
- (2) All tests are according to ANSI C63.10-2013.

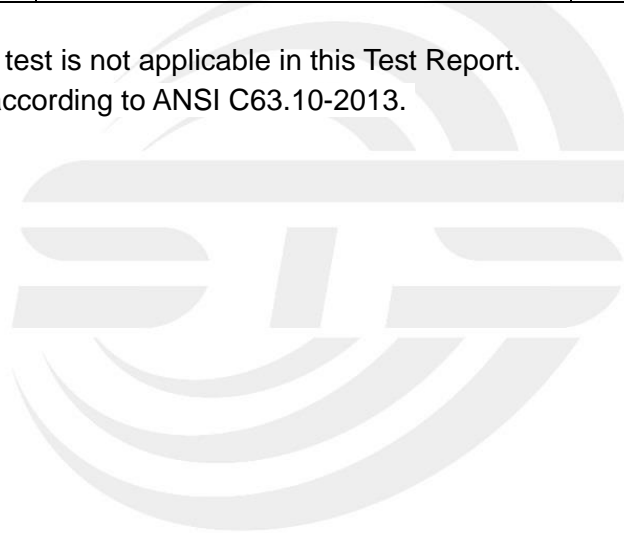



### 1.1 TEST FACTORY

SHENZHEN STS TEST SERVICES CO., LTD

Add. : A 1/F, Building B, Zhuoke Science Park, No.190 Chongqing Road, HepingShequ, Fuyong Sub-District, Bao'an District, Shenzhen, Guang Dong, China

FCC test Firm Registration Number: 625569

IC test Firm Registration Number: 12108A

A2LA Certificate No.: 4338.01

### 1.2 MEASUREMENT UNCERTAINTY

The reported uncertainty of measurement  $y \pm U$ , where expanded uncertainty  $U$  is based on a standard uncertainty multiplied by a coverage factor of  $k=2$ , providing a level of confidence of approximately **95 %**.

No.	Item	Uncertainty
1	RF output power, conducted	$\pm 0.87\text{dB}$
2	Unwanted Emissions, conducted	$\pm 2.895\text{dB}$
3	All emissions, radiated 9K-30MHz	$\pm 3.80\text{dB}$
4	All emissions, radiated 30M-1GHz	$\pm 4.09\text{dB}$
5	All emissions, radiated 1G-6GHz	$\pm 4.92\text{dB}$
6	All emissions, radiated >6G	$\pm 5.49\text{dB}$
7	Conducted Emission (9KHz-30MHz)	$\pm 2.73\text{dB}$

## 2. GENERAL INFORMATION

### 2.1 GENERAL DESCRIPTION OF THE EUT

Product Name	Orchestra of Lights- Pathway Stakes								
Trade Name	N/A								
Model Name	880108								
Series Model	N/A								
Model Difference	N/A								
Product Description	<p>The EUT is a Orchestra of Lights- Pathway Stakes</p> <table border="1"> <tr> <td>Operation Frequency:</td> <td>2420MHz, 2443MHz, 2465MHz</td> </tr> <tr> <td>Modulation Type:</td> <td>GFSK</td> </tr> <tr> <td>Antenna Designation:</td> <td>Please refer to the Note 3.</td> </tr> <tr> <td>Antenna Gain(Peak):</td> <td>4dBi</td> </tr> </table> <p>Based on the application, features, or specification exhibited in User Manual, the EUT is considered as an ITE/Computing Device. More details of EUT technical specification, please refer to the User Manual.</p>	Operation Frequency:	2420MHz, 2443MHz, 2465MHz	Modulation Type:	GFSK	Antenna Designation:	Please refer to the Note 3.	Antenna Gain(Peak):	4dBi
Operation Frequency:	2420MHz, 2443MHz, 2465MHz								
Modulation Type:	GFSK								
Antenna Designation:	Please refer to the Note 3.								
Antenna Gain(Peak):	4dBi								
Channel List	Please refer to the Note 2.								
Rating	Input: 120V, 60Hz								
Hardware version number	ZXS102 (V2.1)								
Software version number	880108 -USA (V1)								
Connecting I/O Port(s)	Please refer to the Note 1.								

Note:

1. For a more detailed features description, please refer to the manufacturer's specifications or the User Manual.

2.

Channel List					
Channel	Frequency (MHz)	Channel	Frequency (MHz)	Channel	Frequency (MHz)
01	2402	02	2443	03	2465

3. Table for Filed Antenna

Ant	Brand	Model Name	Antenna Type	Connector	Gain (dBi)	NOTE
1	N/A	880108	Monopole	N/A	4dBi	Antenna

Note: The antenna information refer the manufacturer provide report, applicable only to the tested sample identified in the report.



## 2.2 DESCRIPTION OF THE TEST MODES

For conducted test items and radiated spurious emissions

Each of these EUT operation mode(s) or test configuration mode(s) mentioned below was evaluated respectively.

Pretest Mode	Description	Data/Modulation
Mode 1	TX Low channel	GFSK
Mode 2	TX Mid channel	GFSK
Mode 3	TX High channel	GFSK

Note:

(1) All above mode have been measurement, only worst data was reported.

(2) We have be tested for all avaiable U.S. voltage and frequencies(For 120V,50/60Hz and 240V, 50/60Hz) for which the device is capable of operation, and the worst case of 120V,50/60Hz is shown in the report.

For AC Conducted Emission

Test Case	
AC Conducted Emission	Mode 4 : Keeping TX

## 2.3 TEST SOFTWARE AND POWER LEVEL

During testing channel & power controlling software provided by the customer was used to control the operating channel as well as the output power level.

RF Function	Type	Mode Or Modulation type	ANT Gain(dBi)	Power Class	Software For Testing
Other SRD	2.4G	GFSK	4	Default	The EUT has signal transmission when it is powered on



## 2.4 BLOCK DIGRAM SHOWING THE CONFIGURATION OF SYSTEM TESTED

During testing channel & power controlling software provided by the customer was used to control the operating channel as well as the output power level. The RF output power selection is for the setting of RF output power expected by the customer and is going to be fixed on the firmware of the final end product power parameters.

### Radiated Spurious Emission Test

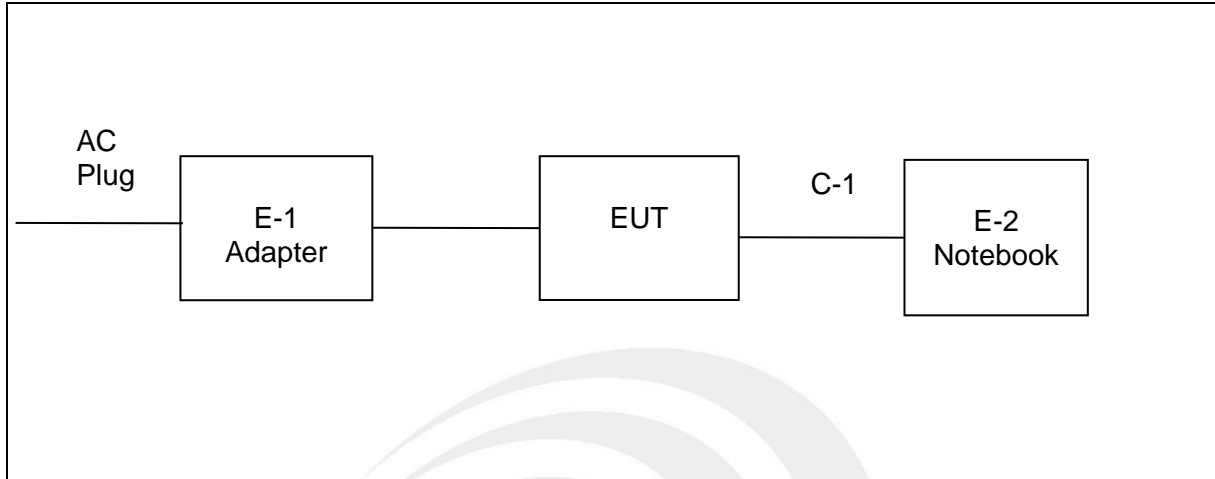

### Conducted Emission Test

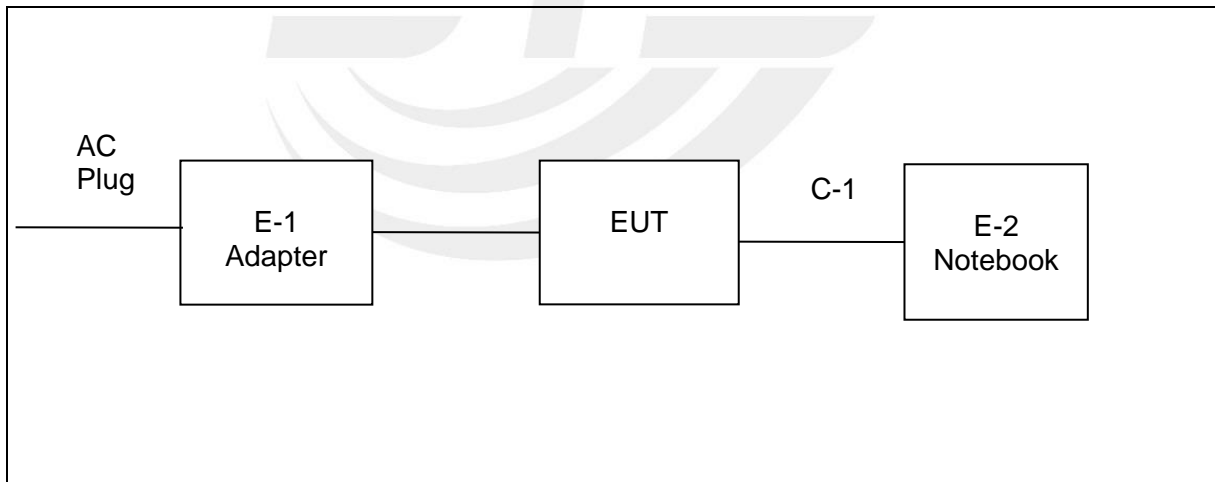

## 2.5 DESCRIPTION OF NECESSARY ACCESSORIES AND SUPPORT UNITS

The EUT has been tested as an independent unit together with other necessary accessories or support units. The following support units or accessories were used to form a representative test configuration during the tests.

### Necessary accessories

Item	Equipment	Mfr/Brand	Model/Type No.	Length	Note
E-1	Adapter	N/A	N/A	N/A	N/A

### Support units

Item	Equipment	Mfr/Brand	Model/Type No.	Length	Note
E-2	Notebook	LENOVO	ThinkPad E470	N/A	N/A
C-1	USB Cable	N/A	N/A	150cm	NO

#### Note:

- (1) The support equipment was authorized by Declaration of Confirmation.
- (2) For detachable type I/O cable should be specified the length in cm in 『Length』 column.

## 2.6 EQUIPMENTS LIST FOR ALL TEST ITEMS

### Radiation Test equipment

Kind of Equipment	Manufacturer	Type No.	Serial No.	Last calibration	Calibrated until
Test Receiver	R&S	ESCI	101427	2021.09.30	2022.09.29
Signal Analyzer	R&S	FSV 40-N	101823	2021.09.30	2022.09.29
Active loop Antenna	ZHINAN	ZN30900C	16035	2021.04.11	2023.04.10
Bilog Antenna	TESEQ	CBL6111D	34678	2020.10.12	2022.10.11
Horn Antenna	SCHWARZBECK	BBHA 9120D	02014	2021.10.11	2023.10.10
SHF-EHF Horn Antenna (18G-40GHz)	A-INFO	LB-180400-KF	J211020657	2020.10.12	2022.10.11
Pre-Amplifier(0.1M-3 GHz)	EM	EM330	060665	2021.10.08	2022.10.07
Pre-Amplifier (1G-18GHz)	SKET	LNPA-01018G-45	SK2018080901	2021.09.30	2022.09.29
Pre-Amplifier (18G-40GHz)	SKET	LNPA-1840-50	SK2018101801	2021.09.28	2022.09.27
Temperature & Humidity	HH660	Mieo	N/A	2021.10.09	2022.10.08
turn table	EM	SC100_1	60531	N/A	N/A
Antenna mast	EM	SC100	N/A	N/A	N/A
Test SW	FARAD	EZ-EMC(Ver.STSLAB-03A1 RE)			

### Conduction Test equipment

Kind of Equipment	Manufacturer	Type No.	Serial No.	Last calibration	Calibrated until
Test Receiver	R&S	ESCI	101427	2021.09.30	2022.09.29
LISN	R&S	ENV216	101242	2021.09.30	2022.09.29
LISN	EMCO	3810/2NM	23625	2021.09.30	2022.09.29
Temperature & Humidity	HH660	Mieo	N/A	2021.10.09	2022.10.08
Test SW	FARAD	EZ-EMC(Ver.STSLAB-03A1 CE)			



## RF Connected Test

Kind of Equipment	Manufacturer	Type No.	Serial No.	Last calibration	Calibrated until
Power Sensor	Keysight	U2021XA	MY55520005	2021.09.30	2022.09.29
			MY55520006	2021.09.30	2022.09.29
			MY56120038	2021.09.30	2022.09.29
			MY56280002	2021.09.30	2022.09.29
Signal Analyzer	Agilent	N9020A	MY51110105	2021.10.11	2023.10.10
Temperature & Humidity	HH660	Mieo	N/A	2021.10.09	2022.10.08
Test SW	FARAD	EZ-EMC(Ver.STSLAB-03A1 RE)			



### 3. EMC EMISSION TEST

#### 3.1 CONDUCTED EMISSION MEASUREMENT

##### 3.1.1 POWER LINE CONDUCTED EMISSION LIMITS

Operating frequency band. In case the emission fall within the restricted band specified on Part 15.249 limit in the table below has to be followed.

FREQUENCY (MHz)	Quasi-peak	Average
0.15 -0.5	66 - 56 *	56 - 46 *
0.50 -5.0	56.00	46.00
5.0 -30.0	60.00	50.00

Note:

- (1) The tighter limit applies at the band edges.
- (2) The limit of “ \* ” marked band means the limitation decreases linearly with the logarithm of the frequency in the range.

The following table is the setting of the receiver

Receiver Parameters	Setting
Attenuation	10 dB
Start Frequency	0.15 MHz
Stop Frequency	30 MHz
IF Bandwidth	9 kHz

### 3.1.2 TEST PROCEDURE

- The EUT was 0.8 meters from the horizontal ground plane and 0.4 meters from the vertical ground plane with EUT being connected to the power mains through a line impedance stabilization network (LISN). All other support equipments powered from additional LISN(s). The LISN provide 50 Ohm/ 50uH of coupling impedance for the measuring instrument.
- Interconnecting cables that hang closer than 40 cm to the ground plane shall be folded back and forth in the center forming a bundle 30 to 40 cm long.
- I/O cables that are not connected to a peripheral shall be bundled in the center. The end of the cable may be terminated, if required, using the correct terminating impedance. The overall length shall not exceed 1 m.
- LISN at least 80 cm from nearest part of EUT chassis.
- For the actual test configuration, please refer to the related Item –EUT Test Photos.

### 3.1.3 TEST SETUP

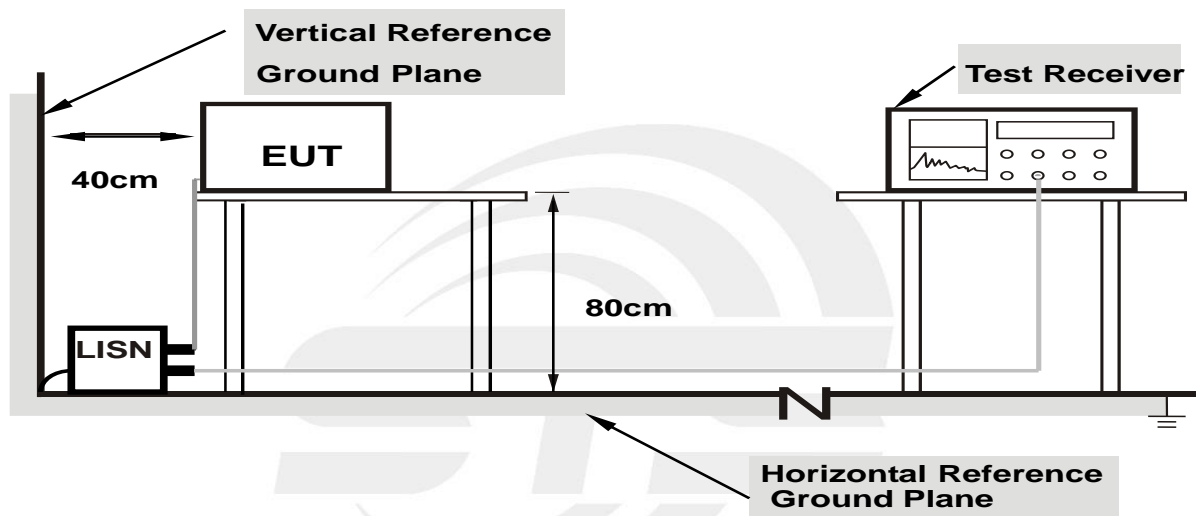

- Note: 1.Support units were connected to second LISN.**  
**2.Both of LISNs (AMN) are 80 cm from EUT and at least 80 cm from other units and other metal planes**

### 3.1.4 EUT OPERATING CONDITIONS

The EUT was configured for testing in a typical fashion (as a customer would normally use it). The EUT has been programmed to continuously transmit during test. This operating condition was tested and used to collect the included data.



3.1.5 TEST RESULT

Temperature:	23.2(C)	Relative Humidity:	44%RH
Test Voltage:	AC 120V/60Hz	Phase:	L
Test Mode:	Mode 4		

No.	Frequency (MHz)	Reading (dBuV)	Correct Factor(dB)	Result (dBuV)	Limit (dBuV)	Margin (dB)	Remark
1	0.2071	31.24	20.34	51.58	63.32	-11.74	QP
2	0.2071	18.58	20.34	38.92	53.32	-14.40	AVG
3	0.4180	29.17	20.54	49.71	57.49	-7.78	QP
4	0.4180	12.36	20.54	32.90	47.49	-14.59	AVG
5	0.7460	26.85	20.34	47.19	56.00	-8.81	QP
6	0.7460	10.71	20.34	31.05	46.00	-14.95	AVG
7	1.2500	26.83	20.31	47.14	56.00	-8.86	QP
8	1.2500	14.45	20.31	34.76	46.00	-11.24	AVG
9	2.3100	24.70	20.32	45.02	56.00	-10.98	QP
10	2.3100	13.34	20.32	33.66	46.00	-12.34	AVG
11	17.1460	15.32	22.23	37.55	60.00	-22.45	QP
12	17.1460	3.08	22.23	25.31	50.00	-24.69	AVG

Remark:

1. All readings are Quasi-Peak and Average values.
2. Margin = Result (Result = Reading + Factor) – Limit





Temperature:	23.2(C)	Relative Humidity:	44%RH
Test Voltage:	AC 120V/60Hz	Phase:	N
Test Mode:	Mode 4		

No.	Frequency (MHz)	Reading (dBuV)	Correct Factor(dB)	Result (dBuV)	Limit (dBuV)	Margin (dB)	Remark
1	0.2060	32.21	20.34	52.55	63.37	-10.82	QP
2	0.2060	19.64	20.34	39.98	53.37	-13.39	AVG
3	0.4580	32.32	20.54	52.86	56.73	-3.87	QP
4	0.4580	16.99	20.54	37.53	46.73	-9.20	AVG
5	0.7620	29.89	20.34	50.23	56.00	-5.77	QP
6	0.7620	12.76	20.34	33.10	46.00	-12.90	AVG
7	1.2180	31.08	20.30	51.38	56.00	-4.62	QP
8	1.2180	13.37	20.30	33.67	46.00	-12.33	AVG
9	1.7780	28.49	20.30	48.79	56.00	-7.21	QP
10	1.7780	15.54	20.30	35.84	46.00	-10.16	AVG
11	4.1340	26.68	20.41	47.09	56.00	-8.91	QP
12	4.1340	12.57	20.41	32.98	46.00	-13.02	AVG

Remark:

1. All readings are Quasi-Peak and Average values.
2. Margin = Result (Result =Reading + Factor )–Limit

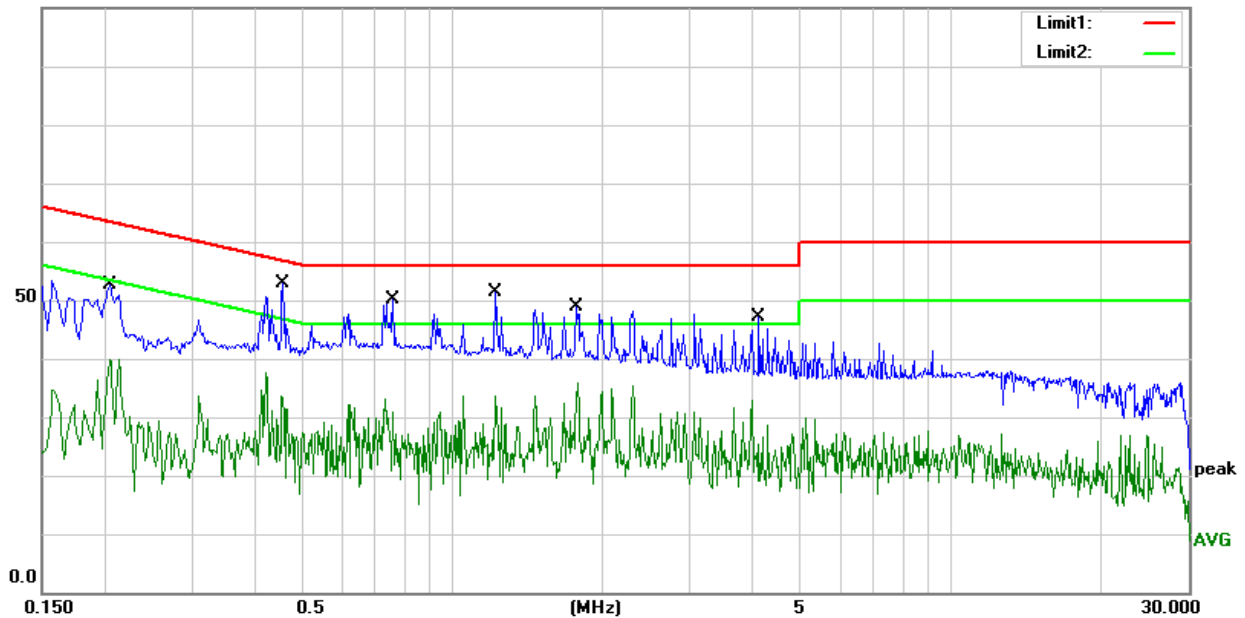





### 3.2 RADIATED EMISSION MEASUREMENT

#### 3.2.1 RADIATED EMISSION LIMITS

20dBc in any 100 kHz bandwidth outside the operating frequency band. In case the emission fall within the restricted band specified on Part 15.249 and the Part 15.209(a) limit in the table below has to be followed.

Standard FCC 15.209

Frequencies (MHz)	Field Strength (micorvolts/meter)	Measurement Distance (meters)
0.009~0.490	2400/F(KHz)	300
0.490~1.705	24000/F(KHz)	30
1.705~30.0	30	30
30~88	100	3
88~216	150	3
216~960	200	3
960~1000	500	3
Above 1000	Other:74.0 dB( $\mu$ V)/m (Peak) 54.0 dB( $\mu$ V)/m (Average)	3

Standard FCC 15.249

Frequency of Emission (MHz)	Field Strength of fundamental (millivolts /meter)	Field Strength of Harmonics (microvolts/meter)
900~928	50	500
2400~2483.5	50	500
5725~5875	50	500
24000~242500	250	2500

Notes:

- (1) Emissions radiated outside of the specified frequency bands, except for harmonics, shall be attenuated by at least 50 dB below the level of the fundamental or to the general radiated emission limits in Section 15.209, whichever is the lesser attenuation.

Spectrum Parameter	Setting
Detector	Peak/AV
Attenuation	Auto
Start Frequency	1000 MHz
Stop Frequency	10th carrier harmonic
RB (emission in restricted band)	>20BW
VB (emission in restricted band)	=3xRB

Receiver Parameter	Setting
Attenuation	Auto
Start ~ Stop Frequency	9kHz~90kHz / RB 200Hz for PK & AV
	90kHz~110kHz / RB 200Hz for QP
	110kHz~490kHz / RB 200Hz for PK & AV
	490kHz~30MHz / RB 9kHz for QP
	30MHz~1000MHz / RB 120kHz for QP

3.2.2 TEST PROCEDURE

- a. The measuring distance of 3m shall be used for measurements. The EUT was placed on the top of arotating table 0.8 meter above the ground at a 3 meter semi-anechoic chamber. The table was rotated 360 degrees to determine the position of the highest radiation(Below 1GHz)
- b. The measuring distance of 3m shall used for measurements. The EUT was placed on the top of a rotating table 1.5 meter above the ground at a 3 meter semi-anechoic chamber. The table was rotated 360 degrees to determine the position of the highest radiation(Above 1GHz)
- c. The height of the test antenna shall vary between 1m to 4m.Both horizontal and vertical polarization Of the antenna are set to make the measurement.
- d. The initial step in collecting radiated emission data is a receive peak detector mode. Pre-scanning the measurement frequency range. Significant peaks are then marked and then Quasi Peak detector mode re-measured.
- e. All readings are peak unless otherwise stated QP in column of Note. Peak denoted that the Peak reading compliance with the QP limits and then QP Mode measurement didn't perform (Below 1GHz)
- f. All readings are Peak mode value unless otherwise stated AVG in column of Note. If the Peak mode measured value compliance with the Peak limits and lower than AVG Limits, the EUT shall be deemed to meet Peak & AVG limits and then only Peak mode was measured, but AVG mode didn't perform.(Above 1GHz)
- g. For the actual test configuration, please refer to the related Item –EUT Test Photos.  
Note: Both horizontal and vertical antenna polarities were tested and performed pretest to three orthogonal axis. The worst case emissions were reported.

3.2.3 DEVIATION FROM TEST STANDARD

No deviation

### 3.2.4 TEST SETUP

#### (A) Radiated Emission Test-Up Frequency Below 30MHz

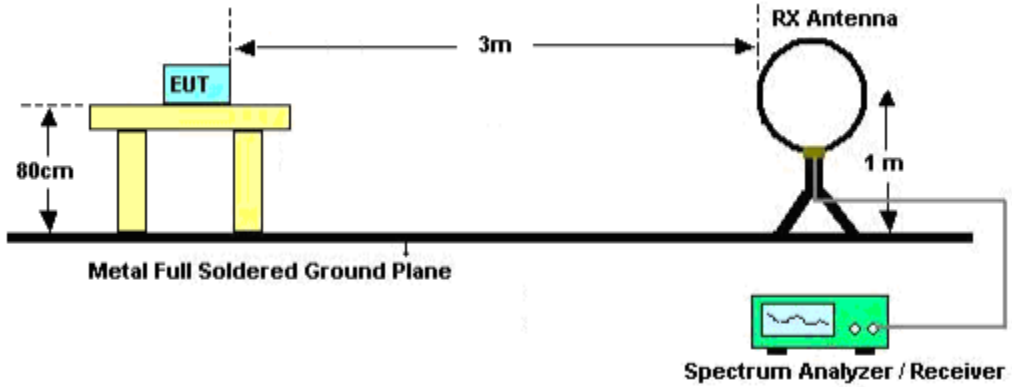

#### (B) Radiated Emission Test-Up Frequency 30MHz~1GHz

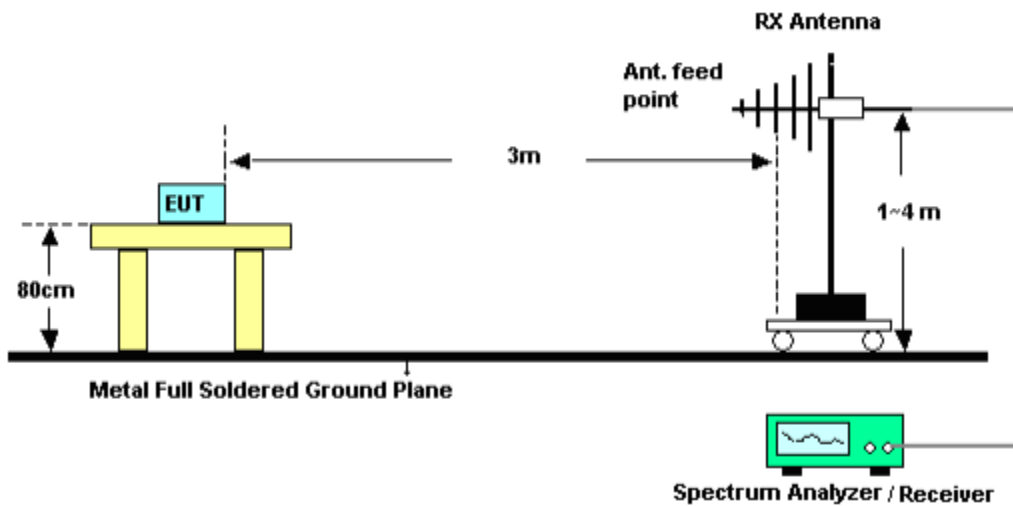

#### (C) Radiated Emission Test-Up Frequency Above 1GHz

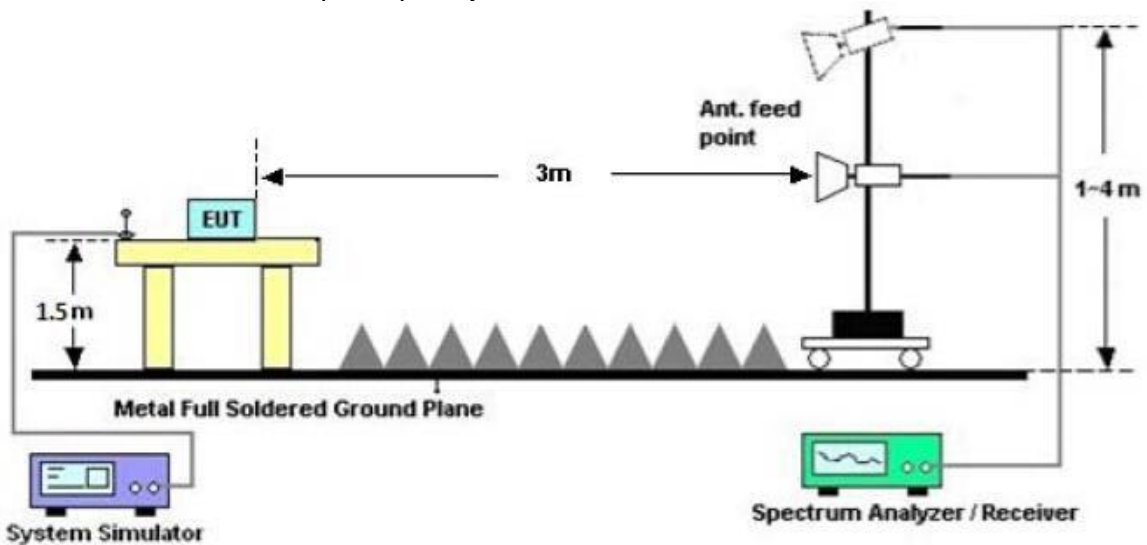



### 3.2.5 FIELD STRENGTH CALCULATION

The field strength is calculated by adding the Antenna Factor and Cable Factor and subtracting the Amplifier Gain and Duty Cycle Correction Factor (if any) from the measured reading. The basic equation with a sample calculation is as follows:

Margin=PL-PK L or AL- AV L; Margin only shown the worst case.

Where

PR = Peak Reading

AR = Average Reading

PL = Peak Level

AL = Average Level

AF = Antenna Factor

PK L = Peak Limit

AV L = AV Limit

For example

Frequency	PR	AR	AF	PL	AL	PK L	AV L	Margin
(MHz)	(dB $\mu$ V/m)	(dB $\mu$ V/m)	(dB)	(dB $\mu$ V/m)	(dB $\mu$ V/m)	(dB $\mu$ V/m)	(dB $\mu$ V/m)	(dB)
2178	40.23	30.31	9.83	50.06	40.14	74.00	54.00	-13.86





### 3.2.6 EUT OPERATING CONDITIONS

The EUT tested system was configured as the statements of 2.4 Unless otherwise a special operating condition is specified in the follows during the testing.

Below 30 MHz

Temperature:	23.1(C)	Relative Humidity:	60%RH
Test Voltage:	AC 120V/60Hz	Polarization:	---
Test Mode:	TX Mode		

Freq. (MHz)	Reading (dBuV/m)	Limit (dBuV/m)	Margin (dB)	State P/F
--	--	--	--	PASS
--	--	--	--	PASS

**NOTE:**

The amplitude of spurious emissions which are attenuated by more than 20dB below the permissible value has no need to be reported.

Distance extrapolation factor =  $40 \log(\text{specific distance}/\text{test distance})$ (dB);

Limit line = specific limits(dBuv) + distance extrapolation factor.

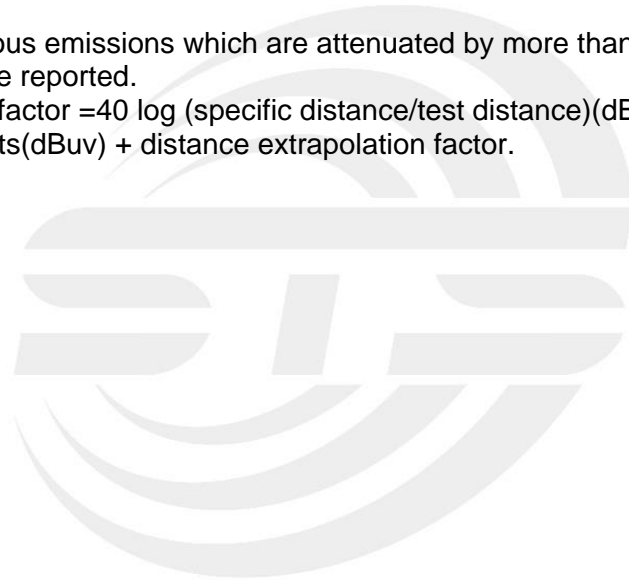



Between 30MHz – 1000 MHz Radiation Spurious

Temperature:	23.1(C)	Relative Humidity:	60%RH
Test Voltage:	AC 120V/60Hz	Phase:	Horizontal
Test Mode:	Mode 1		

No.	Frequency (MHz)	Reading (dBuV)	Correct Factor(dB/m)	Result (dBuV/m)	Limit (dBuV/m)	Margin (dB)	Remark
1	70.7400	59.04	-24.73	34.31	40.00	-5.69	peak
2	224.0000	62.05	-19.38	42.67	46.00	-3.33	peak
3	319.0600	56.71	-14.05	42.66	46.00	-3.34	peak
4	437.4000	50.72	-10.10	40.62	46.00	-5.38	peak
5	650.8000	48.22	-4.90	43.32	46.00	-2.68	peak
6	929.1900	41.85	0.50	42.35	46.00	-3.65	peak

Remark:

1. Margin = Result (Result =Reading + Factor )–Limit

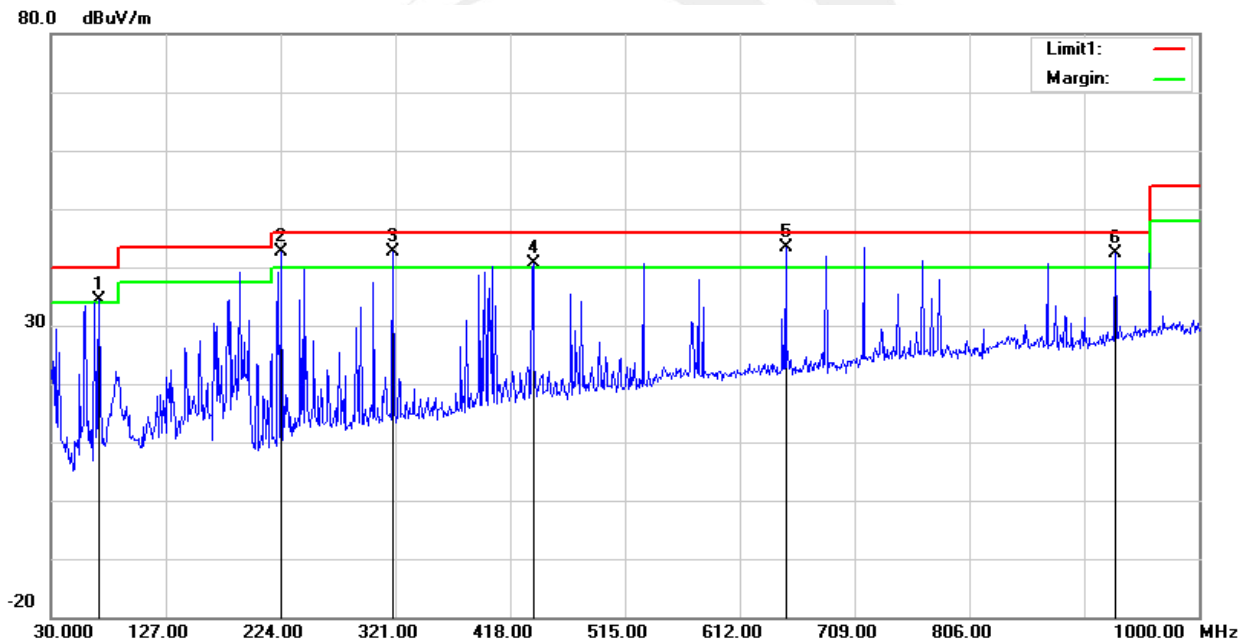



Temperature:	23.1(C)	Relative Humidity:	60%RH
Test Voltage:	AC 120V/60Hz	Phase:	Vertical
Test Mode:	Mode 1		

No.	Frequency (MHz)	Reading (dBuV)	Correct Factor(dB/m)	Result (dBuV/m)	Limit (dBuV/m)	Margin (dB)	Remark
1	81.4100	59.41	-22.82	36.59	40.00	-3.41	peak
2	161.9200	56.49	-19.01	37.48	43.50	-6.02	peak
3	292.8700	56.77	-15.06	41.71	46.00	-4.29	peak
4	341.3700	55.47	-13.36	42.11	46.00	-3.89	peak
5	426.7300	50.20	-10.12	40.08	46.00	-5.92	peak
6	605.2100	46.34	-5.67	40.67	46.00	-5.33	peak

Remark:

1. Margin = Result (Result =Reading + Factor )–Limit

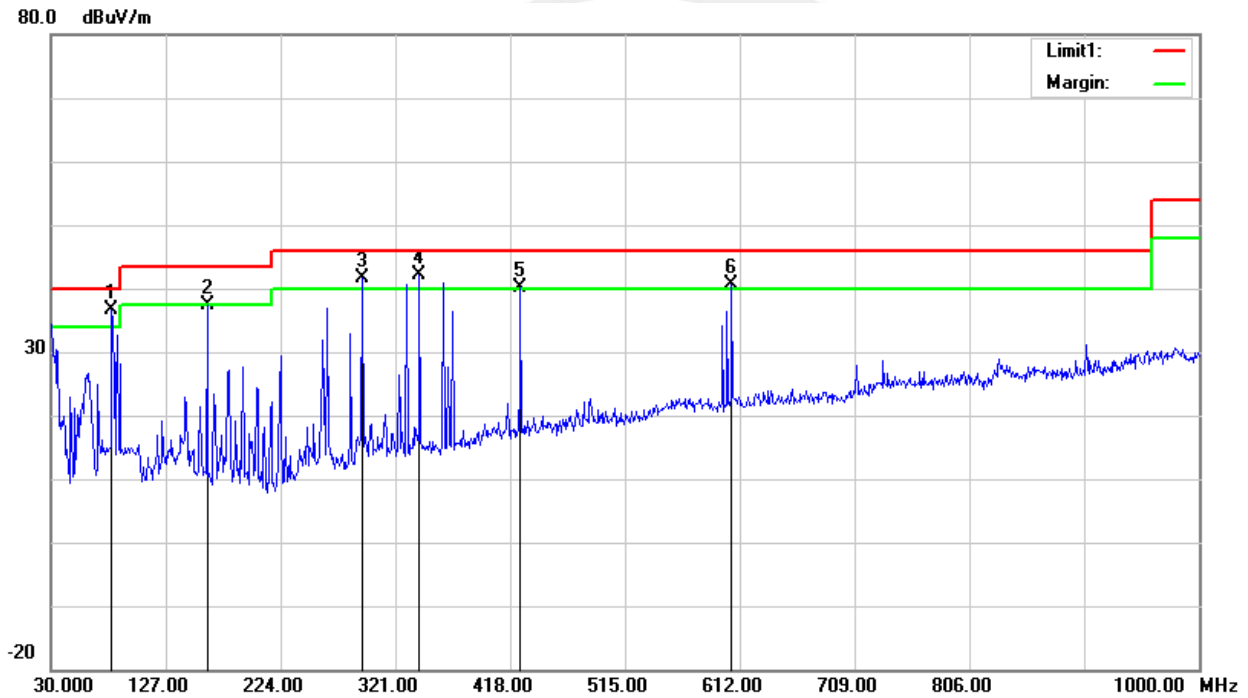



Temperature:	23.1(C)	Relative Humidity:	60%RH
Test Voltage:	AC 120V/60Hz	Phase:	Horizontal
Test Mode:	Mode 2		

No.	Frequency (MHz)	Reading (dBuV)	Correct Factor(dB/m)	Result (dBuV/m)	Limit (dBuV/m)	Margin (dB)	Remark
1	53.2800	58.96	-24.47	34.49	40.00	-5.51	peak
2	161.9200	54.97	-19.01	35.96	43.50	-7.54	peak
3	621.7000	48.18	-5.42	42.76	46.00	-3.24	peak
4	746.8300	45.68	-2.15	43.53	46.00	-2.47	peak
5	782.7200	46.15	-2.14	44.01	46.00	-1.99	peak
6	963.1400	40.57	1.84	42.41	54.00	-11.59	peak

Remark:

1. Margin = Result (Result =Reading + Factor )-Limit

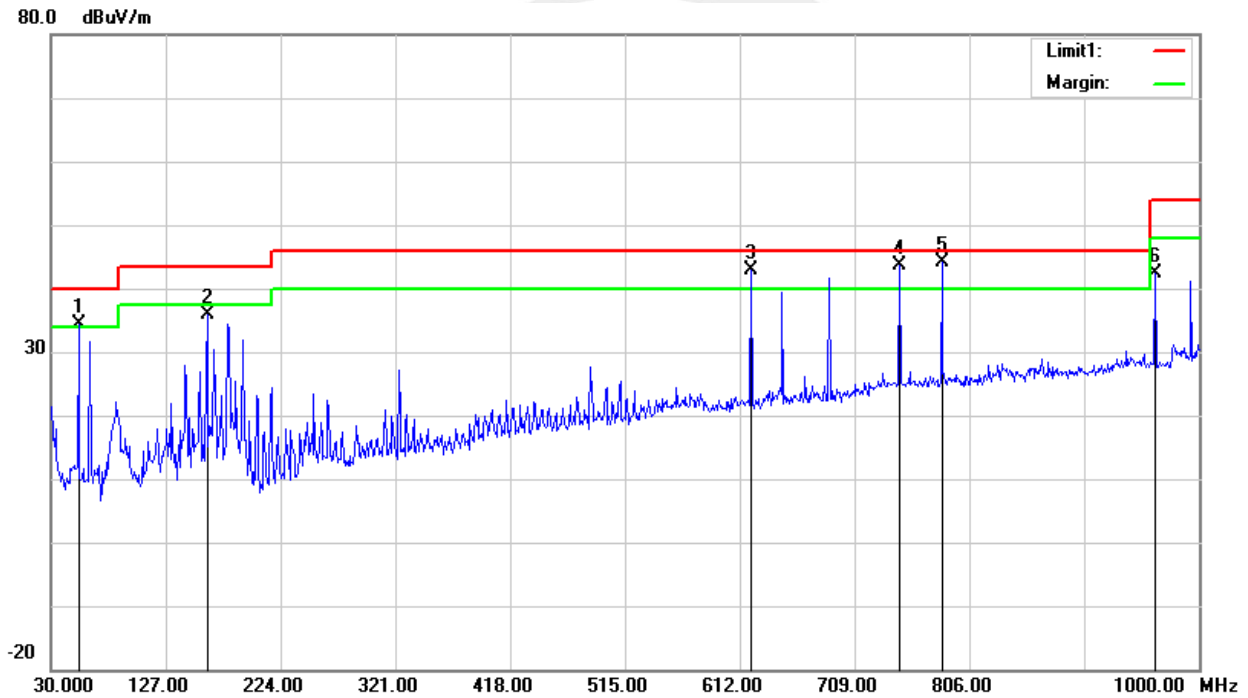





Temperature:	23.1(C)	Relative Humidity:	60%RH
Test Voltage:	AC 120V/60Hz	Phase:	Vertical
Test Mode:	Mode 2		

No.	Frequency (MHz)	Reading (dBuV)	Correct Factor(dB/m)	Result (dBuV/m)	Limit (dBuV/m)	Margin (dB)	Remark
1	30.9700	47.45	-13.35	34.10	40.00	-5.90	peak
2	168.7100	59.95	-19.67	40.28	43.50	-3.22	peak
3	249.2200	55.26	-16.27	38.99	46.00	-7.01	peak
4	499.4800	49.59	-8.02	41.57	46.00	-4.43	peak
5	646.9200	48.72	-4.88	43.84	46.00	-2.16	peak
6	984.4800	28.60	2.40	31.00	54.00	-23.00	peak

Remark:

1. Margin = Result (Result =Reading + Factor )-Limit

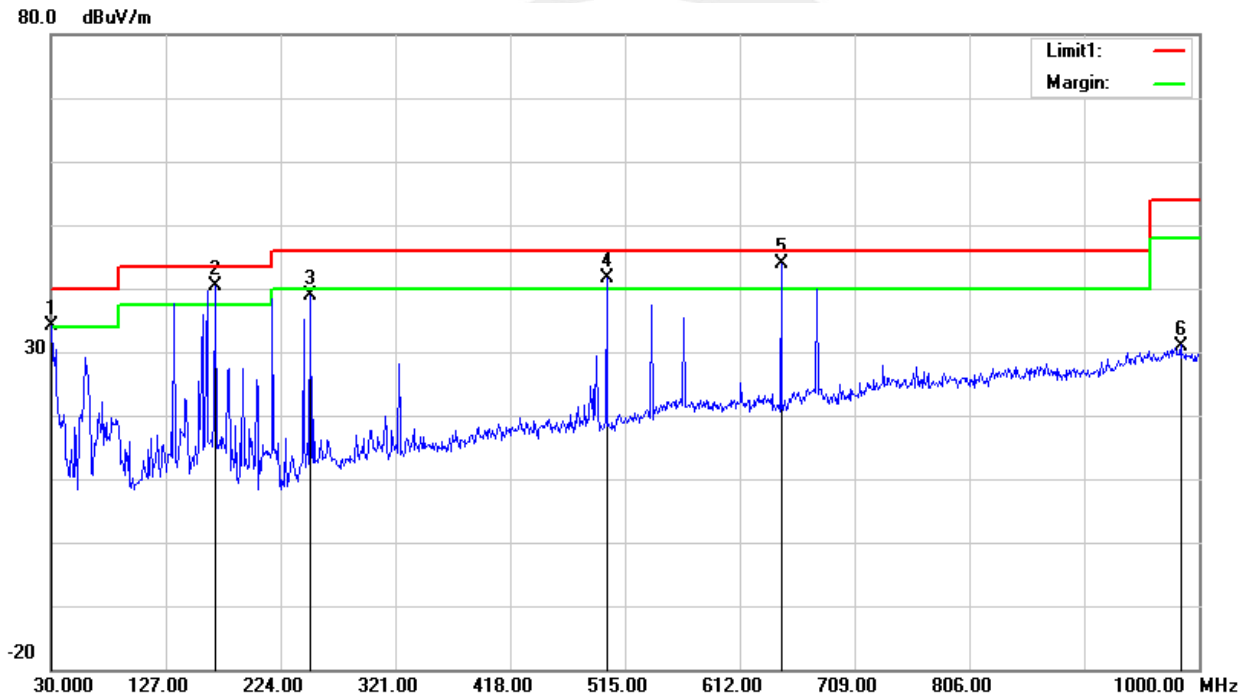



Temperature:	23.1(C)	Relative Humidity:	60%RH
Test Voltage:	AC 120V/60Hz	Phase:	Horizontal
Test Mode:	Mode 3		

No.	Frequency (MHz)	Reading (dBuV)	Correct Factor(dB/m)	Result (dBuV/m)	Limit (dBuV/m)	Margin (dB)	Remark
1	161.9200	60.21	-19.01	41.20	43.50	-2.30	peak
2	323.9100	47.10	-13.88	33.22	46.00	-12.78	peak
3	488.8100	51.52	-8.27	43.25	46.00	-2.75	peak
4	671.1700	46.27	-4.55	41.72	46.00	-4.28	peak
5	749.7400	45.44	-2.16	43.28	46.00	-2.72	peak
6	912.7000	43.45	-0.14	43.31	46.00	-2.69	peak

Remark:

1. Margin = Result (Result =Reading + Factor )-Limit

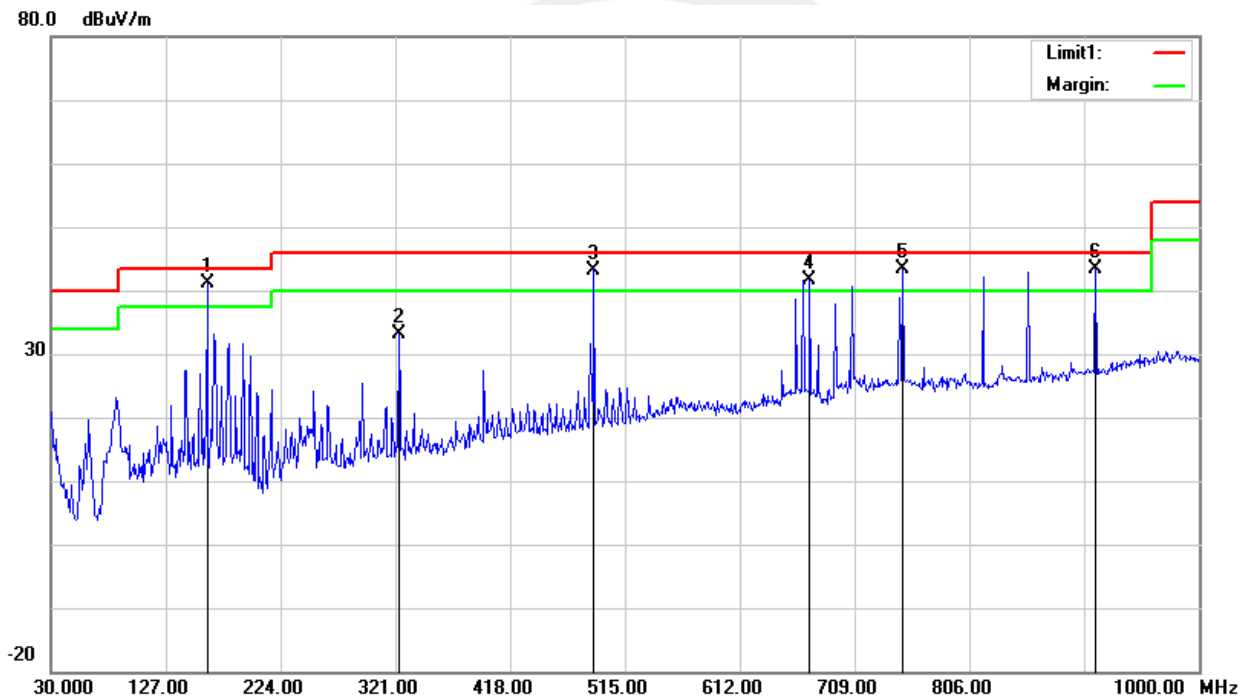



Temperature:	23.1(C)	Relative Humidity:	60%RH
Test Voltage:	AC 120V/60Hz	Phase:	Vertical
Test Mode:	Mode 3		

No.	Frequency (MHz)	Reading (dBuV)	Correct Factor(dB/m)	Result (dBuV/m)	Limit (dBuV/m)	Margin (dB)	Remark
1	62.0100	63.28	-25.76	37.52	40.00	-2.48	peak
2	125.0600	58.20	-18.22	39.98	43.50	-3.52	peak
3	275.4100	56.58	-15.46	41.12	46.00	-4.88	peak
4	508.2100	50.55	-7.95	42.60	46.00	-3.40	peak
5	682.8100	45.88	-4.29	41.59	46.00	-4.41	peak
6	837.0400	43.15	-0.46	42.69	46.00	-3.31	peak

Remark:

1. Margin = Result (Result =Reading + Factor )–Limit

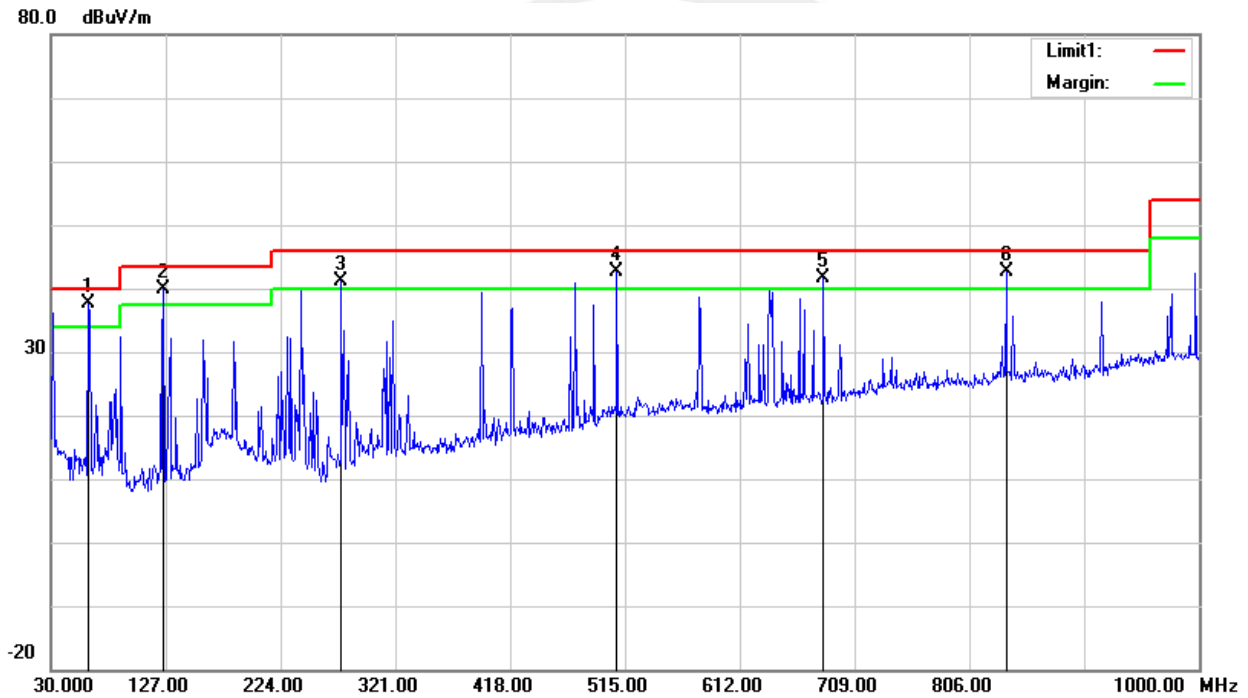



Above 1G Radiation Spurious

**2420MHz  
PK**

Frequency (MHz)	Meter Reading (dBµV/m)	Detector (PK/QP/AV)	Amplifier (dB)	Loss (dB)	Antenna Factor (dB/m)	Orrected Factor (dB)	Corrected Amplitude (dBµV/m)	FCC Part 15.249/15.209/205		RX Antenna
								Limit (dBµV/m)	Margin (dB)	Polar (H/V)
4840.20	77.69	PK	45.10	4.91	25.00	-15.19	62.50	74	-11.50	H
4840.20	76.89	PK	45.10	4.91	25.00	-15.19	61.70	74	-12.30	V
7260.03	68.38	PK	44.10	5.03	25.80	-13.27	55.11	74	-18.89	H
7260.03	66.83	PK	44.10	5.03	25.80	-13.27	53.56	74	-20.44	V
9679.83	50.52	PK	43.80	6.72	33.40	-3.68	46.84	74	-27.16	H
9679.83	50.54	PK	43.80	6.72	33.40	-3.68	46.86	74	-27.14	V

**AV**

Frequency (MHz)	PK Reading (dBµV/m)	Duty cycle factor (dB)	AV Reading (dBµV/m)	Orrected Factor (dB)	Corrected Amplitude (dBµV/m)	FCC Part 15.249/15.209/205		RX Antenna
						Limit (dBµV/m)	Margin (dB)	Polar (H/V)
4840.20	77.69	-24.32	53.37	-15.19	38.18	54.00	-15.82	H
4840.20	76.89	-24.32	52.57	-15.19	37.38	54.00	-16.62	V
7260.03	68.38	-24.32	44.06	-13.27	30.79	54.00	-23.21	H
7260.03	66.83	-24.32	42.51	-13.27	29.24	54.00	-24.76	V
9679.83	50.52	-24.32	26.20	-3.68	22.52	54.00	-31.48	H
9679.83	50.54	-24.32	26.22	-3.68	22.54	54.00	-31.46	V

AV = Peak +20Log10(duty cycle factor) =PK+(-24.32)

**2443MHz  
PK**

Frequency (MHz)	Meter Reading (dBµV/m)	Detector (PK/QP/AV)	Amplifier (dB)	Loss (dB)	Antenna Factor (dB/m)	Orrected Factor (dB)	Corrected Amplitude (dBµV/m)	FCC Part 15.249/15.209/205		RX Antenna
								Limit (dBµV/m)	Margin (dB)	Polar (H/V)
4885.87	71.00	PK	50.33	8.84	31.22	-10.27	60.73	74	-13.27	H
4885.87	70.33	PK	50.33	8.84	31.22	-10.27	60.06	74	-13.94	V
7329.14	68.35	PK	55.48	9.31	34.05	-12.12	56.23	74	-17.77	H
7329.14	66.70	PK	55.48	9.31	34.05	-12.12	54.58	74	-19.42	V
9771.91	71.28	PK	59.13	9.89	36.99	-12.25	59.03	74	-14.97	H
9771.91	70.25	PK	59.13	9.89	36.99	-12.25	58.00	74	-16.00	V

**AV**

Frequency (MHz)	PK Reading (dBµV/m)	Duty cycle factor (dB)	AV Reading (dBµV/m)	Orrected Factor (dB)	Corrected Amplitude (dBµV/m)	FCC Part 15.249/15.209/205		RX Antenna
						Limit (dBµV/m)	Margin (dB)	Polar (H/V)
4885.87	71.00	-24.32	46.68	-10.27	36.41	54.00	-17.59	H
4885.87	70.33	-24.32	46.01	-10.27	35.74	54.00	-18.26	V
7329.14	68.35	-24.32	44.03	-12.12	31.91	54.00	-22.09	H
7329.14	66.70	-24.32	42.38	-12.12	30.26	54.00	-23.74	V
9771.91	71.28	-24.32	46.96	-12.25	34.71	54.00	-19.29	H
9771.91	70.25	-24.32	45.93	-12.25	33.68	54.00	-20.32	V

AV = Peak +20Log10(duty cycle factor) =PK+(-24.32)



**2465MHz  
PK**

Frequency (MHz)	Meter Reading (dBμV/m)	Detector (PK/QP/AV)	Amplifier (dB)	Loss (dB)	Antenna Factor (dB/m)	Orrected Factor (dB)	Corrected Amplitude (dBμV/m)	FCC Part 15.249/15.209/205		RX Antenna
								Limit (dBμV/m)	Margin (dB)	Polar (H/V)
4929.99	71.35	PK	50.33	8.84	31.22	-10.27	61.08	74	-12.92	H
4929.99	70.31	PK	50.33	8.84	31.22	-10.27	60.04	74	-13.96	V
7394.82	67.98	PK	55.48	9.31	34.05	-12.12	55.86	74	-18.14	H
7394.82	66.40	PK	55.48	9.31	34.05	-12.12	54.28	74	-19.72	V
9860.03	71.41	PK	59.13	9.89	36.99	-12.25	59.16	74	-14.84	H
9860.03	70.10	PK	59.13	9.89	36.99	-12.25	57.85	74	-16.15	V

**AV**

Frequency (MHz)	PK Reading (dBμV/m)	Duty cycle factor (dB)	AV Reading (dBμV/m)	Orrected Factor (dB)	Corrected Amplitude (dBμV/m)	FCC Part 15.249/15.209/205		RX Antenna
						Limit (dBμV/m)	Margin (dB)	Polar (H/V)
4929.99	71.35	-24.32	47.03	-10.27	36.76	54.00	-17.24	H
4929.99	70.31	-24.32	45.99	-10.27	35.72	54.00	-18.28	V
7394.82	67.98	-24.32	43.66	-12.12	31.54	54.00	-22.46	H
7394.82	66.40	-24.32	42.08	-12.12	29.96	54.00	-24.04	V
9860.03	71.41	-24.32	47.09	-12.25	34.84	54.00	-19.16	H
9860.03	70.10	-24.32	45.78	-12.25	33.53	54.00	-20.47	V

AV = Peak +20Log10(duty cycle factor) =PK+(-24.32)

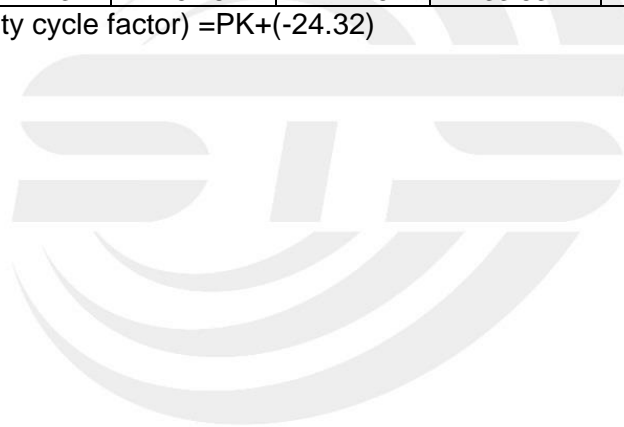



Duty cycle

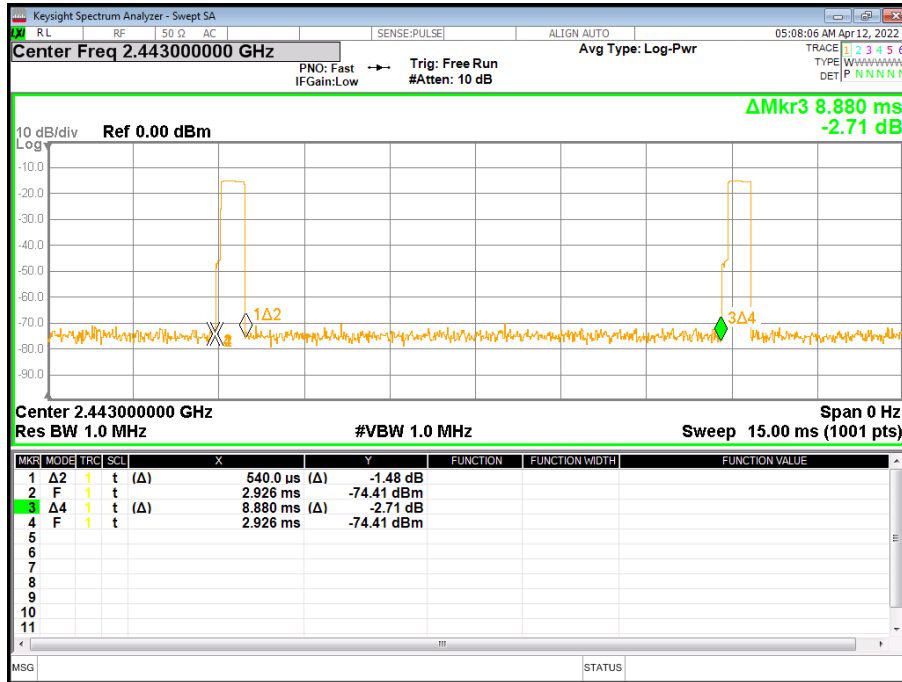

Ton	Tp	Duty cycle(%)	Duty factor(dB)
0.540	8.880	6.08%	-24.32

Note: Duty Factor=20\*LOG10(1/(Ton/Tp))



(Radiation Band edge)

**Low channel**  
Horizontal

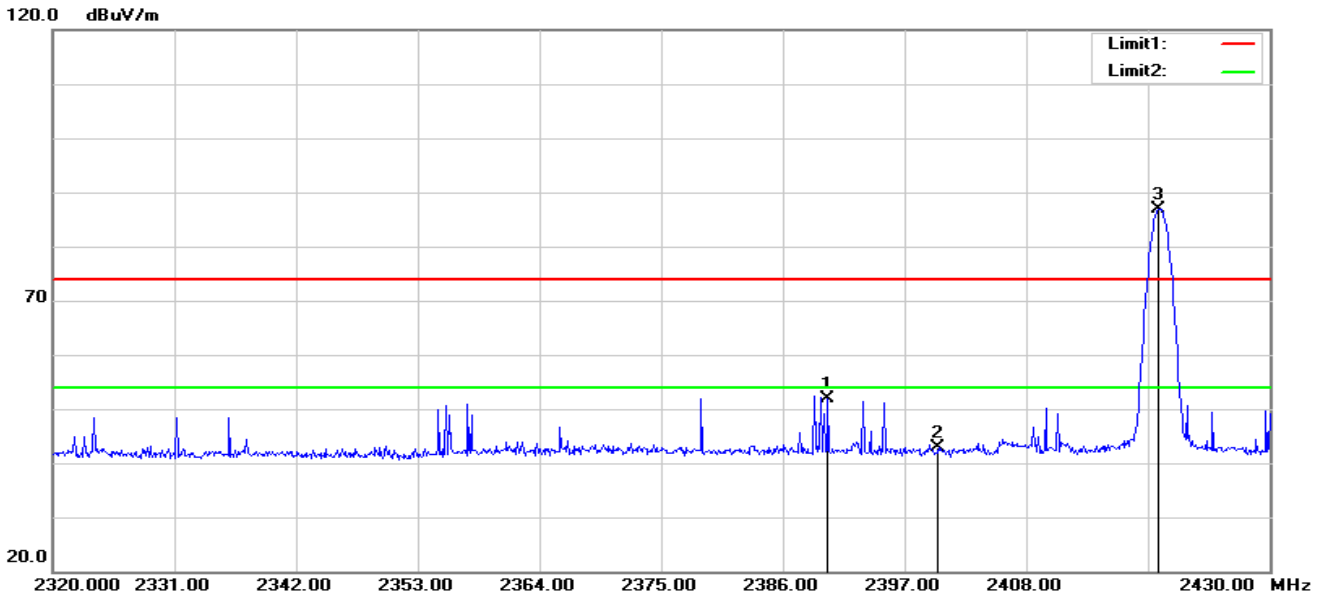

No.	Frequency (MHz)	Reading (dBuV)	Correct Factor(dB/m)	Result (dBuV/m)	Limit (dBuV/m)	Margin (dB)	Remark
1	2390.000	47.48	4.34	51.82	74.00	-22.18	peak
2	2400.000	38.46	4.49	42.95	74.00	-31.05	peak

**Fundamental Frequency**

No.	Frequency (MHz)	Reading (dBuV)	Correct Factor(dB/m)	Duty cycle Factor(dB/m)	Result (dBuV/m)	Limit (dBuV/m)	Margin (dB)	Remark
3	2420.000	82.41	4.50	-	86.91	114.00	-27.09	peak



Vertical

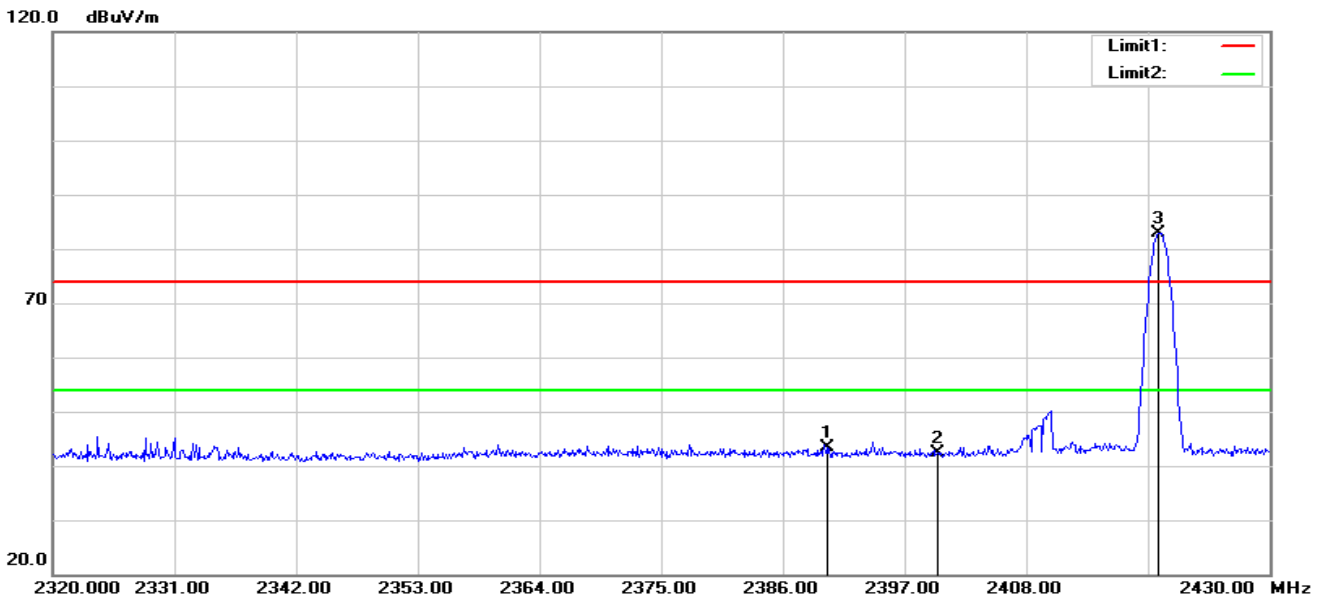

No.	Frequency (MHz)	Reading (dBuV)	Correct Factor(dB/m)	Result (dBuV/m)	Limit (dBuV/m)	Margin (dB)	Remark
1	2390.000	39.14	4.34	43.48	74.00	-30.52	peak
2	2400.000	37.84	4.49	42.33	74.00	-31.67	peak

Fundamental Frequency

No.	Frequency (MHz)	Reading (dBuV)	Correct Factor(dB/m)	Duty cycle Factor(dB/m)	Result (dBuV/m)	Limit (dBuV/m)	Margin (dB)	Remark
3	2420.000	78.44	4.50	-	82.94	114.00	-31.06	peak





Mid channel  
Horizontal

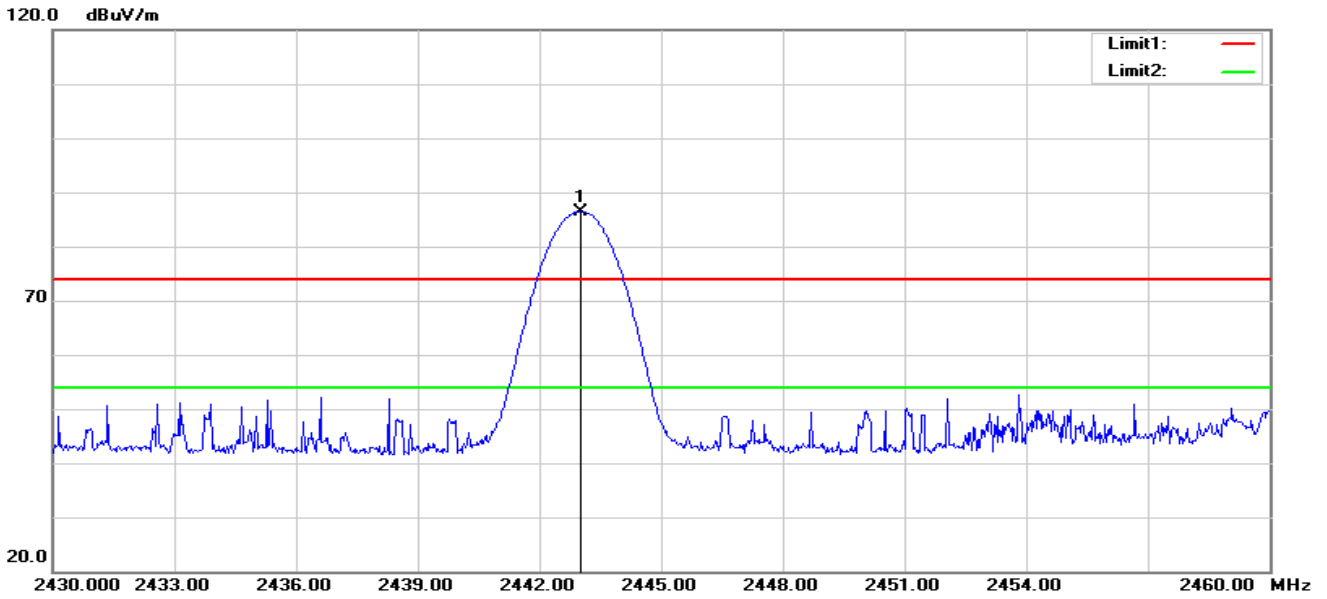

No.	Frequency (MHz)	Reading (dBuV)	Correct Factor(dB/m)	Duty cycle Factor(dB/m)	Result (dBuV/m)	Limit (dBuV/m)	Margin (dB)	Remark
1	2443.000	81.94	4.52	-	86.46	114.00	-27.54	peak

Vertical

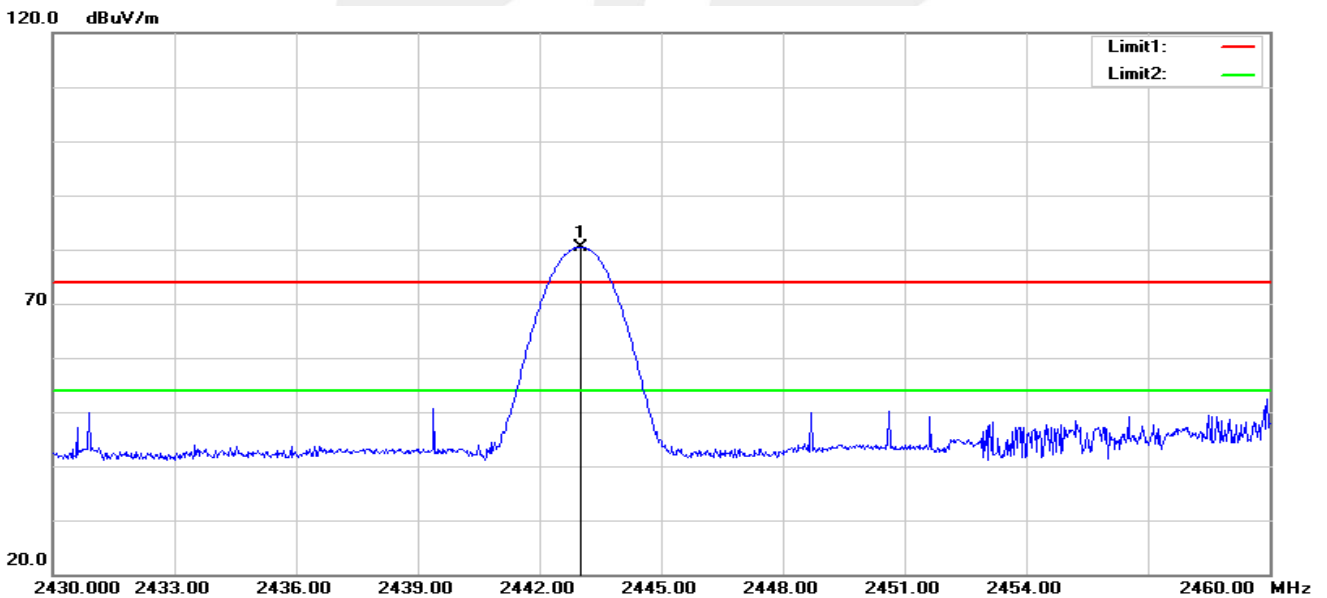

No.	Frequency (MHz)	Reading (dBuV)	Correct Factor(dB/m)	Duty cycle Factor(dB/m)	Result (dBuV/m)	Limit (dBuV/m)	Margin (dB)	Remark
1	2443.000	75.88	4.52	-	80.40	114.00	-33.60	peak



### High channel Horizontal

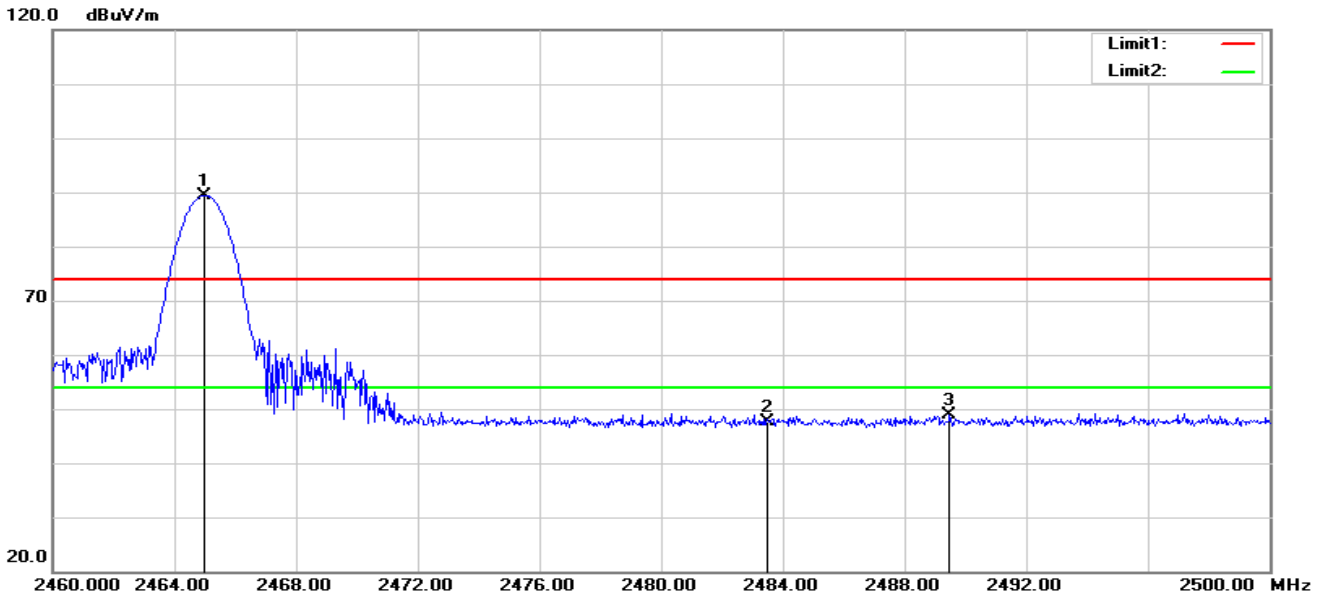

No.	Frequency (MHz)	Reading (dBuV)	Correct Factor(dB/m)	Result (dBuV/m)	Limit (dBuV/m)	Margin (dB)	Remark
2	2483.500	42.93	4.60	47.53	74.00	-26.47	peak
3	2489.480	44.31	4.62	48.93	74.00	-25.07	peak

### Fundamental Frequency

No.	Frequency (MHz)	Reading (dBuV)	Correct Factor(dB/m)	Duty cycle Factor(dB/m)	Result (dBuV/m)	Limit (dBuV/m)	Margin (dB)	Remark
1	2465.000	84.87	4.56	-	89.43	114.00	-24.57	peak



Vertical

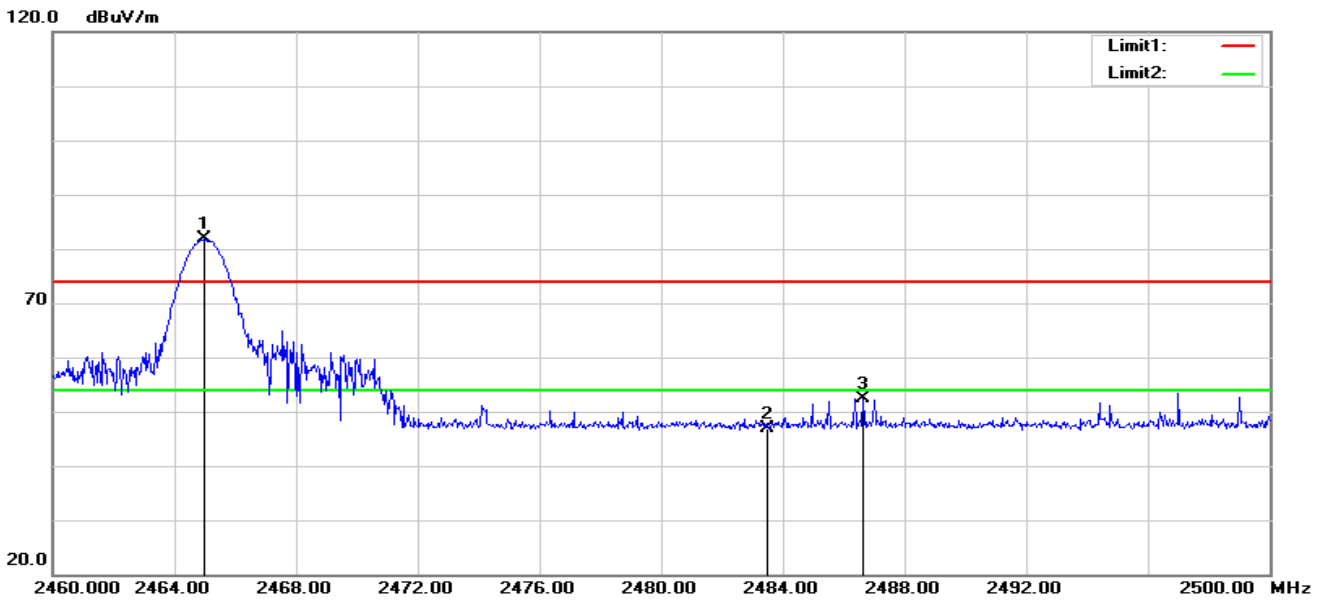

No.	Frequency (MHz)	Reading (dBuV)	Correct Factor(dB/m)	Result (dBuV/m)	Limit (dBuV/m)	Margin (dB)	Remark
2	2483.500	42.30	4.60	46.90	74.00	-27.10	peak
3	2486.640	47.84	4.61	52.45	74.00	-21.55	peak

Fundamental Frequency

No.	Frequency (MHz)	Reading (dBuV)	Correct Factor(dB/m)	Duty cycle Factor(dB/m)	Result (dBuV/m)	Limit (dBuV/m)	Margin (dB)	Remark
1	2465.000	77.23	4.56	-	81.79	114.00	-32.21	peak

#### 4. BANDWIDTH TEST

##### 4.1 TEST PROCEDURE

- a. The EUT was directly connected to the spectrum analyzer and antenna output port as show in the block diagram below.
- b. Spectrum Setting : RBW= 1% to 5% OBW, VBW $\geq$ RBW, Sweep time = Auto.

##### 4.2 TEST SETUP



##### 4.3 EUT OPERATION CONDITIONS

TX mode.





4.4 TEST RESULTS

Temperature:	25 °C	Relative Humidity:	50%
Test Voltage:	AC 120V/60Hz		

Test Channel	Frequency(MHz)	20 dB Bandwidth(MHz)	99% Bandwidth(MHz)
CH01	2402	4.045	4.0213
CH02	2443	2.683	3.8552
CH03	2465	2.448	2.2907

Low Channel

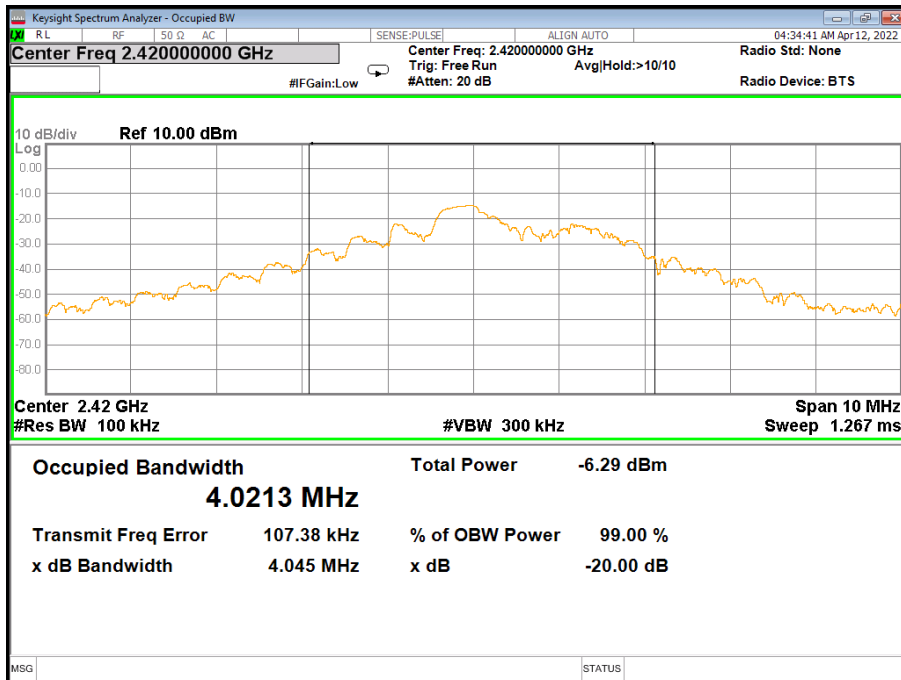



### Mid Channel

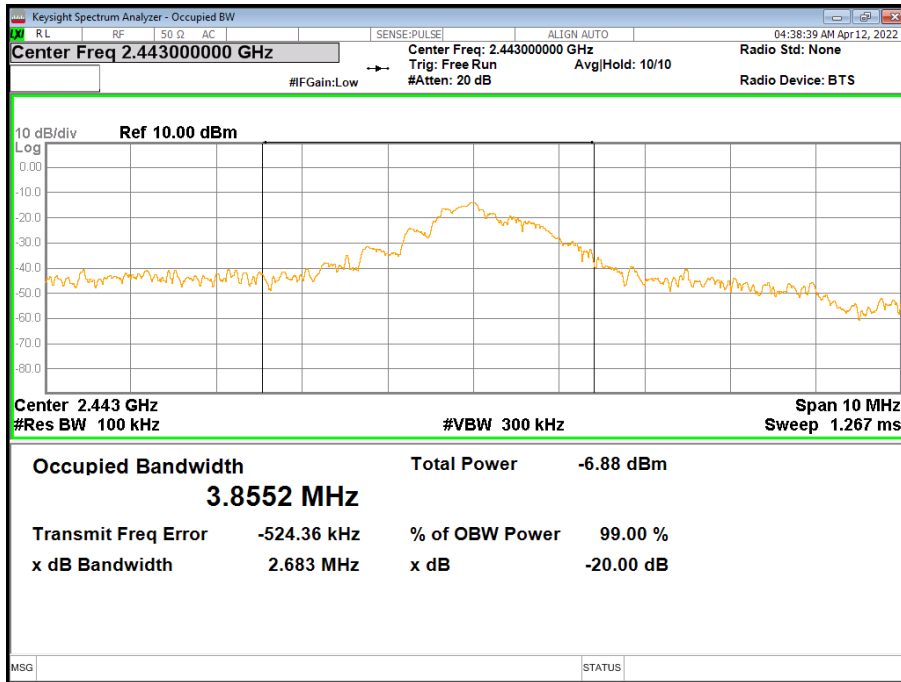

### High Channel

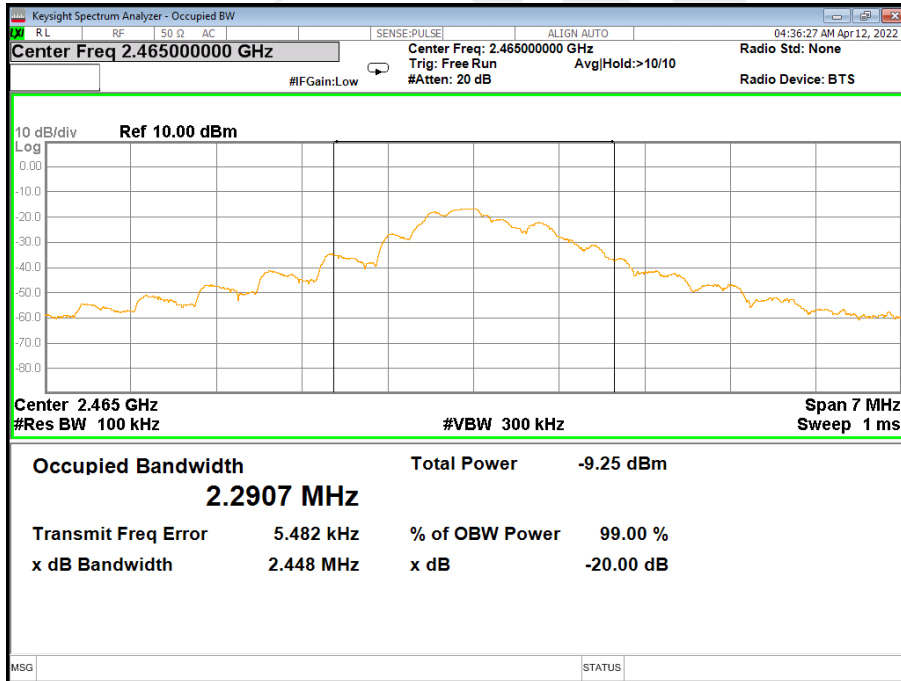



## 5. ANTENNA REQUIREMENT

### 5.1 STANDARD REQUIREMENT

According to the FCC Part 15 Paragraph 15.203, an intentional radiator shall be designed to ensure that no antenna other than that furnished by the responsible party shall be used with the device.

### 5.2 EUT ANTENNA

The EUT antenna is Monopole Antenna. It conforms to the standard requirements.





## APPENDIX- PHOTOS OF TEST SETUP

Note: See test photos in setup photo document for the actual connections between Product and support equipment.

※※※※END OF THE REPORT※※※※

