



FCC 47 CFR PART 15 SUBPART C

TEST REPORT

For

Lightshow Control Box

Model: 82208

Brand: Gemmy

Test Report Number:

C160607Z01-RP1

Issued for

GEMMY INDUSTRIES (HK) LIMITED BVI

**No.301 on 3rd Floor, East Ocean Centre, No.98 Granville Road, Kowloon,
Hong Kong**

Issued by:

COMPLIANCE CERTIFICATION SERVICES (SHENZHEN) INC.

**No.10-1, Mingkeda Logistics Park, No.18, Huanguan South Rd.,
Guan Lan Town, Baoan District, Shenzhen China**

TEL: 86-755-28055000

FAX: 86-755-28055221

E-Mail: service@ccssz.com

Issued Date: June 24, 2016



TESTING CERT #2861.01

Note: This report shall not be reproduced except in full, without the written approval of Compliance Certification Services (Shenzhen) Inc. This document may be altered or revised by Compliance Certification Services (Shenzhen) Inc. personnel only, and shall be noted in the revision section of the document. The client should not use it to claim product endorsement by TAF, A2LA, NVLAP, NIST, CNAS or any government agencies. The test result of this report relate only to the tested sample identified in this report.



Revision History

Rev.	Issue Date	Revisions	Effect Page	Revised By
00	June 24, 2016	Initial Issue	ALL	Nancy Fu



TABLE OF CONTENTS

1. TEST RESULT CERTIFICATION 4

2. EUT DESCRIPTION 5

3. TEST METHODOLOGY..... 6

 3.1 DESCRIPTION OF TEST MODES..... 6

4. FACILITIES AND ACCREDITATIONS 7

 4.1 FACILITIES 7

 4.2 ACCREDITATIONS 7

 4.3 MEASUREMENT UNCERTAINTY 7

5. SETUP OF EQUIPMENT UNDER TEST..... 8

 5.1 SETUP CONFIGURATION OF EUT 8

 5.2 SUPPORT EQUIPMENT 8

6. FCC PART 15.247 REQUIREMENTS..... 9

 6.1 20DB BANDWIDTH 9

 6.2 ANTENNA GAIN 14

 6.3 PEAK POWER..... 15

 6.4 PEAK POWER SPECTRAL DENSITY 17

 6.5 BAND EDGES MEASUREMENT 18

 6.6 FREQUENCY SEPARATION 28

 6.7 NUMBER OF HOPPING FREQUENCY 31

 6.8 TIME OF OCCUPANCY (DWELL TIME) 33

 6.9 SPURIOUS EMISSIONS 40

 6.10 POWERLINE CONDUCTED EMISSIONS 59



1. TEST RESULT CERTIFICATION

Product	Lightshow Control Box
Model	82208
Brand	Gemmy
Tested	June 7~ June 24, 2016
Applicant	GEMMY INDUSTRIES (HK) LIMITED BVI No.301 on 3rd Floor, East Ocean Centre, No.98 Granville Road, Kowloon, Hong Kong
Manufacturer	ZAIXING ELECTRONIC (SHENZHEN) CO., LTD. 3#, 1st Road Yang Yong, Shapu Community, Songgang, Baoan District, Shenzhen City, Guangdong Province, China

APPLICABLE STANDARDS	
STANDARD	TEST RESULT
FCC 47 CFR Part 15 Subpart C	No non-compliance noted

We hereby certify that:

The above equipment was tested by Compliance Certification Services (Shenzhen) Inc. The test data, data evaluation, test procedures, and equipment configurations shown in this report were made in accordance with the procedures given in ANSI C63.10:2013 and the energy emitted by the sample EUT tested as described in this report is in compliance with conducted and radiated emission limits of FCC Rules Part 15.207, 15.209 and 15.247.

The test results of this report relate only to the tested sample EUT identified in this report.

Approved by:

Sunday Hu
Supervisor of EMC Dept.
Compliance Certification Services (Shenzhen) Inc.

Reviewed by:

Ruby Zhang
Supervisor of Report Dept.
Compliance Certification Services (Shenzhen) Inc.



2. EUT DESCRIPTION

Product	Lightshow Control Box
Model Number	82208
Brand	Gemmy
Model Discrepancy	N/A
Identify Number	C160607Z01-RP1
Received Date	June 7, 2016
Power Supply	AC120V/60Hz
Frequency Range	2402 ~ 2480 MHz
Transmit Power	GFSK : 6.44dBm $\pi/4$ -DQPSK: 6.59dBm 8DPSK : 6.34dBm
Modulation Technique	FHSS (GFSK for 1Mbps, $\pi/4$ -DQPSK for 2Mbps, 8DPSK for 3Mbps)
Number of Channels	79 Channels
Antenna Specification	PCB Antenna with 0dBi gain (Max)
Temperature Range	-20°C ~ +50°C
Hardware Version	82208-Canada(V1)
Software Version	82208-Canada(V1)

Note: This submittal(s) (test report) is intended for FCC ID: GPO82208 filing to comply with Section 15.207, 15.209 and 15.247 of the FCC Part 15, Subpart C Rules.



3. TEST METHODOLOGY

3.1 DESCRIPTION OF TEST MODES

The EUT has been tested under operating condition.
Test program used to control the EUT for staying in continuous transmitting and receiving mode is programmed.

Test Item	Test mode	Worse mode
Conducted Emission	Mode 1: Charge +BT Play	<input checked="" type="checkbox"/>
Radiated Emission	Mode 1: TX	<input checked="" type="checkbox"/>

Channel Low (2402MHz), Mid (2441MHz) and High (2480MHz) were chosen for pre-testing for GFSK, $\pi/4$ -DQPSK and 8DPSK, GFSK and 8DPSK were the worse case and print in the report.



4. FACILITIES AND ACCREDITATIONS

4.1 FACILITIES

All measurement facilities used to collect the measurement data are located at

☒ **No.10-1, Mingkeda Logistics Park, No.18, Huanguan South Rd.,
Guan Lan Town, Baoan District, Shenzhen, China**

The sites are constructed in conformance with the requirements of ANSI C63.10:2013, ANSI C63.7 and CISPR Publication 22. All receiving equipment conforms to CISPR Publication 16-1, "Radio Interference Measuring Apparatus and Measurement Methods."

4.2 ACCREDITATIONS

Our laboratories are accredited and approved by the following accreditation body according to ISO/IEC 17025.

USA	A2LA
China	CNAS

The measuring facility of laboratories has been authorized or registered by the following approval agencies.

USA	FCC
Japan	VCCI(C-4815, R-4320, T-2317, G-10624)
Canada	INDUSTRY CANADA

Copies of granted accreditation certificates are available for downloading from our web site, <http://www.ccssz.com>

4.3 MEASUREMENT UNCERTAINTY

Where relevant, the following measurement uncertainty levels have been estimated for tests performed on the EUT as specified in CISPR 16-4-2:

Parameter	Uncertainty
Radiated Emission, 30 to 200 MHz Test Site : 966(2)	+/-3.6880dB
Radiated Emission, 200 to 1000 MHz Test Site : 966(2)	+/-3.6695dB
Radiated Emission, 1 to 8 GHz	+/-5.1782dB
Radiated Emission, 8 to 18 GHz	+/-5.2173dB
Conducted Emissions	+/-3.6836dB
Band Width	178kHz
Peak Output Power MU	+/-1.906dB
Band Edge MU	+/-0.182dB
Channel Separation MU	416.178Hz
Duty Cycle MU	0.054ms
Frequency Stability MU	226Hz

This uncertainty represents an expanded uncertainty expressed at approximately the 95% confidence level using a coverage factor of k=2.

The measured result is above (below) the specification limit by a margin less than the measurement uncertainty; it is therefore not possible to state compliance based on the 95% level of confidence. However, the result indicates that compliance (non-compliance) is more probable than non-compliance) with the specification limit.



5. SETUP OF EQUIPMENT UNDER TEST

5.1 SETUP CONFIGURATION OF EUT

See test photographs attached in Appendix 1 for the actual connections between EUT and support equipment.

5.2 SUPPORT EQUIPMENT

No.	Equipment	Model No.	Serial No.	FCC ID	Brand	Data Cable	Power Cord
1	Notebook	B475	WE04591721	DoC	LENOVO	N/A	Unshielded 1.45m (AC Cable) Unshielded 1.75m (DC Cable)

Notes: Grounding was established in accordance with the manufacturer's requirements and conditions for the intended use.



6. FCC PART 15.247 REQUIREMENTS

6.1 20DB BANDWIDTH

None; for reporting purpose only.

MEASUREMENT EQUIPMENT USED

Name of Equipment	Manufacturer	Model	Serial Number	Last Calibration	Due Calibration
Spectrum Analyzer	Agilent	E4446A	US44300399	02/21/2016	02/20/2017

Remark: Each piece of equipment is scheduled for calibration once a year.

TEST CONFIGURATION

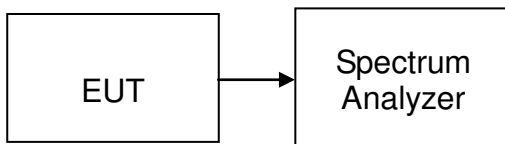

TEST PROCEDURE

1. Place the EUT on the table and set it in the transmitting mode.
2. Remove the antenna from the EUT, then connect a low loss RF cable from antenna port to the spectrum analyzer.
3. Set the spectrum analyzer as RBW=30 kHz, VBW=100 kHz, Span=3MHz, Sweep = auto.
4. Mark the peak frequency and 20dB (upper and lower) frequency.
5. Repeat until all the test channels are investigated.

TEST RESULTS

No non-compliance noted



Test plot

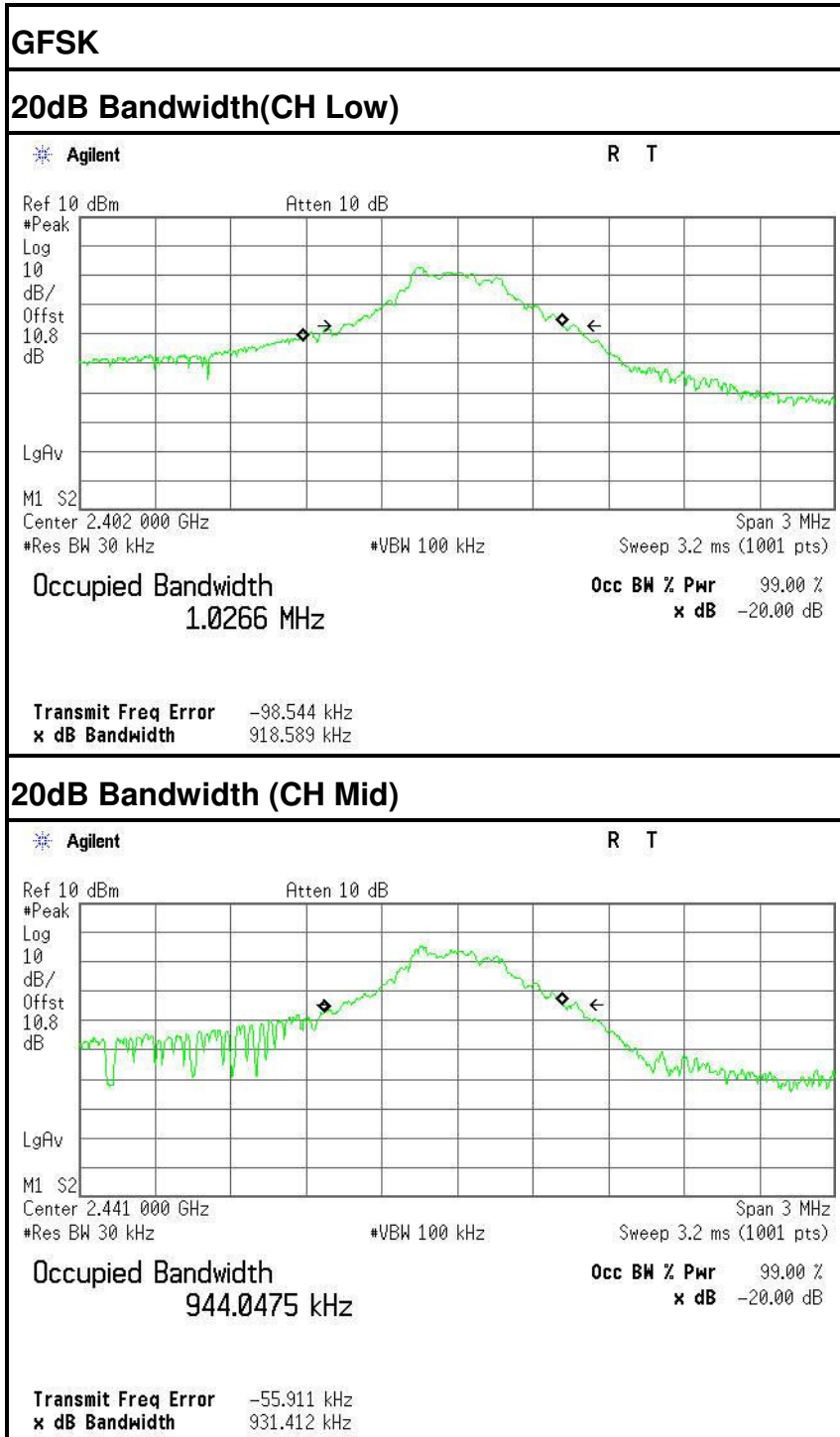



20dB Bandwidth (CH High)

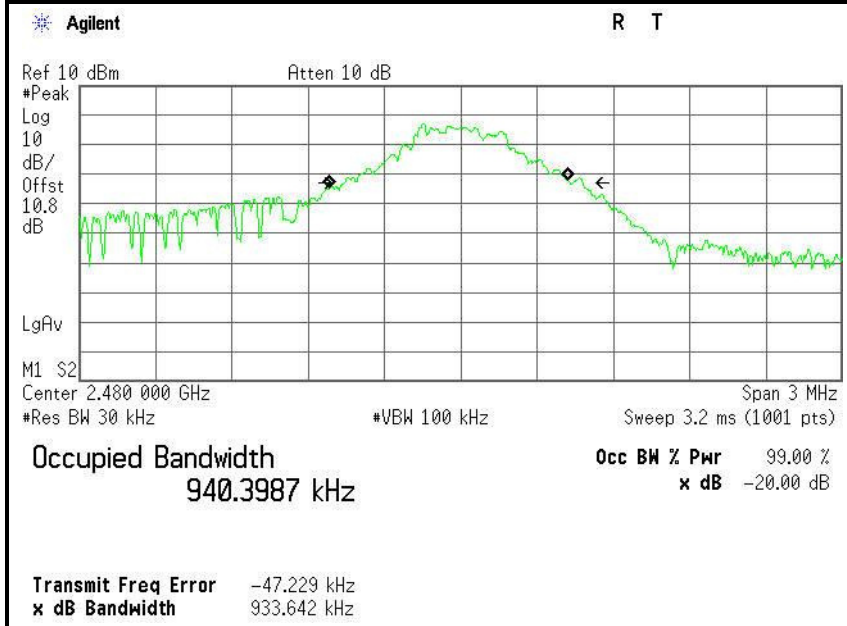



Test plot

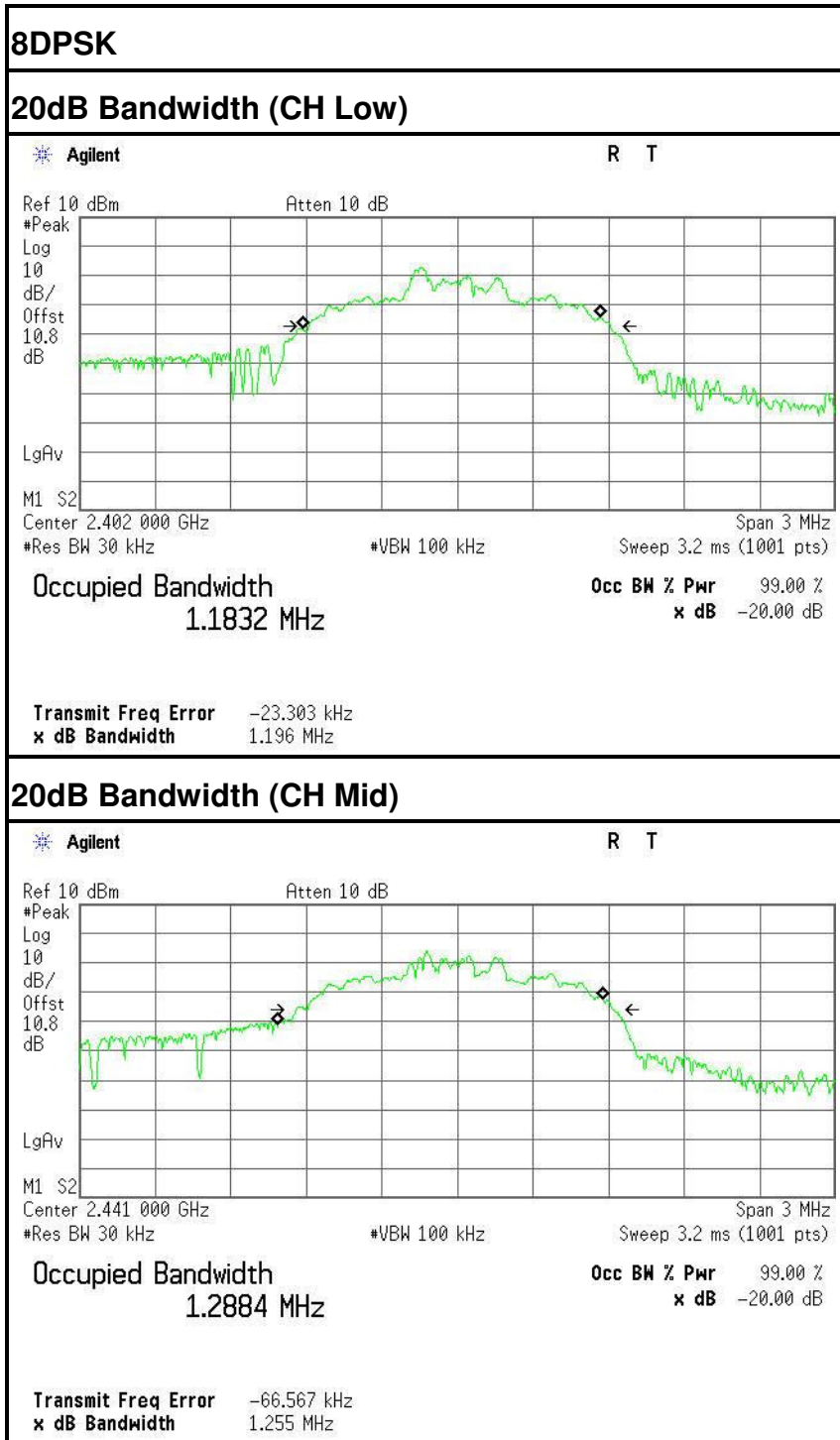

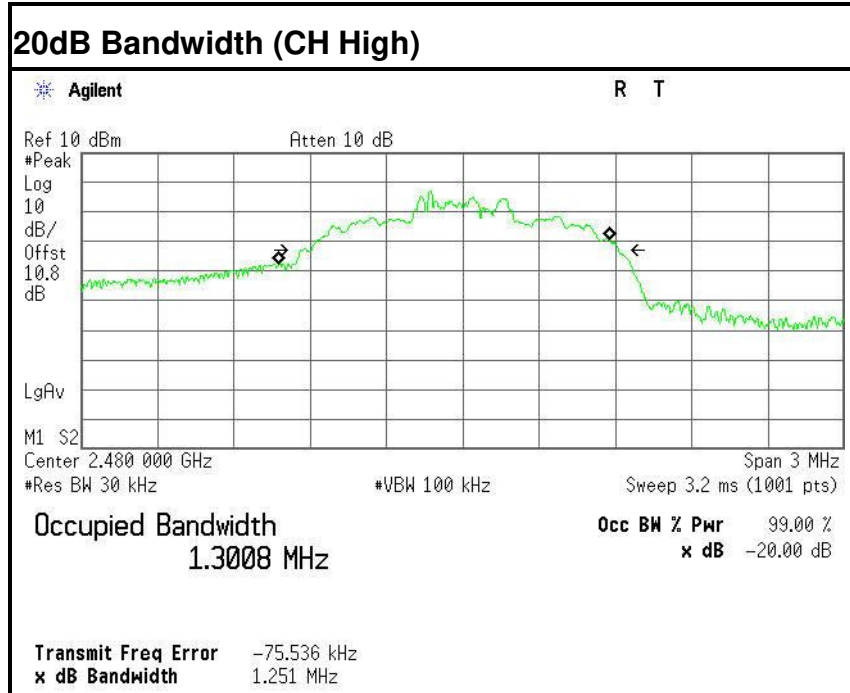



6.2 ANTENNA GAIN

MEASUREMENT

The antenna gain of the complete system is calculated by the difference of radiated power in EIRP and the conducted power of the module. For normal BT devices, the GFSK mode is used.

MEASUREMENT PARAMETERS

Measurement parameter	
Detector	Peak
Sweep time	Auto
Resolution bandwidth	3 MHz
Video bandwidth	3 MHz
Trace-Mode	Max hold

LIMITS

FCC	IC
Antenna Gain	
6 dBi	

TEST RESULTS

GFSK

T _{nom}	V _{nom}	Lowest channel 2402MHz	Middle channel 2441MHz	Highest channel 2480MHz
Conducted power [dBm] Measured with GFSK modulation		2.80	4.62	6.44
Radiated power [dBm] Measured with GFSK modulation		2.23	4.38	-0.52
Gain [dBi] Calculated		-0.57	-0.24	-6.96
Measurement uncertainty		± 1.5 dB (cond.) / ± 3 dB (rad.)		

8DPSK

T _{nom}	V _{nom}	Lowest channel 2402MHz	Middle channel 2441MHz	Highest channel 2480MHz
Conducted power [dBm] Measured with 8DPSK modulation		2.36	4.64	6.34
Radiated power [dBm] Measured with 8DPSK modulation		0.60	0.24	-0.22
Gain [dBi] Calculated		-1.76	-4.40	-6.56
Measurement uncertainty		± 1.5 dB (cond.) / ± 3 dB (rad.)		



6.3 PEAK POWER

LIMIT

The maximum peak output power of the intentional radiator shall not exceed the following:

1. For frequency hopping systems operating in the 2400-2483.5 MHz band employing at least 75 non-overlapping hopping channels: 1 watt. For all other frequency hopping systems in the 2400-2483.5 MHz band: 0.125 watts.
2. Except as shown in paragraphs (b)(3) (i), (ii) and (iii) of this section, if transmitting antennas of directional gain greater than 6dBi are used the peak output power from the intentional radiator shall be reduced below the stated values in paragraphs (b)(1) or (b)(2) of this section, as appropriate, by the amount in dB that the directional gain of the antenna exceeds 6dBi.
3. The conducted output power limit specified in paragraph (b) of this section is based on the use of antennas with directional gains that do not exceed 6 dBi. Except as shown in paragraph (c) of this section, if transmitting antennas of directional gain greater than 6 dBi are used, the conducted output power from the intentional radiator shall be reduced below the stated values in paragraphs (b)(1), (b)(2), and (b)(3) of this section, as appropriate, by the amount in dB that the directional gain of the antenna exceeds 6 dBi.

MEASUREMENT EQUIPMENT USED

Name of Equipment	Manufacturer	Model	Serial Number	Last Calibration	Due Calibration
Power Meter	Anritsu	ML2495A	1204003	02/21/2016	02/20/2017
Power Sensor	Anritsu	MA2411B	1126150	02/21/2016	02/20/2017

Remark: Each piece of equipment is scheduled for calibration once a year.

Test Configuration

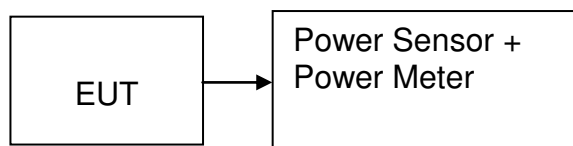

TEST PROCEDURE

The transmitter output is connected to the RF Power Meter. The RF Power Meter is set to the peak power detection.



TEST RESULTS

No non-compliance noted

Test Data

GFSK

Channel	Frequency (MHz)	Reading Power (dBm)	Cable loss (dB)	Output Power (dBm)	Output Power (W)	Limit (W)	Peak /AVG	Result
Low	2402	-0.70	3.50	2.80	0.00191	1	peak	PASS
Mid	2441	1.12	3.50	4.62	0.00290			PASS
High	2480	2.94	3.50	6.44	0.00441			PASS
Low	2402	-10.27	3.50	-6.77	0.00021	1	AVG	PASS
Mid	2441	-7.94	3.50	-4.44	0.00036			PASS
High	2480	-5.48	3.50	-1.98	0.00063			PASS

$\pi/4$ -DQPSK

Channel	Frequency (MHz)	Reading Power (dBm)	Cable loss (dB)	Output Power (dBm)	Output Power (W)	Limit (W)	Peak /AVG	Result
Low	2402	-1.14	3.50	2.36	0.00172	1	peak	PASS
Mid	2441	0.96	3.50	4.46	0.00279			PASS
High	2480	3.09	3.50	6.59	0.00456			PASS
Low	2402	-11.32	3.50	-7.82	0.00017	1	AVG	PASS
Mid	2441	-9.04	3.50	-5.54	0.00028			PASS
High	2480	-7.28	3.50	-3.78	0.00042			PASS

8DPSK

Channel	Frequency (MHz)	Reading Power (dBm)	Cable loss (dB)	Output Power (dBm)	Output Power (W)	Limit (W)	Peak /AVG	Result
Low	2402	-1.14	3.50	2.36	0.00172	1	peak	PASS
Mid	2441	1.14	3.50	4.64	0.00291			PASS
High	2480	2.84	3.50	6.34	0.00431			PASS
Low	2402	-11.33	3.50	-7.83	0.00016	1	AVG	PASS
Mid	2441	-9.36	3.50	-5.86	0.00026			PASS
High	2480	-5.61	3.50	-2.11	0.00062			PASS



6.4 PEAK POWER SPECTRAL DENSITY

LIMIT

1. For direct sequence systems, the peak power spectral density conducted from the intentional radiator to the antenna shall not be greater than 8dBm in any 3kHz band during any time interval of continuous transmission.
2. The direct sequence operating of the hybrid system, with the frequency hopping operation turned off, shall comply with the power density requirements of paragraph (d) of this section.

MEASUREMENT EQUIPMENT USED

Name of Equipment	Manufacturer	Model	Serial Number	Last Calibration	Due Calibration
Spectrum Analyzer	Agilent	E4446A	US44300399	02/21/2016	02/20/2017

Remark: Each piece of equipment is scheduled for calibration once a year.

Test Configuration

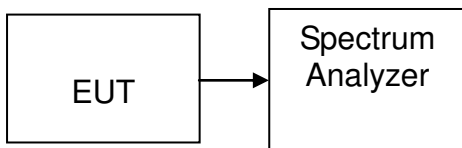

TEST PROCEDURE

1. Set analyzer center frequency to DTS channel center frequency.
2. Set the span to 1.5 times the DTS bandwidth.
3. Set the RBW to: $3\text{ kHz} \leq \text{RBW} \leq 100\text{ kHz}$.
4. Set the VBW $\geq 3 \times \text{RBW}$.
5. Detector = peak.
6. Sweep time = auto couple.
7. Trace mode = max hold.
8. Allow trace to fully stabilize.
9. Use the peak marker function to determine the maximum amplitude level within the RBW.
10. If measured value exceeds limit, reduce RBW (no less than 3 kHz) and repeat.

TEST RESULTS

Not applicable. Since EUT is the Bluetooth device.



6.5 BAND EDGES MEASUREMENT

LIMIT

According to §15.247(c), in any 100 kHz bandwidth outside the frequency bands in which the spread spectrum intentional radiator is operating, the radio frequency power that is produced by the intentional radiator shall be at least 20dB below that in the 100kHz bandwidth within the band that contains the highest level of the desired power. In addition, radiated emissions which fall in the restricted bands, as defined in §15.205(a), must also comply with the radiated emission limits specified in 15.209(a).

MEASUREMENT EQUIPMENT USED

Radiated Emission Test Site 966(2)					
Name of Equipment	Manufacturer	Model Number	Serial Number	Last Calibration	Due Calibration
Spectrum Analyzer	Agilent	E4446A	US44300399	02/21/2016	02/20/2017
EMI TEST RECEIVER	ROHDE&SCHWARZ	ESCI	100783	02/21/2016	02/20/2017
Amplifier	MITEQ	AM-1604-3000	1123808	03/18/2016	03/18/2017
High Noise Amplifier	Agilent	8449B	3008A01838	02/21/2016	02/20/2017
Board-Band Horn Antenna	Schwarzbeck	BBHA 9170	9170-497	02/28/2016	02/27/2017
Bilog Antenna	SCHAFFNER	CBL6143	5082	02/21/2016	02/20/2017
Horn Antenna	SCHWARZBECK	BBHA9120	D286	02/28/2016	02/27/2017
Active Loop Antenna	COM-POWER	AL-130	121044	02/21/2016	02/20/2017
Turn Table	N/A	N/A	N/A	N.C.R	N.C.R
Controller	Sunol Sciences	SC104V	022310-1	N.C.R	N.C.R
Controller	CT	N/A	N/A	N.C.R	N.C.R
Temp. / Humidity Meter	Anymetre	JR913	N/A	02/21/2016	02/20/2017
Antenna Tower	SUNOL	TLT2	N/A	N.C.R	N.C.R
Cable	HuberSuhner	SUCOFLEX 104PEA	N/A	N/A	N/A
Test S/W	FARAD	LZ-RF / CCS-SZ-3A2			



Test Configuration

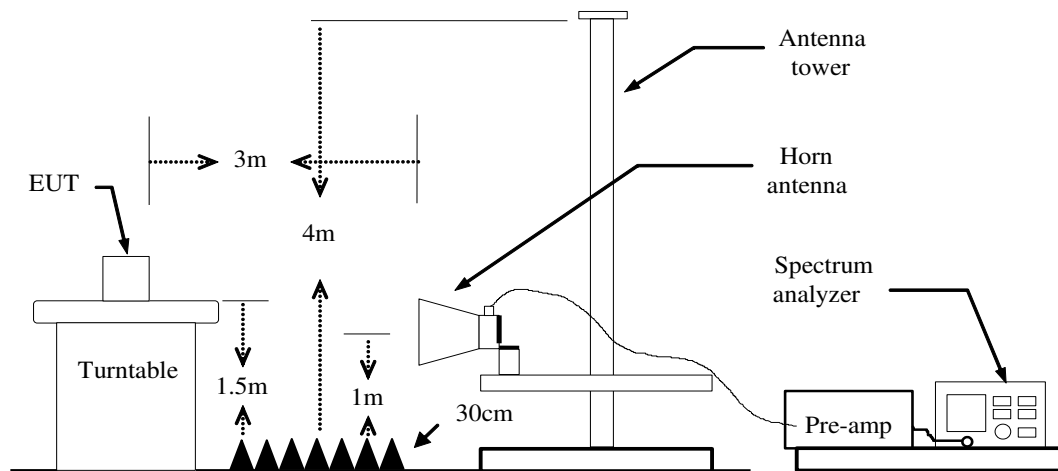

TEST PROCEDURE

1. The EUT is placed on a turntable, which is 1.5m above the ground plane.
2. The turntable shall be rotated for 360 degrees to determine the position of maximum emission level.
3. EUT is set 3m away from the receiving antenna, which is varied from 1m to 4m to find out the highest emission.
4. Set the spectrum analyzer in the following setting in order to capture the lower and upper band-edges of the emission:
 - (a) PEAK: RBW=VBW=1MHz / Sweep=AUTO
 - (b) AVERAGE: RBW=1MHz / VBW=330Hz / Sweep=AUTO
5. Repeat the procedures until all the PEAK and AVERAGE versus POLARIZATION are measured.

TEST RESULTS

Refer to attach spectrum analyzer data chart.



Test Data (GFSK)

Band Edges (CH-Low)

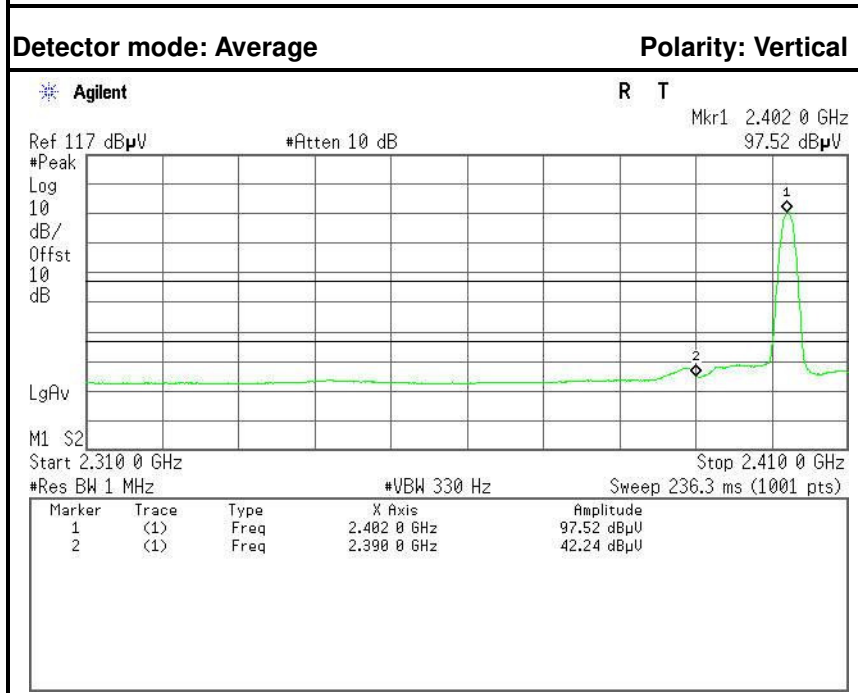
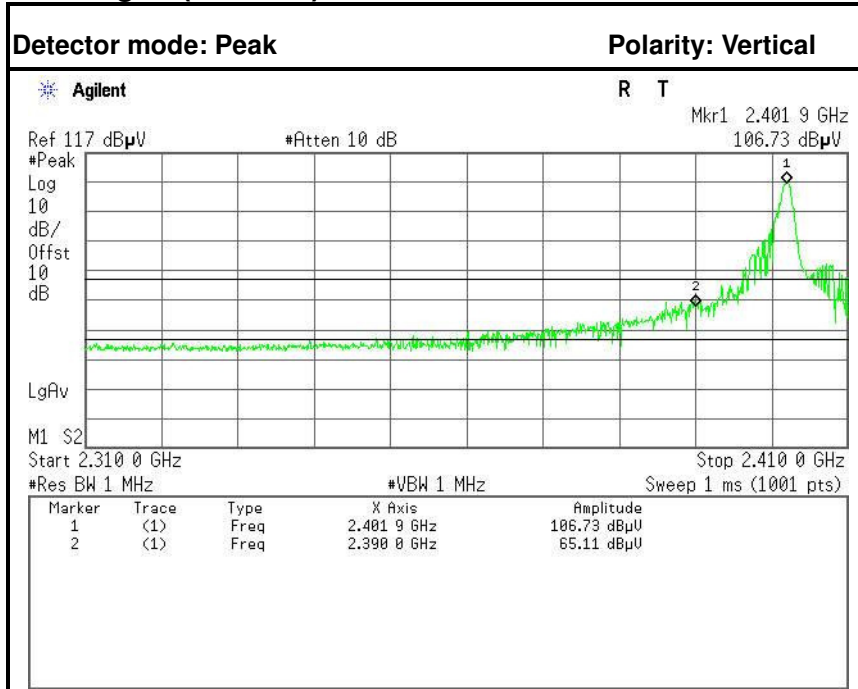

No.	Frequency (MHz)	Reading (dBuV)	Corrected (dB)	Result (dBuV)	Limit (dBuV)	Margin (dB)	Detector	Antenna Pole
1	2390.0000	58.51	-6.60	65.11	74.00	-8.89	Peak	Vertical
2	2390.0000	35.64	-6.60	42.24	54.00	-11.76	Average	Vertical

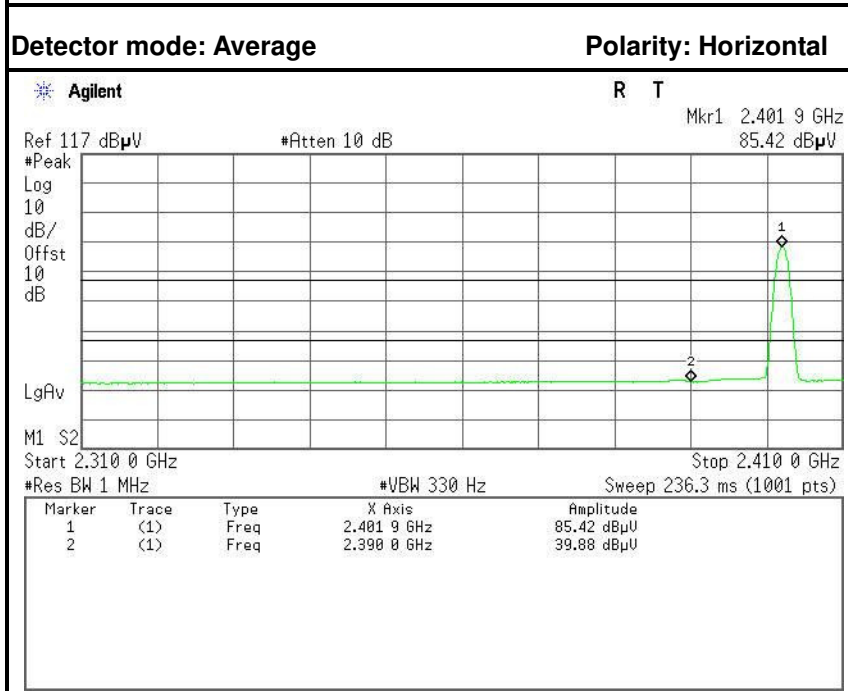
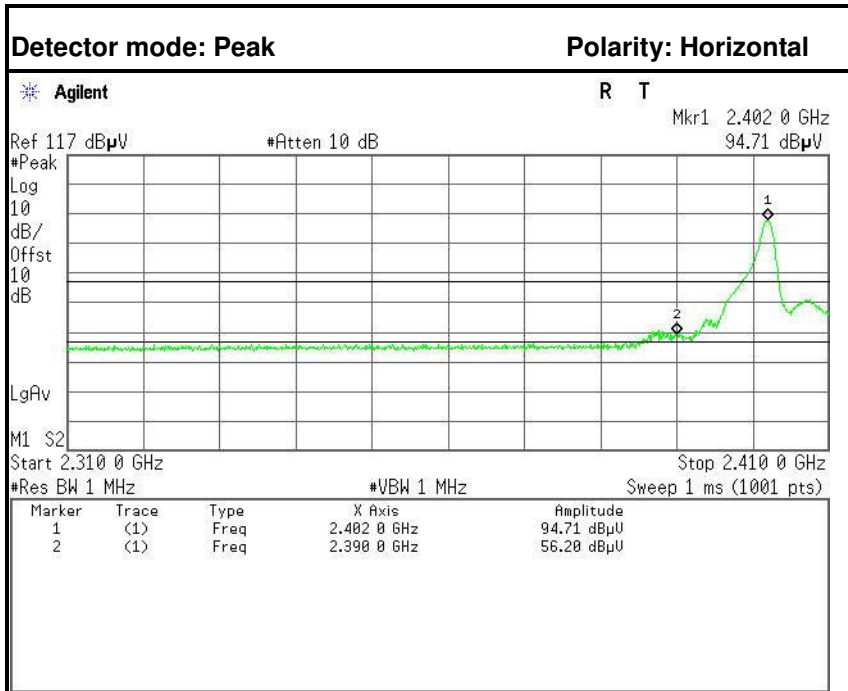

No.	Frequency (MHz)	Reading (dB μ V)	Corrected (dB)	Result (dB μ V)	Limit (dB μ V)	Margin (dB)	Detector	Antenna Pole
1	2390.0000	49.60	-6.60	56.20	74.00	-17.80	Peak	Horizontal
2	2390.0000	33.28	-6.60	39.88	54.00	-14.12	Average	Horizontal



Band Edges (CH-High)

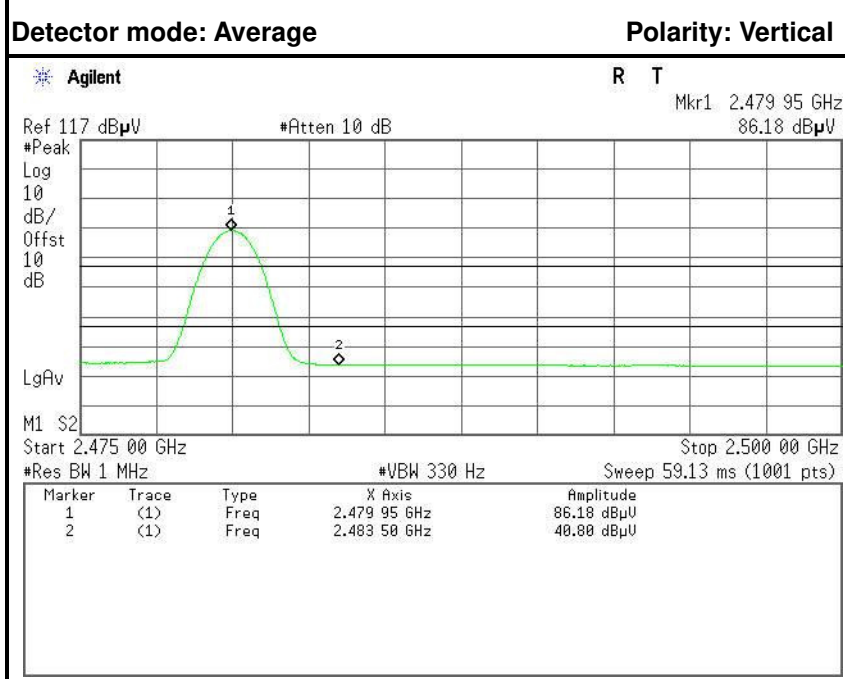
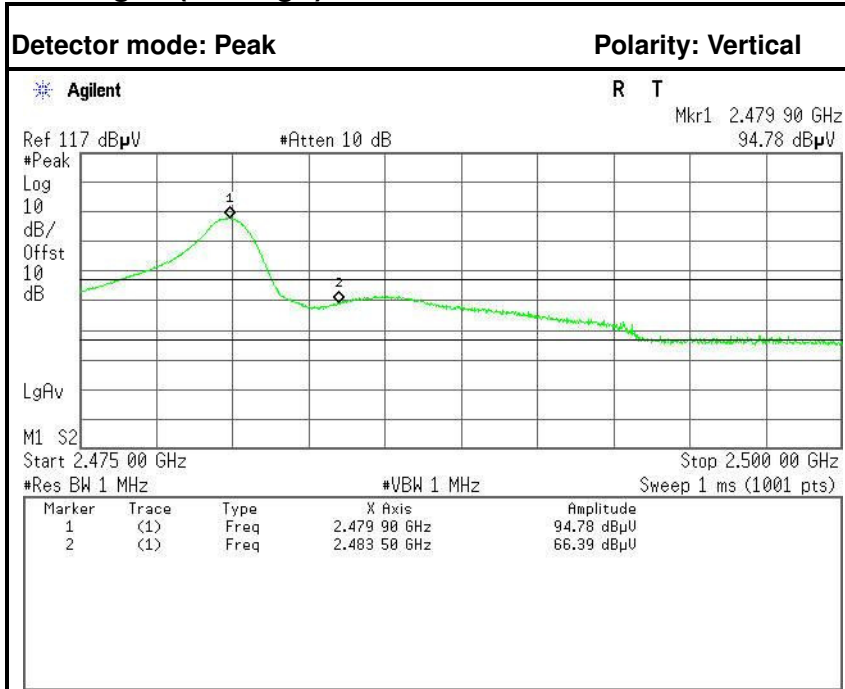

No.	Frequency (MHz)	Reading (dBuV)	Corrected (dB)	Result (dBuV)	Limit (dBuV)	Margin (dB)	Detector	Antenna Pole
1	2483.5000	60.15	-6.24	66.39	74.00	-7.61	Peak	Vertical
2	2483.5000	34.56	-6.24	40.80	54.00	-13.20	Average	Vertical

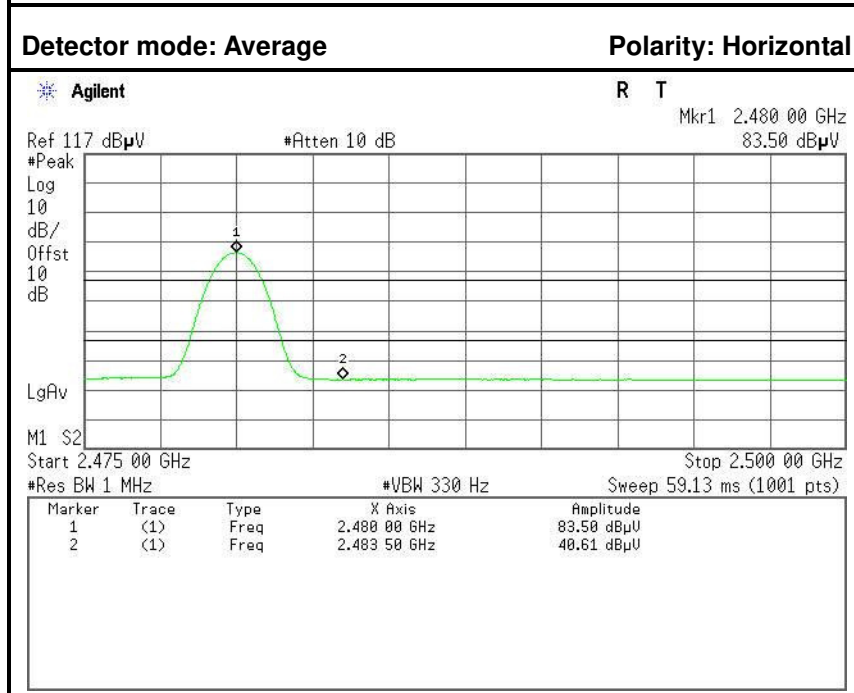
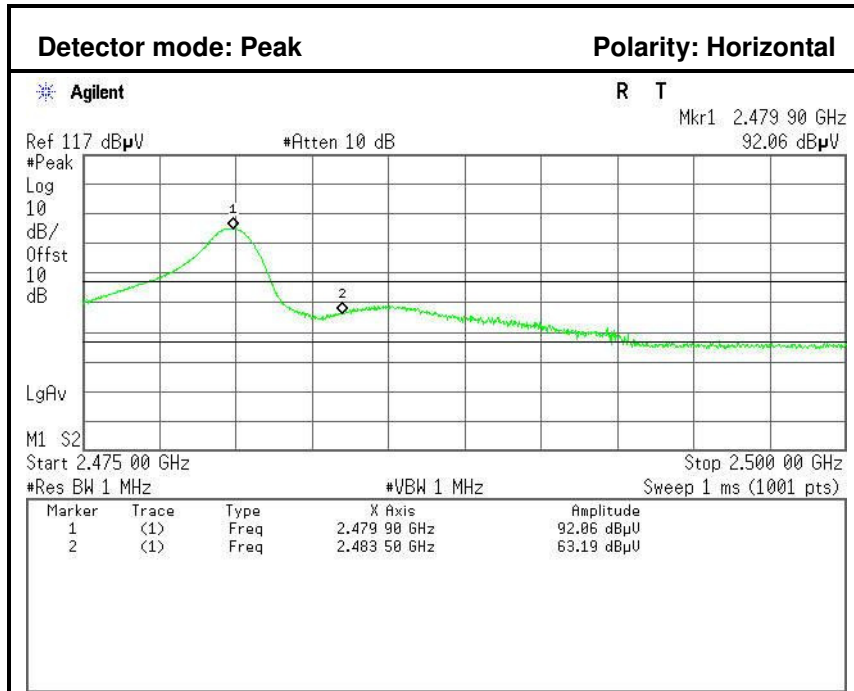

No.	Frequency (MHz)	Reading (dBuV)	Corrected (dB)	Result (dBuV)	Limit (dBuV)	Margin (dB)	Detector	Antenna Pole
1	2483.5000	56.95	-6.24	63.19	74.00	-10.81	Peak	Horizontal
2	2483.5000	34.37	-6.24	40.61	54.00	-13.39	Average	Horizontal



8DPSK

Band Edges (CH-Low)

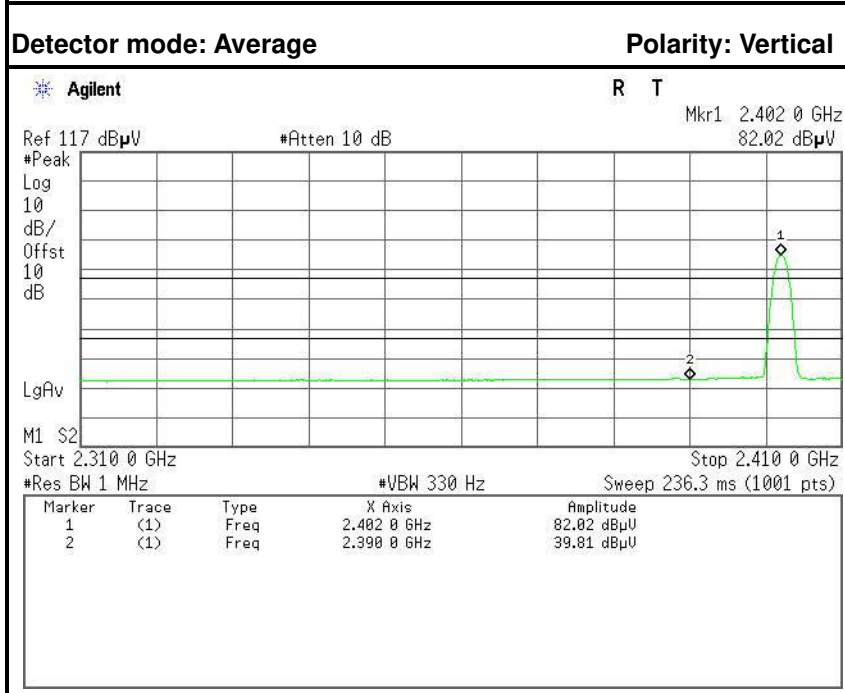
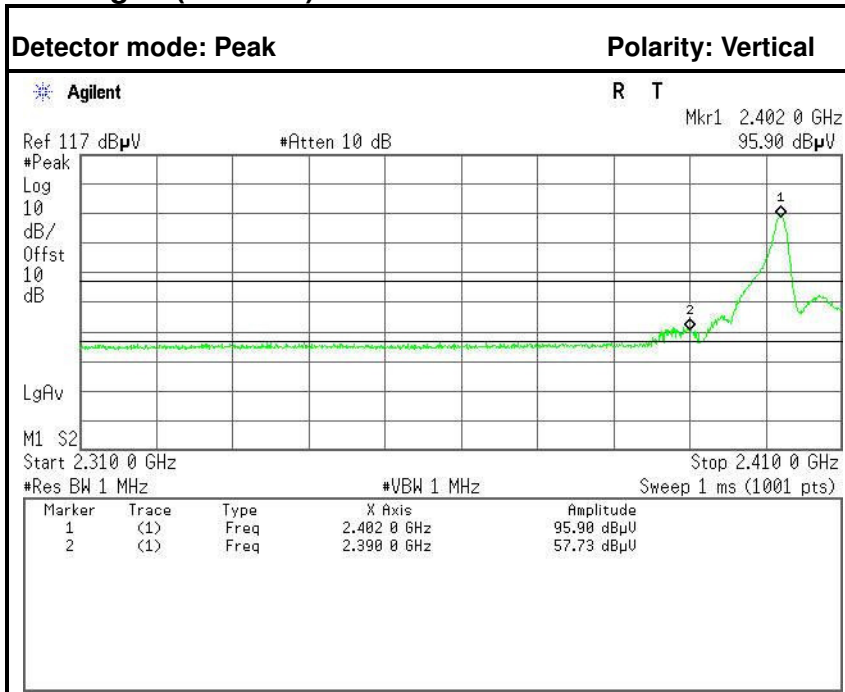

No.	Frequency (MHz)	Reading (dBuV)	Corrected (dB)	Result (dBuV)	Limit (dBuV)	Margin (dB)	Detector	Antenna Pole
1	2390.0000	51.13	-6.60	57.73	74.00	-16.27	Peak	Vertical
2	2390.0000	33.21	-6.60	39.81	54.00	-14.19	Average	Vertical

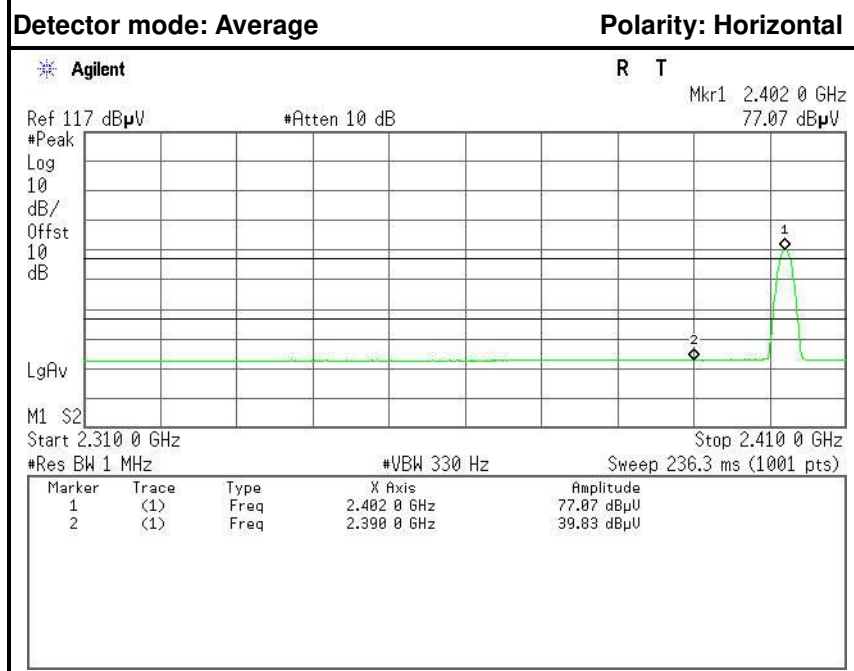
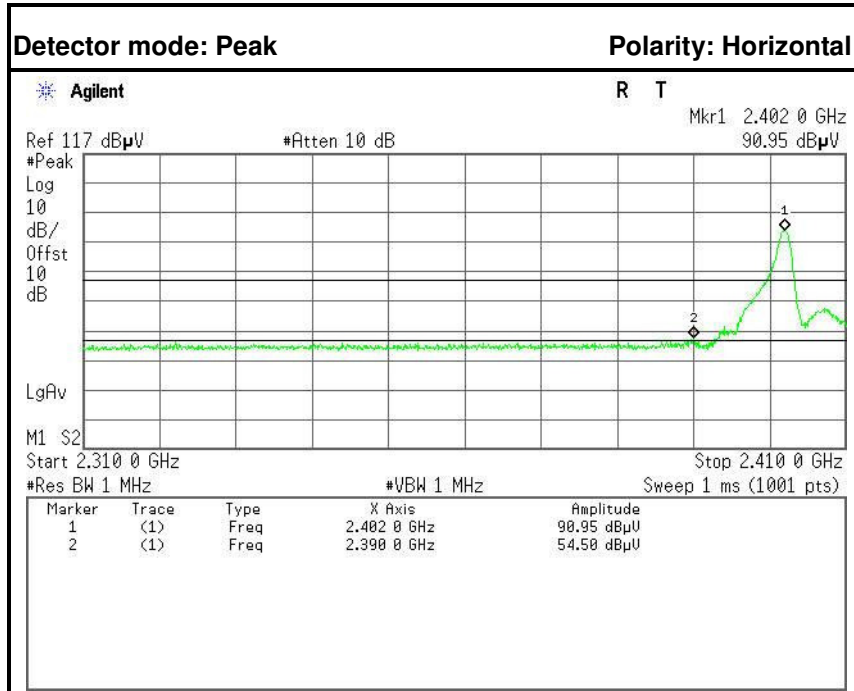

No.	Frequency (MHz)	Reading (dBuV)	Corrected (dB)	Result (dBuV)	Limit (dBuV)	Margin (dB)	Detector	Antenna Pole
1	2390.0000	47.90	-6.60	54.50	74.00	-19.50	Peak	Horizontal
2	2390.0000	33.23	-6.60	39.83	54.00	-14.17	Average	Horizontal



Band Edges (CH-High)

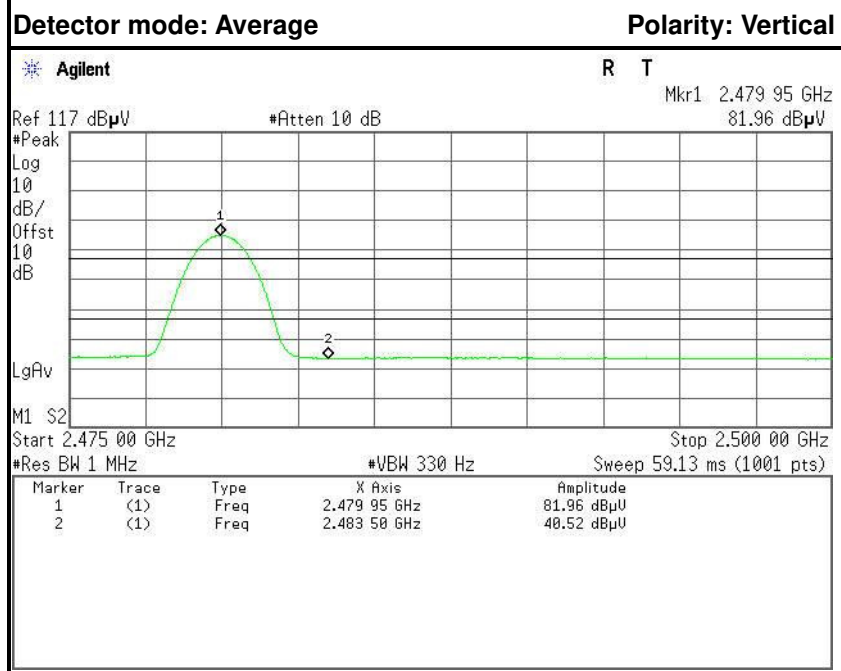
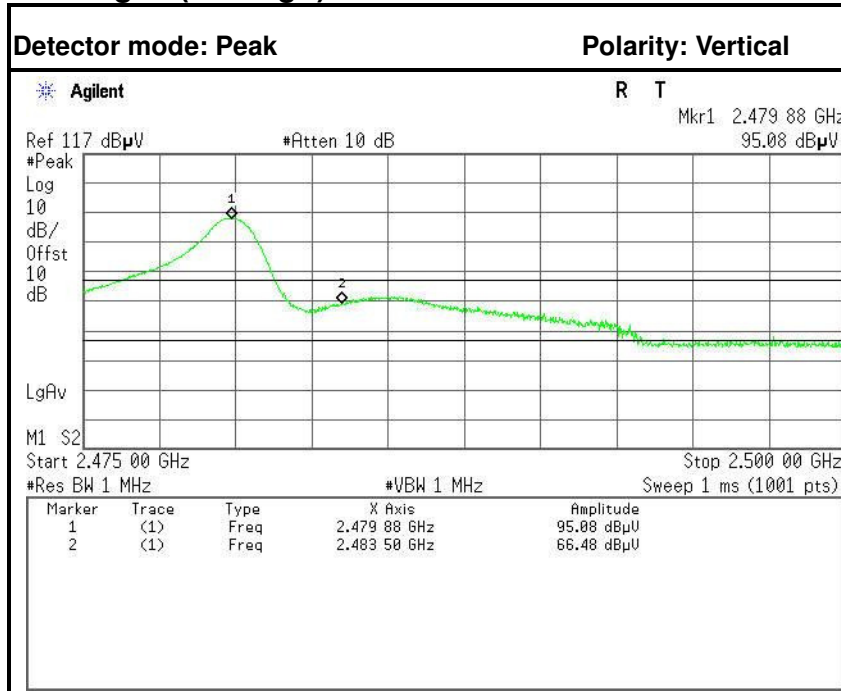

No.	Frequency (MHz)	Reading (dBuV)	Corrected (dB)	Result (dBuV)	Limit (dBuV)	Margin (dB)	Detector	Antenna Pole
1	2483.5000	60.24	-6.24	66.48	74.00	-7.52	Peak	Vertical
2	2483.5000	34.28	-6.24	40.52	54.00	-13.48	Average	Vertical

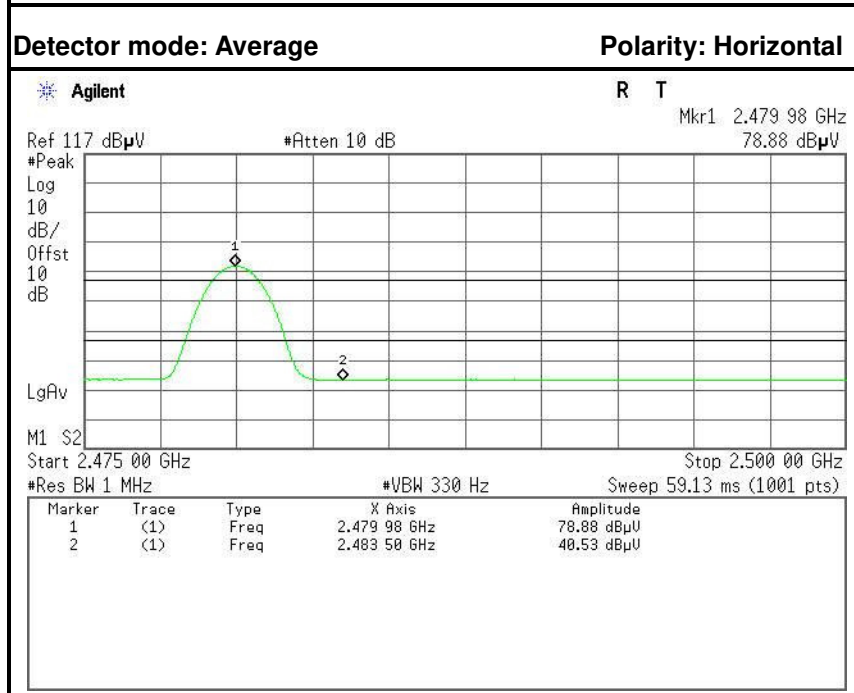
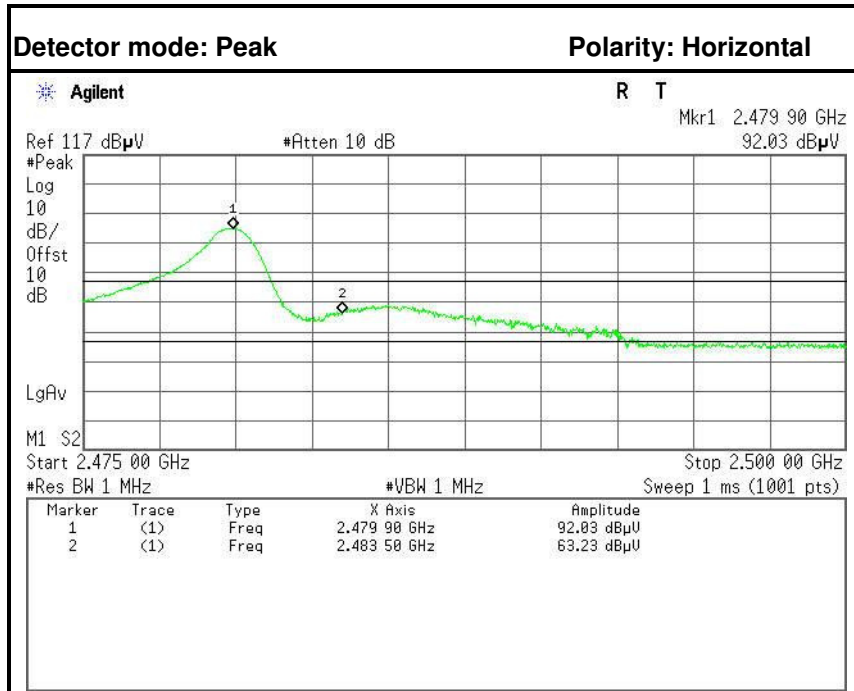

No.	Frequency (MHz)	Reading (dBuV)	Corrected (dB)	Result (dBuV)	Limit (dBuV)	Margin (dB)	Detector	Antenna Pole
1	2483.5000	56.99	-6.24	63.23	74.00	-10.77	Peak	Horizontal
2	2483.5000	34.29	-6.24	40.53	54.00	-13.47	Average	Horizontal



6.6 FREQUENCY SEPARATION

LIMIT

According to §15.247(a)(1), Frequency hopping systems shall have hopping channel carrier frequencies separated by a minimum of 25 kHz or the 20 dB bandwidth of the hopping channel, whichever is greater. Alternatively, frequency hopping systems operating in the 2400-2483.5 MHz band may have hopping channel carrier frequencies that are separated by 25 kHz or two-thirds of the 20 dB bandwidth of the hopping channel, whichever is greater, provided the systems operate with an output power no greater than 125 mW.

MEASUREMENT EQUIPMENT USED

Name of Equipment	Manufacturer	Model	Serial Number	Last Calibration	Due Calibration
Spectrum Analyzer	Agilent	E4446A	US44300399	02/21/2016	02/20/2017

Remark: Each piece of equipment is scheduled for calibration once a year.

Test Configuration

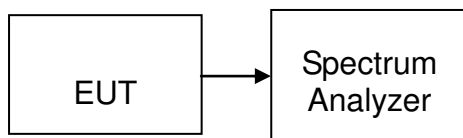

TEST PROCEDURE

1. Place the EUT on the table and set it in transmitting mode.
2. Remove the antenna from the EUT and then connect a low loss RF cable from the antenna port to the spectrum analyzer.
3. Set center frequency of spectrum analyzer = middle of hopping channel.
4. Set the spectrum analyzer as RBW=30kHz, VBW=30kHz, Adjust Span to 4 MHz, Sweep = auto.
5. Max hold. Mark 3 Peaks of hopping channel and record the 3 peaks frequency.

TEST RESULTS

No non-compliance noted

Test Data

GFSK

Channel Separation (MHz)	Two-thirds of the 20 dB Bandwidth (kHz)	Channel Separation Limit	Result
1.000	622.428	> Two-thirds of the 20 dB Bandwidth	Pass

8DPSK

Channel Separation (MHz)	Two-thirds of the 20 dB Bandwidth (kHz)	Channel Separation Limit	Result
1.000	836.667	> Two-thirds of the 20 dB Bandwidth	Pass



GFSK

Test Plot

Measurement of Channel Separation

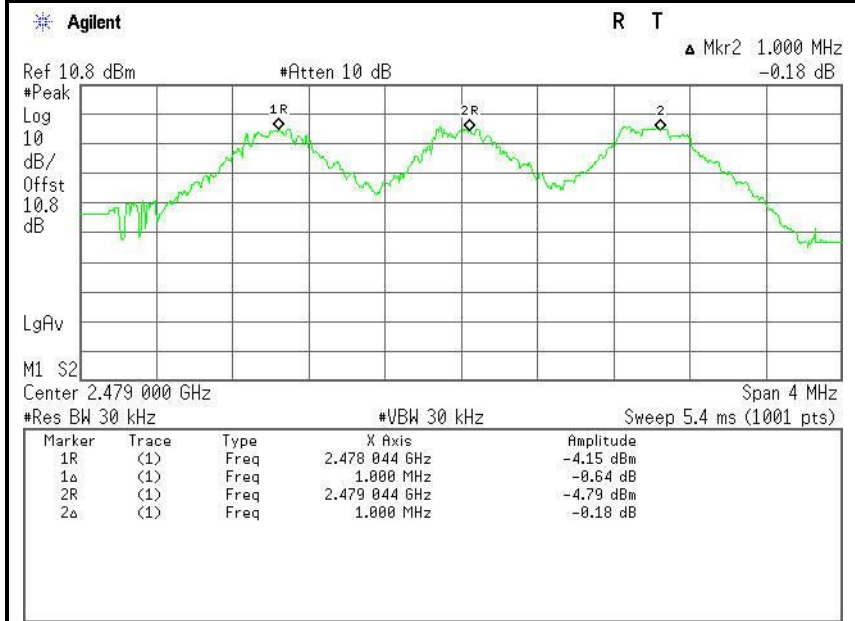

20 dB bandwidth(CH High)

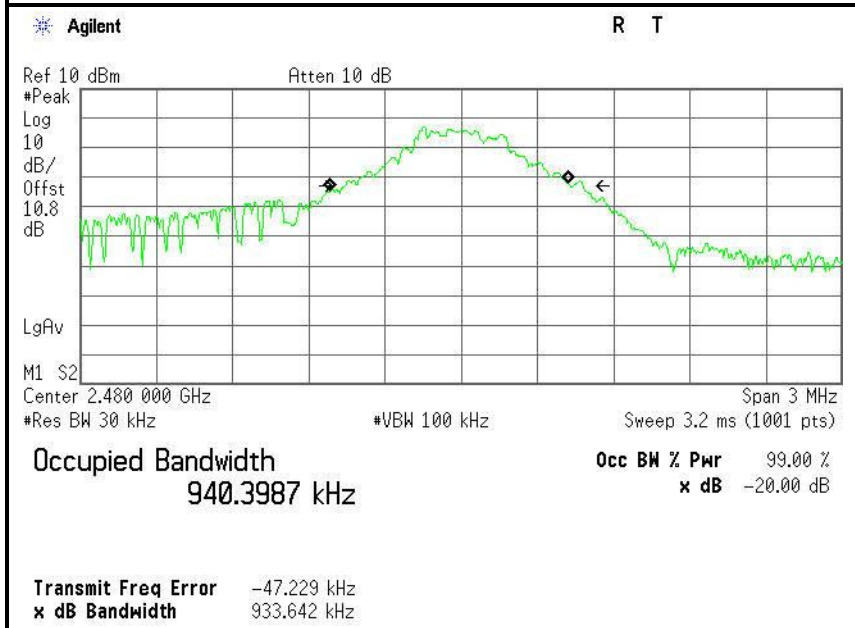



8DPSK

Test Plot

Measurement of Channel Separation

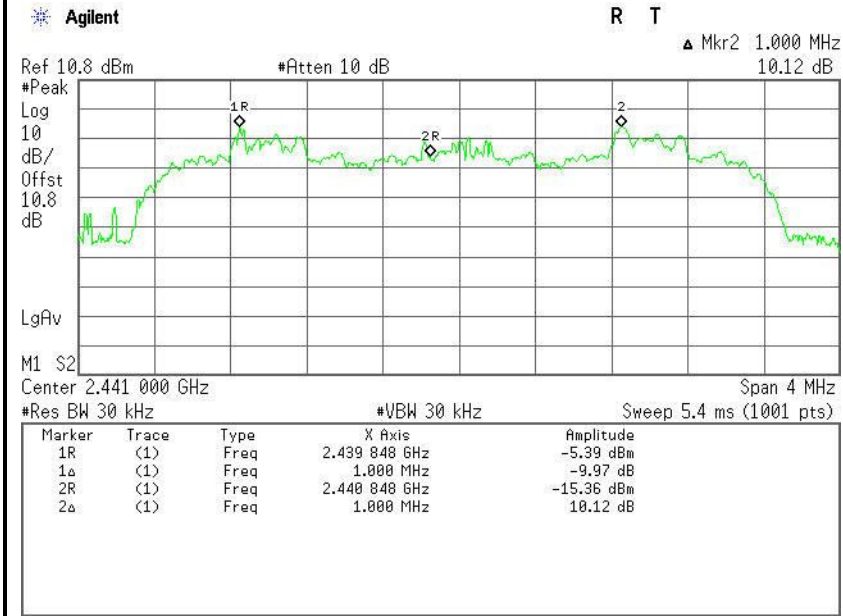

20 dB bandwidth(CH High)

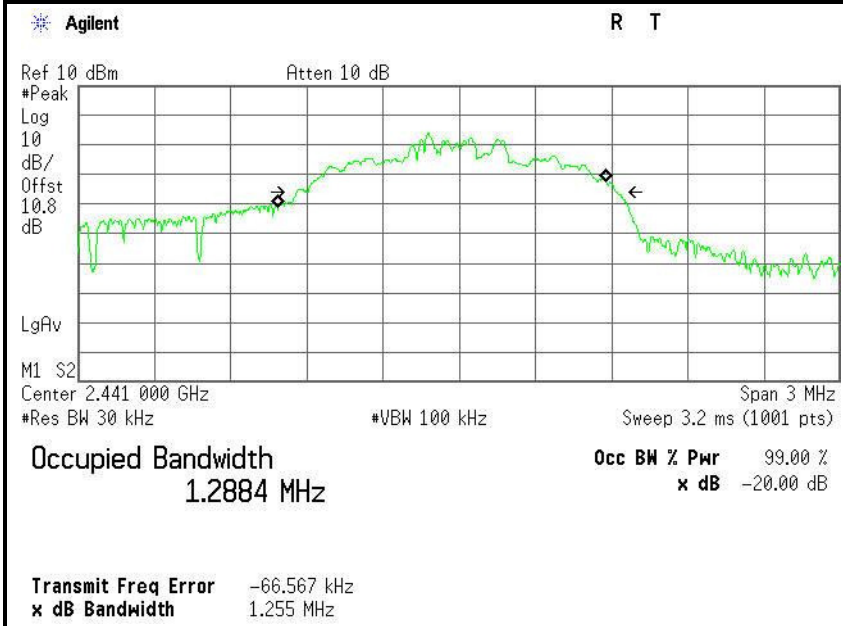



6.7 NUMBER OF HOPPING FREQUENCY

LIMIT

According to §15.247(a)(1)(ii), Frequency hopping systems operating in the 2400MHz-2483.5 MHz bands shall use at least 15 hopping frequencies.

MEASUREMENT EQUIPMENT USED

Name of Equipment	Manufacturer	Model	Serial Number	Last Calibration	Due Calibration
Spectrum Analyzer	Agilent	E4446A	US44300399	02/21/2016	02/20/2017

Remark: Each piece of equipment is scheduled for calibration once a year.

Test Configuration

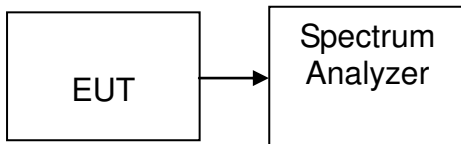

TEST PROCEDURE

1. Place the EUT on the table and set it in transmitting mode.
2. Remove the antenna from the EUT and then connect a low loss RF cable from the antenna port to the spectrum analyzer.
3. Set spectrum analyzer Start=2400MHz, Stop = 2483.5MHz, Sweep = 1ms.
4. Set the spectrum analyzer as RBW, VBW=300kHz,
5. Max hold, view and count how many channel in the band.

TEST RESULTS

No non-compliance noted

Test Data

Result (No. of CH)	Limit (No. of CH)	Result
79	>15	PASS



Test Plot

Channel Number

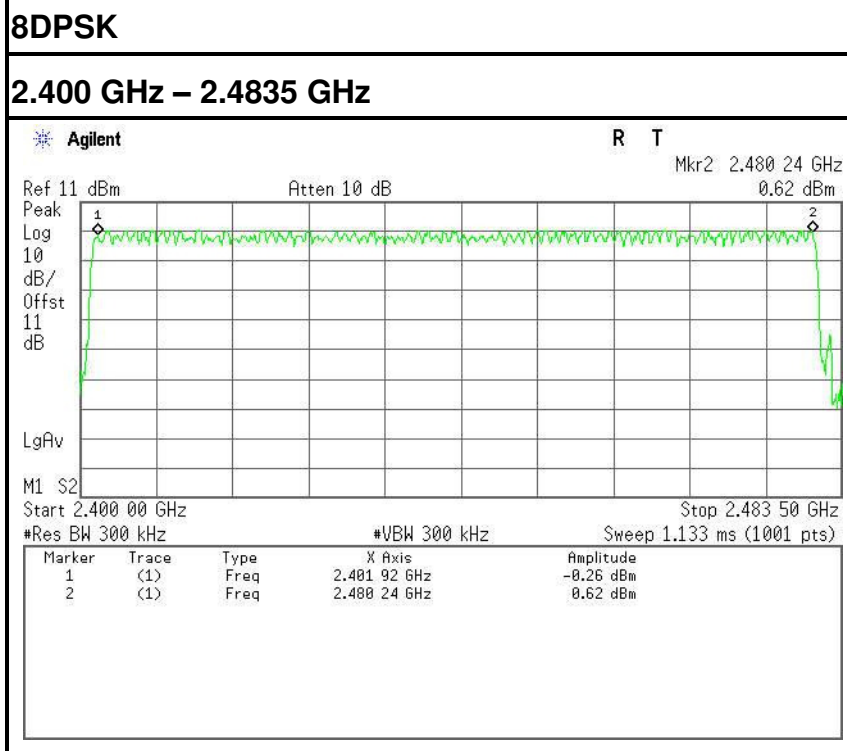
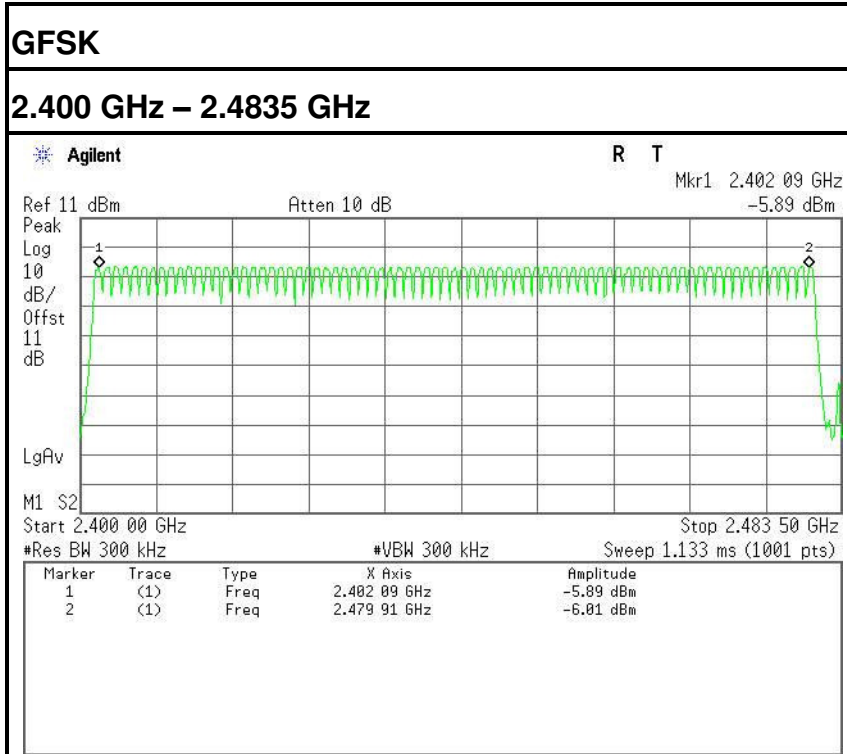



6.8 TIME OF OCCUPANCY (DWELL TIME)

LIMIT

According to §15.247(a)(1)(iii), Frequency hopping systems operating in the 2400MHz-2483.5 MHz bands. The average time of occupancy on any channels shall not greater than 0.4 s within a period 0.4s multiplied by the number of hopping channels employed.

MEASUREMENT EQUIPMENT USED

Name of Equipment	Manufacturer	Model	Serial Number	Last Calibration	Due Calibration
Spectrum Analyzer	Agilent	E4446A	US44300399	02/21/2016	02/20/2017

Remark: Each piece of equipment is scheduled for calibration once a year.

Test Configuration

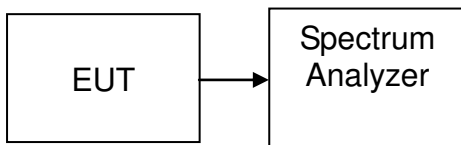

TEST PROCEDURE

1. Place the EUT on the table and set it in transmitting mode.
2. Remove the antenna from the EUT and then connect a low loss RF cable from the antenna port to the spectrum analyzer.
3. Set center frequency of spectrum analyzer = operating frequency.
4. Set the spectrum analyzer as RBW, VBW=1MHz, Span = 0Hz, Sweep = auto.
5. Repeat above procedures until all frequency measured were complete.



TEST RESULTS

No non-compliance noted

Test Data

GFSK

DH 1

CH Mid: $0.403 * (1600/2)/79 * 31.6 = 128.96$ (ms)

CH	Pulse Time (ms)	Total of Dwell (ms)	Period Time (s)	Limit (ms)	Result
Mid	0.403	128.96	31.60	400.00	PASS

DH 3

CH Mid: $1.660 * (1600/4)/79 * 31.6 = 265.60$ (ms)

CH	Pulse Time (ms)	Total of Dwell (ms)	Period Time (s)	Limit (ms)	Result
Mid	1.660	265.60	31.60	400.00	PASS

DH 5

CH Mid: $2.908 * (1600/6)/79 * 31.6 = 310.19$ (ms)

CH	Pulse Time (ms)	Total of Dwell (ms)	Period Time (s)	Limit (ms)	Result
Mid	2.908	310.19	31.60	400.00	PASS



8DPSK

DH 1

DH 1

CH Mid: $0.403 * (1600/2)/79 * 31.6 = 128.96$ (ms)

CH	Pulse Time (ms)	Total of Dwell (ms)	Period Time (s)	Limit (ms)	Result
Mid	0.403	128.96	31.60	400.00	PASS

DH 3

CH Mid: $1.660 * (1600/4)/79 * 31.6 = 265.60$ (ms)

CH	Pulse Time (ms)	Total of Dwell (ms)	Period Time (s)	Limit (ms)	Result
Mid	1.660	265.60	31.60	400.00	PASS

DH 5

CH Mid: $2.916 * (1600/6)/79 * 31.6 = 311.04$ (ms)

CH	Pulse Time (ms)	Total of Dwell (ms)	Period Time (s)	Limit (ms)	Result
Mid	2.916	311.04	31.60	400.00	PASS



Test Plot

GFSK

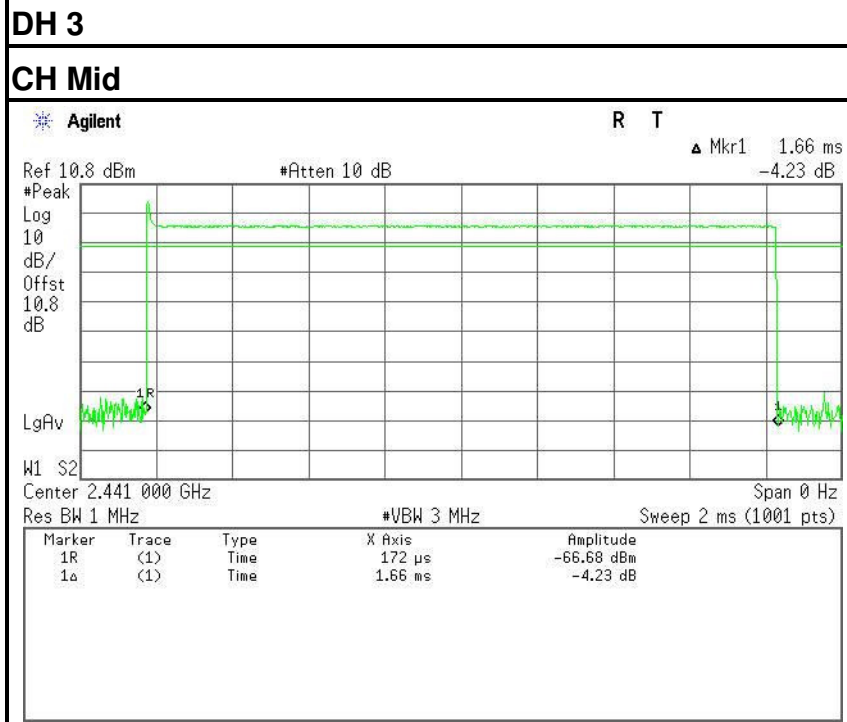
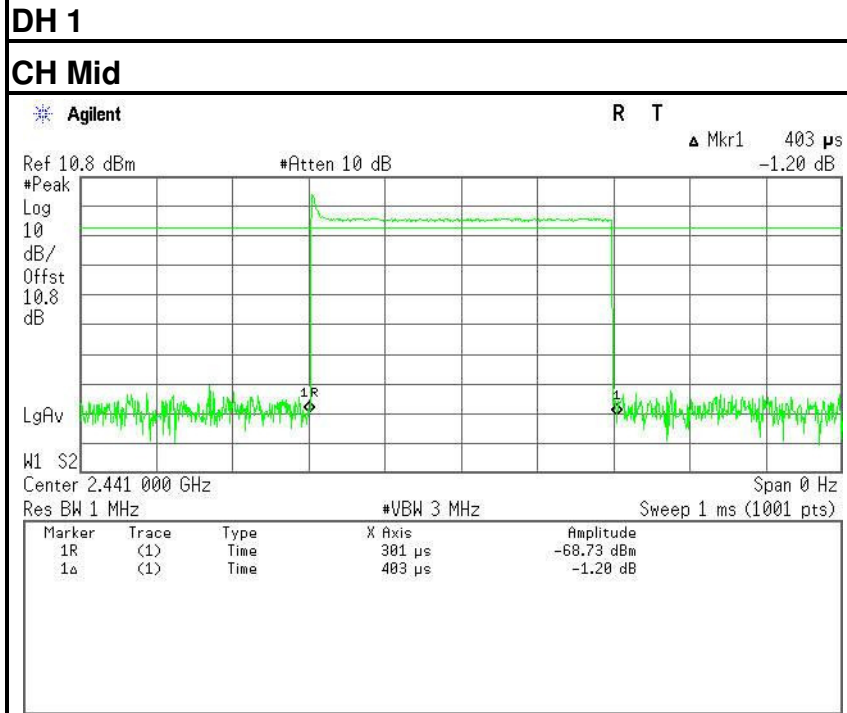

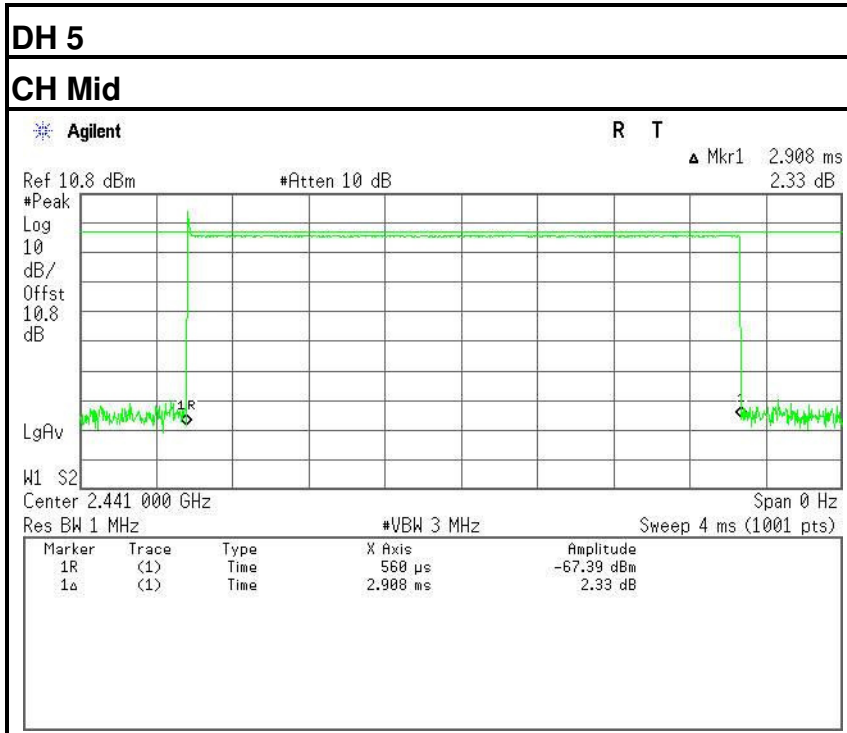



Test Plot

8DPSK

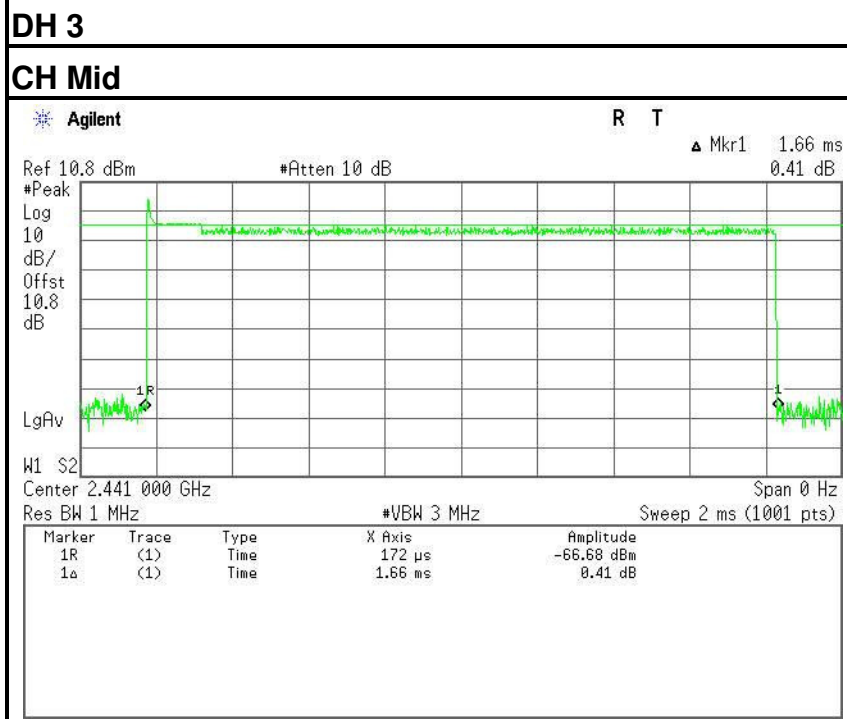
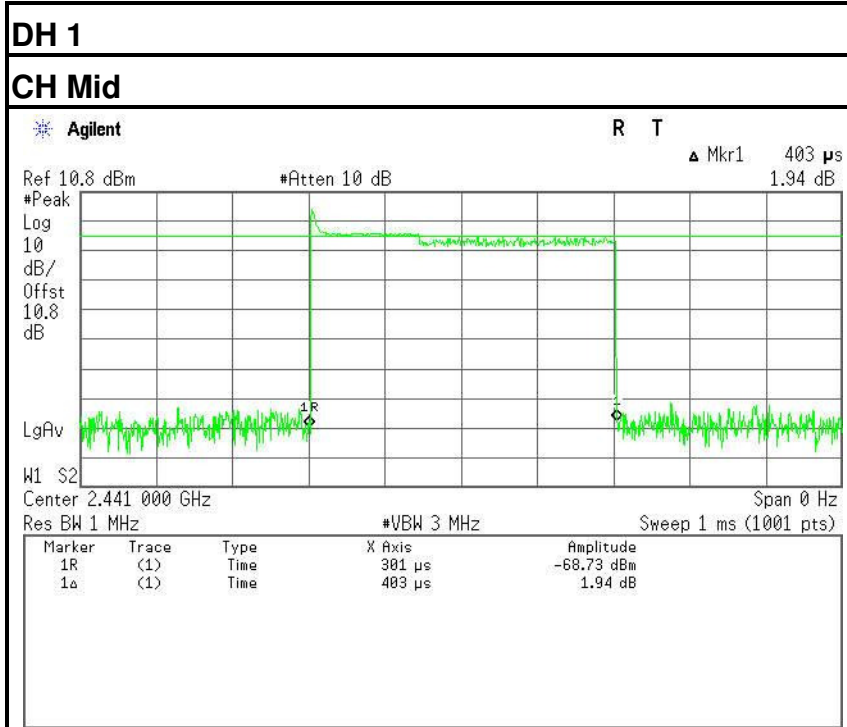

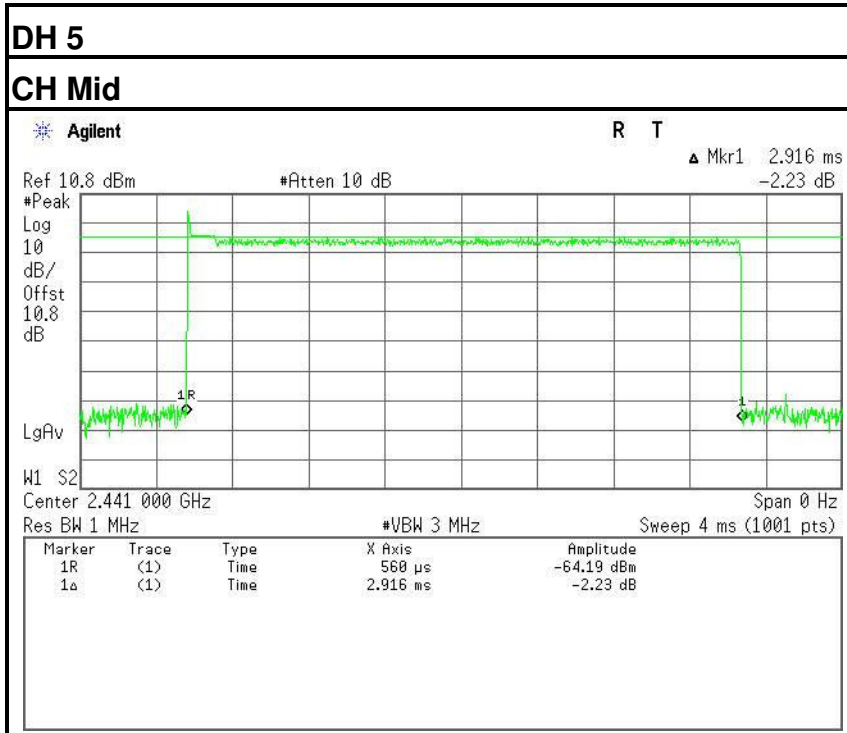



6.9 SPURIOUS EMISSIONS

6.9.1. CONDUCTED MEASUREMENT

LIMIT

In any 100 kHz bandwidth outside the frequency band in which the spread spectrum or digitally modulated intentional radiator is operating, the radio frequency power that is produced by the intentional radiator shall be at least 20 dB below that in the 100 kHz bandwidth within the band that contains the highest level of the desired power, based on either an RF conducted or a radiated measurement. Attenuation below the general limits specified in Section 15.209(a) is not required. In addition, radiated emissions which fall in the restricted bands, as defined in Section 15.205(a), must also comply with the radiated emission limits specified in Section 15.209(a) (see Section 15.205(c)).

MEASUREMENT EQUIPMENT USED

Name of Equipment	Manufacturer	Model	Serial Number	Last Calibration	Due Calibration
Spectrum Analyzer	Agilent	E4446A	US44300399	02/21/2016	02/20/2017

Remark: Each piece of equipment is scheduled for calibration once a year.

Test Configuration

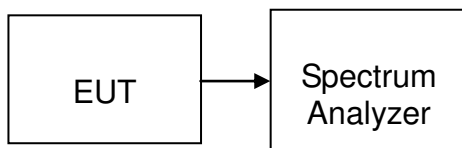

TEST PROCEDURE

Conducted RF measurements of the transmitter output were made to confirm that the EUT antenna port conducted emissions meet the specified limit and to identify any spurious signals that require further investigation or measurements on the radiated emissions site.

The transmitter output is connected to the spectrum analyzer. The resolution bandwidth is set to 100 kHz. The video bandwidth is set to 100 kHz.

Measurements are made over the 10MHz to 26GHz range with the transmitter set to the lowest, middle, and highest channels, and highest channels. No emission found between lowest internal used/generated frequency to 10MHz , it is only recorded 10MHz to 26GHz.

TEST RESULTS

No non-compliance noted

Remark: The hopping on mode and hopping off mode were chosen for pre-test and the hopping off mode was the worse case and print in the report.



Hopping Off

Test Plot (GFSK)

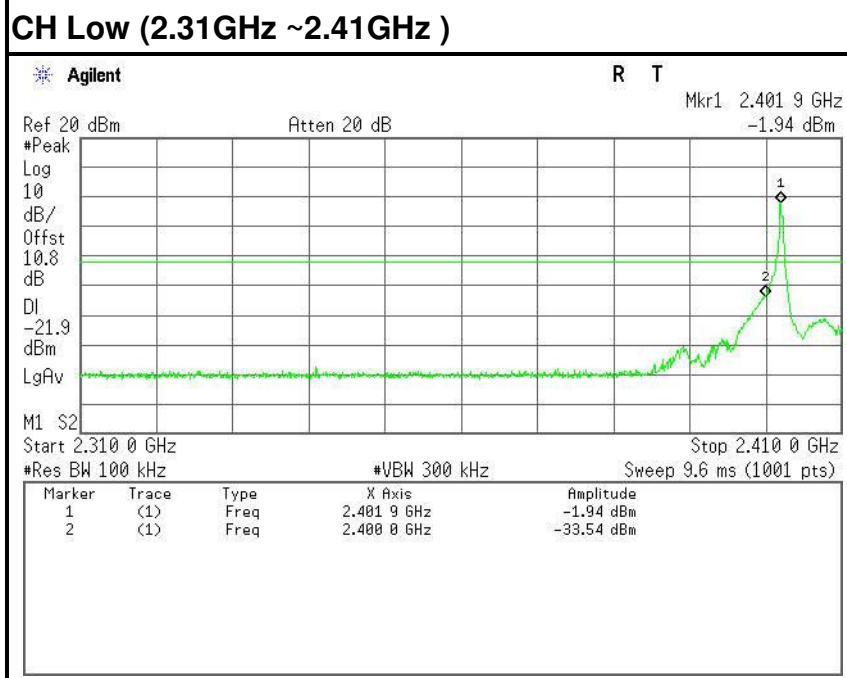
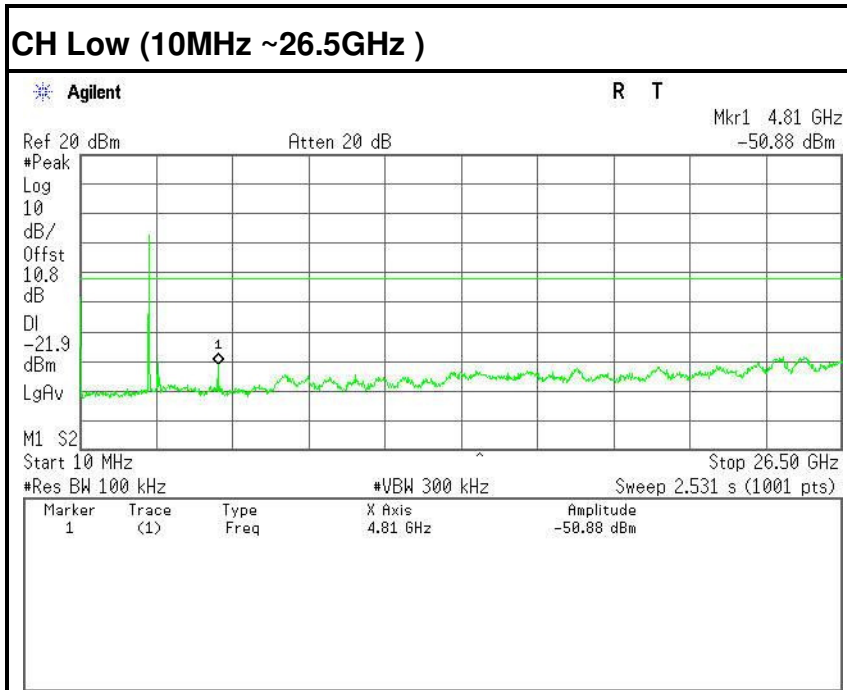

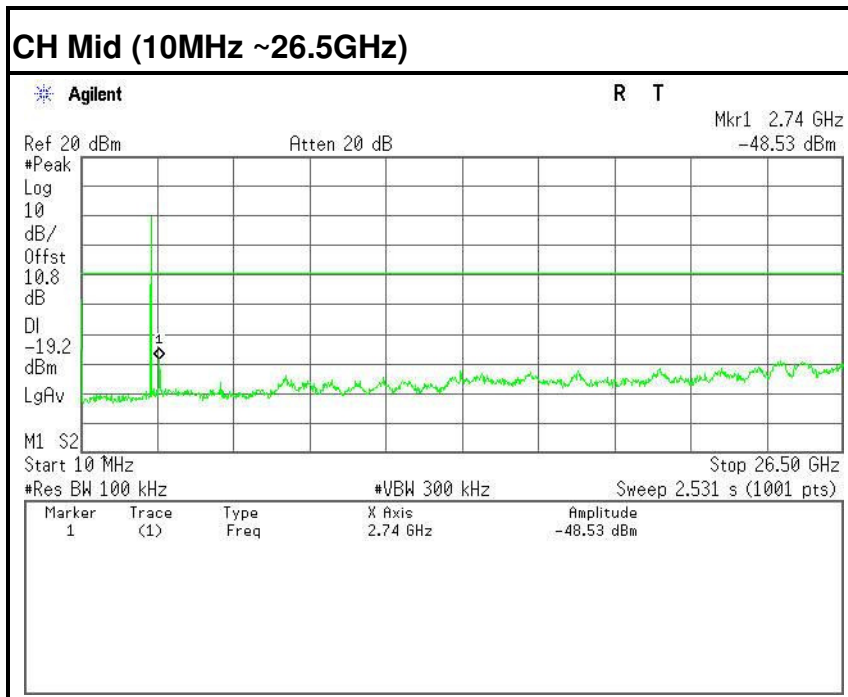



CH High (10MHz ~26.5GHz)

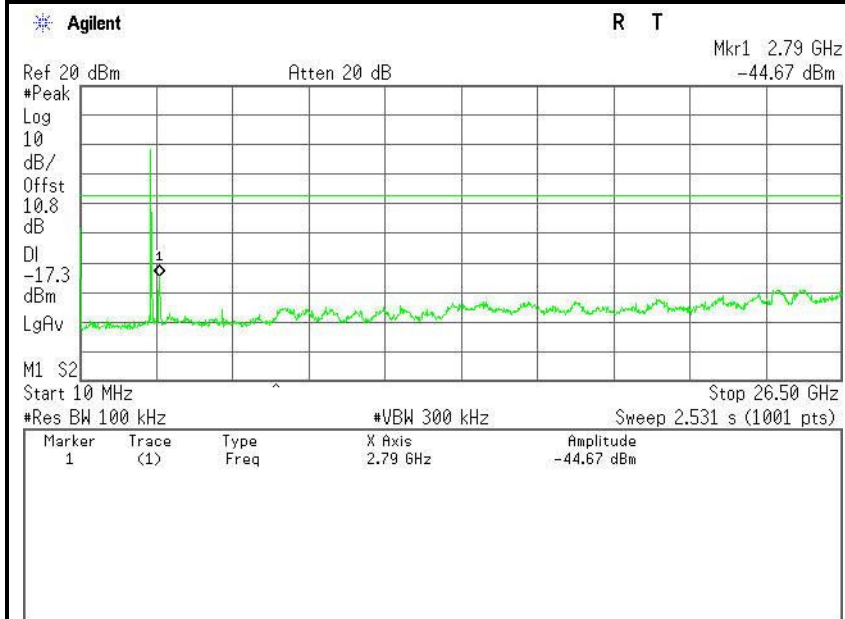

CH High (2.475GHz ~ 2.5GHz)

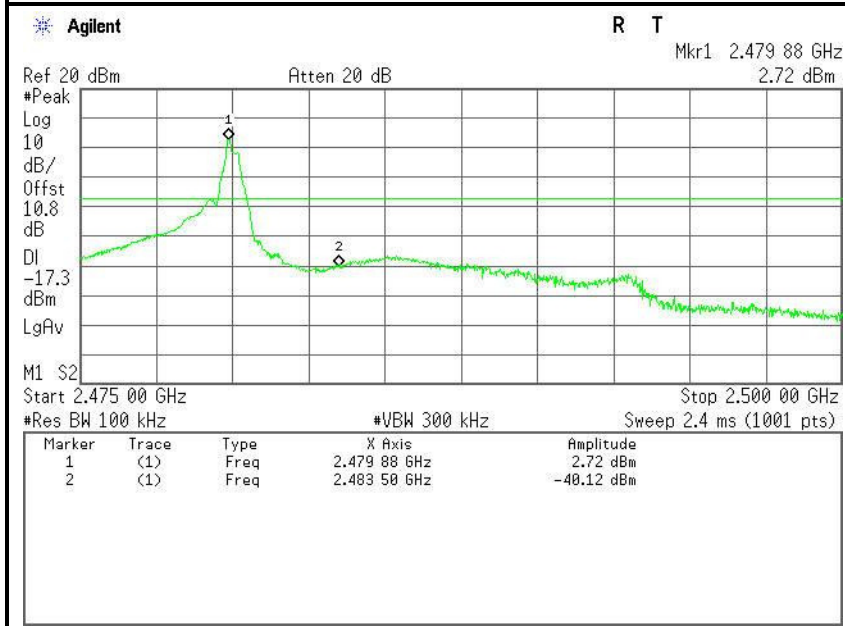



Test Plot (8DPSK)

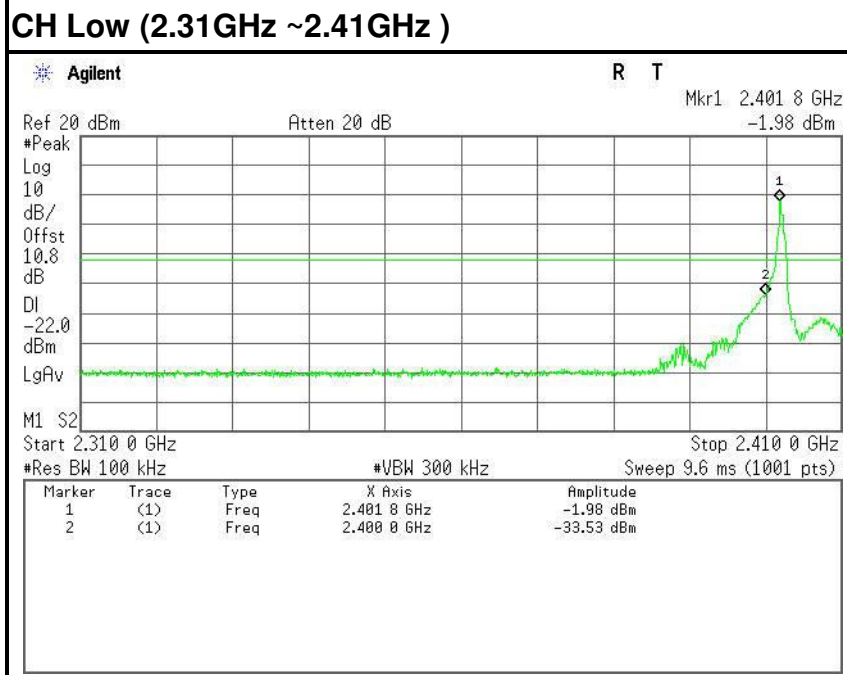
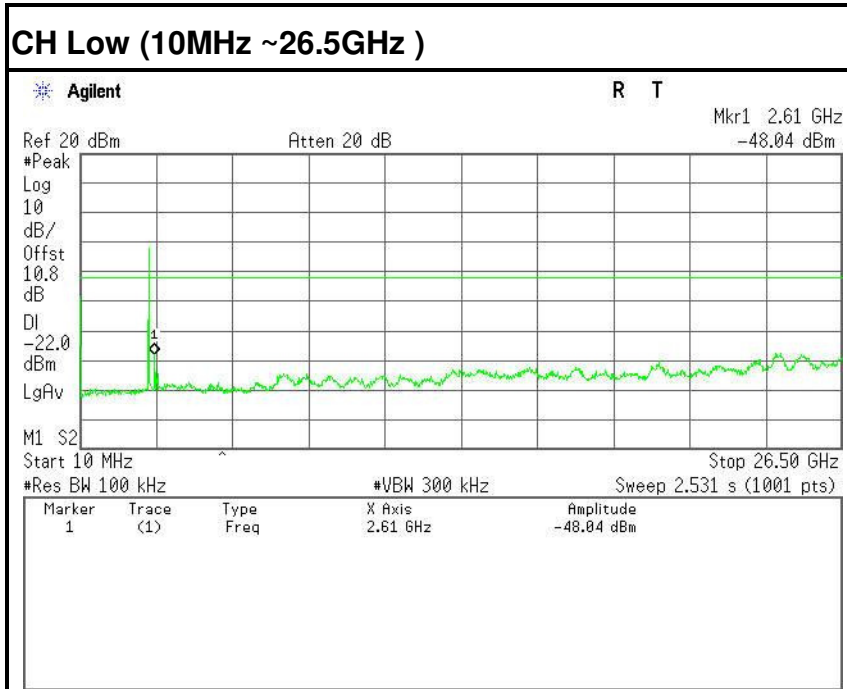

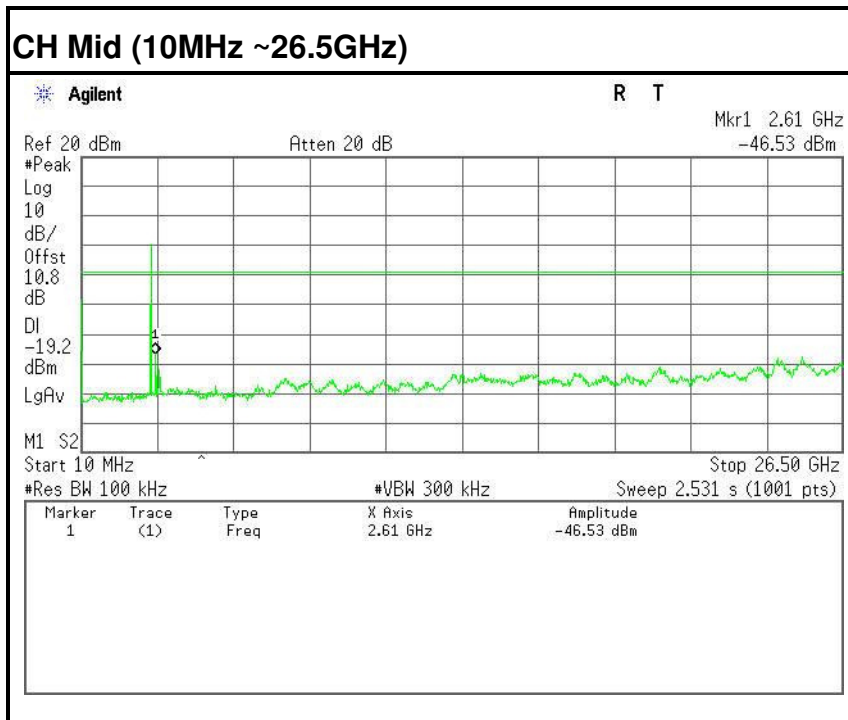



CH High (10MHz ~26.5GHz)

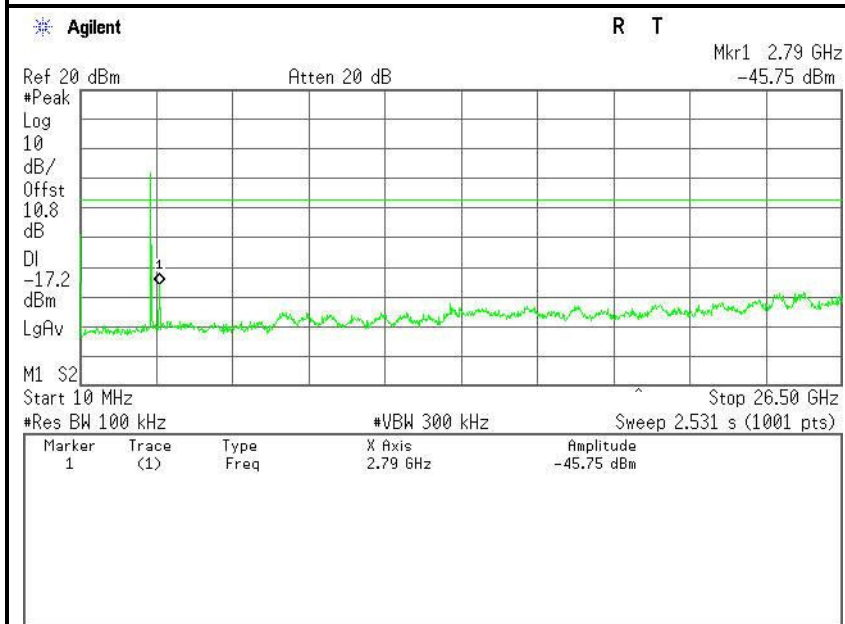

CH High (2.475GHz ~ 2.5GHz)

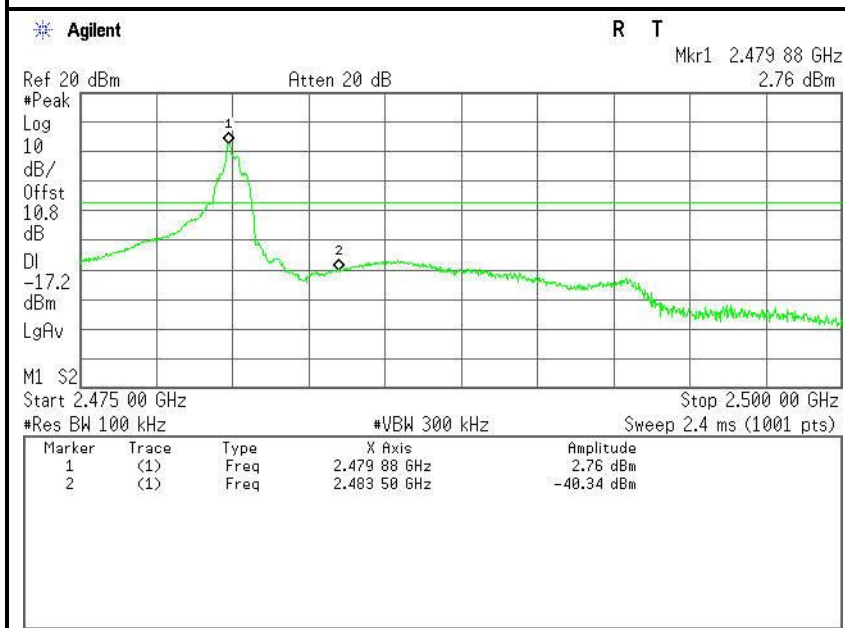



Hopping On

Test Data (GFSK)

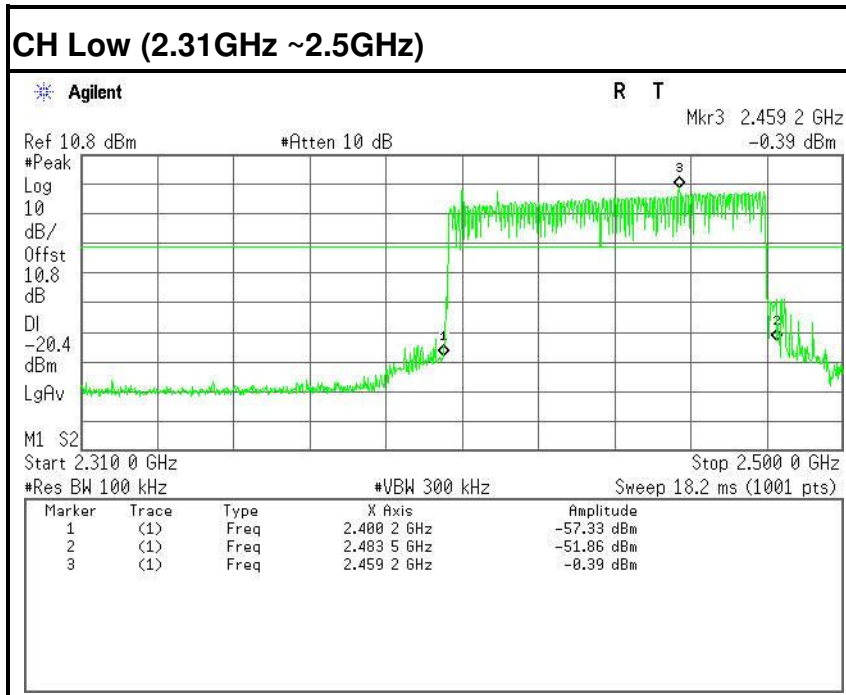

Test Data (8DPSK)

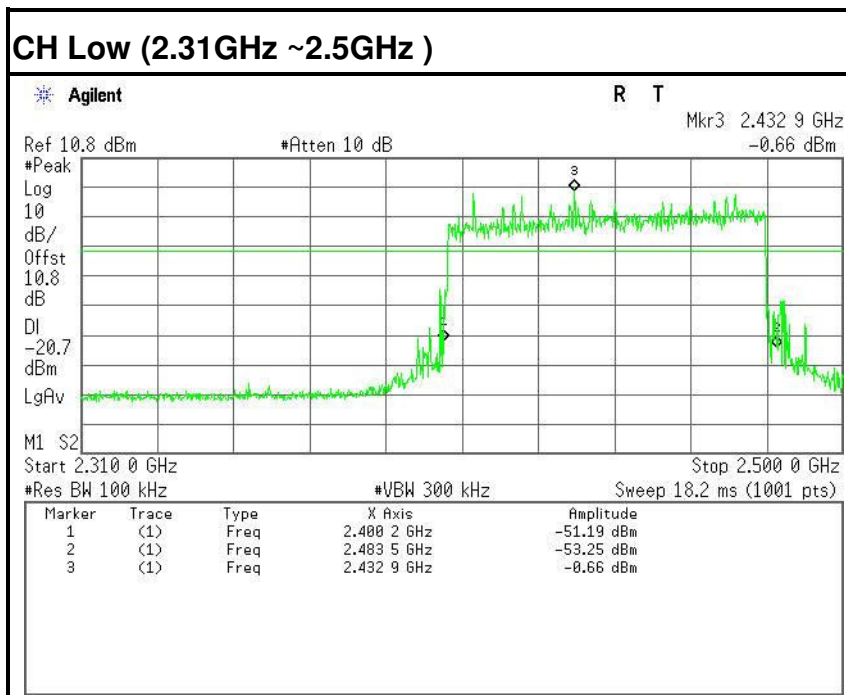



6.9.2. Radiated Emissions

LIMIT

1. Except as provided elsewhere in this Subpart, the emissions from an intentional radiator shall not exceed the field strength levels specified in the following table:

Frequency (MHz)	Field Strength (mV/m)	Measurement Distance (m)
0.009-0.490	2400/F(kHz)	300
0.490-1.705	24000/F(kHz)	30
1.705-30.0	30	30
30-88	100*	3
88-216	150*	3
216-960	200*	3
Above 960	500	3

Note: Except as provided in paragraph (g), fundamental emissions from intentional radiators operating under this Section shall not be located in the frequency bands 54-72 MHz, 76-88 MHz, 174-216 MHz or 470-806 MHz. However, operation within these frequency bands is permitted under other sections of this Part, e.g., Sections 15.231 and 15.241.

2. In the above emission table, the tighter limit applies at the band edges.

Frequency (Hz)	Field Strength ($\mu\text{V}/\text{m}$ at 3-meter)	Field Strength ($\text{dB}\mu\text{V}/\text{m}$ at 3-meter)
30-88	100	40
88-216	150	43.5
216-960	200	46
Above 960	500	54



MEASUREMENT EQUIPMENT USED

Radiated Emission Test Site 966(2)					
Name of Equipment	Manufacturer	Model Number	Serial Number	Last Calibration	Due Calibration
Spectrum Analyzer	Agilent	E4446A	US44300399	02/21/2016	02/20/2017
EMI TEST RECEIVER	ROHDE&SCHWARZ	ESCI	100783	02/21/2016	02/20/2017
Amplifier	MITEQ	AM-1604-3000	1123808	03/18/2016	03/18/2017
High Noise Amplifier	Agilent	8449B	3008A01838	02/21/2016	02/20/2017
Board-Band Horn Antenna	Schwarzbeck	BBHA 9170	9170-497	02/28/2016	02/27/2017
Bilog Antenna	SCHAFFNER	CBL6143	5082	02/21/2016	02/20/2017
Horn Antenna	SCHWARZBECK	BBHA9120	D286	02/28/2016	02/27/2017
Active Loop Antenna	COM-POWER	AL-130	121044	02/21/2016	02/20/2017
Turn Table	N/A	N/A	N/A	N.C.R	N.C.R
Controller	Sunol Sciences	SC104V	022310-1	N.C.R	N.C.R
Controller	CT	N/A	N/A	N.C.R	N.C.R
Temp. / Humidity Meter	Anymetre	JR913	N/A	02/21/2016	02/20/2017
Antenna Tower	SUNOL	TLT2	N/A	N.C.R	N.C.R
Cable	HuberSuhner	SUCOFLEX 104PEA	N/A	N/A	N/A
Test S/W	FARAD	LZ-RF / CCS-SZ-3A2			

Remark: Each piece of equipment is scheduled for calibration once a year.

Test Configuration

Below 30MHz

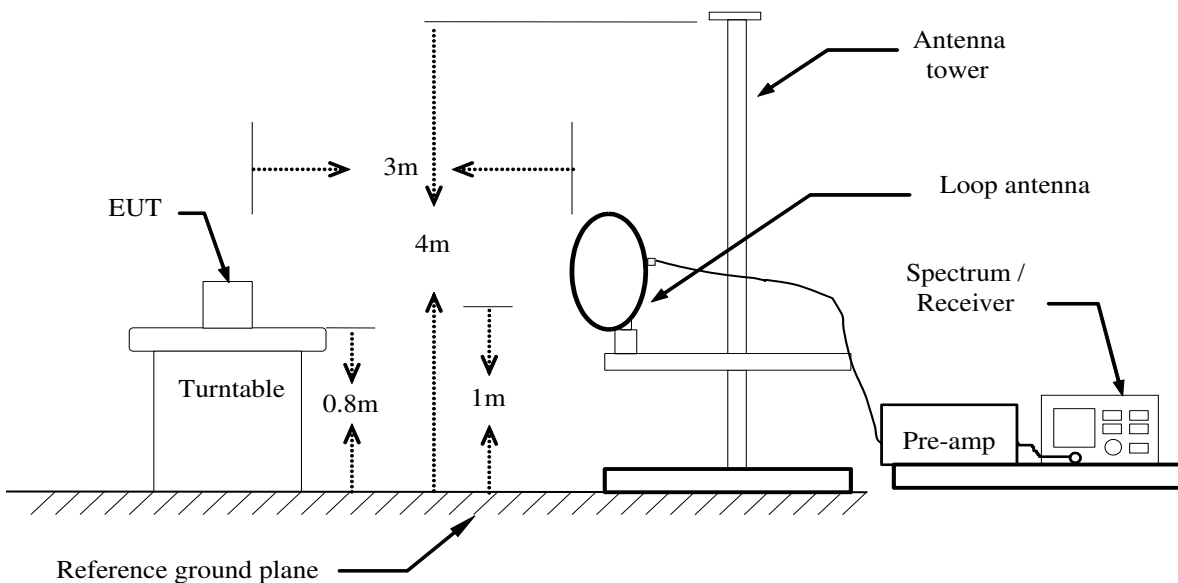



Below 1 GHz

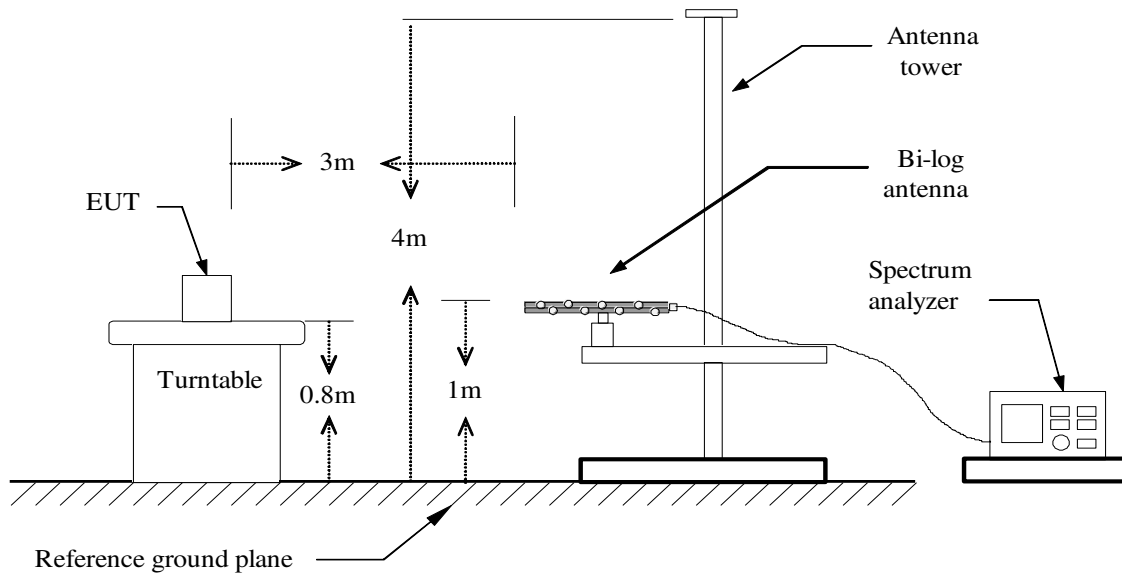

Above 1 GHz

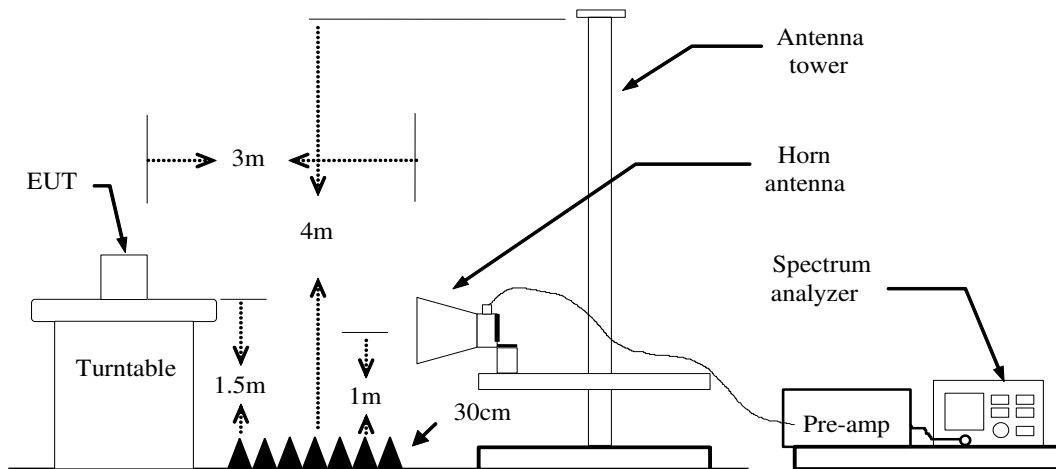



TEST PROCEDURE

1. The EUT is placed on a turntable, which is 0.8m or 1.5m above ground plane.
2. The turntable shall be rotated for 360 degrees to determine the position of maximum emission level.
3. EUT is set 3m away from the receiving antenna, which is varied from 1m to 4m to find out the highest emissions.
4. Maximum procedure was performed on the six highest emissions to ensure EUT compliance.
5. And also, each emission was to be maximized by changing the polarization of receiving antenna both horizontal and vertical.
6. Repeat above procedures until the measurements for all frequencies are complete.



TEST RESULTS

Below 1 GHz

Test Mode: TX

Tested by: Darry Wu

Ambient temperature: 24°C Relative humidity: 52% RH

Date: June 22, 2016

Frequency (MHz)	Reading (dBuV)	Correction Factor (dB/m)	Result (dBuV/m)	Limit (dBuV/m)	Margin (dB)	Antenna Pole (V/H)	Remark
37.7600	49.49	-15.48	34.01	40.00	-5.99	V	QP
71.7100	53.15	-25.87	27.28	40.00	-12.72	V	QP
120.2100	47.21	-21.13	26.08	43.50	-17.42	V	QP
437.4000	50.58	-15.66	34.92	46.00	-11.08	V	QP
551.8600	42.05	-13.13	28.92	46.00	-17.08	V	QP
600.3600	44.74	-12.86	31.88	46.00	-14.12	V	QP
37.7600	52.38	-15.48	36.90	40.00	-3.10	H	QP
227.8800	56.96	-21.53	35.43	46.00	-10.57	H	QP
312.2700	54.10	-19.12	34.98	46.00	-11.02	H	QP
407.3300	51.05	-15.74	35.31	46.00	-10.69	H	QP
480.0800	49.85	-14.36	35.49	46.00	-10.51	H	QP
600.3600	42.01	-12.86	29.15	46.00	-16.85	H	QP

****Remark:** No emission found between lowest internal used/generated frequency to 30MHz.

Notes:

1. Measuring frequencies from 9kHz to the 1GHz.
2. Radiated emissions measured in frequency range from 30MHz to 1GHz were made with an instrument using Peak/Quasi-peak detector mode.
3. Data of measurement within this frequency range shown " --- " in the table above means the reading of emissions are attenuated more than 20dB below the permissible limits or the field strength is too small to be measured.
4. The IF bandwidth of SPA between 30MHz to 1GHz was 120kHz.
5. Frequency (MHz). = Emission frequency in MHz
 Reading (dBuV) = Receiver reading
 Correction Factor(dB/m) = Antenna factor + Cable loss – Amplifier gain
 Actual FS (dBuV/m) = Reading (dBuV) + Corr. Factor (dB/m)
 Limit (dBuV/m) = Limit stated in standard
 Margin(dB) = Measured (dBuV/m) – Limits (dBuV/m)
 Antenna Pole(V/H) = Current carrying line of reading



Above 1 GHz

GFSK

Test Mode: TX(CH Low)

Tested by: Darry Wu

Ambient temperature: 24°C **Relative humidity:** 52% RH

Date: June 22, 2016

Frequency (MHz)	Reading (dBuV)	Correction Factor (dB/m)	Result (dBuV/m)	Limit (dBuV/m)	Margin (dB)	Antenna Pole (V/H)	Remark
1594.000	50.65	-6.71	43.94	74.00	-30.06	V	peak
2125.000	46.28	-4.31	41.97	74.00	-32.03	V	peak
3187.000	44.32	-1.05	43.27	74.00	-30.73	V	peak
4087.000	42.82	1.90	44.72	74.00	-29.28	V	peak
4240.000	42.95	2.43	45.38	74.00	-28.62	V	peak
8362.000	41.39	9.45	50.84	74.00	-23.16	V	peak
1594.000	48.09	-6.71	41.38	74.00	-32.62	H	Peak
1747.000	49.50	-6.38	43.12	74.00	-30.88	H	Peak
2602.000	46.28	-2.08	44.20	74.00	-29.80	H	Peak
2809.000	45.04	-1.70	43.34	74.00	-30.66	H	peak
4879.000	42.69	4.59	47.28	74.00	-26.72	H	peak
7048.000	41.43	7.79	49.22	74.00	-24.78	H	peak

Notes:

1. Measuring frequencies from 1 GHz to the 10th harmonic of highest fundamental frequency.
2. Measurements above show only up to 6 maximum emissions noted, or would be lesser if no specific emissions from the EUT are recorded (ie: margin>20dB from the applicable limit) and considered that's already beyond the background noise floor.
3. Radiated emissions measured in frequency above 1000MHz were made with an instrument using Peak detector mode and average detector mode of the emission shown in Actual FS column.
4. Spectrum setting:
 - a. Peak Setting 1GHz - 26GHz, RBW = 1MHz, VBW = 1MHz, Sweep time = auto.
 - b. AV Setting 1GH z- 26GHz, RBW = 1MHz, VBW = 330Hz, Sweep time = auto.
5. Frequency (MHz) = Emission frequency in MHz

Reading (dBuV/m) =Uncorrected Analyzer / Receiver Reading

Correction Factor (dB) = Antenna factor + Cable loss – Amplifier gain

Limit (dBuV/m) = Limit stated in standard

Margin (dB) = Result (dBuV/m)- Limit (dBuV/m)

Pk = Peak Reading

AV. = Average Reading

Remark = Mark Peak Reading or Average Reading



Test Mode: TX(CH Mid)

Tested by: Darry Wu

Ambient temperature: 24°C Relative humidity: 52% RH

Date: June 22, 2016

Frequency (MHz)	Reading (dBuV)	Correction Factor (dB/m)	Result (dBuV/m)	Limit (dBuV/m)	Margin (dB)	Antenna Pole (V/H)	Remark
1603.000	48.92	-6.69	42.23	74.00	-31.77	V	peak
2125.000	46.83	-4.31	42.52	74.00	-31.48	V	peak
2521.000	45.58	-2.22	43.36	74.00	-30.64	V	peak
3196.000	45.84	-1.03	44.81	74.00	-29.19	V	peak
5032.000	41.78	5.04	46.82	74.00	-27.18	V	peak
6976.000	41.00	7.66	48.66	74.00	-25.34	V	peak
1333.000	49.36	-7.30	42.06	74.00	-31.94	H	Peak
3529.000	44.09	-0.40	43.69	74.00	-30.31	H	Peak
4276.000	42.71	2.56	45.27	74.00	-28.73	H	Peak
4960.000	41.43	4.85	46.28	74.00	-27.72	H	peak
6013.000	41.37	6.10	47.47	74.00	-26.53	H	peak
7759.000	40.62	9.18	49.80	74.00	-24.20	H	peak

Notes:

1. Measuring frequencies from 1 GHz to the 10th harmonic of highest fundamental frequency.
2. Measurements above show only up to 6 maximum emissions noted, or would be lesser if no specific emissions from the EUT are recorded (ie: margin>20dB from the applicable limit) and considered that's already beyond the background noise floor.
3. Radiated emissions measured in frequency above 1000MHz were made with an instrument using Peak detector mode and average detector mode of the emission shown in Actual FS column.
4. Spectrum setting:
 - a. Peak Setting 1GHz - 26GHz, RBW = 1MHz, VBW = 1MHz, Sweep time = auto.
 - b. AV Setting 1GH z- 26GHz, RBW = 1MHz, VBW = 330Hz, Sweep time = auto.
5. Frequency (MHz) = Emission frequency in MHz
 - Reading (dBuV/m) =Uncorrected Analyzer / Receiver Reading
 - Correction Factor (dB) = Antenna factor + Cable loss – Amplifier gain
 - Limit (dBuV/m) = Limit stated in standard
 - Margin (dB) = Result (dBuV/m)- Limit (dBuV/m)
 - Pk = Peak Reading
 - AV. = Average Reading
 - Remark = Mark Peak Reading or Average Reading



Test Mode: TX(CH High)

Tested by: Darry Wu

Ambient temperature: 24°C Relative humidity: 52% RH

Date: June 22, 2016

Frequency (MHz)	Reading (dBuV)	Correction Factor (dB/m)	Result (dBuV/m)	Limit (dBuV/m)	Margin (dB)	Antenna Pole (V/H)	Remark
1594.000	49.98	-6.71	43.27	74.00	-30.73	V	peak
2134.000	47.83	-4.27	43.56	74.00	-30.44	V	peak
2854.000	45.13	-1.62	43.51	74.00	-30.49	V	peak
3196.000	45.05	-1.03	44.02	74.00	-29.98	V	peak
4285.000	42.66	2.59	45.25	74.00	-28.75	V	peak
4969.000	42.51	4.88	47.39	74.00	-26.61	V	peak
1270.000	47.35	-7.53	39.82	74.00	-34.18	H	Peak
1594.000	46.66	-6.71	39.95	74.00	-34.05	H	Peak
5176.000	49.98	5.29	55.27	74.00	-18.73	H	Peak
5176.000	41.76	5.29	47.05	54.00	-6.95	H	AVG
5761.000	41.60	5.98	47.58	74.00	-26.42	H	peak
7777.000	41.08	9.22	50.30	74.00	-23.70	H	peak
8335.000	41.43	9.47	50.90	74.00	-23.10	H	peak

Notes:

1. Measuring frequencies from 1 GHz to the 10th harmonic of highest fundamental frequency.
2. Measurements above show only up to 6 maximum emissions noted, or would be lesser if no specific emissions from the EUT are recorded (ie: margin>20dB from the applicable limit) and considered that's already beyond the background noise floor.
3. Radiated emissions measured in frequency above 1000MHz were made with an instrument using Peak detector mode and average detector mode of the emission shown in Actual FS column.
4. Spectrum setting:
 - a. Peak Setting 1GHz - 26GHz, RBW = 1MHz, VBW = 1MHz, Sweep time = auto.
 - b. AV Setting 1GHz - 26GHz, RBW = 1MHz, VBW = 330Hz, Sweep time = auto.
5. Frequency (MHz) = Emission frequency in MHz
 Reading (dBuV/m) = Uncorrected Analyzer / Receiver Reading
 Correction Factor (dB) = Antenna factor + Cable loss – Amplifier gain
 Limit (dBuV/m) = Limit stated in standard
 Margin (dB) = Result (dBuV/m)- Limit (dBuV/m)
 Pk = Peak Reading
 AV. = Average Reading
 Remark = Mark Peak Reading or Average Reading



8DPSK

Test Mode: TX(CH Low)

Tested by: Darry Wu

Ambient temperature: 24°C **Relative humidity:** 52% RH

Date: June 22, 2016

Frequency (MHz)	Reading (dBuV)	Correction Factor (dB/m)	Result (dBuV/m)	Limit (dBuV/m)	Margin (dB)	Antenna Pole (V/H)	Remark
1603.000	49.26	-6.69	42.57	74.00	-31.43	V	peak
2125.000	46.63	-4.31	42.32	74.00	-31.68	V	peak
3196.000	45.12	-1.03	44.09	74.00	-29.91	V	peak
4807.000	42.78	4.35	47.13	74.00	-26.87	V	peak
7201.000	43.55	8.09	51.64	74.00	-22.36	V	peak
7867.000	40.82	9.39	50.21	74.00	-23.79	V	peak
1603.000	46.53	-6.69	39.84	74.00	-34.16	H	Peak
2548.000	46.09	-2.17	43.92	74.00	-30.08	H	Peak
3241.000	44.47	-0.96	43.51	74.00	-30.49	H	Peak
3880.000	42.88	1.08	43.96	74.00	-30.04	H	peak
4753.000	41.29	4.17	45.46	74.00	-28.54	H	peak
6481.000	40.54	6.86	47.40	74.00	-26.60	H	peak

Notes:

1. Measuring frequencies from 1 GHz to the 10th harmonic of highest fundamental frequency.
2. Measurements above show only up to 6 maximum emissions noted, or would be lesser if no specific emissions from the EUT are recorded (ie: margin>20dB from the applicable limit) and considered that's already beyond the background noise floor.
3. Radiated emissions measured in frequency above 1000MHz were made with an instrument using Peak detector mode and average detector mode of the emission shown in Actual FS column.
4. Spectrum setting:
 - a. Peak Setting 1GHz - 26GHz, RBW = 1MHz, VBW = 1MHz, Sweep time = auto.
 - b. AV Setting 1GHz - 26GHz, RBW = 1MHz, VBW = 330Hz, Sweep time = auto.
5. Frequency (MHz) = Emission frequency in MHz
 Reading (dBuV/m) =Uncorrected Analyzer / Receiver Reading
 Correction Factor (dB) = Antenna factor + Cable loss – Amplifier gain
 Limit (dBuV/m) = Limit stated in standard
 Margin (dB) = Result (dBuV/m)- Limit (dBuV/m)
 Pk = Peak Reading
 AV. = Average Reading
 Remark = Mark Peak Reading or Average Reading



Test Mode: TX(CH Mid)

Tested by: Darry Wu

Ambient temperature: 24°C Relative humidity: 52% RH

Date: June 22, 2016

Frequency (MHz)	Reading (dBuV)	Correction Factor (dB/m)	Result (dBuV/m)	Limit (dBuV/m)	Margin (dB)	Antenna Pole (V/H)	Remark
1603.000	47.10	-6.69	40.41	74.00	-33.59	V	peak
2242.000	46.23	-3.67	42.56	74.00	-31.44	V	peak
2521.000	45.92	-2.22	43.70	74.00	-30.30	V	peak
2854.000	44.83	-1.62	43.21	74.00	-30.79	V	peak
4771.000	42.11	4.23	46.34	74.00	-27.66	V	peak
5284.000	41.83	5.49	47.32	74.00	-26.68	V	peak
1180.000	47.74	-7.87	39.87	74.00	-34.13	H	Peak
1603.000	47.66	-6.69	40.97	74.00	-33.03	H	Peak
1864.000	47.19	-5.86	41.33	74.00	-32.67	H	Peak
5014.000	42.19	5.00	47.19	74.00	-26.81	H	peak
6499.000	41.14	6.89	48.03	74.00	-25.97	H	peak
7732.000	41.21	9.13	50.34	74.00	-23.66	H	peak

Notes:

1. Measuring frequencies from 1 GHz to the 10th harmonic of highest fundamental frequency.
2. Measurements above show only up to 6 maximum emissions noted, or would be lesser if no specific emissions from the EUT are recorded (ie: margin>20dB from the applicable limit) and considered that's already beyond the background noise floor.
3. Radiated emissions measured in frequency above 1000MHz were made with an instrument using Peak detector mode and average detector mode of the emission shown in Actual FS column.
4. Spectrum setting:
 - a. Peak Setting 1GHz - 26GHz, RBW = 1MHz, VBW = 1MHz, Sweep time = auto.
 - b. AV Setting 1GHz - 26GHz, RBW = 1MHz, VBW = 330Hz, Sweep time = auto.
5. Frequency (MHz) = Emission frequency in MHz
 Reading (dBuV/m) =Uncorrected Analyzer / Receiver Reading
 Correction Factor (dB) = Antenna factor + Cable loss – Amplifier gain
 Limit (dBuV/m) = Limit stated in standard
 Margin (dB) = Result (dBuV/m)- Limit (dBuV/m)
 Pk = Peak Reading
 AV. = Average Reading
 Remark = Mark Peak Reading or Average Reading



Test Mode: TX(CH High)

Tested by: Darry Wu

Ambient temperature: 24°C Relative humidity: 52% RH

Date: June 22, 2016

Frequency (MHz)	Reading (dBuV)	Correction Factor (dB/m)	Result (dBuV/m)	Limit (dBuV/m)	Margin (dB)	Antenna Pole (V/H)	Remark
1603.000	48.75	-6.69	42.06	74.00	-31.94	V	peak
2800.000	45.31	-1.72	43.59	74.00	-30.41	V	peak
3196.000	45.32	-1.03	44.29	74.00	-29.71	V	peak
4744.000	42.03	4.15	46.18	74.00	-27.82	V	peak
7246.000	40.92	8.18	49.10	74.00	-24.90	V	peak
8218.000	40.92	9.53	50.45	74.00	-23.55	V	peak
1594.000	48.04	-6.71	41.33	74.00	-32.67	H	Peak
2548.000	46.31	-2.17	44.14	74.00	-29.86	H	Peak
3430.000	43.48	-0.64	42.84	74.00	-31.16	H	Peak
3925.000	42.75	1.27	44.02	74.00	-29.98	H	peak
5653.000	41.21	5.93	47.14	74.00	-26.86	H	peak
7687.000	40.51	9.04	49.55	74.00	-24.45	H	peak

Notes:

1. Measuring frequencies from 1 GHz to the 10th harmonic of highest fundamental frequency.
2. Measurements above show only up to 6 maximum emissions noted, or would be lesser if no specific emissions from the EUT are recorded (ie: margin>20dB from the applicable limit) and considered that's already beyond the background noise floor.
3. Radiated emissions measured in frequency above 1000MHz were made with an instrument using Peak detector mode and average detector mode of the emission shown in Actual FS column.
4. Spectrum setting:
 - a. Peak Setting 1GHz - 26GHz, RBW = 1MHz, VBW = 1MHz, Sweep time = auto.
 - b. AV Setting 1GHz - 26GHz, RBW = 1MHz, VBW = 330Hz, Sweep time = auto.
5. Frequency (MHz) = Emission frequency in MHz
 Reading (dBuV/m) =Uncorrected Analyzer / Receiver Reading
 Correction Factor (dB) = Antenna factor + Cable loss – Amplifier gain
 Limit (dBuV/m) = Limit stated in standard
 Margin (dB) = Result (dBuV/m)- Limit (dBuV/m)
 Pk = Peak Reading
 AV. = Average Reading
 Remark = Mark Peak Reading or Average Reading



6.10 POWERLINE CONDUCTED EMISSIONS

LIMIT

For an intentional radiator which is designed to be connected to the public utility (AC) power line, the radio frequency voltage that is conducted back onto the AC power line on any frequency or frequencies within the band 150 kHz to 30 MHz shall not exceed 250 microvolts (The limit decreases linearly with the logarithm of the frequency in the range 0.15 MHz to 0.50 MHz). The limits at specific frequency range is listed as follows:

Frequency Range (MHz)	Limits (dB μ V)	
	Quasi-peak	Average
0.15 to 0.50	66 to 56	56 to 46
0.50 to 5	56	46
5 to 30	60	50

Compliance with this provision shall be based on the measurement of the radio frequency voltage between each power line (LINE and NEUTRAL) and ground at the power terminals.

MEASUREMENT EQUIPMENT USED

Conducted Emission Test Site					
Name of Equipment	Manufacturer	Model Number	Serial Number	Last Calibration	Due Calibration
EMI TEST RECEIVER	ROHDE&SCHWARZ	ESCI	100783	02/21/2016	02/20/2017
LISN(EUT)	ROHDE&SCHWARZ	ENV216	101543-WX	02/21/2016	02/20/2017
LISN	EMCO	3825/2	8901-1459	02/21/2016	02/20/2017
Temp. / Humidity Meter	VICTOR	HTC-1	N/A	02/21/2016	02/20/2017
Test S/W	FARAD	EZ-EMC/ CCS-3A1-CE			

Remark: Each piece of equipment is scheduled for calibration once a year.



Test Configuration

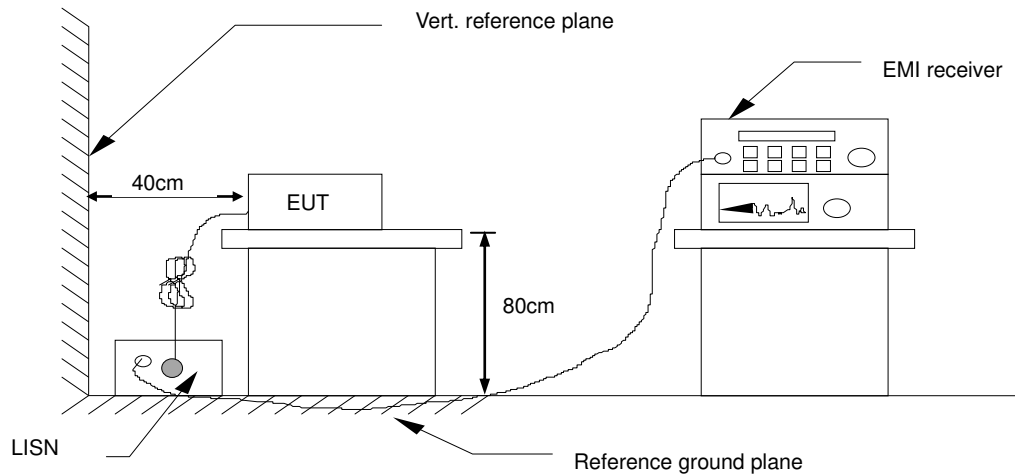

See test photographs attached in Appendix 1 for the actual connections between EUT and support equipment.

TEST PROCEDURE

1. The EUT was placed on a table, which is 0.8m above ground plane.
2. Maximum procedure was performed on the six highest emissions to ensure EUT compliance.
3. Repeat above procedures until all frequency measured were complete.

TEST RESULTS

The initial step in collecting conducted data is a spectrum analyzer peak scan of the measurement range. Significant peaks are then marked as shown on the following data page, and these signals are then quasi-peaked.



Test Data

Model No.	82208	RBW,VBW	9 kHz
Environmental Conditions	22°C, 45% RH	Test Mode	Mode 1
Tested by	Darry Wu	Line	L1
Test Date	June 20, 2016		

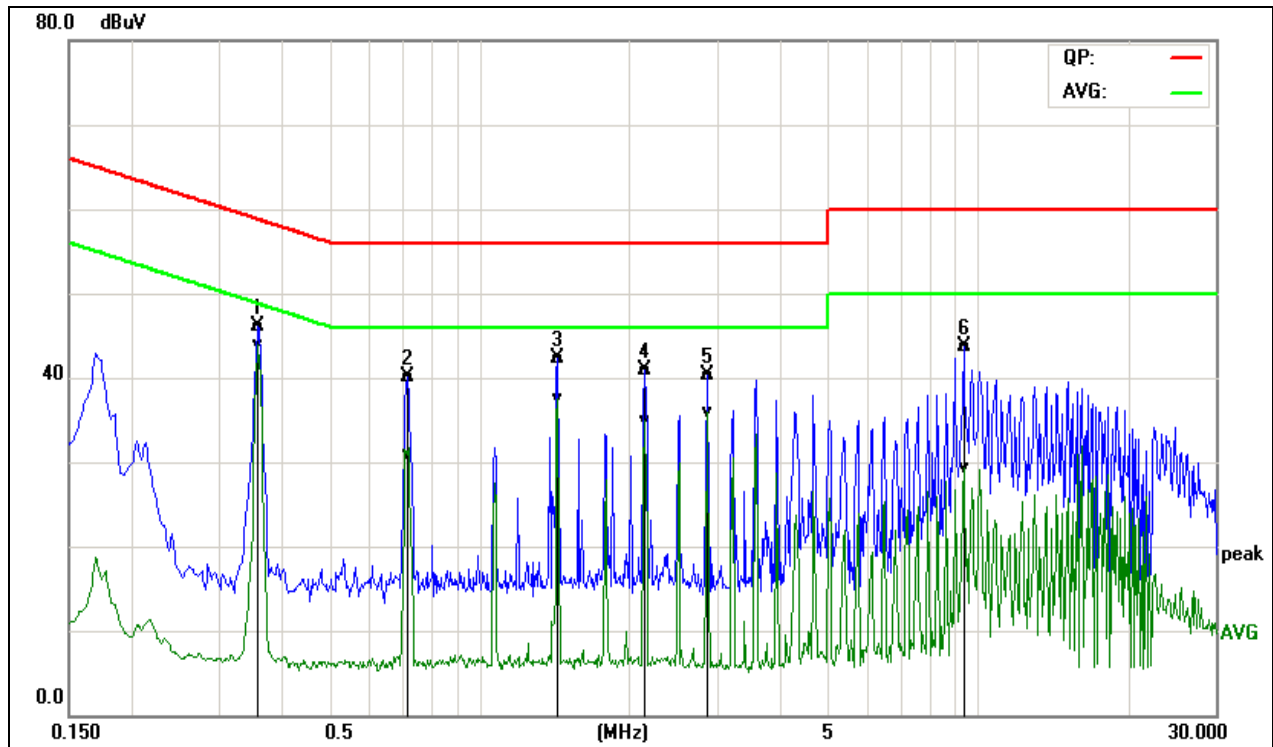

Frequency (MHz)	QuasiPeak Reading (dBuV)	Average Reading (dBuV)	Correction Factor (dB)	QuasiPeak Result (dBuV)	Average Result (dBuV)	QuasiPeak Limit (dBuV)	Average Limit (dBuV)	QuasiPeak Margin (dB)	Average Margin (dB)	Remark (Pass/Fail)
0.3580	36.35	34.30	9.68	46.03	43.98	58.77	48.77	-12.74	-4.79	Pass
0.7180	30.32	21.15	9.78	40.10	30.93	56.00	46.00	-15.90	-15.07	Pass
1.4340	32.50	27.73	9.72	42.22	37.45	56.00	46.00	-13.78	-8.55	Pass
2.1500	31.11	25.24	9.72	40.83	34.96	56.00	46.00	-15.17	-11.04	Pass
2.8660	30.61	26.12	9.71	40.32	35.83	56.00	46.00	-15.68	-10.17	Pass
9.3700	33.86	19.38	9.85	43.71	29.23	60.00	50.00	-16.29	-20.77	Pass

REMARKS: L1 = Line One (Live Line)



Model No.	82208	RBW,VBW	9 kHz
Environmental Conditions	22°C, 45% RH	Test Mode	Mode 1
Tested by	Darry Wu	Line	L2
Test Date	June 20, 2016		

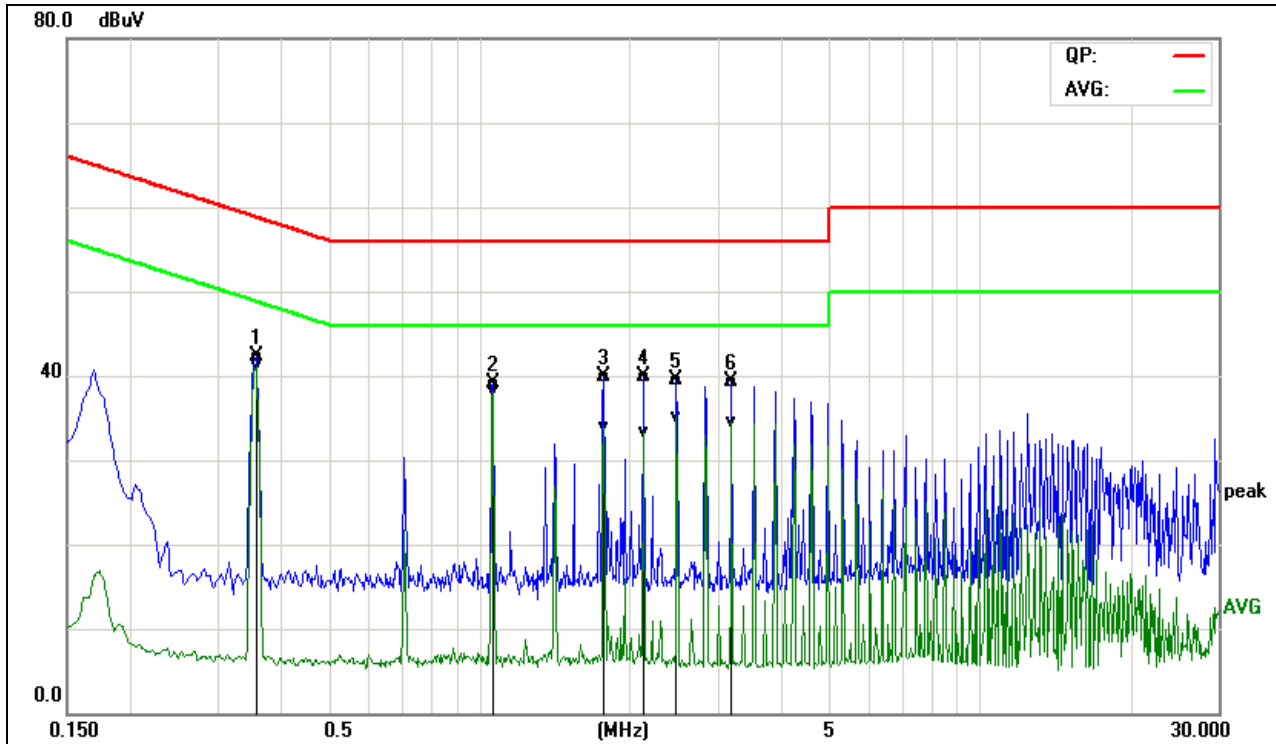

Frequency (MHz)	QuasiPeak Reading (dBuV)	Average Reading (dBuV)	Correction Factor (dB)	QuasiPeak Result (dBuV)	Average Result (dBuV)	QuasiPeak Limit (dBuV)	Average Limit (dBuV)	QuasiPeak Margin (dB)	Average Margin (dB)	Remark (Pass/Fail)
0.3580	32.65	31.33	9.73	42.38	41.06	58.77	48.77	-16.39	-7.71	Pass
1.0660	29.39	28.37	9.80	39.19	38.17	56.00	46.00	-16.81	-7.83	Pass
1.7740	30.13	24.24	9.75	39.88	33.99	56.00	46.00	-16.12	-12.01	Pass
2.1300	30.19	23.50	9.73	39.92	33.23	56.00	46.00	-16.08	-12.77	Pass
2.4860	29.70	25.27	9.74	39.44	35.01	56.00	46.00	-16.56	-10.99	Pass
3.1940	29.53	24.75	9.75	39.28	34.50	56.00	46.00	-16.72	-11.50	Pass

REMARKS: L2 = Line Two (Neutral Line)