

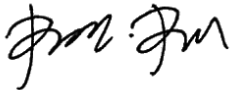



## TEST REPORT

<b>Report No.:</b>	E20190308772201-3	<b>Application No.:</b>	E20190308772201
<b>Applicant:</b>	GEMMY INDUSTRIES (HK)LIMITED BVI		
<b>Address:</b>	No.301 on 3rd Floor, East Ocean Centre,No.98 Granville Road,Kowloon,Hong Kong		
<b>Sample Description:</b>	Wireless Remote Controller		
<b>Model:</b>	2002019		
<b>Adding Model:</b>	/		
<b>FCC ID:</b>	GPO2002019		
<b>Test Specification:</b>	FCC 47 CFR Part 15 Subpart C		
<b>Test Date:</b>	2019-03-27 to 2019-04-01		
<b>Issue Date:</b>	2019-04-15		
<b>Test Result:</b>	PASS		
<b>Prepared By:</b>	<b>Reviewed By:</b>	<b>Approved By:</b>	
Darry Wu / Test Engineer	Eve Wang / Technical Manager	Tony Han / Manager	
			
Date:2019-04-15	Date:2019-04-15	Date:2019-04-15	
<b>Other Aspects:</b>			
/			
<b>Abbreviations:</b> ok / P = passed; fail / F = failed; n.a. / N = not applicable			
The test result in this test report refers exclusively to the presented test sample. This report shall not be reproduced except in full, without the written approval of GRGT.			

## **DIRECTIONS OF TEST**

1. This company carries out test task according to the national regulation of verifications which can be traced to National Primary Standards and BIPM.
2. The test report merely corresponds to the test sample. It is not permitted to copy extracts of these test result without the written permission of the test laboratory.
3. If there is any objection concerning the test, the client should inform the laboratory within 15 days from the date of receiving the test report.

## TABLE OF CONTENTS

<b>1. TEST RESULT SUMMARY .....</b>	<b>4</b>
<b>2. GENERAL DESCRIPTION OF EUT.....</b>	<b>5</b>
2.1 APPLICANT.....	5
2.2 MANUFACTURER.....	5
2.3 FACTORY .....	5
2.4 BASIC DESCRIPTION OF EQUIPMENT UNDER TEST .....	5
2.5 TEST OPERATION MODE.....	6
8.1. LOCAL SUPPORTIVE.....	6
<b>3. LABORATORY AND ACCREDITATIONS .....</b>	<b>7</b>
3.1 LABORATORY.....	7
3.2 ACCREDITATIONS .....	7
3.3 MEASUREMENT UNCERTAINTY .....	7
<b>4. LIST OF USED TEST EQUIPMENT AT GRGT.....</b>	<b>8</b>
<b>5. ANTENNA REQUIREMENT .....</b>	<b>9</b>
<b>6. RADIATED SPURIOUS EMISSIONS .....</b>	<b>10</b>
6.1. LIMITS.....	10
6.2. TEST PROCEDURES .....	10
6.3. TEST SETUP .....	14
6.4. DATA SAMPLE .....	15
6.5. TEST RESULTS .....	16
<b>7. 20DB BANDWIDTH.....</b>	<b>24</b>
1.1. LIMITS.....	24
1.2. TEST PROCEDURES.....	24
1.3. TEST SETUP .....	24
1.4. TEST RESULTS .....	24
<b>8. DUTY CYCLE .....</b>	<b>27</b>
2.1. LIMITS.....	27
2.2. TEST PROCEDURES.....	27
2.3. TEST SETUP .....	27
2.4. TEST RESULTS .....	27
<b>9. RESTRICTED BANDS OF OPERATION.....</b>	<b>28</b>
9.1. LIMITS.....	28
9.2. TEST PROCEDURES.....	28
9.3. TEST SETUP .....	29
9.4. TEST RESULTS .....	30
<b>APPENDIX A: PHOTOGRAPH OF THE TEST ARRANGEMENT.....</b>	<b>34</b>

**1. TEST RESULT SUMMARY**

<b>FCC Part 15.249</b>			
<b>Standard</b>	<b>Item</b>	<b>Limit / Severity</b>	<b>Result</b>
FCC Part 15,Subpart C (15.249)	Antenna Requirement	§15.203	PASS
	Conducted Emissions	§15.207 (a)	N/A <sup>1)</sup>
	Radiated Spurious Emission	§15.249(d)	PASS
	20 dB Bandwidth	N/A	PASS
	Duty Cycle	N/A	PASS
	Restricted bands of operation	§15.205	PASS

Note 1): The EUT received DC 3V supply by the cell.

## 2. GENERAL DESCRIPTION OF EUT

### 2.1 APPLICANT

Name: GEMMY INDUSTRIES (HK)LIMITED BVI  
Address: No.301 on 3rd Floor, East Ocean Centre, No.98 Granville Road,  
Kowloon, Hong Kong

### 2.2 MANUFACTURER

Name: GEMMY INDUSTRIES (HK)LIMITED BVI  
Address: No.301 on 3rd Floor, East Ocean Centre, No.98 Granville Road,  
Kowloon, Hong Kong

### 2.3 FACTORY

#### Factory 1

Name : ZAIXING ELECTRONIC (SHENZHEN)CO., LTD.  
Address : 3#, 1st Road Yang Yong, Shapu Community, Songgang, Baoan  
District, Shenzhen City, Guangdong Province, China.

#### Factory 2

Name : DynaTech Co. Ltd  
Address : 259-261 Xincheng Road, Qiaotou Town, Dongguan, Guangdong, China

#### Factory 3

Name : YUAN HONG CO., LTD  
Address : No. 3, meichun A industrial zone, meichun fang, fumei city, Ba Ria  
Vung Tau Province, Vietnam.

### 2.4 BASIC DESCRIPTION OF EQUIPMENT UNDER TEST

Equipment: Wireless Remote Controller  
Model No.: 2002019  
Adding Model : /  
Trade Name: /  
Power supply DC 3V supply by the cell  
Frequency 2407MHz~2477MHz  
Range  
Transmit Peak: 83.88dBuV/m (Max.)  
Power: Average: 58.75dBuV/m (Max.)  
Antenna Monopole antenna with 0dBi gain(Max)  
Specification:  
Modulation GFSK  
type:  
Temperature -20 °C ~ +70 °C  
Range:  
Hardware 115604-USA (V1)

Version:

Software 115604-USA (V1)

Version:

Note: /

## 2.5 TEST OPERATION MODE

Test Item	Mode No.	Description of the modes
Conducted Emission	/	/
Radiated Emission	1	Continuously Transmitting

## 8.1. LOCAL SUPPORTIVE

Name of Equipment	Manufacturer	Model	Serial Number	Note
/	/	/	/	/
<b>Cable</b>				
/	/	/	/	/

Test software:

Software version	Test level
/	3

### 3. LABORATORY AND ACCREDITATIONS

#### 3.1 LABORATORY

The tests and measurements refer to this report were performed by EMC Laboratory of GRG METROLOGY & TEST (SHENZHEN) CO., LTD

Add. : No.1301 Guanguang Road Xinlan Community, Guanlan Street, Longhua District Shenzhen, 518110, People's Republic of China

Telephone : +86-755-61180008

Fax : /

#### 3.2 ACCREDITATIONS

A2LA	Certificate Number 2861.01
------	----------------------------

#### 3.3 MEASUREMENT UNCERTAINTY

Where relevant, the following measurement uncertainty levels have been estimated for tests performed on the EUT as specified in CISPR 16-4-2:

Measurement		Frequency	Uncertainty
Radiated Emission	Horizontal	30MHz~1000MHz	4.8dB
		1GHz~26.5GHz	5.8dB
	Vertical	30MHz~1000MHz	4.8dB
		1GHz~26.5GHz	5.9dB

This uncertainty represents an expanded uncertainty factor of  $k=2$ .

**4. LIST OF USED TEST EQUIPMENT AT GRGT**

<b>Name of Equipment</b>	<b>Manufacturer</b>	<b>Model</b>	<b>Serial Number</b>	<b>Calibration Due</b>
<b>Radiated Spurious Emission&amp; Restricted bands of operation</b>				
ESPI Test Receiver	ROHDE&SCHWARZ	ESPI	101026	2020-01-09
EXA signal analyzer	Agilent	N9010A	MY52221469	2020-01-10
Bilog Antenna	Schwarzbeck	VULB 9160	9160-3401	2019-12-21
Horn Antenna	Schwarzbeck	BBHA9120	D286	2019-12-21
Active Loop Antenna	COM-POWER	AL-130	121044	2019-12-27
Amplifier	EM Electronics Corporation	EM330	060661	2019-12-21
High Noise Amplifier	Agilent	8449B	3008A02060	2019-12-21
Hygrothermograph	VICTOR	HTC-1	NA	2019-12-24
Test SW	FARAD	EZ-EMC/ CCS-3A1-CE		
<b>20 dB Bandwidth</b>				
EXA signal analyzer	Agilent	N9010A	MY52221469	2020-01-10
<b>Duty cycle</b>				
EXA signal analyzer	Agilent	N9010A	MY52221469	2020-01-10



## **5. ANTENNA REQUIREMENT**

The EUT has only one antenna. The antenna is monopole antenna.

The max gain of antenna is 0 dBi. Which accordance 15.203.is considered sufficient to comply with the provisions of this section

## 6. RADIATED SPURIOUS EMISSIONS

### 6.1. LIMITS

Except as provided in paragraph (b) of this section, the field strength of emissions from intentional radiators operated within these frequency bands shall comply with the following:

Fundamental Frequency	Field Strength of Fundamental Field Strength (mV/m)	Field Strength of Harmonics ( $\mu$ V/m)
902-928 MHz	50	500
2400 - 2483.5 MHz	50	500
5725 - 5875 MHz	50	500
24.0 - 24.25 GHz	250	2500

Except as provided elsewhere in this Subpart, the emissions from an intentional radiator shall not exceed the field strength levels specified in the following table:

Frequency (MHz)	Field Strength ( $\mu$ V/m)	Measurement Distance (m)
0.009-0.490	2400/F(kHz)	300
0.490-1.705	24000/F(kHz)	30
1.705-30.0	30	30
30-88	100*	3
88-216	150*	3
216-960	200*	3
Above 960	500	3

### 6.2. TEST PROCEDURES (please refer to measurement standard)

#### 1) Sequence of testing 9 kHz to 30 MHz

##### Setup:

- The equipment was set up to simulate a typical usage like described in the user manual or described by manufacturer.
- If the EUT is a tabletop system, a rotatable table with 0.8 m height is used.
- If the EUT is a floor standing device, it is placed on the ground.
- Auxiliary equipment and cables were positioned to simulate normal operation conditions.
- The AC power port of the EUT (if available) is connected to a power outlet below the turntable.
- The measurement distance is 3 meter.
- The EUT was set into operation.

**Pre measurement:**

- The turntable rotates from 0 ° to 315 ° using 45 ° steps.
- The antenna height is 0.8 meter.
- At each turntable position the analyzer sweeps with peak detection to find the maximum of all emissions

**Final measurement:**

- Identified emissions during the pre measurement the software maximizes by rotating the turntable position (0 ° to 360 °) and by rotating the elevation axes (0 ° to 360 °).
- The final measurement will be done in the position (turntable and elevation) causing the highest emissions with QPK detector.
- The final levels, frequency, measuring time, bandwidth, turntable position, correction factor, margin to the limit and limit will be recorded. Also a plot with the graph of the pre measurement and the limit will be stored.

**2) Sequence of testing 30 MHz to 1 GHz****Setup:**

- The equipment was set up to simulate a typical usage like described in the user manual or described by manufacturer.
- If the EUT is a tabletop system, a table with 0.8 m height is used, which is placed on the ground plane.
- If the EUT is a floor standing device, it is placed on the ground plane with insulation between both.
- Auxiliary equipment and cables were positioned to simulate normal operation conditions
- The AC power port of the EUT (if available) is connected to a power outlet below the turntable.
- The measurement distance is 3 meter.
- The EUT was set into operation.

**Pre measurement:**

- The turntable rotates from 0 ° to 315 ° using 45 ° steps.
- The antenna is polarized vertical and horizontal.
- The antenna height changes from 1 to 3 meter.
- At each turntable position, antenna polarization and height the analyzer sweeps three times in peak to find the maximum of all emissions.

**Final measurement:**

- The final measurement will be performed with minimum the six highest peaks.
- According to the maximum antenna and turntable positions of premeasurement the software maximize the peaks by changing turntable position ( $\pm 45^\circ$ ) and antenna movement between 1 and 4 meter.
- The final measurement will be done with QP detector with an EMI receiver.
- The final levels, frequency, measuring time, bandwidth, antenna height, antenna polarization, turntable angle, correction factor, margin to the limit and limit will be recorded. Also a plot with the graph of the premeasurement with marked maximum final measurements and the limit will be stored.

**3) Sequence of testing 1 GHz to 18 GHz****Setup:**

- The equipment was set up to simulate a typical usage like described in the user manual or described by manufacturer.
- If the EUT is a tabletop system, a rotatable table with 1.5 m height is used.
- If the EUT is a floor standing device, it is placed on the ground plane with insulation between both.
- Auxiliary equipment and cables were positioned to simulate normal operation conditions
- The AC power port of the EUT (if available) is connected to a power outlet below the turntable.
- The measurement distance is 3 meter.
- The EUT was set into operation.

**Pre measurement:**

- The turntable rotates from  $0^\circ$  to  $315^\circ$  using  $45^\circ$  steps.
- The antenna is polarized vertical and horizontal.
- The antenna height scan range is 1 meter to 2.5 meter.
- At each turntable position and antenna polarization the analyzer sweeps with peak detection to find the maximum of all emissions.

**Final measurement:**

- The final measurement will be performed with minimum the six highest peaks.
- According to the maximum antenna and turntable positions of premeasurement the software maximize the peaks by changing turntable position ( $\pm 45^\circ$ ) and antenna movement between 1 and 4 meter. This procedure is repeated for both antenna polarizations.
- The final measurement will be done in the position (turntable, EUT-table and antenna polarization) causing the highest emissions with Peak and Average detector.
- The final levels, frequency, measuring time, bandwidth, turntable position, EUT-table position, antenna polarization, correction factor, margin to the limit and limit will be recorded. Also a plot with the graph of the pre measurement with marked maximum final measurements and the limit will be stored.

**4) Sequence of testing above 18 GHz****Setup:**

- The equipment was set up to simulate a typical usage like described in the user manual or described by manufacturer.
- If the EUT is a tabletop system, a rotatable table with 1.5 m height is used.
- If the EUT is a floor standing device, it is placed on the ground plane with insulation between both.
- Auxiliary equipment and cables were positioned to simulate normal operation conditions
- The AC power port of the EUT (if available) is connected to a power outlet below the turntable.
- The measurement distance is 1 meter.
- The EUT was set into operation.

**Pre measurement:**

- The antenna is moved spherical over the EUT in different polarisations of the antenna.

**Final measurement:**

- The final measurement will be performed at the position and antenna orientation for all detected emissions that were found during the premeasurements with Peak and Average detector.
- The final levels, frequency, measuring time, bandwidth, correction factor, margin to the limit and limit will be recorded. Also a plot with the graph of the premeasurement and the limit will be stored.

NOTE: The resolution bandwidth of test receiver/spectrum analyzer is 1MHz and the video bandwidth is 3MHz for RMS Average (Duty cycle < 98%) for Average detection (AV) at frequency above 1GHz, then the measurement results was added to a correction factor ( $10 \log(1/\text{duty cycle})$ ).

### 6.3. TEST SETUP

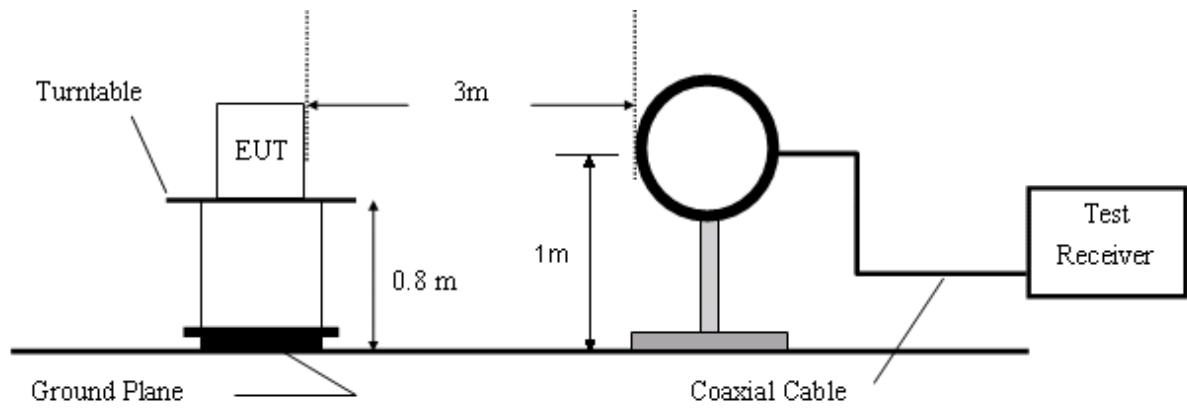

Figure 1. 9KHz to 30MHz radiated emissions test configuration

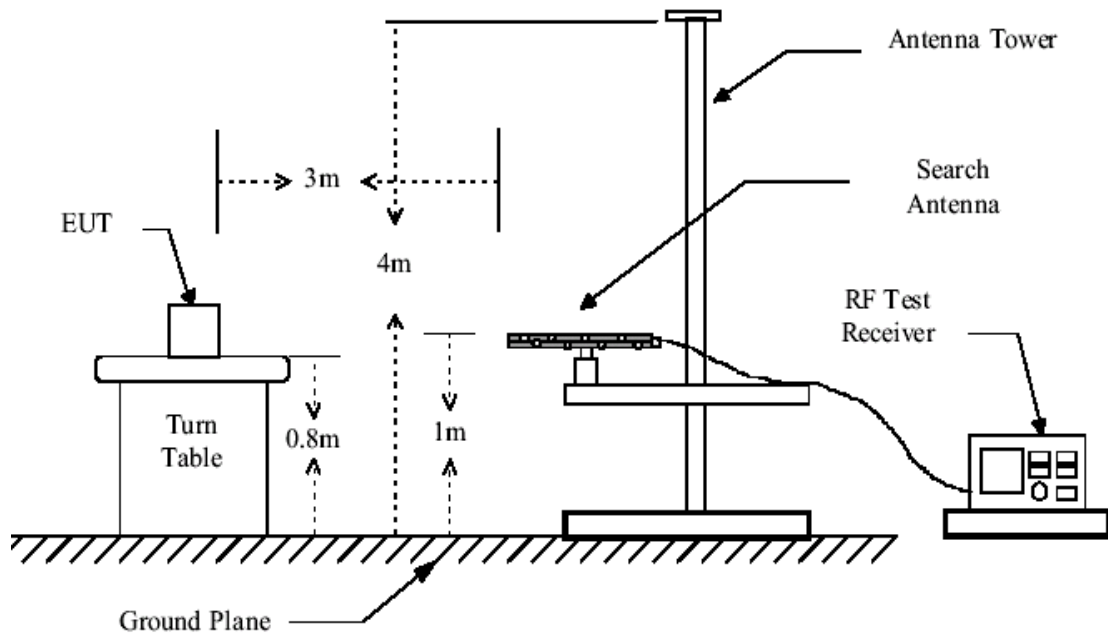

Figure 2. 30MHz to 1GHz radiated emissions test configuration

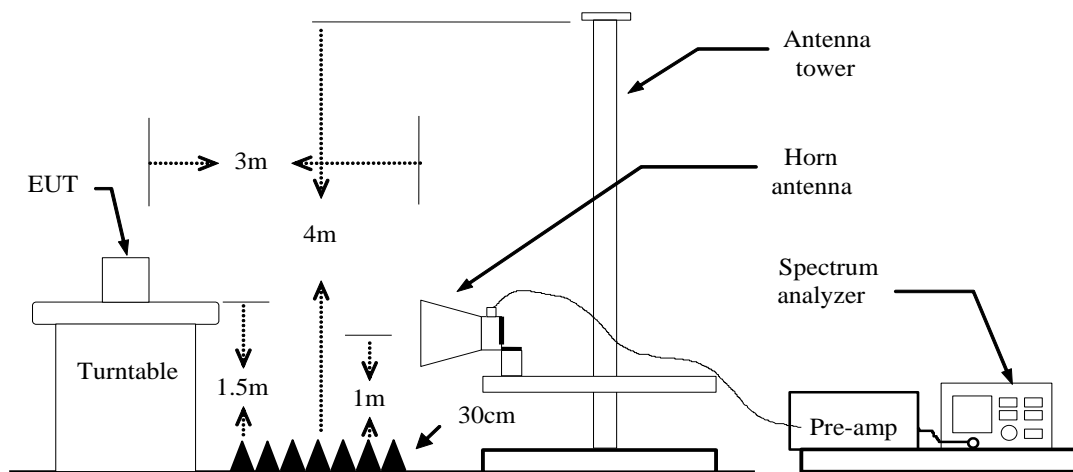

Figure 3. Above 1GHz radiated emissions test configuration

## 6.4. DATA SAMPLE

### 30MHz to 1GHz

No.	Frequency	Reading	Correct	Result	Limit	Margin	Remark	Pole
	(MHz)	(dBuV/m)	Factor(dB/m)	(dBuV/m)	(dBuV/m)	(dB)		
xxx	xxx	37.06	-15.48	21.58	40.00	-18.42	QP	Vertical

### Above 1 GHz

No.	Frequency	Reading	Correct	Result	Limit	Margin	Remark	Pole
	(MHz)	(dBuV/m)	Factor(dB/m)	(dBuV/m)	(dBuV/m)	(dB)		
xxx	xxx	65.45	-11.12	54.33	74.00	-19.67	peak	Vertical
xxx	xxx	63.00	-11.12	51.88	54.00	-2.12	AVG	Vertical

Frequency (MHz)	= Emission frequency in MHz
Ant.Pol. (H/V)	= Antenna polarization
Reading (dBuV)	= Uncorrected Analyzer / Receiver reading
Correction Factor (dB/m)	= Antenna factor + Cable loss – Amplifier gain
Result (dBuV/m)	= Reading (dBuV) + Correction Factor (dB/m)
Limit (dBuV/m)	= Limit stated in standard
Margin (dB)	= Remark Result (dBuV/m) – Limit (dBuV/m)
Peak	= Peak Reading
QP	= Quasi-peak Reading
AVG	= Average Reading

### 6.5. TEST RESULTS

#### . 30MHz to 1GHz:

Pre-scan all channel and recorded the worst case results in this report.

Mode: TX

High channel (2477MHz)

Date: Date: 2019-03-27

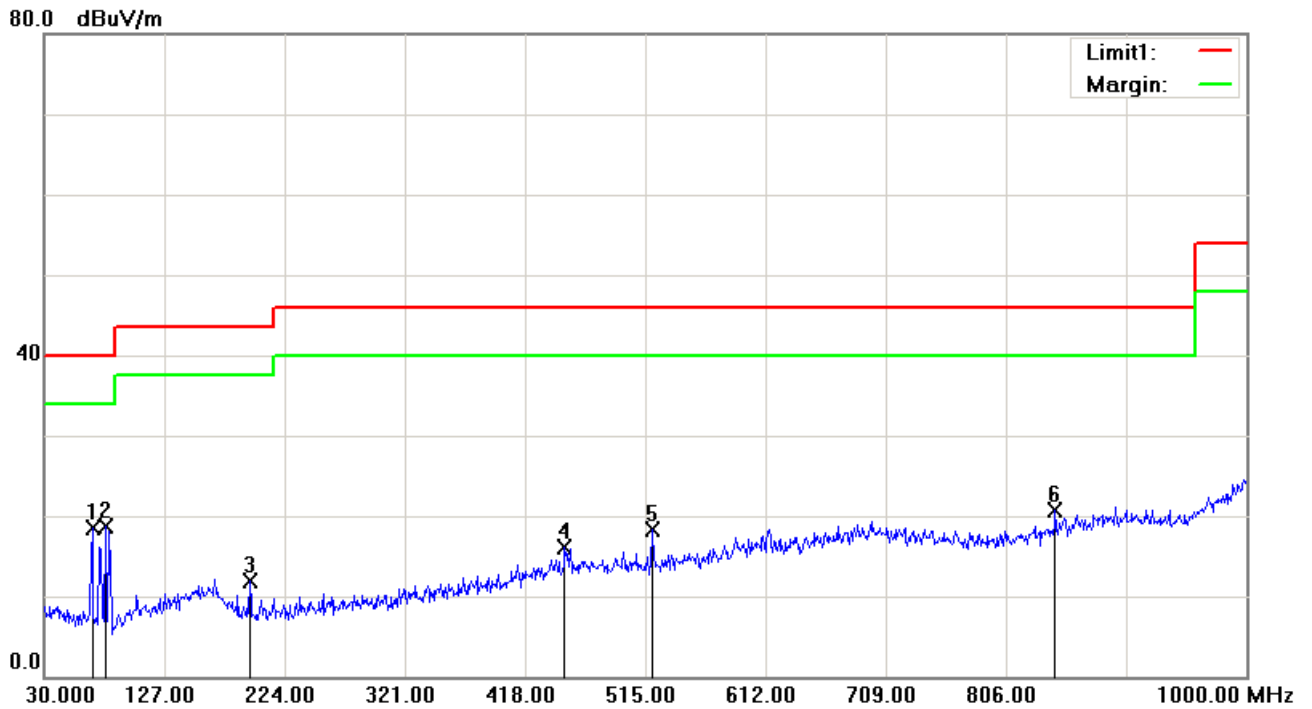

No.	Frequency (MHz)	Reading (dBuV/m)	Correct Factor(dB/m)	Result (dBuV/m)	Limit (dBuV/m)	Margin (dB)	Remark	Pole
1	68.8000	37.45	-18.85	18.60	40.00	-21.40	QP	Vertical
2	79.4700	39.16	-20.47	18.69	40.00	-21.31	QP	Vertical
3	195.8700	29.85	-18.02	11.83	43.50	-31.67	QP	Vertical
4	450.0100	27.19	-11.16	16.03	46.00	-29.97	QP	Vertical
5	520.8200	28.97	-10.58	18.39	46.00	-27.61	QP	Vertical
6	845.7700	26.13	-5.47	20.66	46.00	-25.34	QP	Vertical



Mode: TX

High channel (2477MHz)

Date: Date: 2019-03-27

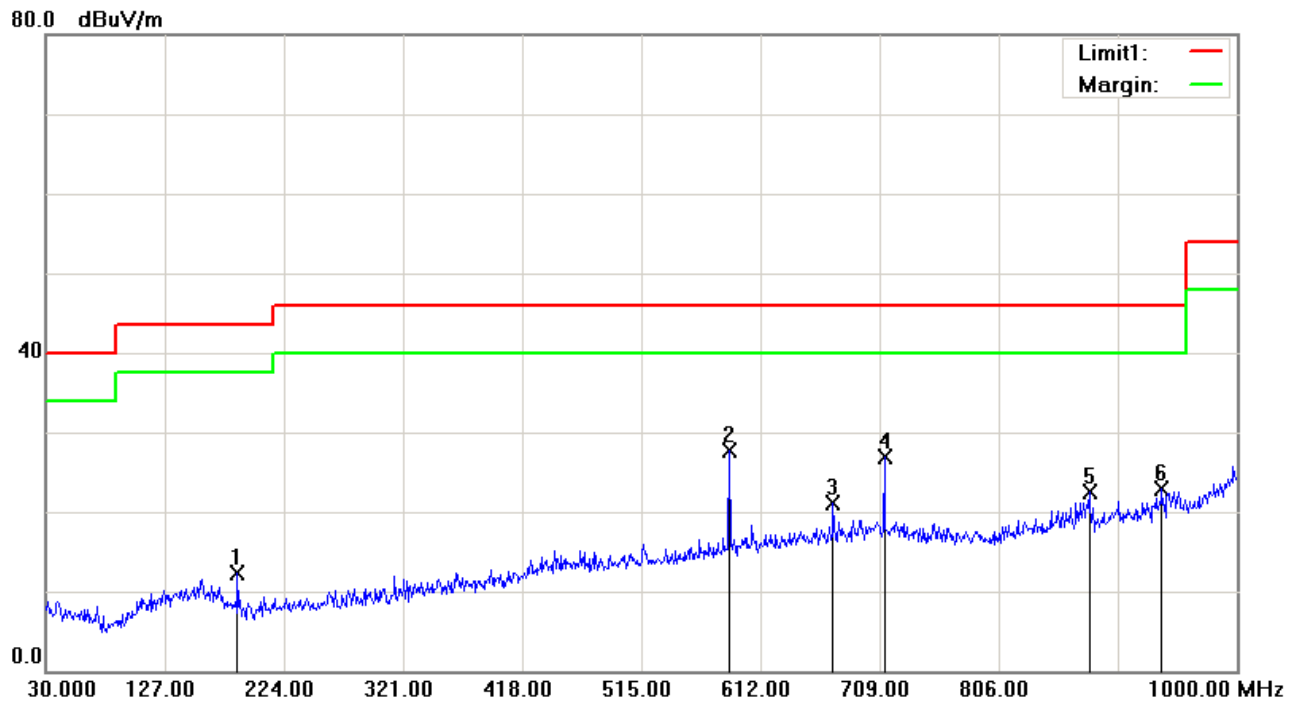

No.	Frequency (MHz)	Reading (dBuV/m)	Correct Factor(dB/m)	Result (dBuV/m)	Limit (dBuV/m)	Margin (dB)	Remark	Pole
1	186.1700	29.84	-17.58	12.26	43.50	-31.24	QP	Horizontal
2	586.7800	36.46	-8.85	27.61	46.00	-18.39	QP	Horizontal
3	671.1700	28.25	-7.06	21.19	46.00	-24.81	QP	Horizontal
4	712.8800	33.50	-6.50	27.00	46.00	-19.00	QP	Horizontal
5	879.7200	27.18	-4.63	22.55	46.00	-23.45	QP	Horizontal
6	938.8900	26.98	-4.07	22.91	46.00	-23.09	QP	Horizontal

**Remark:**

- 1 No emission found between lowest internal used/generated frequency to 30MHz.
- 2 Radiated emissions measured in frequency range from 9kHz to 1GHz were made with an instrument using peak/quasi-peak detector mode.
- 3 Quasi-peak test would be performed if the peak result were greater than the quasi-peak limit or as required by the applicant.
- 4 Measurements above show only up to 6 maximum emissions noted, or would be lesser, with " N/A " remark, if no specific emissions from the EUT are recorded (ie: margin>20dB from the applicable limit) and considered that's already beyond the background noise floor.

**Above 1GHz:**

Mode: TX

Lowest channel (2407MHz)

Date: 2019-03-29

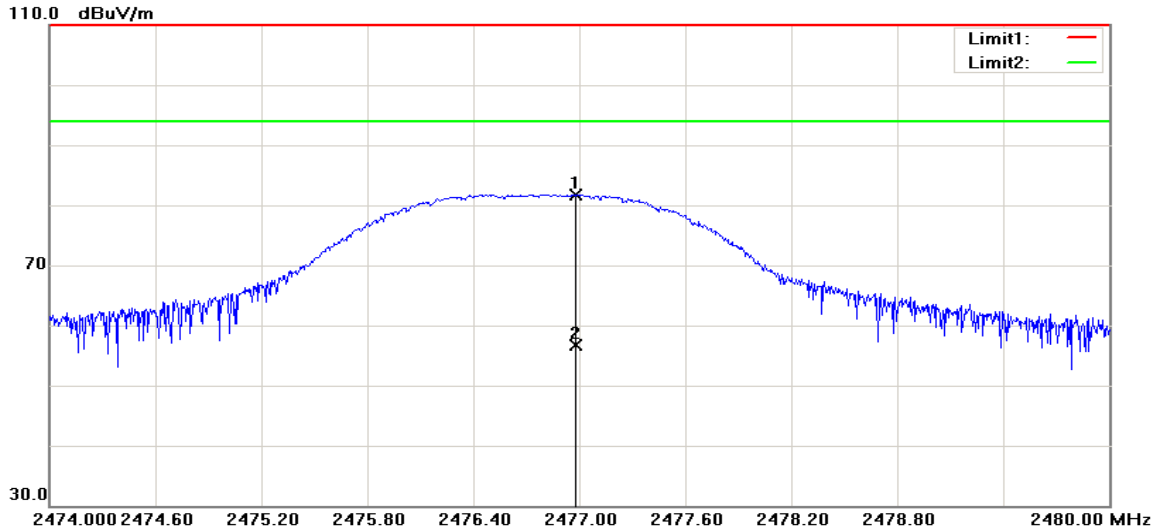

No.	Frequency (MHz)	Reading (dBuV/m)	Correct Factor (dB/m)	Result (dBuV/m)	Limit (dBuV/m)	Margin (dB)	Remark	Pole
1	2406.798	85.32	-1.44	83.88	114.00	-30.12	peak	Vertical
2	2406.798	60.19	-1.44	58.75	94.00	-35.25	AVG	Vertical

Mode: TX

Lowest channel (2407MHz)

Date: 2019-03-29

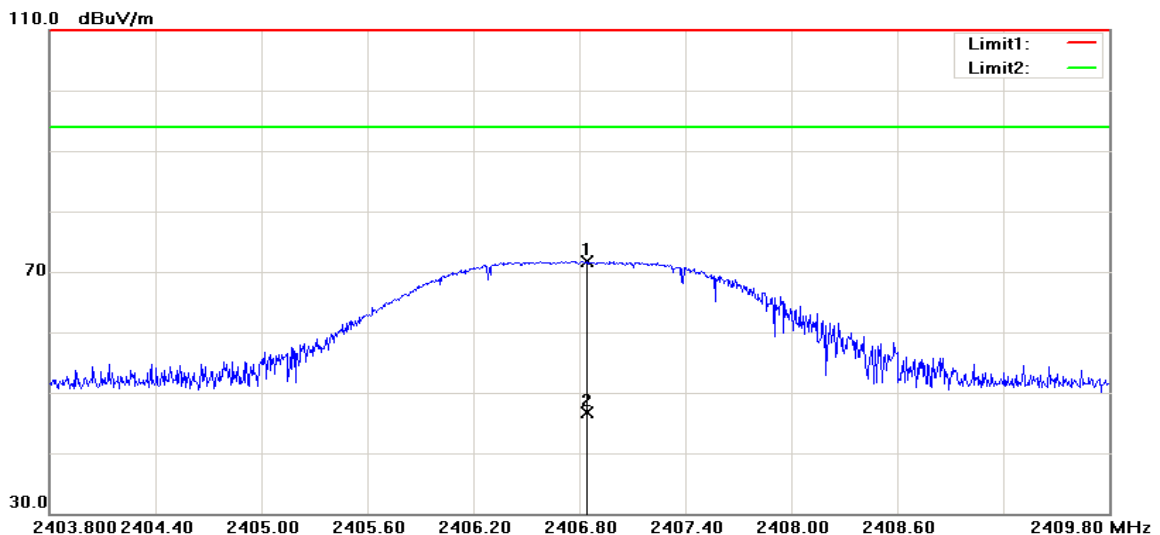

No.	Frequency (MHz)	Reading (dBuV/m)	Correct Factor (dB/m)	Result (dBuV/m)	Limit (dBuV/m)	Margin (dB)	Remark	Pole
1	2406.842	73.22	-1.44	71.78	114.00	-42.22	peak	Horizontal
2	2406.842	48.09	-1.44	46.65	94.00	-47.35	AVG	Horizontal

Remark: AVG result=Peak result-duty cycle

Mode: TX

Low channel (2407 MHz)

Date: 2019-03-28

No.	Frequency (MHz)	Reading (dBuV/m)	Correct Factor(dB/m)	Result (dBuV/m)	Limit (dBuV/m)	Margin (dB)	Remark	Pole
1	1189.000	47.03	-6.16	40.87	74.00	-33.13	peak	Vertical
2	2827.000	44.18	0.16	44.34	74.00	-29.66	peak	Vertical
3	3736.000	43.01	1.24	44.25	74.00	-29.75	peak	Vertical
4	4816.000	46.75	2.35	49.10	74.00	-24.90	peak	Vertical
5	7165.000	41.35	7.46	48.81	74.00	-25.19	peak	Vertical
6	7948.000	41.13	9.10	50.23	74.00	-23.77	peak	Vertical
7	1891.000	45.23	-3.00	42.23	74.00	-31.77	peak	Horizontal
8	3349.000	43.31	0.92	44.23	74.00	-29.77	peak	Horizontal
9	4816.000	49.95	2.35	52.30	74.00	-21.70	peak	Horizontal
10	4816.000	47.56	2.35	49.91	54.00	-4.09	AVG	Horizontal
11	6832.000	41.23	6.71	47.94	74.00	-26.06	peak	Horizontal
12	7957.000	40.48	9.11	49.59	74.00	-24.41	peak	Horizontal
13	9550.000	41.21	10.36	51.57	74.00	-22.43	peak	Horizontal

Mode: TX

Middle channel (2445MHz)

Date: 2019-03-29

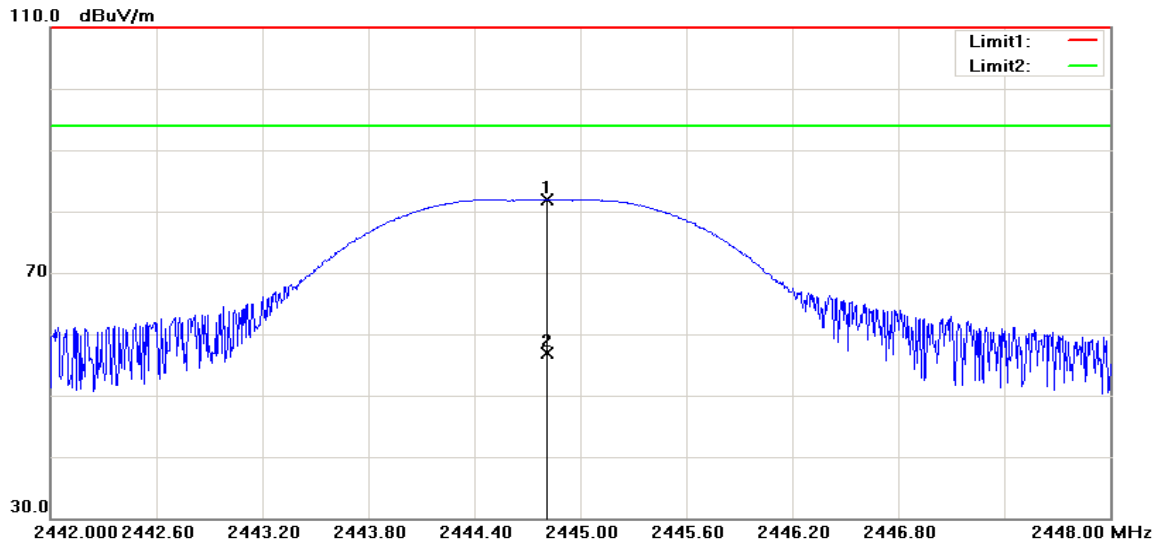

No.	Frequency (MHz)	Reading (dBuV/m)	Correct Factor(dB/m)	Result (dBuV/m)	Limit (dBuV/m)	Margin (dB)	Remark	Pole
1	2444.814	83.34	-1.36	81.98	114.00	-32.02	peak	Vertical
2	2444.814	58.21	-1.36	56.85	94.00	-37.15	AVG	Vertical

Mode: TX

Middle channel (2445MHz)

Date: 2019-03-29

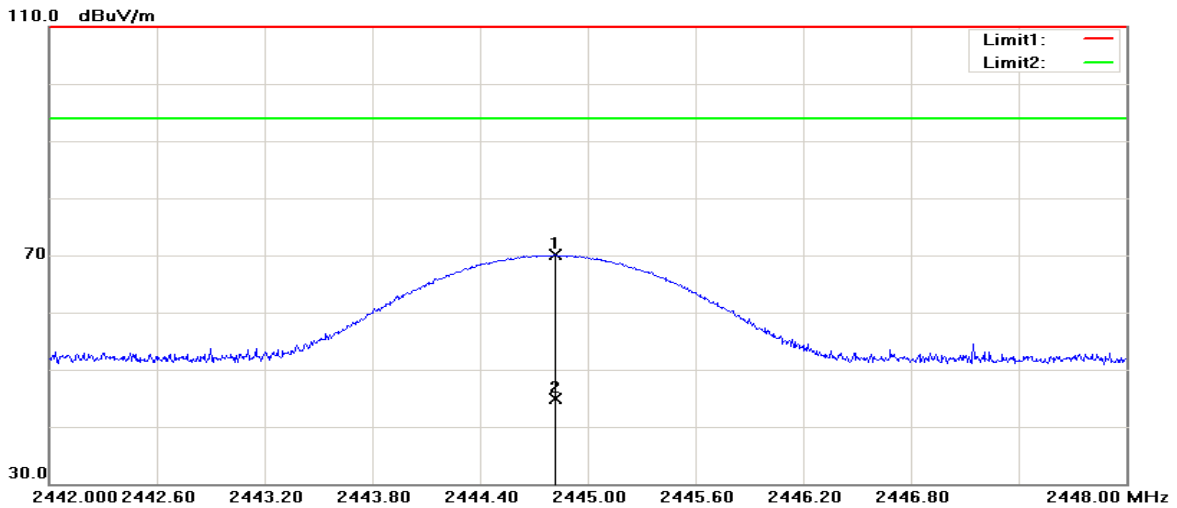

No.	Frequency (MHz)	Reading (dBuV/m)	Correct Factor(dB/m)	Result (dBuV/m)	Limit (dBuV/m)	Margin (dB)	Remark	Pole
1	2444.820	71.38	-1.36	70.02	114.00	-43.98	peak	Horizontal
2	2444.820	46.25	-1.36	44.89	94.00	-49.11	AVG	Horizontal

Remark: AVG result=Peak result-duty cycle

Mode: TX

Mid channel (2445 MHz)

Date: 2019-03-28

No.	Frequency	Reading	Correct	Result	Limit	Margin	Remark	Pole
	(MHz)	(dBuV/m)	Factor(dB/m)	(dBuV/m)	(dBuV/m)	(dB)		
1	2242.000	45.70	-1.81	43.89	74.00	-30.11	peak	Vertical
2	3079.000	43.30	0.91	44.21	74.00	-29.79	peak	Vertical
3	4429.000	42.21	2.41	44.62	74.00	-29.38	peak	Vertical
4	4888.000	45.59	2.30	47.89	74.00	-26.11	peak	Vertical
5	6517.000	40.82	6.04	46.86	74.00	-27.14	peak	Vertical
6	8632.000	41.64	9.01	50.65	74.00	-23.35	peak	Vertical
7	1918.000	45.68	-2.84	42.84	74.00	-31.16	peak	Horizontal
8	3214.000	45.24	0.92	46.16	74.00	-27.84	peak	Horizontal
9	4888.000	48.46	2.30	50.76	74.00	-23.24	peak	Horizontal
10	5644.000	41.27	4.13	45.40	74.00	-28.60	peak	Horizontal
11	7282.000	40.83	7.74	48.57	74.00	-25.43	peak	Horizontal
12	7975.000	41.06	9.15	50.21	74.00	-23.79	peak	Horizontal

Mode: TX  
 Highest channel (2477MHz)

Date: 2019-03-29

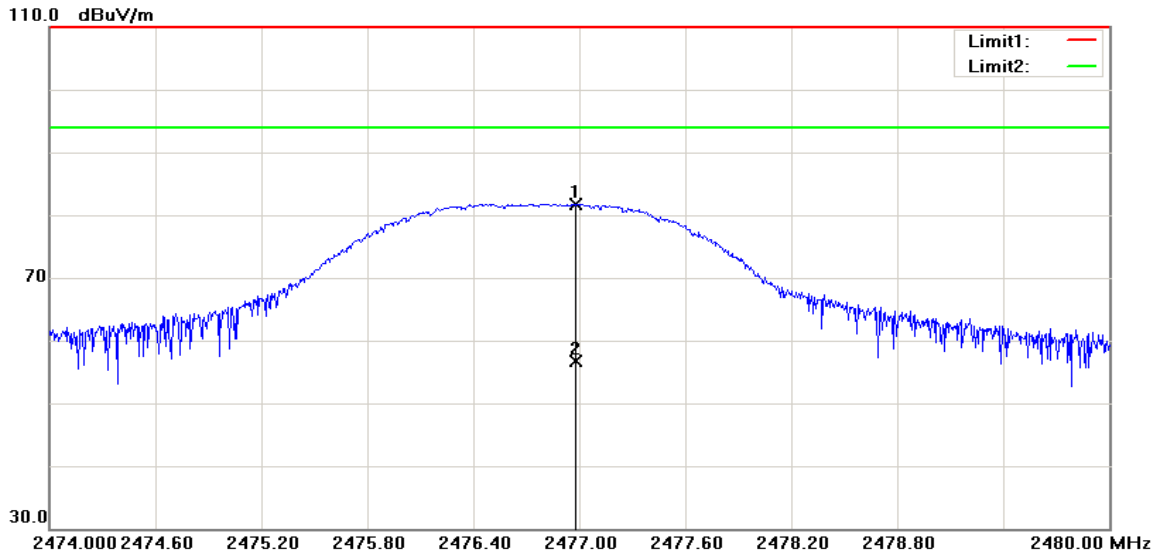

No.	Frequency	Reading	Correct	Result	Limit	Margin	Remark	Pole
	(MHz)	(dBuV/m)	Factor(dB/m)	(dBuV/m)	(dBuV/m)	(dB)		
1	2476.982	83.04	-1.30	81.74	114.00	-32.26	peak	Vertical
2	2476.982	57.91	-1.30	56.61	94.00	-37.39	AVG	Vertical

Mode: TX  
 Highest channel (2477MHz)

Date: 2019-03-29

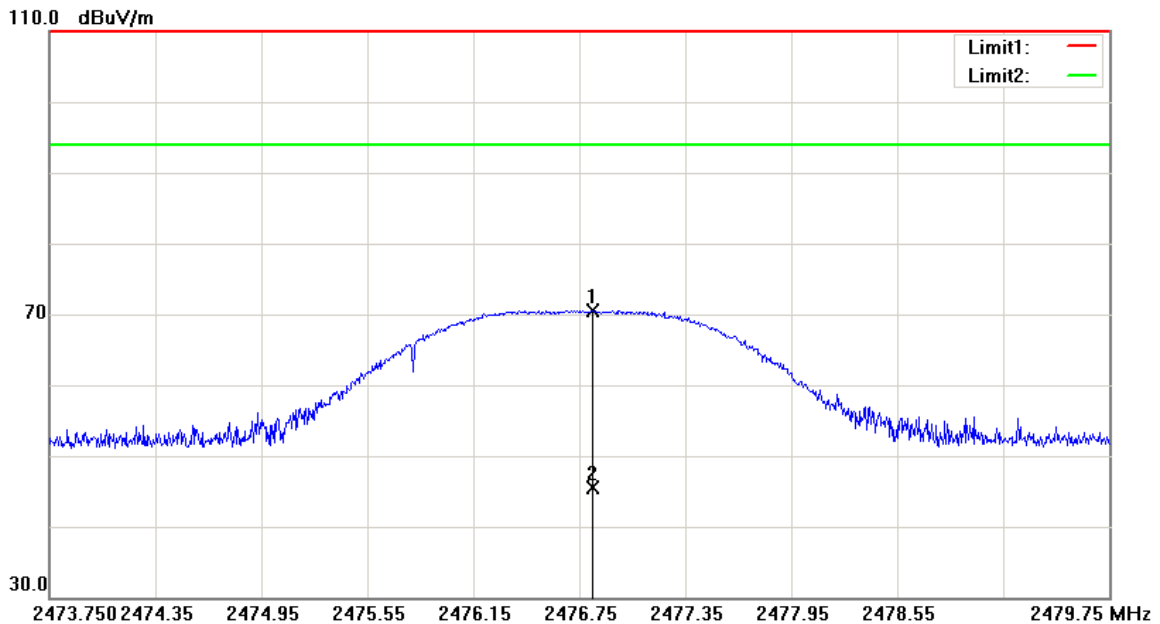

No.	Frequency	Reading	Correct	Result	Limit	Margin	Remark	Pole
	(MHz)	(dBuV/m)	Factor(dB/m)	(dBuV/m)	(dBuV/m)	(dB)		
1	2476.828	71.88	-1.30	70.58	114.00	-43.42	peak	Horizontal
2	2476.828	46.75	-1.30	45.45	94.00	-48.55	AVG	Horizontal

Remark: AVG result=Peak result-duty cycle

Mode: TX

High channel (2477 MHz)

Date: 2019-03-28

No.	Frequency (MHz)	Reading (dBuV/m)	Correct Factor(dB/m)	Result (dBuV/m)	Limit (dBuV/m)	Margin (dB)	Remark	Pole
1	1153.000	47.10	-6.26	40.84	74.00	-33.16	peak	Vertical
2	4132.000	42.40	1.84	44.24	74.00	-29.76	peak	Vertical
3	4357.000	42.46	2.28	44.74	74.00	-29.26	peak	Vertical
4	4951.000	43.63	2.26	45.89	74.00	-28.11	peak	Vertical
5	6436.000	41.55	5.92	47.47	74.00	-26.53	peak	Vertical
6	7894.000	41.26	8.99	50.25	74.00	-23.75	peak	Vertical
7	1225.000	46.83	-6.06	40.77	74.00	-33.23	peak	Horizontal
8	2512.000	45.97	-1.19	44.78	74.00	-29.22	peak	Horizontal
9	4951.000	45.54	2.26	47.80	74.00	-26.20	peak	Horizontal
10	6580.000	41.48	6.18	47.66	74.00	-26.34	peak	Horizontal
11	6850.000	41.88	6.74	48.62	74.00	-25.38	peak	Horizontal
12	7723.000	40.71	8.69	49.40	74.00	-24.60	peak	Horizontal

**Remark:**

- 1 Measuring frequencies from 1 GHz to the 10th harmonic of highest fundamental frequency.
- 2 Radiated emissions measured in frequency above 1000MHz were made with an instrument using peak/average detector mode.
- 3 Average test would be performed if the peak result were greater than the average limit or as required by the applicant.
- 4 Data of measurement within this frequency range shown " --- " in the table above means the reading of emissions are attenuated more than 20dB below the permissible limits or the field strength is too small to be measured.
- 5 Measurements above show only up to 6 maximum emissions noted, or would be lesser, with " N/A " remark, if no specific emissions from the EUT are recorded (ie: margin>20dB from the applicable limit) and considered that's already beyond the background noise floor.

## 7. 20DB BANDWIDTH

### 1.1. LIMITS

None: for reporting purpose only.

### 1.2. TEST PROCEDURES

- 1) Remove the antenna from the EUT, and then connect a low loss RF cable from antenna port to the spectrum analyzer.
- 2) Set the spectrum analyzer as RBW=100 kHz, VBW=300 kHz, Span=6MHz, Sweep = auto.
- 3) Mark the peak frequency and 20dB (upper and lower) frequency.
- 4) Repeat above procedures until all frequencies measured were complete.

### 1.3. TEST SETUP

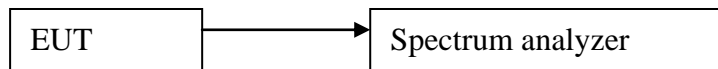

### 1.4. TEST RESULTS

Channel	Frequency (MHz)	Bandwidth (kHz)	Limit (kHz)	Test Result
Low	2407	1460	>500	PASS
Mid	2445	1252		PASS
High	2477	1202		PASS



Channel 2407MHz

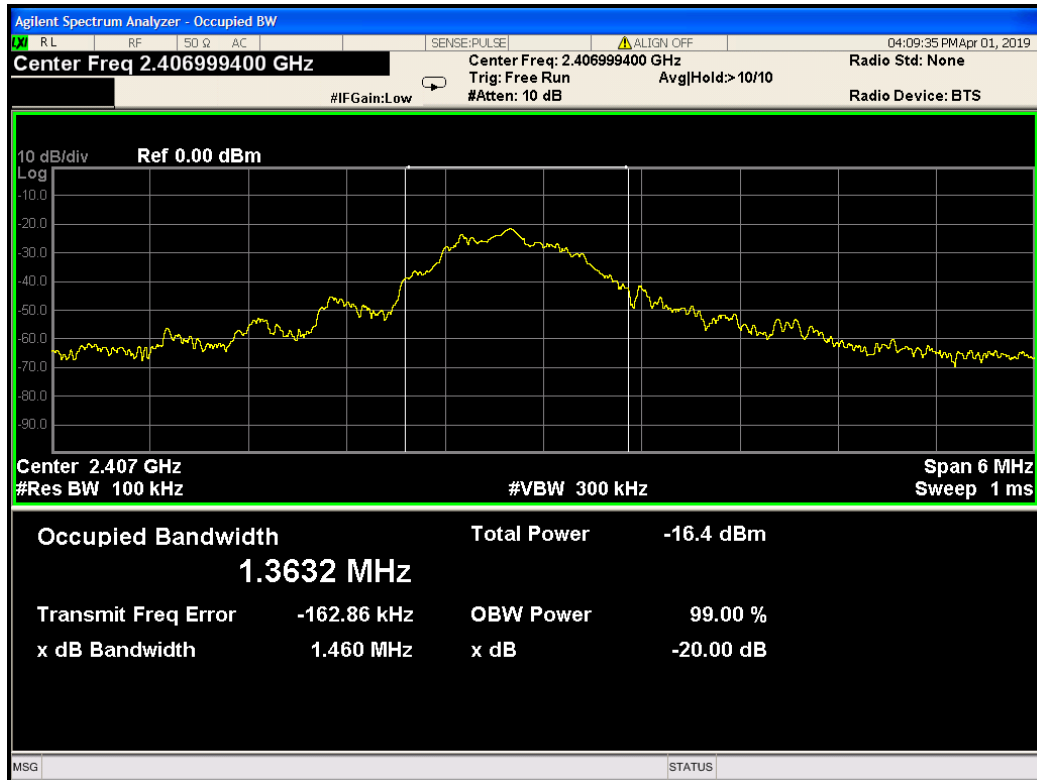

Channel 2445MHz

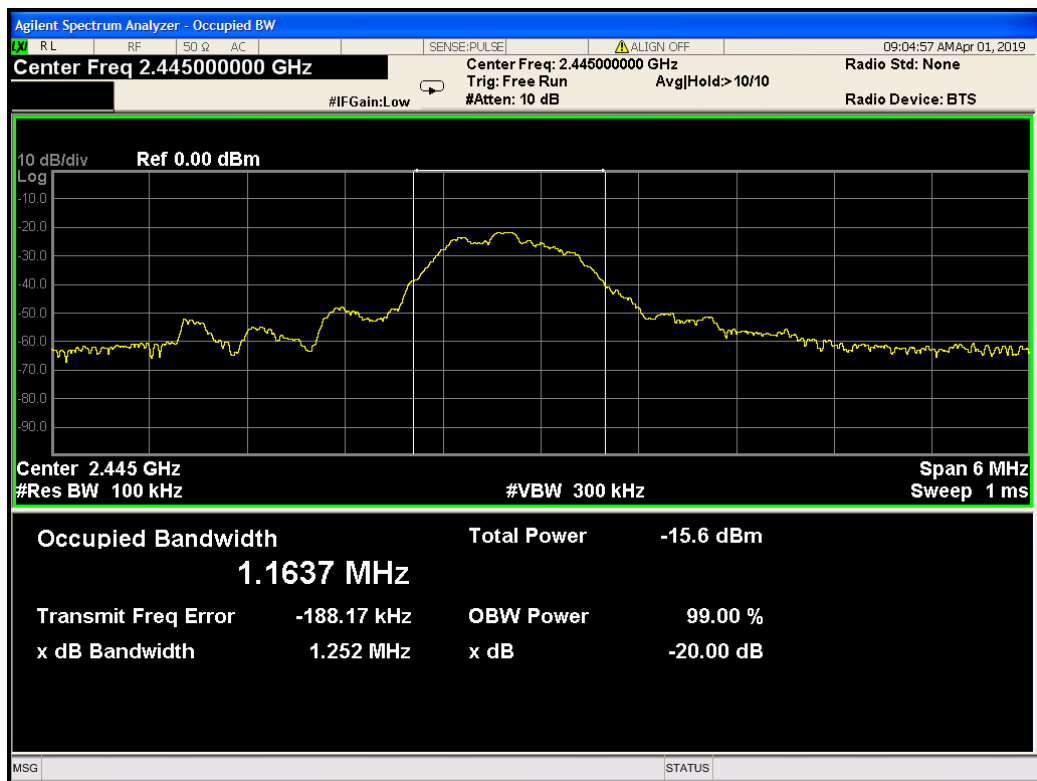

Channel 2477MHz

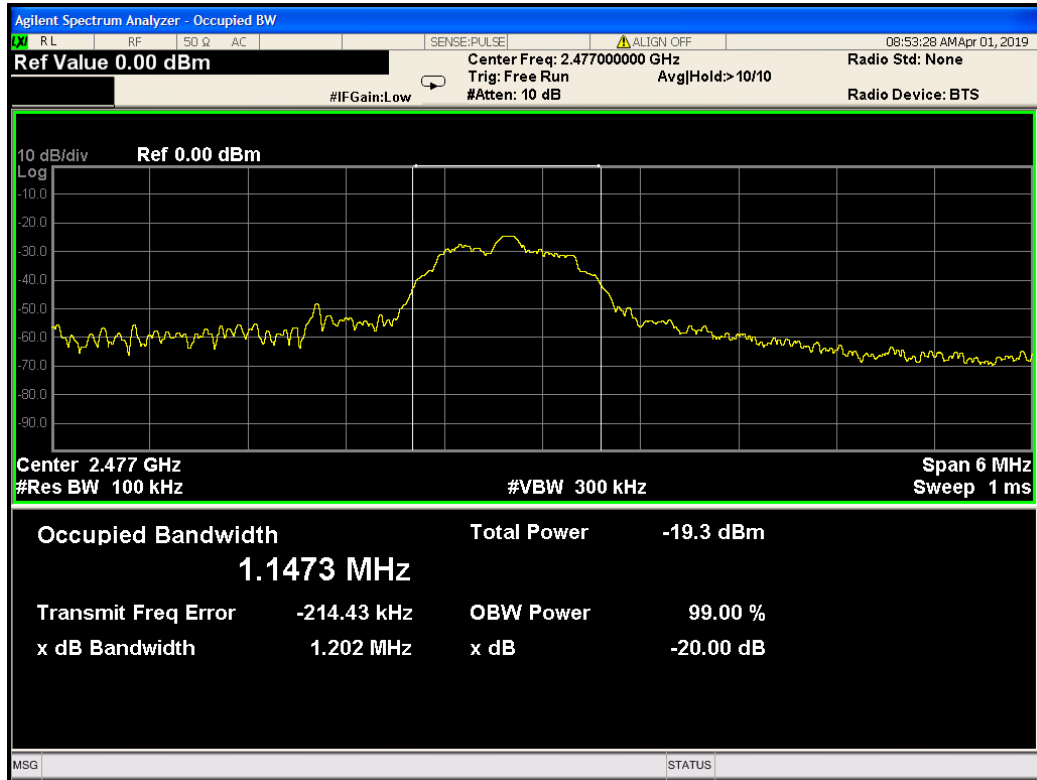

## 8. DUTY CYCLE

### 2.1. LIMITS

None: for reporting purpose only.

### 2.2. TEST PROCEDURES

- 1) Remove the antenna from the EUT and then connect a low loss RF cable from the antenna port to an EMI Test Receiver.
- 2) Set center frequency of spectrum analyzer = operating frequency.
- 3) Set the spectrum analyzer as RBW, VBW=1MHz, Span = 0Hz, Adjust Sweep = 20ms
- 4) Only need to test one channel and record data

### 2.3. TEST SETUP

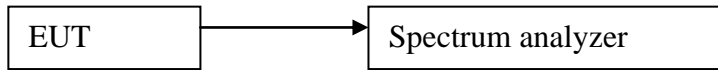

### 2.4. TEST RESULTS

$$20\text{Log} \{ 1/[\text{on}/(\text{on}+\text{off})] \} = 20\text{Log} [1/(0.504/9.1)] = 25.13\text{dB}$$

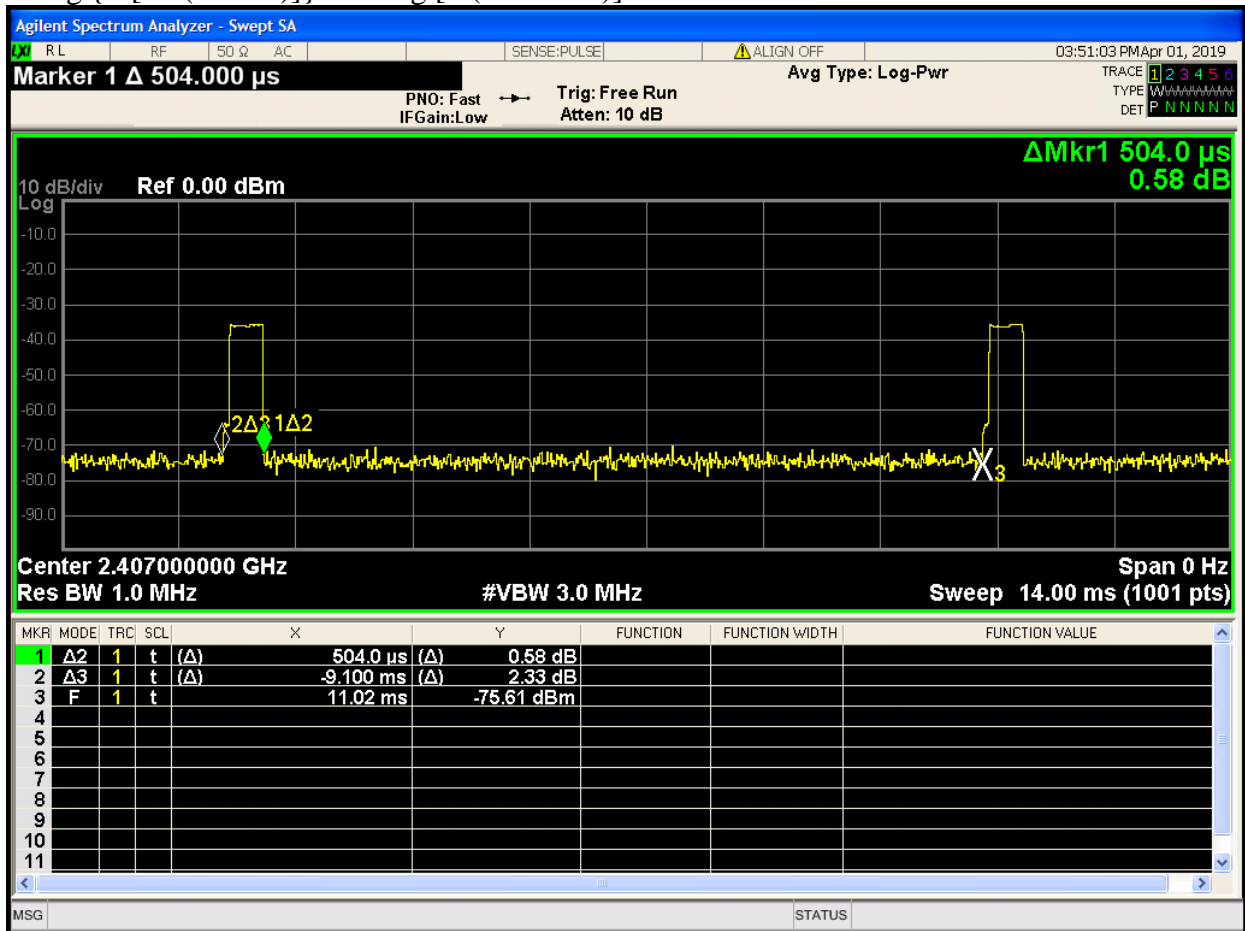

## 9. RESTRICTED BANDS OF OPERATION

### 9.1.LIMITS

§15.205(a) Except as shown in paragraph (d) of this section, only spurious emissions are permitted in any of the frequency bands listed below:

MHz	MHz	MHz	GHz
0.090 - 0.110	16.42 - 16.423	399.9 - 410	4.5 - 5.15
0.495 - 0.505	16.69475 -	608 - 614	5.35 - 5.46
2.1735 - 2.1905	16.69525	960 - 1240	7.25 - 7.75
4.125 - 4.128	16.80425 -	1300 - 1427	8.025 - 8.5
4.17725 - 4.17775	16.80475	1435 - 1626.5	9.0 - 9.2
4.20725 - 4.20775	25.5 - 25.67	1645.5 - 1646.5	9.3 - 9.5
6.215 - 6.218	37.5 - 38.25	1660 - 1710	10.6 - 12.7
6.26775 - 6.26825	73 - 74.6	1718.8 - 1722.2	13.25 - 13.4
6.31175 - 6.31225	74.8 - 75.2	2200 - 2300	14.47 - 14.5
8.291 - 8.294	108 - 121.94	2310 - 2390	15.35 - 16.2
8.362 - 8.366	123 - 138	2483.5 - 2500	17.7 - 21.4
8.37625 - 8.38675	149.9 - 150.05	2655 - 2900	22.01 - 23.12
8.41425 - 8.41475	156.52475 -	3260 - 3267	23.6 - 24.0
12.29 - 12.293	156.52525	3332 - 3339	31.2 - 31.8
12.51975 -	156.7 - 156.9	3345.8 - 3358	36.43 - 36.5
12.52025	162.0125 - 167.17	3600 - 4400	
12.57675 -	167.72 - 173.2		
12.57725	240 - 285		
13.36 - 13.41	322 - 335.4		

### 9.2.TEST PROCEDURES

- 1) The EUT is placed on a turntable, which is 1.5m above the ground plane.
- 2) The turntable shall be rotated for 360 degrees to determine the position of maximum emission level.
- 3) EUT is set 3m away from the receiving antenna, which is varied from 1m to 4m to find out the highest emission.
- 4) Set the spectrum analyzer in the following setting in order to capture the lower and upper band-edges of the emission:
  - a) PEAK: RBW=1MHz / VBW=1MHz / Sweep=AUTO
  - b) AVERAGE: RBW=1MHz / VBW=1/T / Sweep=AUTO
- 5) Repeat the procedures until all the PEAK and AVERAGE versus POLARIZATION are measured.

### 9.3.TEST SETUP

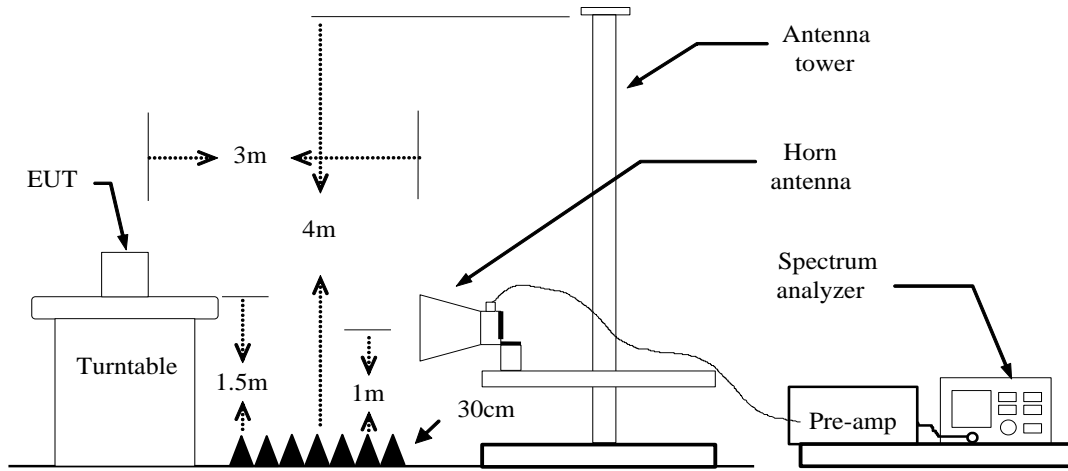

### 9.4.TEST RESULTS

#### Channel Low (2407MHz)

Detector mode: Peak

Polarity: Vertical

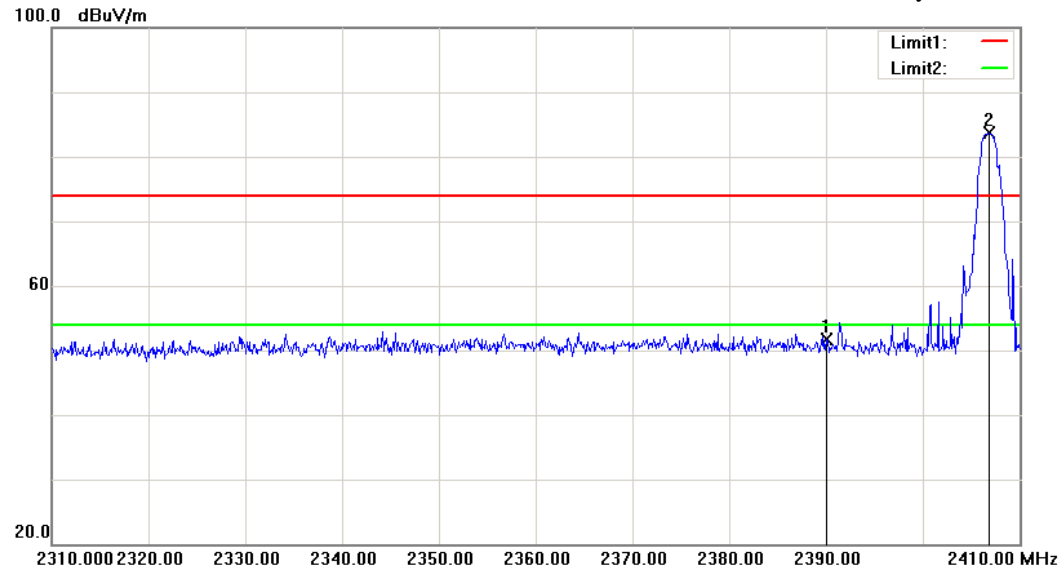

Detector mode: Average

Polarity: Vertical

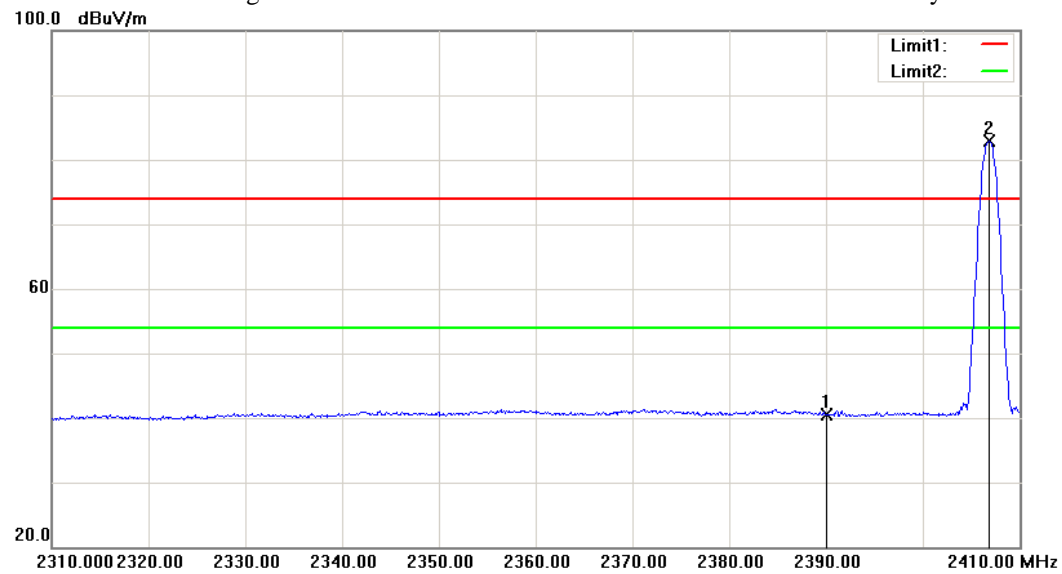

No.	Frequency MHz	Reading dBuV	Factor dB	Result dBuV/m	Limit dBuV/m	Margin dB	Remark	Pole
1	2390.000	53.20	-1.48	51.72	74.00	-22.28	Peak	Vertical
2	2406.800	85.10	-1.44	---	74.00	---	Peak	Vertical
1	2390.000	41.99	-1.48	40.51	54.00	-13.49	Average	Vertical
2	2406.900	84.26	-1.44	---	54.00	---	Average	Vertical

**Channel Low(2407MHz)**

Detector mode: Peak

Polarity: Horizontal

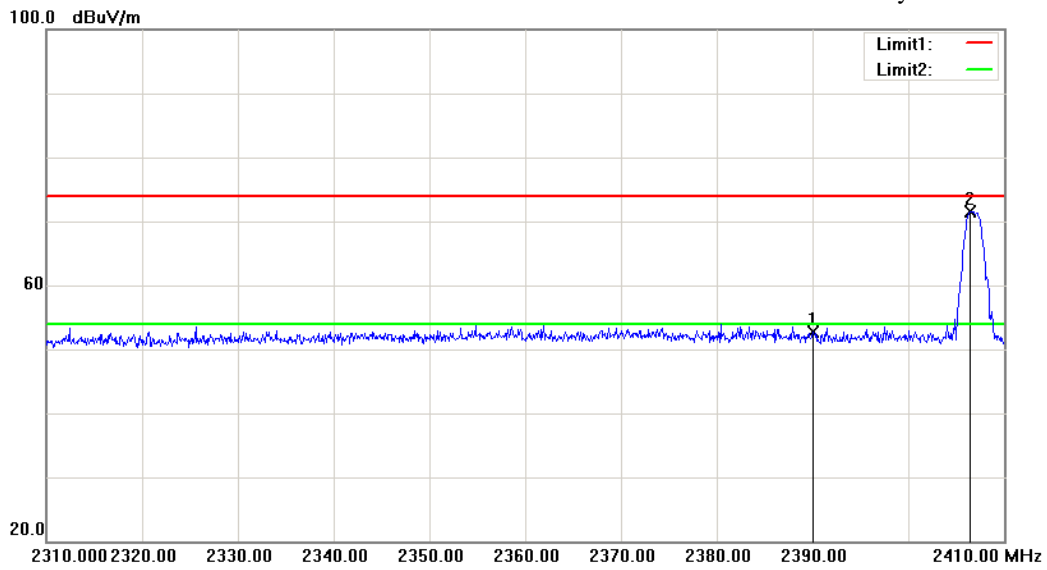

Detector mode: Average

Polarity: Horizontal

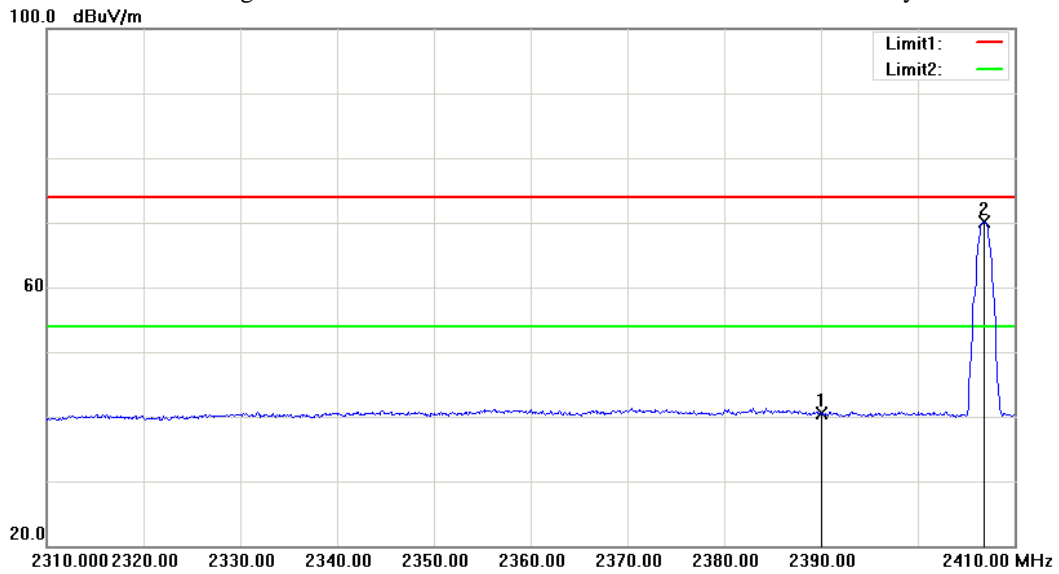

No.	Frequency MHz	Reading dBuV	Factor dB	Result dBuV/m	Limit dBuV/m	Margin dB	Remark	Pole
1	2390.000	54.15	-1.48	52.67	74.00	-21.33	Peak	Horizontal
2	2406.400	72.96	-1.44	---	74.00	---	Peak	Horizontal
1	2390.000	42.02	-1.48	40.54	54.00	-13.46	Average	Horizontal
2	2406.900	71.63	-1.44	---	54.00	---	Average	Horizontal

**Channel High(2477MHz)**

Detector mode: Peak

Polarity: Vertical

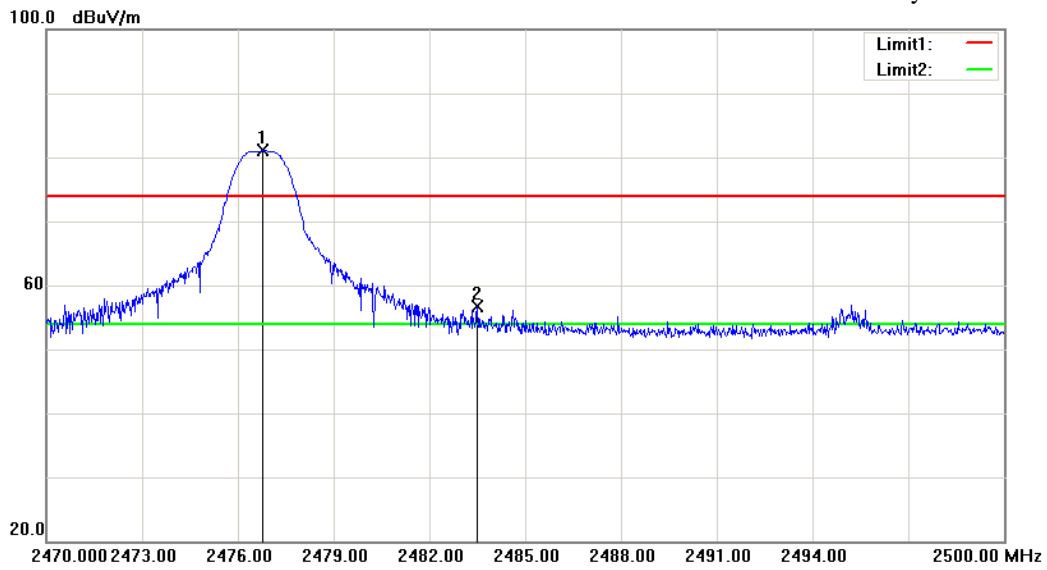

Detector mode: Average

Polarity: Vertical

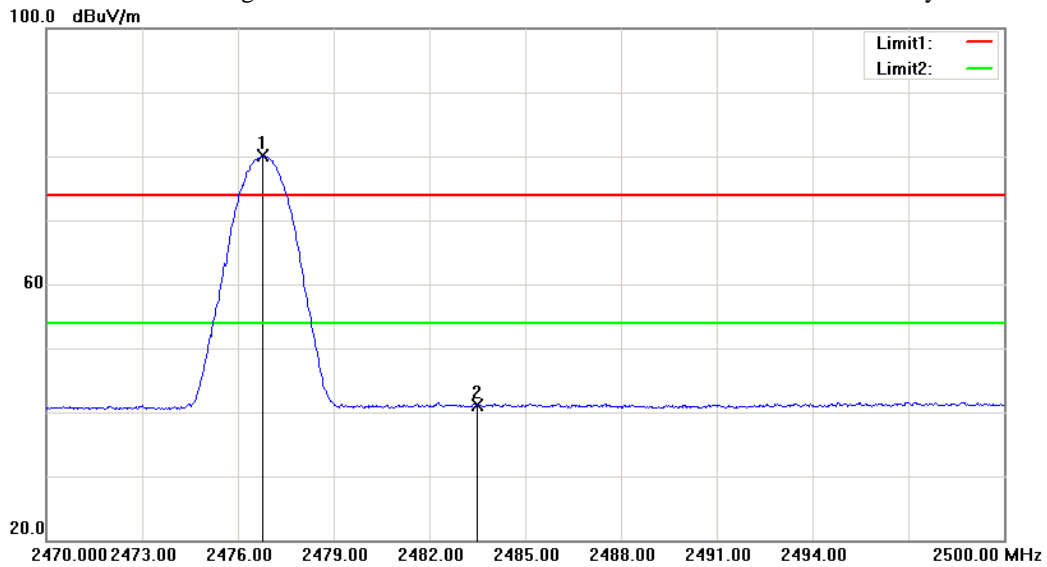

No.	Frequency MHz	Reading dBuV	Factor dB	Result dBuV/m	Limit dBuV/m	Margin dB	Remark	Pole
1	2476.780	82.38	-1.30	---	74.00	---	Peak	Vertical
2	2483.500	57.98	-1.27	56.71	74.00	-17.29	Peak	Vertical
1	2476.780	81.34	-1.30	---	54.00	---	Average	Vertical
2	2483.500	42.43	-1.27	41.16	54.00	-12.84	Average	Vertical



**Channel High(2477MHz)**

Detector mode: Peak

Polarity: Horizontal

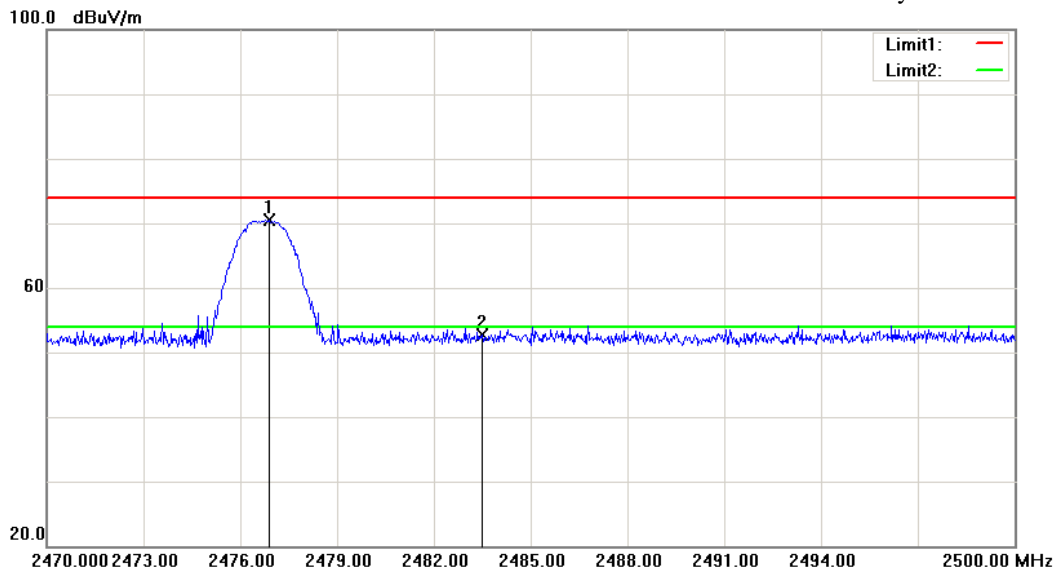

Detector mode: Average

Polarity: Horizontal

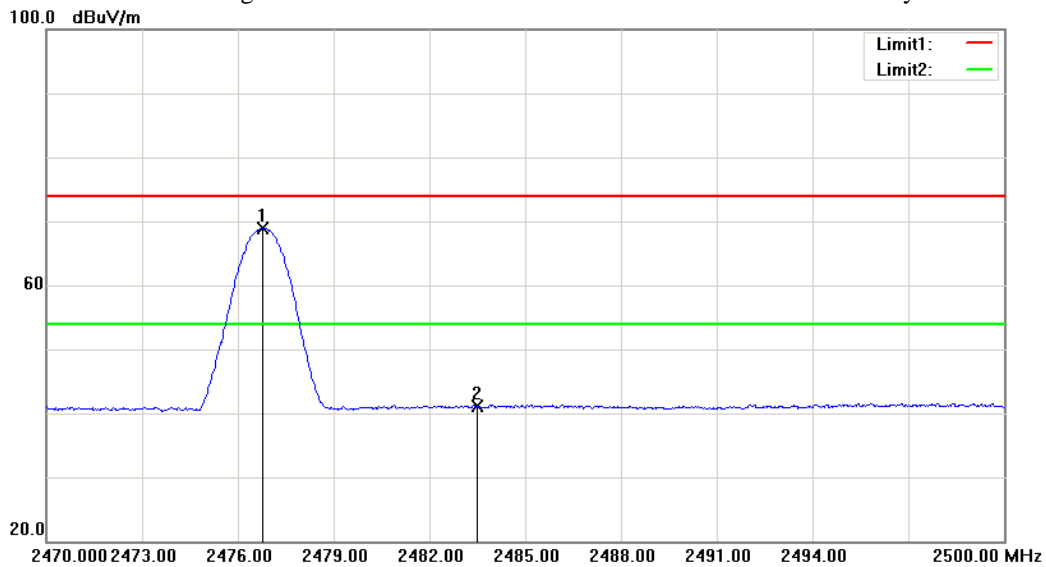

No.	Frequency MHz	Reading dBuV	Factor dB	Result dBuV/m	Limit dBuV/m	Margin dB	Remark	Pole
1	2476.900	71.74	-1.30	---	74.00	---	Peak	Horizontal
2	2483.500	54.04	-1.27	52.77	74.00	-21.23	Peak	Horizontal
1	2476.780	70.29	-1.30	---	54.00	---	Average	Horizontal
2	2483.500	42.30	-1.27	41.03	54.00	-12.97	Average	Horizontal

Remark: Max field strength in 3m distance. No any other emission which falls in restricted bands can be detected and be reported.

## APPENDIX A: PHOTOGRAPH OF THE TEST ARRANGEMENT

RSE (Below 1GHz)



RSE (Above 1GHz)



-----This is the last page of the report. -----