



FCC 47 CFR PART 15 SUBPART C

for

LIGHTSHOW PROJECTION WITH REMOTE

Model:2002017

Brand: Gemmy

Test Report Number:

C170109Z06-RP1

Issued for:

GEMMY INDUSTRIES (HK)LIMITED BVI

No.301 on 3rd Floor, East Ocean Centre, No.98 Granville Road, Kowloon, Hong Kong

Issued by:

COMPLIANCE CERTIFICATION SERVICES (SHENZHEN) INC.

**No10-1, Mingkeda Logistics Park, No.18 Huanguan South Rd.,
Guan Lan Town, Baoan District, Shenzhen, China**

TEL: 86-755-28055000

FAX: 86-755-28055221

E-Mail: service@ccssz.com

Issued Date: January 22, 2017



中国认可
国际互认
检测
TESTING
CNAS L4818



TESTING CERT #2861.01

Note: This report shall not be reproduced except in full, without the written approval of Compliance Certification Services (Shenzhen) Inc. This document may be altered or revised by Compliance Certification Services (Shenzhen) Inc. personnel only, and shall be noted in the revision section of the document. The client should not use it to claim product endorsement by TAF, A2LA, NVLAP, NIST or any government agencies. The test result of this report relate only to the tested sample identified in this report.



Revision History

Rev.	Issue Date	Revisions	Effect Page	Revised By
00	January 22, 2017	Initial Issue	ALL	Amzula Chen



TABLE OF CONTENTS

1 TEST CERTIFICATION 4

2 EUT DESCRIPTION..... 5

3 TEST METHODOLOGY..... 6

 3.1. DESCRIPTION OF TEST MODES6

4 TEST METHODOLOGY..... 7

 4.1. EUT EXERCISE7

 4.2. FCC PART 15.205 RESTRICTED BANDS OF OPERATIONS7

5 INSTRUMENT CALIBRATION 8

6 SETUP OF EQUIPMENT UNDER TEST 8

 6.1. DESCRIPTION OF SUPPORT UNITS8

 6.2. CONFIGURATION OF SYSTEM UNDER TEST8

7 FACILITIES AND ACCREDITATIONS 9

 7.1. FACILITIES9

 7.2. ACCREDITATIONS.....9

 7.3. MEASUREMENT UNCERTAINTY10

8 FCC PART 15.249 REQUIREMENTS 11

 8.1. 20DB BANDWIDTH.....11

 8.2. BAND EDGES MEASUREMENT14

 8.3. POWER LINE CONDUCTED EMISSIONS MEASUREMENT21

 8.4. SPURIOUS EMISSIONS MEASUREMENT24



1 TEST CERTIFICATION

Product	LIGHTSHOW PROJECTION WITH REMOTE
Model	2002017
Brand	Gemmy
Tested	January 9~January 22, 2017
Applicant	GEMMY INDUSTRIES (HK)LIMITED BVI No.301 on 3rd Floor, East Ocean Centre, No.98 Granville Road, Kowloon, Hong Kong
Manufacturer	ZAIXING ELECTRONIC (SHENZHEN)CO., LTD. 3#, 1st Road Yang Yong, Shapu Community, Songgang, Baoan District, Shenzhen City, Guangdong Province, China. DynaTech Co. Ltd 259-261 Xincheng Road, Qiaotou Town, Dongguan, Guangdong, China

APPLICABLE STANDARDS	
STANDARD	TEST RESULT
FCC 47 CFR Part 15 Subpart C	No non-compliance noted
DEVIATION FROM APPLICABLE STANDARD	
None	

We hereby certify that:

The above equipment was tested by Compliance Certification Services (Shenzhen) Inc. The test data, data evaluation, test procedures, and equipment configurations shown in this report were made in accordance with the procedures given in ANSI C63.10 and the energy emitted by the sample EUT tested as described in this report is in compliance with the requirements of FCC Rules Part 15.207, 15.209, 15.249.

The test results of this report relate only to the tested sample EUT identified in this report.

Approved by:

Reviewed by:

Sunday Hu
Supervisor of EMC Dept.
Compliance Certification Service (Shenzhen)
Inc.

Ruby Zhang
Supervisor of Report Dept.
Compliance Certification Service (Shenzhen)
Inc.



2 EUT DESCRIPTION

Product	LIGHTSHOW PROJECTION WITH REMOTE
Model Number	2002017
Brand Name	Gemmy
Model Discrepancy	N/A
Identify Number	C170109Z06-RP1
EUT Power Rating	DC3V supplied by the battery
Frequency Range	2407MHz~2477MHz
Transmit Power	85.25dBuV/m (Max.)(Peak) 69.60dBuV/m (Max.)(AVG)
Modulation Technique	GFSK
Number of Channels	3 Channel
Antenna Specification	PCB antenna with 2.1dBi gain (Max)
Temperature Range	-20°C ~ +58°C
Hardware Version	88972 -USA (V1)
Software Version	88972 -USA (V1)

Note: 1. The sample selected for test was engineering sample that approximated to production product and was provided by manufacturer.

2. This submittal(s) (test report) is intended for **FCC ID: GPO2002017** filing to comply with Section 15.207, 15.209 and 15.249 of the FCC Part 15, Subpart C Rules.



3 TEST METHODOLOGY

3.1. DESCRIPTION OF TEST MODES

The EUT has been tested under operating condition.

Button was used to control the EUT for staying in continuous transmitting mode manually.

The following test mode(s) were scanned during the preliminary test below 1G:

Test Item	Test mode	Worse mode
Conducted Emission	Not applicable, since the EUT received DC power from Battery.	<input type="checkbox"/>
Radiated Emission	Mode 1: TX	<input checked="" type="checkbox"/>

After verification, all tests were carried out with the worst case test modes as shown below except radiated spurious emission below 1GHz, one statement for spurious below 1GHz, that only worst case was recorded and whether it was low, mid or high.



4 TEST METHODOLOGY

The tests documented in this report were performed in accordance with ANSI C63.10: 2013 and FCC CFR 47 15.207, 15.209 and 15.249.

4.1. EUT EXERCISE

The EUT was operated in the engineering mode to fix the TX frequency that was for the purpose of the measurements.

According to its specifications, the EUT must comply with the requirements of the Section 15.207, 15.209, 15.249 under the FCC Rules Part 15 Subpart C.

4.2. FCC PART 15.205 RESTRICTED BANDS OF OPERATIONS

(a) Except as shown in paragraph (d) of this section, only spurious emissions are permitted in any of the frequency bands listed below:

MHz	MHz	MHz	GHz
0.090 - 0.110	16.42 - 16.423	399.9 - 410	4.5 - 5.15
¹ 0.495 - 0.505	16.69475 - 16.69525	608 - 614	5.35 - 5.46
2.1735 - 2.1905	16.80425 - 16.80475	960 - 1240	7.25 - 7.75
4.125 - 4.128	25.5 - 25.67	1300 - 1427	8.025 - 8.5
4.17725 - 4.17775	37.5 - 38.25	1435 - 1626.5	9.0 - 9.2
4.20725 - 4.20775	73 - 74.6	1645.5 - 1646.5	9.3 - 9.5
6.215 - 6.218	74.8 - 75.2	1660 - 1710	10.6 - 12.7
6.26775 - 6.26825	108 - 121.94	1718.8 - 1722.2	13.25 - 13.4
6.31175 - 6.31225	123 - 138	2200 - 2300	14.47 - 14.5
8.291 - 8.294	149.9 - 150.05	2310 - 2390	15.35 - 16.2
8.362 - 8.366	156.52475 -	2483.5 - 2500	17.7 - 21.4
8.37625 - 8.38675	156.52525	2655 - 2900	22.01 - 23.12
8.41425 - 8.41475	156.7 - 156.9	3260 - 3267	23.6 - 24.0
12.29 - 12.293	162.0125 - 167.17	3332 - 3339	31.2 - 31.8
12.51975 - 12.52025	167.72 - 173.2	3345.8 - 3358	36.43 - 36.5
12.57675 - 12.57725	240 - 285	3600 - 4400	(²)
13.36 - 13.41	322 - 335.4		

¹ Until February 1, 1999, this restricted band shall be 0.490-0.510 MHz.

² Above 38.6

(b) Except as provided in paragraphs (d) and (e), the field strength of emissions appearing within these frequency bands shall not exceed the limits shown in Section 15.209. At frequencies equal to or less than 1000 MHz, compliance with the limits in Section 15.209 shall be demonstrated using measurement instrumentation employing a CISPR quasi-peak detector. Above 1000 MHz, compliance with the emission limits in Section 15.209 shall be demonstrated based on the average value of the measured emissions. The provisions in Section 15.35 apply to these measurements.



5 INSTRUMENT CALIBRATION

The measuring equipment, which was utilized in performing the tests documented herein, has been calibrated in accordance with the manufacturer's recommendations for utilizing calibration equipment, which is traceable to recognized national standards.

6 SETUP OF EQUIPMENT UNDER TEST

6.1. DESCRIPTION OF SUPPORT UNITS

The EUT has been tested as an independent unit together with other necessary accessories or support units. The following support units or accessories were used to form a representative test configuration during the tests.

No.	Equipment	Model No.	Serial No.	FCC ID	Brand	Data Cable	Power Cord
1	Notebook	E335	R9-WN1EF	DoC	Thinkpad	N/A	N/A

Note:

- 1) Grounding was established in accordance with the manufacturer's requirements and conditions for the intended use.

6.2. CONFIGURATION OF SYSTEM UNDER TEST

See test photographs attached in Appendix II for the actual connections between EUT and support equipment.



7 FACILITIES AND ACCREDITATIONS

7.1. FACILITIES

All measurement facilities used to collect the measurement data are located at

No10-1, Mingkeda Logistics Park, No.18 Huanguan South Rd., Guan Lan Town, Baoan District, Shenzhen China

The sites are constructed in conformance with the requirements of ANSI C63.10, ANSI C63.7 and CISPR Publication 22. All receiving equipment conforms to CISPR Publication 16-1, "Radio Interference Measuring Apparatus and Measurement Methods."

7.2. ACCREDITATIONS

Our laboratories are accredited and approved by the following accreditation body according to ISO/IEC 17025.

USA	A2LA
China	CNAS

The measuring facility of laboratories has been authorized or registered by the following approval agencies.

USA	FCC
Japan	VCCI (C-4815,R-4320,T-2317, G-10624)
Canada	INDUSTRY CANADA

Copies of granted accreditation certificates are available for downloading from our web site, <http://www.ccpsz.com>



7.3. MEASUREMENT UNCERTAINTY

Where relevant, the following measurement uncertainty levels have been estimated for tests performed on the EUT as specified in CISPR 16-4-2:

Parameter	Uncertainty
Radiated Emission, 30 to 200 MHz Test Site : 966(2)	+/-3.6880dB
Radiated Emission, 200 to 1000 MHz Test Site : 966(2)	+/-3.6695dB
Radiated Emission, 1 to 8 GHz	+/-5.1782dB
Radiated Emission, 8 to 18 GHz	+/-5.2173dB
Conducted Emissions	+/-3.6836dB
Band Width	178kHz
Peak Output Power MU	+/-1.906dB
Band Edge MU	+/-0.182dB
Channel Separation MU	416.178Hz
Duty Cycle MU	0.054ms
Frequency Stability MU	226Hz

This uncertainty represents an expanded uncertainty expressed at approximately the 95% confidence level using a coverage factor of $k=2$.

The measured result is above (below) the specification limit by a margin less than the measurement uncertainty; it is therefore not possible to state compliance based on the 95% level of confidence. However, the result indicates that compliance (non-compliance) is more probable than non-compliance) with the specification limit.



8 FCC PART 15.249 REQUIREMENTS

8.1. 20DB BANDWIDTH

None; for reporting purpose only.

MEASUREMENT EQUIPMENT USED

Name of Equipment	Manufacturer	Model	Serial Number	Last Calibration	Due Calibration
Spectrum Analyzer	Agilent	N9010A	MY55370330	02/21/2016	02/20/2017

Remark: Each piece of equipment is scheduled for calibration once a year.

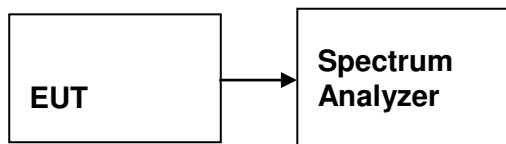

TEST CONFIGURATION

TEST PROCEDURE

1. Place the EUT on the table and set it in the transmitting mode.
2. Remove the antenna from the EUT, then connect a low loss RF cable from antenna port to the spectrum analyzer.
3. Set the spectrum analyzer as RBW=100 kHz, VBW=300 kHz, Span=6MHz, Sweep = auto.
4. Mark the peak frequency and 20dB (upper and lower) frequency.
5. Repeat until all the test channels are investigated.

TEST RESULTS

No non-compliance noted

Test Data

Channel	Frequency (MHz)	Bandwidth (kHz)	Limit (kHz)	Margin (kHz)
Low	2407	1070	>500	PASS
Mid	2445	1019		PASS
High	2477	1251		PASS



Test plot

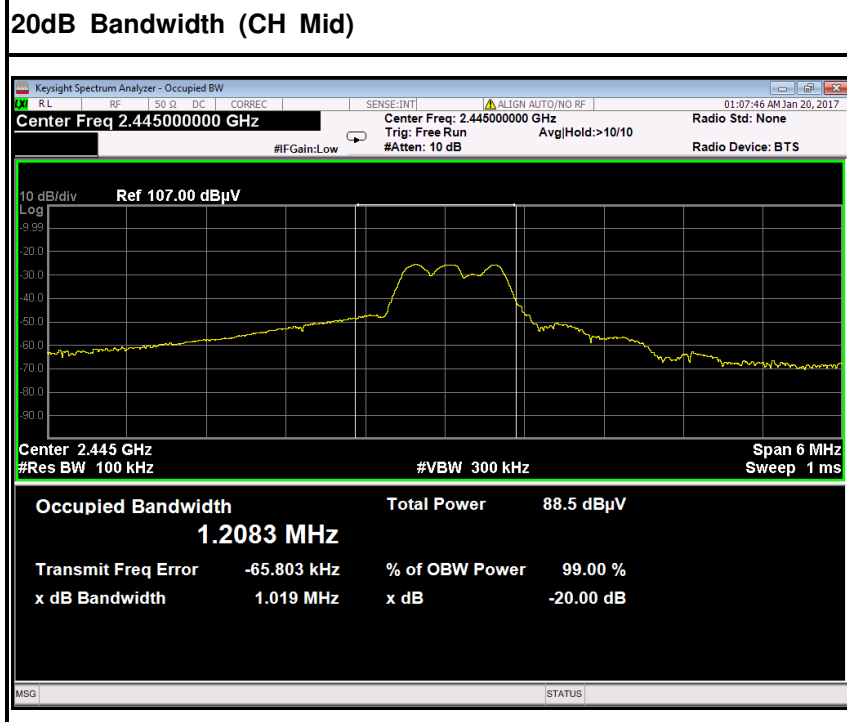
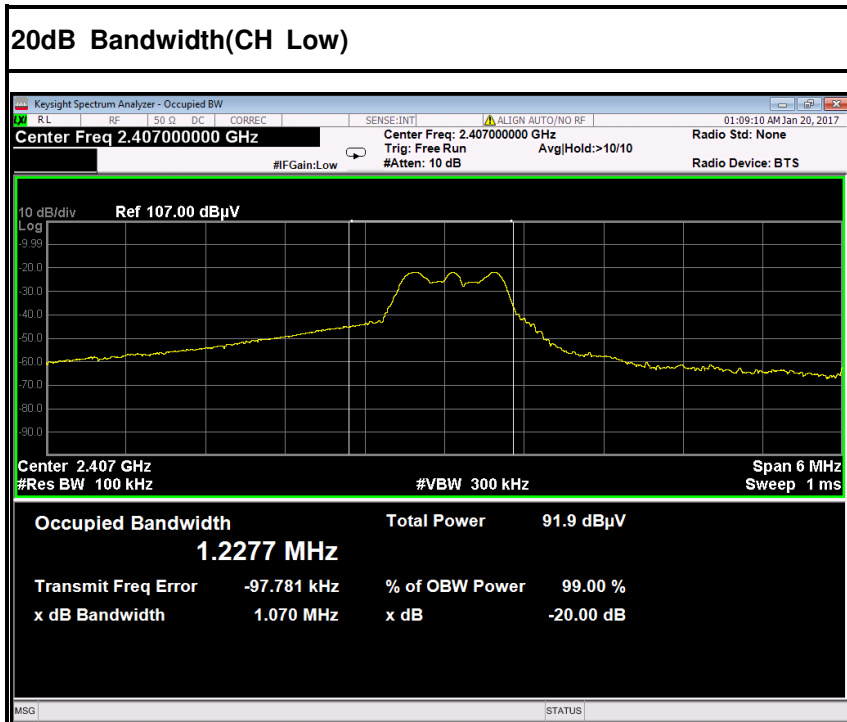

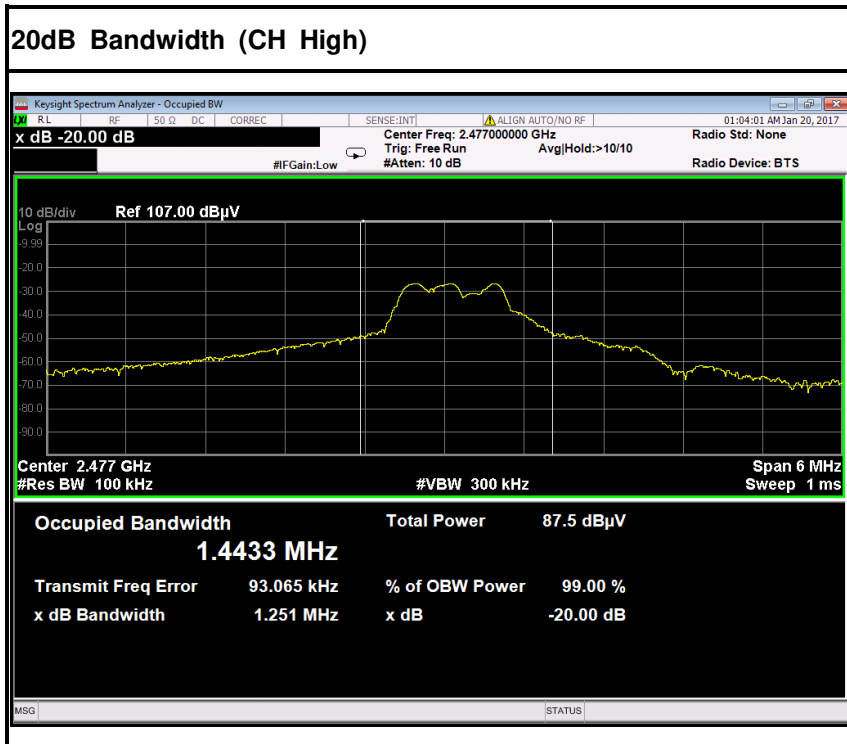



8.2. BAND EDGES MEASUREMENT

LIMIT

1. In the above emission table, the tighter limit applies at the band edges.

Frequency (Hz)	Field Strength ($\mu\text{V/m}$ at 3-meter)	Field Strength ($\text{dB}\mu\text{V/m}$ at 3-meter)
30-88	100	40
88-216	150	43.5
216-960	200	46
Above 960	500	54

2. As shown in Section 15.35(b), for frequencies above 1000 MHz, the above field strength limits in paragraphs (a) and (b) of this section are based on average limits. However, the peak field strength of any emission shall not exceed the maximum permitted average limits specified above by more than 20 dB under any condition of modulation. For point-to-point operation under paragraph (b) of this section, the peak field strength shall not exceed 2500 millivolts/meter at 3 meters along the antenna azimuth.
3. As shown in Section 15.249(d) Emissions radiated outside of the specified frequency bands, except for harmonics, shall be attenuated by at least 50 dB below the level of the fundamental or to the general radiated emission limits in Section 15.209, whichever is the lesser attenuation.



MEASUREMENT EQUIPMENT USED

Radiated Emission Test Site 966 (2)					
Name of Equipment	Manufacturer	Model Number	Serial Number	Last Calibration	Due Calibration
PSA Series Spectrum Analyzer	Agilent	E4446A	US44300399	02/21/2016	02/20/2017
EMI TEST RECEIVER	ROHDE&SCHWARZ	ESCI	100783	02/21/2016	02/20/2017
Amplifier	MITEQ	AM-1604-3000	1123808	03/18/2016	03/17/2017
High Noise Amplifier	Agilent	8449B	3008A01838	02/21/2016	02/20/2017
Board-Band Horn Antenna	Schwarzbeck	BBHA 9170	9170-497	02/28/2016	02/27/2017
Bilog Antenna	SCHAFFNER	CBL6143	5082	02/21/2016	02/20/2017
Horn Antenna	SCHWARZBECK	BBHA9120	D286	02/28/2016	02/27/2017
Loop Antenna	COM-POWER	AL-130	121044	09/25/2016	09/24/2017
Turn Table	N/A	N/A	N/A	N.C.R	N.C.R
Controller	Sunol Sciences	SC104V	022310-1	N.C.R	N.C.R
Controller	CT	N/A	N/A	N.C.R	N.C.R
Temp. / Humidity Meter	Anymetre	JR913	N/A	02/21/2016	02/20/2017
Antenna Tower	SUNOL	TLT2	N/A	N.C.R	N.C.R
Test S/W	FARAD	LZ-RF / CCS-SZ-3A2			

Remark: Each piece of equipment is scheduled for calibration once a year.

TEST CONFIGURATION

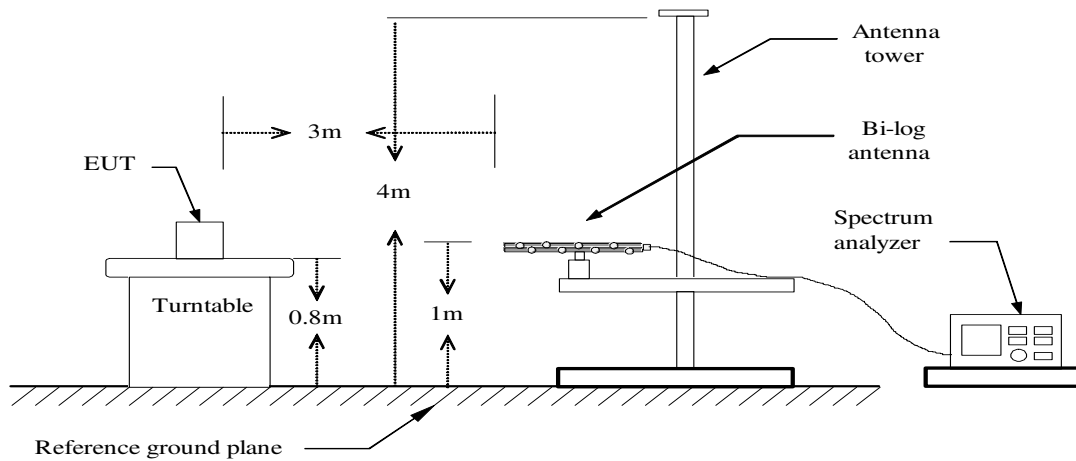



TEST PROCEDURE

1. The EUT is placed on a turntable, which is 0.8m above the ground plane.
2. The turntable shall be rotated for 360 degrees to determine the position of maximum emission level.
3. EUT is set 3m away from the receiving antenna, which is varied from 1m to 4m to find out the highest emission.
4. Set the spectrum analyzer in the following setting in order to capture the lower and upper band-edges of the emission:
 - (a) PEAK: RBW=1MHz / VBW=3MHz / Sweep=AUTO
5. Repeat the procedures until all the PEAK and AVERAGE versus POLARIZATION are measured.

TEST RESULTS

Refer to attach spectrum analyzer data chart.

Note: The test result for the plot contain the correct value.



Test Data

Band Edges (Low)

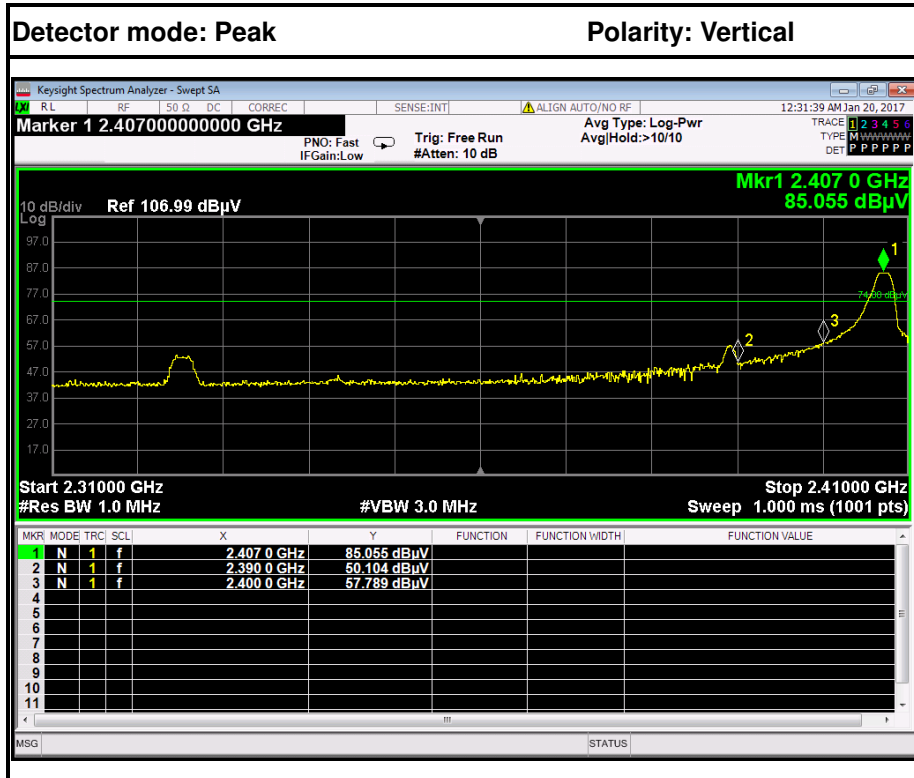

No.	Frequency (MHz)	Reading (dBu V)	Corrected (dB/m)	Result (dBu V/m)	Limit (dBu V/m)	Margin (dB)	Detector	Antenna Pole
1	2390.0000	47.24	-2.86	50.10	74.00	-23.90	Peak	Vertical
2	2390.0000	31.59	-2.86	34.45	54.00	-19.55	Average	Vertical
3	2400.0000	54.98	-2.81	57.79	74.00	-16.21	Peak	Vertical
4	2400.0000	39.33	-2.81	42.14	54.00	-11.86	Average	Vertical

Remark: $20\text{Log} \{1/[\text{on}/(\text{on}+\text{off})]\} = 20\text{Log} [1/(1.236/7.488)] = 15.65\text{dB}$;

AVG (Result) = Peak - $20\text{Log} \{1/[\text{on}/(\text{on} + \text{off})]\}$;

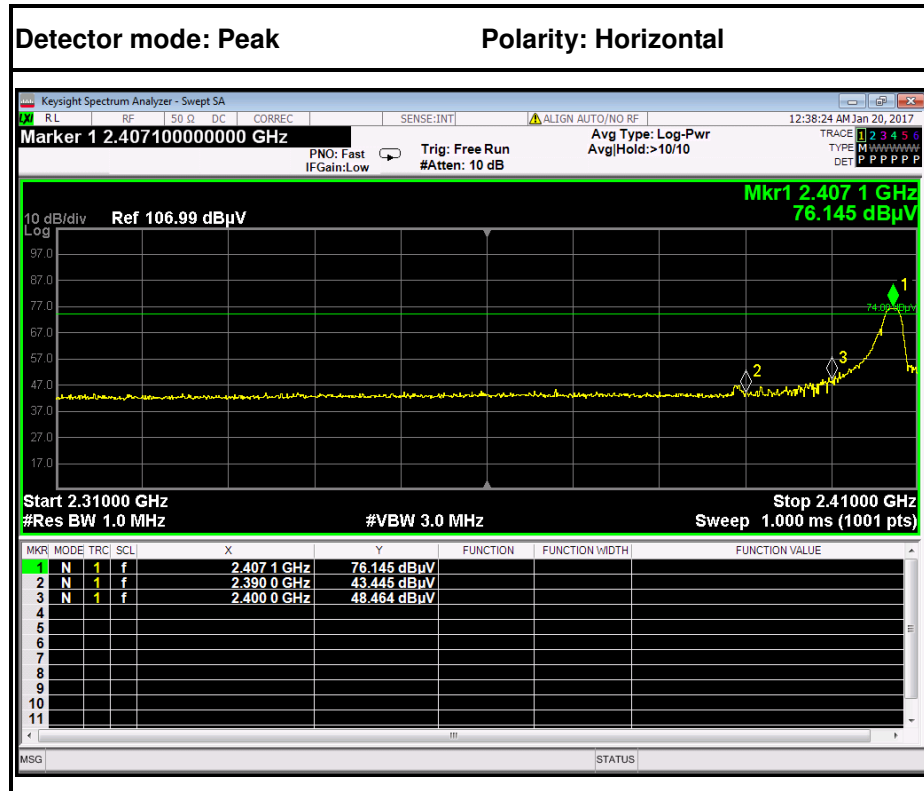

No.	Frequency (MHz)	Reading (dBuV)	Corrected (dB/m)	Result (dBuV/m)	Limit (dBuV/m)	Margin (dB)	Detector	Antenna Pole
1	2390.0000	40.59	-2.86	43.45	74.00	-30.56	Peak	Horizontal
2	2390.0000	24.94	-2.86	27.80	54.00	-26.21	Average	Horizontal
3	2400.0000	45.65	-2.81	48.46	74.00	-25.54	Peak	Horizontal
4	2400.0000	30.00	-2.81	32.81	54.00	-21.19	Average	Horizontal

Remark: $20\text{Log} \{1/[\text{on}/(\text{on}+\text{off})]\} = 20\text{Log} [1/(1.236/7.488)] = 15.65\text{dB}$;

$\text{AVG}(\text{Result}) = \text{Peak} - 20\text{Log} \{1/[\text{on}/(\text{on} + \text{off})]\}$;



Band Edges (High)

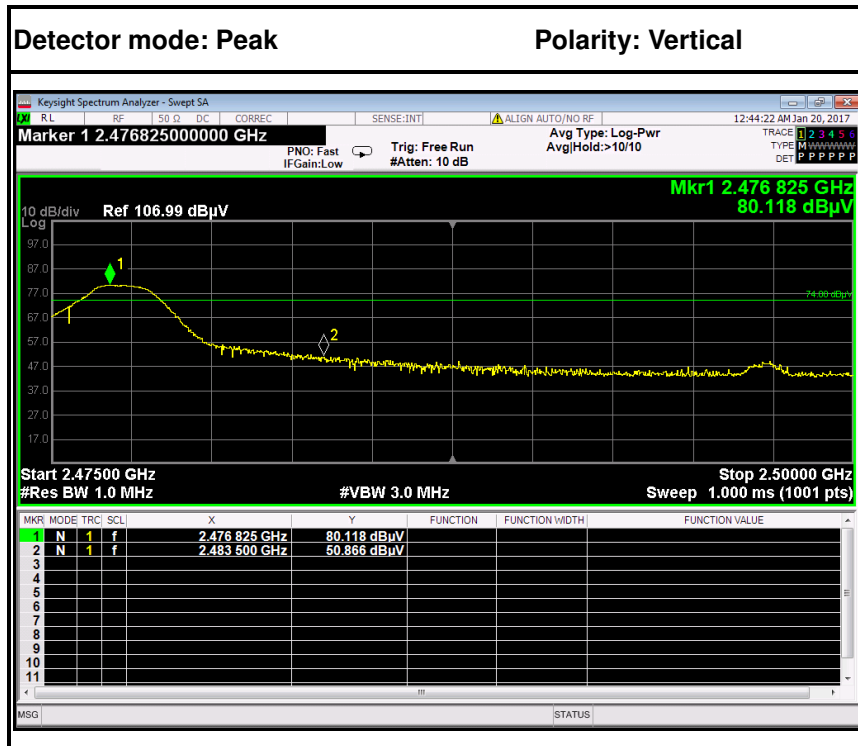

No.	Frequency (MHz)	Reading (dBu V)	Corrected (dB/m)	Result (dBu V/m)	Limit (dBu V/m)	Margin (dB)	Detector	Antenna Pole
1	2483.5000	48.52	-2.35	50.87	74.00	-23.13	Peak	Vertical
2	2483.5000	32.87	-2.35	35.22	54.00	-18.78	Average	Vertical

Remark: $20\text{Log} \{1/[\text{on}/(\text{on}+\text{off})]\} = 20\text{Log} [1/(1.236/7.488)] = 15.65\text{dB}$;
 $\text{AVG (Result)} = \text{Peak} - 20\text{Log} \{1/[\text{on}/(\text{on} + \text{off})]\}$;

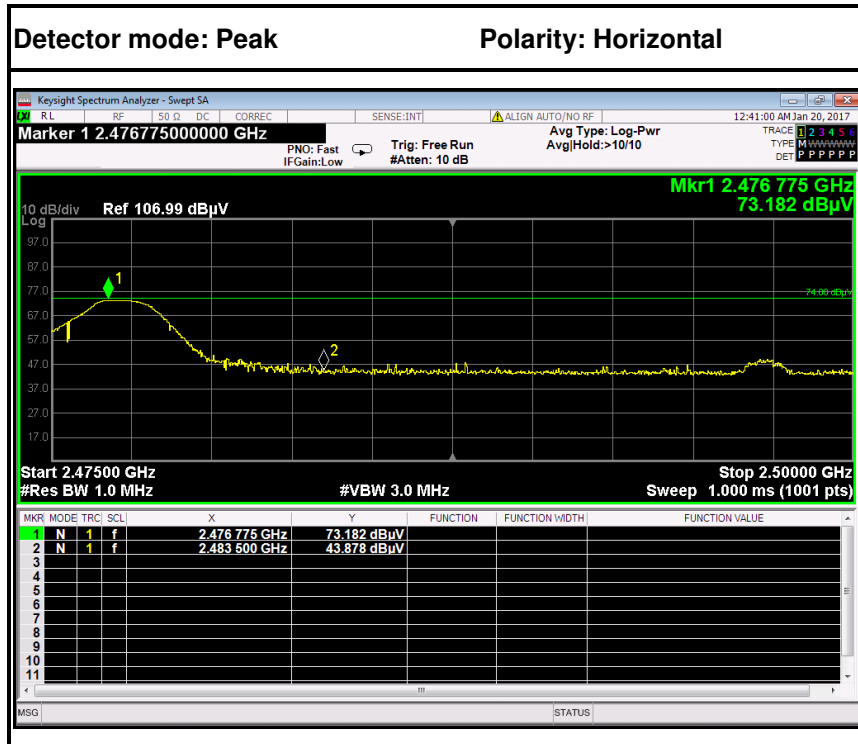

No.	Frequency (MHz)	Reading (dBU V)	Corrected (dB/m)	Result (dBU V/m)	Limit (dBU V/m)	Margin (dB)	Detector	Antenna Pole
1	2483.5000	41.53	-2.35	43.88	74.00	-30.12	Peak	Horizontal
2	2483.5000	25.88	-2.35	28.23	54.00	-25.77	Average	Horizontal

Remark: $20\text{Log} \{1/[on/(on+off)]\} = 20\text{Log} [1/(1.236/7.488)] = 15.65\text{dB}$;
 $\text{AVG (Result)} = \text{Peak} - 20\text{Log} \{1/[on/(on+ off)]\}$;



8.3. POWER LINE CONDUCTED EMISSIONS MEASUREMENT

8.3.1. LIMITS OF CONDUCTED EMISSIONS MEASUREMENT

According to §15.207(a), except as shown in paragraphs (b) and (c) of this section, for an intentional radiator that is designed to be connected to the public utility (AC) power line, the radio frequency voltage that is conducted back onto the AC power line on any frequency or frequencies within the band 150 kHz to 30 MHz shall not exceed the limits in the following table, as measured using a 50 μH/50 ohms line impedance stabilization network (LISN). Compliance with the provisions of this paragraph shall be based on the measurement of the radio frequency voltage between each power line and ground at the power terminal. The lower limit applies at the boundary between the frequency ranges.

Frequency Range (MHz)	Limits (dBμV)	
	Quasi-peak	Average
0.15 to 0.50	66 to 56*	56 to 46*
0.50 to 5	56	46
5 to 30	60	50

NOTE:

- (1) The lower limit shall apply at the transition frequencies.
- (2) The limit decreases in line with the logarithm of the frequency in the range of 0.15 to 0.50 MHz.
- (3) All emanations from a class A/B digital device or system, including any network of conductors and apparatus connected thereto, shall not exceed the level of field strengths specified above.

TEST INSTRUMENTS

Conducted Emission Test Site					
Name of Equipment	Manufacturer	Model Number	Serial Number	Last Calibration	Due Calibration
EMI TEST RECEIVER	ROHDE&SCHWARZ	ESCI	100783	02/21/2016	02/20/2017
LISN(EUT)	ROHDE&SCHWARZ	ENV216	101543-WX	02/21/2016	02/20/2017
LISN	EMCO	3825/2	8901-1459	02/21/2016	02/20/2017
Temp. / Humidity Meter	VICTOR	HTC-1	N/A	02/21/2016	02/20/2017
Test S/W	FARAD	EZ-EMC/ CCS-3A1-CE			

- NOTE:**
1. The calibration interval of the above test instruments is 12 months and the calibrations are traceable to NML/ROC and NIST/USA.
 2. N.C.R = No Calibration Request.



8.3.2. TEST PROCEDURES (please refer to measurement standard)

- The EUT and Support equipment, if needed, was placed on a non-conducted table, which is 0.8m above the ground plane and 0.4m away from the conducted wall.
- The test equipment EUT installed received AC main power, through a Line Impedance Stabilization Network (LISN), which supplied power source and was grounded to the ground plane. All support equipment power received from a second LISN. The two LISNs provide 50 ohm/ 50uH of coupling impedance for the measuring instrument.
- The EUT test program was started. Emissions were measured on each current carrying line of the EUT using an EMI Test Receiver connected to the LISN powering the EUT.
- The frequency range from 150 kHz to 30 MHz was searched. The test data of the worst-case condition(s) was recorded. Emission levels under limit 20dB were not recorded.



8.3.3. TEST SETUP

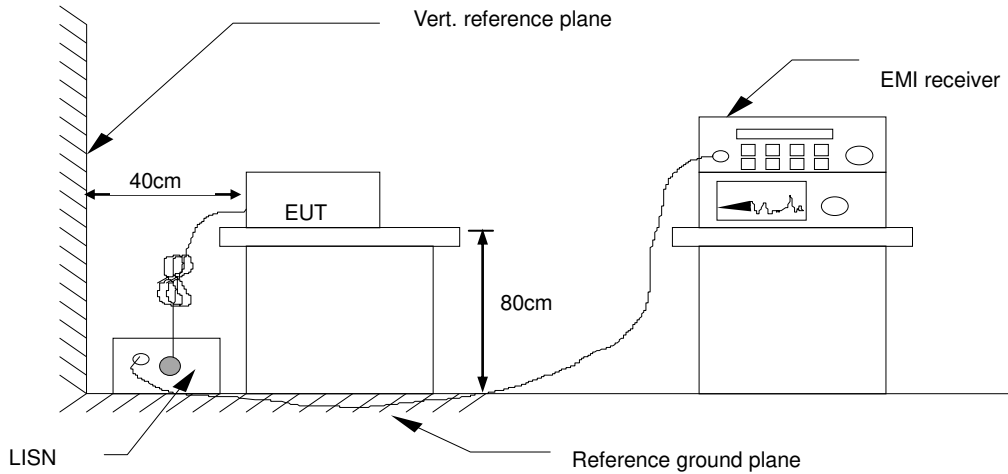

For the actual test configuration, please refer to the related item - Photographs of the Test Configuration.

8.3.4. DATA SAMPLE

Frequency (MHz)	QuasiPeak Reading (dBuV)	Average Reading (dBuV)	Correction Factor (dB)	QuasiPeak Result (dBuV)	Average Result (dBuV)	QuasiPeak Limit (dBuV)	Average Limit (dBuV)	QuasiPeak Margin (dB)	Average Margin (dB)	Remark (Pass/Fail)
X.XXXX	32.69	25.65	11.52	44.21	37.17	65.78	55.79	-21.57	-18.62	Pass

- Factor = Insertion loss of LISN + Cable Loss
- Result = Quasi-peak Reading/ Average Reading + Factor
- Limit = Limit stated in standard
- Margin = Result (dBuV) – Limit (dBuV)

8.3.5. TEST RESULTS

Not applicable, since the EUT received DC power from Battery.



8.4. SPURIOUS EMISSIONS MEASUREMENT

8.4.1. LIMITS OF RADIATED EMISSIONS MEASUREMENT

1. In the section 15.249(a):

Except as provided in paragraph (b) of this section, the field strength of emissions from intentional radiators operated within these frequency bands shall comply with the following:

Fundamental Frequency	Field Strength of Fundamental Field Strength (mV/m)	Field Strength of Harmonics ($\mu\text{V/m}$)
902-928 MHz	50	500
2400 - 2483.5 MHz	50	500
5725 - 5875 MHz	50	500
24.0 - 24.25 GHz	250	2500

2. Except as provided elsewhere in this Subpart, the emissions from an intentional radiator shall not exceed the field strength levels specified in the following table:

Frequency (MHz)	Field Strength ($\mu\text{V/m}$)	Measurement Distance (m)
30-88	100*	3
88-216	150*	3
216-960	200*	3
Above 960	500	3

Remark: Except as provided in paragraph (g), fundamental emissions from intentional radiators operating under this Section shall not be located in the frequency bands 54-72 MHz, 76-88 MHz, 174-216 MHz or 470-806 MHz. However, operation within these frequency bands is permitted under other sections of this Part, e.g., Sections 15.231 and 15.241.

3. In the above emission table, the tighter limit applies at the band edges.

Frequency (Hz)	Field Strength ($\mu\text{V/m}$ at 3-meter)	Field Strength ($\text{dB}\mu\text{V/m}$ at 3-meter)
30-88	100	40
88-216	150	43.5
216-960	200	46
Above 960	500	54

**8.4.2. TEST INSTRUMENTS**

Radiated Emission Test Site 966 (2)						
Name of Equipment	Manufacturer	Model Number	Serial Number	Last Calibration	Due Calibration	
PSA Series Spectrum Analyzer	Agilent	E4446A	US44300399	02/21/2016	02/20/2017	
EMI TEST RECEIVER	ROHDE&SCHWARZ	ESCI	100783	02/21/2016	02/20/2017	
Amplifier	MITEQ	AM-1604-3000	1123808	03/18/2016	03/17/2017	
High Noise Amplifier	Agilent	8449B	3008A01838	02/21/2016	02/20/2017	
Board-Band Horn Antenna	Schwarzbeck	BBHA 9170	9170-497	02/28/2016	02/27/2017	
Bilog Antenna	SCHAFFNER	CBL6143	5082	02/21/2016	02/20/2017	
Horn Antenna	SCHWARZBECK	BBHA9120	D286	02/28/2016	02/27/2017	
Loop Antenna	COM-POWER	AL-130	121044	09/25/2016	09/24/2017	
Turn Table	N/A	N/A	N/A	N.C.R	N.C.R	
Controller	Sunol Sciences	SC104V	022310-1	N.C.R	N.C.R	
Controller	CT	N/A	N/A	N.C.R	N.C.R	
Temp. / Humidity Meter	Anymetre	JR913	N/A	02/21/2016	02/20/2017	
Antenna Tower	SUNOL	TLT2	N/A	N.C.R	N.C.R	
Test S/W	FARAD	LZ-RF / CCS-SZ-3A2				

NOTE: 1. The calibration interval of the above test instruments is 12 months and the calibrations are traceable to NML/ROC and NIST/USA.

2. N.C.R = No Calibration Required.

8.4.3. Measuring Instruments and Setting

The following table is the setting of spectrum analyzer and receiver.

Spectrum Parameter	Setting
Attenuation	Auto
Start Frequency	1000 MHz
Stop Frequency	10th carrier harmonic
RB / VB (Emission in restricted band)	1MHz / 1MHz for Peak, 1 MHz / 10Hz for Average
RB / VB (Emission in non-restricted band)	1MHz / 1MHz for Peak, 1 MHz / 10Hz for Average



Receiver Parameter	Setting
Attenuation	Auto
Start ~ Stop Frequency	9kHz~150kHz / RB 200Hz for QP/AVG
Start ~ Stop Frequency	150kHz~30MHz / RB 9kHz for QP/AVG
Start ~ Stop Frequency	30MHz~1000MHz / RB 100kHz for QP

8.4.4 TEST PROCEDURE (please refer to measurement standard)

1) Sequence of testing 9 kHz to 30 MHz

Setup:

- The equipment was set up to simulate a typical usage like described in the user manual or described by manufacturer.
- If the EUT is a tabletop system, a rotatable table with 0.8 m height is used.
- If the EUT is a floor standing device, it is placed on the ground.
- Auxiliary equipment and cables were positioned to simulate normal operation conditions.
- The AC power port of the EUT (if available) is connected to a power outlet below the turntable.
- The measurement distance is 3 meter.
- The EUT was set into operation.

Pre measurement:

- The turntable rotates from 0° to 315° using 45° steps.
- The antenna height is 0.8 meter.
- At each turntable position the analyzer sweeps with peak detection to find the maximum of all emissions

Final measurement:

- Identified emissions during the pre measurement the software maximizes by rotating the turntable position (0° to 360°) and by rotating the elevation axes (0° to 360°).
- The final measurement will be done in the position (turntable and elevation) causing the highest emissions with QPK detector.



--- The final levels, frequency, measuring time, bandwidth, turntable position, correction factor, margin to the limit and limit will be recorded. Also a plot with the graph of the pre measurement and the limit will be stored.

2) Sequence of testing 30 MHz to 1 GHz

Setup:

--- The equipment was set up to simulate a typical usage like described in the user manual or described by manufacturer.

--- If the EUT is a tabletop system, a table with 0.8 m height is used, which is placed on the ground plane.

--- If the EUT is a floor standing device, it is placed on the ground plane with insulation between both.

--- Auxiliary equipment and cables were positioned to simulate normal operation conditions

--- The AC power port of the EUT (if available) is connected to a power outlet below the turntable.

--- The measurement distance is 3 meter.

--- The EUT was set into operation.

Pre measurement:

--- The turntable rotates from 0° to 315° using 45° steps.

--- The antenna is polarized vertical and horizontal.

--- The antenna height changes from 1 to 3 meter.

--- At each turntable position, antenna polarization and height the analyzer sweeps three times in peak to find the maximum of all emissions.



Final measurement:

- The final measurement will be performed with minimum the six highest peaks.
- According to the maximum antenna and turntable positions of premeasurement the software maximize the peaks by changing turntable position ($\pm 45^\circ$) and antenna movement between 1 and 4 meter.
- The final measurement will be done with QP detector with an EMI receiver.
- The final levels, frequency, measuring time, bandwidth, antenna height, antenna polarization, turntable angle, correction factor, margin to the limit and limit will be recorded. Also a plot with the graph of the premeasurement with marked maximum final measurements and the limit will be stored.

3) Sequence of testing 1 GHz to 18 GHz

Setup:

- The equipment was set up to simulate a typical usage like described in the user manual or described by manufacturer.
- If the EUT is a tabletop system, a rotatable table with 1.5 m height is used.
- If the EUT is a floor standing device, it is placed on the ground plane with insulation between both.
- Auxiliary equipment and cables were positioned to simulate normal operation conditions
- The AC power port of the EUT (if available) is connected to a power outlet below the turntable.
- The measurement distance is 3 meter.
- The EUT was set into operation.

Pre measurement:

- The turntable rotates from 0° to 315° using 45° steps.
- The antenna is polarized vertical and horizontal.
- The antenna height scan range is 1 meter to 2.5 meter.
- At each turntable position and antenna polarization the analyzer sweeps with peak detection to find the maximum of all emissions.



Final measurement:

--- The final measurement will be performed with minimum the six highest peaks.

--- According to the maximum antenna and turntable positions of premeasurement the software maximize the peaks by changing turntable position ($\pm 45^\circ$) and antenna movement between 1 and 4 meter. This procedure is repeated for both antenna polarizations.

--- The final measurement will be done in the position (turntable, EUT-table and antenna polarization) causing the highest emissions with Peak and Average detector.

--- The final levels, frequency, measuring time, bandwidth, turntable position, EUT-table position, antenna polarization, correction factor, margin to the limit and limit will be recorded. Also a plot with the graph of the pre measurement with marked maximum final measurements and the limit will be stored.

4) Sequence of testing above 18 GHz

Setup:

--- The equipment was set up to simulate a typical usage like described in the user manual or described by manufacturer.

--- If the EUT is a tabletop system, a rotatable table with 1.5 m height is used.

--- If the EUT is a floor standing device, it is placed on the ground plane with insulation between both.

--- Auxiliary equipment and cables were positioned to simulate normal operation conditions

--- The AC power port of the EUT (if available) is connected to a power outlet below the turntable.

--- The measurement distance is 1 meter.

--- The EUT was set into operation.

Pre measurement:

--- The antenna is moved spherical over the EUT in different polarisations of the antenna.

Final measurement:

--- The final measurement will be performed at the position and antenna orientation for all detected emissions that were found during the premeasurements with Peak and Average detector.



8.4.3.1. TEST SETUP

Below 30 MHz

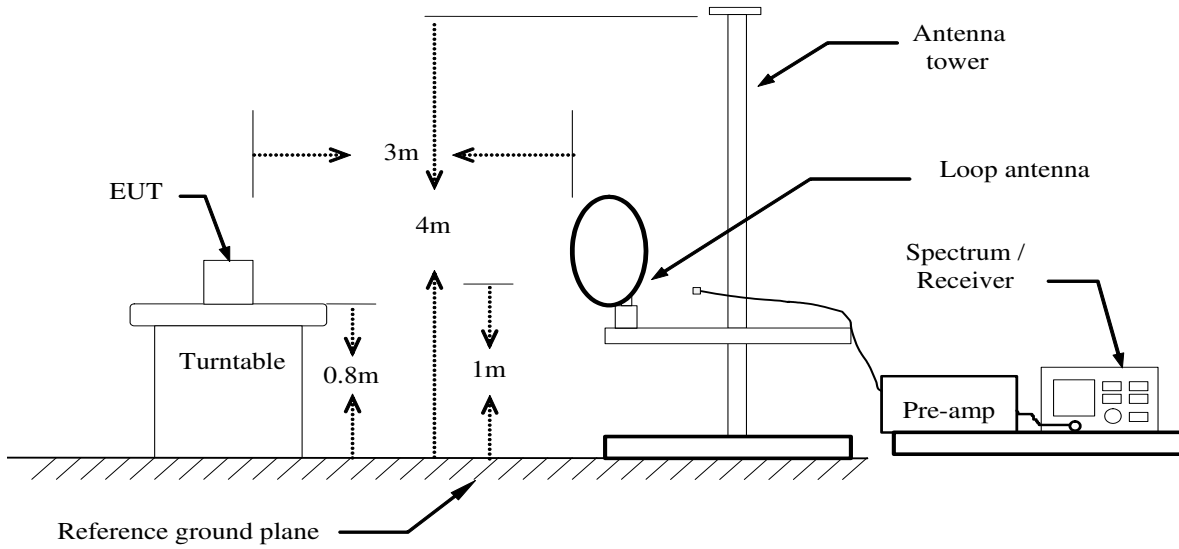

Below 1 GHz

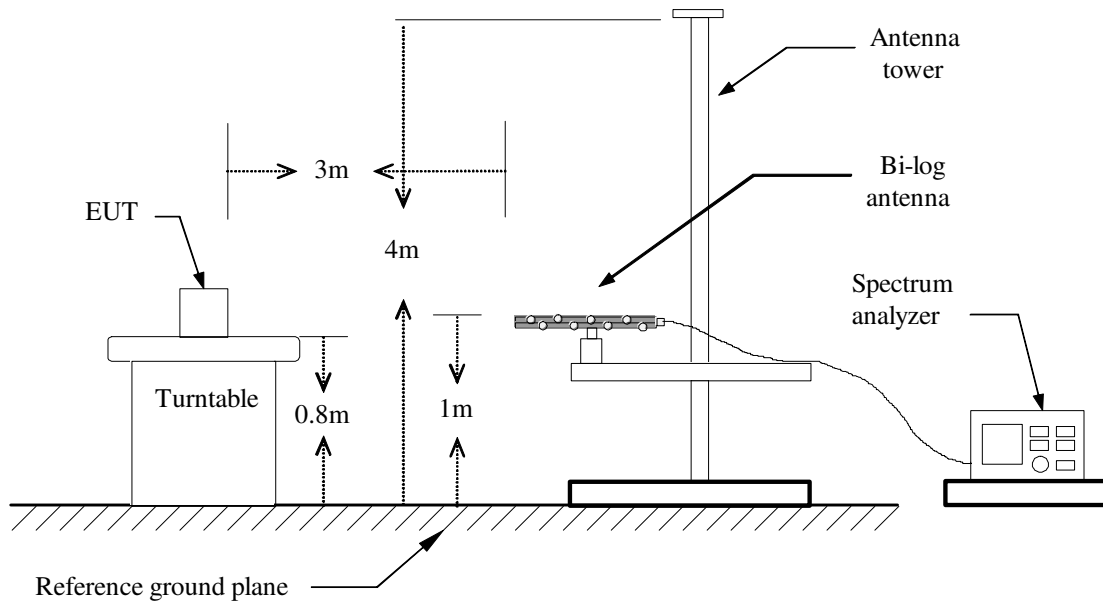



Above 1 GHz

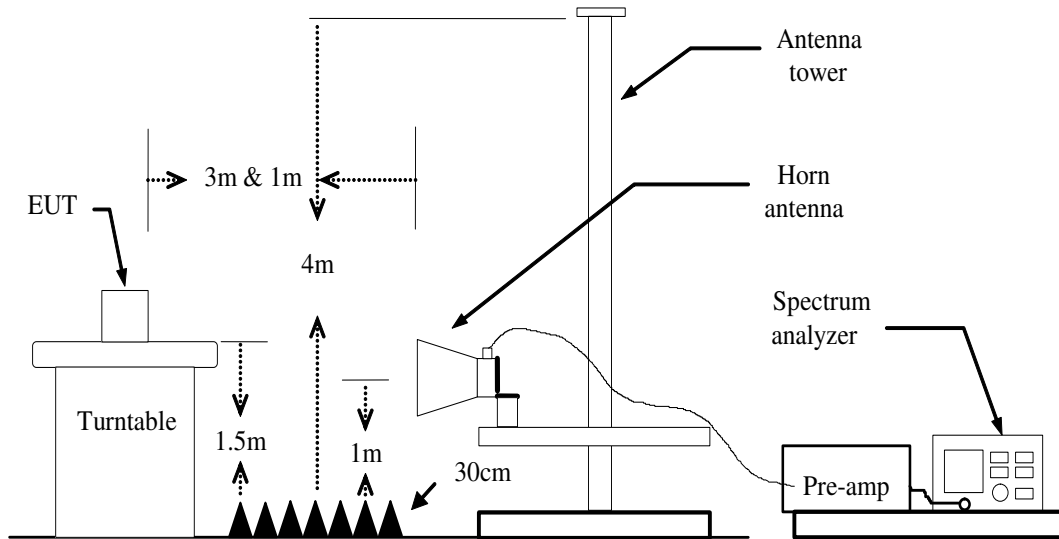

For the actual test configuration, please refer to the related item – Photographs of the Test Configuration.

8.4.3.2. DATA SAMPLE

Below 1 GHz

Frequency (MHz)	Ant.Pol. (H/V)	Reading (Remark) (dBuV)	Correction Factor (dB/m)	Result (Remark) (dBuV/m)	Limit (Peak) (dBuV/m)	Margin (dB)	Remark
xxx	V	12.12	10.21	22.33	40.00	-17.67	Peak

Above 1 GHz

Frequency (MHz)	Ant.Pol. (H/V)	Reading (Peak) (dBuV)	Reading (Average) (dBuV)	Correction Factor (dB/m)	Result (Peak) (dBuV/m)	Result (Average) (dBuV/m)	Limit (Peak) (dBuV/m)	Limit (Average) (dBuV/m)	Margin (dB)	Remark
xxx	V	65.45	63.00	-11.12	54.33	51.88	74.00	54.00	-2.12	AVG

- Frequency (MHz) = Emission frequency in MHz
- Ant.Pol. (H/V) = Antenna polarization
- Reading (dBuV) = Uncorrected Analyzer / Receiver reading
- Correction Factor (dB/m) = Antenna factor + Cable loss – Amplifier gain
- Result (dBuV/m) = Reading (dBuV) + Correction Factor (dB/m)
- Limit (dBuV/m) = Limit stated in standard
- Margin (dB) = Remark Result (dBuV/m) – Limit (dBuV/m)
- Peak = Peak Reading
- QP = Quasi-peak Reading
- AVG = Average Reading

**8.4.3.3. TEST RESULTS****Below 1 GHz**Test Mode: TXTested by: Darry WuAmbient temperature: 24°C Relative humidity: 52% RH Date: January 14, 2017

Frequency (MHz)	Reading (dBuV)	Correction Factor (dB/m)	Result (dBuV/m)	Limit (dBuV/m)	Margin (dB)	Antenna Pole (V/H)	Remark
37.7600	37.06	-15.48	21.58	40.00	-18.42	V	QP
184.2300	37.18	-22.91	14.27	43.50	-29.23	V	QP
213.3300	36.41	-21.12	15.29	43.50	-28.21	V	QP
433.5200	51.80	-15.62	36.18	46.00	-9.82	V	QP
740.0400	28.66	-11.35	17.31	46.00	-28.69	V	QP
906.8800	28.19	-9.66	18.53	46.00	-27.47	V	QP
30.9700	31.30	-12.22	19.08	40.00	-20.92	H	QP
193.9300	38.17	-22.81	15.36	43.50	-28.14	H	QP
433.5200	39.16	-15.62	23.54	46.00	-22.46	H	QP
567.3800	28.63	-13.08	15.55	46.00	-30.45	H	QP
777.8700	28.44	-11.20	17.24	46.00	-28.76	H	QP
893.3000	28.94	-9.88	19.06	46.00	-26.94	H	QP

****Note:**

1. No emission found between lowest internal used/generated frequency to 30 MHz.
2. Only worst case recorded for radiated emissions below 1GHz.

REMARKS:

1. Radiated emissions measured in frequency range from 9kHz to 1GHz were made with an instrument using peak/quasi-peak detector mode.
2. Quasi-peak test would be performed if the peak result were greater than the quasi-peak limit or as required by the applicant.
3. Measurements above show only up to 6 maximum emissions noted, or would be lesser, with " N/A " remark, if no specific emissions from the EUT are recorded (ie: margin>20dB from the applicable limit) and considered that's already beyond the background noise floor.
4. Margin (dB) = Remark result (dBuV/m) – Quasi-peak limit (dBuV/m)



Vertical

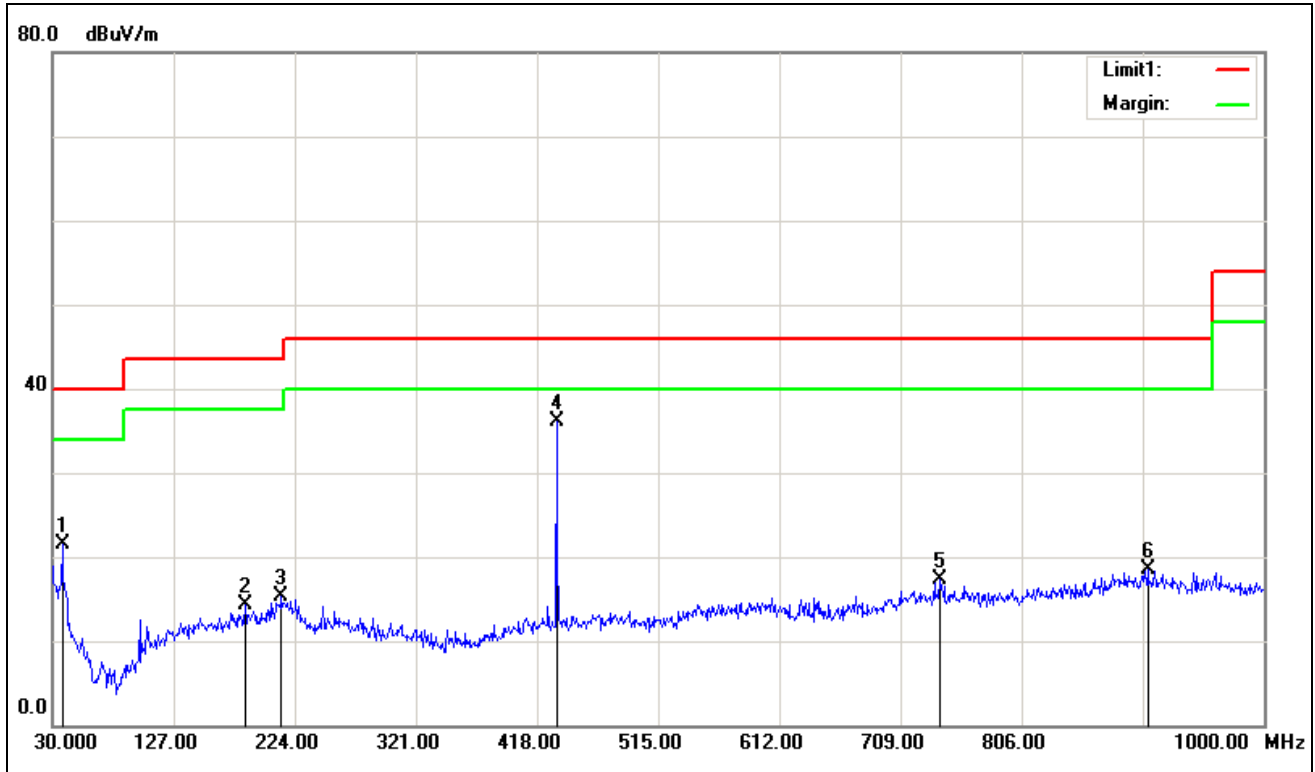

Horizontal

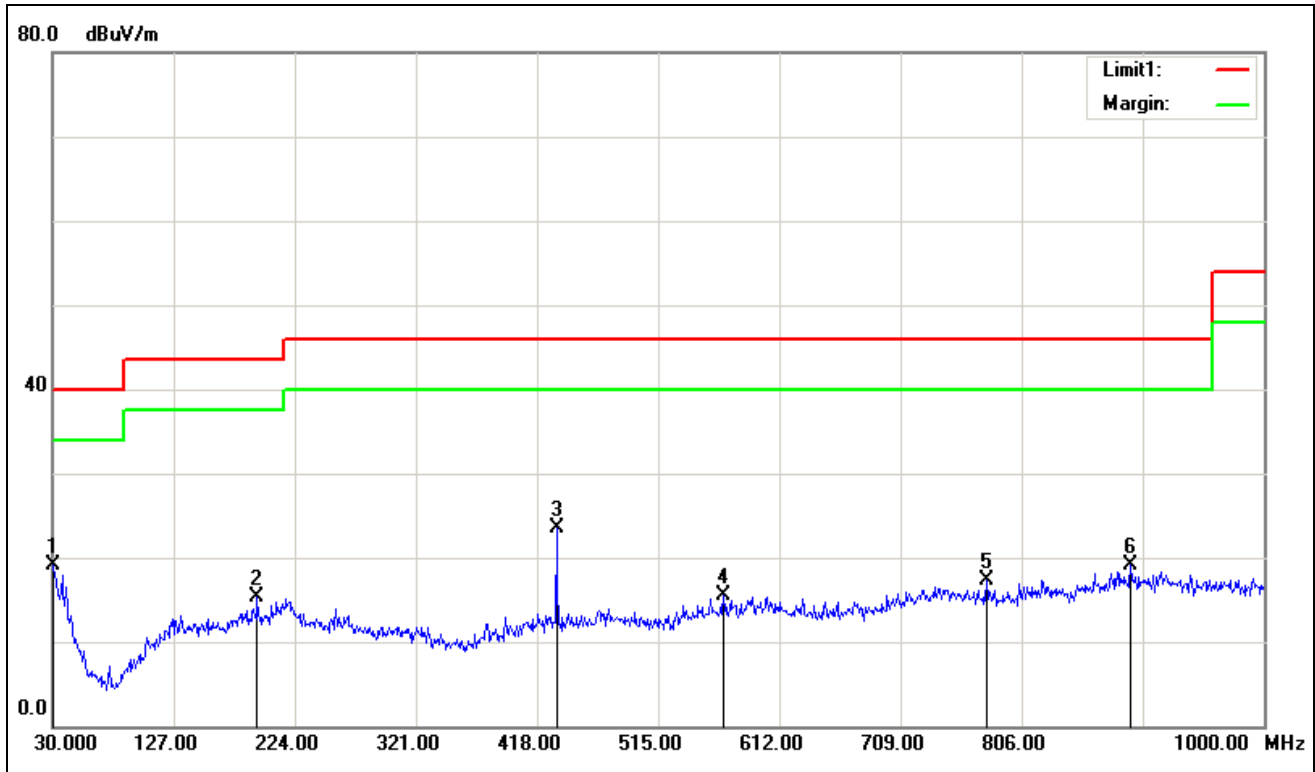



Above 1 GHz

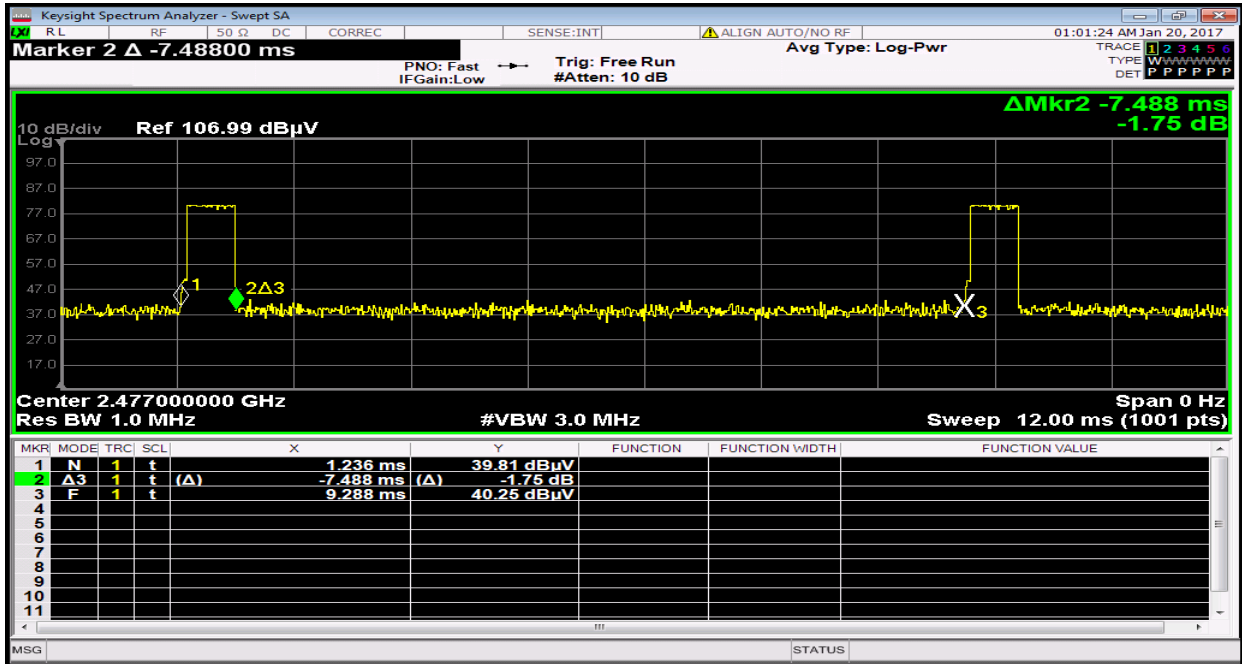

Remark: $20\text{Log} \{1/[\text{on}/(\text{on}+\text{off})]\} = 20\text{Log} [1/(1.236/7.488)] = 15.65\text{dB}$;
 $\text{AVG (Result)} = \text{Peak} - 20\text{Log} \{1/[\text{on}/(\text{on} + \text{off})]\}$;

Fundamental

Channel	Frequency (MHz)	Reading (dBuV)	Correction Factor (dB/m)	Result (dBuV/m)	Limit (dBuV/m)	Margin (dB)	Antenna Pole (V/H)	Remark
CH Low	2407.0000	88.02	-2.77	85.25	114.00	-28.75	V	Peak
	2407.0000	72.37	-2.77	69.60	94.00	-24.40	V	AVG
	2407.0000	78.91	-2.77	76.14	114.00	-37.86	H	Peak
	2407.0000	63.26	-2.77	60.49	94.00	-33.51	H	AVG

Channel	Frequency (MHz)	Reading (dBuV)	Correction Factor (dB/m)	Result (dBuV/m)	Limit (dBuV/m)	Margin (dB)	Antenna Pole (V/H)	Remark
CH Mid	2445.0000	84.30	-2.56	81.74	114.00	-32.26	V	Peak
	2445.0000	68.65	-2.56	66.09	94.00	-27.91	V	AVG
	2445.0000	76.40	-2.56	73.84	114.00	-40.16	H	Peak
	2445.0000	60.75	-2.56	58.19	94.00	-35.81	H	AVG

Channel	Frequency (MHz)	Reading (dBuV)	Correction Factor (dB/m)	Result (dBuV/m)	Limit (dBuV/m)	Margin (dB)	Antenna Pole (V/H)	Remark
CH High	2477.0000	82.88	-2.39	80.49	114.00	-33.51	V	Peak
	2477.0000	67.23	-2.39	64.84	94.00	-29.16	V	AVG
	2477.0000	75.55	-2.39	73.16	114.00	-40.84	H	Peak
	2477.0000	59.90	-2.39	57.51	94.00	-36.49	H	AVG



Test Mode: GFSK (CH Low)

Tested by: Darry Wu

Ambient temperature: 24°C Relative humidity: 52% RH Date: January 14, 2017

Frequency (MHz)	Reading (dBμV)	Correction Factor (dB/m)	Result (dBμV/m)	Limit (dBμV/m)	Margin (dB)	Antenna Pole (V/H)	Remark
2134.000	46.48	-4.27	42.21	74.00	-31.79	V	peak
2557.000	45.83	-2.16	43.67	74.00	-30.33	V	peak
4402.000	42.37	3.01	45.38	74.00	-28.62	V	peak
4816.000	42.27	4.38	46.65	74.00	-27.35	V	peak
5536.000	41.60	5.89	47.49	74.00	-26.51	V	peak
8191.000	41.62	9.54	51.16	74.00	-22.84	V	peak
1180.000	48.96	-7.87	41.09	74.00	-32.91	H	peak
2557.000	45.36	-2.16	43.20	74.00	-30.80	H	peak
3610.000	43.09	-0.06	43.03	74.00	-30.97	H	peak
4816.000	45.05	4.38	49.43	74.00	-24.57	H	peak
4915.000	43.54	4.70	48.24	74.00	-25.76	H	peak
7993.000	40.82	9.64	50.46	74.00	-23.54	H	peak

REMARKS:

1. Measuring frequencies from 1 GHz to the 10th harmonic of highest fundamental frequency.
2. Radiated emissions measured in frequency above 1000MHz were made with an instrument using peak/average detector mode.
3. Average test would be performed if the peak result were greater than the average limit or as required by the applicant.
4. Data of measurement within this frequency range shown " --- " in the table above means the reading of emissions are attenuated more than 20dB below the permissible limits or the field strength is too small to be measured.
5. Measurements above show only up to 6 maximum emissions noted, or would be lesser, with " N/A " remark, if no specific emissions from the EUT are recorded (ie: margin>20dB from the applicable limit) and considered that's already beyond the background noise floor.
6. Margin (dB) = Remark result (dBuV/m) – Average limit (dBuV/m).



Test Mode: GFSK (CH Mid)

Tested by: Darry Wu

Ambient temperature: 24°C Relative humidity: 52% RH Date: January 14, 2017

Frequency (MHz)	Reading (dBμV)	Correction Factor (dB/m)	Result (dBμV/m)	Limit (dBμV/m)	Margin (dB)	Antenna Pole (V/H)	Remark
2512.000	44.56	-2.24	42.32	74.00	-31.68	V	peak
4510.000	42.13	3.38	45.51	74.00	-28.49	V	peak
4888.000	42.18	4.61	46.79	74.00	-27.21	V	peak
6292.000	41.74	6.55	48.29	74.00	-25.71	V	peak
6895.000	41.19	7.53	48.72	74.00	-25.28	V	peak
7570.000	40.13	8.81	48.94	74.00	-25.06	V	peak
2233.000	45.23	-3.72	41.51	74.00	-32.49	H	peak
2512.000	45.41	-2.24	43.17	74.00	-30.83	H	peak
4672.000	42.26	3.91	46.17	74.00	-27.83	H	peak
4888.000	45.86	4.61	50.47	74.00	-23.53	H	peak
6643.000	42.02	7.12	49.14	74.00	-24.86	H	peak
8101.000	41.47	9.59	51.06	74.00	-22.94	H	peak

REMARKS:

1. Measuring frequencies from 1 GHz to the 10th harmonic of highest fundamental frequency.
2. Radiated emissions measured in frequency above 1000MHz were made with an instrument using peak/average detector mode.
3. Average test would be performed if the peak result were greater than the average limit or as required by the applicant.
4. Data of measurement within this frequency range shown " --- " in the table above means the reading of emissions are attenuated more than 20dB below the permissible limits or the field strength is too small to be measured.
5. Measurements above show only up to 6 maximum emissions noted, or would be lesser, with " N/A " remark, if no specific emissions from the EUT are recorded (ie: margin>20dB from the applicable limit) and considered that's already beyond the background noise floor.
6. Margin (dB) = Remark result (dBuV/m) – Average limit (dBuV/m).



Test Mode: GFSK (CH High)

Tested by: Darry Wu

Ambient temperature: 24°C Relative humidity: 52% RH Date: January 14, 2017

Frequency (MHz)	Reading (dBμV)	Correction Factor (dB/m)	Result (dBμV/m)	Limit (dBμV/m)	Margin (dB)	Antenna Pole (V/H)	Remark
1747.000	46.64	-6.38	40.26	74.00	-33.74	V	peak
1900.000	50.59	-5.63	44.96	74.00	-29.04	V	peak
4303.000	42.18	2.66	44.84	74.00	-29.16	V	peak
5698.000	41.43	5.95	47.38	74.00	-26.62	V	peak
6463.000	41.24	6.83	48.07	74.00	-25.93	V	peak
7183.000	42.59	8.06	50.65	74.00	-23.35	V	peak
2143.000	45.46	-4.22	41.24	74.00	-32.76	H	peak
2521.000	44.41	-2.22	42.19	74.00	-31.81	H	peak
3097.000	43.64	-1.20	42.44	74.00	-31.56	H	peak
4951.000	44.24	4.82	49.06	74.00	-24.94	H	peak
5635.000	41.07	5.93	47.00	74.00	-27.00	H	peak
8074.000	41.24	9.61	50.85	74.00	-23.15	H	peak

REMARKS:

1. Measuring frequencies from 1 GHz to the 10th harmonic of highest fundamental frequency.
2. Radiated emissions measured in frequency above 1000MHz were made with an instrument using peak/average detector mode.
3. Average test would be performed if the peak result were greater than the average limit or as required by the applicant.
4. Data of measurement within this frequency range shown " --- " in the table above means the reading of emissions are attenuated more than 20dB below the permissible limits or the field strength is too small to be measured.
5. Measurements above show only up to 6 maximum emissions noted, or would be lesser, with " N/A " remark, if no specific emissions from the EUT are recorded (ie: margin>20dB from the applicable limit) and considered that's already beyond the background noise floor.
6. Margin (dB) = Remark result (dBuV/m) – Average limit (dBuV/m).