



FCC 47 CFR PART 15 SUBPART C

TEST REPORT

For

Bluetooth Calculator Keypad

Model: WKP-3020A

Trade Name: ORtek

Issued to

**ORtek Technology Inc.
13F, Number 150, Jian-Yi Rd., Zhonghe Dist.,
New Taipei City, Taiwan, R.O.C.**

Issued by

**Compliance Certification Services Inc.
No.11, Wugong 6th Rd., Wugu Dist.,
New Taipei City 24891, Taiwan. (R.O.C.)
<http://www.ccsrf.com>
service@ccsrf.com**

Issued Date: January 08, 2013



Note: This report shall not be reproduced except in full, without the written approval of Compliance Certification Services Inc. This document may be altered or revised by Compliance Certification Services Inc. personnel only, and shall be noted in the revision section of the document.



Revision History

| Rev. | Issue Date | Revisions | Effect Page | Revised By |
|------|------------------|---------------|-------------|------------|
| 00 | January 08, 2013 | Initial Issue | ALL | Rachel Wu |
| | | | | |
| | | | | |
| | | | | |



TABLE OF CONTENTS

| | |
|---|-----------|
| 1. TEST RESULT CERTIFICATION..... | 4 |
| 2. EUT DESCRIPTION | 5 |
| 3. TEST METHODOLOGY | 6 |
| 3.1 EUT CONFIGURATION | 6 |
| 3.2 EUT EXERCISE..... | 6 |
| 3.3 GENERAL TEST PROCEDURES..... | 6 |
| 3.4 FCC PART 15.205 RESTRICTED BANDS OF OPERATIONS..... | 7 |
| 3.5 DESCRIPTION OF TEST MODES | 8 |
| 4. INSTRUMENT CALIBRATION..... | 9 |
| 4.1 MEASURING INSTRUMENT CALIBRATION | 9 |
| 4.2 MEASUREMENT EQUIPMENT USED | 9 |
| 4.3 MEASUREMENT UNCERTAINTY | 10 |
| 5. FACILITIES AND ACCREDITATIONS | 11 |
| 5.1 FACILITIES | 11 |
| 5.2 EQUIPMENT..... | 11 |
| 5.3 TABLE OF ACCREDITATIONS AND LISTINGS..... | 12 |
| 6. SETUP OF EQUIPMENT UNDER TEST | 13 |
| 6.1 SETUP CONFIGURATION OF EUT..... | 13 |
| 6.2 SUPPORT EQUIPMENT | 13 |
| 7. FCC PART 15.247 REQUIREMENTS..... | 14 |
| 7.1 20 DB BANDWIDTH..... | 14 |
| 7.2 PEAK POWER..... | 18 |
| 7.3 BAND EDGES MEASUREMENT | 19 |
| 7.4 FREQUENCY SEPARATION..... | 29 |
| 7.5 NUMBER OF HOPPING FREQUENCY..... | 32 |
| 7.6 TIME OF OCCUPANCY (DWELL TIME) | 35 |
| 7.7 SPURIOUS EMISSIONS | 39 |
| 7.8 POWERLINE CONDUCTED EMISSIONS..... | 51 |
| APPENDIX I PHOTOGRAPHS OF TEST SETUP..... | 53 |



1. TEST RESULT CERTIFICATION

| | |
|-------------------|---|
| Product: | Bluetooth Calculator Keypad |
| Model: | WKP-3020A |
| Brand: | ORtek |
| Applicant: | ORtek Technology Inc. 13F, Number 150, Jian-Yi Rd., Zhonghe Dist., New Taipei City, Taiwan, R.O.C. |
| Tested: | December 28 ~ 29, 2012 |

| APPLICABLE STANDARDS | |
|------------------------------|-------------------------|
| STANDARD | TEST RESULT |
| FCC 47 CFR Part 15 Subpart C | No non-compliance noted |

We hereby certify that:

The above equipment was tested by Compliance Certification Services Inc. The test data, data evaluation, test procedures, and equipment configurations shown in this report were made in accordance with the procedures given in **ANSI C63.4: 2009** and the energy emitted by the sample EUT tested as described in this report is in compliance with the requirements of FCC Rules Part 15.207, 15.209, 15.247.

The test results of this report relate only to the tested sample EUT identified in this report.

Approved by:

Reviewed by:

Miller Lee
Section Manager
Compliance Certification Services Inc.

Gina Lo
Section Manager
Compliance Certification Services Inc.



2. EUT DESCRIPTION

| | |
|------------------------------|-----------------------------------|
| Product | Bluetooth Calculator Keypad |
| Brand Name | ORtek |
| Model | WKP-3020A |
| Applicant | ORtek Technology Inc. |
| Housing material | Plastic |
| Serial Number | T121211W01 |
| Received Date | December 11, 2012 |
| EUT Power Rating | Power from Battery AAA*2 (DC 3 V) |
| Frequency Range | 2402 ~ 2480 MHz |
| Transmit Power | -4.34 dBm |
| Modulation Technique | FHSS (GFSK) |
| Transmit Data Rate | 1Mbps |
| Number of Channels | 79 Channels |
| Antenna Specification | Gain: 2.78 dBi |
| Antenna Designation | PCB antenna |

Remark:

1. *The sample selected for test was production product and was provided by manufacturer.*
2. *This submittal(s) (test report) is intended for FCC ID: **GM8WKP3020A** filing to comply with Section 15.207, 15.209 and 15.247 of the FCC Part 15, Subpart C Rules.*



3. TEST METHODOLOGY

The tests documented in this report were performed in accordance with ANSI C63.4: 2009 and FCC CFR 47 Part 15.207, 15.209, 15.247 and DA00-705.

3.1 EUT CONFIGURATION

The EUT configuration for testing is installed on RF field strength measurement to meet the Commissions requirement and operating in a manner that intends to maximize its emission characteristics in a continuous normal application.

3.2 EUT EXERCISE

The EUT was operated in the engineering mode to fix the TX frequency that was for the purpose of the measurements.

According to its specifications, the EUT must comply with the requirements of the Section 15.207, 15.209 and 15.247 under the FCC Rules Part 15 Subpart C.

3.3 GENERAL TEST PROCEDURES

Conducted Emissions

The EUT is placed on the turntable, which is 0.8 m above ground plane. According to the requirements in Section 13.1.4.1 of ANSI C63.4: 2009 Conducted emissions from the EUT measured in the frequency range between 0.15 MHz and 30MHz using CISPR Quasi-peak and average detector modes.

Radiated Emissions

The EUT is placed on a turn table, which is 0.8 m above ground plane. The turntable shall rotate 360 degrees to determine the position of maximum emission level. EUT is set 3m away from the receiving antenna, which varied from 1m to 4m to find out the highest emission. And also, each emission was to be maximized by changing the polarization of receiving antenna both horizontal and vertical. In order to find out the maximum emissions, exploratory radiated emission measurements were made according to the requirements in Section 13.1.4.1 of ANSI C63.4: 2009.



3.4 FCC PART 15.205 RESTRICTED BANDS OF OPERATIONS

(a) Except as shown in paragraph (d) of this section, only spurious emissions are permitted in any of the frequency bands listed below:

| MHz | MHz | MHz | GHz |
|----------------------------|---------------------|-----------------|------------------|
| 0.090 - 0.110 | 16.42 - 16.423 | 399.9 - 410 | 4.5 - 5.15 |
| ¹ 0.495 - 0.505 | 16.69475 - 16.69525 | 608 - 614 | 5.35 - 5.46 |
| 2.1735 - 2.1905 | 16.80425 - 16.80475 | 960 - 1240 | 7.25 - 7.75 |
| 4.125 - 4.128 | 25.5 - 25.67 | 1300 - 1427 | 8.025 - 8.5 |
| 4.17725 - 4.17775 | 37.5 - 38.25 | 1435 - 1626.5 | 9.0 - 9.2 |
| 4.20725 - 4.20775 | 73 - 74.6 | 1645.5 - 1646.5 | 9.3 - 9.5 |
| 6.215 - 6.218 | 74.8 - 75.2 | 1660 - 1710 | 10.6 - 12.7 |
| 6.26775 - 6.26825 | 108 - 121.94 | 1718.8 - 1722.2 | 13.25 - 13.4 |
| 6.31175 - 6.31225 | 123 - 138 | 2200 - 2300 | 14.47 - 14.5 |
| 8.291 - 8.294 | 149.9 - 150.05 | 2310 - 2390 | 15.35 - 16.2 |
| 8.362 - 8.366 | 156.52475 - | 2483.5 - 2500 | 17.7 - 21.4 |
| 8.37625 - 8.38675 | 156.52525 | 2655 - 2900 | 22.01 - 23.12 |
| 8.41425 - 8.41475 | 156.7 - 156.9 | 3260 - 3267 | 23.6 - 24.0 |
| 12.29 - 12.293 | 162.0125 - 167.17 | 3332 - 3339 | 31.2 - 31.8 |
| 12.51975 - 12.52025 | 167.72 - 173.2 | 3345.8 - 3358 | 36.43 - 36.5 |
| 12.57675 - 12.57725 | 240 - 285 | 3600 - 4400 | (²) |
| 13.36 - 13.41 | 322 - 335.4 | | |

¹ Until February 1, 1999, this restricted band shall be 0.490-0.510 MHz.

² Above 38.6

(b) Except as provided in paragraphs (d) and (e), the field strength of emissions appearing within these frequency bands shall not exceed the limits shown in Section 15.209. At frequencies equal to or less than 1000 MHz, compliance with the limits in Section 15.209 shall be demonstrated using measurement instrumentation employing a CISPR quasi-peak detector. Above 1000 MHz, compliance with the emission limits in Section 15.209 shall be demonstrated based on the average value of the measured emissions. The provisions in Section 15.35 apply to these measurements.



3.5 DESCRIPTION OF TEST MODES

The EUT (model: WKP-3020A) had been tested under operating condition.

Software used to control the EUT for staying in continuous transmitting mode was programmed.

After verification, all tests were carried out with the worst case test modes as shown below except radiated spurious emission below 1GHz, which worst case was in normal link mode only.

Channel Low (2402MHz), Mid (2441MHz) and High (2480MHz) with 1Mbps data rate was chosen for full testing.



4. INSTRUMENT CALIBRATION

4.1 MEASURING INSTRUMENT CALIBRATION

The measuring equipment, which was utilized in performing the tests documented herein, has been calibrated in accordance with the manufacturer's recommendations for utilizing calibration equipment, which is traceable to recognized national standards.

4.2 MEASUREMENT EQUIPMENT USED

Equipment Used for Emissions Measurement

Remark: Each piece of equipment is scheduled for calibration once a year and Loop Antenna is scheduled for calibration once three years.

| Conducted Emissions Test Site | | | | |
|-------------------------------|--------------|---------|---------------|-----------------|
| Name of Equipment | Manufacturer | Model | Serial Number | Calibration Due |
| Spectrum Analyzer | Agilent | E4446A | MY43360131 | 03/21/2013 |
| Power Meter | Anritsu | ML2495A | 1012009 | 06/05/2013 |
| Power Sensor | Anritsu | MA2411B | 0917072 | 06/05/2013 |

| Wugu 966 Chamber A | | | | |
|--------------------|--------------------|--------------------------|---------------|-----------------|
| Name of Equipment | Manufacturer | Model | Serial Number | Calibration Due |
| Spectrum Analyzer | Agilent | E4446A | US42510268 | 11/06/2013 |
| EMI Test Receiver | R&S | ESCI | 100064 | 03/01/2013 |
| Pre-Amplifier | Mini-Circuits | ZFL-1000LN | SF350700823 | 01/13/2013 |
| Pre-Amplifier | MITEQ | AFS44-00102650-42-10P-44 | 1415367 | 11/19/2013 |
| Bilog Antenna | Sunol Sciences | JB3 | A030105 | 10/02/2013 |
| Horn Antenna | EMCO | 3117 | 00055165 | 02/14/2013 |
| Horn Antenna | EMCO | 3116 | 2487 | 10/10/2013 |
| Turn Table | CCS | CC-T-1F | N/A | N.C.R |
| Antenna Tower | CCS | CC-A-1F | N/A | N.C.R |
| Controller | CCS | CC-C-1F | N/A | N.C.R |
| Site NSA | CCS | N/A | N/A | 12/22/2013 |
| Test S/W | EZ-EMC (CCS-3A1RE) | | | |



4.3 MEASUREMENT UNCERTAINTY

| PARAMETER | UNCERTAINTY |
|---------------------------------------|-------------|
| 3M Semi Anechoic Chamber / 30M~200M | +/- 4.0138 |
| 3M Semi Anechoic Chamber / 200M~1000M | +/- 3.9483 |
| 3M Semi Anechoic Chamber / 1G~8G | +/- 2.5975 |
| 3M Semi Anechoic Chamber / 8G~18G | +/- 2.6112 |
| 3M Semi Anechoic Chamber / 18G~26G | +/- 2.7389 |
| 3M Semi Anechoic Chamber / 26G~40G | +/- 2.9683 |

Remark: This uncertainty represents an expanded uncertainty expressed at approximately the 95% confidence level using a coverage factor of $k=2$.



5. FACILITIES AND ACCREDITATIONS

5.1 FACILITIES

All measurement facilities used to collect the measurement data are located at

No.199, Chunghsen Road, Hsintien City, Taipei Hsien, Taiwan, R.O.C.

Tel: 886-2-2217-0894 / Fax: 886-2-2217-1029

No.11, Wugong 6th Rd., Wugu Dist., New Taipei City 24891, Taiwan. (R.O.C.)

Tel: 886-2-2299-9720 / Fax: 886-2-2298-4045

No.81-1, Lane 210, Bade 2nd Rd., Lujhu Township, Taoyuan County 33841, TAIWAN, R.O.C.

Tel: 886-3-324-0332 / Fax: 886-3-324-5235

The sites are constructed in conformance with the requirements of ANSI C63.7, ANSI C63.4 and CISPR Publication 22.

5.2 EQUIPMENT

Radiated emissions are measured with one or more of the following types of linearly polarized antennas: tuned dipole, biconical, log periodic, bi-log, and/or ridged waveguide, horn. Spectrum analyzers with pre-selectors and quasi-peak detectors are used to perform radiated measurements.



Conducted emissions are measured with Line Impedance Stabilization Networks and EMI Test Receivers.

Calibrated wideband preamplifiers, coaxial cables, and coaxial attenuators are also used for making measurements.

All receiving equipment conforms to CISPR Publication 16-1, "Radio Interference Measuring Apparatus and Measurement Methods."



5.3 TABLE OF ACCREDITATIONS AND LISTINGS

| Country | Agency | Scope of Accreditation | Logo |
|---------|-----------------|--|---|
| USA | FCC | 3M Semi Anechoic Chamber (FCC MRA: TW1039) to perform FCC Part 15 measurements |  FCC MRA: TW1039 |
| Taiwan | TAF | LP0002, RTTE01, FCC Method-47 CFR Part 15 Subpart C, D, E, RSS-210, RSS-310 IDA TS SRD, AS/NZS 4268, AS/NZS 4771, TS 12.1 & 12.2, ETSI EN 300 440-1, ETSI EN 300 440-2, ETSI EN 300 328, ETSI EN 300 220-1, ETSI EN 300 220-2, ETSI EN 301 893, ETSI EN 301 489-1/3/7/17 FCC OET Bulletin 65 + Supplement C, EN 50360, EN 50361, EN 50371, RSS 102, EN 50383, EN 50385, EN 50392, IEC 62209, CNS 14958-1, CNS 14959 FCC Method -47 CFR Part 15 Subpart B IEC / EN 61000-3-2, IEC / EN 61000-3-3, IEC / EN 61000-4-2/3/4/5/6/8/11 |  |
| Canada | Industry Canada | 3M Semi Anechoic Chamber (IC 2324G-1 / IC 2324G-2) to perform |  IC 2324G-1 IC 2324G-2 |

* No part of this report may be used to claim or imply product endorsement by A2LA or any agency of the US Government.



6. SETUP OF EQUIPMENT UNDER TEST

6.1 SETUP CONFIGURATION OF EUT

See test photographs attached in Appendix II for the actual connections between EUT and support equipment.

6.2 SUPPORT EQUIPMENT

| No. | Device Type | Brand | Model | Series No. | FCC ID | Data Cable | Power Cord |
|-----|-------------|-------|---------|--------------|-------------|------------|---|
| 1. | Notebook PC | ASUS | M5200AE | 5BN0AG019631 | PD9WM3B2100 | N/A | AC I/P: Unshielded, 1.8m with a core DC O/P: Unshielded, 1.8m |

Remark:

1. *All the equipment/cables were placed in the worst-case configuration to maximize the emission during the test.*
2. *Grounding was established in accordance with the manufacturer's requirements and conditions for the intended use.*



7. FCC PART 15.247 REQUIREMENTS

7.1 20 DB BANDWIDTH

LIMIT

None; for reporting purposes only.

Test Configuration

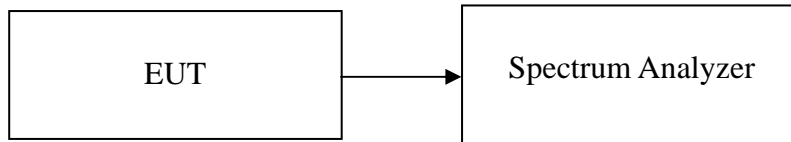

TEST PROCEDURE

1. Place the EUT on the table and set it in the transmitting mode.
2. Remove the antenna from the EUT and then connect a low loss RF cable from the antenna port to the spectrum analyzer.
3. Set the spectrum analyzer as RBW=30kHz, VBW = 100kHz, Span = 3MHz, Sweep = auto
4. Mark the peak frequency and 20dB (upper and lower) frequency.
5. Repeat until all the rest channels are investigated.

TEST RESULTS

No non-compliance noted.

Test Data

| Channel | Frequency (MHz) | 20dB Bandwidth (MHz) |
|---------|-----------------|----------------------|
| Low | 2402 | 1.04 |
| Mid | 2441 | 1.04 |
| High | 2480 | 1.04 |



Test Plot

20dB Bandwidth (CH Low)

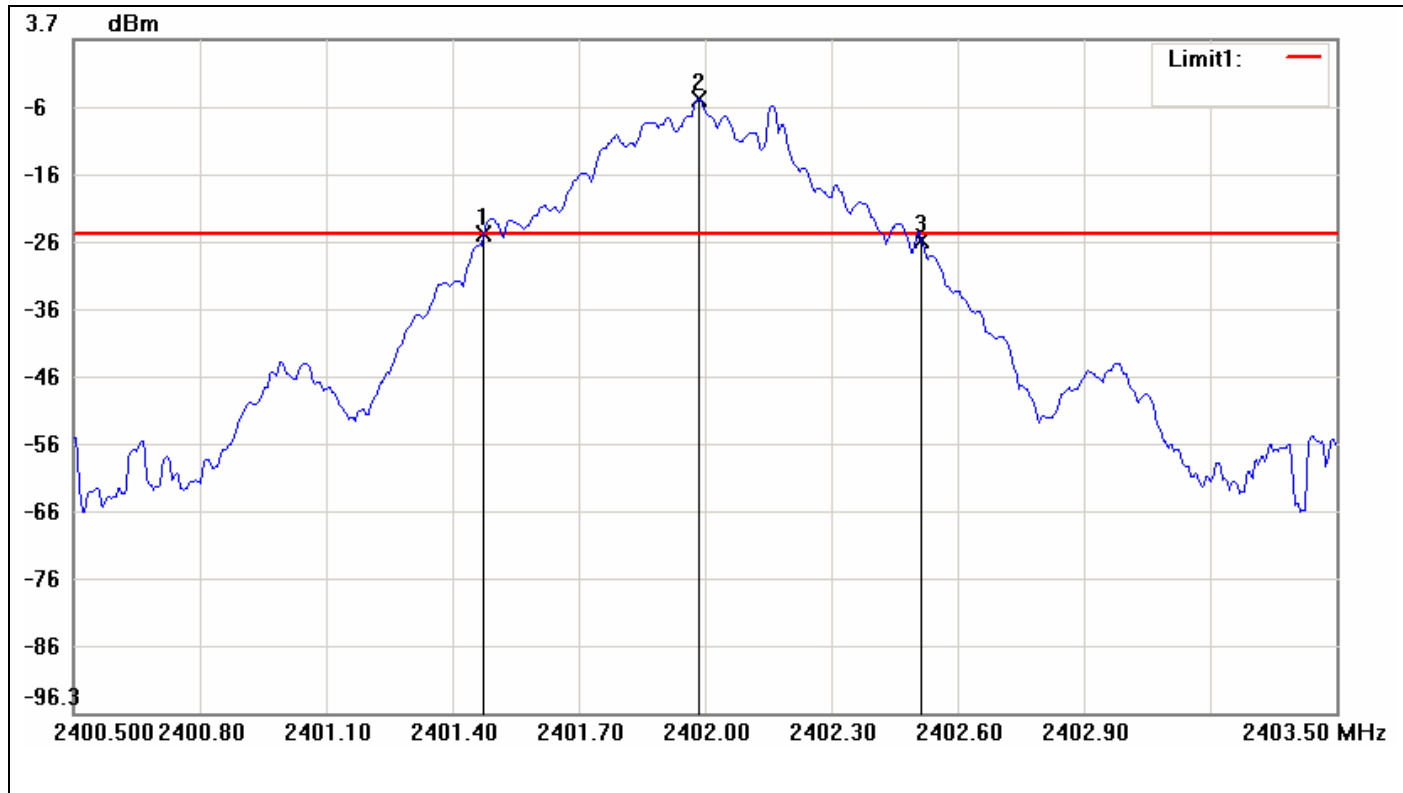

| No. | Frequency(MHz) | Level(dBm) | Limit(dBm) | Margin(dBm) |
|-----|----------------|------------|------------|-------------|
| 1 | 2401.4750 | -25.16 | -25.10 | -0.06 |
| 2 | 2401.9850 | -5.10 | -25.10 | 20.00 |
| 3 | 2402.5150 | -26.21 | -25.10 | -1.11 |

| No. | | Δ Frequency(MHz) | Δ Level(dB) |
|-----|---------|-------------------------|--------------------|
| 1 | mk3-mk1 | 1.04 | -1.05 |



20dB Bandwidth (CH Mid)

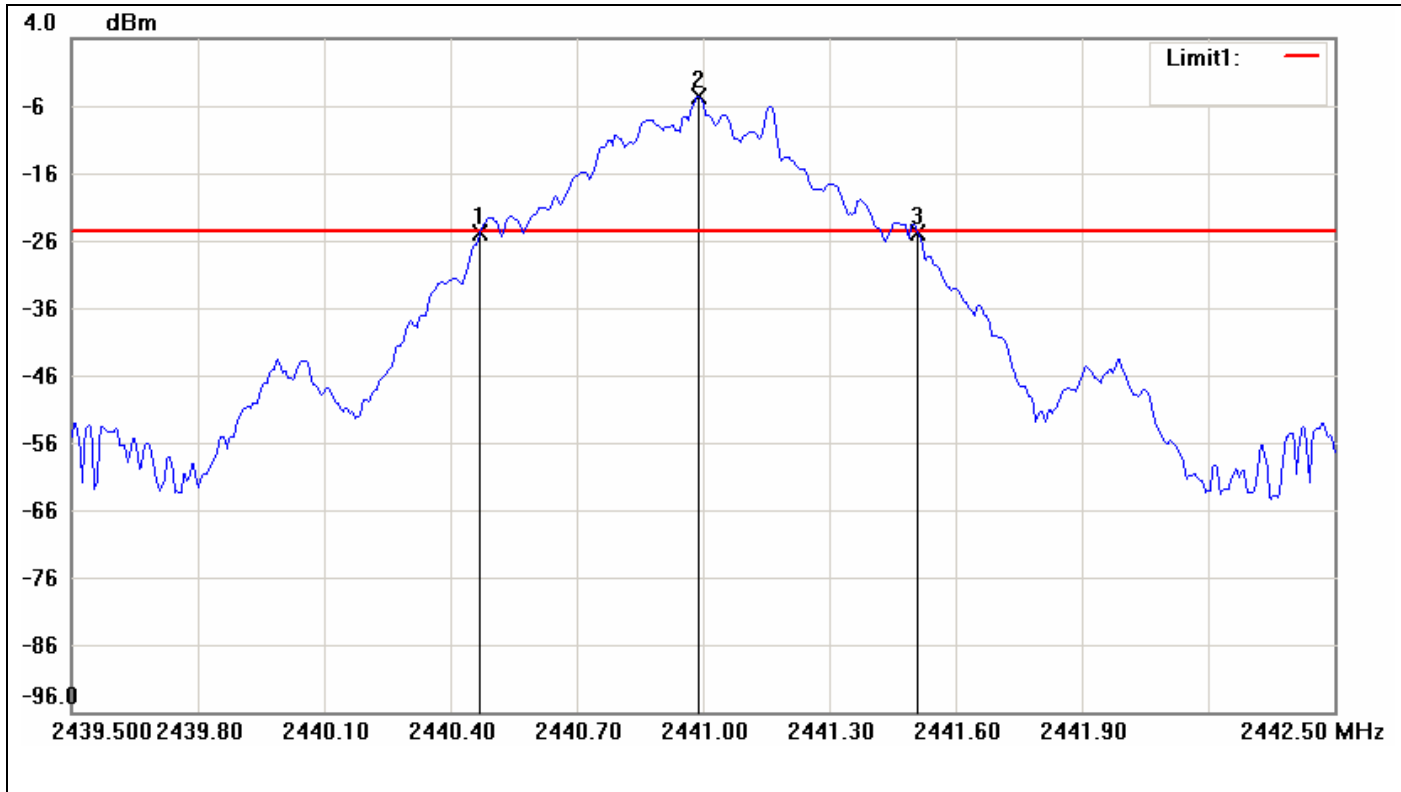

| No. | Frequency(MHz) | Level(dBm) | Limit(dBm) | Margin(dBm) |
|-----|----------------|------------|------------|-------------|
| 1 | 2440.4700 | -24.93 | -24.66 | -0.27 |
| 2 | 2440.9900 | -4.66 | -24.66 | 20.00 |
| 3 | 2441.5100 | -24.76 | -24.66 | -0.10 |

| No. | | Δ Frequency(MHz) | Δ Level(dB) |
|-----|---------|-------------------------|--------------------|
| 1 | mk3-mk1 | 1.04 | 0.17 |



20dB Bandwidth (CH High)

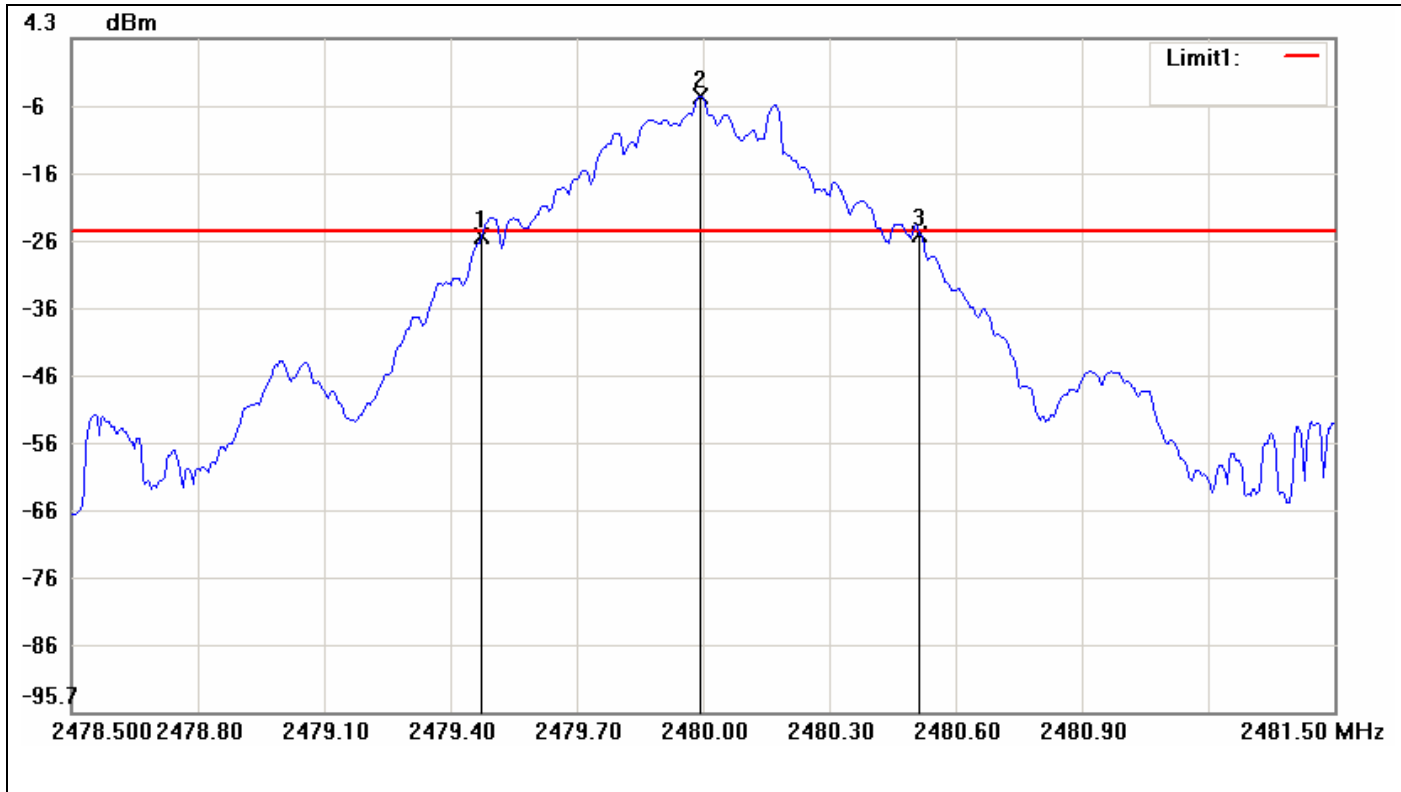

| No. | Frequency(MHz) | Level(dBm) | Limit(dBm) | Margin(dBm) |
|-----|----------------|------------|------------|-------------|
| 1 | 2479.4750 | -25.05 | -24.29 | -0.76 |
| 2 | 2479.9950 | -4.29 | -24.29 | 20.00 |
| 3 | 2480.5150 | -24.77 | -24.29 | -0.48 |

| No. | | Δ Frequency(MHz) | Δ Level(dB) |
|-----|---------|-------------------------|--------------------|
| 1 | mk3-mk1 | 1.04 | 0.28 |



7.2 PEAK POWER

LIMIT

The maximum peak output power of the intentional radiator shall not exceed the following:

1. According to §15.247(a)(1), Frequency hopping systems shall have hopping channel carrier frequencies separated by a minimum of 25 kHz or the 20 dB bandwidth of the hopping channel, whichever is greater. Alternatively, frequency hopping systems operating in the 2400-2483.5 MHz band may have hopping channel carrier frequencies that are separated by 25 kHz or two-thirds of the 20 dB bandwidth of the hopping channel, whichever is greater, provided the systems operate with an output power no greater than 125 mW.
2. According to §15.247(b)(1), for frequency hopping systems operating in the 2400–2483.5 MHz band employing at least 75 nonoverlapping hopping channels, and all frequency hopping systems in the 5725–5850 MHz band: 1 watt. For all other frequency hopping systems in the 2400–2483.5 MHz band: 0.125 watts.
3. According to §15.247(b)(4), the conducted output power limit specified in paragraph (b) of this section is based on the use of antennas with directional gains that do not exceed 6 dBi. Except as shown in paragraph (c) of this section, if transmitting antennas of directional gain greater than 6 dBi are used, the conducted output power from the intentional radiator shall be reduced below the stated values in paragraphs (b)(1), (b)(2), and (b)(3) of this section, as appropriate, by the amount in dB that the directional gain of the antenna exceeds 6 dBi.

Test Configuration

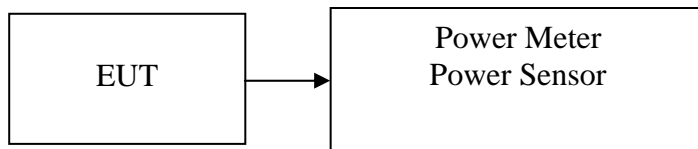

TEST PROCEDURE

The transmitter output is connected to the Power Meter. The Power Meter is set to the peak power detection.

TEST RESULTS

No non-compliance noted.

Test Data

| Channel | Frequency (MHz) | Output Power (dBm) | Output Power (W) | Limit (W) | Result |
|---------|-----------------|--------------------|------------------|-----------|--------|
| Low | 2402 | -4.63 | 0.00034 | 0.125 | PASS |
| Mid | 2441 | -4.50 | 0.00035 | | PASS |
| High | 2480 | -4.34 | 0.00037 | | PASS |



7.3 BAND EDGES MEASUREMENT

LIMIT

According to §15.247(d), in any 100 kHz bandwidth outside the frequency band in which the spread spectrum or digitally modulated intentional radiator is operating, the radio frequency power that is produced by the intentional radiator shall be at least 20 dB below that in the 100 kHz bandwidth within the band that contains the highest level of the desired power, based on either an RF conducted or a radiated measurement, provided the transmitter demonstrates compliance with the peak conducted power limits. If the transmitter complies with the conducted power limits based on the use of RMS averaging over a time interval, as permitted under paragraph (b)(3) of this section, the attenuation required under this paragraph shall be 30 dB instead of 20 dB. Attenuation below the general limits specified in §15.209(a) is not required. In addition, radiated emissions which fall in the restricted bands, as defined in §15.205(a), must also comply with the radiated emission limits specified in §15.209(a) (see §15.205(c)).

Test Configuration

For Radiated

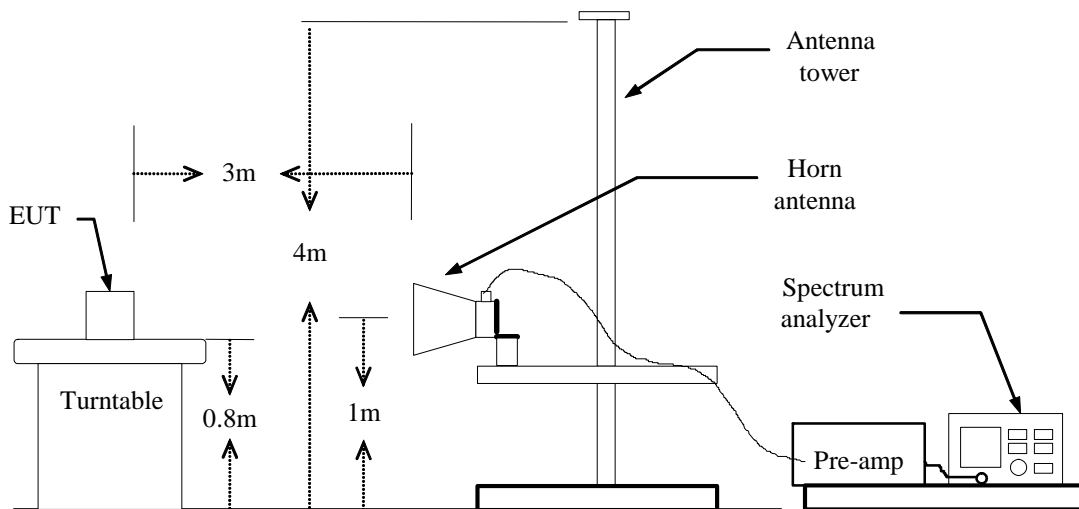

For Conducted

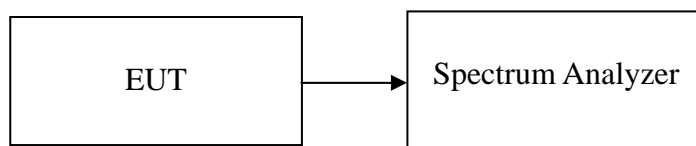



TEST PROCEDURE

For Radiated

1. The EUT is placed on a turntable, which is 0.8m above the ground plane.
2. The turntable shall be rotated for 360 degrees to determine the position of maximum emission level.
3. EUT is set 3m away from the receiving antenna, which is varied from 1m to 4m to find out the highest emission.
4. Set the spectrum analyzer in the following setting in order to capture the lower and upper band-edges of the emission:
 - (a) PEAK: RBW=1MHz / VBW=3MHz / Sweep=AUTO
 - (b) AVERAGE: RBW=1MHz / VBW=10Hz / Sweep=AUTO
5. Repeat the procedures until all the PEAK and AVERAGE versus POLARIZATION are measured.

For Conducted

Conducted RF measurements of the transmitter output were made to confirm that the EUT antenna port conducted emissions meet the specified limit and to identify any spurious signals that require further investigation or measurements on the radiated emissions site.

The transmitter output is connected to the spectrum analyzer. The resolution bandwidth is set to 100 kHz. The video bandwidth is set to 100 kHz.

TEST RESULTS

Refer to attach spectrum analyzer data chart.



Band Edges (CH Low)

Detector mode: Peak

Polarity: Vertical

Agilent 17:24:45 Dec 28, 2012

R T

Mkr1 2.382 93 GHz
48.70 dB μ V/m

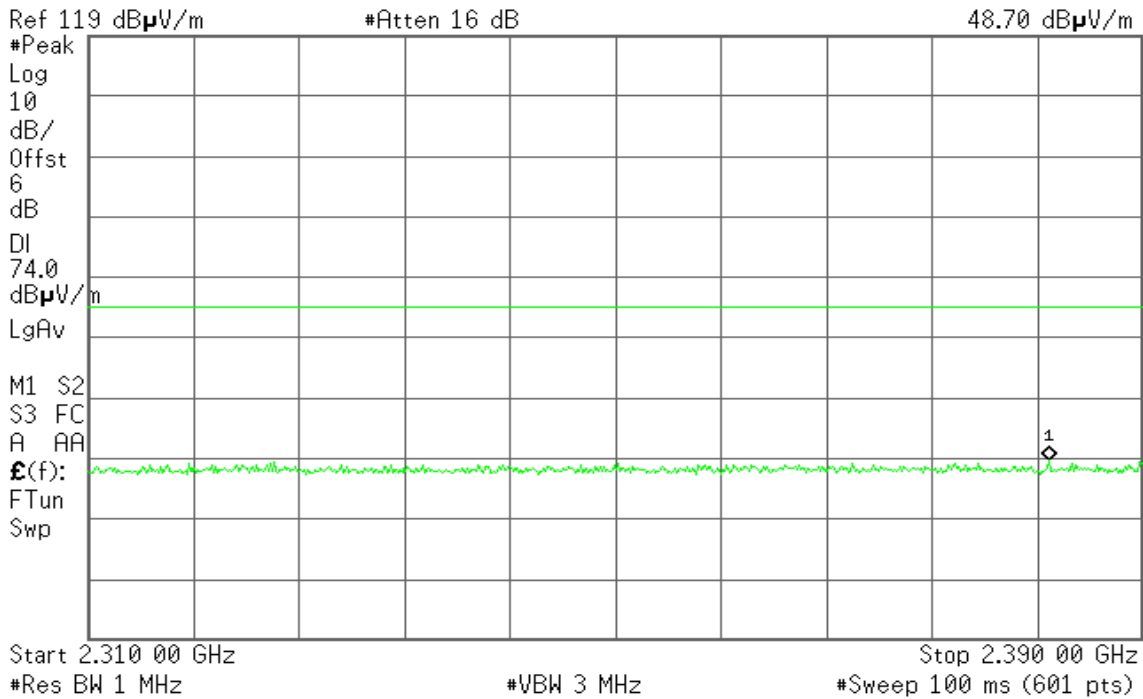

Detector mode: Average

Polarity: Vertical

Agilent 17:25:11 Dec 28, 2012

R T

Mkr1 2.377 87 GHz
33.75 dB μ V/m

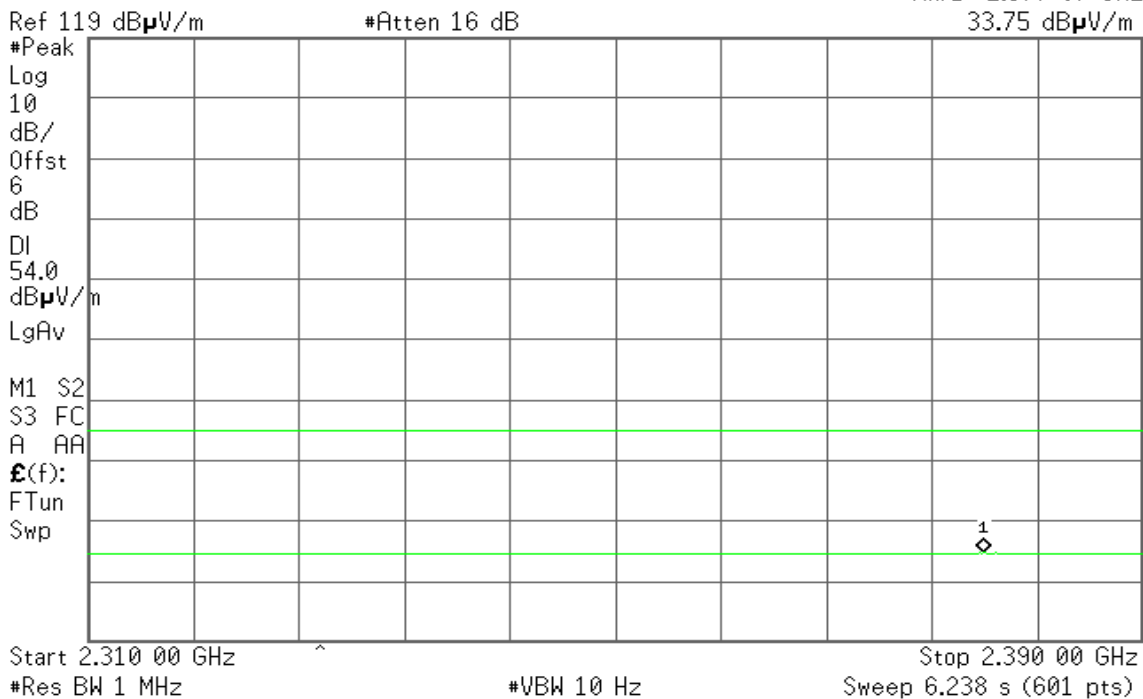



Detector mode: Peak

Polarity: Horizontal

Agilent 17:30:48 Dec 28, 2012

R T

Mkr1 2.358 67 GHz
48.35 dB μ W/m

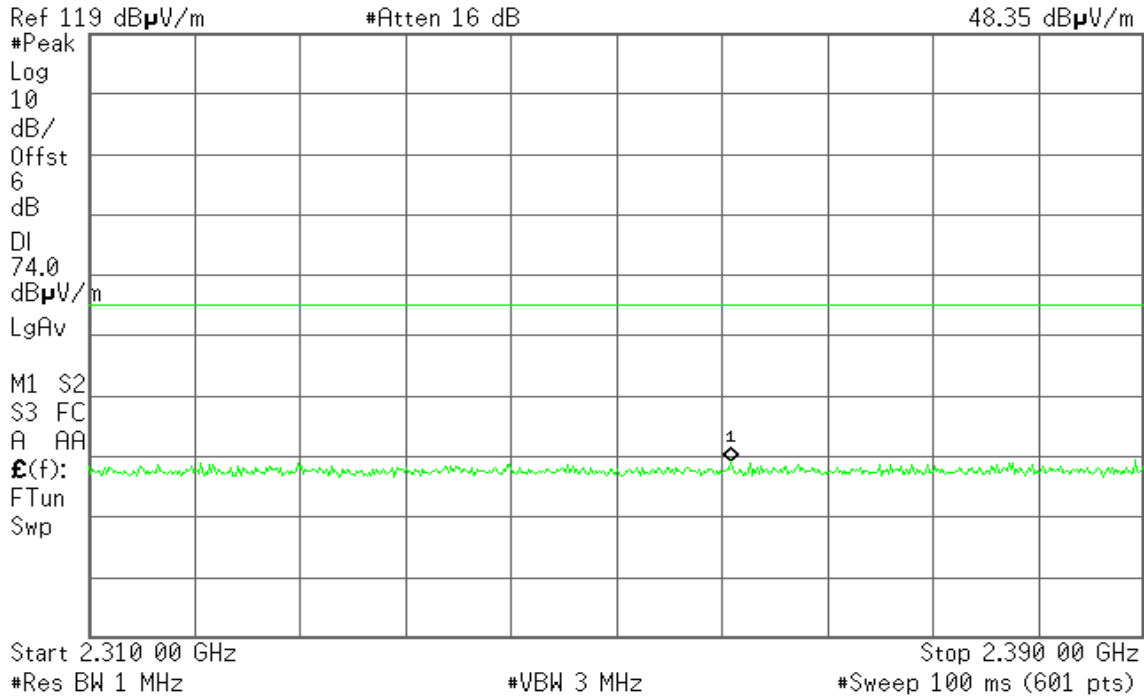

Detector mode: Average

Polarity: Horizontal

Agilent 17:31:44 Dec 28, 2012

R T

Mkr1 2.378 00 GHz
33.68 dB μ W/m

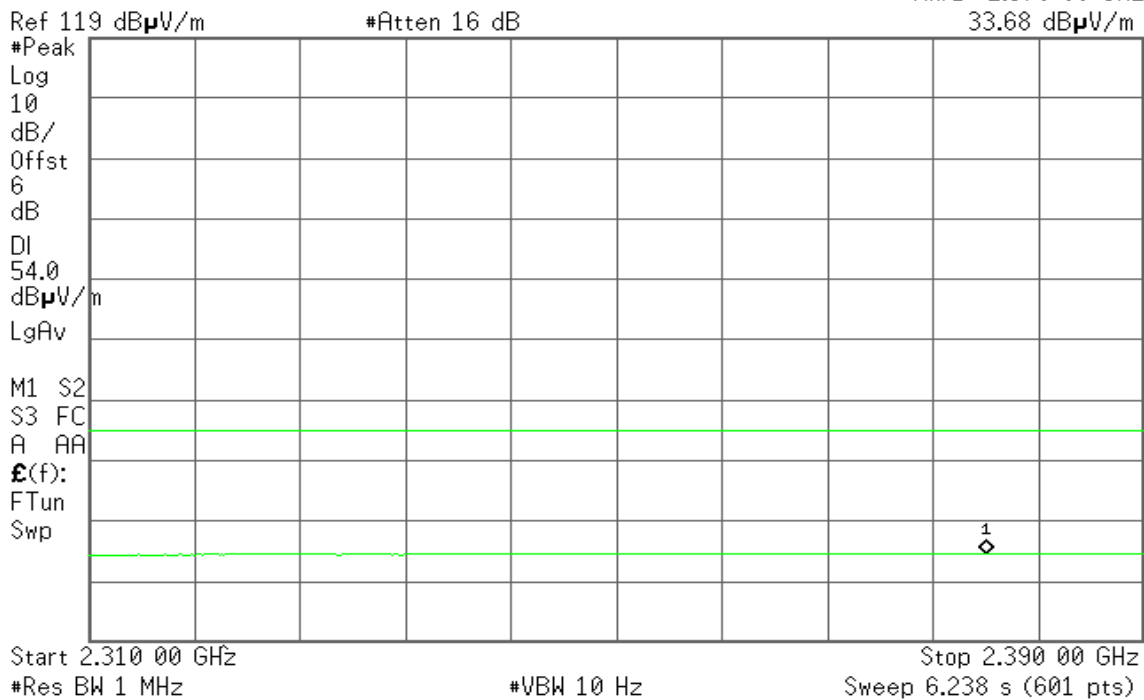



Band Edges (CH High)

Detector mode: Peak

Polarity: Vertical

Agilent 17:45:07 Dec 28, 2012

R T

Mkr1 2.491 56 GHz
49.09 dB μ V/m

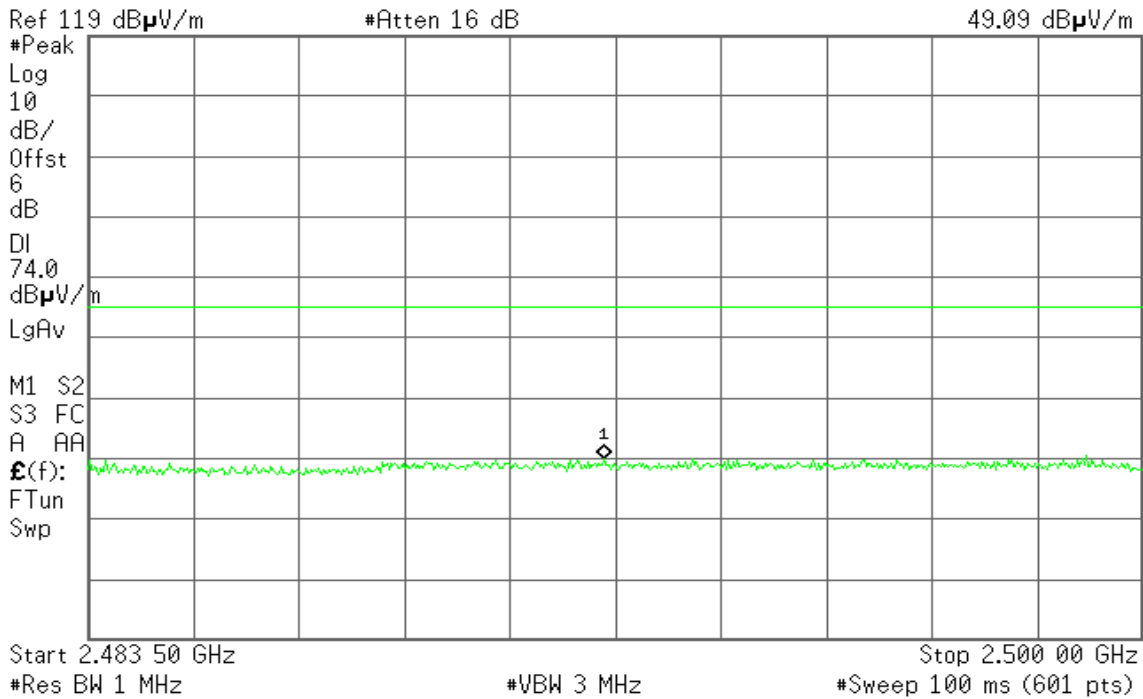

Detector mode: Average

Polarity: Vertical

Agilent 17:45:48 Dec 28, 2012

R T

Mkr1 2.496 59 GHz
34.23 dB μ V/m

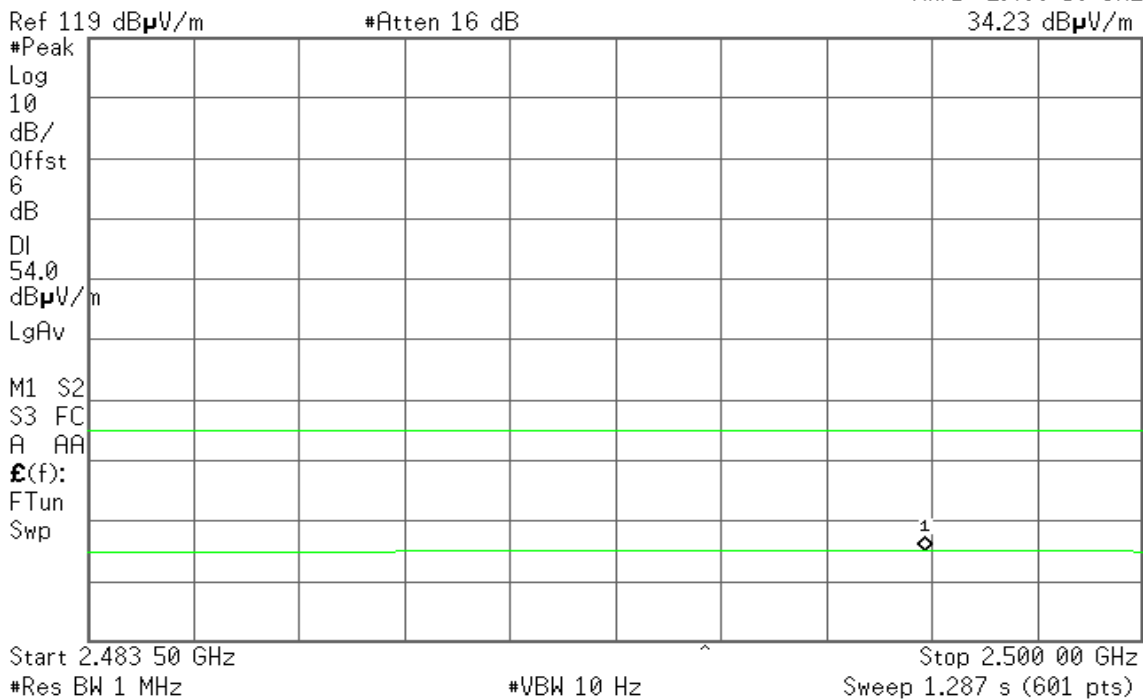



Detector mode: Peak

Polarity: Horizontal

Agilent 17:51:55 Dec 28, 2012

R T

Mkr1 2.483 50 GHz
53.65 dBμV/m

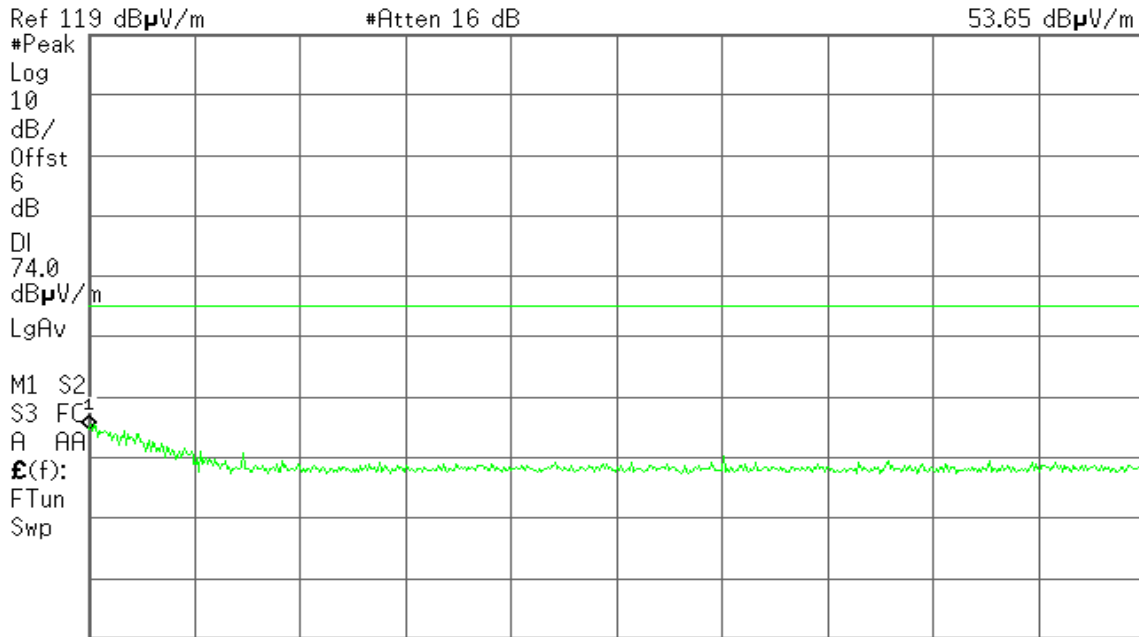

Start 2.483 50 GHz Stop 2.500 00 GHz
#Res BW 1 MHz #VBW 3 MHz #Sweep 100 ms (601 pts)

Detector mode: Average

Polarity: Horizontal

Agilent 17:52:19 Dec 28, 2012

R T

Mkr1 2.483 50 GHz
34.23 dBμV/m

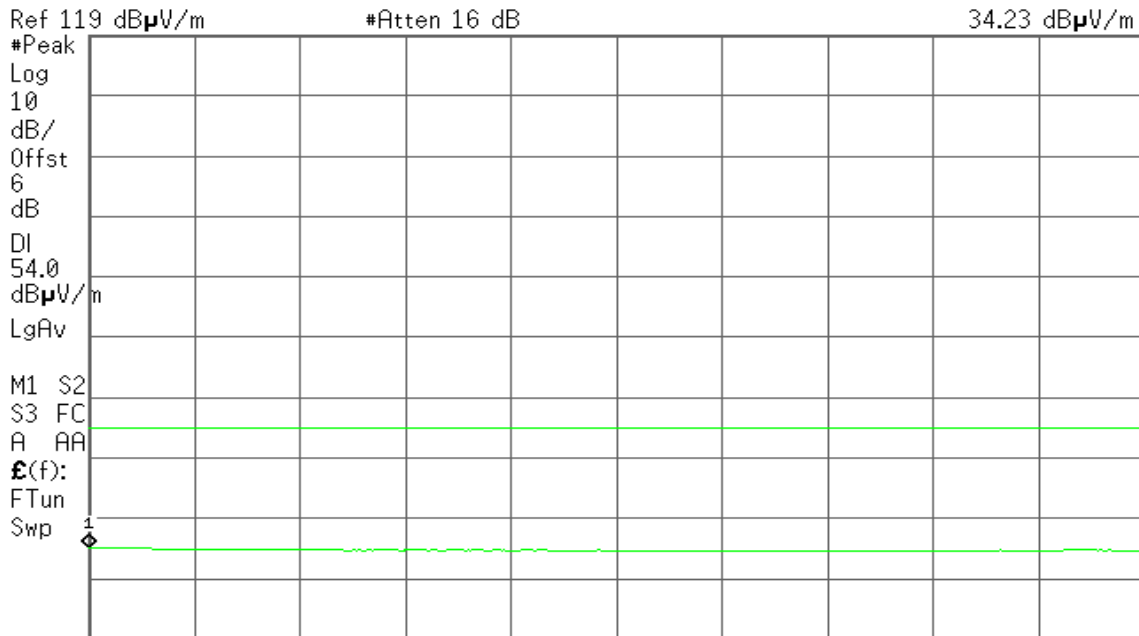

Start 2.483 50 GHz Stop 2.500 00 GHz
#Res BW 1 MHz #VBW 10 Hz Sweep 1.287 s (601 pts)



Band Edges (CH Low)

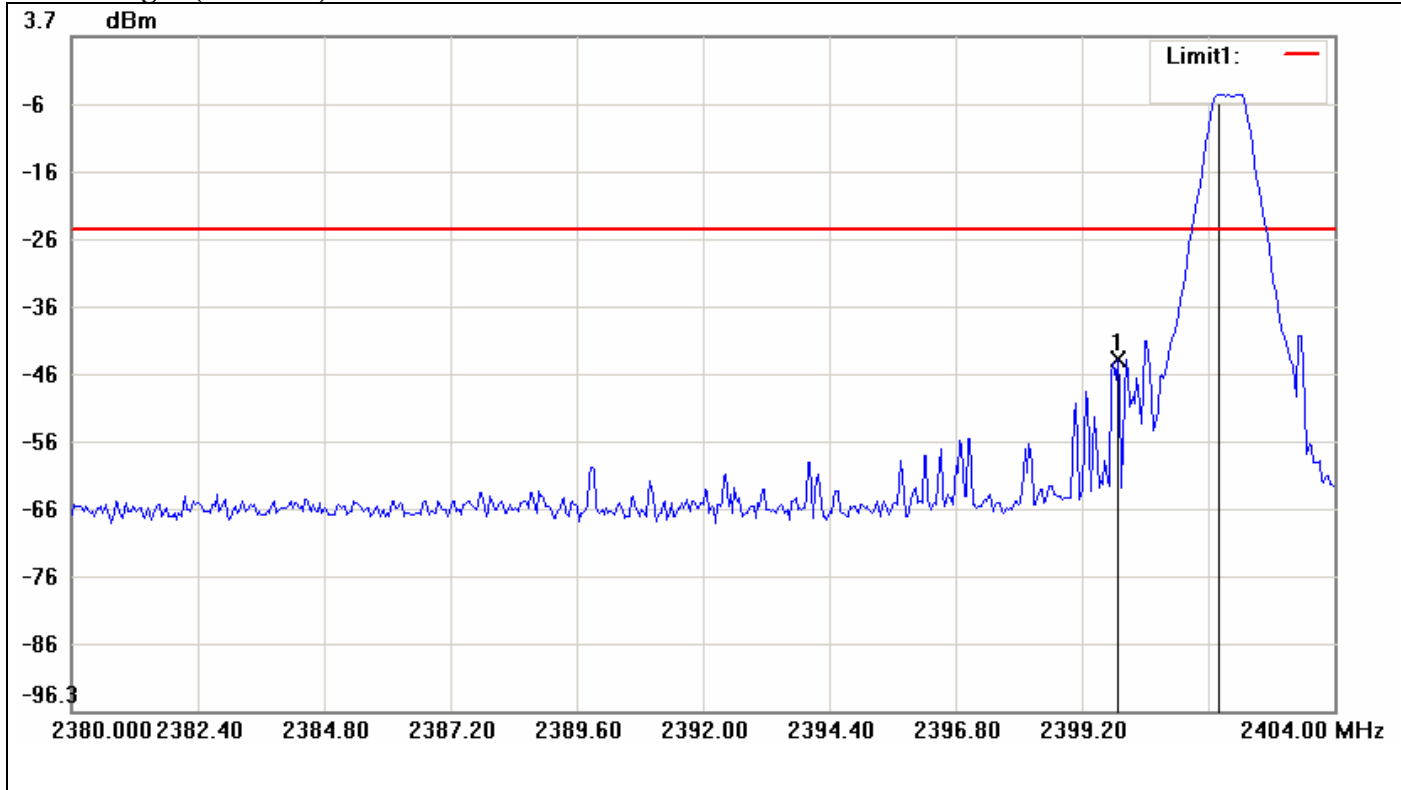

| No. | Frequency(MHz) | Level(dBm) | Limit(dBm) | Margin(dBm) |
|-----|----------------|------------|------------|-------------|
| 1 | 2399.8800 | -44.15 | -24.80 | -19.35 |
| 2 | 2401.8000 | -4.80 | -24.80 | 20.00 |



Band Edges (CH High)

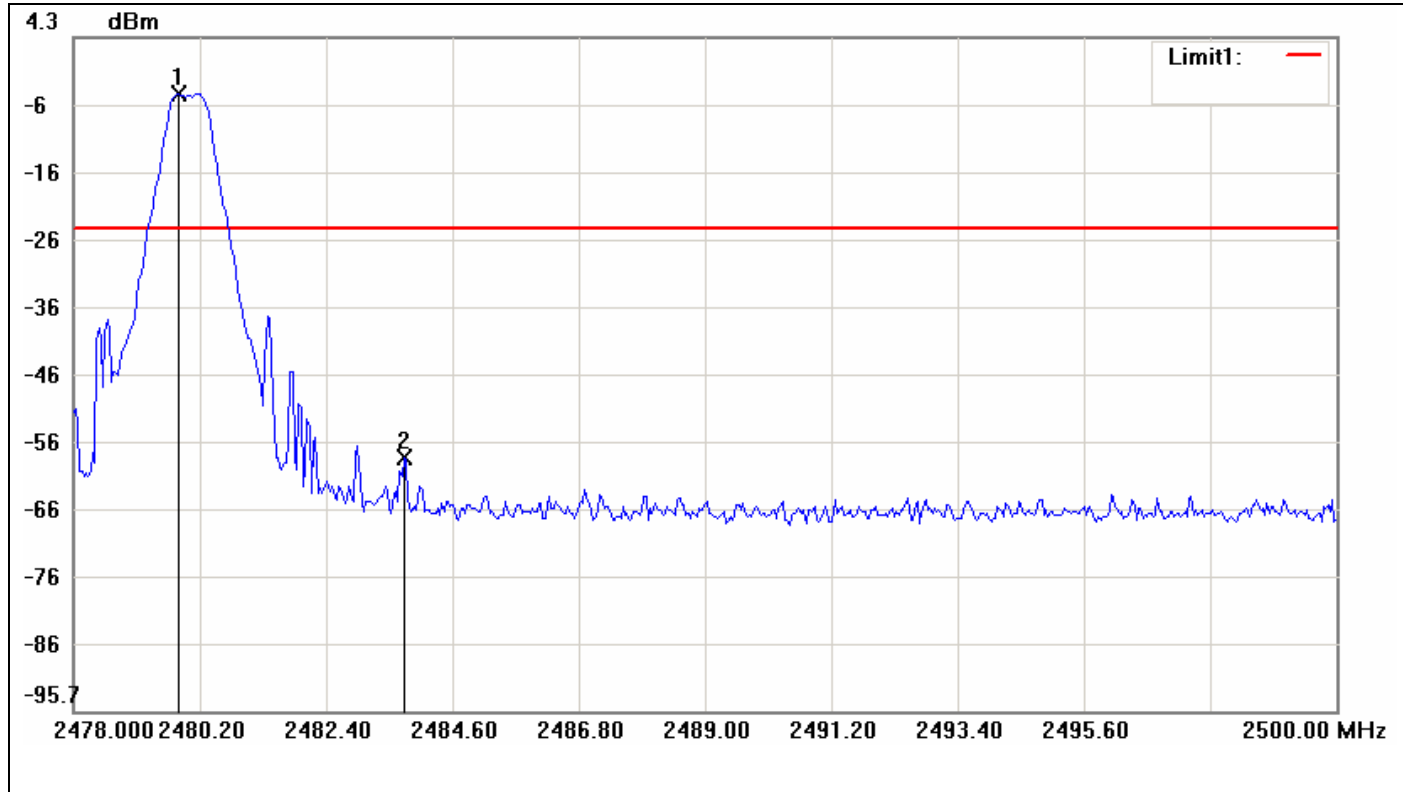

| No. | Frequency(MHz) | Level(dBm) | Limit(dBm) | Margin(dBm) |
|-----|----------------|------------|------------|-------------|
| 1 | 2479.8333 | -4.11 | -24.11 | 20.00 |
| 2 | 2483.7567 | -58.18 | -24.11 | -34.07 |



Hopping Mode

(CH Low)

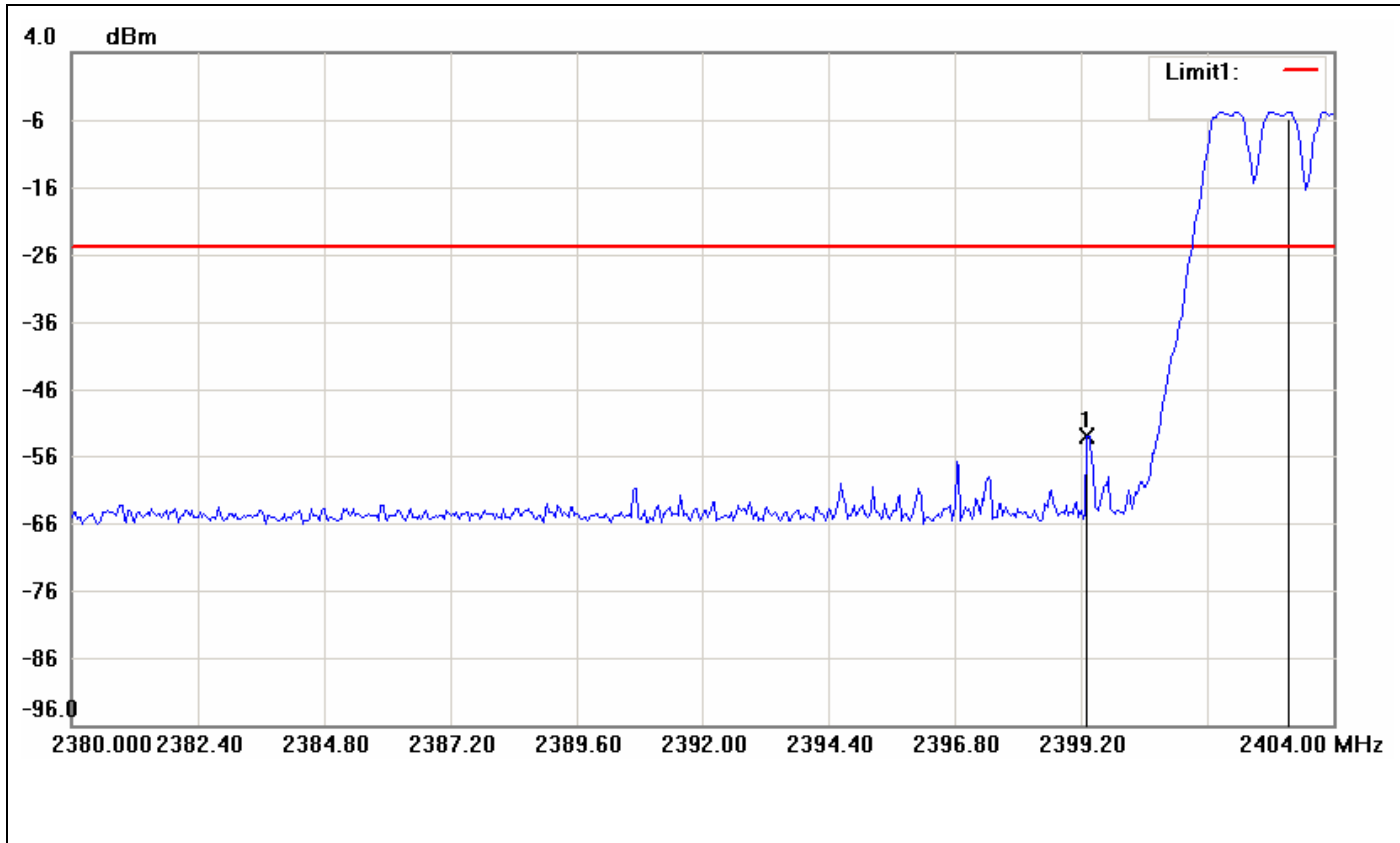

| No. | Frequency(MHz) | Level(dBm) | Limit(dBm) | Margin(dBm) |
|-----|----------------|------------|------------|-------------|
| 1 | 2399.3200 | -53.02 | -24.74 | -28.28 |
| 2 | 2403.1600 | -4.74 | -24.74 | 20.00 |



(CH High)

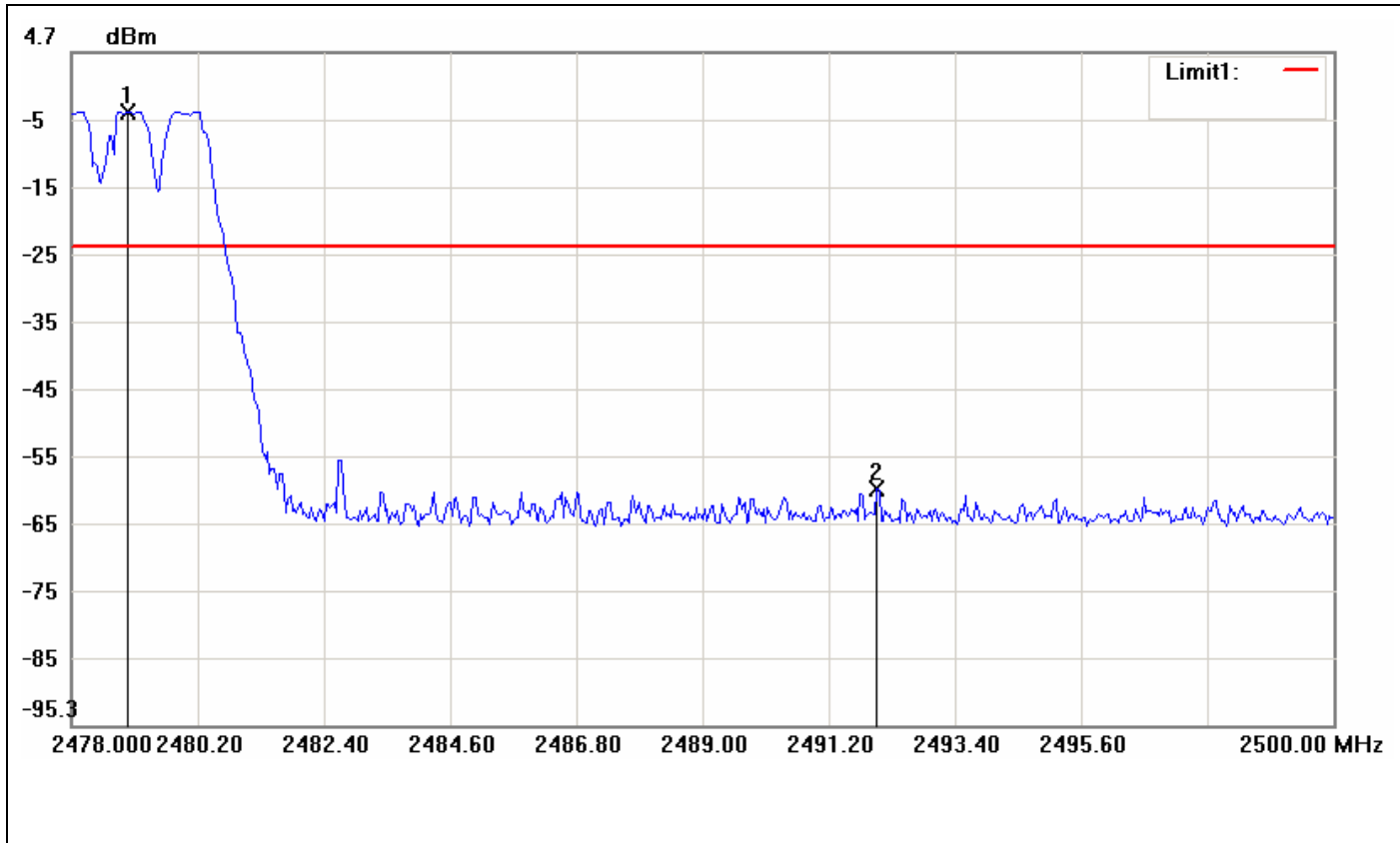

| No. | Frequency(MHz) | Level(dBm) | Limit(dBm) | Margin(dBm) |
|-----|----------------|------------|------------|-------------|
| 1 | 2478.9900 | -4.06 | -24.06 | 20.00 |
| 2 | 2492.0433 | -60.25 | -24.06 | -36.19 |



7.4 FREQUENCY SEPARATION

LIMIT

According to §15.247(a)(1), Frequency hopping systems shall have hopping channel carrier frequencies separated by a minimum of 25 kHz or the 20 dB bandwidth of the hopping channel, whichever is greater. Alternatively, frequency hopping systems operating in the 2400-2483.5 MHz band may have hopping channel carrier frequencies that are separated by 25 kHz or two-thirds of the 20 dB bandwidth of the hopping channel, whichever is greater, provided the systems operate with an output power no greater than 125 mW.

Test Configuration

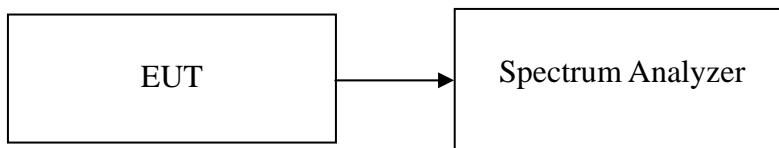

TEST PROCEDURE

1. Place the EUT on the table and set it in transmitting mode.
2. Remove the antenna from the EUT and then connect a low loss RF cable from the antenna port to the spectrum analyzer.
3. Set center frequency of spectrum analyzer = middle of hopping channel.
4. Set the spectrum analyzer as RBW = 30kHz, VBW = 100kHz, Span = 3MHz, Sweep = auto.
5. Max hold, mark 3 peaks of hopping channel and record the 3 peaks frequency.

TEST RESULTS

No non-compliance noted

Test Data

| Channel Separation (MHz) | two-thirds of the 20 dB bandwidth (kHz) | Channel Separation Limit | Result |
|--------------------------|---|------------------------------------|--------|
| 1.065 | 693.33 | >two-thirds of the 20 dB bandwidth | Pass |



Test Plot

Measurement of Channel Separation

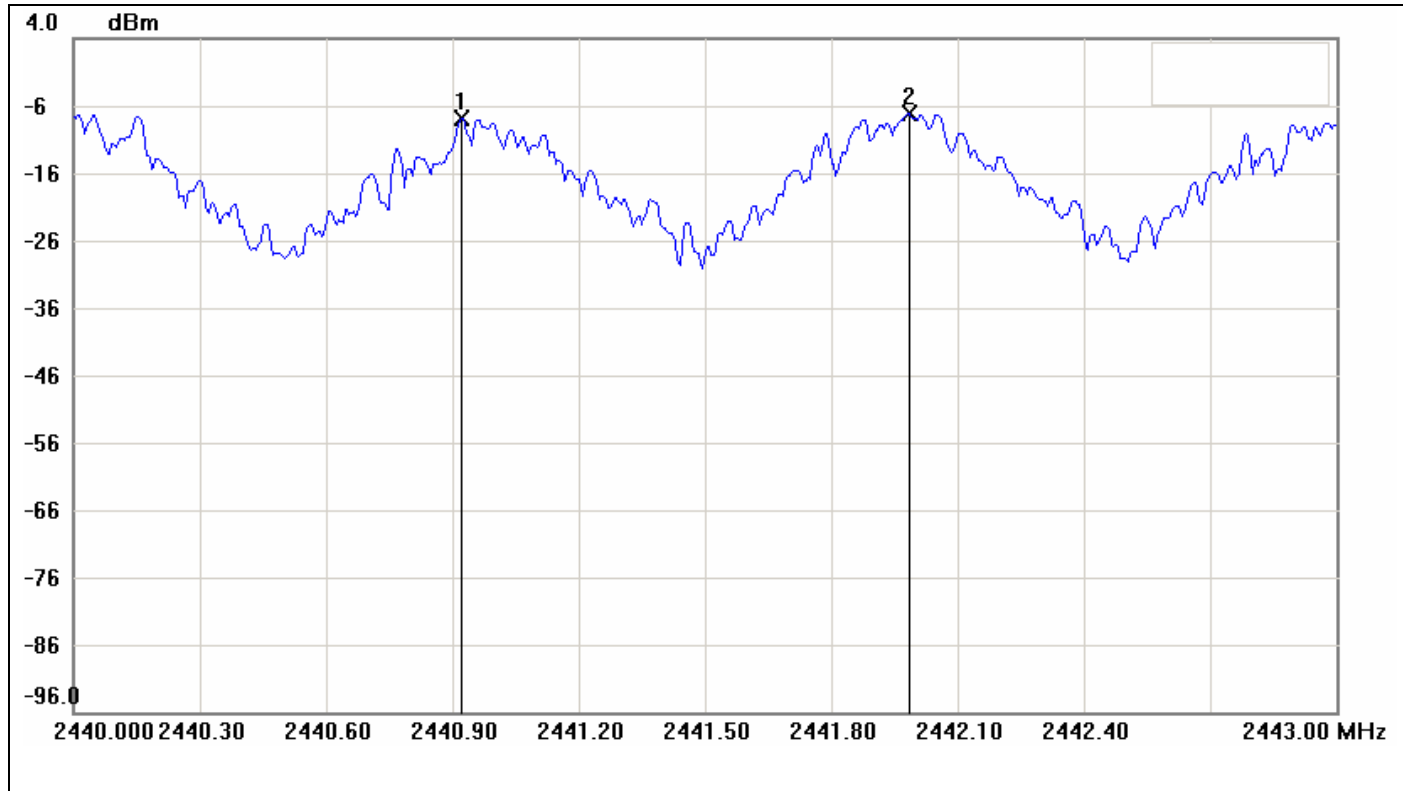

| No. | Frequency(MHz) | Level(dBm) | Limit(dBm) | Margin(dBm) |
|-----|----------------|------------|------------|-------------|
| 1 | 2440.9200 | -7.92 | | |
| 2 | 2441.9850 | -7.20 | | |

| No. | | Δ Frequency(MHz) | Δ Level(dB) |
|-----|---------|-------------------------|--------------------|
| 1 | mk2-mk1 | 1.065 | 0.72 |



Measurement of 20dB Bandwidth

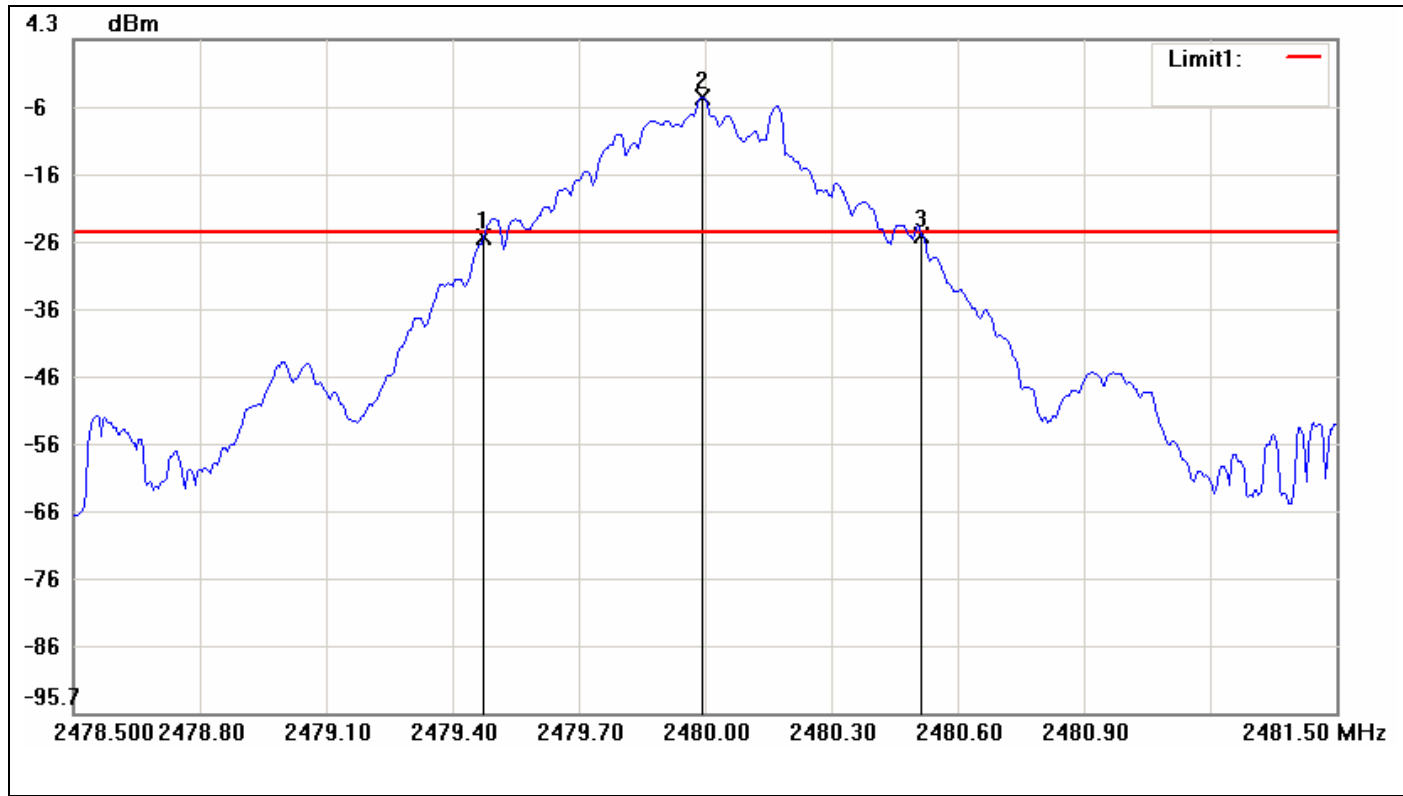

| No. | Frequency(MHz) | Level(dBm) | Limit(dBm) | Margin(dBm) |
|-----|----------------|------------|------------|-------------|
| 1 | 2479.4750 | -25.05 | -24.29 | -0.76 |
| 2 | 2479.9950 | -4.29 | -24.29 | 20.00 |
| 3 | 2480.5150 | -24.77 | -24.29 | -0.48 |

| No. | | Δ Frequency(MHz) | Δ Level(dB) |
|-----|---------|-------------------------|--------------------|
| 1 | mk3-mk1 | 1.04 | 0.28 |



7.5 NUMBER OF HOPPING FREQUENCY

LIMIT

According to §15.247(a)(1)(ii), Frequency hopping systems operating in the 2400MHz-2483.5 MHz bands shall use at least 75 hopping frequencies.

Test Configuration

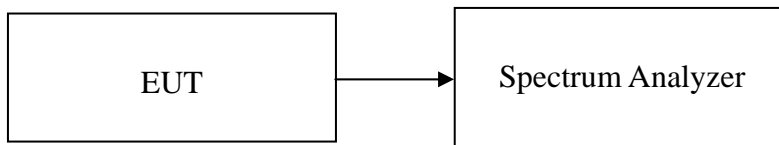

TEST PROCEDURE

1. Place the EUT on the table and set it in transmitting mode.
2. Remove the antenna from the EUT and then connect a low loss RF cable from the antenna port to the spectrum analyzer.
3. Set spectrum analyzer Start=2400MHz, Stop = 2430.5MHz, Sweep = auto, Start=2430.5MHz, Stop = 2460.5MHz, Sweep = auto and Start=2460.5MHz, Stop = 2485.5MHz, Sweep = auto.
4. Set the spectrum analyzer as RBW, VBW=300kHz.
5. Max hold, view and count how many channel in the band.

TEST RESULTS

No non-compliance noted

Test Data

| Result (No. of CH) | Limit (No. of CH) | Result |
|--------------------|-------------------|--------|
| 79 | >75 | PASS |



Test Plot

Channel Number

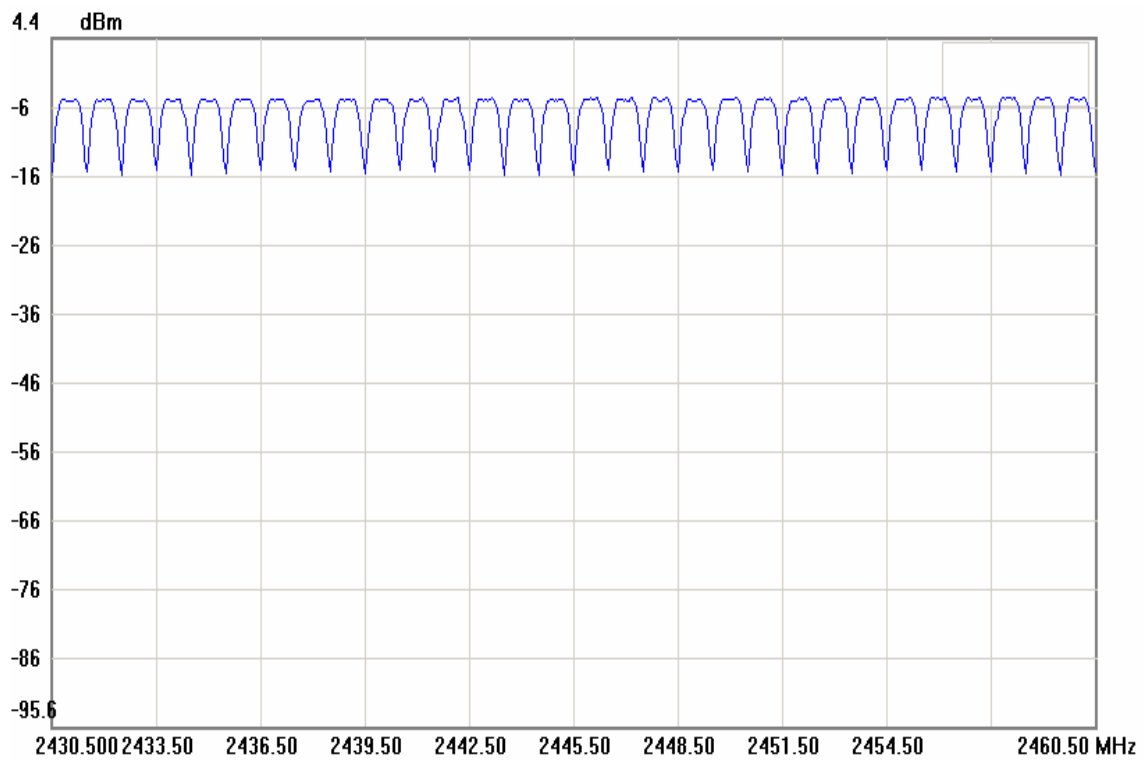
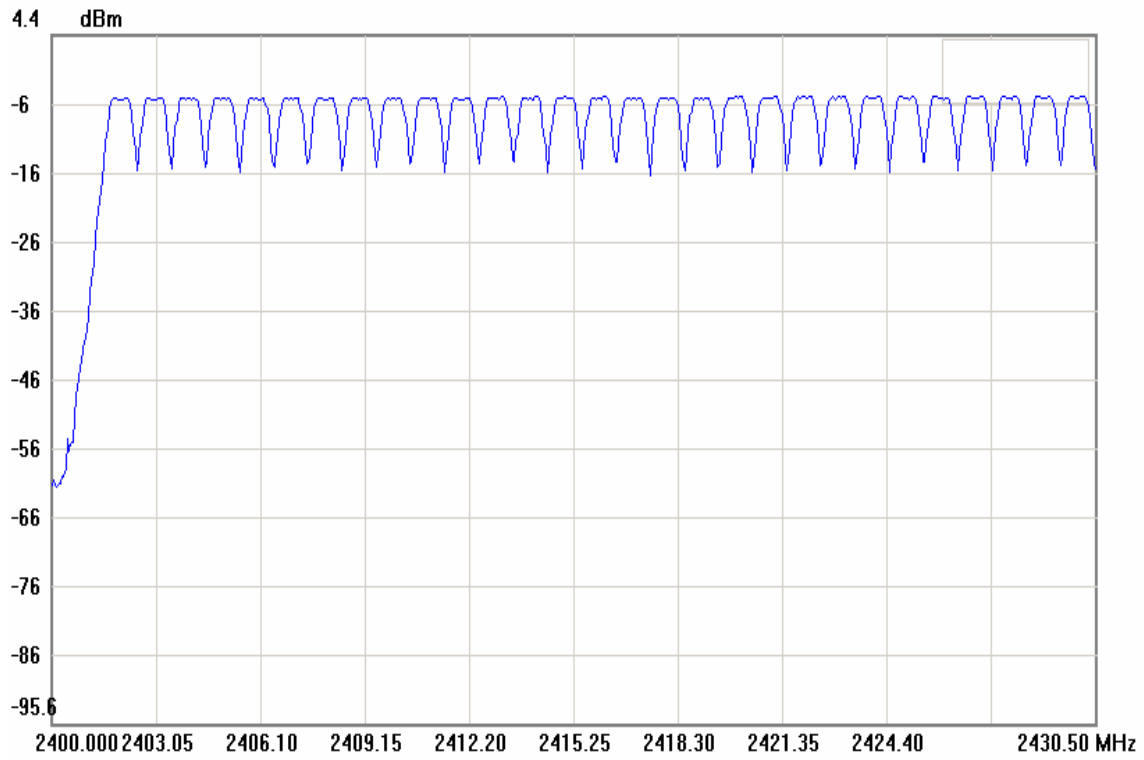

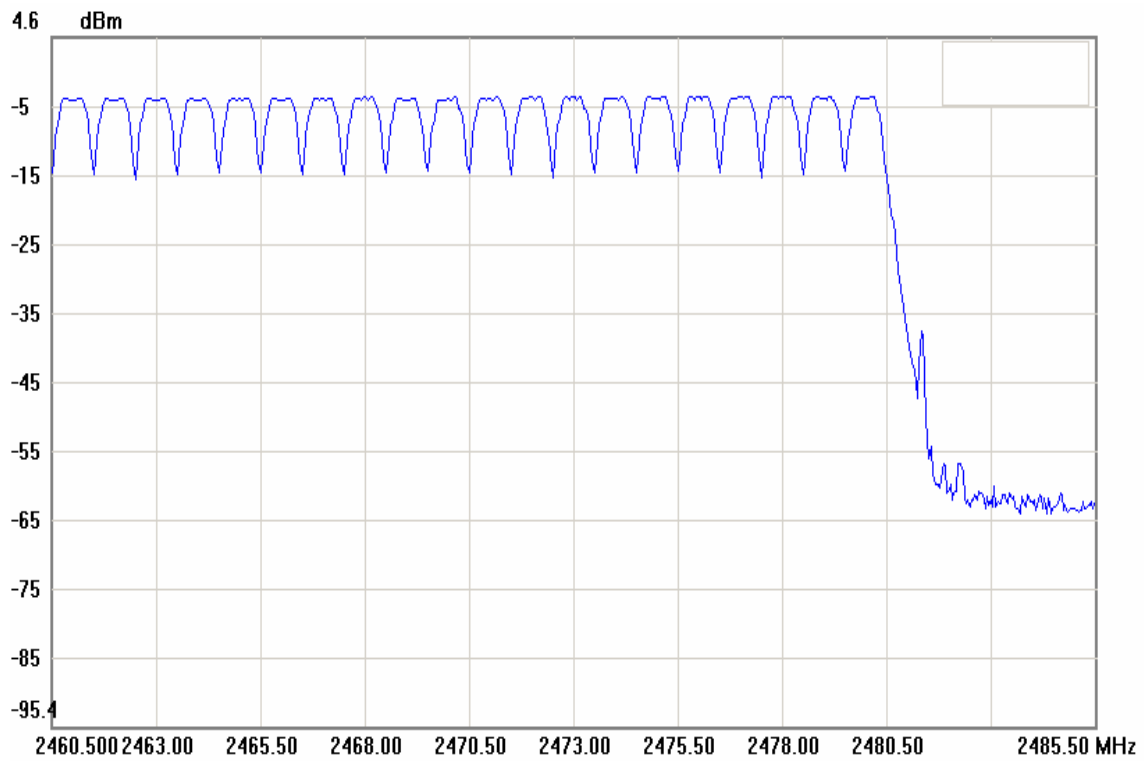



7.6 TIME OF OCCUPANCY (DWELL TIME)

LIMIT

According to §15.247(a)(1)(iii), Frequency hopping systems operating in the 2400MHz-2483.5 MHz bands. The average time of occupancy on any channels shall not greater than 0.4 s within a period 0.4 s multiplied by the number of hopping channels employed.

Test Configuration

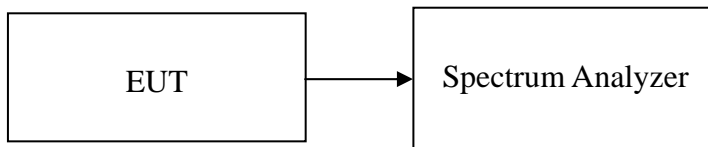

TEST PROCEDURE

1. Place the EUT on the table and set it in transmitting mode.
2. Remove the antenna from the EUT and then connect a low loss RF cable from the antenna port to the spectrum analyzer.
3. Set center frequency of spectrum analyzer = operating frequency.
4. Set the spectrum analyzer as RBW, VBW=1MHz, Span = 0Hz, Sweep = auto.
5. Repeat above procedures until all frequency measured were complete.

Test Data

DH 1: $0.4367 * (1600/2)/79 * 31.6 = 139.700$ (ms)

DH 3: $1.7000 * (1600/4)/79 * 31.6 = 272.000$ (ms)

DH 5: $2.9583 * (1600/6)/79 * 31.6 = 315.600$ (ms)

| | Pulse Time (ms) | Total of Dwell (ms) | Period Time (s) | Limit (ms) | Result |
|------|-----------------|---------------------|-----------------|------------|--------|
| DH 1 | 0.4367 | 139.700 | 31.60 | 400.00 | PASS |
| DH 3 | 1.7 | 272.000 | 31.60 | | PASS |
| DH 5 | 2.9583 | 315.600 | 31.60 | | PASS |



Test Plot

DH 1

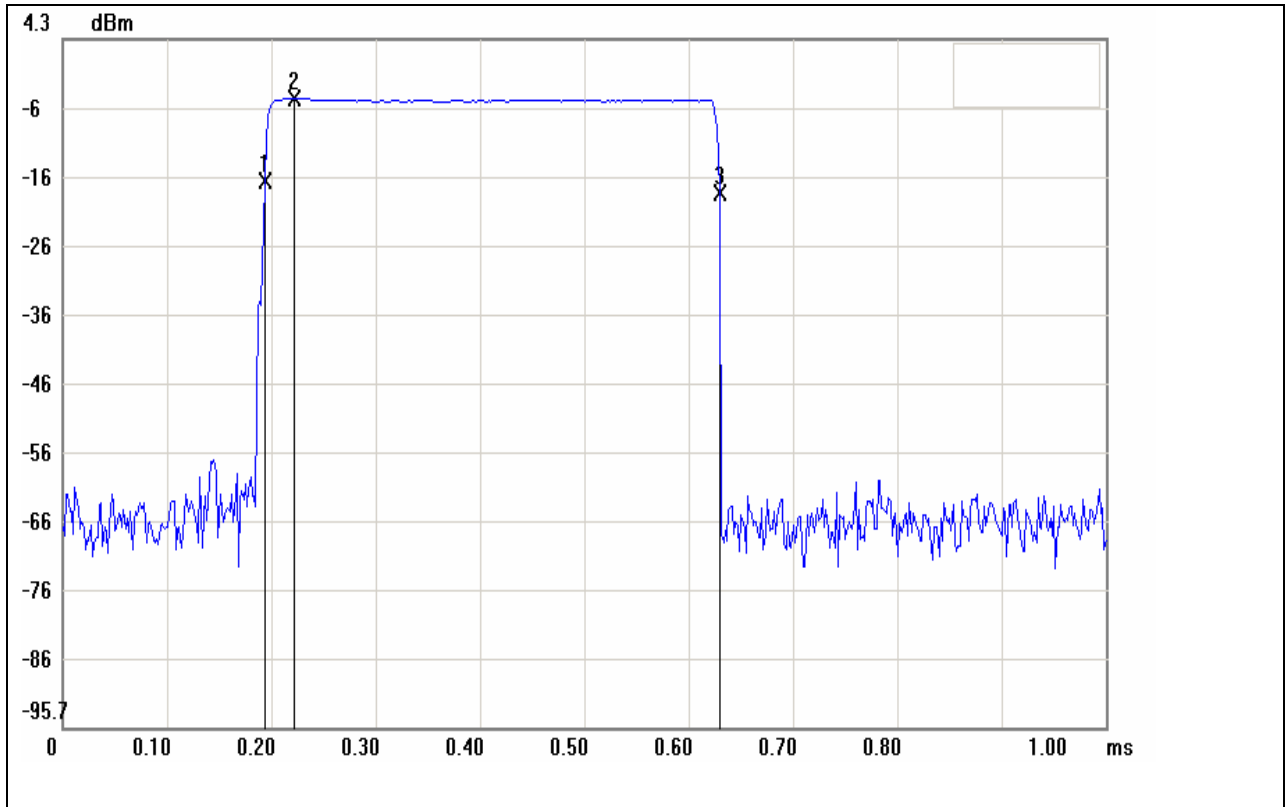

| No. | Sweep time(ms) | Level(dBm) | Limit(dBm) | Margin(dBm) |
|-----|----------------|------------|------------|-------------|
| 1 | 0.1933 | -16.30 | | |
| 2 | 0.2217 | -4.40 | | |
| 3 | 0.6300 | -18.05 | | |

| No. | | Δ Time(ms) | Δ Level(dB) |
|-----|---------|-------------------|--------------------|
| 1 | mk3-mk1 | 0.4367 | -1.75 |



DH 3

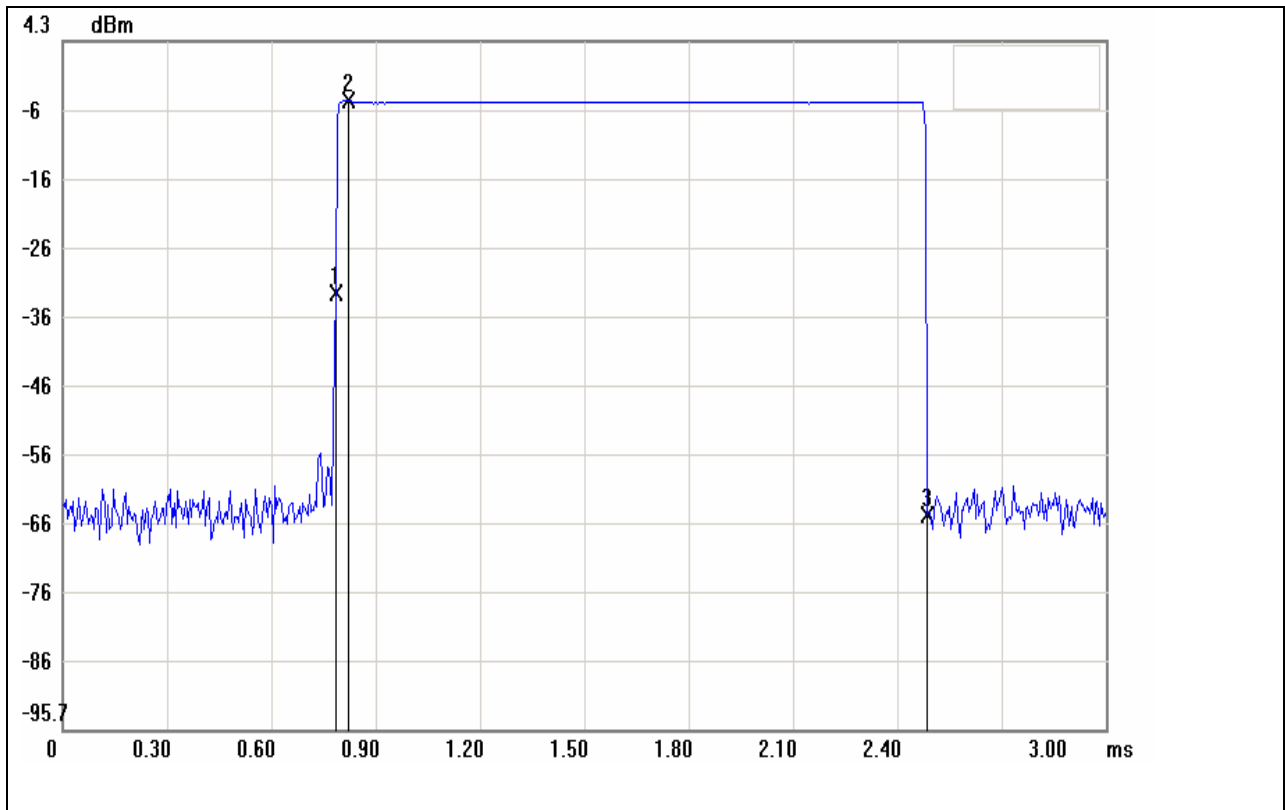

| No. | Sweep time(ms) | Level(dBm) | Limit(dBm) | Margin(dBm) |
|-----|----------------|------------|------------|-------------|
| 1 | 0.7850 | -32.35 | | |
| 2 | 0.8200 | -4.39 | | |
| 3 | 2.4850 | -64.60 | | |

| No. | | Δ Time(ms) | Δ Level(dB) |
|-----|---------|-------------------|--------------------|
| 1 | mk3-mk1 | 1.7 | -32.25 |



DH 5

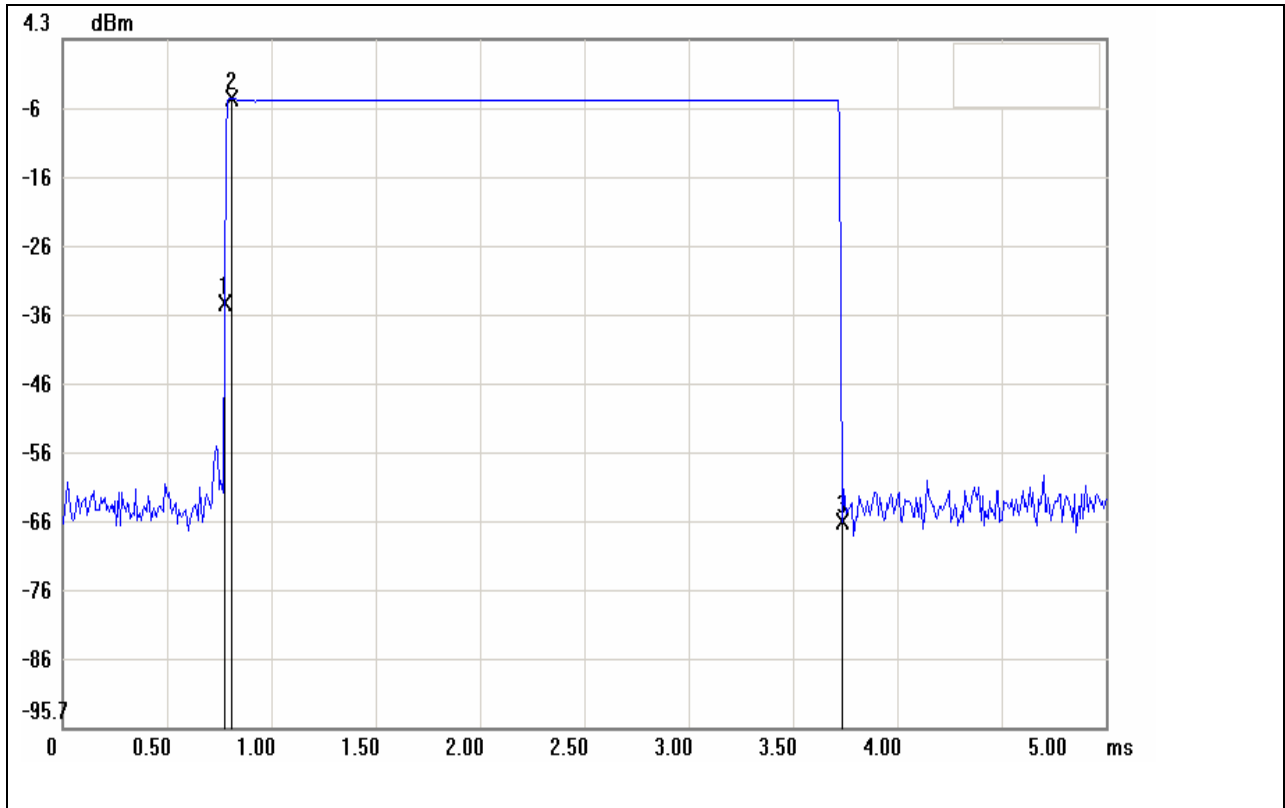

| No. | Sweep time(ms) | Level(dBm) | Limit(dBm) | Margin(dBm) |
|-----|----------------|------------|------------|-------------|
| 1 | 0.7750 | -33.99 | | |
| 2 | 0.8083 | -4.40 | | |
| 3 | 3.7333 | -65.82 | | |

| No. | | Δ Time(ms) | Δ Level(dB) |
|-----|---------|-------------------|--------------------|
| 1 | mk3-mk1 | 2.9583 | -31.83 |



7.7 SPURIOUS EMISSIONS

7.7.1 Conducted Measurement

LIMIT

According to §15.247(d), in any 100 kHz bandwidth outside the frequency bands in which the spread spectrum intentional radiator is operating, the radio frequency power that is produced by the intentional radiator shall be at least 20 dB below that in the 100 kHz bandwidth within the band that contains the highest level of the desired power, based on either an RF conducted or a radiated measurement, provided the transmitter demonstrates compliance with the peak conducted power limits. In addition, radiated emissions which fall in the restricted bands, as defined in §15.205(a), must also comply with the radiated emission limits specified in 15.209(a) (see Section 15.205(c)).

Test Configuration

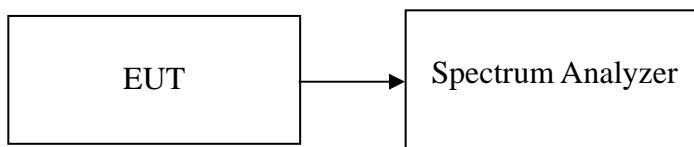

TEST PROCEDURE

Conducted RF measurements of the transmitter output were made to confirm that the EUT antenna port conducted emissions meet the specified limit and to identify any spurious signals that require further investigation or measurements on the radiated emissions site.

The transmitter output is connected to the spectrum analyzer. The resolution bandwidth is set to 100 kHz. The video bandwidth is set to 100 kHz.

Measurements are made over the 30MHz to 26GHz range with the transmitter set to the lowest, middle, and highest channels.

TEST RESULTS

No non-compliance noted



Test Plot

CH Low

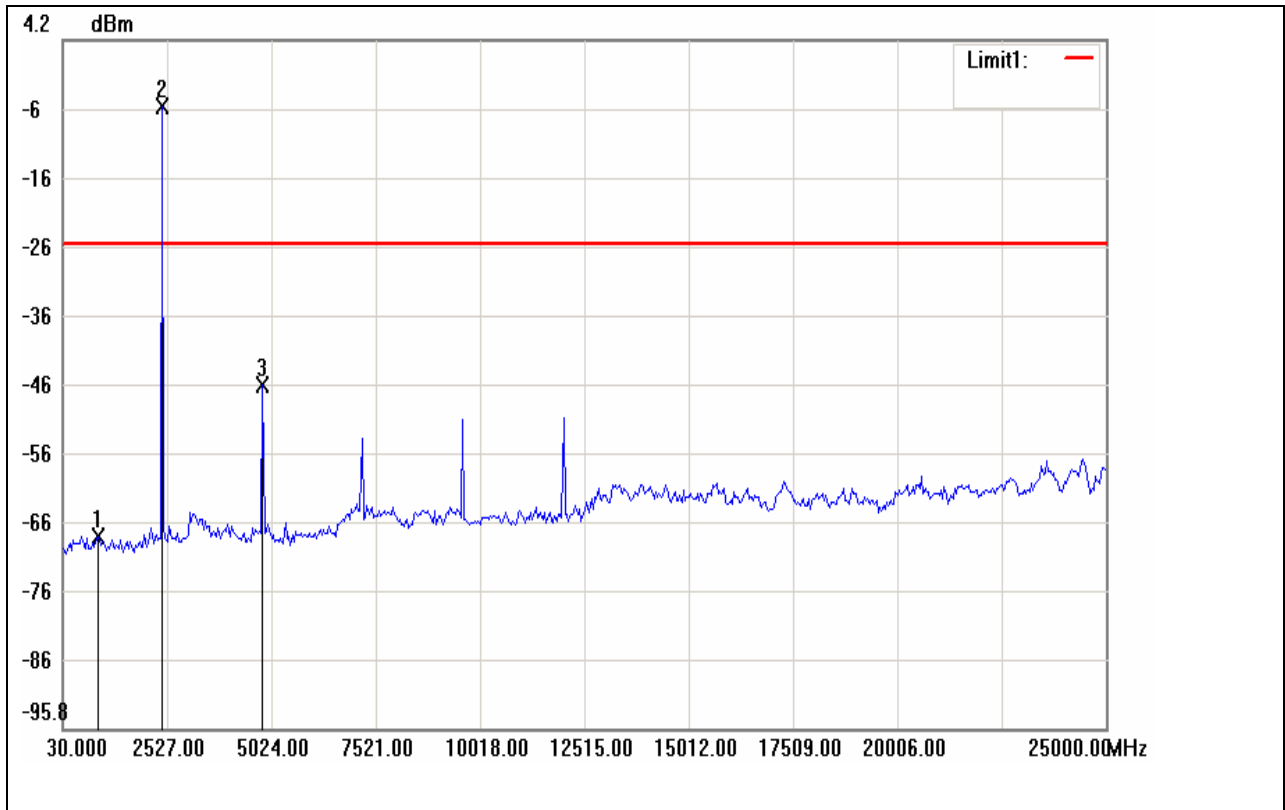

| No. | Frequency(MHz) | Level(dBm) | Limit(dBm) | Margin(dBm) |
|-----|----------------|------------|------------|-------------|
| 1 | 862.3333 | -67.84 | -25.49 | -42.35 |
| 2 | 2402.1500 | -5.49 | -25.49 | 20.00 |
| 3 | 4815.9167 | -45.96 | -25.49 | -20.47 |



CH Mid

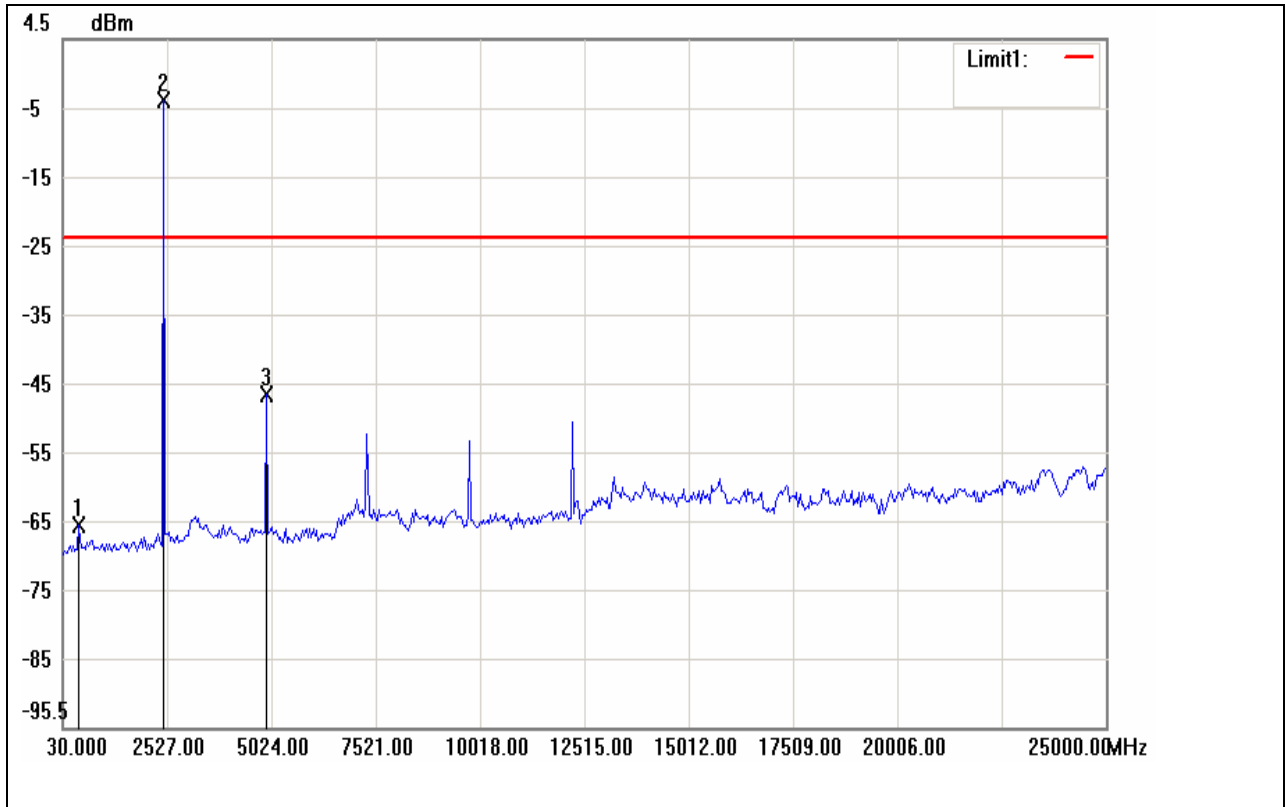

| No. | Frequency(MHz) | Level(dBm) | Limit(dBm) | Margin(dBm) |
|-----|----------------|------------|------------|-------------|
| 1 | 404.5500 | -66.12 | -24.36 | -41.76 |
| 2 | 2443.7667 | -4.36 | -24.36 | 20.00 |
| 3 | 4899.1500 | -47.01 | -24.36 | -22.65 |



CH High

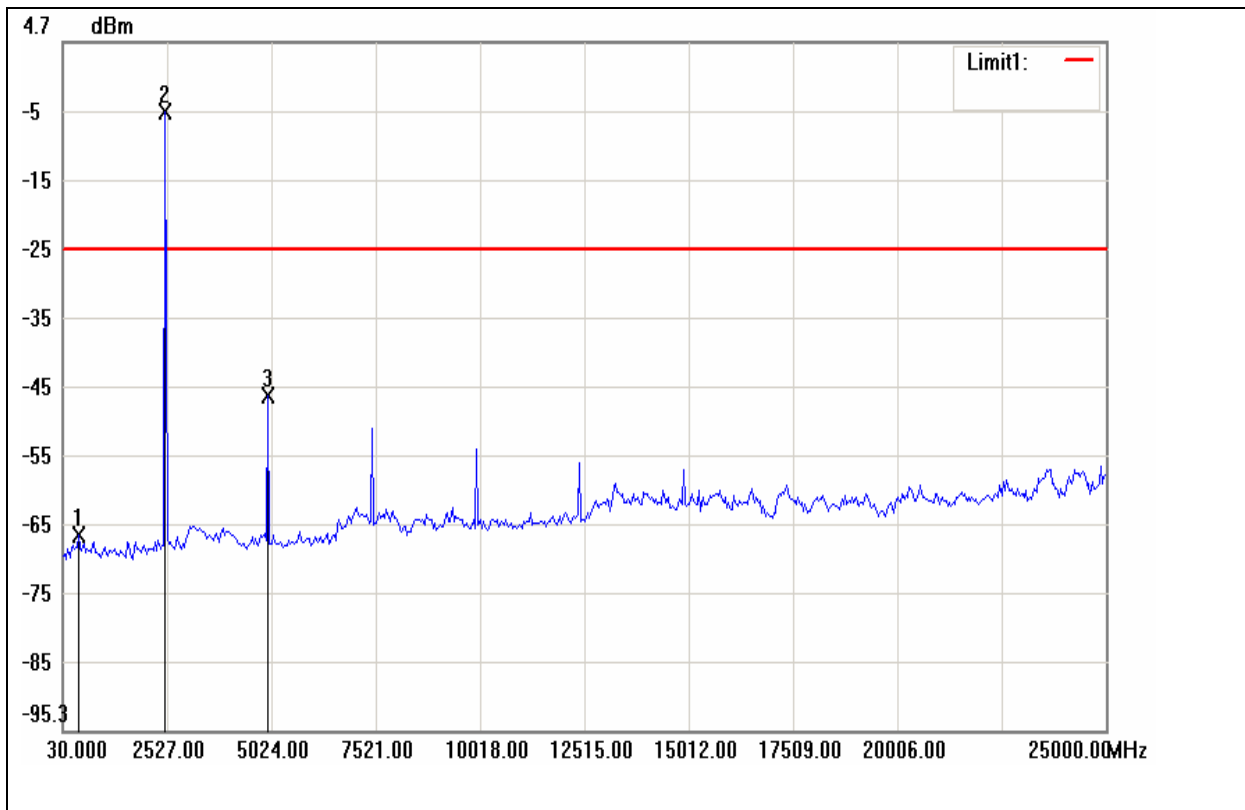

| No. | Frequency(MHz) | Level(dBm) | Limit(dBm) | Margin(dBm) |
|-----|----------------|------------|------------|-------------|
| 1 | 404.5500 | -66.96 | -25.50 | -41.46 |
| 2 | 2485.3833 | -5.50 | -25.50 | 20.00 |
| 3 | 4940.7667 | -46.56 | -25.50 | -21.06 |



7.7.2 Radiated Emissions

LIMIT

1. According to §15.209(a), except as provided elsewhere in this Subpart, the emissions from an intentional radiator shall not exceed the field strength levels specified in the following table:

| Frequency (MHz) | Field Strength ($\mu\text{V/m}$) | Measurement Distance (m) |
|-----------------|------------------------------------|--------------------------|
| 30-88 | 100* | 3 |
| 88-216 | 150* | 3 |
| 216-960 | 200* | 3 |
| Above 960 | 500 | 3 |

Remark: Except as provided in paragraph (g), fundamental emissions from intentional radiators operating under this Section shall not be located in the frequency bands 54-72 MHz, 76-88 MHz, 174-216 MHz or 470-806 MHz. However, operation within these frequency bands is permitted under other sections of this Part, e.g., Sections 15.231 and 15.241.

2. In the emission table above, the tighter limit applies at the band edges.

| Frequency (MHz) | Field Strength ($\mu\text{V/m}$ at 3-meter) | Field Strength (dB $\mu\text{V/m}$ at 3-meter) |
|-----------------|--|--|
| 30-88 | 100 | 40 |
| 88-216 | 150 | 43.5 |
| 216-960 | 200 | 46 |
| Above 960 | 500 | 54 |



Test Configuration

9kHz ~ 30MHz

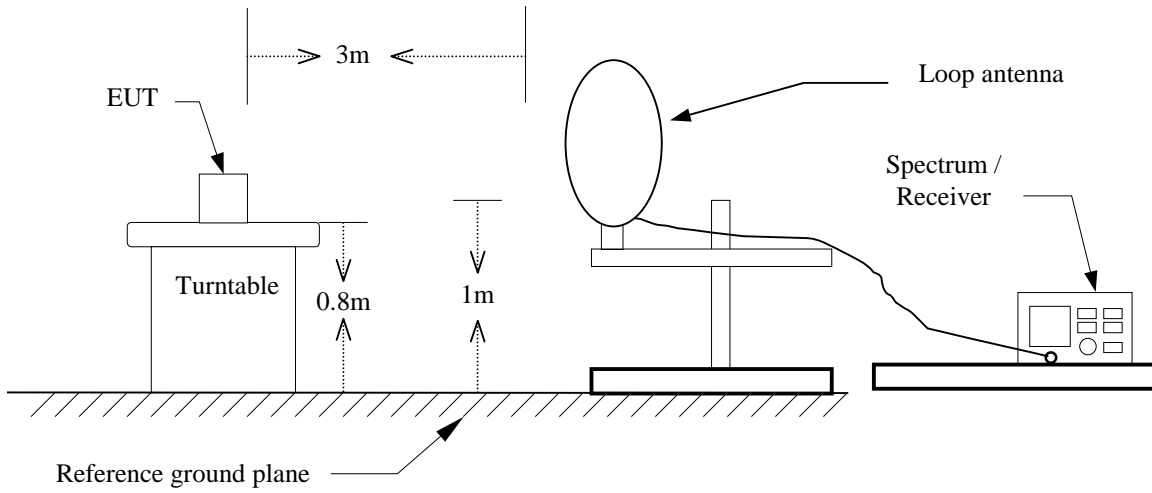

30MHz ~ 1GHz

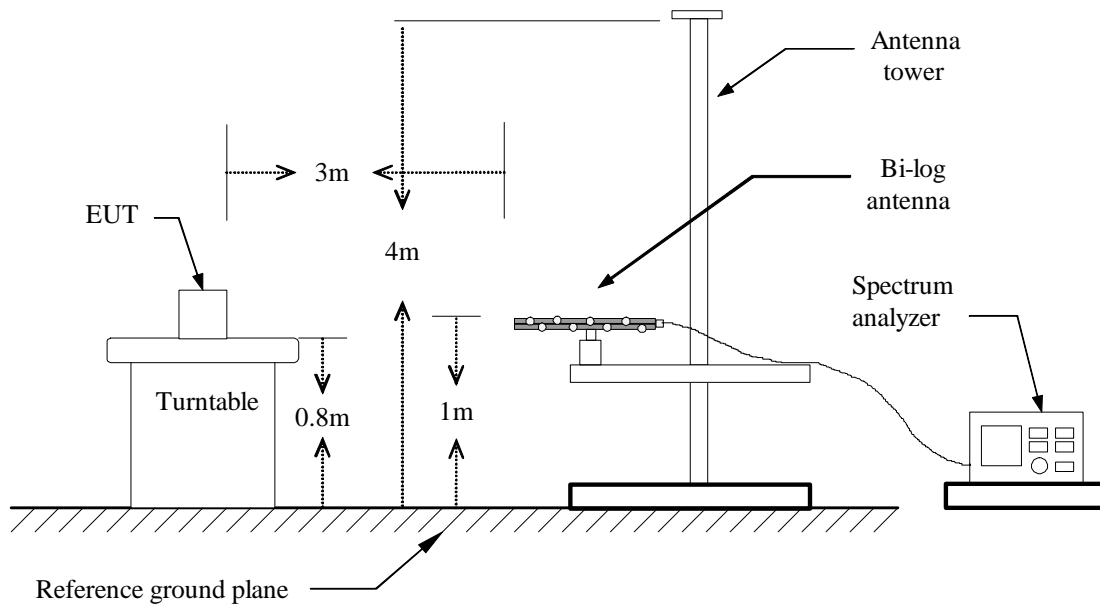



Above 1 GHz

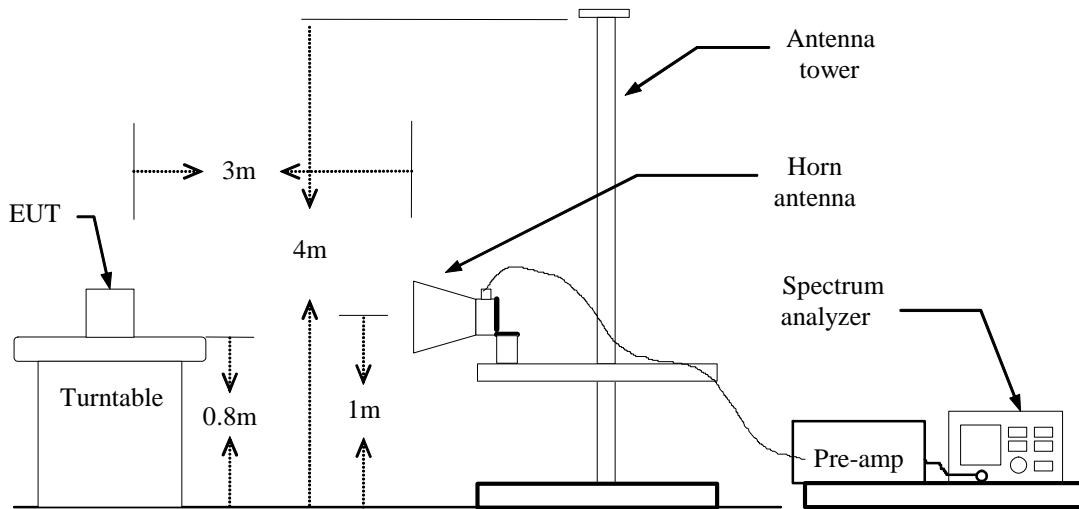



TEST PROCEDURE

1. The EUT is placed on a turntable, which is 0.8m above ground plane.
2. The turntable shall be rotated for 360 degrees to determine the position of maximum emission level.
3. EUT is set 3m away from the receiving antenna, which is varied from 1m to 4m to find out the highest emissions.
4. Maximum procedure was performed on the six highest emissions to ensure EUT compliance.
5. And also, each emission was to be maximized by changing the polarization of receiving antenna both horizontal and vertical.
6. Set the spectrum analyzer in the following setting as:
Below 1GHz:
RBW=100kHz / VBW=300kHz / Sweep=AUTO
Above 1GHz:
(a) PEAK: RBW=1MHz / VBW=3MHz / Sweep=AUTO
(b) AVERAGE: RBW=1MHz / VBW=10Hz / Sweep=AUTO
7. Repeat above procedures until the measurements for all frequencies are complete.

**Below 1 GHz****Operation Mode:** Normal Link**Test Date:** December 29, 2012**Temperature:** 27°C**Tested by:** Shawn Wu**Humidity:** 53 % RH**Polarity:** Ver. / Hor.

| Frequency (MHz) | Reading (dBuV) | Correction Factor (dB/m) | Result (dBuV/m) | Limit (dBuV/m) | Margin (dB) | Remark | Ant.Pol. (H/V) |
|-----------------|----------------|--------------------------|-----------------|----------------|-------------|--------|----------------|
| 31.6167 | 55.97 | -21.64 | 34.33 | 40.00 | -5.67 | Peak | V |
| 144.7833 | 51.89 | -28.77 | 23.12 | 43.50 | -20.38 | Peak | V |
| 167.4167 | 55.32 | -29.67 | 25.65 | 43.50 | -17.85 | Peak | V |
| 191.6667 | 53.46 | -29.37 | 24.09 | 43.50 | -19.41 | Peak | V |
| 215.9167 | 52.35 | -29.84 | 22.51 | 43.50 | -20.99 | Peak | V |
| 448.7167 | 45.94 | -24.24 | 21.70 | 46.00 | -24.30 | Peak | V |
| 144.7833 | 58.91 | -28.77 | 30.14 | 43.50 | -13.36 | Peak | H |
| 191.6667 | 62.14 | -29.37 | 32.77 | 43.50 | -10.73 | Peak | H |
| 215.9167 | 66.49 | -29.84 | 36.65 | 43.50 | -6.85 | Peak | H |
| 264.4167 | 60.76 | -28.60 | 32.16 | 46.00 | -13.84 | Peak | H |
| 311.3000 | 56.59 | -27.47 | 29.12 | 46.00 | -16.88 | Peak | H |
| 359.8000 | 50.48 | -26.36 | 24.12 | 46.00 | -21.88 | Peak | H |

Remark:

1. No emission found between lowest internal used/generated frequency to 30MHz (9kHz~30MHz).
2. Radiated emissions measured were made with an instrument using peak/quasi-peak detector mode.
3. Quasi-peak test would be performed if the peak result were greater than the quasi-peak limit or as required by the applicant.
4. Measurements above show only up to 6 maximum emissions noted, or would be lesser, with " N/A " remark, if no specific emissions from the EUT are recorded (ie: margin>20dB from the applicable limit) and considered that's already beyond the background noise floor.
5. $Margin (dB) = Remark\ result (dBuV/m) - Quasi-peak\ limit (dBuV/m).$



Above 1 GHz

Operation Mode: TX / CH Low

Test Date: December 29, 2012

Temperature: 27°C

Tested by: Shawn Wu

Humidity: 53 % RH

Polarity: Ver. / Hor.

| Frequency (MHz) | Reading (dBuV) | Correction (dB/m) | Result (dBuV/m) | Limit (dBuV/m) | Margin (dB) | Remark | Ant.Pol. (H/V) |
|-----------------|----------------|-------------------|-----------------|----------------|-------------|--------|----------------|
| 2826.667 | 66.06 | -17.08 | 48.98 | 74.00 | -25.02 | peak | V |
| 4800.000 | 60.26 | -12.37 | 47.89 | 74.00 | -26.11 | peak | V |
| 7208.333 | 62.02 | -7.48 | 54.54 | 74.00 | -19.46 | peak | V |
| 7208.333 | 55.97 | -7.48 | 48.49 | 54.00 | -5.51 | AVG | V |
| N/A | | | | | | | |
| | | | | | | | |
| 2766.667 | 65.03 | -17.23 | 47.80 | 74.00 | -26.20 | peak | H |
| 4800.000 | 60.60 | -12.37 | 48.23 | 74.00 | -25.77 | peak | H |
| 7208.333 | 63.06 | -7.48 | 55.58 | 74.00 | -18.42 | peak | H |
| 7208.333 | 58.17 | -7.48 | 50.69 | 54.00 | -3.31 | AVG | H |
| | | | | | | | |
| N/A | | | | | | | |

Remark:

1. Measuring frequencies from 1 GHz to the 10th harmonic of highest fundamental frequency.
2. Radiated emissions measured in frequency above 1000MHz were made with an instrument using peak/average detector mode.
3. Average test would be performed if the peak result were greater than the average limit or as required by the applicant.
4. Data of measurement within this frequency range shown “ --- ” in the table above means the reading of emissions are attenuated more than 20dB below the permissible limits or the field strength is too small to be measured.
5. Measurements above show only up to 6 maximum emissions noted, or would be lesser, with “ N/A ” remark, if no specific emissions from the EUT are recorded (ie: margin>20dB from the applicable limit) and considered that's already beyond the background noise floor.
6. Peak Margin (dB) = Peak result (dBuV/m) –Peak limit (dBuV/m).
Average Margin (dB) = Peak result (dBuV/m) – Average limit (dBuV/m).



Operation Mode: TX / CH Mid

Test Date: December 29, 2012

Temperature: 27°C

Tested by: Shawn Wu

Humidity: 53 % RH

Polarity: Ver. / Hor.

| Frequency (MHz) | Reading (dBuV) | Correction (dB/m) | Result (dBuV/m) | Limit (dBuV/m) | Margin (dB) | Remark | Ant.Pol. (H/V) |
|-----------------|----------------|-------------------|-----------------|----------------|-------------|--------|----------------|
| 1966.667 | 67.28 | -19.46 | 47.82 | 74.00 | -26.18 | peak | V |
| 4883.333 | 60.50 | -12.12 | 48.38 | 74.00 | -25.62 | peak | V |
| 7325.000 | 59.79 | -7.06 | 52.73 | 74.00 | -21.27 | peak | V |
| 7325.000 | 52.49 | -7.06 | 45.43 | 54.00 | -8.57 | AVG | V |
| N/A | | | | | | | |
| | | | | | | | |
| 2973.333 | 65.07 | -16.73 | 48.34 | 74.00 | -25.66 | peak | H |
| 4791.667 | 60.77 | -12.39 | 48.38 | 74.00 | -25.62 | peak | H |
| 4883.333 | 60.47 | -12.12 | 48.35 | 74.00 | -25.65 | peak | H |
| 7325.000 | 59.01 | -7.06 | 51.95 | 74.00 | -22.05 | peak | H |
| N/A | | | | | | | |
| | | | | | | | |

Remark:

1. Measuring frequencies from 1 GHz to the 10th harmonic of highest fundamental frequency.
2. Radiated emissions measured in frequency above 1000MHz were made with an instrument using peak/average detector mode.
3. Average test would be performed if the peak result were greater than the average limit or as required by the applicant.
4. Data of measurement within this frequency range shown “ --- ” in the table above means the reading of emissions are attenuated more than 20dB below the permissible limits or the field strength is too small to be measured.
5. Measurements above show only up to 6 maximum emissions noted, or would be lesser, with “ N/A ” remark, if no specific emissions from the EUT are recorded (ie: margin>20dB from the applicable limit) and considered that's already beyond the background noise floor.
6. Peak Margin (dB) = Peak result (dBuV/m) – Peak limit (dBuV/m).
Average Margin (dB) = Peak result (dBuV/m) – Average limit (dBuV/m).



Operation Mode: TX / CH High

Test Date: December 29, 2012

Temperature: 27°C

Tested by: Shawn Wu

Humidity: 53 % RH

Polarity: Ver. / Hor.

| Frequency (MHz) | Reading (dBuV) | Correction (dB/m) | Result (dBuV/m) | Limit (dBuV/m) | Margin (dB) | Remark | Ant.Pol. (H/V) |
|-----------------|----------------|-------------------|-----------------|----------------|-------------|--------|----------------|
| 2923.333 | 65.28 | -16.85 | 48.43 | 74.00 | -25.57 | peak | V |
| 4958.333 | 60.72 | -11.90 | 48.82 | 74.00 | -25.18 | peak | V |
| N/A | | | | | | | |
| | | | | | | | |
| | | | | | | | |
| 2830.000 | 64.80 | -17.07 | 47.73 | 74.00 | -26.27 | peak | H |
| 4958.333 | 61.14 | -11.90 | 49.24 | 74.00 | -24.76 | peak | H |
| 7441.667 | 57.39 | -6.63 | 50.76 | 74.00 | -23.24 | peak | H |
| N/A | | | | | | | |
| | | | | | | | |
| | | | | | | | |

Remark:

1. Measuring frequencies from 1 GHz to the 10th harmonic of highest fundamental frequency.
2. Radiated emissions measured in frequency above 1000MHz were made with an instrument using peak/average detector mode.
3. Average test would be performed if the peak result were greater than the average limit or as required by the applicant.
4. Data of measurement within this frequency range shown “ --- ” in the table above means the reading of emissions are attenuated more than 20dB below the permissible limits or the field strength is too small to be measured.
5. Measurements above show only up to 6 maximum emissions noted, or would be lesser; with “ N/A ” remark, if no specific emissions from the EUT are recorded (ie: margin>20dB from the applicable limit) and considered that's already beyond the background noise floor.
6. Peak Margin (dB) = Peak result (dBuV/m) – Peak limit (dBuV/m).
Average Margin (dB) = Peak result (dBuV/m) – Average limit (dBuV/m).



7.8 POWERLINE CONDUCTED EMISSIONS

LIMIT

According to §15.207(a), except as shown in paragraphs (b) and (c) of this section, for an intentional radiator that is designed to be connected to the public utility (AC) power line, the radio frequency voltage that is conducted back onto the AC power line on any frequency or frequencies within the band 150 kHz to 30 MHz shall not exceed the limits in the following table, as measured using a 50 μ H/50 ohms line impedance stabilization network (LISN). Compliance with the provisions of this paragraph shall be based on the measurement of the radio frequency voltage between each power line and ground at the power terminal. The lower limit applies at the boundary between the frequency ranges.

| Frequency Range (MHz) | Limits (dB μ V) | |
|-----------------------|---------------------|-----------|
| | Quasi-peak | Average |
| 0.15 to 0.50 | 66 to 56* | 56 to 46* |
| 0.50 to 5 | 56 | 46 |
| 5 to 30 | 60 | 50 |

* Decreases with the logarithm of the frequency.

Test Configuration

See test photographs attached in Appendix II for the actual connections between EUT and support equipment.

TEST PROCEDURE

1. The EUT was placed on a table, which is 0.8m above ground plane.
2. Maximum procedure was performed on the six highest emissions to ensure EUT compliance.
3. Repeat above procedures until all frequency measured were complete.



TEST RESULTS

The initial step in collecting conducted data is a spectrum analyzer peak scan of the measurement range. Significant peaks are then marked as shown on the following data page, and these signals are then quasi-peaked.

Test Data

Not applicable, because EUT does not connect to AC Main Source direct.