

ENGINEERING TEST REPORT

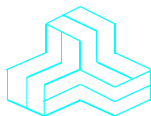

Psion Teklogix 'g' Radio Model No.: RA2040

FCC ID: GM3RA2040

Applicant:

Psion Teklogix Inc.
2100 Meadowvale Blvd.
Mississauga, ON
Canada, L5N 7J9

In Accordance With

**FEDERAL COMMUNICATIONS COMMISSION (FCC)
Part 15, Subpart C, Section 15.247
Digital Modulation Systems in 2400 - 2483.5 MHz Band**

UltraTech's File No.: TEK-508F15C247

This Test report is Issued under the Authority of
Tri M. Luu, Professional Engineer,
Vice President of Engineering
UltraTech Group of Labs



Date: October 27, 2005

Report Prepared by: Dan Huynh

Tested by: Hung Trinh

Issued Date: October 27, 2005

Test Dates: October 5-20, 2005

- *The results in this Test Report apply only to the sample(s) tested, and the sample tested is randomly selected.*
- *This report must not be used by the client to claim product endorsement by NVLAP or any agency of the US Government.*

UltraTech

3000 Bristol Circle, Oakville, Ontario, Canada, L6H 6G4
Tel.: (905) 829-1570 Fax.: (905) 829-8050

Website: www.ultratech-labs.com, Email: vic@ultratech-labs.com, Email: tri.luu@sympatico.ca



TABLE OF CONTENTS

EXHIBIT 1.	SUBMITTAL CHECK LIST	1
EXHIBIT 2.	INTRODUCTION.....	2
2.1.	SCOPE	2
2.2.	RELATED SUBMITTAL(S)/GRANT(S)	2
2.3.	NORMATIVE REFERENCES	2
EXHIBIT 3.	PERFORMANCE ASSESSMENT.....	3
3.1.	CLIENT INFORMATION	3
3.2.	EQUIPMENT UNDER TEST (EUT) INFORMATION	3
3.3.	EUT'S TECHNICAL SPECIFICATIONS.....	4
3.4.	LIST OF EUT'S PORTS.....	4
EXHIBIT 4.	EUT OPERATING CONDITIONS AND CONFIGURATIONS DURING TESTS.....	5
4.1.	CLIMATE TEST CONDITIONS.....	5
4.2.	OPERATIONAL TEST CONDITIONS & ARRANGEMENT FOR TESTS.....	5
EXHIBIT 5.	SUMMARY OF TEST RESULTS.....	6
5.1.	LOCATION OF TESTS	6
5.2.	APPLICABILITY & SUMMARY OF EMC EMISSION TEST RESULTS	6
5.3.	MODIFICATIONS INCORPORATED IN THE EUT FOR COMPLIANCE PURPOSES.....	6
EXHIBIT 6.	MEASUREMENTS, EXAMINATIONS & TEST DATA FOR EMC EMISSIONS.....	7
6.1.	TEST PROCEDURES.....	7
6.2.	MEASUREMENT UNCERTAINTIES	7
6.3.	MEASUREMENT EQUIPMENT USED	7
6.4.	ESSENTIAL/PRIMARY FUNCTIONS AS DECLARED BY THE MANUFACTURER	7
6.5.	POWER LINE CONDUCTED EMISSIONS [§15.207(a)].....	8
6.6.	BANDWIDTH [§ 15.247(a)(2)].....	16
6.7.	POWER OUTPUT [§ 15.247(b)]	39
6.8.	SPURIOUS CONDUCTED EMISSIONS [§ 15.247(d)]	42
6.9.	SPURIOUS RADIATED EMISSIONS @ 3 METERS [§ 15.247(d)].....	69
6.10.	POWER SPECTRAL DENSITY [§ 15.247(e)].....	81
6.11.	RF EXPOSURE REQUIRMENTS [§ 15.247(i), 1.1310 & 2.1091].....	104
EXHIBIT 7.	MEASUREMENT UNCERTAINTY.....	106
7.1.	LINE CONDUCTED EMISSION MEASUREMENT UNCERTAINTY	106
7.2.	RADIATED EMISSION MEASUREMENT UNCERTAINTY	107
EXHIBIT 8.	MEASUREMENT METHODS	108
8.1.	GENERAL TEST CONDITIONS	108
8.2.	METHOD OF MEASUREMENTS - AC MAINS CONDUCTED EMISSIONS	109
8.3.	SPURIOUS EMISSIONS (CONDUCTED & RADIATED).....	110

EXHIBIT 1. SUBMITTAL CHECK LIST

Annex No.	Exhibit Type	Description of Contents	Quality Check (OK)
--	Test Report	Test Report	OK
1	Test Setup Photos	Radiated Emissions Setup Photos	OK
2	External Photos	External EUT Photos	OK
3	Internal Photos	Internal EUT Photos	OK
4	Cover Letters	<ul style="list-style-type: none">▪ Letter from Ultratech for Certification Request▪ Letter from the Applicant to appoint Ultratech to act as an agent▪ Letter from the Applicant to request for Confidentiality Filing	OK
5	Attestation Statements	--	--
6	ID Label/Location Info	<ul style="list-style-type: none">▪ ID Label▪ Location of ID Label	OK
7	Block Diagrams	Block Diagram	OK
8	Schematic Diagrams	Schematic diagrams	OK
9	Parts List/Tune Up Info	--	--
10	Operational Description	Operational Description	OK
11	RF Exposure Info	See Section 6.11 of this test report for MPE evaluation	OK
12	Users Manual	Users Manual	OK

ULTRATECH GROUP OF LABS

3000 Bristol Circle, Oakville, Ontario, Canada L6H 6G4
Tel. #: 905-829-1570, Fax. #: 905-829-8050, Email: vic@ultratech-labs.com, Website: <http://www.ultratech-labs.com>

File #: TEK-508F15C247

October 27, 2005

All test results contained in this engineering test report are traceable to National Institute of Standards and Technology (NIST)

EXHIBIT 2. INTRODUCTION

2.1. SCOPE

Reference:	FCC Part 15, Subpart C, Section 15.247
Title:	Code of Federal Regulations (CFR), Title 47 - Telecommunication, Part 15
Purpose of Test:	To gain FCC Equipment Authorization for Digital Modulation Systems operating in the Frequency Band 2400 - 2483.5 MHz
Test Procedures	Both conducted and radiated emissions measurements were conducted in accordance with American National Standards Institute ANSI C63.4 - American National Standard for Methods of Measurement of Radio-Noise Emissions from Low-Voltage Electrical and Electronic Equipment in the Range of 9 kHz to 40 GHz.
Environmental Classification:	Commercial, industrial or business environment.

2.2. RELATED SUBMITTAL(S)/GRANT(S)

None.

2.3. NORMATIVE REFERENCES

Publication	Year	Title
FCC CFR Parts 0-19	2005	Code of Federal Regulations – Telecommunication
ANSI C63.4	2003	American National Standard for Methods of Measurement of Radio-Noise Emissions from Low-Voltage Electrical and Electronic Equipment in the Range of 9 kHz to 40 GHz
CISPR 22 & EN 55022	2003 2003	Limits and Methods of Measurements of Radio Disturbance Characteristics of Information Technology Equipment
CISPR 16-1	2003	Specification for Radio Disturbance and Immunity measuring apparatus and methods
FCC Public Notice DA 00-1407	2000	Part 15 Unlicensed Modular Transmitter Approval
FCC ET Docket No. 99-231	2002	Amendment to FCC Part 15 of the Commission's Rules Regarding to Spread Spectrum Devices
KDB Publication No. 558074	2005	Guidance on Measurements for Digital Transmission Systems (47 CFR 15.247)

ULTRATECH GROUP OF LABS

3000 Bristol Circle, Oakville, Ontario, Canada L6H 6G4
Tel. #: 905-829-1570, Fax. #: 905-829-8050, Email: vic@ultratech-labs.com, Website: <http://www.ultratech-labs.com>

File #: TEK-508F15C247

October 27, 2005

All test results contained in this engineering test report are traceable to National Institute of Standards and Technology (NIST)

EXHIBIT 3. PERFORMANCE ASSESSMENT

3.1. CLIENT INFORMATION

APPLICANT	
Name:	Psion Teklogix Inc.
Address:	2100 Meadowvale Blvd. Mississauga, ON Canada, L5N 7J9
Contact Person:	Mr. Sada Dharwarkar Phone #: 905-812-6200 (3358) Fax #: 905-812-6301 Email Address: Sada.Dharwarkar@psionteklogix.com

MANUFACTURER	
Name:	Psion Teklogix Inc.
Address:	2100 Meadowvale Blvd. Mississauga, ON Canada, L5N 7J9
Contact Person:	Mr. Sada Dharwarkar Phone #: 905-812-6200 (3358) Fax #: 905-812-6301 Email Address: Sada.Dharwarkar@psionteklogix.com

3.2. EQUIPMENT UNDER TEST (EUT) INFORMATION

The following information (with the exception of the Date of Receipt) has been supplied by the applicant.

Brand Name	Psion Teklogix Inc.
Product Name	Psion Teklogix 'g' Radio
Model Name or Number	RA2040
Serial Number	N/A
Type of Equipment	Digital Modulation Systems
Input Power Supply Type	DC 3.3V from expansion PC card
Primary User Functions of EUT:	To transmit and receiver data

3.3. EUT'S TECHNICAL SPECIFICATIONS

TRANSMITTER	
Equipment Type:	Modular Transceiver for Mobile and Fixed Base
Intended Operating Environment:	Commercial, light industry & heavy industry
Power Supply Requirement:	DC 3.3V
RF Output Power Rating:	802.11b: 15 dBm (32 mW) \pm 1.5 dBm 802.11g: 13 dBm (20 mW) \pm 1.5 dBm
Operating Frequency Range:	2412 - 2462 MHz
RF Output Impedance:	50 Ohms
6 dB Bandwidth:	16.65 MHz
Modulation Type:	DBPSK, DQPSK, CCK, 16QAM, 64QAM
Oscillator Frequencies:	40 MHz
Antenna Connector Type:	SMA Reverse Polarity
Antenna Description:	Manufacturer: Mobile Mark Type: Collinear Model: MAG5-2400 Frequency Range: 2400-2500 MHz Gain: 5 dBi

3.4. LIST OF EUT'S PORTS

Port Number	EUT's Port Description	Number of Identical Ports	Connector Type	Cable Type (Shielded/Non-shielded)
1	Antenna Connector	1	U.FL HIROSE JACK	Shielded coaxial
2	CF Connector	1	50 Pin CF	None-Plugs in to 50 pin CF connector in the host

EXHIBIT 4. EUT OPERATING CONDITIONS AND CONFIGURATIONS DURING TESTS

4.1. CLIMATE TEST CONDITIONS

The climate conditions of the test environment are as follows:

Temperature:	21°C
Humidity:	51%
Pressure:	102 kPa
Power input source:	DC 3.3V

4.2. OPERATIONAL TEST CONDITIONS & ARRANGEMENT FOR TESTS

Operating Modes:	<ul style="list-style-type: none"> ▪ Each of lowest, middle and highest channel frequencies transmits continuously for emissions measurements. ▪ The EUT operates in normal Direct Sequence mode for occupancy duration, and frequency separation.
Special Test Software:	Special software is provided by the Applicant to select and operate the EUT at each channel frequency continuously. For example, the transmitter will be operated at each of lowest, middle and highest frequencies individually continuously during testing.
Special Hardware Used:	The RS2040 Radio Module was mounted on top of an expansion PC card, which is plugged in the laptop so that the radio module can be tested outside of the enclosure.
Transmitter Test Antenna:	The antenna was connected to the EUT for RF interference measurements.

Transmitter Test Signals	
Frequency Band(s):	2412-2462 MHz
Frequency(ies) Tested: (Near lowest, near middle & near highest frequencies in the frequency range of operation.)	2412 MHz, 2437 MHz and 2462 MHz
RF Power Output: (measured maximum output power at antenna terminals)	16.44 dBm (0.044 W)
Normal Test Modulation:	DBPSK, DQPSK, CCK, 16QAM, 64QAM
Modulating Signal Source:	Internal

EXHIBIT 5. SUMMARY OF TEST RESULTS

5.1. LOCATION OF TESTS

All of the measurements described in this report were performed at Ultratech Group of Labs located in the city of Oakville, Province of Ontario, Canada.

- AC power line conducted emissions were performed in UltraTech's shielded room, 24'(L) by 16'(W) by 8'(H).
- Radiated emissions were performed at the Ultratech's 3-10 TDK Semi-Anechoic Chamber situated in the Town of Oakville, province of Ontario. This test site been calibrated in accordance with ANSI C63.4, and found to be in compliance with the requirements of Sec. 2.948 of the FCC Rules. The descriptions and site measurement data of the Oakville 3-10 TDK Semi-Anechoic Chamber has been filed with FCC office (FCC File No.: 31040/SIT 1300B3) and Industry Canada office (Industry Canada File No.: IC2049-1). Last Date of Site Calibration: June. 20, 2005.

5.2. APPLICABILITY & SUMMARY OF EMC EMISSION TEST RESULTS

FCC Section(s)	Test Requirements	Compliance (Yes/No)
FCC DA 00-1407	Un-licensed Modular Transmitter Approval Requirements	Yes
15.207(a)	Power Line Conducted Emissions	Yes
15.247(a)(2)	Bandwidth	Yes
15.247(b)	Power Output	Yes
15.247(d)	Spurious Conducted Emissions	Yes
15.247(d)	Spurious Radiated Emissions	Yes
15.247(e)	Power Spectral Density	Yes
15.247(i)	RF Safety	Yes
15.109(a)	Unintentional Radiators - Radiated Emission	Yes, See Note 1

Note 1: A separate engineering test report for compliance with FCC Part 15, Subpart B - Class B Unintentional Radiators will be provided upon request.

5.3. MODIFICATIONS INCORPORATED IN THE EUT FOR COMPLIANCE PURPOSES

None.

ULTRATECH GROUP OF LABS

3000 Bristol Circle, Oakville, Ontario, Canada L6H 6G4
Tel. #: 905-829-1570, Fax. #: 905-829-8050, Email: vic@ultratech-labs.com, Website: <http://www.ultratech-labs.com>

File #: TEK-508F15C247

October 27, 2005

All test results contained in this engineering test report are traceable to National Institute of Standards and Technology (NIST)

EXHIBIT 6. MEASUREMENTS, EXAMINATIONS & TEST DATA FOR EMC EMISSIONS

6.1. TEST PROCEDURES

This section contains test results only. Details of test methods and procedures can be found in Exhibit 8 of this report, KDB Publication No. 558074: Guidance on Measurements for Digital Transmission Systems (47 CFR 15.247) and ANSI C63.4:2003.

6.2. MEASUREMENT UNCERTAINTIES

The measurement uncertainties stated were calculated in accordance with requirements of UKAS Document NIS 81 with a confidence level of 95%. Please refer to Exhibit 7 for Measurement Uncertainties.

6.3. MEASUREMENT EQUIPMENT USED

The measurement equipment used complied with the requirements of the Standards referenced in the Methods & Procedures ANSI C63.4:2003 and CISPR 16-1.

6.4. ESSENTIAL/PRIMARY FUNCTIONS AS DECLARED BY THE MANUFACTURER

The essential function of the EUT is to correctly communicate data to and from radios over RF link.

6.5. POWER LINE CONDUCTED EMISSIONS [§15.207(a)]

6.5.1. Limits

The equipment shall meet the limits of the following table:

Frequency of emission (MHz)	Conducted Limits (dB μ V)	
	Quasi-peak	Average
0.15–0.5	66 to 56*	56 to 46*
0.5–5	56	46
5–30	60	50

* Decreases with logarithm of the frequency.

6.5.2. Method of Measurements

See Section 8.2 of this test report & ANSI C63.4

6.5.3. Test Arrangement

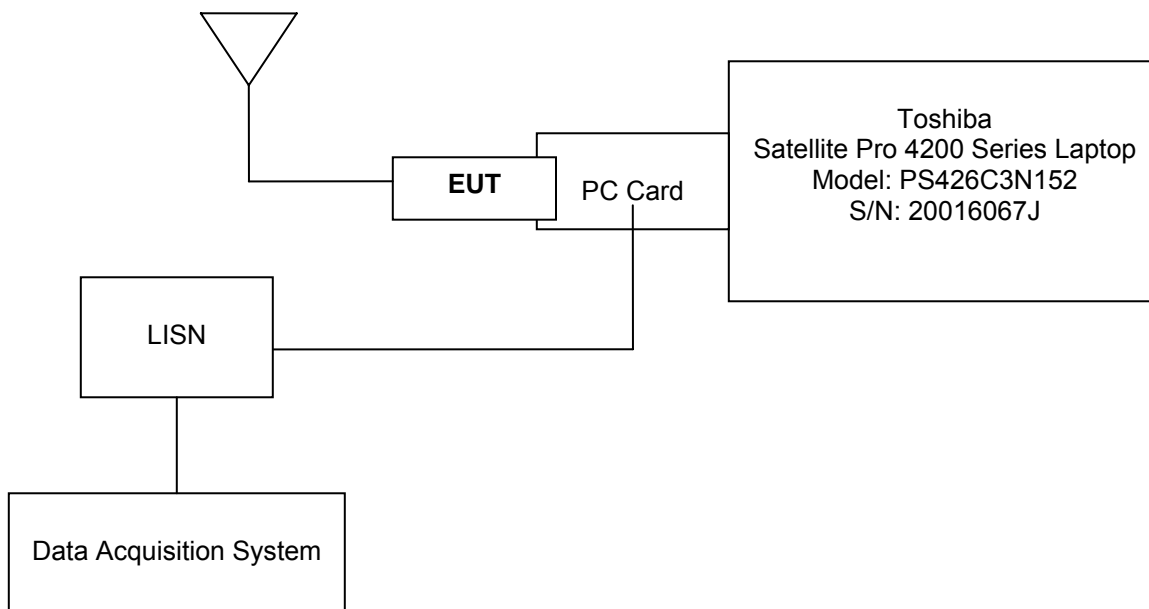

6.5.4. Test Equipment List

Test Instruments	Manufacturer	Model No.	Serial No.	Frequency Range
Spectrum Analyzer/ EMI Receiver	Hewlett Packard	HP 8593EM	3412A00103	9 kHz – 26.5 GHz
Transient Limiter	Hewlett Packard	11947A	310701998	9 kHz – 200 MHz 10 dB attenuation
L.I.S.N.	EMCO	3825/2	89071531	9 kHz – 200 MHz 50 Ohms / 50 μ H
24'(L) x 16'(W) x 8'(H) RF Shielded Chamber	Braden Shielding

ULTRATECH GROUP OF LABS

3000 Bristol Circle, Oakville, Ontario, Canada L6H 6G4
Tel. #: 905-829-1570, Fax. #: 905-829-8050, Email: vic@ultratech-labs.com, Website: <http://www.ultratech-labs.com>

File #: TEK-508F15C247

October 27, 2005

All test results contained in this engineering test report are traceable to National Institute of Standards and Technology (NIST)

6.5.5. Test Data

Frequency (MHz)	RF Level (dBμV)	Receiver Detector (P/QP/AVG)	QP Limit (dBUV)	AVG Limit (dBUV)	Margin (dB)	Pass/ Fail	Line Tested (Pos/Neg)
Test Configuration #1: Tx Mode							
0.656645	44.1	QP	56.0	46.0	-11.9	Pass	Pos
0.656645	42.4	AVG	56.0	46.0	-3.6	Pass	Pos
0.765840	44.4	QP	56.0	46.0	-11.6	Pass	Pos
0.765840	44.1	AVG	56.0	46.0	-1.9	Pass	Pos
1.093770	42.7	QP	56.0	46.0	-13.3	Pass	Pos
1.093770	42.2	AVG	56.0	46.0	-3.8	Pass	Pos
5.579510	41.0	QP	60.0	50.0	-19.0	Pass	Pos
5.579510	38.9	AVG	60.0	50.0	-11.1	Pass	Pos
9.955305	37.2	QP	60.0	50.0	-22.8	Pass	Pos
9.955305	34.8	AVG	60.0	50.0	-15.2	Pass	Pos
0.657860	43.6	QP	56.0	46.0	-12.4	Pass	Neg
0.657860	41.6	AVG	56.0	46.0	-4.4	Pass	Neg
0.767555	44.0	QP	56.0	46.0	-12.0	Pass	Neg
0.767555	43.7	AVG	56.0	46.0	-2.3	Pass	Neg
1.095660	42.4	QP	56.0	46.0	-13.6	Pass	Neg
1.095660	41.8	AVG	56.0	46.0	-4.2	Pass	Neg
5.589520	40.4	QP	60.0	50.0	-19.6	Pass	Neg
5.589520	37.0	AVG	60.0	50.0	-13.0	Pass	Neg
8.877075	38.7	QP	60.0	50.0	-21.3	Pass	Neg
8.877075	33.6	AVG	60.0	50.0	-16.4	Pass	Neg

Note: See the following plots for detailed measurements

Plot 6.5.5.1
 Power Line Conducted Emissions (Tx Mode)
 Line Voltage: DC 3.3 V
 Line Tested: Pos

177

Signal	Freq (MHz)	PK Amp	QP Amp	AV Amp	AV Δ L2
1	0.656645	45.3	44.1	42.4	-3.6
2	0.765840	45.0	44.4	44.1	-1.9
3	1.093770	43.7	42.7	42.2	-3.8
4	5.579510	41.5	41.0	38.9	-11.1
5	9.955305	38.2	37.5	34.8	-15.1

ACTV DET: PEAK

MEAS DET: PEAK QP AVG

MKR 9.91 MHz

37.01 dB μ V

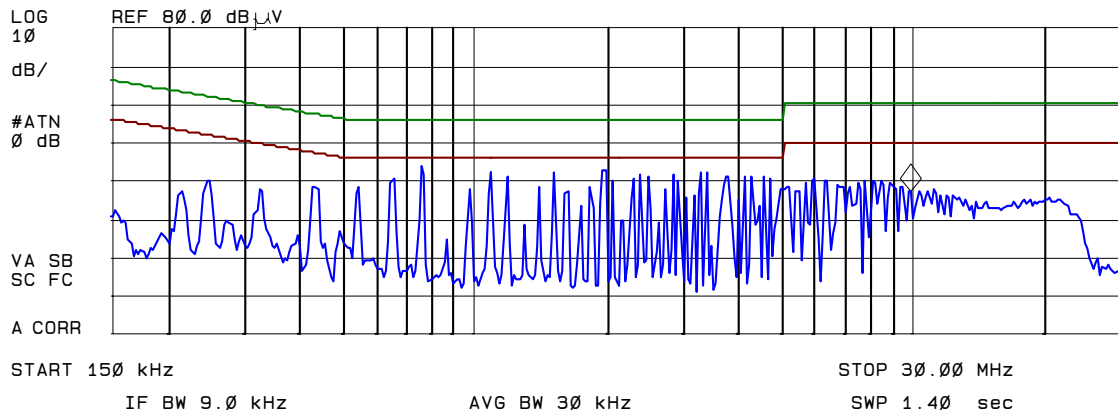

ULTRATECH GROUP OF LABS

3000 Bristol Circle, Oakville, Ontario, Canada L6H 6G4
 Tel. #: 905-829-1570, Fax. #: 905-829-8050, Email: vic@ultratech-labs.com, Website: <http://www.ultratech-labs.com>

File #: TEK-508F15C247

October 27, 2005

All test results contained in this engineering test report are traceable to National Institute of Standards and Technology (NIST)

Plot 6.5.5.2
 Power Line Conducted Emissions (Tx Mode)
 Line Voltage: DC 3.3 V
 Line Tested: Neg

177

Signal	Freq (MHz)	PK Amp	QP Amp	AV Amp	AV Δ L2
1	0.657860	45.0	43.6	41.6	-4.4
2	0.767555	44.6	44.0	43.7	-2.3
3	1.095660	43.2	42.4	41.8	-4.2
4	5.589520	39.8	40.4	37.0	-13.0
5	8.877075	39.4	38.7	33.6	-16.4

ACTV DET: PEAK
 MEAS DET: PEAK QP AVG
 MKR 770 kHz
 41.98 dB μ V

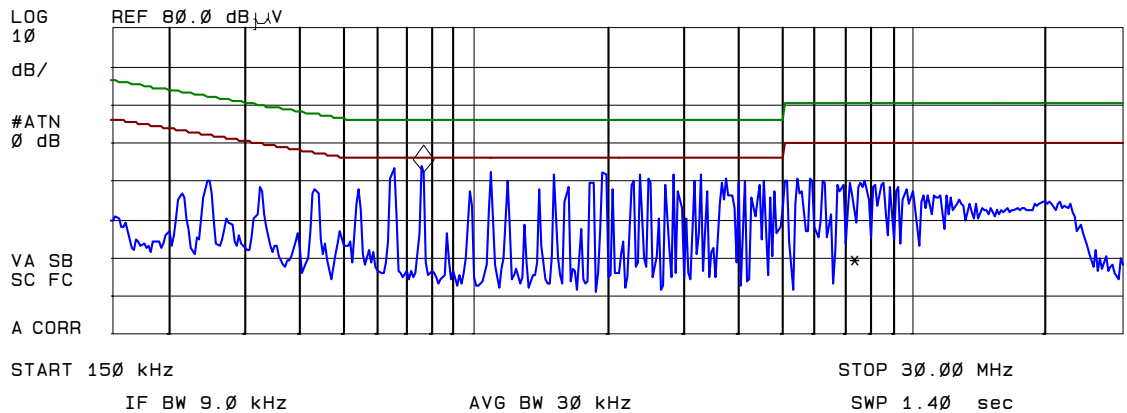

Frequency (MHz)	RF Level (dBμV)	Receiver Detector (P/QP/AVG)	QP Limit (dBuV)	AVG Limit (dBuV)	Margin (dB)	Pass/ Fail	Line Tested (Pos/Neg)
Test Configuration #2: Rx Mode							
0.655720	43.8	QP	56.0	46.0	-12.2	Pass	Pos
0.655720	42.6	AVG	56.0	46.0	-3.4	Pass	Pos
0.766205	44.4	QP	56.0	46.0	-11.6	Pass	Pos
0.766205	44.2	AVG	56.0	46.0	-1.8	Pass	Pos
1.092270	42.6	QP	56.0	46.0	-13.4	Pass	Pos
1.092270	41.9	AVG	56.0	46.0	-4.1	Pass	Pos
5.575250	41.0	QP	60.0	50.0	-19.0	Pass	Pos
5.575250	39.5	AVG	60.0	50.0	-10.5	Pass	Pos
10.928175	37.3	QP	60.0	50.0	-22.7	Pass	Pos
10.928175	33.7	AVG	60.0	50.0	-16.3	Pass	Pos
0.655960	43.9	QP	56.0	46.0	-12.1	Pass	Neg
0.655960	42.5	AVG	56.0	46.0	-3.5	Pass	Neg
0.765010	44.5	QP	56.0	46.0	-11.5	Pass	Neg
0.765010	44.2	AVG	56.0	46.0	-1.8	Pass	Neg
1.092390	42.6	QP	56.0	46.0	-13.4	Pass	Neg
1.092390	40.2	AVG	56.0	46.0	-5.8	Pass	Neg
5.464395	40.9	QP	60.0	50.0	-19.1	Pass	Neg
5.464395	39.2	AVG	60.0	50.0	-10.8	Pass	Neg
11.145500	37.0	QP	60.0	50.0	-23.0	Pass	Neg
11.145500	33.2	AVG	60.0	50.0	-16.8	Pass	Neg

Note: See the following plots for detailed measurements

Plot 6.5.5.3
 Power Line Conducted Emissions (Rx Mode)
 Line Voltage: DC 3.3 V
 Line Tested: Pos

177

Signal	Freq (MHz)	PK Amp	QP Amp	AV Amp	AV Δ L2
1	0.655720	45.2	43.8	42.6	-3.4
2	0.766205	44.9	44.4	44.2	-1.9
3	1.092270	43.6	42.6	41.9	-4.1
4	5.575250	41.5	41.0	39.5	-10.5
5	10.928175	38.0	37.3	33.7	-16.3

ACTV DET: PEAK

MEAS DET: PEAK QP AVG

MKR 11.00 MHz

37.22 dB μ V

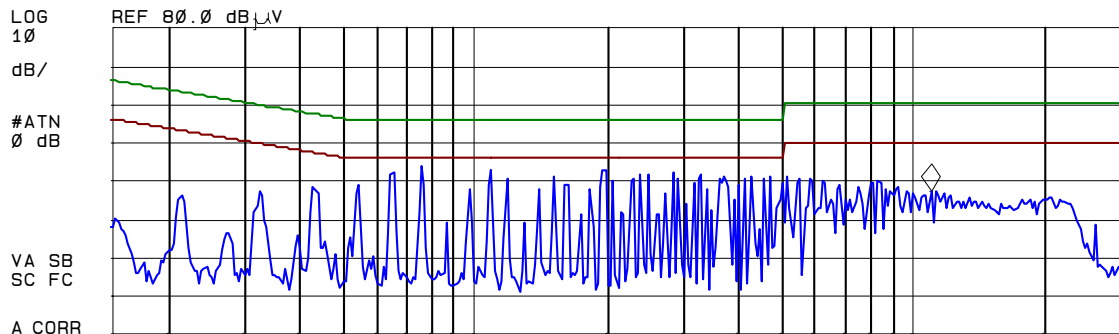

START 150 kHz

IF BW 9.0 kHz

AVG BW 30 kHz

STOP 30.00 MHz

SWP 1.40 sec

Plot 6.5.5.4
 Power Line Conducted Emissions (Rx Mode)
 Line Voltage: DC 3.3 V
 Line Tested: Neg

177

Signal	Freq (MHz)	PK Amp	QP Amp	AV Amp	AV Δ L2
1	0.655960	45.2	43.9	42.5	-3.5
2	0.765010	44.9	44.5	44.2	-1.8
3	1.092390	43.5	42.6	40.2	-5.8
4	5.464395	41.5	40.9	39.2	-10.8
5	11.145500	38.1	37.0	33.2	-16.8

ACTV DET: PEAK
 MEAS DET: PEAK QP AVG
 MKR 11.16 MHz
 30.72 dB μ V

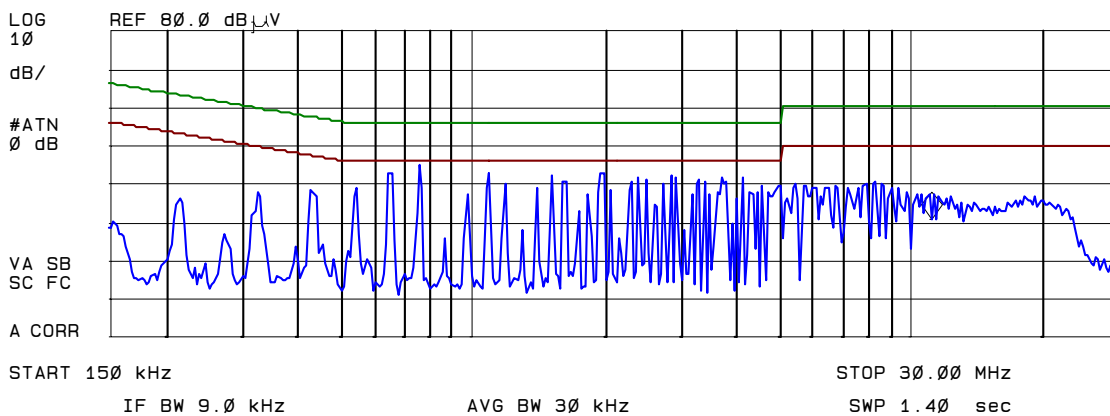

6.6. BANDWIDTH [§ 15.247(a)(2)]

6.6.1. Limits

For a Digital Modulation System, the minimum 6 dB bandwidth shall be at least 500 KHz.

6.6.2. Method of Measurements

KDB Publication No. 558074: Guidance on Measurements for Digital Transmission Systems (47 CFR 15.247)

6.6.3. Test Arrangement

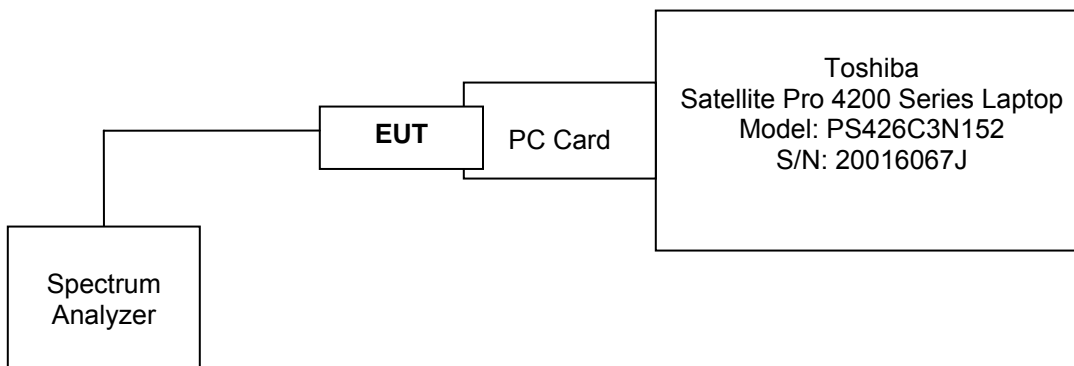

6.6.4. Test Equipment List

Test Instruments	Manufacturer	Model No.	Serial No.	Frequency Range
Spectrum Analyzer	Rhode & Schwarz	FSEK20/B4/B21	834157/005	9 kHz- 40 GHz

6.6.5. Test Data

Frequency (MHz)	Modulation/Data Rate	6 dB Bandwidth (MHz)
802.11b		
2412	DBPSK, 1 Mbps	10.10
2437	DBPSK, 1 Mbps	10.04
2462	DBPSK, 1 Mbps	10.04
2412	DQPSK, 2 Mbps	10.10
2437	DQPSK, 2 Mbps	10.16
2462	DQPSK, 2 Mbps	10.10
2412	CCK, 11 Mbps	11.06
2437	CCK, 11 Mbps	10.40
2462	CCK, 11 Mbps	10.34

Frequency (MHz)	Modulation/Data Rate	6 dB Bandwidth (MHz)
802.11g		
2412	DBPSK, 9 Mbps	16.65
2437	DBPSK, 9 Mbps	16.59
2462	DBPSK, 9 Mbps	16.59
2412	DQPSK, 18 Mbps	16.53
2437	DQPSK, 18 Mbps	16.59
2462	DQPSK, 18 Mbps	16.59
2412	16QAM, 36 Mbps	16.59
2437	16QAM, 36 Mbps	16.59
2462	16QAM, 36 Mbps	16.59
2412	64QAM, 54 Mbps	16.59
2437	64QAM, 54 Mbps	16.59
2462	64QAM, 54 Mbps	16.59

See the following plots for detailed measurements.

Plot 6.6.5.1
6 dB Bandwidth
Frequency: 2412 MHz; Modulation: DBPSK; Data Rate: 1 Mbps

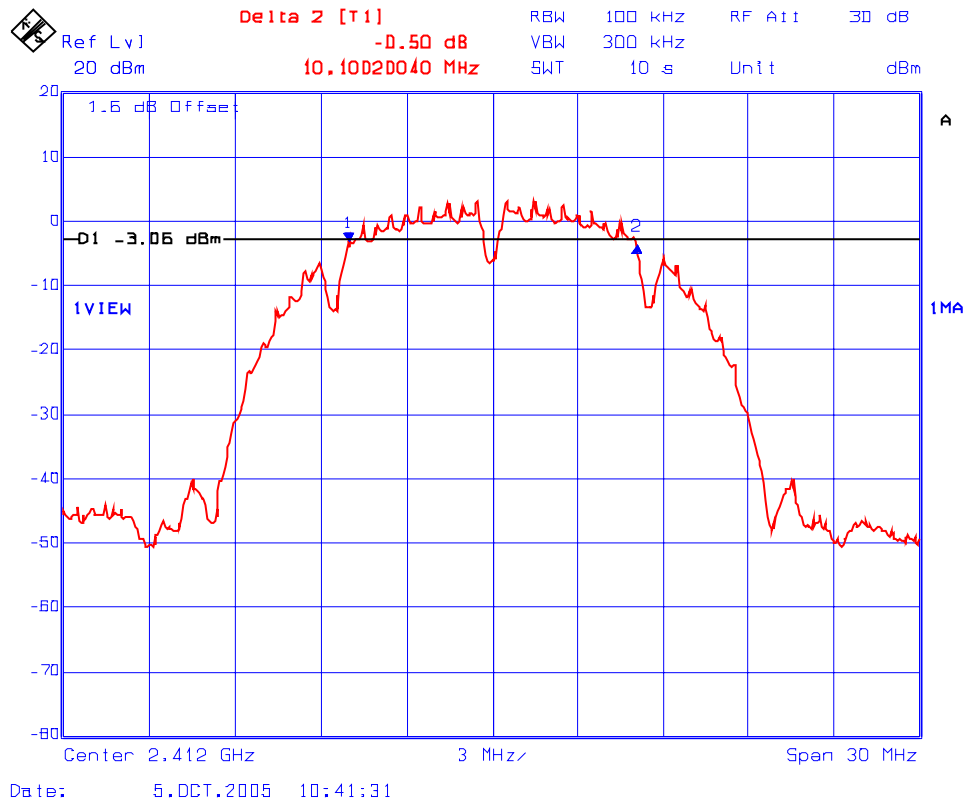

ULTRATECH GROUP OF LABS

3000 Bristol Circle, Oakville, Ontario, Canada L6H 6G4
Tel. #: 905-829-1570, Fax. #: 905-829-8050, Email: vic@ultratech-labs.com, Website: <http://www.ultratech-labs.com>

File #: TEK-508F15C247

October 27, 2005

All test results contained in this engineering test report are traceable to National Institute of Standards and Technology (NIST)

Plot 6.6.5.2
6 dB Bandwidth
Frequency: 2437 MHz; Modulation: DBPSK; Data Rate: 1 Mbps

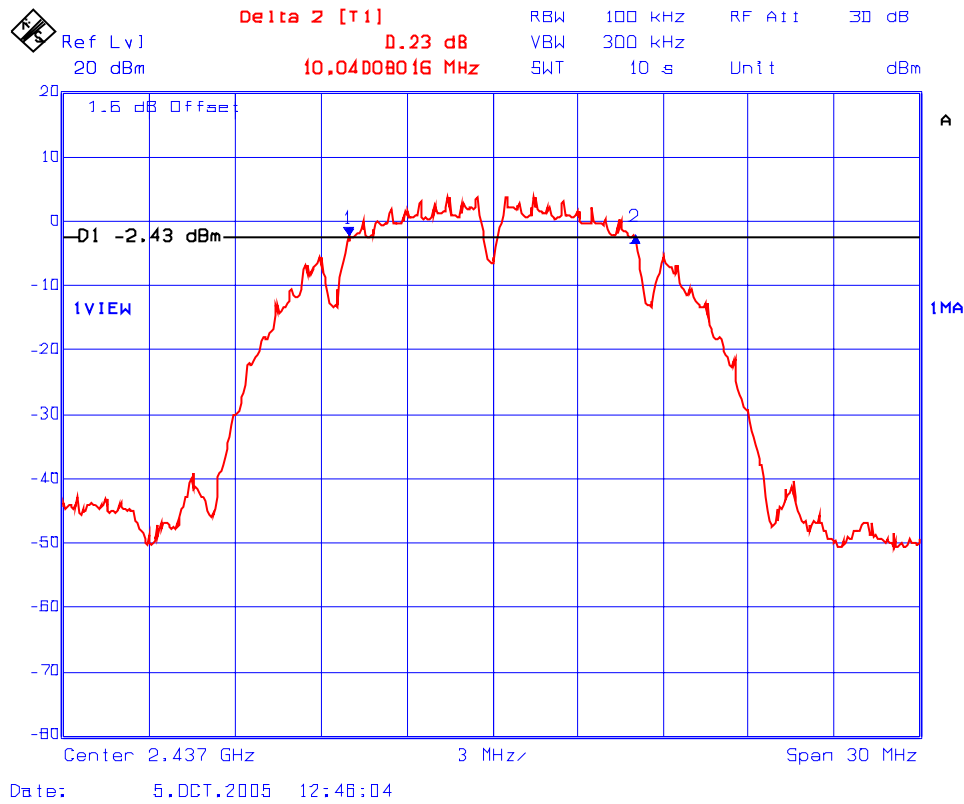

Plot 6.6.5.3
6 dB Bandwidth
Frequency: 2462 MHz; Modulation: DBPSK; Data Rate: 1 Mbps

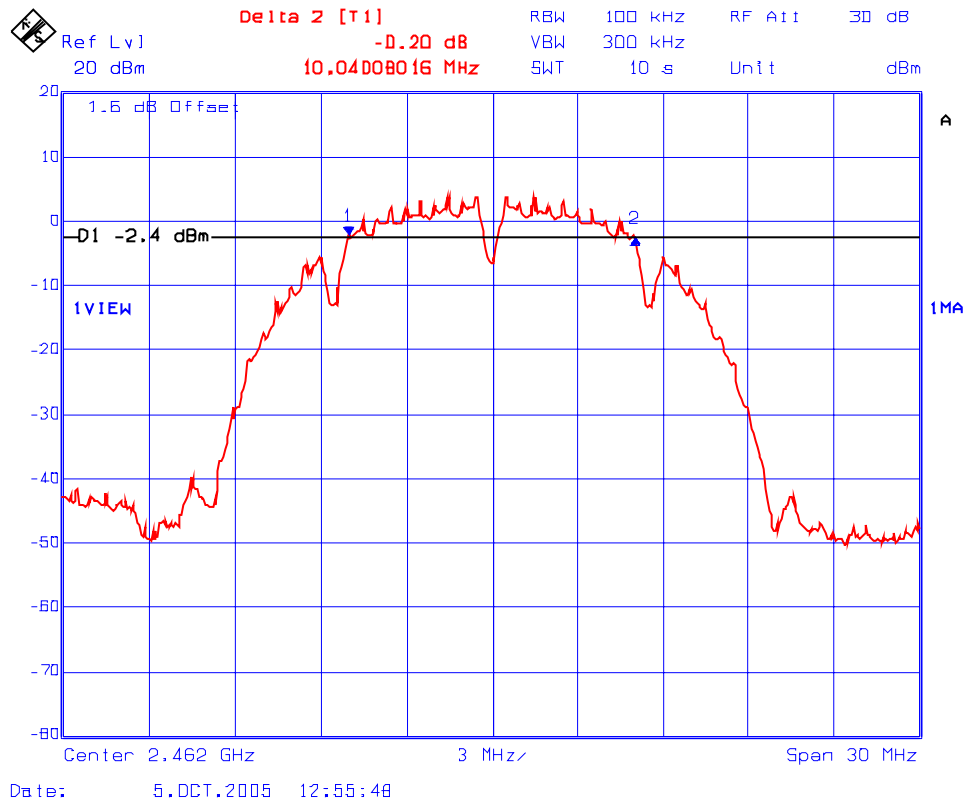

Plot 6.6.5.4
6 dB Bandwidth
Frequency: 2412 MHz; Modulation: DQPSK; Data Rate: 2 Mbps

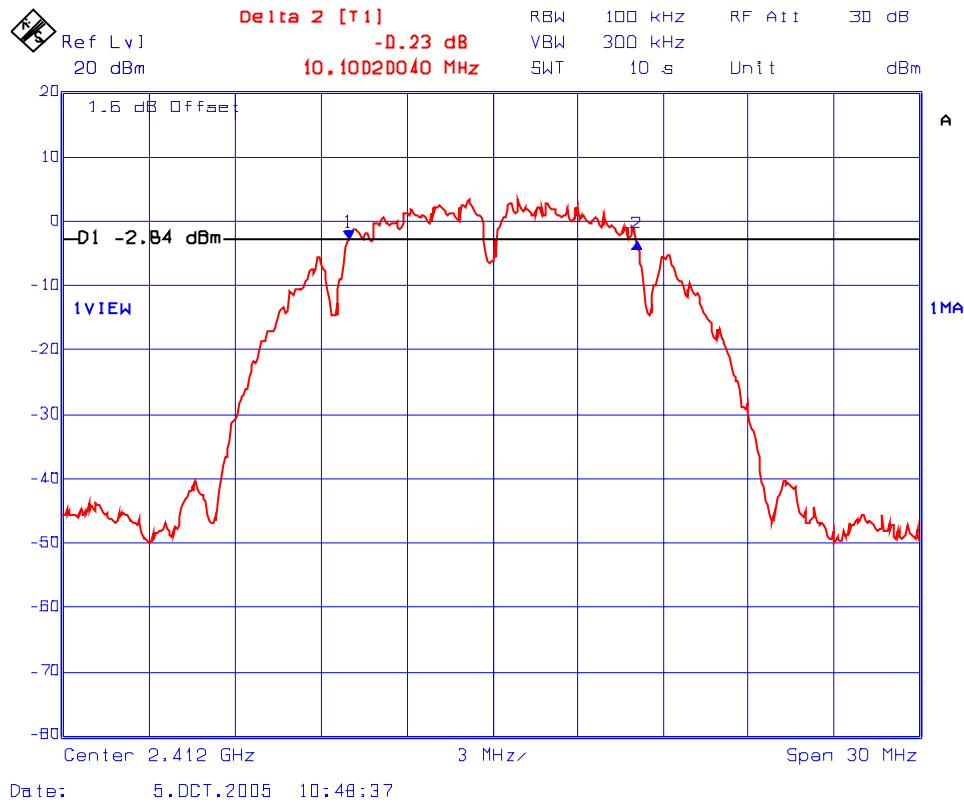

Plot 6.6.5.5
6 dB Bandwidth
Frequency: 2437 MHz; Modulation: DQPSK; Data Rate: 2 Mbps

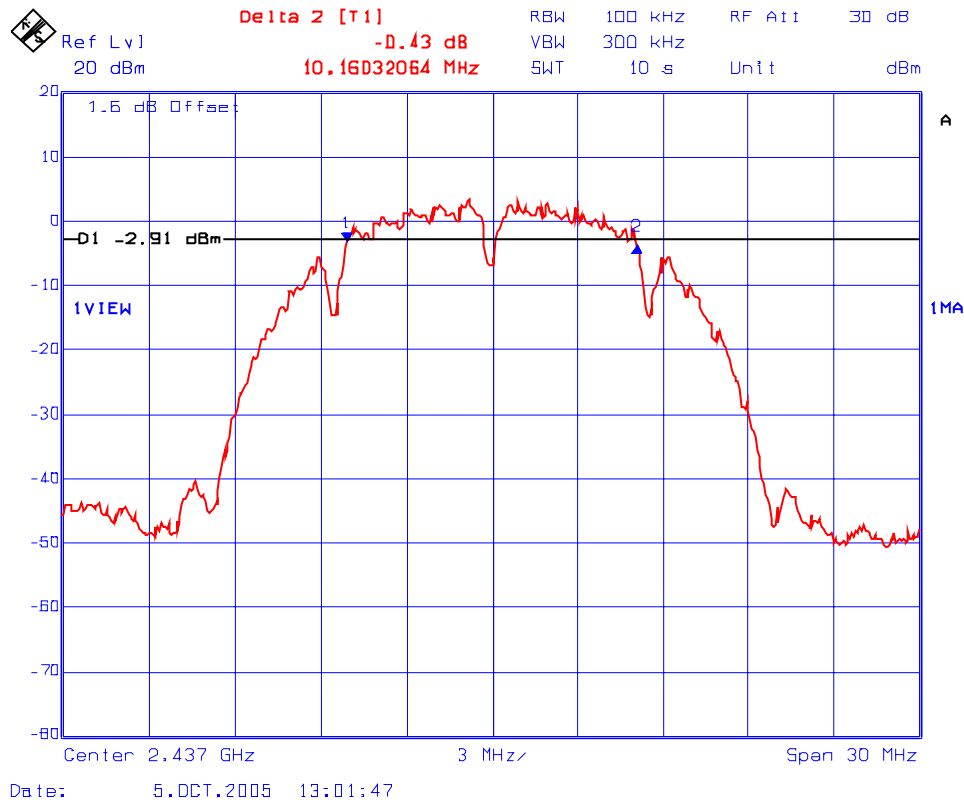

Plot 6.6.5.6
6 dB Bandwidth
Frequency: 2462 MHz; Modulation: DQPSK; Data Rate: 2 Mbps

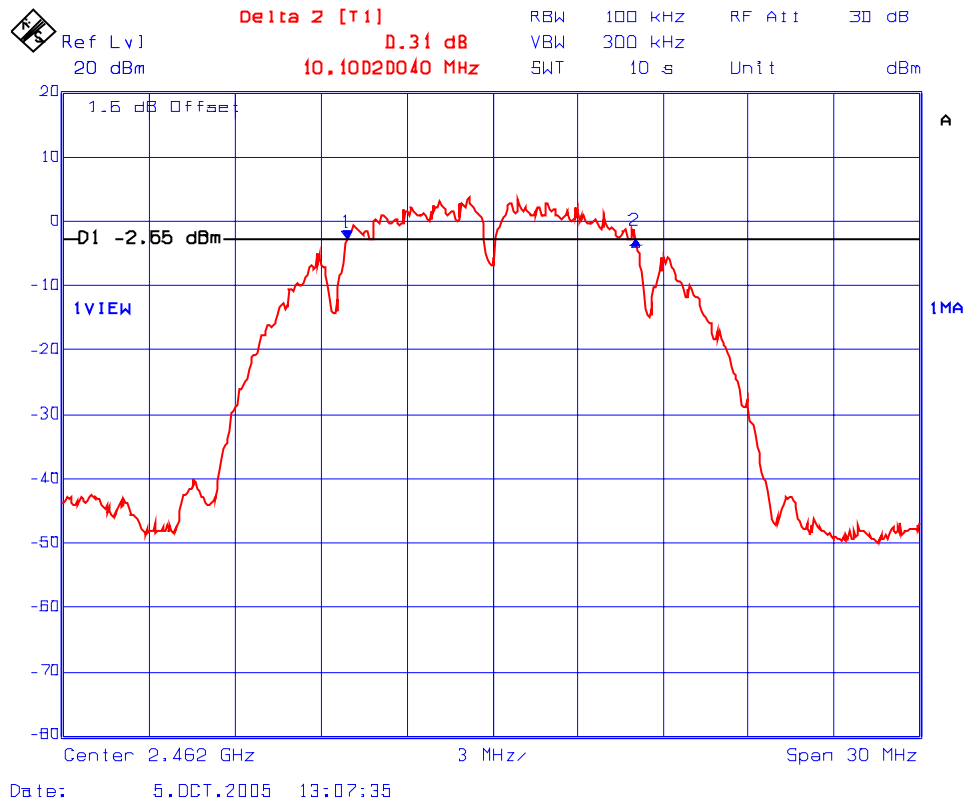

ULTRATECH GROUP OF LABS

3000 Bristol Circle, Oakville, Ontario, Canada L6H 6G4
Tel. #: 905-829-1570, Fax. #: 905-829-8050, Email: vic@ultratech-labs.com, Website: <http://www.ultratech-labs.com>

File #: TEK-508F15C247

October 27, 2005

All test results contained in this engineering test report are traceable to National Institute of Standards and Technology (NIST)

Plot 6.6.5.7
6 dB Bandwidth
Frequency: 2412 MHz; Modulation: CCK; Data Rate: 11 Mbps

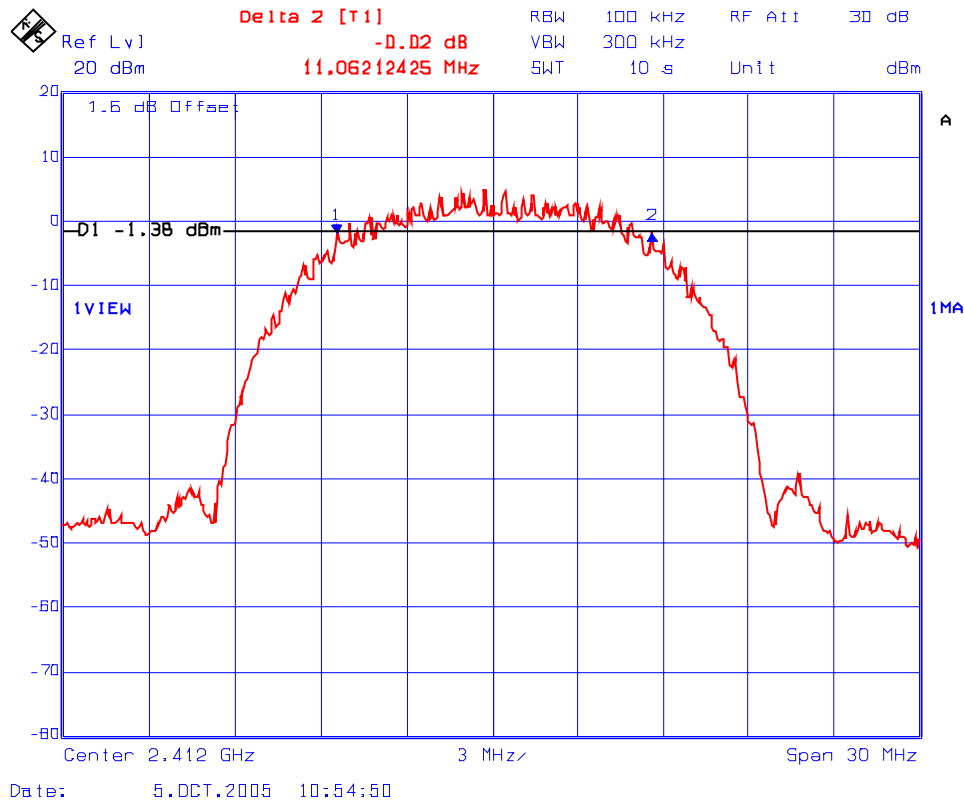

Plot 6.6.5.8
6 dB Bandwidth
Frequency: 2437 MHz; Modulation: CCK; Data Rate: 11 Mbps

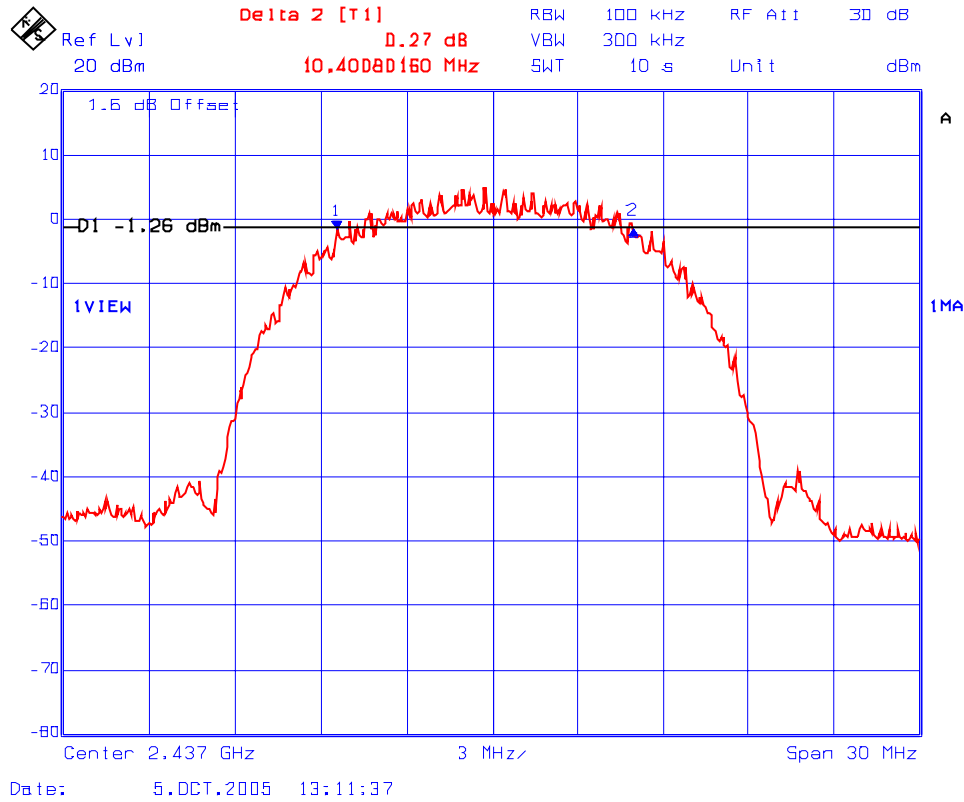

Plot 6.6.5.9
6 dB Bandwidth
Frequency: 2462 MHz; Modulation: CCK; Data Rate: 11 Mbps

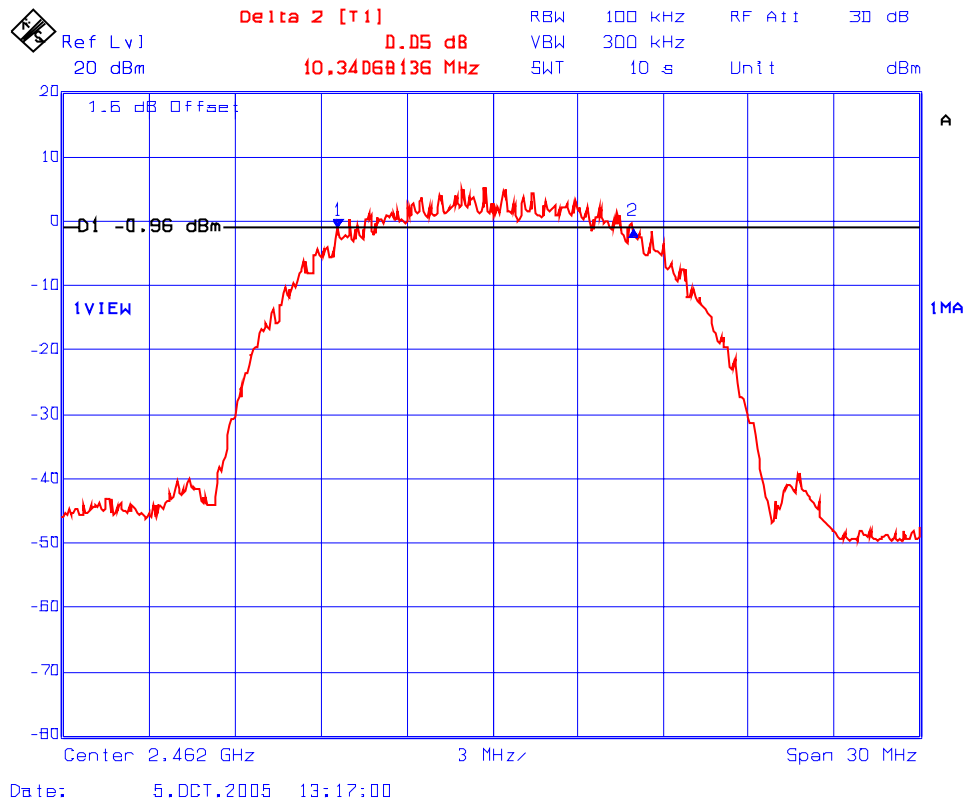

Plot 6.6.5.10
6 dB Bandwidth
Frequency: 2412 MHz; Modulation: DBPSK; Data Rate: 9 Mbps

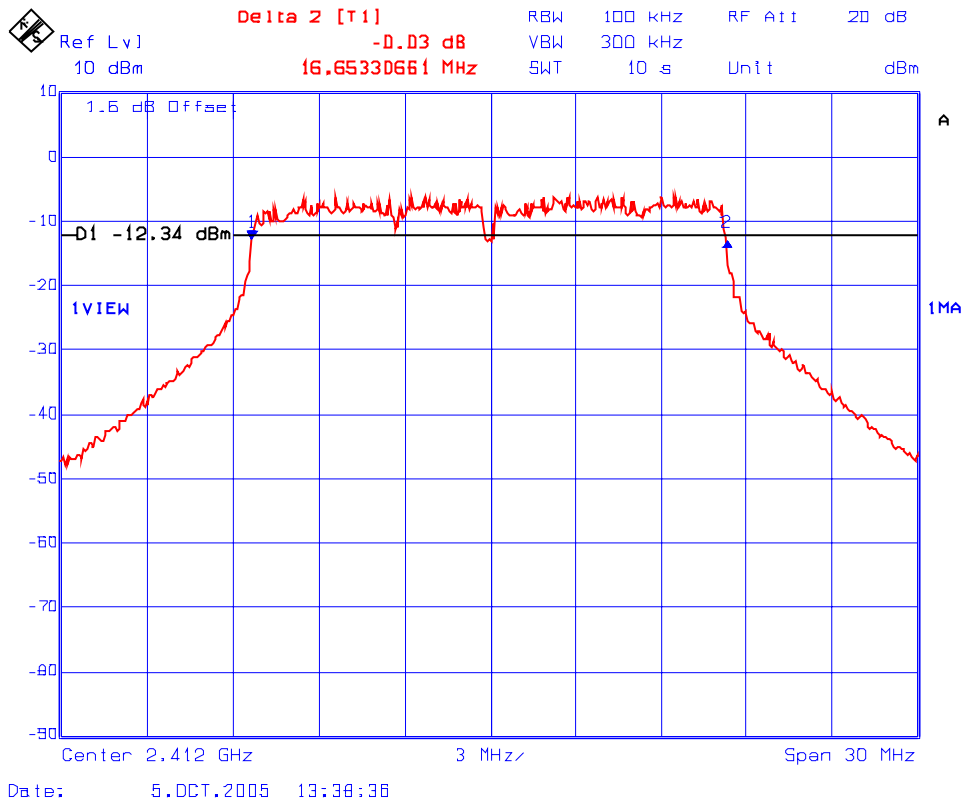

Plot 6.6.5.11
6 dB Bandwidth
Frequency: 2437 MHz; Modulation: DBPSK; Data Rate: 9 Mbps

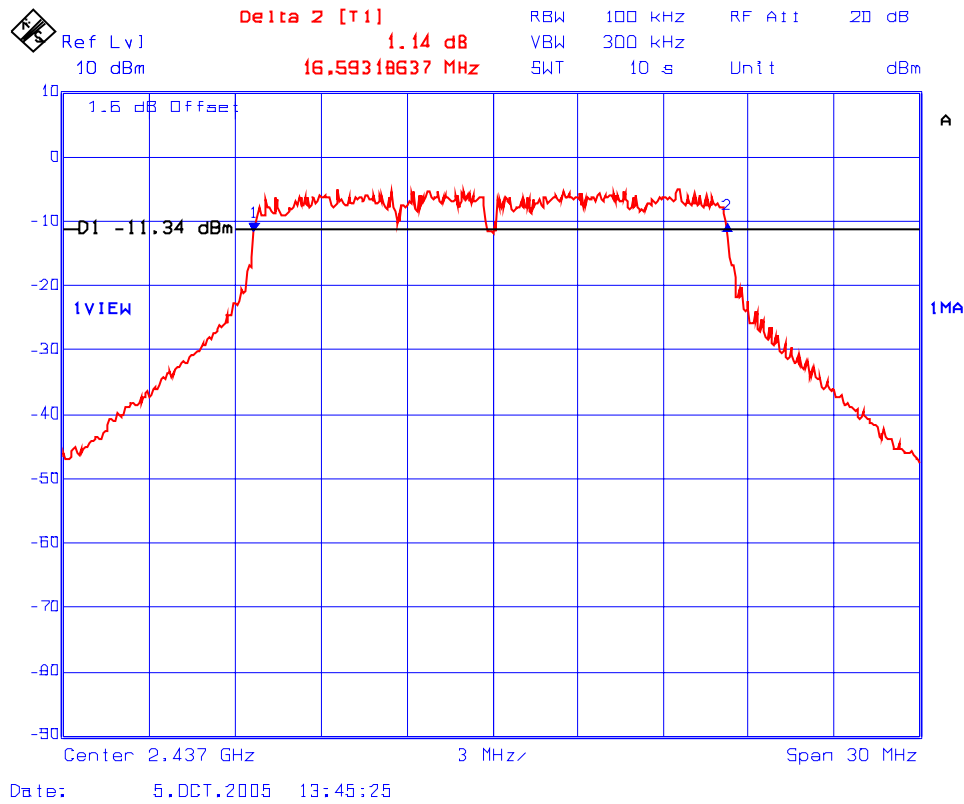

ULTRATECH GROUP OF LABS

3000 Bristol Circle, Oakville, Ontario, Canada L6H 6G4
Tel. #: 905-829-1570, Fax. #: 905-829-8050, Email: vic@ultratech-labs.com, Website: <http://www.ultratech-labs.com>

File #: TEK-508F15C247

October 27, 2005

All test results contained in this engineering test report are traceable to National Institute of Standards and Technology (NIST)

Plot 6.6.5.12
6 dB Bandwidth
Frequency: 2462 MHz; Modulation: DBPSK; Data Rate: 9 Mbps

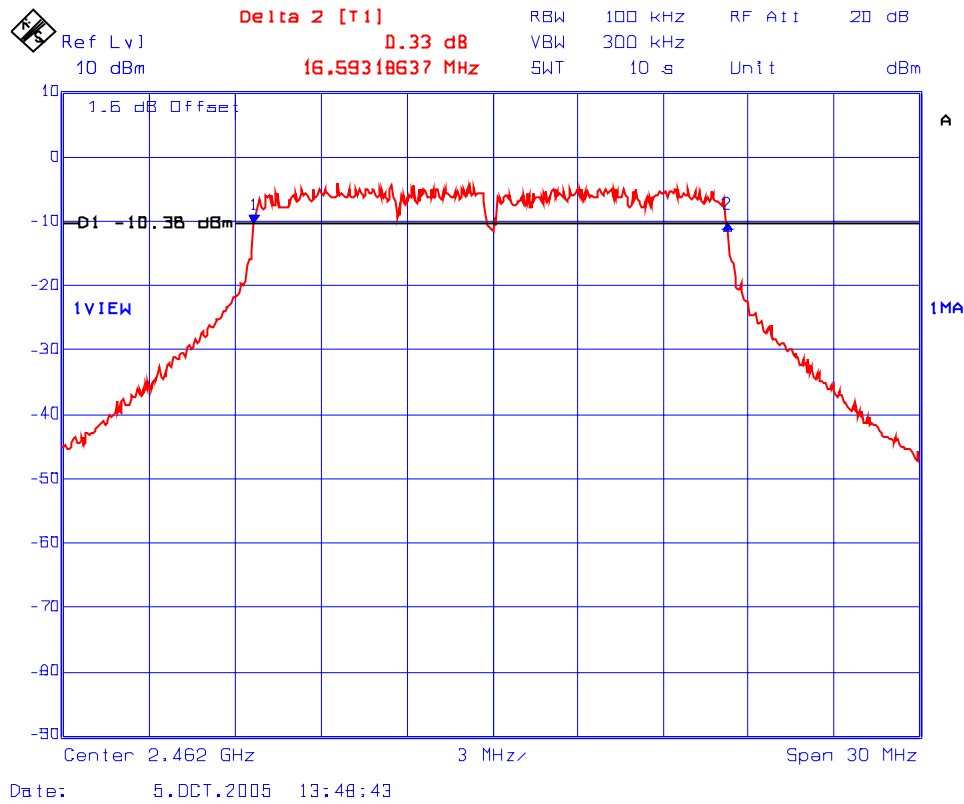

Plot 6.6.5.13
6 dB Bandwidth
Frequency: 2412 MHz; Modulation: DQPSK; Data Rate: 18 Mbps

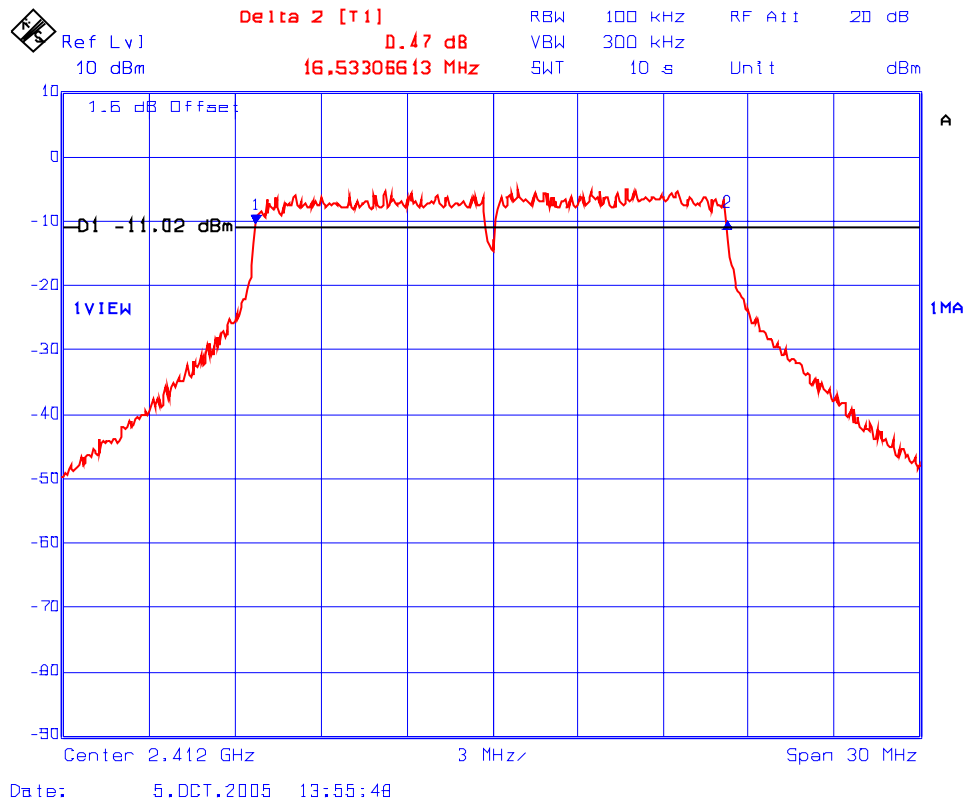

Plot 6.6.5.14
6 dB Bandwidth
Frequency: 2437 MHz; Modulation: DQPSK; Data Rate: 18 Mbps

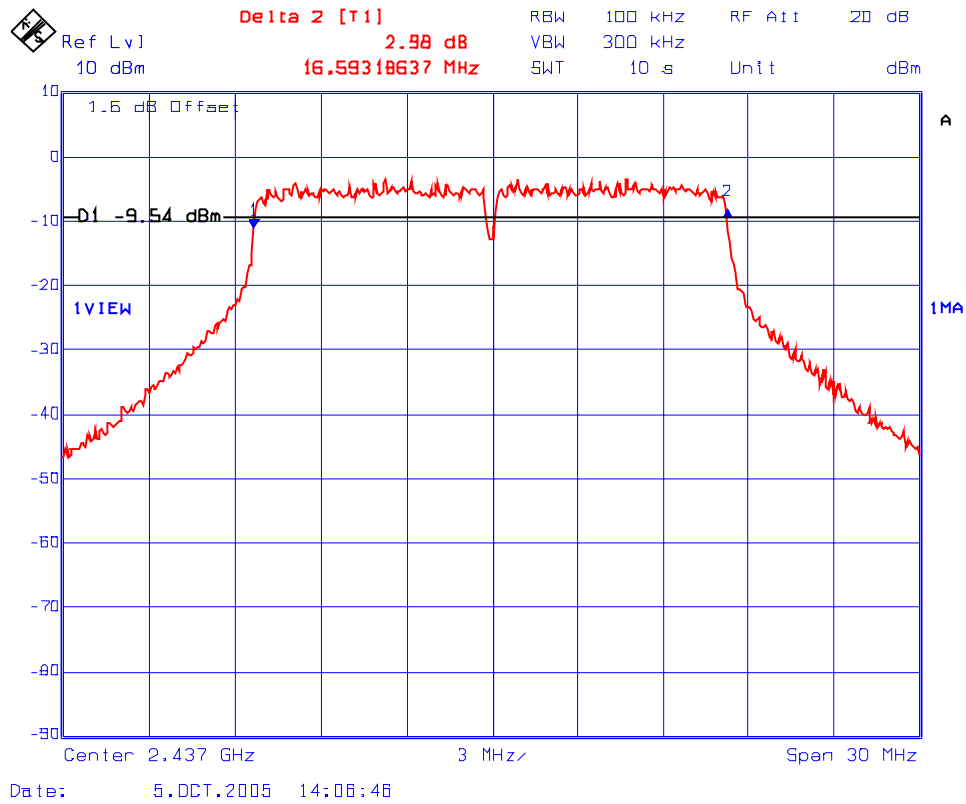

Plot 6.6.5.15
6 dB Bandwidth
Frequency: 2462 MHz; Modulation: DQPSK; Data Rate: 18 Mbps

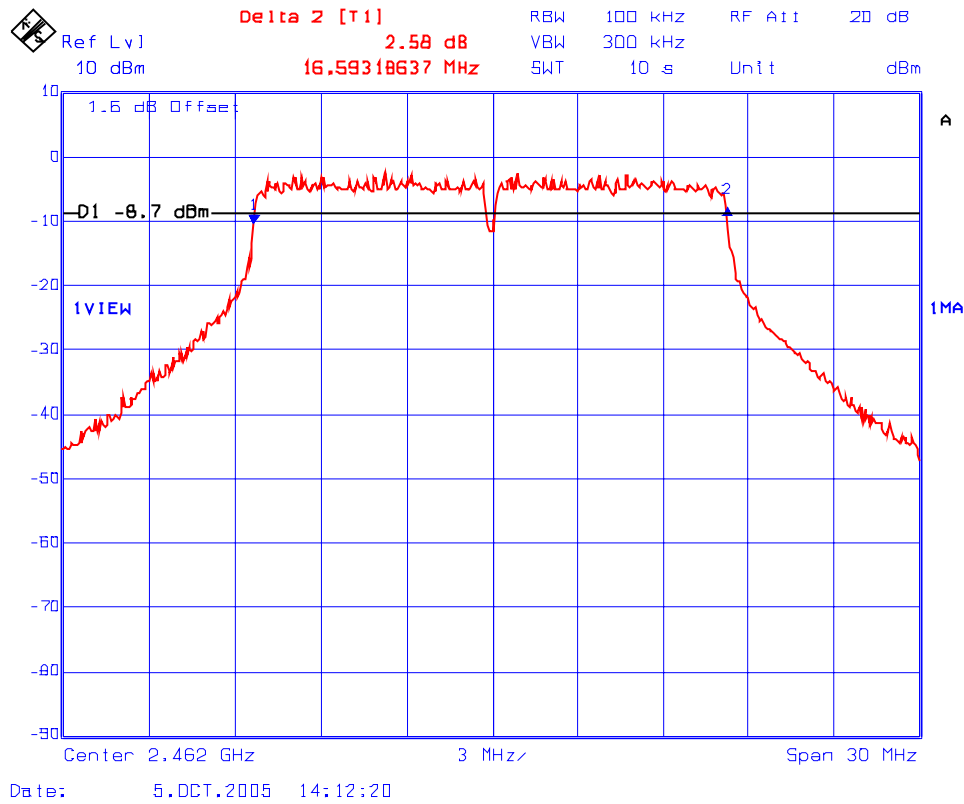

Plot 6.6.5.16
6 dB Bandwidth
Frequency: 2412 MHz; Modulation: 16QAM; Data Rate: 36 Mbps

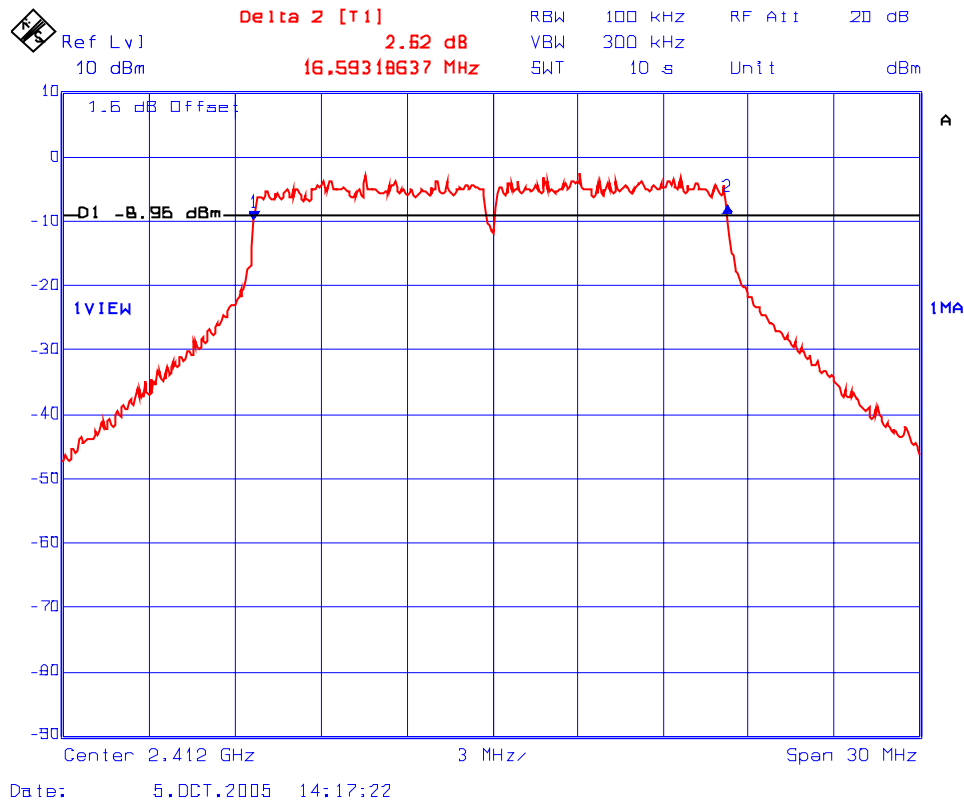

ULTRATECH GROUP OF LABS

3000 Bristol Circle, Oakville, Ontario, Canada L6H 6G4
Tel. #: 905-829-1570, Fax. #: 905-829-8050, Email: vic@ultratech-labs.com, Website: <http://www.ultratech-labs.com>

File #: TEK-508F15C247

October 27, 2005

All test results contained in this engineering test report are traceable to National Institute of Standards and Technology (NIST)

Plot 6.6.5.17
6 dB Bandwidth
Frequency: 2437 MHz; Modulation: 16QAM; Data Rate: 36 Mbps

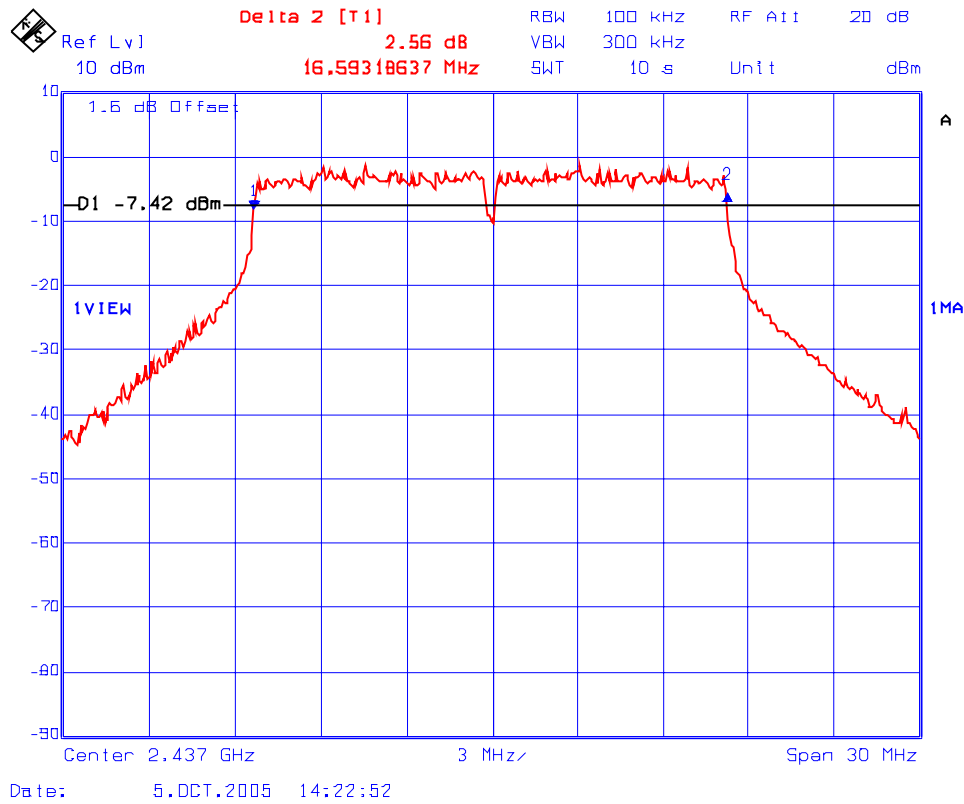

Plot 6.6.5.18
6 dB Bandwidth
Frequency: 2462 MHz; Modulation: 16QAM; Data Rate: 36 Mbps

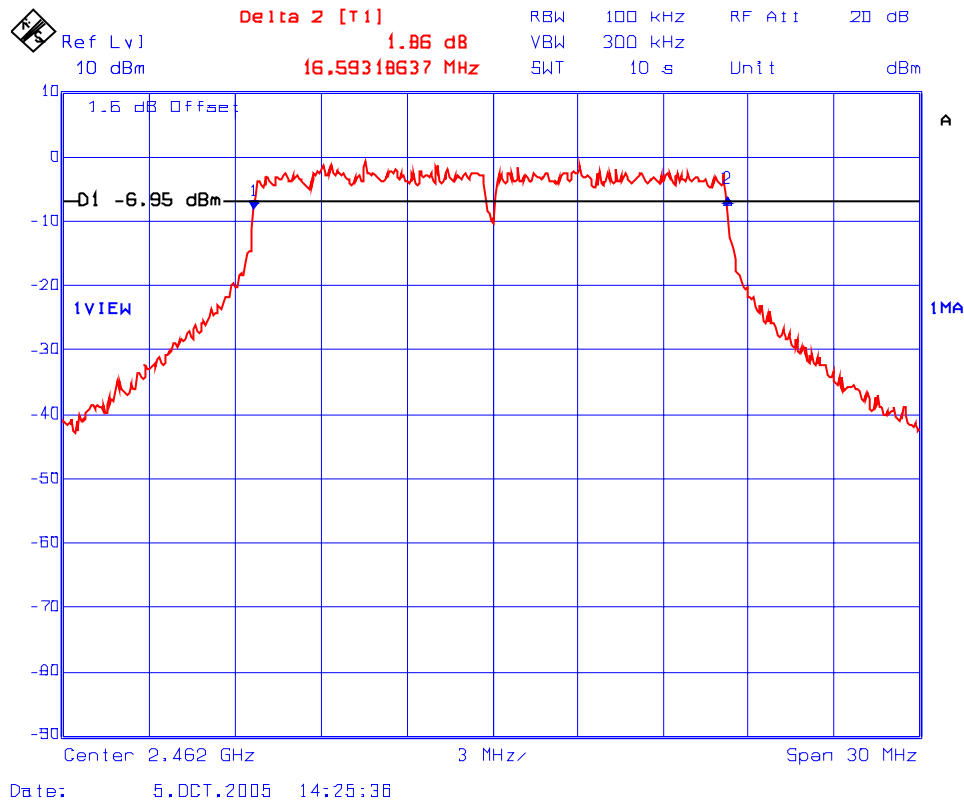

Plot 6.6.5.19
6 dB Bandwidth
Frequency: 2412 MHz; Modulation: 64QAM; Data Rate: 54 Mbps

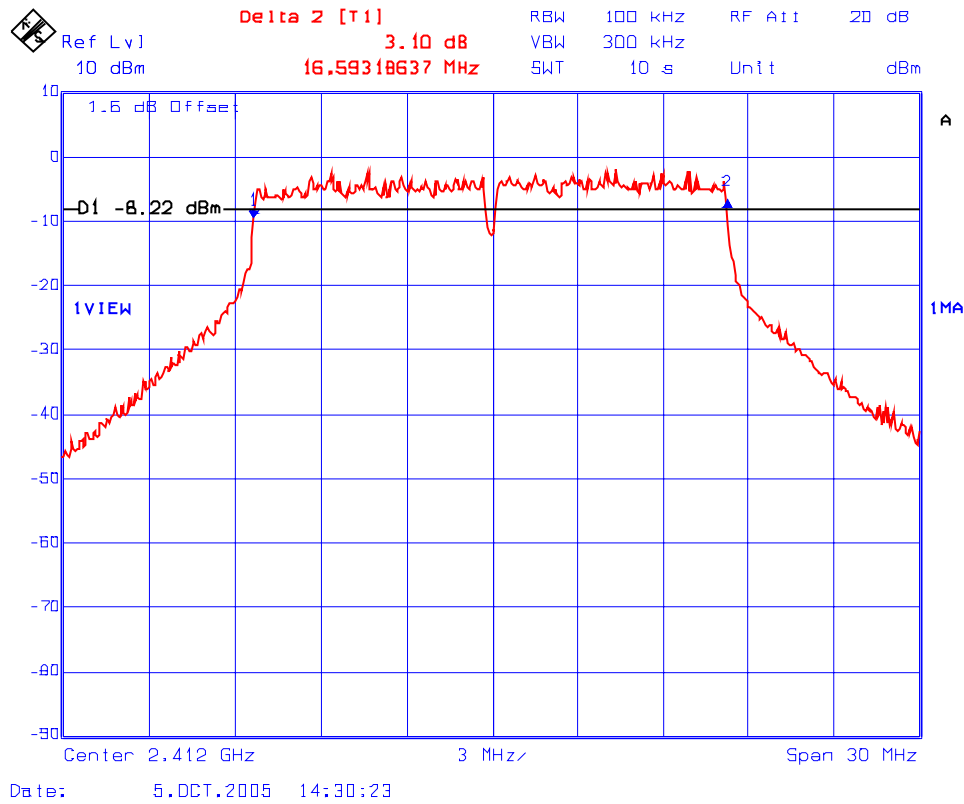

Plot 6.6.5.20
6 dB Bandwidth
Frequency: 2437 MHz; Modulation: 64QAM; Data Rate: 54 Mbps

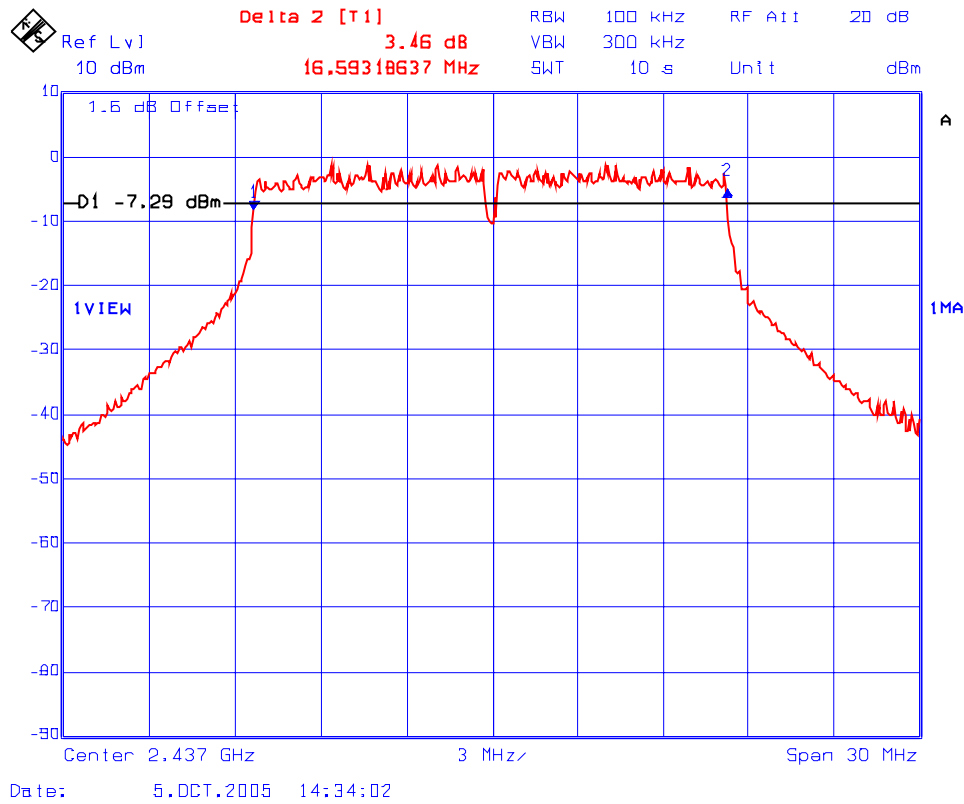

Plot 6.6.5.21
6 dB Bandwidth
Frequency: 2462 MHz; Modulation: 64QAM; Data Rate: 54 Mbps

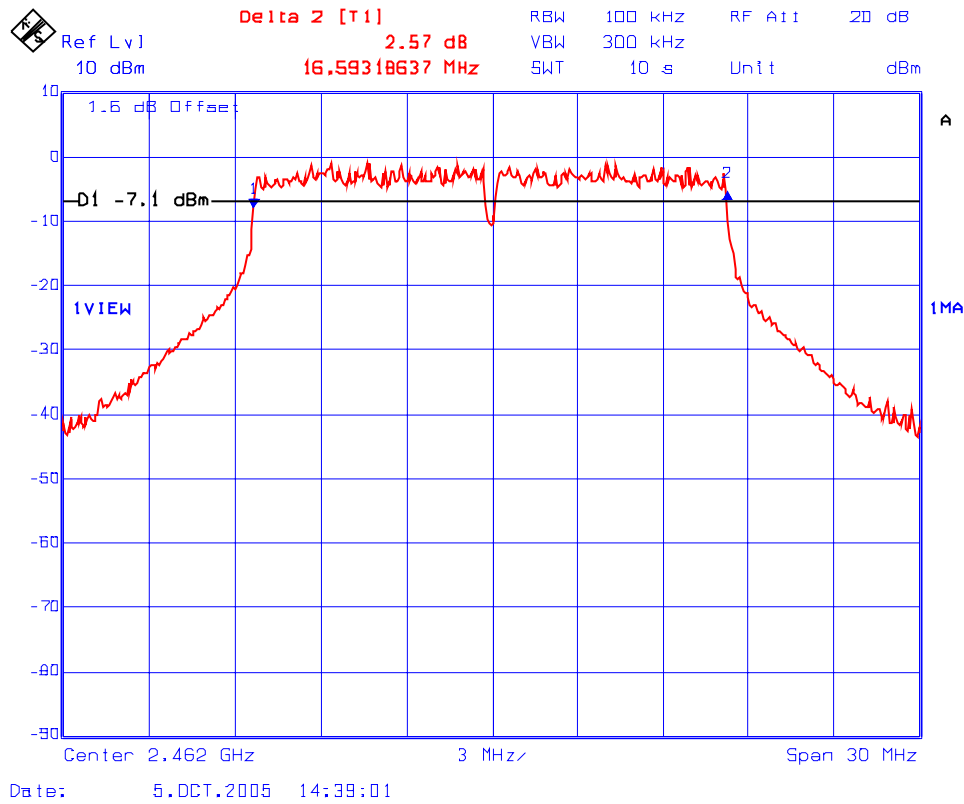

ULTRATECH GROUP OF LABS

3000 Bristol Circle, Oakville, Ontario, Canada L6H 6G4
Tel. #: 905-829-1570, Fax. #: 905-829-8050, Email: vic@ultratech-labs.com, Website: <http://www.ultratech-labs.com>

File #: TEK-508F15C247

October 27, 2005

All test results contained in this engineering test report are traceable to National Institute of Standards and Technology (NIST)

6.7. POWER OUTPUT [§ 15.247(b)]

6.7.1. Limits

§ 15.247(b):

- (3) For systems using digital modulation in the 902-928 MHz, 2400-2483.5 MHz, and 5725-5850 MHz bands: 1 Watt. As an alternative to a peak power measurement, compliance with the one Watt limit can be based on a measurement of the maximum conducted output power. Maximum Conducted Output Power is defined as the total transmit power delivered to all antennas and antenna elements averaged across all symbols in the signaling alphabet when the transmitter is operating at its maximum power control level. Power must be summed across all antennas and antenna elements. The average must not include any time intervals during which the transmitter is off or is transmitting at a reduced power level. If multiple modes of operation are possible (e.g., alternative modulation methods), the *maximum conducted output power* is the highest total transmit power occurring in any mode.
 - (4) The conducted output power limit specified in paragraph (b) of this section is based on the use of antennas with directional gains that do not exceed 6 dBi. Except as shown in paragraph (c) of this section, if transmitting antennas of directional gain greater than 6 dBi are used, the conducted output power from the intentional radiator shall be reduced below the stated values in paragraphs (b)(1), (b)(2), and (b)(3) of this section, as appropriate, by the amount in dB that the directional gain of the antenna exceeds 6 dBi.
- (c) Operation with directional antenna gains greater than 6 dBi.
- (1) Fixed point-to-point operation:
 - (i) Systems operating in the 2400-2483.5 MHz band that are used exclusively for fixed, point-to-point operations may employ transmitting antennas with directional gain greater than 6 dBi provided the maximum conducted output power of the intentional radiator is reduced by 1 dB for every 3 dB that the directional gain of the antenna exceeds 6 dBi.
 - (ii) Systems operating in the 5725-5850 MHz band that are used exclusively for fixed, point-to-point operations may employ transmitting antennas with directional gain greater than 6 dBi without any corresponding reduction in transmitter conducted output power.
 - (iii) Fixed, point-to-point operation, as used in paragraphs (c)(4)(i) and (c)(4)(ii) of this section, excludes the use of point-to-multipoint systems, omnidirectional applications, and multiple co-located intentional radiators transmitting the same information. The operator of the spread spectrum or digitally modulated intentional radiator or, if the equipment is professionally installed, the installer is responsible for ensuring that the system is used exclusively for fixed, point-to-point operations. The instruction manual furnished with the intentional radiator shall contain language in the installation instructions informing the operator and the installer of this responsibility.
 - (2) In addition to the provisions in paragraphs (b)(1), (b)(3), (b)(4) and (c)(1)(i) of this section, transmitters operating in the 2400-2483.5 MHz band that emit multiple directional beams, simultaneously or sequentially, for the purpose of directing signals to individual receivers or to groups of receivers provided the emissions comply with the following:
 - (i) Different information must be transmitted to each receiver.
 - (ii) If the transmitter employs an antenna system that emits multiple directional beams but does not do [the word "do" should be deleted from this sentence] emit multiple directional beams simultaneously, the total output power conducted to the array or arrays that comprise the device, i.e., the sum of the

power supplied to all antennas, antenna elements, staves, etc. and summed across all carriers or frequency channels, shall not exceed the limit specified in paragraph (b)(1) or (b)(3) of this section, as applicable. However, the total conducted output power shall be reduced by 1 dB below the specified limits for each 3 dB that the directional gain of the antenna/antenna array exceeds 6 dBi. The directional antenna gain shall be computed as follows:

- (A) The directional gain shall be calculated as the sum of 10 log(number of array elements or staves) plus the directional gain of the element or stave having the highest gain.
- (B) A lower value for the directional gain than that calculated in paragraph (c)(2)(ii)(A) of this section will be accepted if sufficient evidence is presented, e.g., due to shading of the array or coherence loss in the beamforming.
- (iii) If a transmitter employs an antenna that operates simultaneously on multiple directional beams using the same or different frequency channels, the power supplied to each emission beam is subject to the power limit specified in paragraph (c)(2)(ii) of this section. If transmitted beams overlap, the power shall be reduced to ensure that their aggregate power does not exceed the limit specified in paragraph (c)(2)(ii) of this section. In addition, the aggregate power transmitted simultaneously on all beams shall not exceed the limit specified in paragraph (c)(2)(ii) of this section by more than 8 dB.
- (iv) Transmitters that emit a single directional beam shall operate under the provisions of paragraph (c)(1) of this section.

6.7.2. Method of Measurements & Test Arrangement

KDB Publication No. 558074: Guidance on Measurements for Digital Transmission Systems (47 CFR 15.247)

6.7.3. Test Arrangement

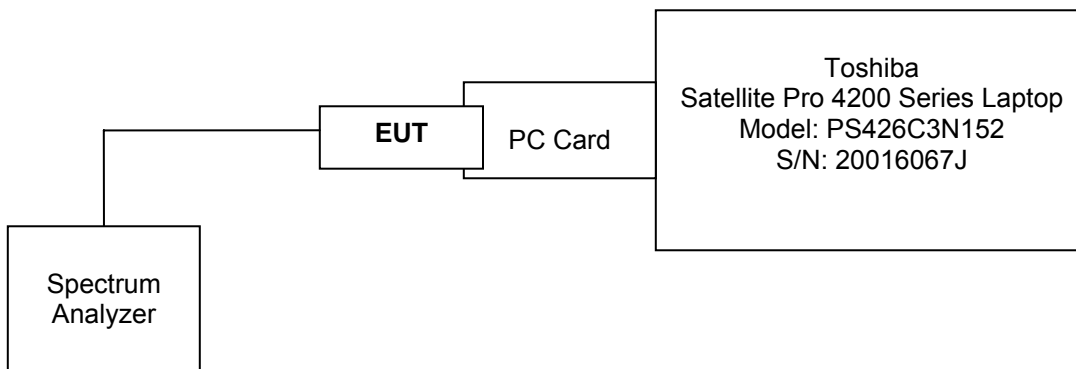

6.7.4. Test Equipment List

Test Instruments	Manufacturer	Model No.	Serial No.	Frequency Range
Spectrum Analyzer	Rhode & Schwarz	FSEK20/B4/B21	834157/005	9 kHz- 40 GHz

6.7.5. Test Data

Channel	Frequency (MHz)	Modulation	Data Rate (Mbps)	Peak Conducted Power (dBm)	Maximum Antenna Gain (dBi)	Peak EIRP (dBm)	Peak Conducted Power Limit (dBm)	EIRP Limit (dBm)
802.11b								
1	2412	DBPSK	1	14.53	5	19.53	30	36
6	2437	DBPSK	1	15.45	5	20.45	30	36
11	2462	DBPSK	1	15.14	5	20.14	30	36
1	2412	DQPSK	2	14.39	5	19.39	30	36
6	2437	DQPSK	2	15.53	5	20.53	30	36
11	2462	DQPSK	2	15.73	5	20.73	30	36
1	2412	CCK	11	15.36	5	20.36	30	36
6	2437	CCK	11	16.30	5	21.30	30	36
11	2462	CCK	11	16.44	5	21.44	30	36
802.11g								
1	2412	DBPSK	9	10.03	5	15.03	30	36
6	2437	DBPSK	9	11.25	5	16.25	30	36
11	2462	DBPSK	9	12.01	5	17.01	30	36
1	2412	DQPSK	18	11.22	5	16.22	30	36
6	2437	DQPSK	18	12.72	5	17.72	30	36
11	2462	DQPSK	18	13.51	5	18.51	30	36
1	2412	16QAM	36	13.26	5	18.26	30	36
6	2437	16QAM	36	14.37	5	19.37	30	36
11	2462	16QAM	36	14.08	5	19.08	30	36
1	2412	64QAM	54	13.18	5	18.18	30	36
6	2437	64QAM	54	14.37	5	19.37	30	36
11	2462	64QAM	54	14.50	5	19.50	30	36

6.8. SPURIOUS CONDUCTED EMISSIONS [§ 15.247(d)]

6.8.1. Limits

In any 100 kHz bandwidth outside the frequency band in which the spread spectrum or digitally modulated intentional radiator is operating, the radio frequency power that is produced by the intentional radiator shall be at least 20 dB below that in the 100 kHz bandwidth within the band that contains the highest level of the desired power, based on either an RF conducted or a radiated measurement, provided the transmitter demonstrates compliance with the peak conducted power limits. If the transmitter complies with the conducted power limits based on the use of RMS averaging over a time interval, as permitted under paragraph (b)(3) of this section, the attenuation required under this paragraph shall be 30 dB instead of 20 dB. Attenuation below the general limits specified in Section 15.209(a) is not required. In addition, radiated emissions which fall in the restricted bands, as defined in Section 15.205(a), must also comply with the radiated emission limits specified in Section 15.209(a) (see Section 15.205(c)).

6.8.2. Method of Measurements

KDB Publication No. 558074: Guidance on Measurements for Digital Transmission Systems (47 CFR 15.247) and Section 8.3 of this test report.

6.8.3. Test Arrangement

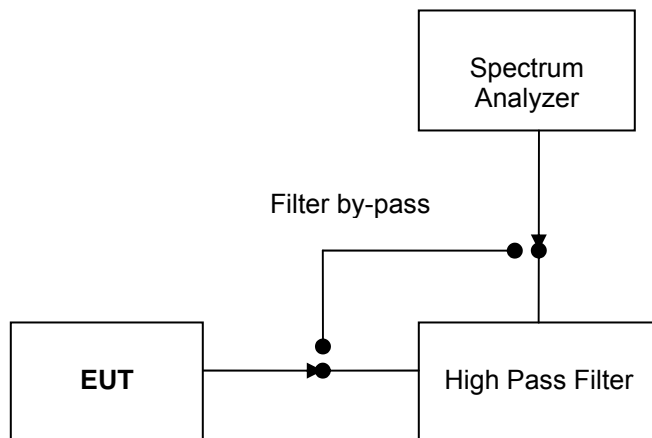

6.8.4. Test Equipment List

Test Instruments	Manufacturer	Model No.	Serial No.	Frequency Range
Spectrum Analyzer	Rhode & Schwarz	FSEK20/B4/B21	834157/005	9 kHz- 40 GHz
Highpass Filter	K & L	11SH10-4000/T12000-0/0	4	2 – 26 GHz

6.8.5. Test Data

6.8.5.1. Band-Edge Conducted Emissions

Plot 6.8.5.1.1
Band-Edge Conducted Emissions
Low End of Frequency Band
Frequency: 2412 MHz, Modulation: DBPSK, Data Rate: 1 Mbps

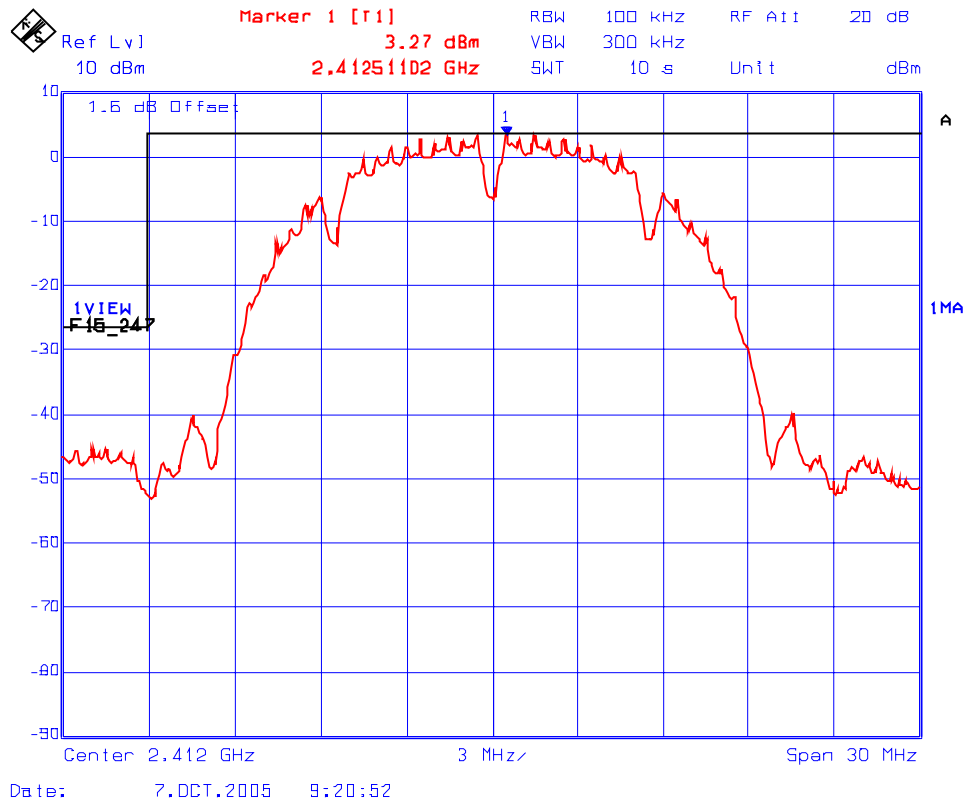

ULTRATECH GROUP OF LABS

3000 Bristol Circle, Oakville, Ontario, Canada L6H 6G4
Tel. #: 905-829-1570, Fax. #: 905-829-8050, Email: vic@ultratech-labs.com, Website: <http://www.ultratech-labs.com>

File #: TEK-508F15C247

October 27, 2005

All test results contained in this engineering test report are traceable to National Institute of Standards and Technology (NIST)

Plot 6.8.5.1.2
Band-Edge Conducted Emissions
High End of Frequency Band
Frequency: 2462 MHz; Modulation: DBPSK; Data Rate: 1 Mbps

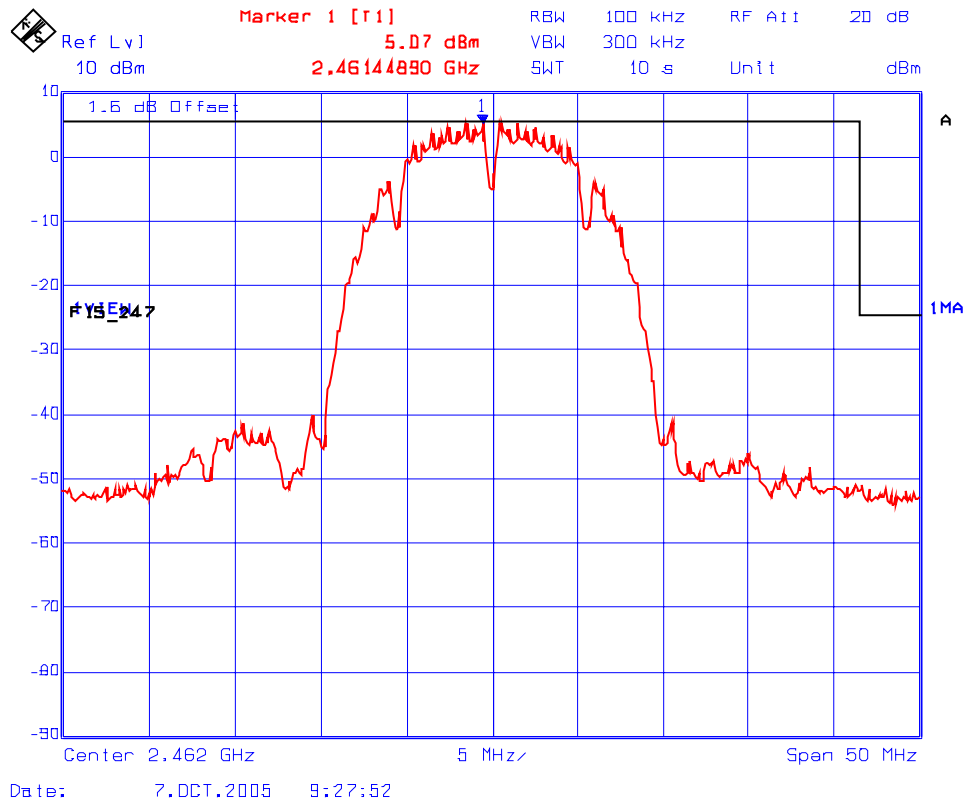

Plot 6.8.5.1.3
Band-Edge Conducted Emissions
Low End of Frequency Band
Frequency: 2412 MHz; Modulation: DQPSK; Data Rate: 2 Mbps

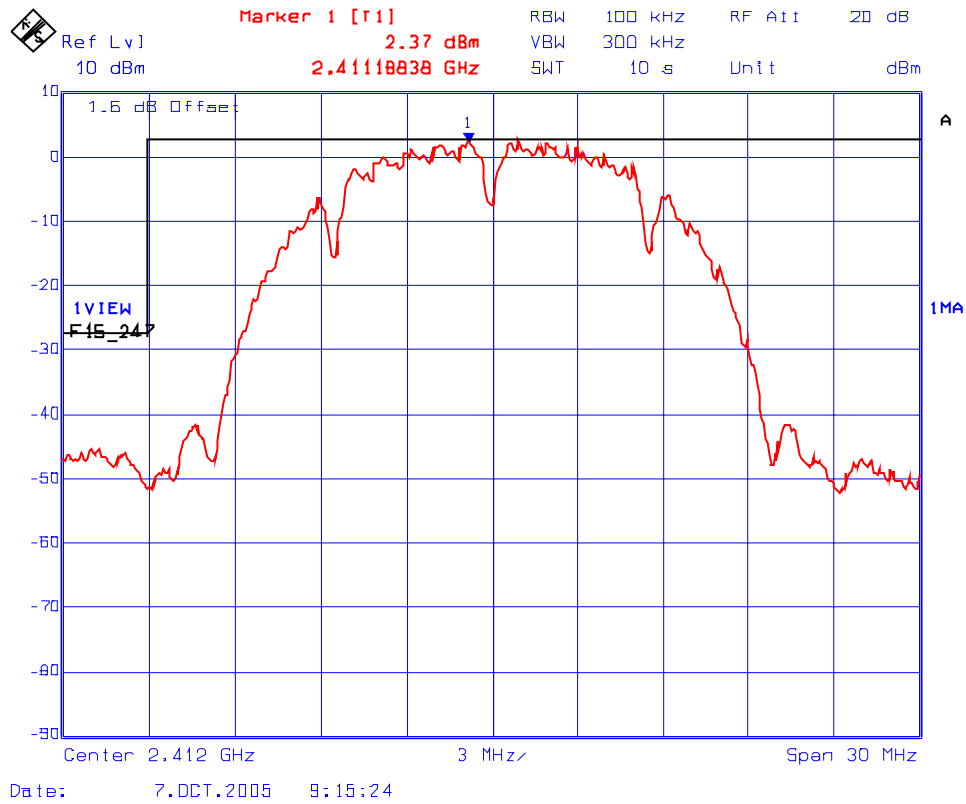

Plot 6.8.5.1.4
Band-Edge Conducted Emissions
High End of Frequency Band
Frequency: 2462 MHz; Modulation: DQPSK; Data Rate: 2 Mbps

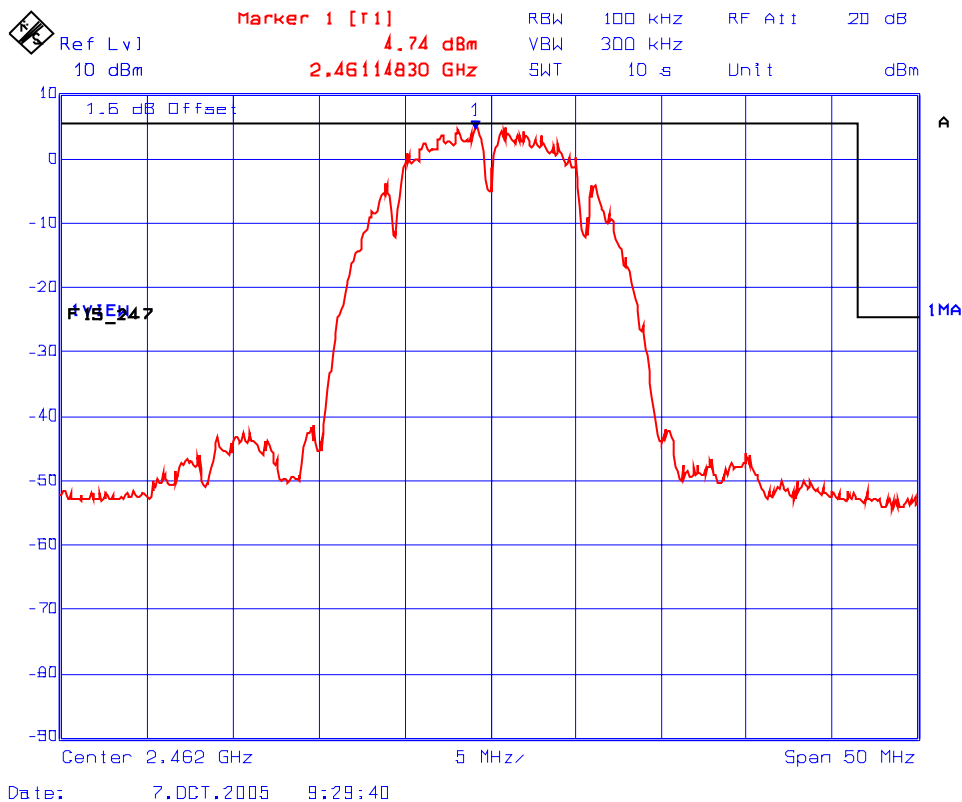

ULTRATECH GROUP OF LABS

3000 Bristol Circle, Oakville, Ontario, Canada L6H 6G4
Tel. #: 905-829-1570, Fax. #: 905-829-8050, Email: vic@ultratech-labs.com, Website: <http://www.ultratech-labs.com>

File #: TEK-508F15C247

October 27, 2005

All test results contained in this engineering test report are traceable to National Institute of Standards and Technology (NIST)

Plot 6.8.5.1.5
Band-Edge Conducted Emissions
Low End of Frequency Band
Frequency: 2412 MHz; Modulation: CCK; Data Rate: 11 Mbps

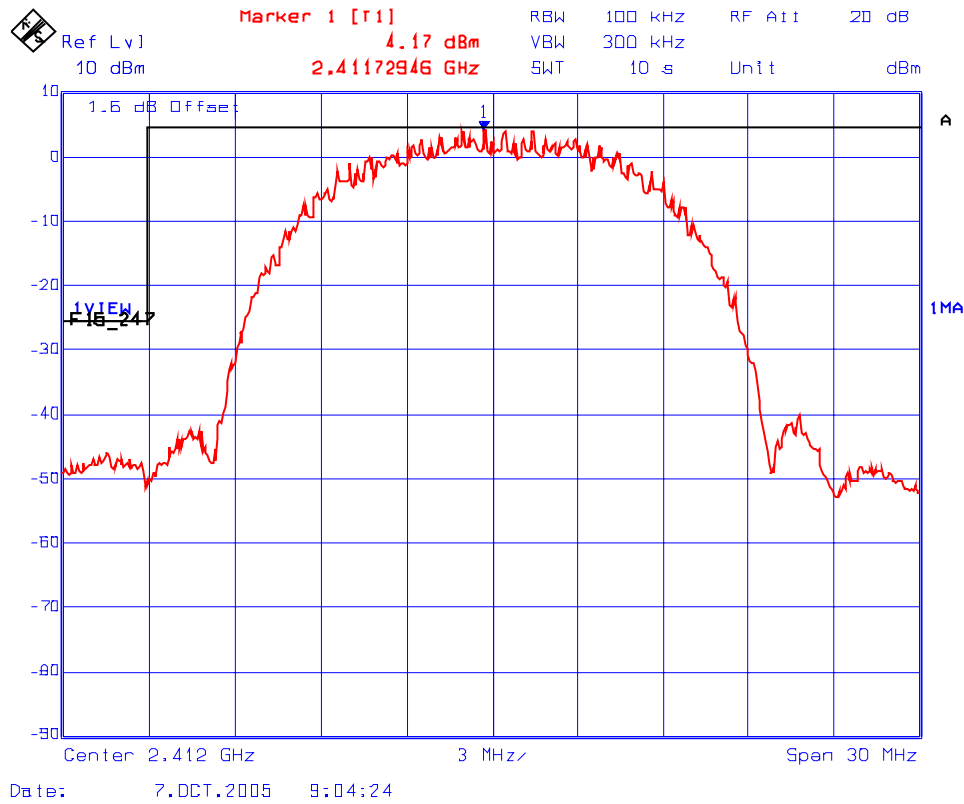

Plot 6.8.5.1.6
Band-Edge Conducted Emissions
High End of Frequency Band
Frequency: 2462 MHz; Modulation: CCK; Data Rate: 11 Mbps

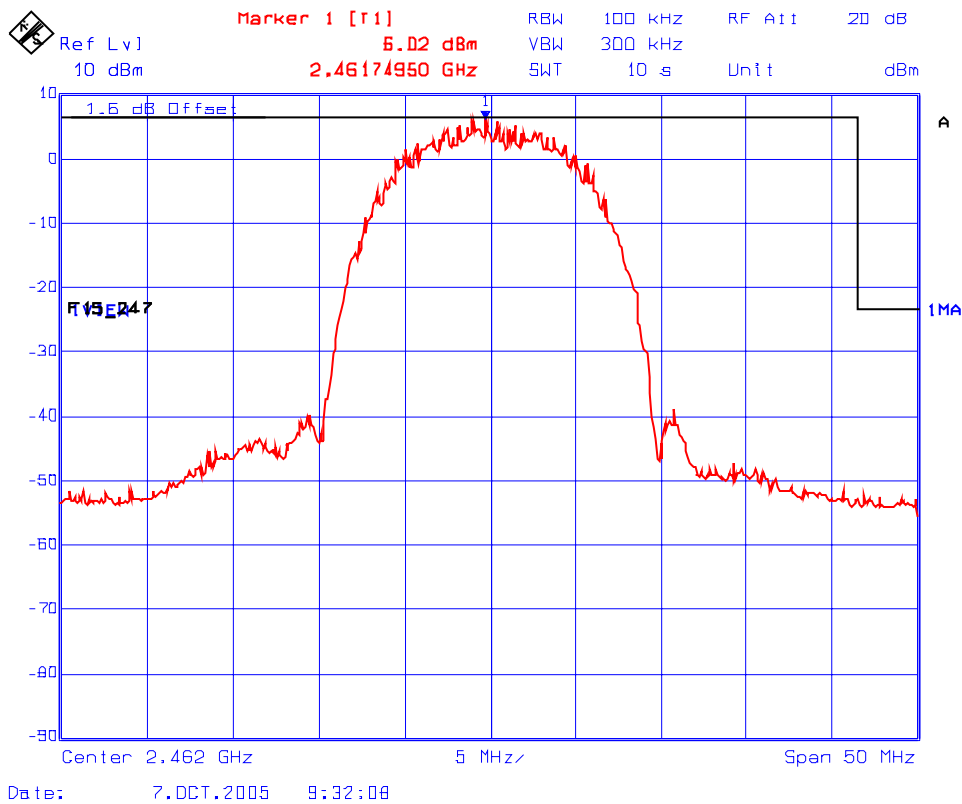

Plot 6.8.5.1.7
Band-Edge Conducted Emissions
Low End of Frequency Band
Frequency: 2412 MHz; Modulation: DBPSK; Data Rate: 9 Mbps

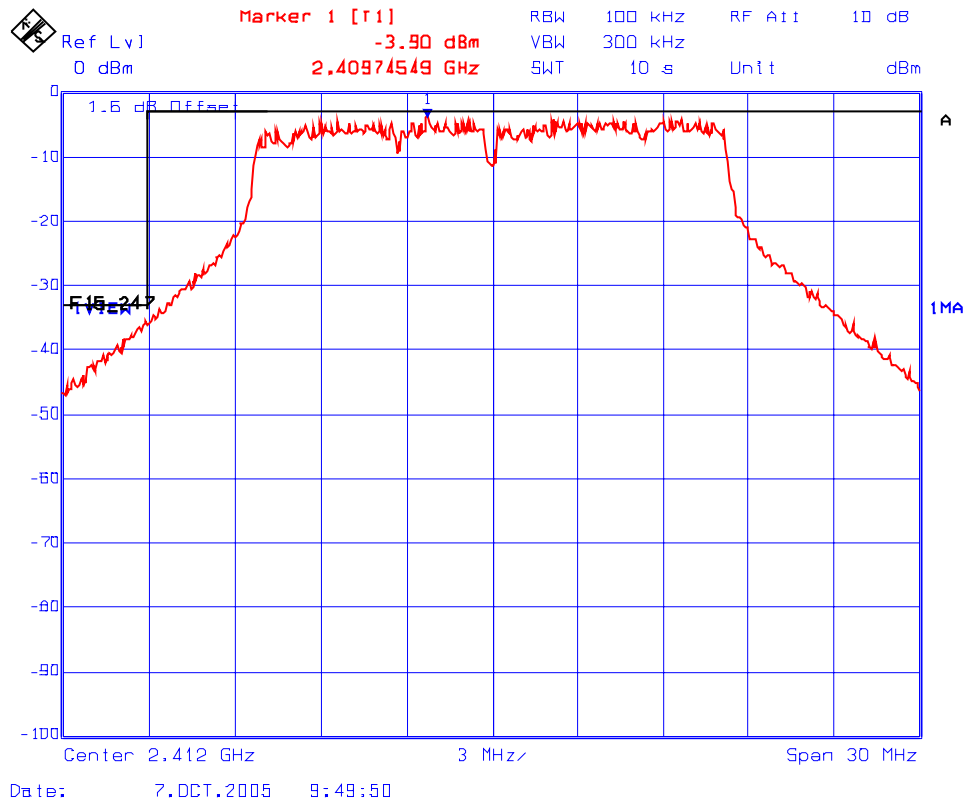

Plot 6.8.5.1.8
Band-Edge Conducted Emissions
High End of Frequency Band
Frequency: 2462 MHz; Modulation: DBPSK; Data Rate: 9 Mbps

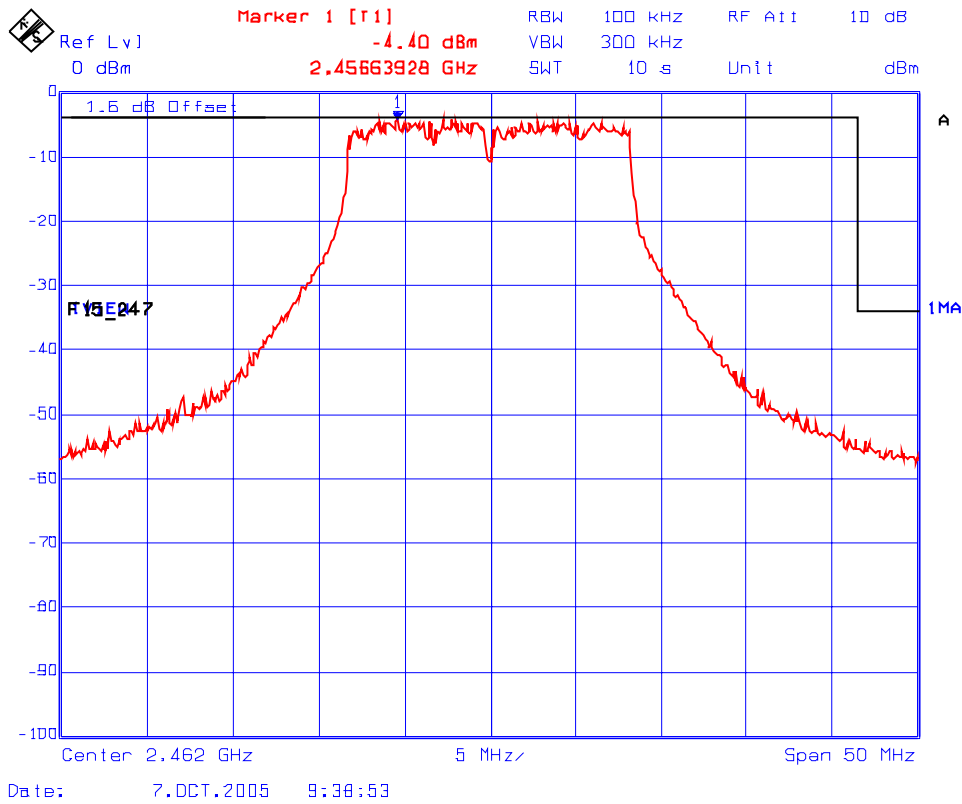

Plot 6.8.5.1.9
Band-Edge Conducted Emissions
Low End of Frequency Band
Frequency: 2412 MHz; Modulation: DQPSK; Data Rate: 18 Mbps

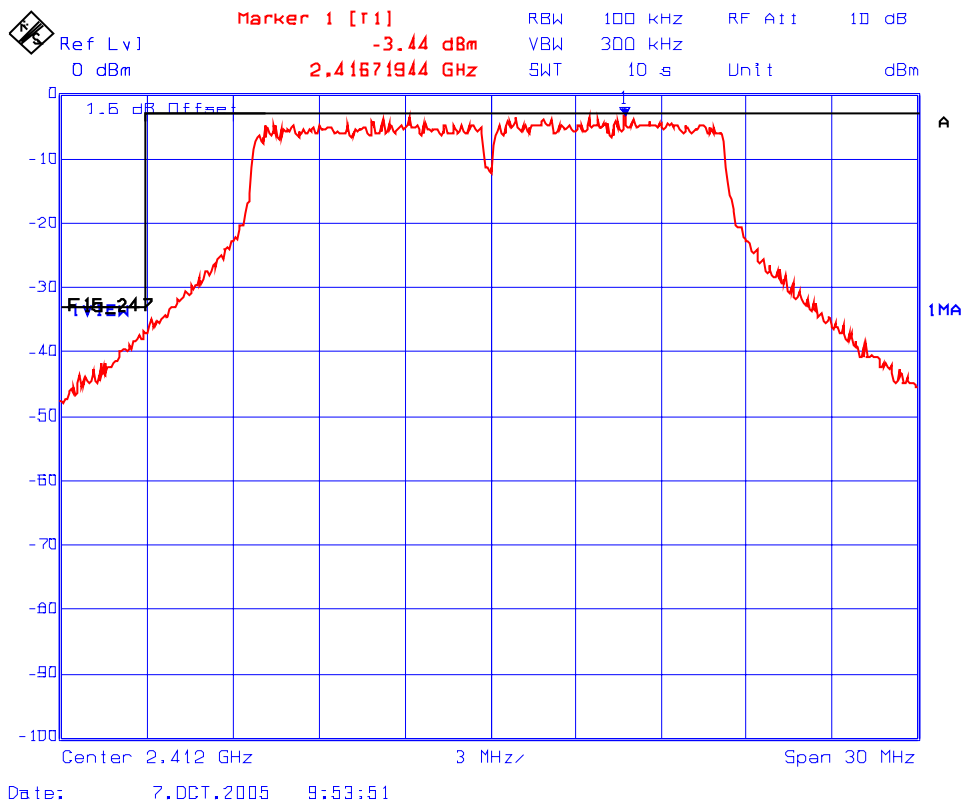

ULTRATECH GROUP OF LABS

3000 Bristol Circle, Oakville, Ontario, Canada L6H 6G4
Tel. #: 905-829-1570, Fax. #: 905-829-8050, Email: vic@ultratech-labs.com, Website: <http://www.ultratech-labs.com>

File #: TEK-508F15C247

October 27, 2005

All test results contained in this engineering test report are traceable to National Institute of Standards and Technology (NIST)

Plot 6.8.5.1.10
Band-Edge Conducted Emissions
High End of Frequency Band
Frequency: 2462 MHz; Modulation: DQPSK; Data Rate: 18 Mbps

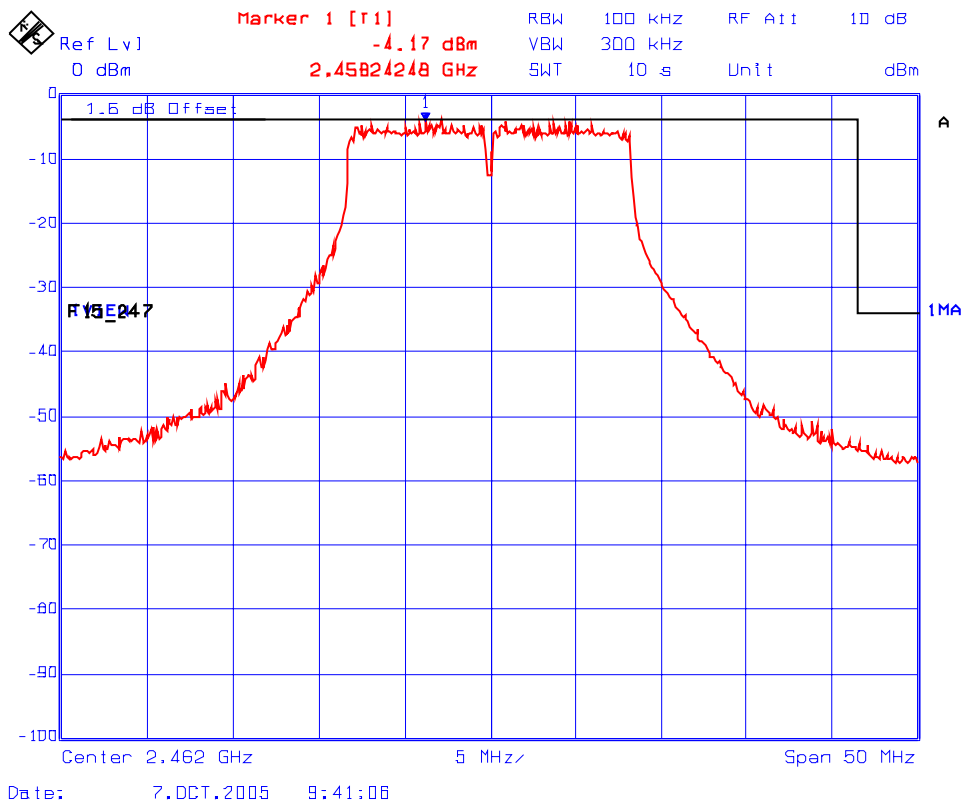

Plot 6.8.5.1.11
Band-Edge Conducted Emissions
Low End of Frequency Band
Frequency: 2412 MHz; Modulation: 16QAM; Data Rate: 36 Mbps

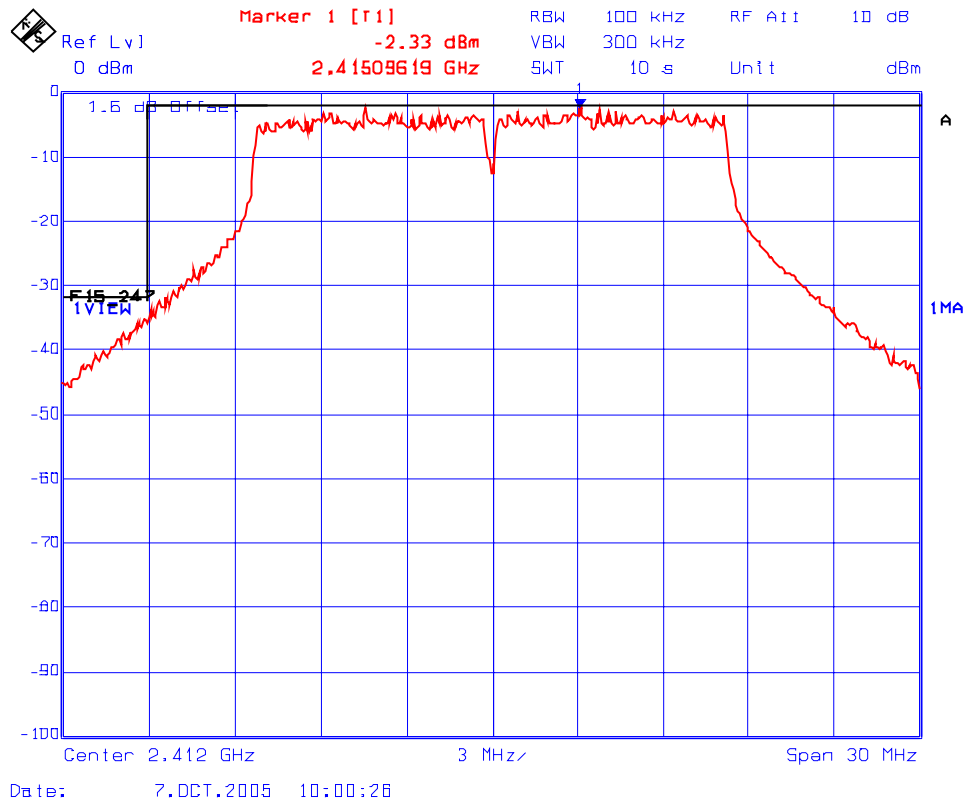

Plot 6.8.5.1.12
Band-Edge Conducted Emissions
High End of Frequency Band
Frequency: 2462 MHz; Modulation: 16QAM; Data Rate: 36 Mbps

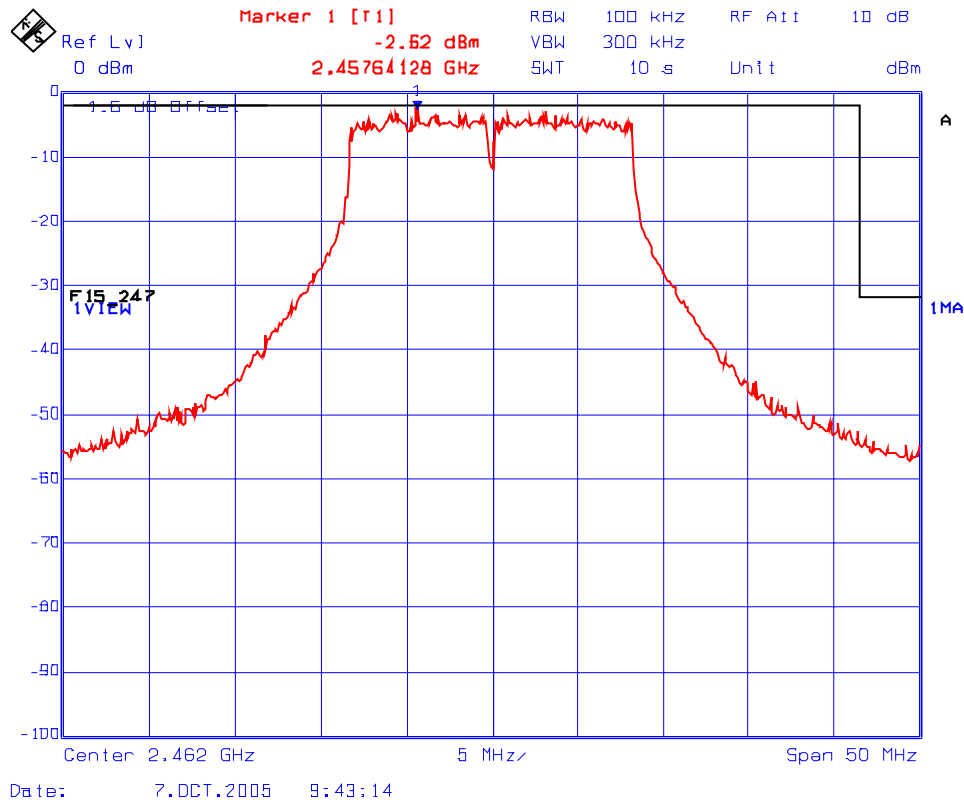

Plot 6.8.5.1.13
Band-Edge Conducted Emissions
Low End of Frequency Band
Frequency: 2412 MHz; Modulation: 64QAM; Data Rate: 54 Mbps

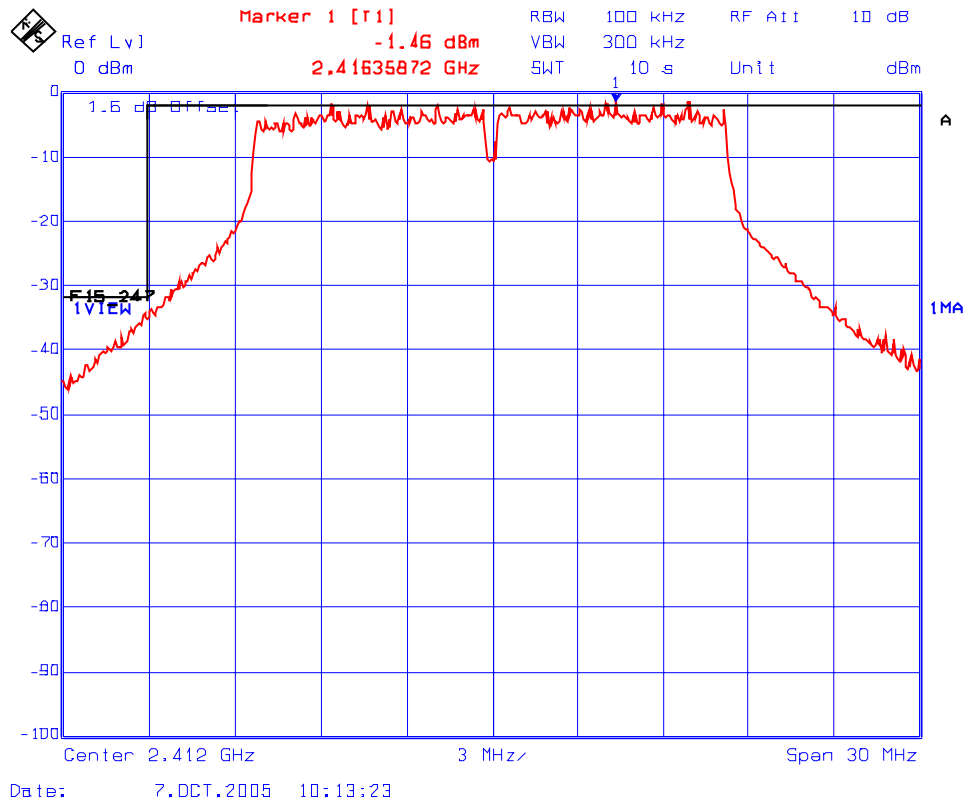

Plot 6.8.5.1.14
Band-Edge Conducted Emissions
High End of Frequency Band
Frequency: 2462 MHz; Modulation: 64QAM; Data Rate: 54 Mbps

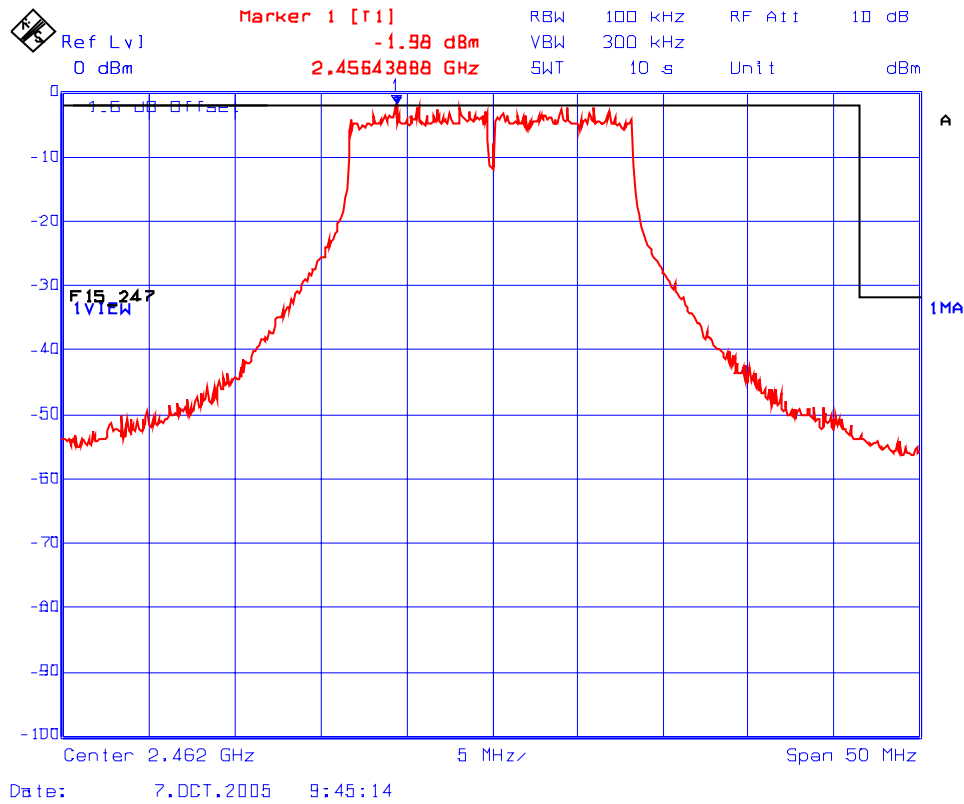

6.8.5.2. Spurious Conducted Emissions

Remark: The spurious conducted emissions were scanned from 30 MHz to 25 GHz with the analyzer set at Max Hold while the EUT operating at all applicable modulation types and data rates. The following resultant plots represent the worse case measurements.

6.8.5.2.1
Spurious Conducted Emissions
Test Frequency: 2412 MHz (802.11b)
Test Setting: Analyzer at Max Hold, EUT operating at 1, 2, 5.5, and 11 Mbps

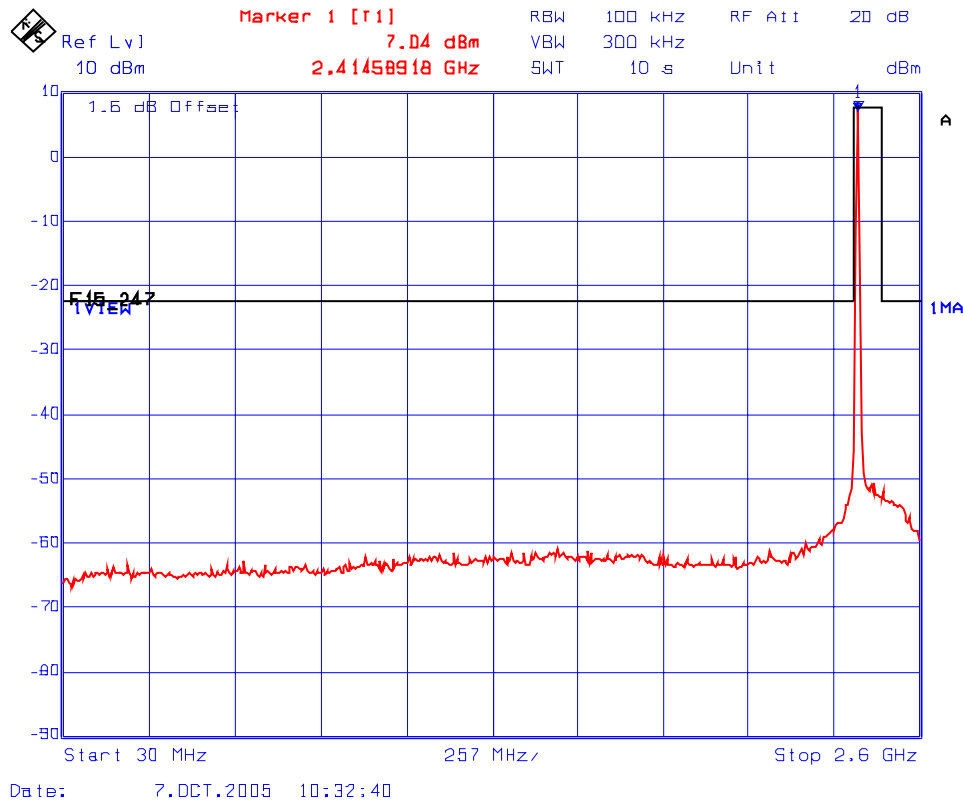

6.8.5.2.2
Spurious Conducted Emissions
Test Frequency: 2412 MHz (802.11b)
Test Setting: Analyzer at Max Hold, EUT operating at 1, 2, 5.5, and 11 Mbps

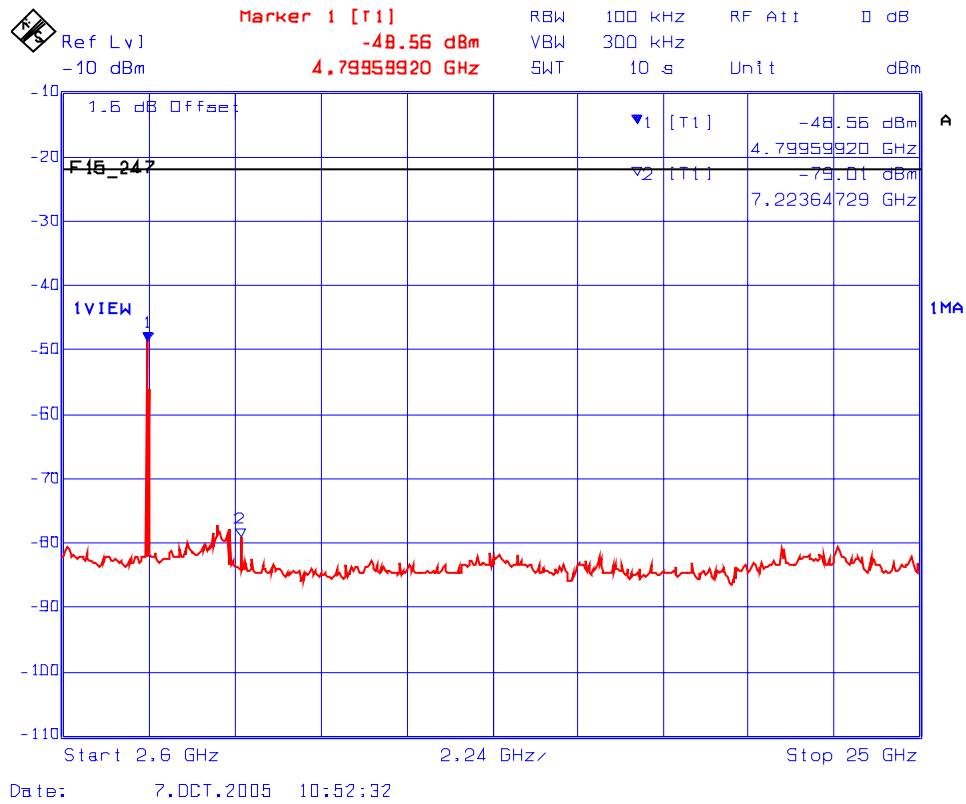

6.8.5.2.3
Spurious Conducted Emissions
Test Frequency: 2437 MHz (802.11b)
Test Setting: Analyzer at Max Hold, EUT operating at 1, 2, 5.5, and 11 Mbps

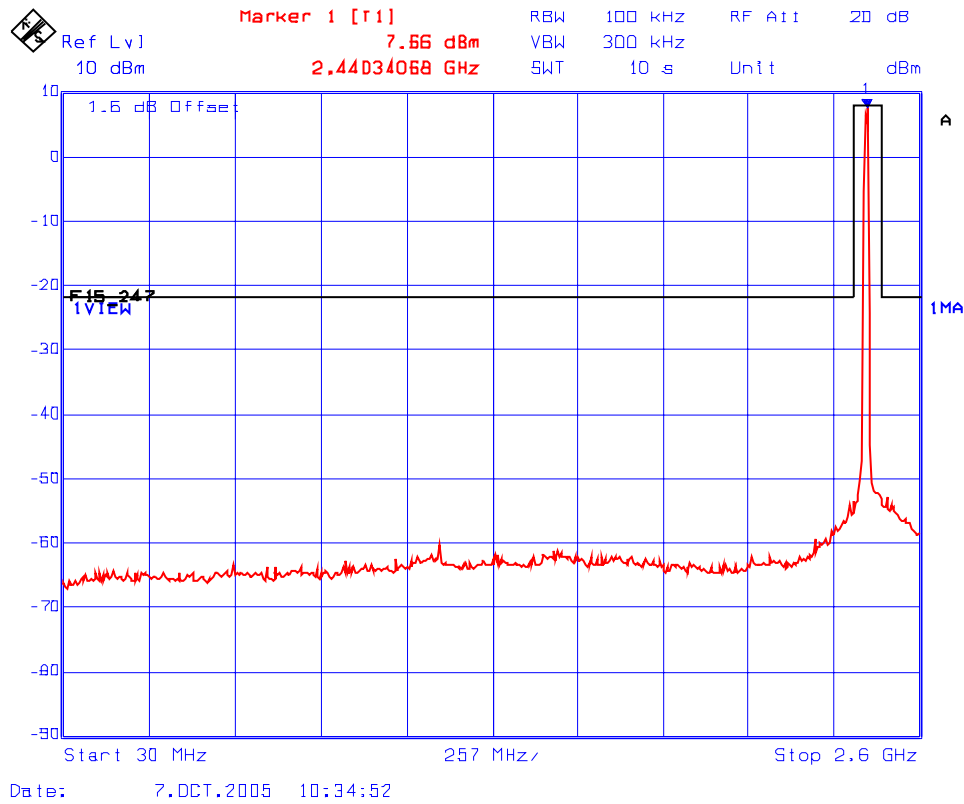

6.8.5.2.4
 Spurious Conducted Emissions
 Test Frequency: 2437 MHz (802.11b)
 Test Setting: Analyzer at Max Hold, EUT operating at 1, 2, 5.5, and 11 Mbps

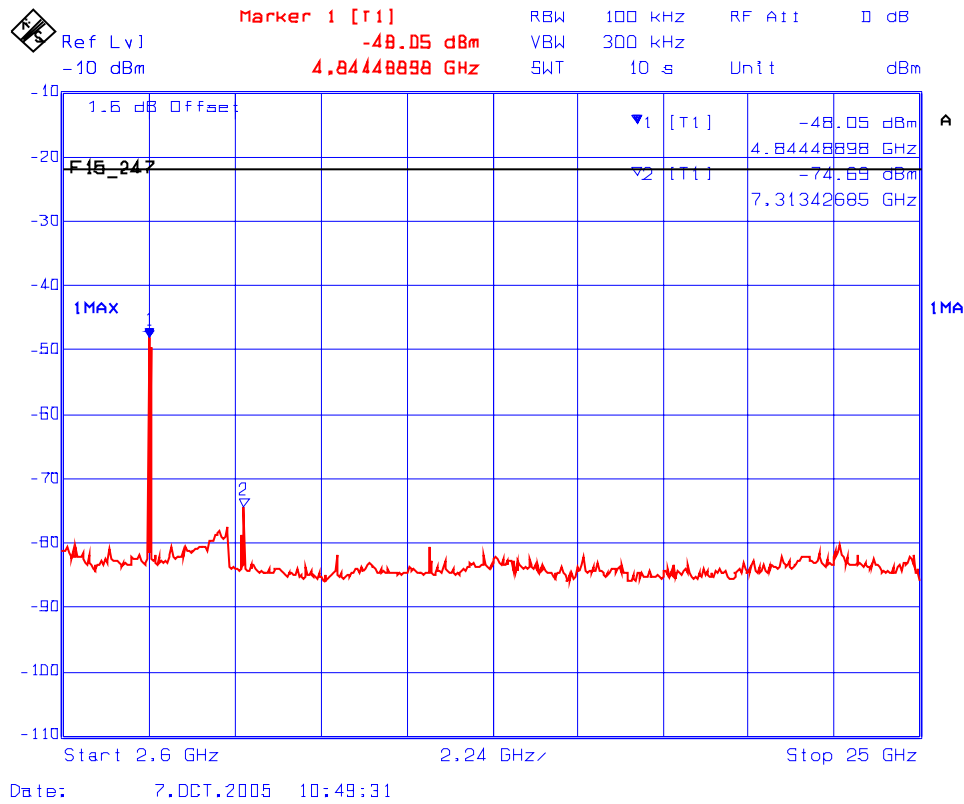

6.8.5.2.5
Spurious Conducted Emissions
Test Frequency: 2462 MHz (802.11b)
Test Setting: Analyzer at Max Hold, EUT operating at 1, 2, 5.5, and 11 Mbps

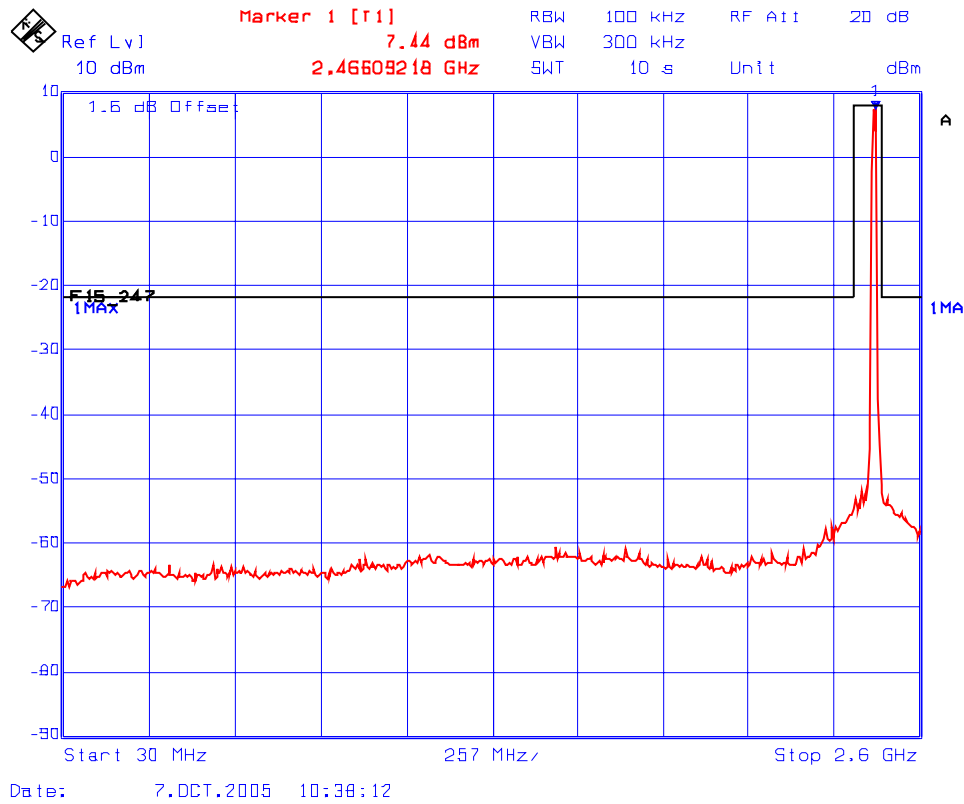

6.8.5.2.6
Spurious Conducted Emissions
Test Frequency: 2462 MHz (802.11b)
Test Setting: Analyzer at Max Hold, EUT operating at 1, 2, 5.5, and 11 Mbps

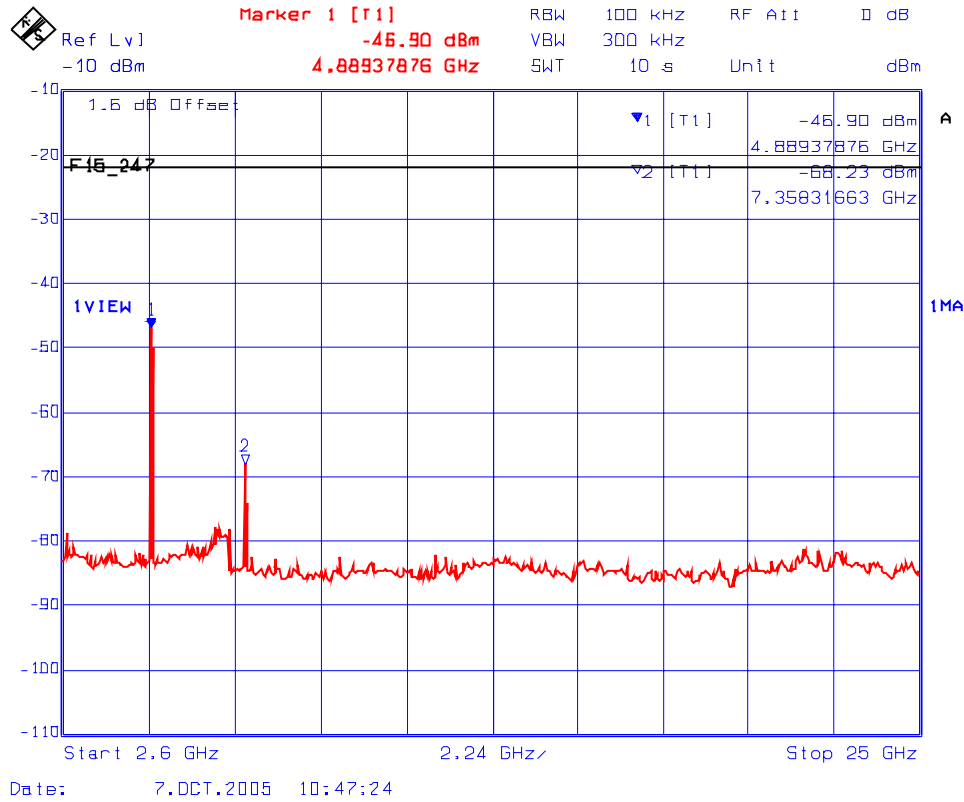

6.8.5.2.7
Spurious Conducted Emissions
Test Frequency: 2412 MHz (802.11g)
Test Setting: Analyzer at Max Hold, EUT operating at 6, 9, 12, 18, 24, 36, 48, and 54 Mbps

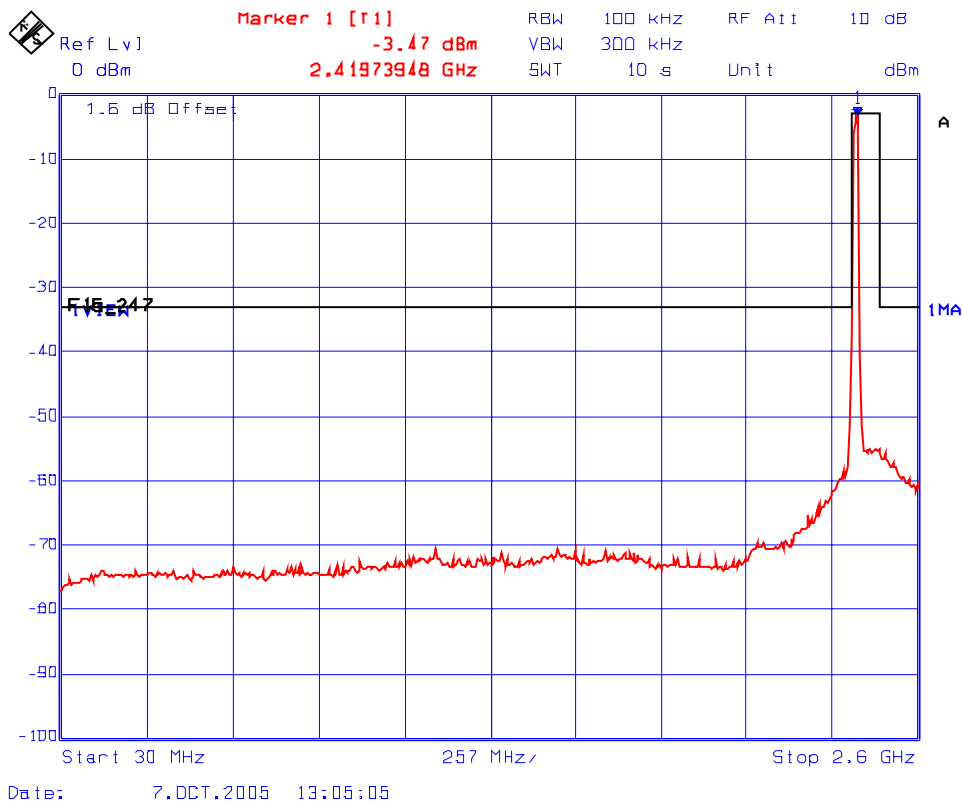

Plot 6.8.5.2.8
Spurious Conducted Emissions
Test Frequency: 2412 MHz (802.11g)
Test Setting: Analyzer at Max Hold, EUT operating at 6, 9, 12, 18, 24, 36, 48, and 54 Mbps

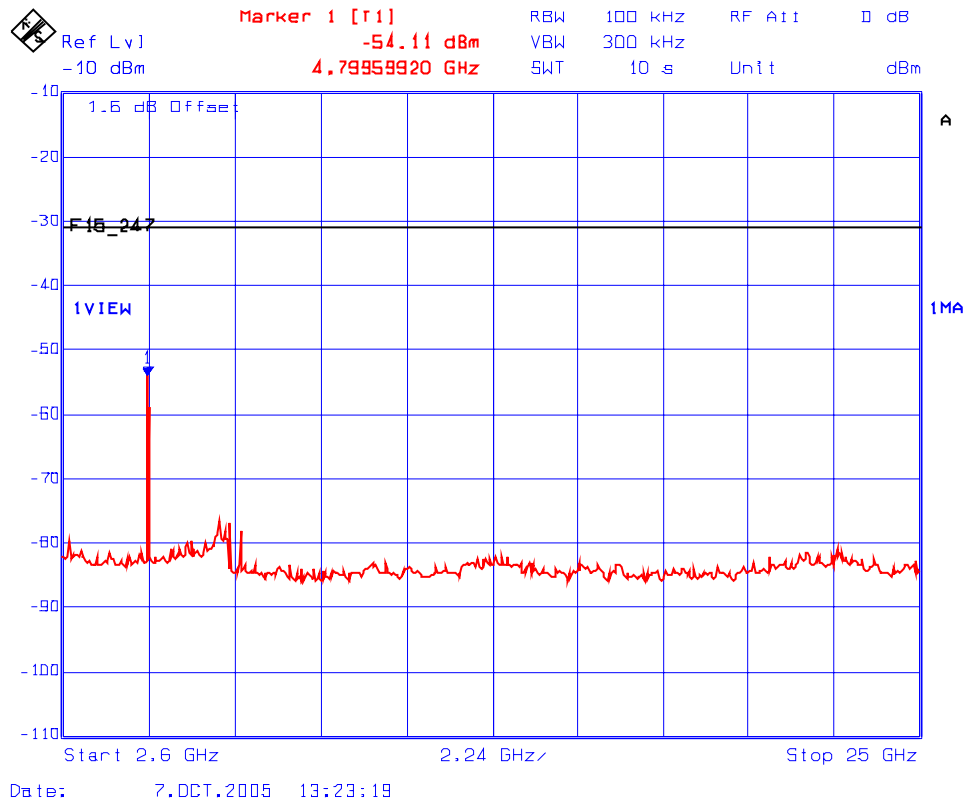

ULTRATECH GROUP OF LABS

3000 Bristol Circle, Oakville, Ontario, Canada L6H 6G4
Tel. #: 905-829-1570, Fax. #: 905-829-8050, Email: vic@ultratech-labs.com, Website: <http://www.ultratech-labs.com>

File #: TEK-508F15C247

October 27, 2005

All test results contained in this engineering test report are traceable to National Institute of Standards and Technology (NIST)

Plot 6.8.5.2.9
Spurious Conducted Emissions
Test Frequency: 2437 MHz (802.11g)
Test Setting: Analyzer at Max Hold, EUT operating at 6, 9, 12, 18, 24, 36, 48, and 54 Mbps

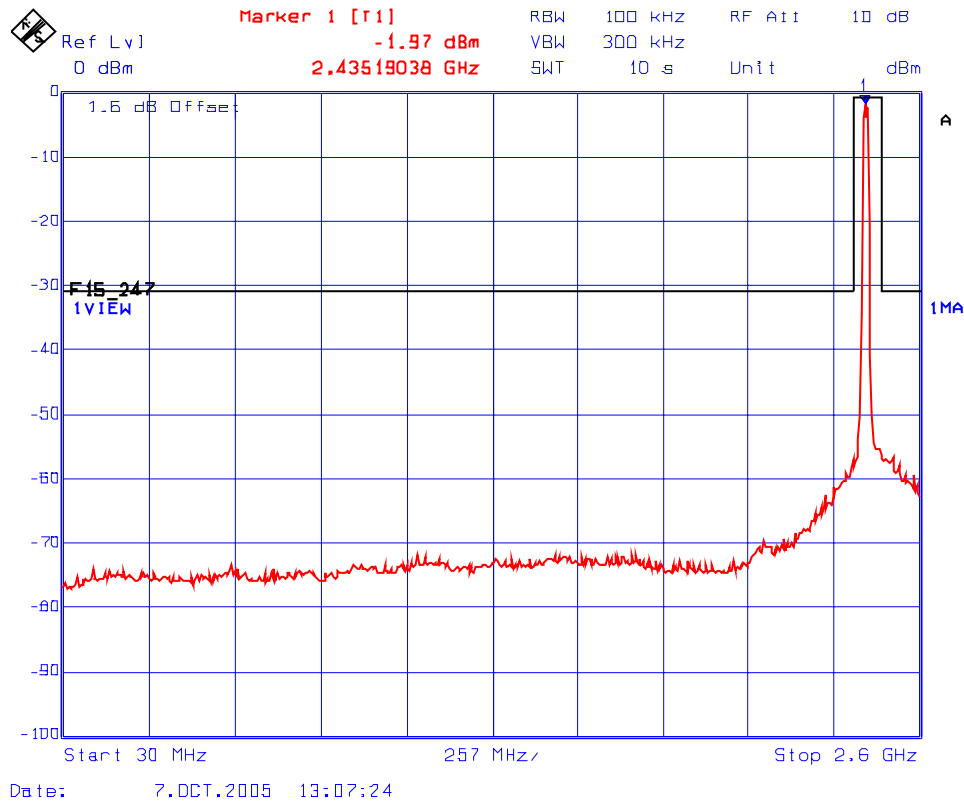

Plot 6.8.5.2.10
Spurious Conducted Emissions
Test Frequency: 2437 MHz (802.11g)
Test Setting: Analyzer at Max Hold, EUT operating at 6, 9, 12, 18, 24, 36, 48, and 54 Mbps

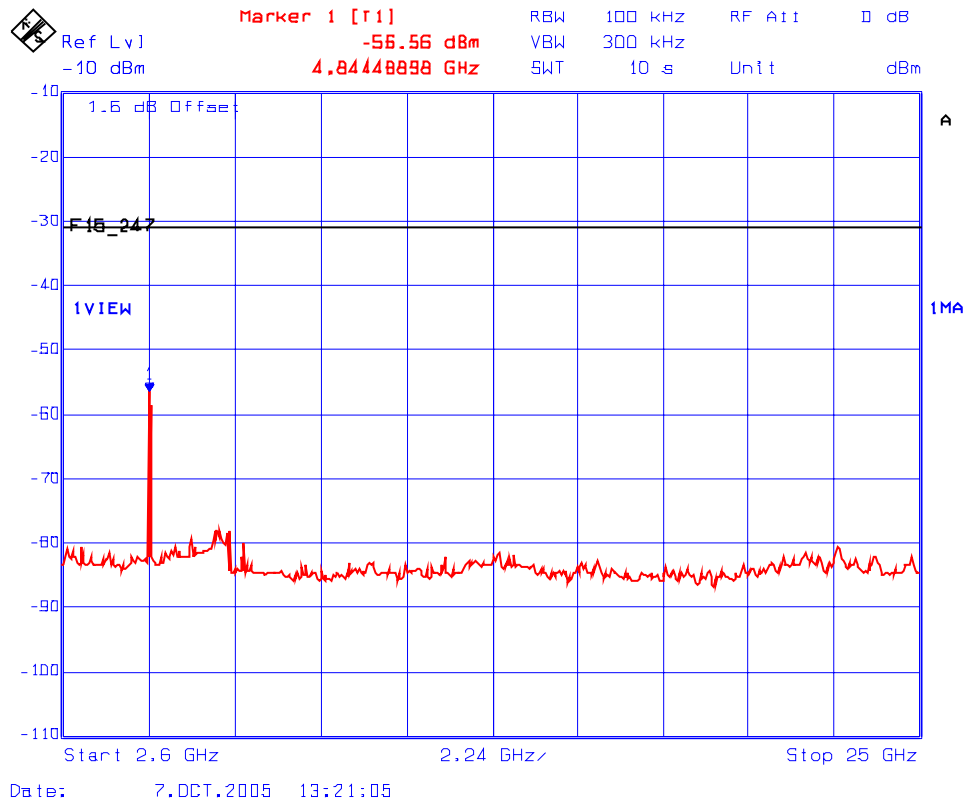

Plot 6.8.5.2.11
Spurious Conducted Emissions
Test Frequency: 2462 MHz (802.11g)
Test Setting: Analyzer at Max Hold, EUT operating at 6, 9, 12, 18, 24, 36, 48, and 54 Mbps

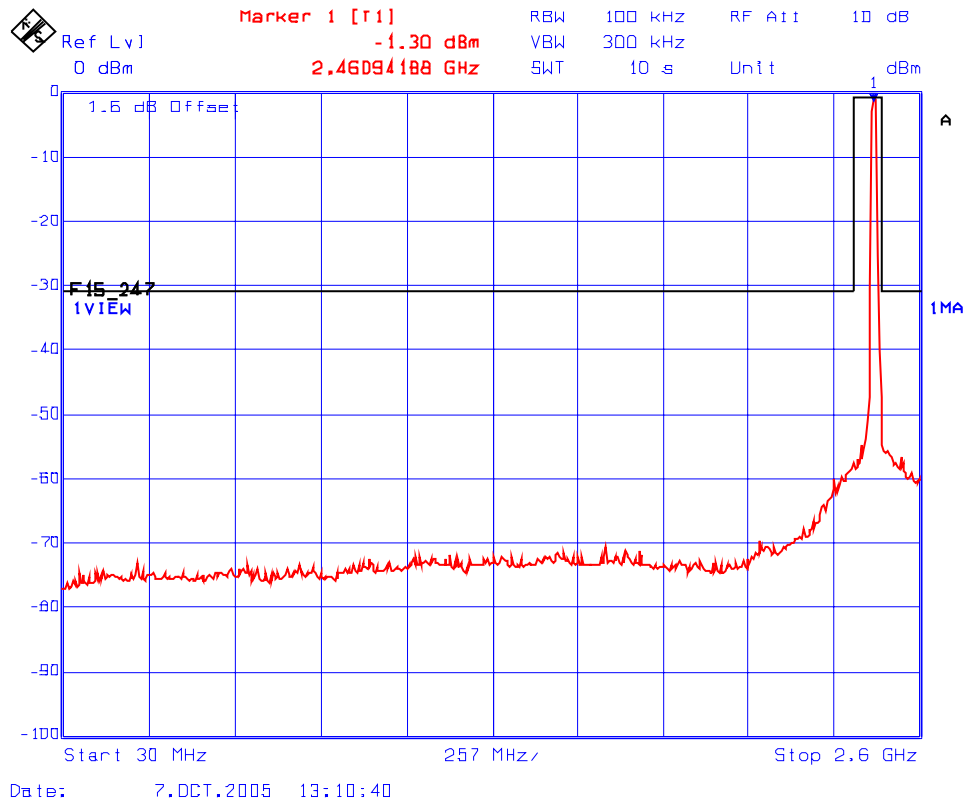

Plot 6.8.5.2.12
Spurious Conducted Emissions
Test Frequency: 2462 MHz (802.11g)
Test Setting: Analyzer at Max Hold, EUT operating at 6, 9, 12, 18, 24, 36, 48, and 54 Mbps

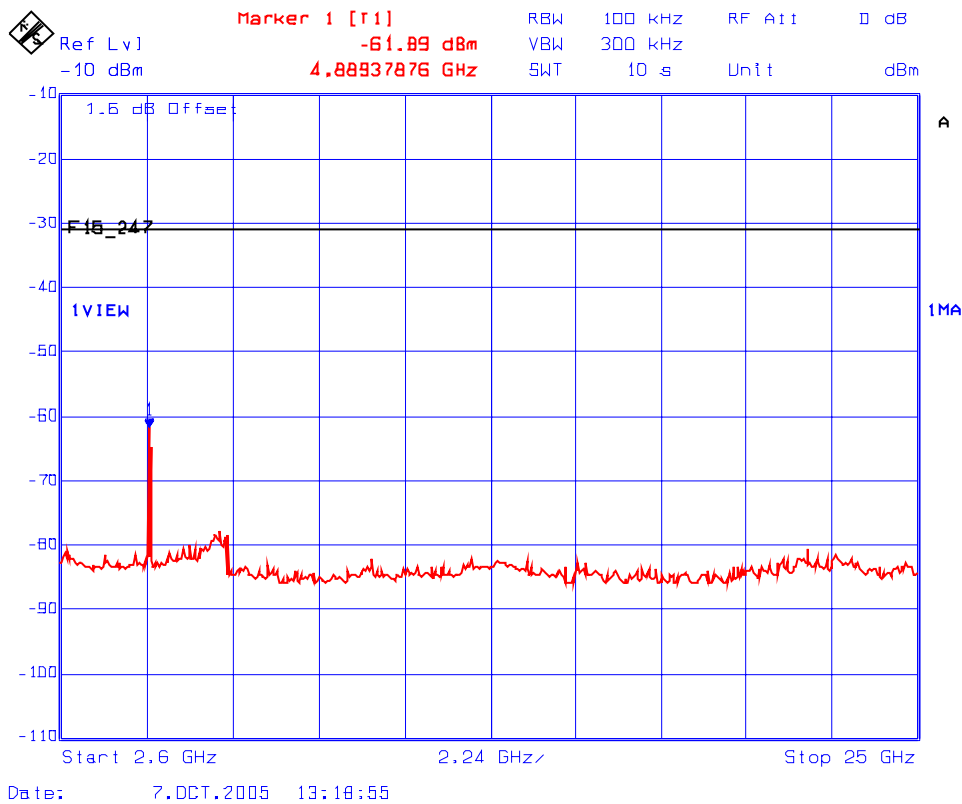

6.9. SPURIOUS RADIATED EMISSIONS @ 3 METERS [§ 15.247(d)]

6.9.1. Limits

(d) In any 100 kHz bandwidth outside the frequency band in which the spread spectrum or digitally modulated intentional radiator is operating, the radio frequency power that is produced by the intentional radiator shall be at least 20 dB below that in the 100 kHz bandwidth within the band that contains the highest level of the desired power, based on either an RF conducted or a radiated measurement, provided the transmitter demonstrates compliance with the peak conducted power limits. If the transmitter complies with the conducted power limits based on the use of RMS averaging over a time interval, as permitted under paragraph (b)(3) of this section, the attenuation required under this paragraph shall be 30 dB instead of 20 dB. Attenuation below the general limits specified in Section 15.209(a) is not required. In addition, radiated emissions which fall in the restricted bands, as defined in Section 15.205(a), must also comply with the radiated emission limits specified in Section 15.209(a) (see Section 15.205(c)).

47 CFR 15.205(a) - Restricted Bands of Operation

MHz	MHz	MHz	GHz
0.090 - 0.110	16.42 - 16.423	399.9 - 410	4.5 - 5.15
¹ 0.495 - 0.505	16.69475 - 16.69525	608 - 614	5.35 - 5.46
2.1735 - 2.1905	16.80425 - 16.80475	960 - 1240	7.25 - 7.75
4.125 - 4.128	25.5 - 25.67	1300 - 1427	8.025 - 8.5
4.17725 - 4.17775	37.5 - 38.25	1435 - 1626.5	9.0 - 9.2
4.20725 - 4.20775	73 - 74.6	1645.5 - 1646.5	9.3 - 9.5
6.215 - 6.218	74.8 - 75.2	1660 - 1710	10.6 - 12.7
6.26775 - 6.26825	108 - 121.94	1718.8 - 1722.2	13.25 - 13.4
6.31175 - 6.31225	123 - 138	2200 - 2300	14.47 - 14.5
8.291 - 8.294	149.9 - 150.05	2310 - 2390	15.35 - 16.2
8.362 - 8.366	156.52475 - 156.52525	2483.5 - 2500	17.7 - 21.4
8.37625 - 8.38675	156.7 - 156.9	2690 - 2900	22.01 - 23.12
8.41425 - 8.41475	162.0125 - 167.17	3260 - 3267	23.6 - 24.0
12.29 - 12.293	167.72 - 173.2	3332 - 3339	31.2 - 31.8
12.51975 - 12.52025	240 - 285	3345.8 - 3358	36.43 - 36.5
12.57675 - 12.57725	322 - 335.4	3600 - 4400	(2)
13.36 - 13.41			

¹ Until February 1, 1999, this restricted band shall be 0.490-0.510 MHz.

² Above 38.6

47 CFR 15.209(a) - Radiated emission limits, general requirements

Frequency (MHz)	Field Strength (microvolts/meter)	Measurement Distance (meters)
0.009 - 0.490	2400/F(kHz)	300
0.490 - 1.705	24000/F(kHz)	30
1.705 - 30.0	30	30
30 - 88	100 **	3
88 - 216	150 **	3
216 - 960	200 **	3
Above 960	500	3

** Except as provided in paragraph (g), fundamental emissions from intentional radiators operating under this Section shall not be located in the frequency bands 54-72 MHz, 76-88 MHz, 174-216 MHz or 470-806 MHz. However, operation within these frequency bands is permitted under other sections of this Part, e.g., Sections 15.231 and 15.241.

6.9.2. Method of Measurements

KDB Publication No. 558074: Guidance on Measurements for Digital Transmission Systems (47 CFR 15.247); Exhibit 8, Section 8.3 of this test report and ANSI 63.4:2003 for detailed radiated emissions measurement procedures.

6.9.3. Test Arrangement

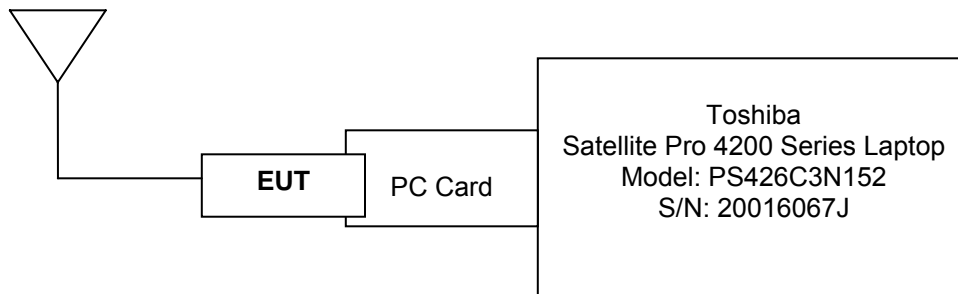

6.9.4. Test Equipment List

Test Instruments	Manufacturer	Model No.	Serial No.	Frequency Range
Spectrum Analyzer	Rhode & Schwarz	FSEK20/B4/B21	834157/005	9 kHz- 40 GHz
Microwave Amplifier	Hewlett Packard	HP 83017A		1 GHz to 26.5 GHz
Biconilog Antenna	EMCO	3143	1029	20 MHz to 2 GHz
Horn Antenna	EMCO	3155	9701-5061	1 GHz – 18 GHz

6.9.5. Test Data

6.9.5.1. Band-edge Radiated Emissions

Plot 6.9.5.1.1
Band-Edge Radiated Emissions @ 3 meters, Horizontal Polarization
Low End of Frequency Band
Frequency: 2412 MHz; Modulation: CCK; Data Rate: 11 Mbps
Trace 1: RBW = 1 MHz, VBW = 3 MHz
Trace 2: RBW = 1 MHz, VBW = 10 Hz

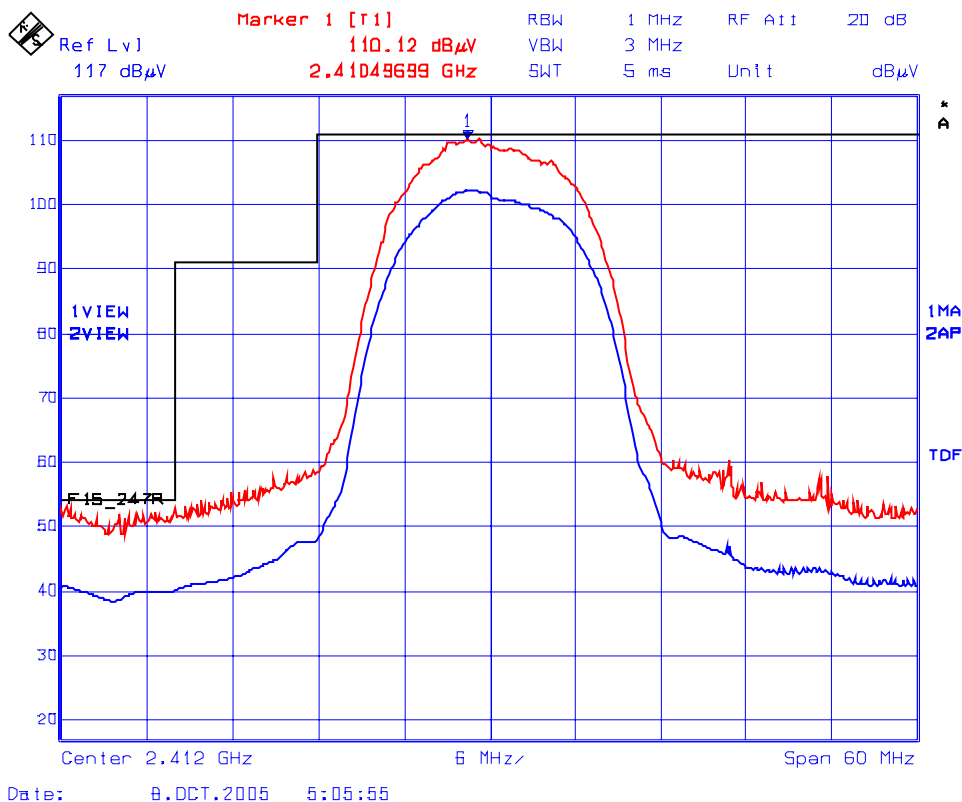

Plot 6.9.5.1.2
Band-Edge Radiated Emissions @ 3 meters, Vertical Polarization
Low End of Frequency Band
Frequency: 2412 MHz; Modulation: CCK; Data Rate: 11 Mbps
Trace 1: RBW = 1 MHz, VBW = 3 MHz
Trace 2: RBW = 1 MHz, VBW = 10 Hz

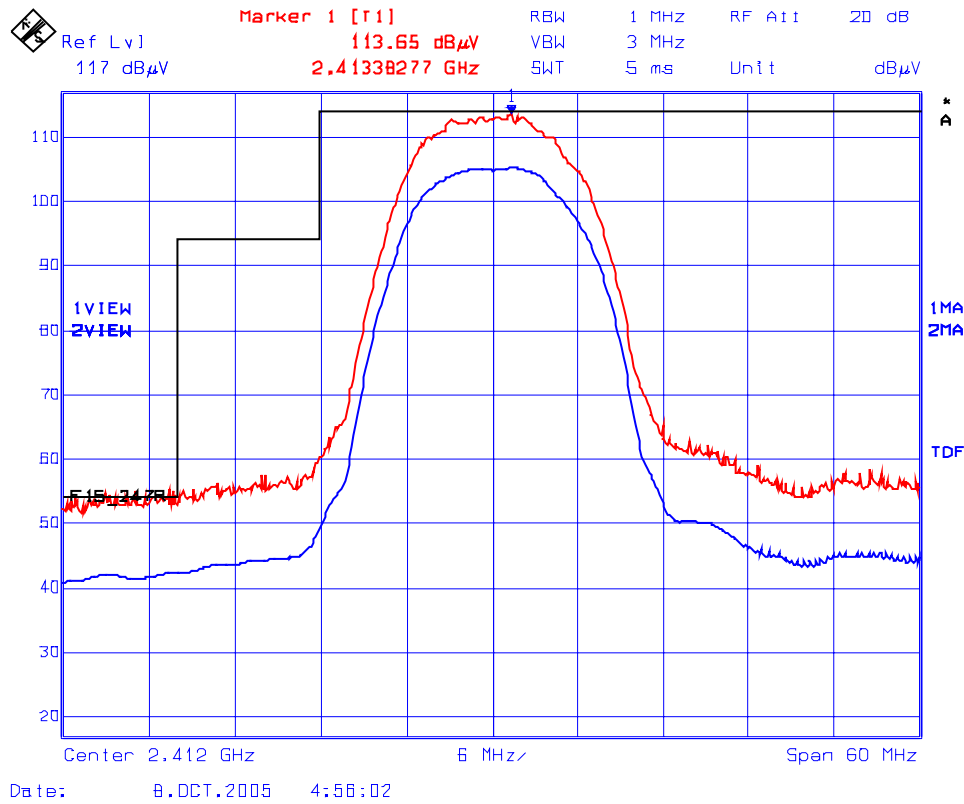

Plot 6.9.5.1.3
 Band-Edge Radiated Emissions @ 3 meters, Horizontal Polarization
 Upper End of Frequency Band
 Frequency: 2462 MHz; Modulation: CCK; Data Rate: 11 Mbps
 Trace 1: RBW = 1 MHz, VBW = 3 MHz
 Trace 2: RBW = 1 MHz, VBW = 10 Hz

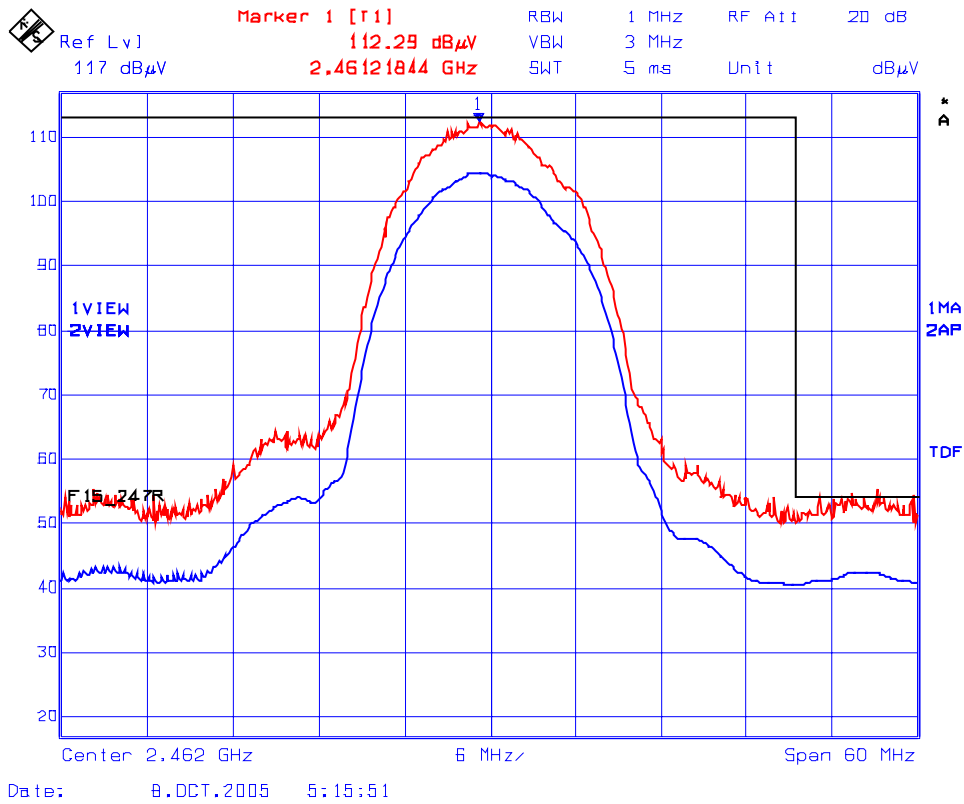

Plot 6.9.5.1.4
Band-Edge Radiated Emissions @ 3 meters, Vertical Polarization
High End of Frequency Band
Frequency: 2462 MHz; Modulation: CCK; Data Rate: 11 Mbps
Trace 1: RBW = 1 MHz, VBW = 3 MHz
Trace 2: RBW = 1 MHz, VBW = 10 Hz

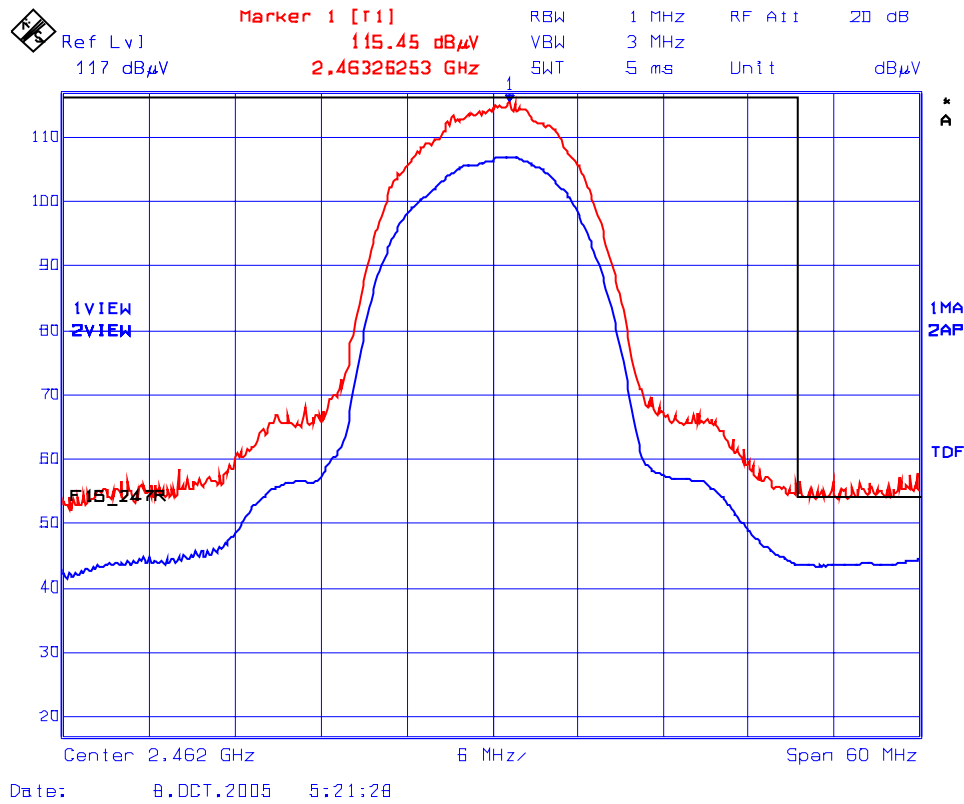

Plot 6.9.5.1.5
 Band-Edge Radiated Emissions @ 3 meters, Horizontal Polarization
 Low End of Frequency Band
 Frequency: 2412 MHz; Modulation: 64QAM; Data Rate: 54 Mbps
 Trace 1: RBW= 1 MHz, VBW= 3 MHz
 Trace 2: RBW= 1 MHz, VBW= 10 Hz

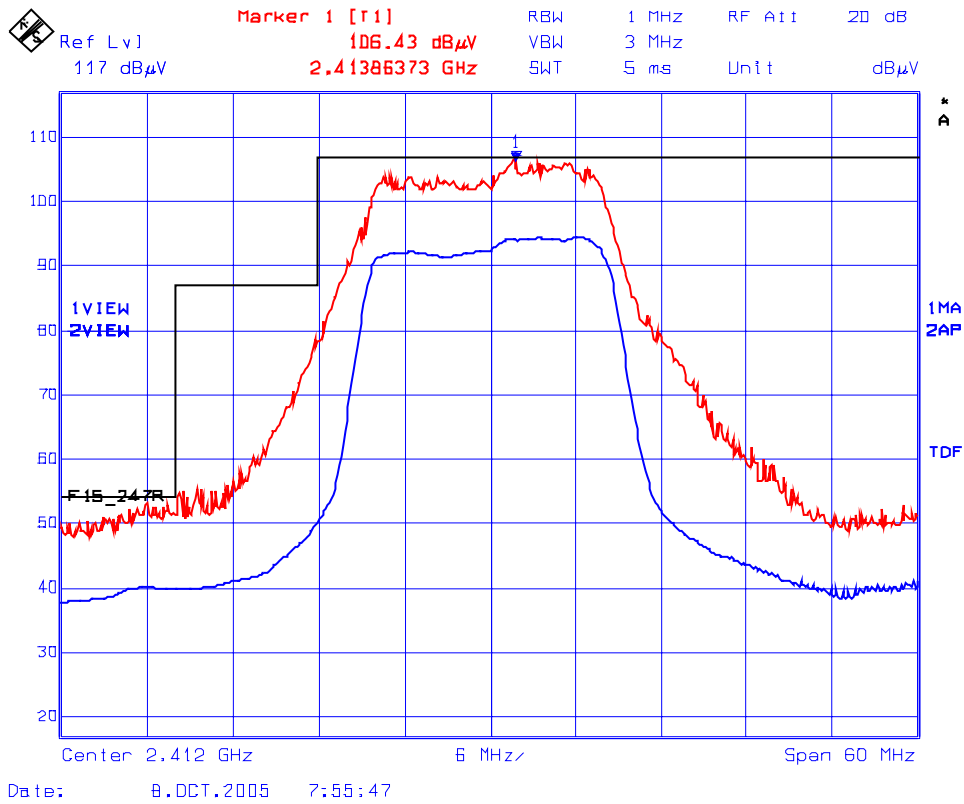

Plot 6.9.5.1.6
 Band-Edge Radiated Emissions @ 3 meters, Vertical Polarization
 Low End of Frequency Band
 Frequency: 2412 MHz; Modulation: 64QAM; Data Rate: 54 Mbps
 Trace 1: RBW= 1 MHz, VBW= 3 MHz
 Trace 2: RBW= 1 MHz, VBW= 10 Hz

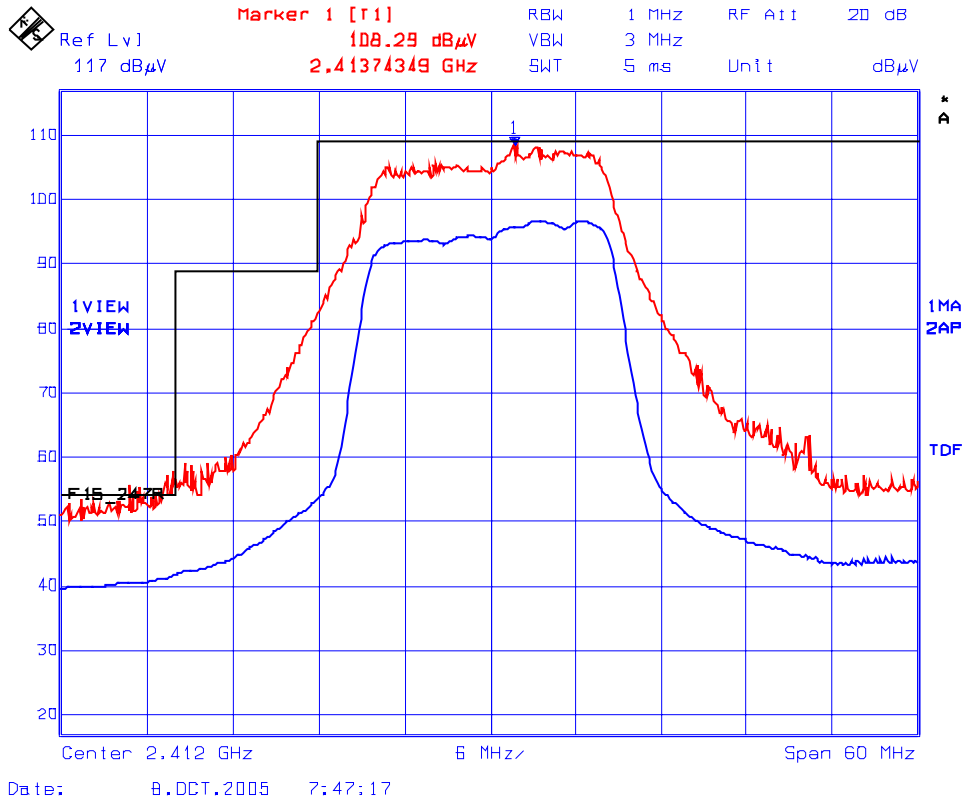

Plot 6.9.5.1.7
 Band-Edge Radiated Emissions @ 3 meters, Horizontal Polarization
 Upper End of Frequency Band
 Frequency: 2462 MHz; Modulation: 64QAM; Data Rate: 54 Mbps
 Trace 1: RBW= 1 MHz, VBW= 3 MHz
 Trace 2: RBW= 1 MHz, VBW= 10 Hz

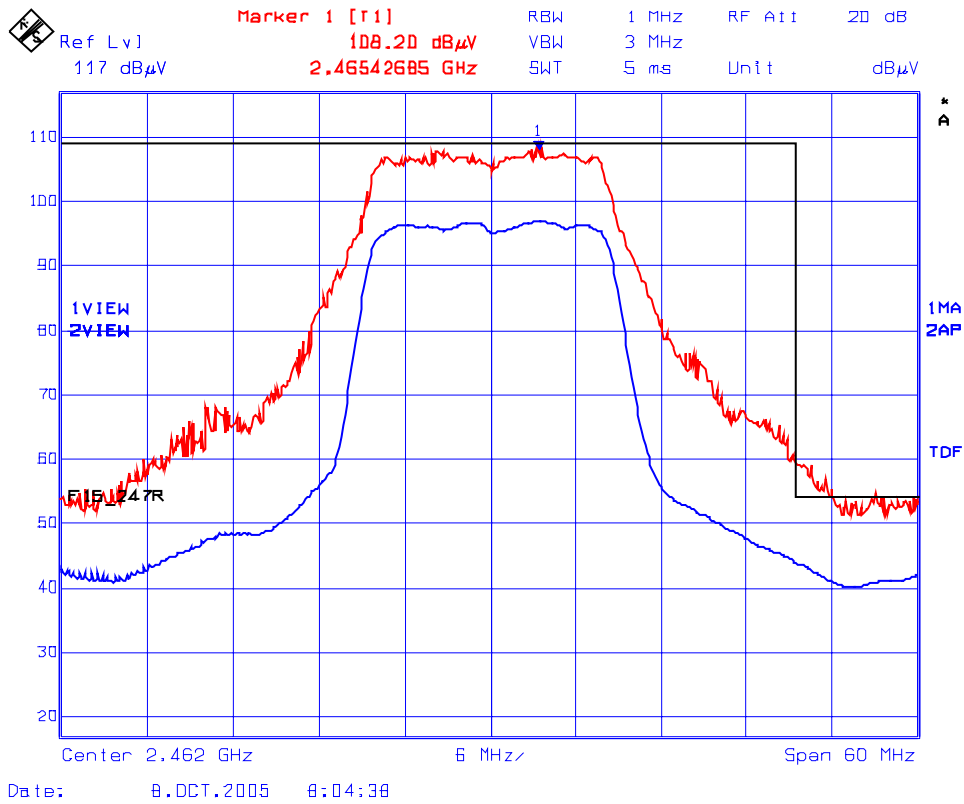

Plot 6.9.5.1.8
 Band-Edge Radiated Emissions @ 3 meters, Vertical Polarization
 Upper End of Frequency Band
 Frequency: 2462 MHz; Modulation: 64QAM; Data Rate: 54 Mbps
 Trace 1: RBW= 1 MHz, VBW= 3 MHz
 Trace 2: RBW= 1 MHz, VBW= 10 Hz

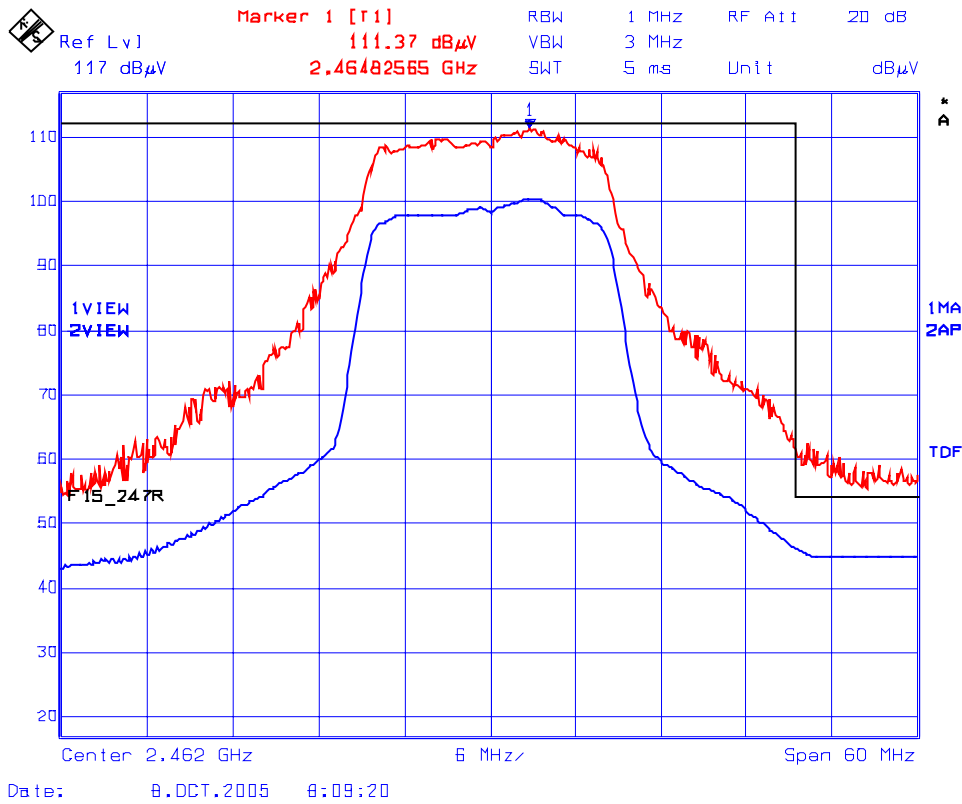

6.9.5.2. Spurious Radiated Emissions

Remarks:

1. The emissions were scanned from 10 MHz to 25 GHz; all emissions within 20 dB below the limits were recorded.
2. The following test results are the worst-case measurements.

6.9.5.2.1. 802.11b Operation

Frequency (MHz)	RF Peak Level (dBµV/m)	RF Avg Level (dBµV/m)	Antenna Plane (H/V)	Limit 15.209 (dBµV/m)	Limit 15.247 (dBµV/m)	Margin (dB)	Pass/Fail
Fundamental Frequency: 2412 MHz							
2412	113.65	--	V	--	--	--	--
2412	110.12	--	H	--	--	--	--
4824	61.82	49.24	V	54.0	83.7	-4.8	Pass*
4824	62.27	49.76	H	54.0	83.7	-4.2	Pass*
Fundamental Frequency: 2437 MHz							
2437	114.26	--	V	--	--	--	--
2437	113.00	--	H	--	--	--	--
4874	58.98	44.61	V	54.0	84.3	-9.4	Pass*
4874	57.62	44.38	H	54.0	84.3	-9.6	Pass*
Fundamental Frequency: 2462 MHz							
2462	115.45	--	V	--	--	--	--
2462	112.29	--	H	--	--	--	--
4924	56.36	43.84	V	54.0	85.5	-10.2	Pass*
4924	57.08	44.86	H	54.0	85.5	-9.1	Pass*

* Emission within the restricted frequency bands.

6.9.5.2.2. 802.11g Operation

Frequency (MHz)	RF Peak Level (dBµV/m)	RF Avg Level (dBµV/m)	Antenna Plane (H/V)	Limit 15.209 (dBµV/m)	Limit 15.247 (dBµV/m)	Margin (dB)	Pass/Fail
Fundamental Frequency: 2412 MHz							
2412	108.29	--	V	--	--	--	--
2412	106.43	--	H	--	--	--	--
4824	54.18	40.19	V	54.0	78.3	-13.8	Pass*
4824	55.23	40.99	H	54.0	78.3	-13.0	Pass*
Fundamental Frequency: 2437 MHz							
2437	111.81	--	V	--	--	--	--
2437	108.21	--	H	--	--	--	--
4874	53.69	39.27	V	54.0	81.8	-14.7	Pass*
4874	54.57	40.16	H	54.0	81.8	-13.8	Pass*
Fundamental Frequency: 2462 MHz							
2462	111.37	--	V	--	--	--	--
2462	108.20	--	H	--	--	--	--
4924	54.58	40.15	V	54.0	81.4	-13.9	Pass*
4924	55.26	40.58	H	54.0	81.4	-13.4	Pass*

* Emission within the restricted frequency bands.

6.10. POWER SPECTRAL DENSITY [§ 15.247(e)]

6.10.1. Limits

For digitally modulated systems, the power spectral density conducted from the intentional radiator to the antenna shall not be greater than 8 dBm in any 3 kHz band during any time interval of continuous transmission.

6.10.2. Method of Measurements

KDB Publication No. 558074: Guidance on Measurements for Digital Transmission Systems (47 CFR 15.247), PSD Option 2 method.

6.10.3. Test Arrangement

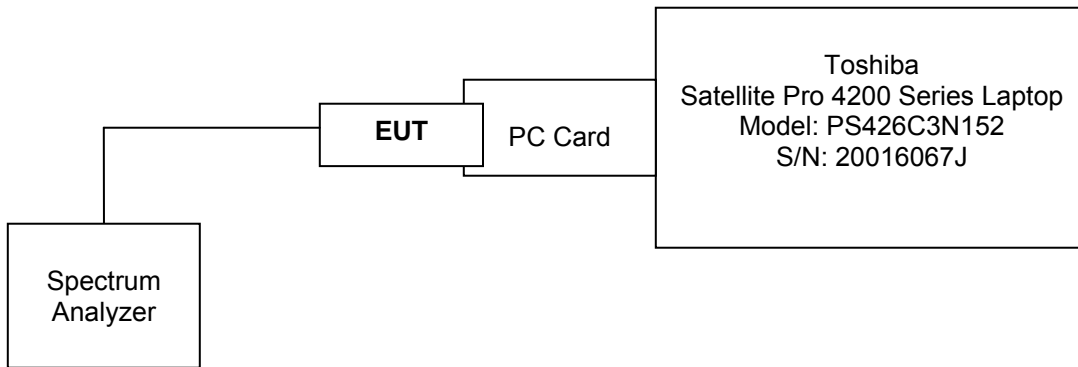

6.10.4. Test Equipment List

Test Instruments	Manufacturer	Model No.	Serial No.	Frequency Range
Spectrum Analyzer	Rhode & Schwarz	FSEK20/B4/B21	834157/005	9 kHz- 40 GHz

6.10.5. Test Data

Remark: Measurement method: Power spectral density (PSD) Option 2.

Frequency (MHz)	Modulation Data Rate	RF Power Level in 3 kHz BW (dBm)	Limit (dBm)	Margin (dB)	Comments (Pass/Fail)
802.11b					
2412	DBPSK, 1 Mbps	-15.58	8.0	-23.58	Pass
2437	DBPSK, 1 Mbps	-14.53	8.0	-22.53	Pass
2462	DBPSK, 1 Mbps	-14.08	8.0	-22.08	Pass
2412	DQPSK, 2 Mbps	-9.37	8.0	-17.37	Pass
2437	DQPSK, 2 Mbps	-8.15	8.0	-16.15	Pass
2462	DQPSK, 2 Mbps	-7.98	8.0	-15.98	Pass
2412	CCK, 11 Mbps	-9.92	8.0	-17.92	Pass
2437	CCK, 11 Mbps	-8.32	8.0	-16.32	Pass
2462	CCK, 11 Mbps	-8.02	8.0	-16.02	Pass
802.11g					
2412	DBPSK, 9 Mbps	-20.24	8.0	-28.24	Pass
2437	DBPSK, 9 Mbps	-19.11	8.0	-27.11	Pass
2462	DBPSK, 9 Mbps	-18.29	8.0	-26.29	Pass
2412	DQPSK, 18 Mbps	-18.13	8.0	-26.13	Pass
2437	DQPSK, 18 Mbps	-16.91	8.0	-24.91	Pass
2462	DQPSK, 18 Mbps	-16.03	8.0	-24.03	Pass
2412	16QAM, 36 Mbps	-15.72	8.0	-23.72	Pass
2437	16QAM, 36 Mbps	-14.25	8.0	-22.25	Pass
2462	16QAM, 36 Mbps	-14.77	8.0	-22.77	Pass
2412	64QAM, 54 Mbps	-15.76	8.0	-23.76	Pass
2437	64QAM, 54 Mbps	-14.88	8.0	-22.88	Pass
2462	64QAM, 54 Mbps	-14.88	8.0	-22.88	Pass

See the following plots for measurement details.

Plot 6.10.5.1
Power Spectral Density
Frequency: 2412 MHz; Modulation: DBPSK; Data Rate: 1 Mbps

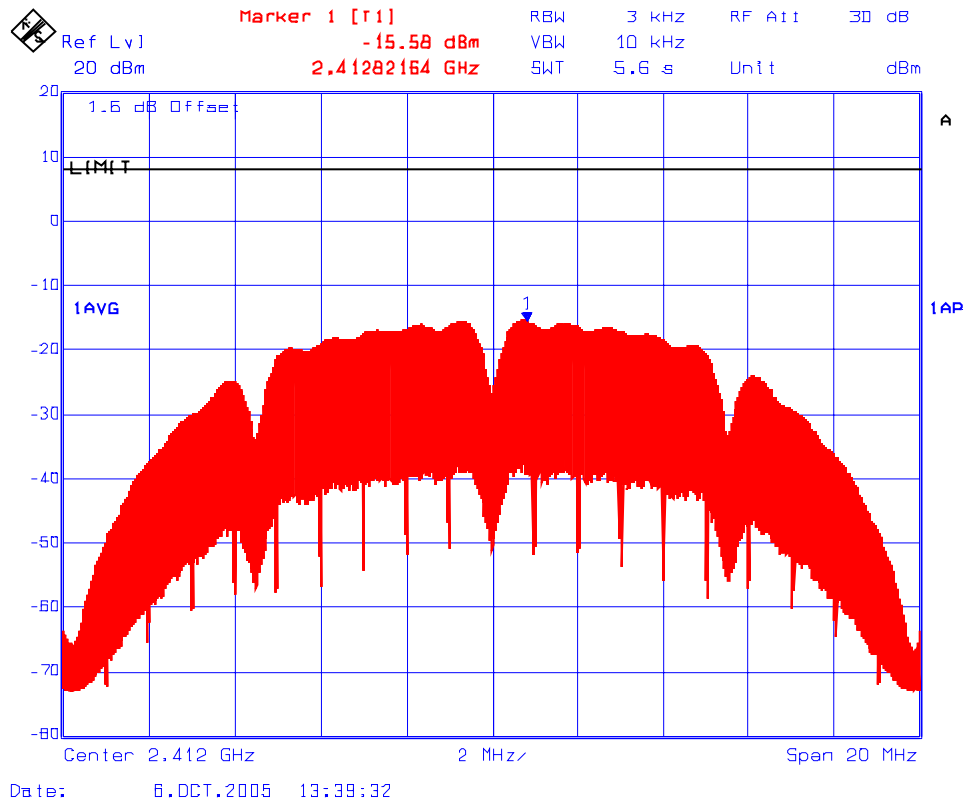

Plot 6.10.5.2
Power Spectral Density
Frequency: 2437 MHz; Modulation: DBPSK; Data Rate: 1 Mbps

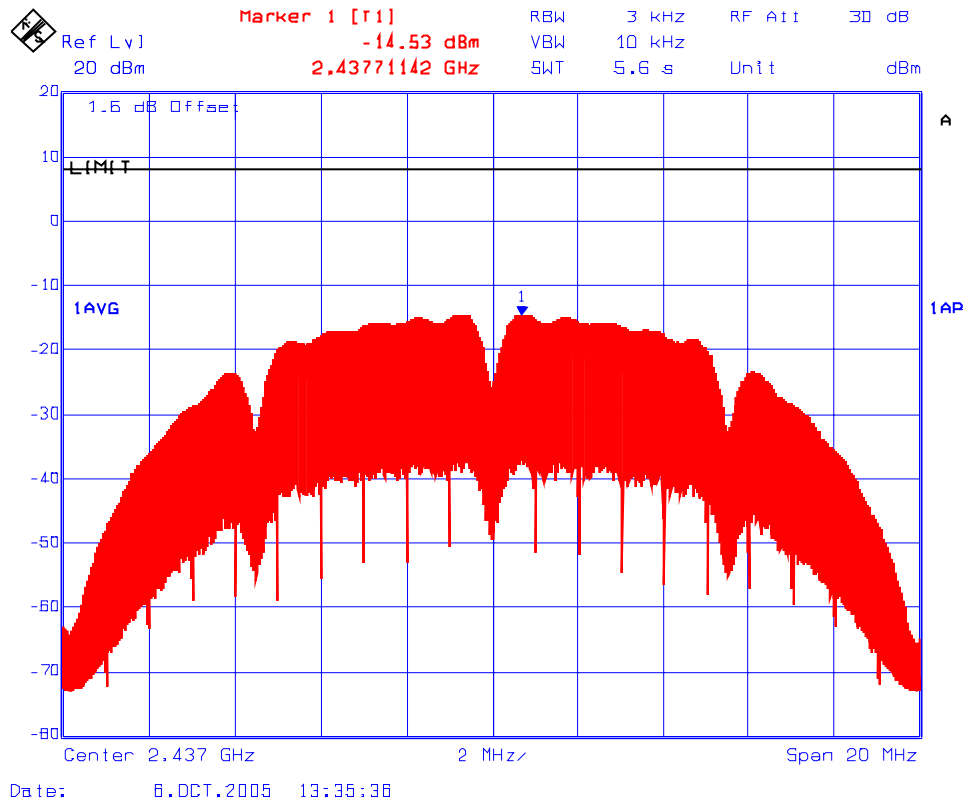

Plot 6.10.5.3
Power Spectral Density
Frequency: 2462 MHz; Modulation: DBPSK; Data Rate: 1 Mbps

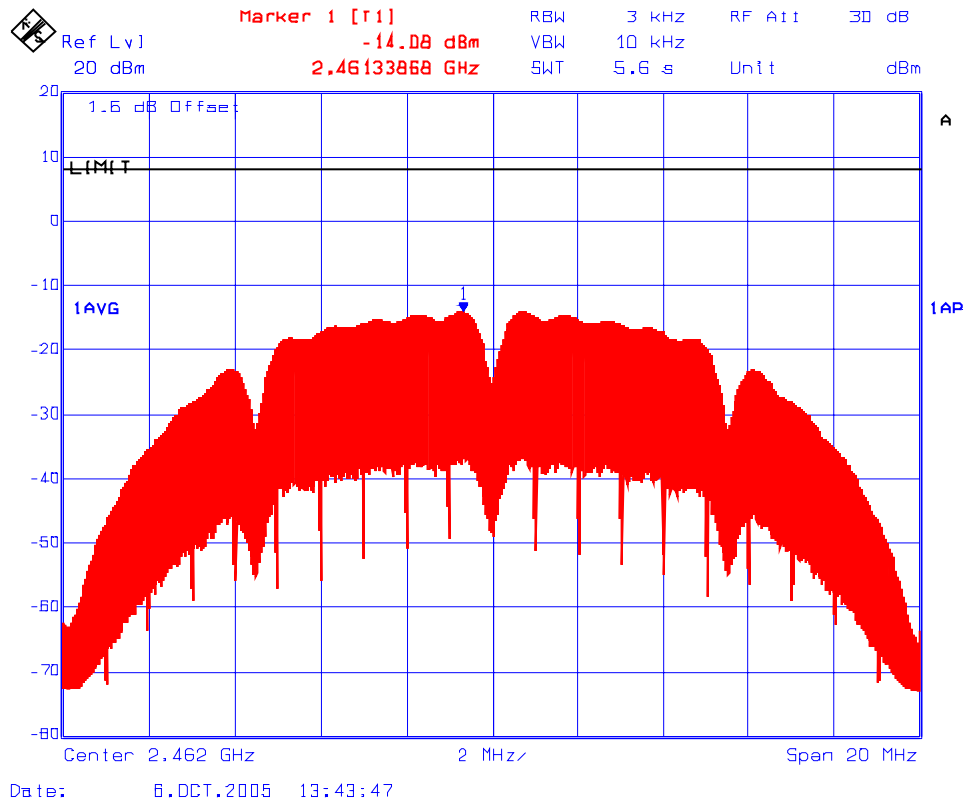

Plot 6.10.5.4
Power Spectral Density
Frequency: 2412 MHz; Modulation: DQPSK; Data Rate: 2 Mbps

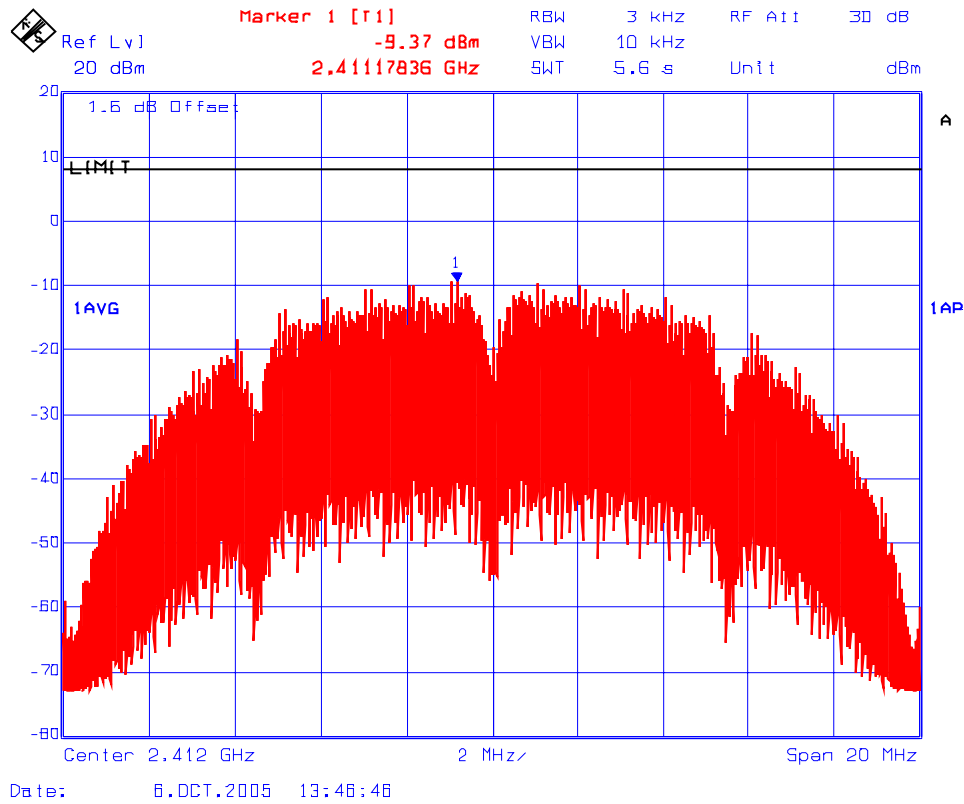

Plot 6.10.5.5
Power Spectral Density
Frequency: 2437 MHz; Modulation: DQPSK; Data Rate: 2 Mbps

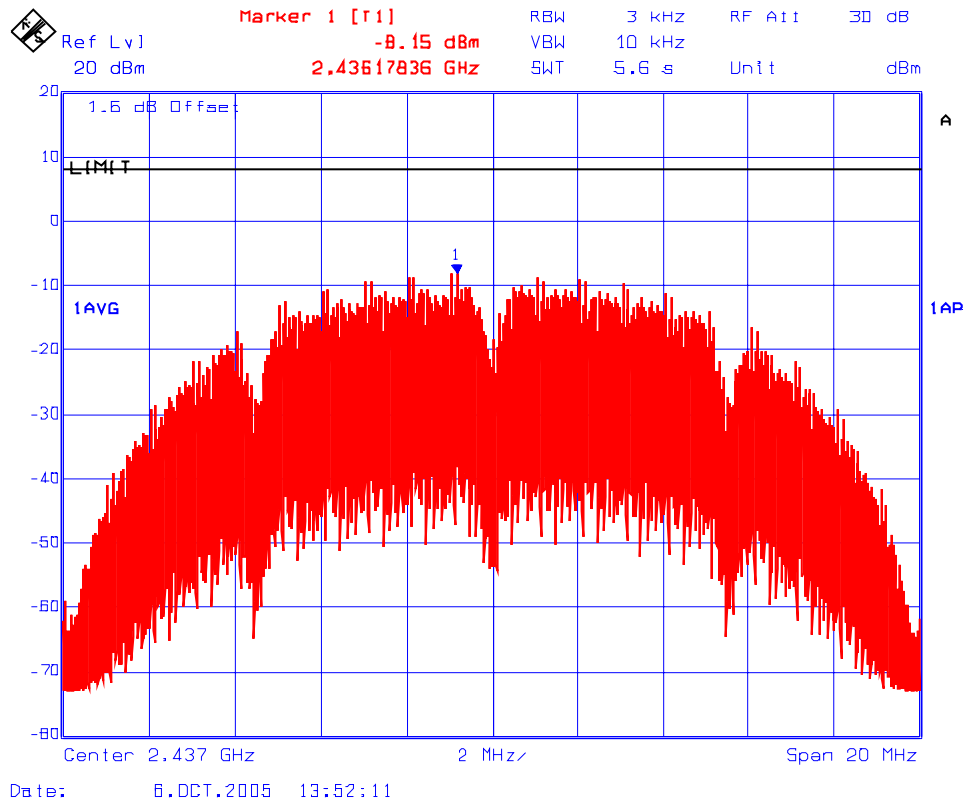

Plot 6.10.5.6
Power Spectral Density
Frequency: 2462 MHz; Modulation: DQPSK; Data Rate: 2 Mbps

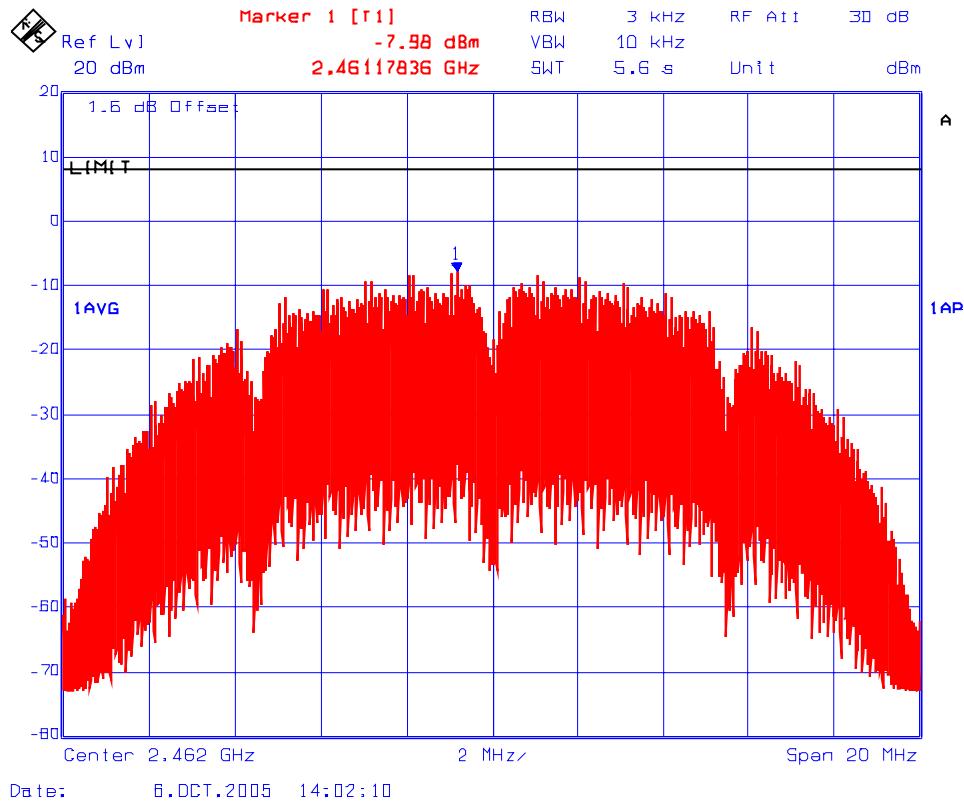

Plot 6.10.5.7
Power Spectral Density
Frequency: 2412 MHz; Modulation: CCK; Data Rate: 11 Mbps

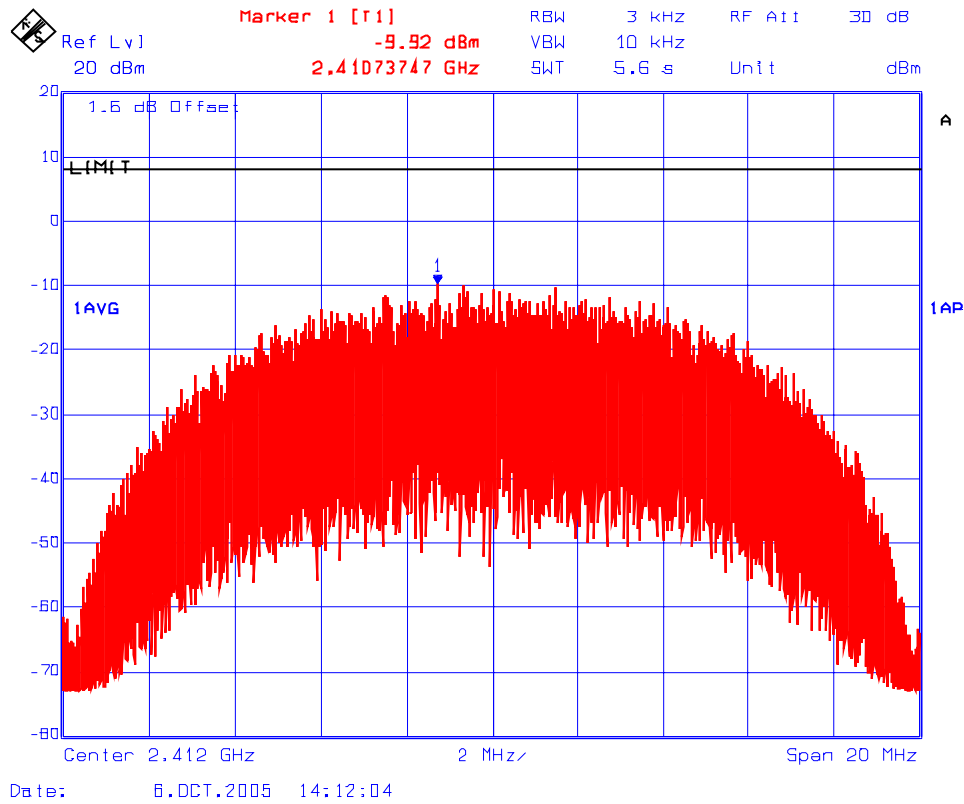

Plot 6.10.5.8
Power Spectral Density
Frequency: 2437 MHz; Modulation: CCK; Data Rate: 11 Mbps

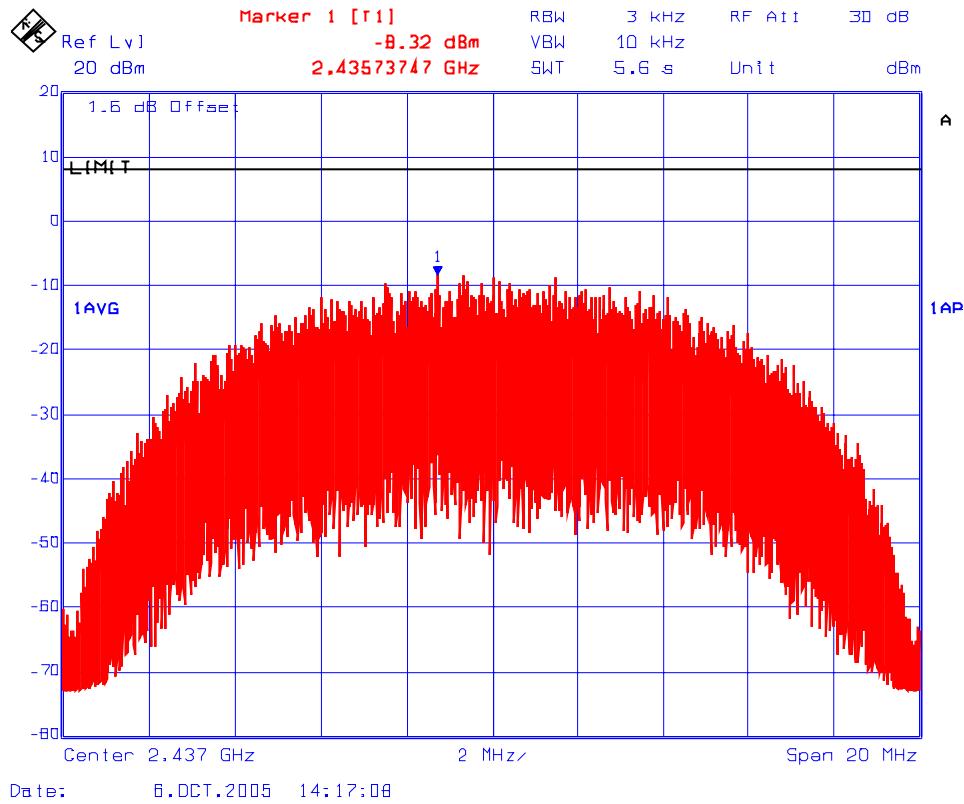

Plot 6.10.5.9
Power Spectral Density
Frequency: 2462 MHz; Modulation: CCK; Data Rate: 11 Mbps

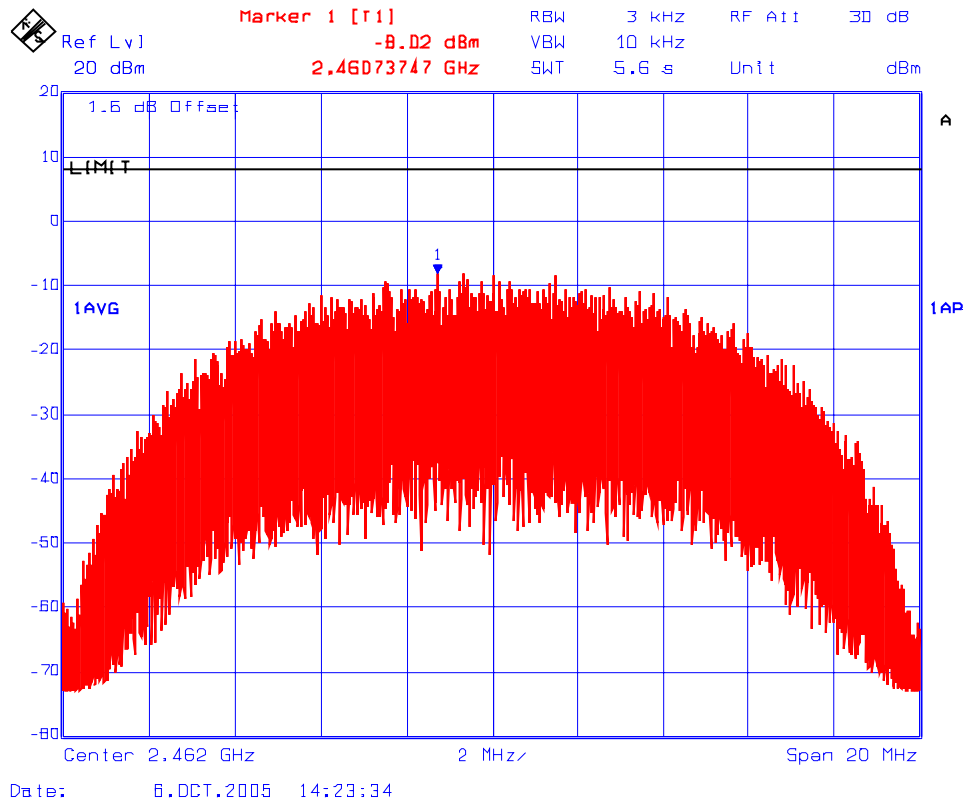

Plot 6.10.5.10
Power Spectral Density
Frequency: 2412 MHz; Modulation: DBPSK; Data Rate: 9 Mbps

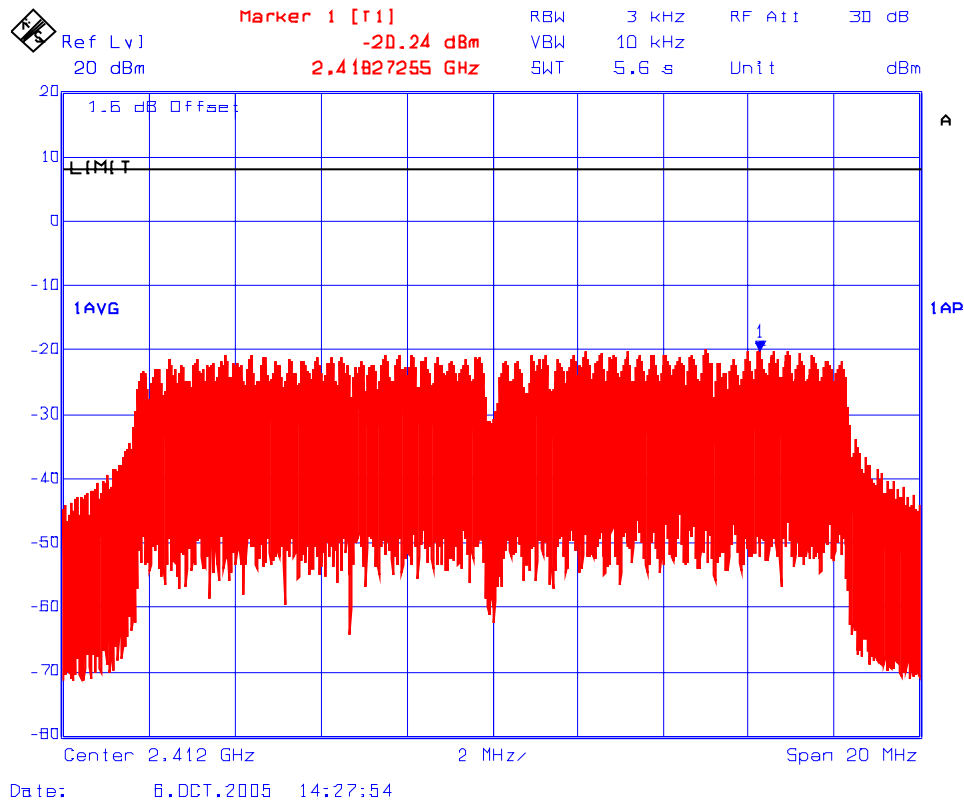

Plot 6.10.5.11
Power Spectral Density
Frequency: 2437 MHz; Modulation: DBPSK; Data Rate: 9 Mbps

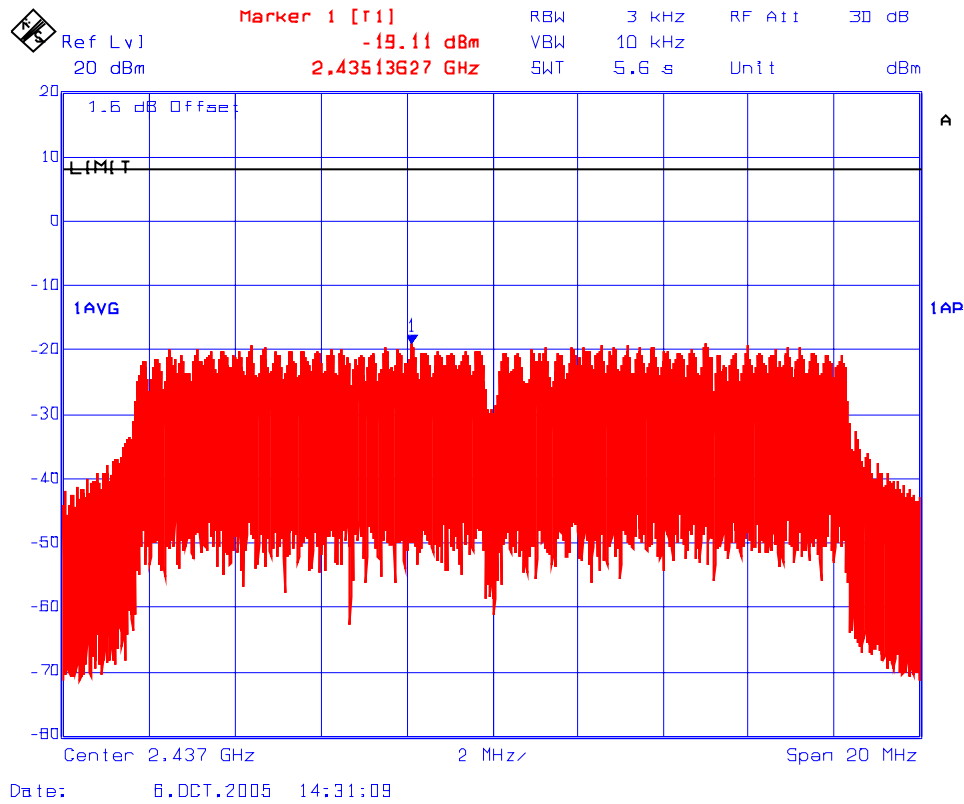

Plot 6.10.5.12
Power Spectral Density
Frequency: 2462 MHz; Modulation: DBPSK; Data Rate: 9 Mbps

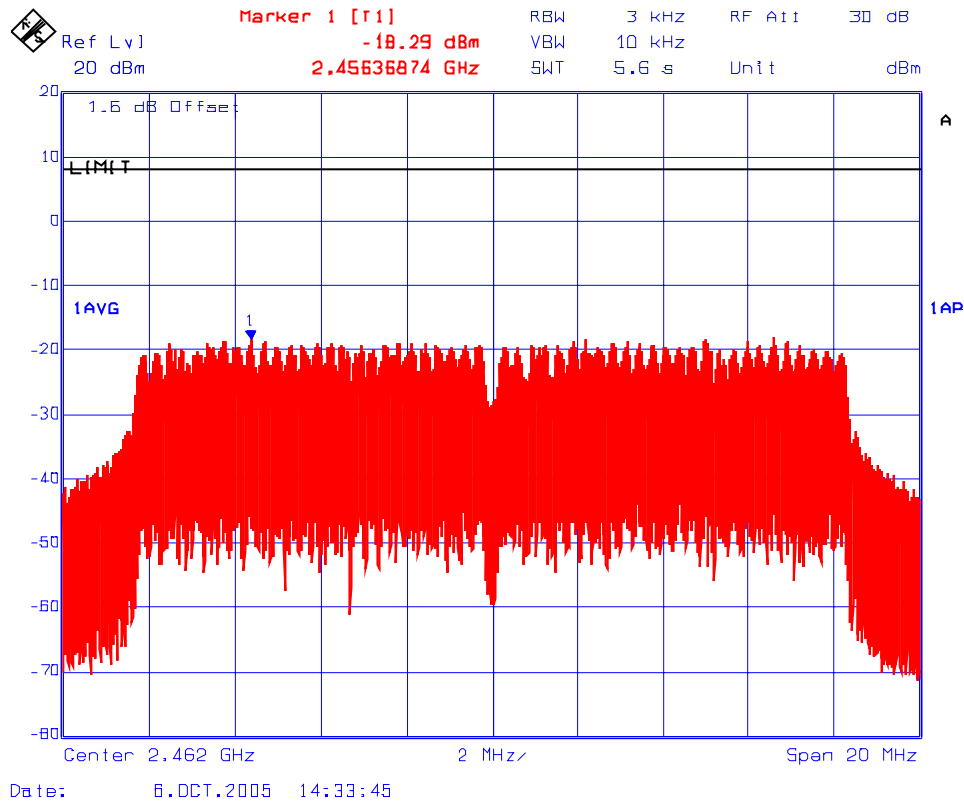

Plot 6.10.5.13
Power Spectral Density
Frequency: 2412 MHz; Modulation: DQPSK; Data Rate: 18 Mbps

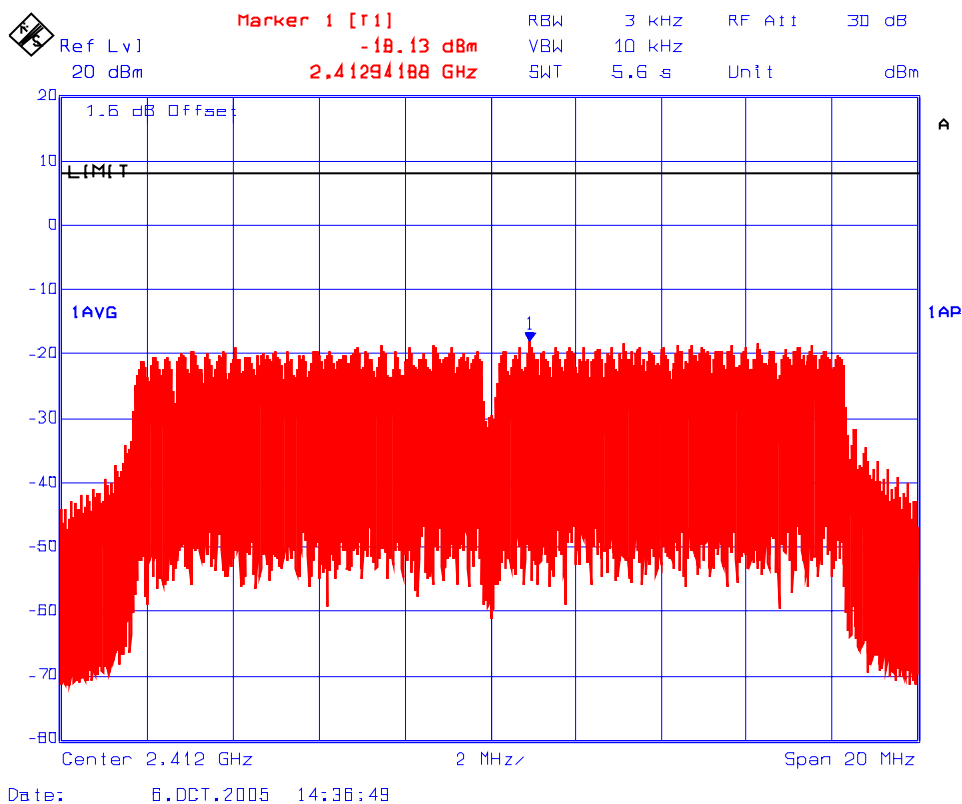

Plot 6.10.5.14
Power Spectral Density
Frequency: 2437 MHz; Modulation: DQPSK; Data Rate: 18 Mbps

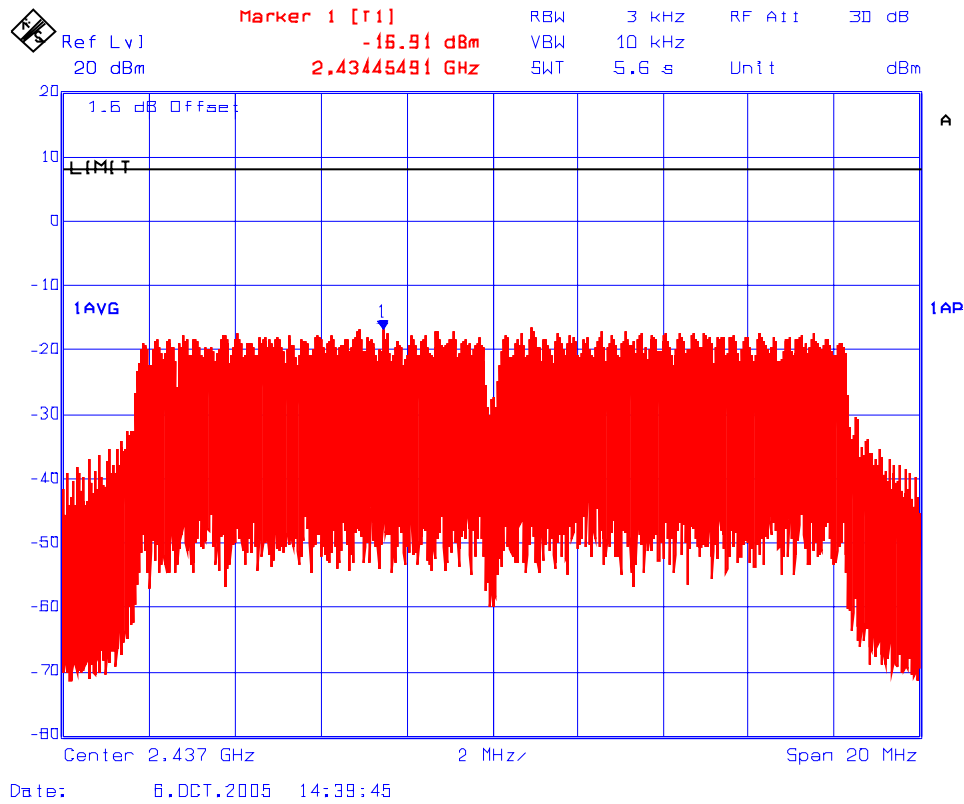

Plot 6.10.5.15
Power Spectral Density
Frequency: 2462 MHz; Modulation: DQPSK; Data Rate: 18 Mbps

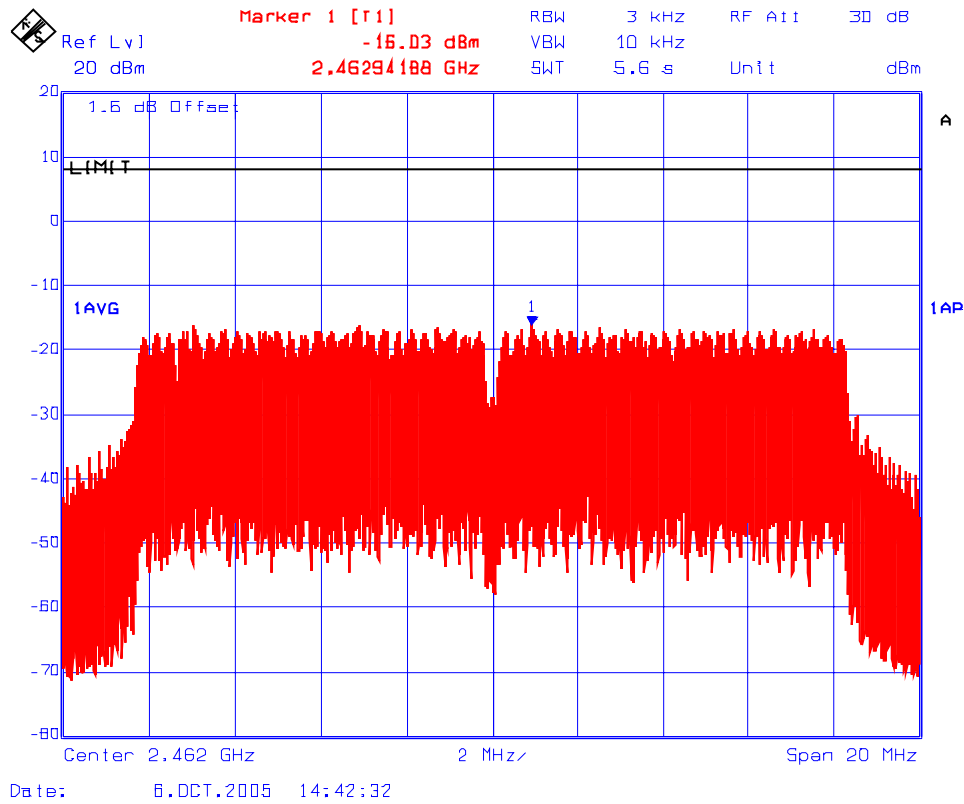

Plot 6.10.5.16
Power Spectral Density
Frequency: 2412 MHz; Modulation: 16QAM; Data Rate: 36 Mbps

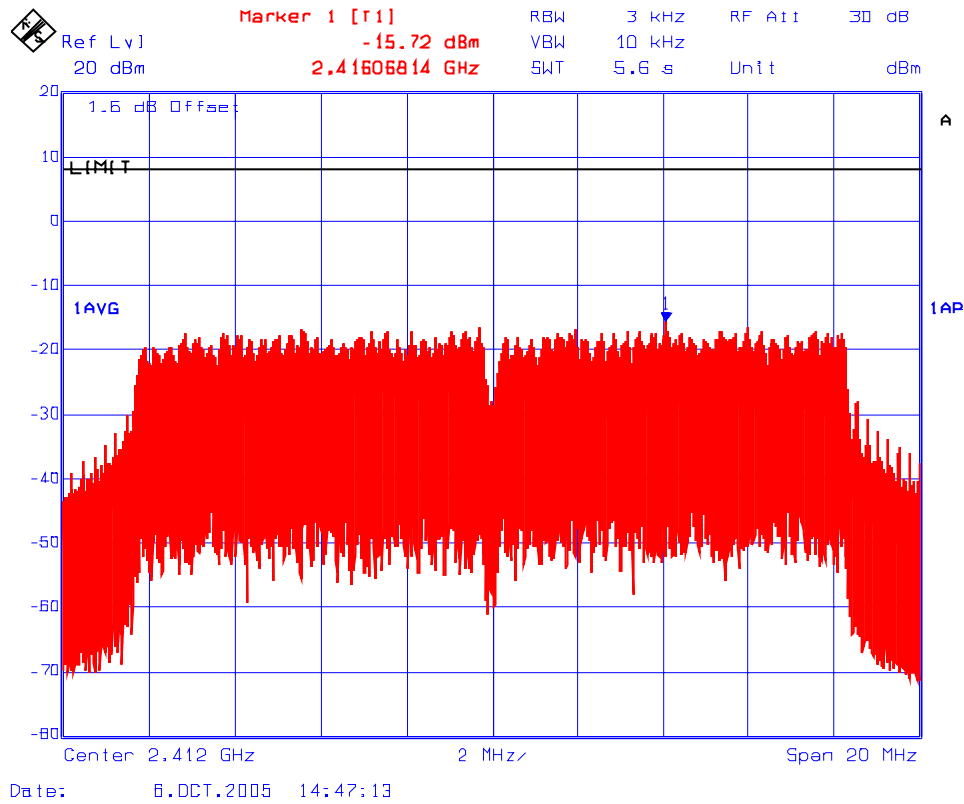

Plot 6.10.5.17
Power Spectral Density
Frequency: 2437 MHz; Modulation: 16QAM; Data Rate: 36 Mbps

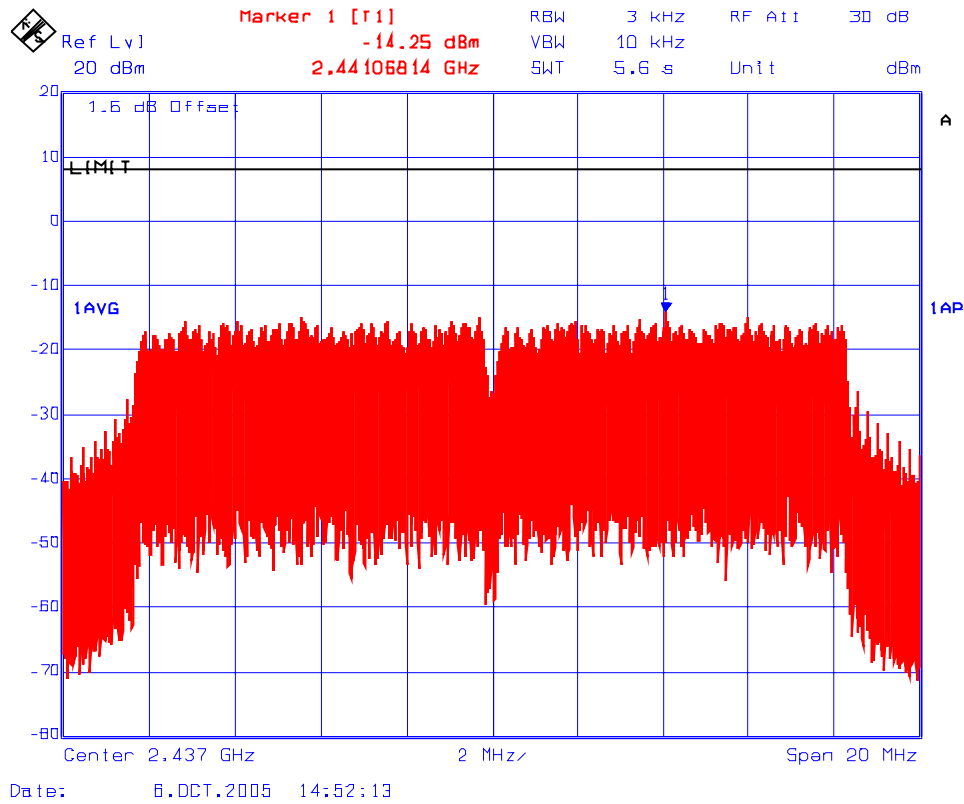

Plot 6.10.5.18
Power Spectral Density
Frequency: 2462 MHz; Modulation: 16QAM; Data Rate: 36 Mbps

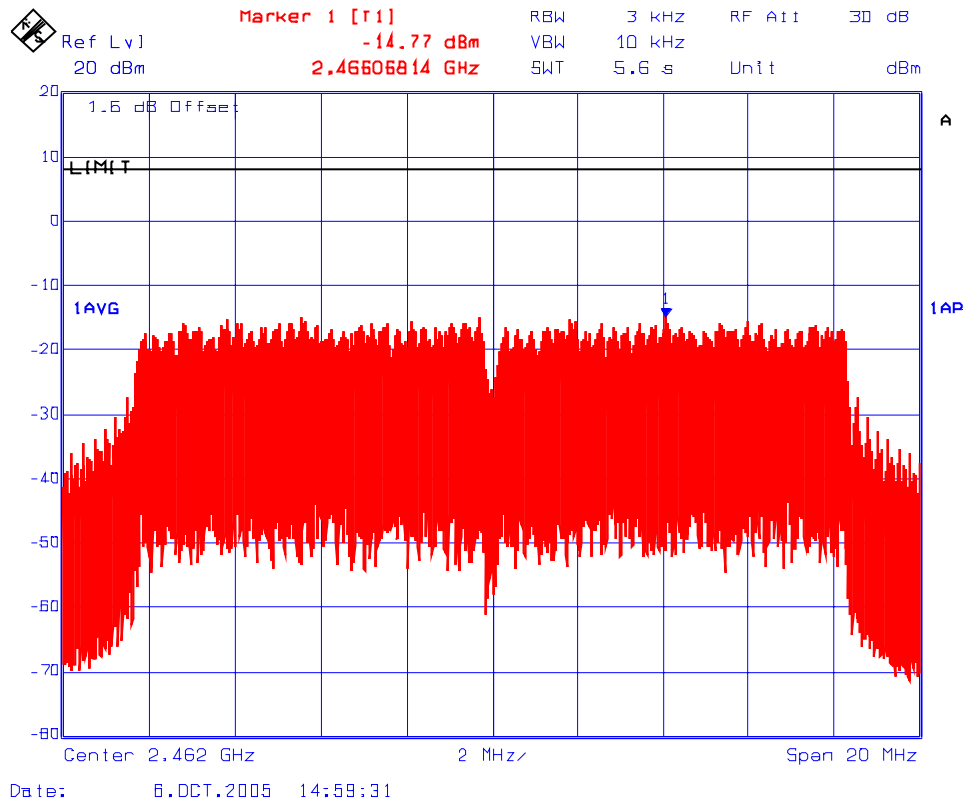

Plot 6.10.5.19
Power Spectral Density
Frequency: 2412 MHz; Modulation: 64QAM; Data Rate: 54 Mbps

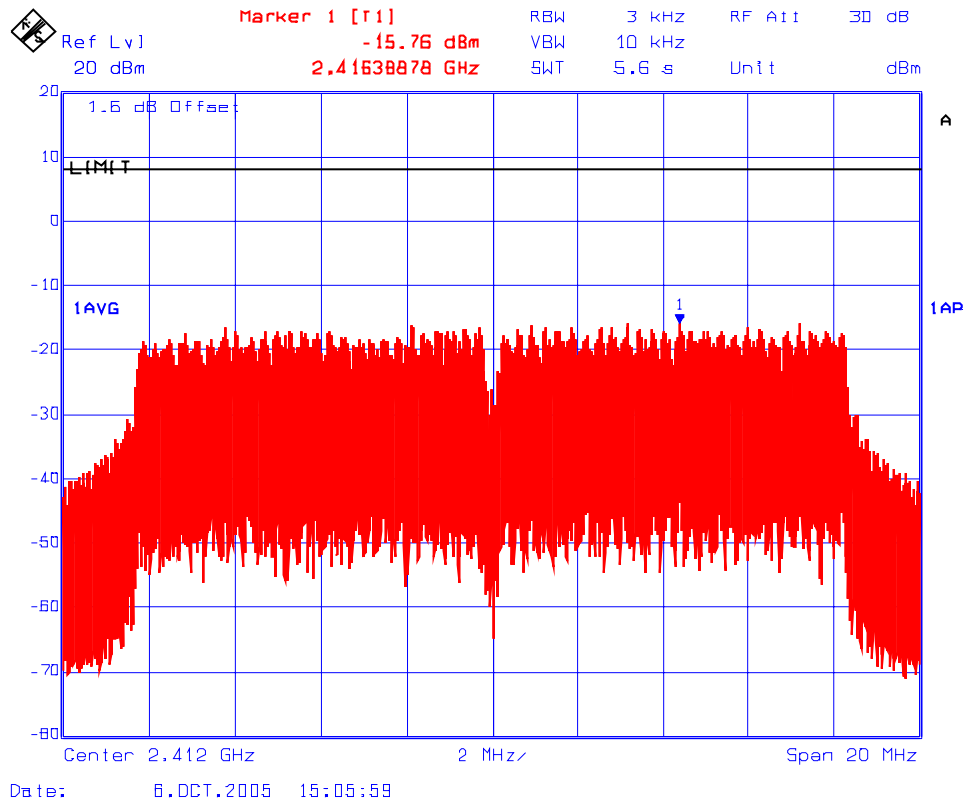

Plot 6.10.5.20
Power Spectral Density
Frequency: 2437 MHz; Modulation: 64QAM; Data Rate: 54 Mbps

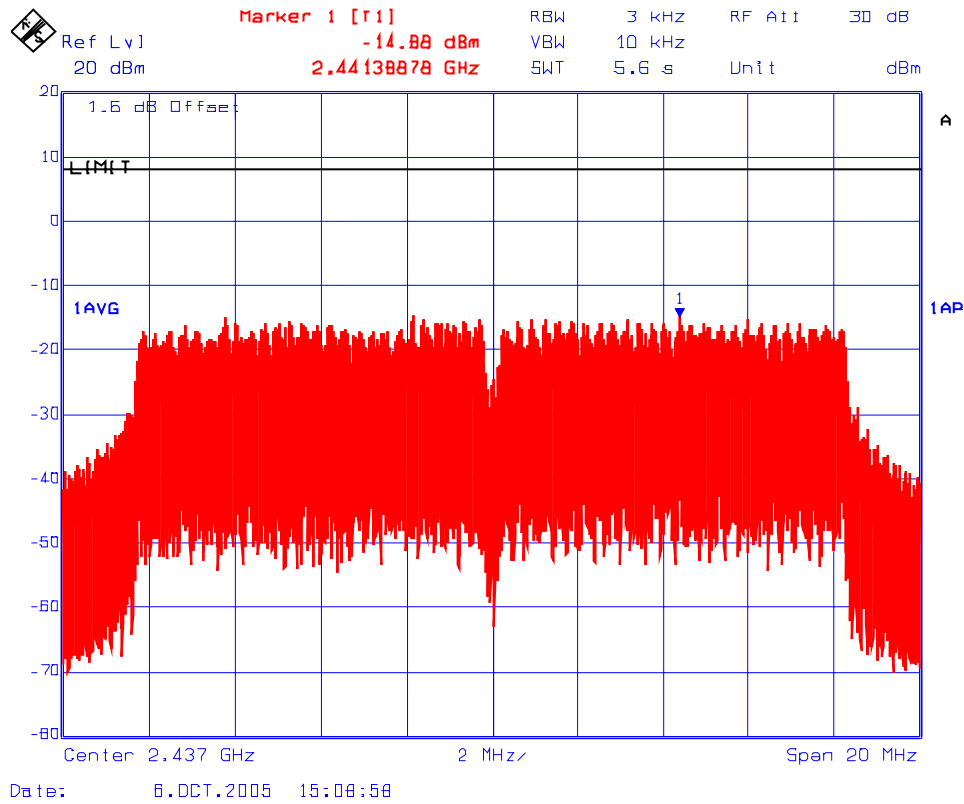

Plot 6.10.5.21
Power Spectral Density
Frequency: 2462 MHz; Modulation: 64QAM; Data Rate: 54 Mbps

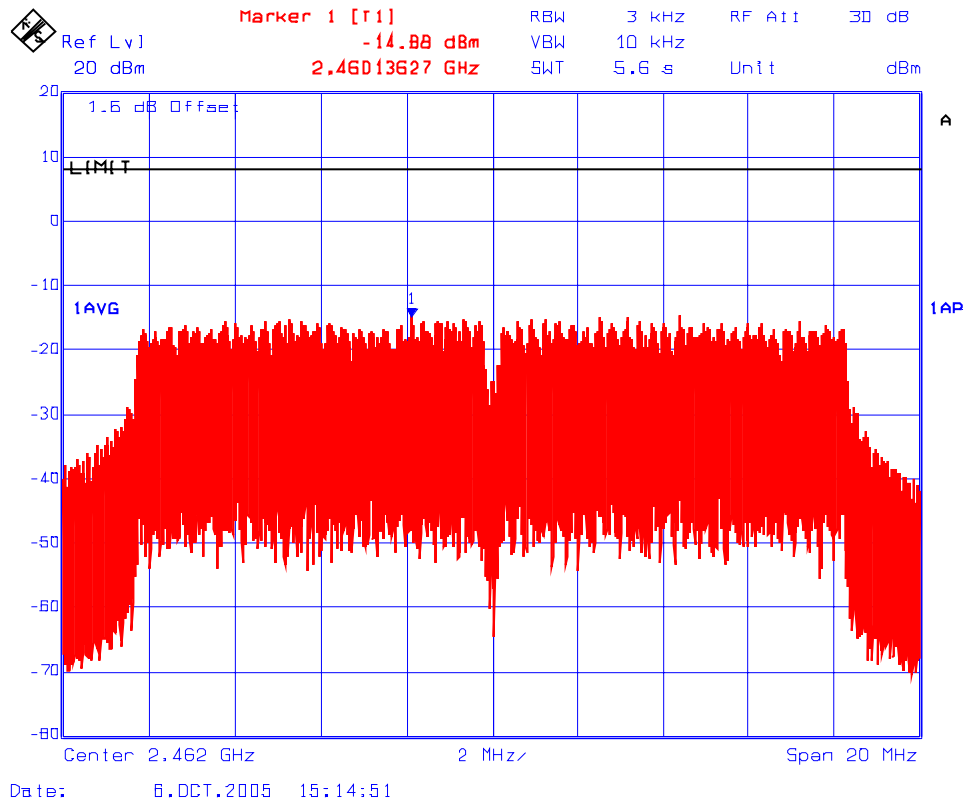

6.11. RF EXPOSURE REQUIRMENTS [§ 15.247(i), 1.1310 & 2.1091]

6.11.1. Limits

- **§ 15.247(i):** Systems operating under provisions of this section shall be operated in a manner that ensures that the public is not exposed to radio frequency energy levels in excess of the Commission’s guidelines. See @ 1.1307(b)(1).
- **§ 1.1310:-** The criteria listed in the following table shall be used to evaluate the environmental impact of human exposure to radio-frequency (RF) radiation as specified in 1.1307(b).

TABLE 1—LIMITS FOR MAXIMUM PERMISSIBLE EXPOSURE (MPE)

Frequency range (MHz)	Electric field strength (V/m)	Magnetic field strength (A/m)	Power density (mW/cm ²)	Averaging time (minutes)
(A) Limits for Occupational/Controlled Exposures				
0.3–3.0	614	1.63	*(100)	6
3.0–30	1842/f	4.89/f	*(900/f ²)	6
30–300	61.4	0.163	1.0	6
300–1500	f/300	6
1500–100,000	5	6
(B) Limits for General Population/Uncontrolled Exposure				
0.3–1.34	614	1.63	*(100)	30
1.34–30	824/f	2.19/f	*(180/f ²)	30
30–300	27.5	0.073	0.2	30
300–1500	f/1500	30
1500–100,000	1.0	30

f = frequency in MHz

* = Plane-wave equivalent power density

NOTE 1 TO TABLE 1: Occupational/controlled limits apply in situations in which persons are exposed as a consequence of their employment provided those persons are fully aware of the potential for exposure and can exercise control over their exposure. Limits for occupational/controlled exposure also apply in situations when an individual is transient through a location where occupational/controlled limits apply provided he or she is made aware of the potential for exposure.

NOTE 2 TO TABLE 1: General population/uncontrolled exposures apply in situations in which the general public may be exposed, or in which persons that are exposed as a consequence of their employment may not be fully aware of the potential for exposure or can not exercise control over their exposure.

6.11.2. Method of Measurements

See 47 CFR §§ 1.1310, 2.1091

In order to demonstrate compliance with MPE requirements (see Section 2.1091), the following information is typically needed:

- (1) Calculation that estimates the minimum separation distance (20 cm or more) between an antenna and persons required to satisfy power density limits defined for free space.
- (2) Antenna installation and device operating instructions for installers (professional/unskilled users), and the parties responsible for ensuring compliance with the RF exposure requirement
- (3) Any caution statements and/or warning labels that are necessary in order to comply with the exposure limits
- (4) Any other RF exposure related issues that may affect MPE compliance

Calculation Method of RF Safety Distance:

$$S = PG/4\pi r^2 = EIRP/4\pi r^2$$

Where: P: power input to the antenna in mW
 EIRP: Equivalent (effective) isotropic radiated power
 S: power density mW/cm²
 G: numeric gain of antenna relative to isotropic radiator
 r: distance to centre of radiation in cm

$$r = \sqrt{EIRP/4\pi S}$$

For portable transmitters (see Section 2.1093), or devices designed to operate next to a person's body, compliance is determined with respect to the SAR limit (define in the body tissues) for near-field exposure conditions. If the maximum average output power, operating condition configurations and exposure conditions are comparable to those of existing cellular and PCS phones, SAR evaluation may be required in order to determine if such a device complies with SAR limit. When SAR evaluation data is not available, and the additional supporting information cannot assure compliance, the Commission may request that an SAR evaluation be performed, as provided for in Section 1.1307(d)

6.11.3. Test Data

Evaluation of RF Exposure Compliance Requirements	
RF Exposure Requirements	Compliance with FCC Rules
Minimum calculated separation distance between antenna and persons required: *3.3 cm	Manufacturer' instruction for separation distance between antenna and persons required: 20 cm.
Antenna installation and device operating instructions for installers (professional/unskilled users), and the parties responsible for ensuring compliance with the RF exposure requirement	Antenna installation and device operating instructions shall be provided to installers to maintain and ensure compliance with RF exposure requirements.
Caution statements and/or warning labels that are necessary in order to comply with the exposure limits	See User's Manual for RF exposure information.
Any other RF exposure related issues that may affect MPE compliance	None.

*The minimum separation distance between the antenna and bodies of users are calculated using the following formula:

$$RF \text{ EXPOSURE DISTANCE LIMITS: } r = (PG/4\pi S)^{1/2} = (EIRP/4\pi S)^{1/2}$$

$$S = 1 \text{ mW/cm}^2$$

$$EIRP = 21.44 \text{ dBm} = 10^{21.44/10} \text{ mW max. (Worst Case)}$$

$$r = (EIRP/4\pi S)^{1/2} = (10^{21.44/10}/4\pi(1))^{1/2} = 3.3 \text{ cm}$$

EXHIBIT 7. MEASUREMENT UNCERTAINTY

The measurement uncertainties stated were calculated in accordance with the requirements of NIST Technical Note 1297 and NIS 81 (1994)

7.1. LINE CONDUCTED EMISSION MEASUREMENT UNCERTAINTY

CONTRIBUTION (Line Conducted)	PROBABILITY DISTRIBUTION	UNCERTAINTY (dB)	
		9-150 kHz	0.15-30 MHz
EMI Receiver specification	Rectangular	± 1.5	± 1.5
LISN coupling specification	Rectangular	± 1.5	± 1.5
Cable and Input Transient Limiter calibration	Normal (k=2)	± 0.3	± 0.5
Mismatch: Receiver VRC $\Gamma_1 = 0.03$ LISN VRC $\Gamma_R = 0.8(9 \text{ kHz}) 0.2 (30 \text{ MHz})$ Uncertainty limits $20\text{Log}(1+\Gamma_1\Gamma_R)$	U-Shaped	± 0.2	± 0.3
System repeatability	Std. deviation	± 0.2	± 0.05
Repeatability of EUT	--	--	--
Combined standard uncertainty	Normal	± 1.25	± 1.30
Expanded uncertainty U	Normal (k=2)	± 2.50	± 2.60

Sample Calculation for Measurement Accuracy in 450 kHz to 30 MHz Band:

$$u_c(y) = \sqrt{\sum_{i=1}^m u_i^2(y)} = \pm \sqrt{(1.5^2 + 1.5^2)/3 + (0.5/2)^2 + (0.05/2)^2 + 0.35^2} = \pm 1.30 \text{ dB}$$

$$U = 2u_c(y) = \pm 2.6 \text{ dB}$$

7.2. RADIATED EMISSION MEASUREMENT UNCERTAINTY

CONTRIBUTION (Radiated Emissions)	PROBABILITY DISTRIBUTION	UNCERTAINTY (+ dB)	
		3 m	10 m
Antenna Factor Calibration	Normal (k=2)	+1.0	+1.0
Cable Loss Calibration	Normal (k=2)	+0.3	+0.5
EMI Receiver specification	Rectangular	+1.5	+1.5
Antenna Directivity	Rectangular	+0.5	+0.5
Antenna factor variation with height	Rectangular	+2.0	+0.5
Antenna phase center variation	Rectangular	0.0	+0.2
Antenna factor frequency interpolation	Rectangular	+0.25	+0.25
Measurement distance variation	Rectangular	+0.6	+0.4
Site imperfections	Rectangular	+2.0	+2.0
Mismatch: Receiver VRC $\Gamma_1 = 0.2$ Antenna VRC $\Gamma_R = 0.67(Bi) 0.3 (Lp)$ Uncertainty limits $20\text{Log}(1+\Gamma_1\Gamma_R)$	U-Shaped	+1.1 -1.25	+0.5
System repeatability	Std. Deviation	+0.5	+0.5
Repeatability of EUT		-	-
Combined standard uncertainty	Normal	+2.19 / -2.21	+1.74 / -1.72
Expanded uncertainty U	Normal (k=2)	+4.38 / -4.42	+3.48 / -3.44

Calculation for maximum uncertainty when 3m biconical antenna including a factor of k = 2 is used:

$$U = 2u_c(y) = 2x(+2.19) = +4.38 \text{ dB} \quad \text{And} \quad U = 2u_c(y) = 2x(-2.21) = -4.42 \text{ dB}$$

EXHIBIT 8. MEASUREMENT METHODS

8.1. GENERAL TEST CONDITIONS

The following test conditions shall be applied throughout the tests covered in this report.

8.1.1. Normal temperature and humidity

- Normal temperature: +15°C to +35°C
- Relative Humidity: +20% to 75%

The actual values during tests shall be recorded in the test report.

8.1.2. Normal power source

8.1.2.1. Mains Voltage

The nominal test voltage of the equipment to be connected to mains shall be the nominal mains voltage which is the declared voltage or any of the declared voltages for which the equipment was designed.

The frequency of test power source corresponding to the AC mains shall be between 59 Hz and 61 Hz.

8.1.2.2. Battery Power Source.

For operation from battery power sources, the nominal test voltage shall be as declared by the equipment manufacturer. This shall be recorded in the test report.

8.1.3. Operating Condition of Equipment under Test

- All tests were carried out while the equipment operated at the following frequencies:
 - The lowest operating frequency,
 - The middle operating frequency and
 - The highest operating frequency
- Modulation were applied using the Test Data sequence
- The transmitter was operated at the highest output power, or in the case the equipment able to operate at more than one power level, at the lowest and highest output powers

8.2. METHOD OF MEASUREMENTS - AC MAINS CONDUCTED EMISSIONS

- AC Mains conducted emissions measurements were performed in accordance with the standard against appropriate limits for each detector function.
- The test was performed in the shielded room, 24'(L) by 16'(W) by 8'(H).
- The test was performed were made over the frequency range from 150 kHz to 30 MHz to determine the line-to-ground radio noise voltage which was conducted from the EUT power-input terminals that were directly connected to a public power network.
- The EUT normally received power from another device that connects to the public utility ac power lines, measurements would be made on that device with the EUT in operation to ensure that the device continues to comply with the appropriate limits while providing the EUT with power.
- If the EUT operates only from internal or dedicated batteries, with no provisions for connection to the public utility ac power lines, AC Mains conducted measurements are not required.
- Table-top devices were placed on a platform of nominal size 1 m by 1.5m raised 80 cm above the conducting ground plane.
- The EUT current-carrying power lead, except the ground (safety) lead, was individually connected through a LISN to the power source. All unused 50-Ohm connectors of the LISN was terminated in 50-ohm when not connected to the measuring instruments.
- The line cord of the EUT connected to one LISN which was connected to the measuring instrument. Those power cords for the units of devices not under measurement were connected to a separate multiple ac outlet. Drawings and photographs of typically conducted emission test setups were shown in the Test Report. Each current-carrying conductor of the EUT shall be individually tested.
- The EUT was normally operated with a ground (safety) connection, the EUT was connected to the ground at the LISN through a conductor provided in the lead from the ac power mains to the LISN.
- The excess length of the power cord was folded back and forth in an 8-shape on a wooden strip with a vertical prong located on the top of the LISN case.
- The EUT was set-up in its typical configuration and operated in its various modes as described in this test report.
- A preliminary scan was made by using spectrum analyzer system with the detector function set to PEAK mode (9 KHz RBW, VBW > RBW), frequency span 150 kHz to 30 MHz.
- The maximum conducted emission for a given mode of operation was found by using the following step-by-step procedure:
 - Step 1. Monitor the frequency range of interest at a fixed EUT azimuth.
 - Step 2. Manipulate the system cables and peripheral devices to produce highest amplitude signal relative to the limit. Note the amplitude and frequency of the suspect signal.
 - Step 3. The effects of various modes of operation is examined. This is done by varying equipment operation modes as step 2 is being performed.
 - Step 4. After completing step 1 through 3, record EUT and peripheral device configuration, mode of operation, cable configuration, signal levels and frequencies for final test.
- Each highest signal level at the maximized test configuration was zoomed in a small frequency span on the spectrum analyzer's display (the manipulation of cables and peripheral devices and EUT operation modes might have to be repeated to obtain the highest signal level with the spectrum analyzer set to PEAK detector mode 10 KHz RBW and VBW > RBW). The spectrum analyzer was then set to CISPR QUASI-PEAK detector mode (9 KHz RBW, 1 MHz VBW) and AVERAGE detector mode (10 kHz RBW, 1 Hz VBW). The final highest RF signal levels and frequencies were record.

8.3. SPURIOUS EMISSIONS (CONDUCTED & RADIATED)

For both conducted and radiated measurements, the spurious emissions were scanned from the lowest frequency generated by the EUT or 10 MHz whichever is lower to 10th harmonic of the highest frequency generated by the EUT.

8.3.1. Band-edge and Spurious Emissions (Conducted)

Band-edge Compliance of RF Conducted Emissions:

Use the following spectrum analyzer settings:

- The radio was connected to the measuring equipment via a suitable attenuator.
- Span = wide enough to capture the peak level of the emission operating on the channel closest to the band-edge, as well as any modulation products which fall outside of the authorized band of operation.
- RBW = 1 % of the span
- VBW = RBW
- Sweep = auto
- Detector function = peak
- Trace = max hold
- Allow the trace to stabilize
- Set the marker on the emission at the band-edge, or on the highest modulation product outside of the band, if this level is greater than that at the band-edge
- Enable the marker-delta function, then use the marker-to-peak function to move the marker to the peak of the in-band emission.
- The marker-delta value now displayed must comply with the limit specified
- Submit this plot

Spurious RF Conducted Emissions:

Use the following spectrum analyzer settings:

- The radio was connected to the measuring equipment via a suitable attenuator.
- Span = wide enough to capture the peak level of the in-band-emission and all spurious emissions (e.g. harmonics) from the lowest frequency generated in the EUT up through the 10th harmonic. Typically, several plots are required to cover this entire span.
- RBW = 100 kHz
- VBW = RBW
- Sweep = auto
- Detector function = peak
- Trace = max hold
- Allow the trace to stabilize
- Set the marker on the any spurious emission recorded. The level displayed must comply with the limit specified in this Section.
- Submit this plot

8.3.2. Spurious Emissions (Radiated)

- The radiated emission measurements were performed at the UltraTech’s 3 Meter Open Field Test Site (OFTS) situated in the Town of Oakville, province of Ontario. The Attenuation Characteristics of OFTS have been filed to FCC, Industry Canada, ACA/Austel, NVLap and ITI.
- Radiated emissions measurements were made using the following test instruments:
 1. Calibrated EMCO BiconiLog antenna in the frequency range from 30 MHz to 2000 MHz.
 2. Calibrated Emco Horn antennas in the frequency range above 1000 MHz (1GHz - 40 GHz).
 3. The test is required for any spurious emission or modulation product that falls in a Restricted Band, as defined in Section 15.205. It must be performed with the highest gain of each type of antenna proposed for use with the EUT. Use the following spectrum analyzer settings:
 - RBW = 100 kHz for $f < 1\text{GHz}$ and $\text{RBW} = 1\text{ MHz}$ for $f \geq 1\text{ GHz}$
 - VBW = RBW
 - Sweep = auto
 - Detector function = peak
 - Trace = max hold
 - Follows the guidelines in ANSI C63.4 with respect to maximizing the emission by rotating the EUT, measuring the emission while the EUT is situated in three orthogonal planes (if appropriate), adjusting the measurement antenna height and polarization, etc.. A pre-amp and highpass filter are required for this test, in order to provide the measuring system with sufficient sensitivity.
 - Allow the trace to stabilize.
 - The peak reading of the emission, after being corrected by the antenna correction factor, cable loss, pre-amp gain, etc.... is the peak field strength which comply with the limit specified in Section 15.35(b)

Calculation of Field Strength:

The field strength is calculated by adding the calibrated antenna factor and cable factor, and subtracting the Amplifier gain (if any) from the measured reading. The basic equation with a sample calculation is as follows:

$FS = RA + AF + CF - AG$

- Where
- FS = Field Strength
 - RA = Receiver/Analyzer Reading
 - AF = Antenna Factor
 - CF = Cable Attenuation Factor
 - AG = Amplifier Gain

Example: If a receiver reading of 60.0 dBuV is obtained, the antenna factor of 7.0 dB/m and cable factor of 1.0 dB are added, and the amplifier gain of 30 dB is subtracted. The actual field strength will be:

Field Level = $60 + 7.0 + 1.0 - 30 = 38.0\text{ dBuV/m.}$
 Field Level = $10^{(38/20)} = 79.43\text{ uV/m.}$

- Submit this test data
- Now set the VBW to 10Hz, while maintaining all of the other instrument settings. This peak level, once corrected, must comply with the limit specified in Section 15.209. If the dwell time of the

each channel is less than 100ms, then the reading obtained may be further adjusted by a "duty cycle correction factor", derived from $10\log(\text{dwell time}/100\text{mS})$ in an effort to demonstrate compliance with the 15.209.

- Submit test data

Maximizing The Radiated Emissions:

- The frequencies of emissions was first detected. Then the amplitude of the emissions was measured at the specified measurement distance using required antenna height, polarization, and detector characteristics.
- During this process, cables and peripheral devices were manipulated within the range of likely configuration.
- For each mode of operation required to be tested, the frequency spectrum was monitored. Variations in antenna heights (from 1 meter to 4 meters above the ground plane), antenna polarization (horizontal plane and vertical plane), cable placement and peripheral placement were explored to produce the highest amplitude signal relative to the limit.

The maximum radiated emission for a given mode of operation was found by using the following step-by-step procedure:

- Step 1: Monitor the frequency range of interest at a fixed antenna height and EUT azimuth.
- Step 2: Manipulate the system cables to produce highest amplitude signal relative to the limit. Note the amplitude and frequency of the suspect signal.
- Step 3: Rotate the EUT 360 degrees to maximize the suspected highest amplitude signal. If the signal or another at a different frequency is observed to exceed the previously noted highest amplitude signal by 1 dB or more, go back to the azimuth and repeat Step 2. Otherwise, orient the EUT azimuth to repeat the highest amplitude observation and proceed.
- Step 4: Move the antenna over its full allowable range of travel (1 to 4 meters) to maximize the suspected highest amplitude signal. If the signal or another at a different frequency is observed to exceed the previously noted highest amplitude signal by 1 dB or more, return to Step 2 with the highest amplitude observation and proceed.
- Step 5: Change the polarization of the antenna and repeat Step 2 through 4. Compare the resulting suspected highest amplitude signal with that found for the other polarization. Select and note the higher of the two signals. This signal is termed the highest observed signal with respect to the limit for this EUT operational mode.
- Step 6: The effects of various modes of operation is examined. This is done by varying the equipment modes as steps 2 through 5 are being performed.
- Step 7: After completing steps 1 through 6, record the final highest emission level, frequency, antenna polarization and detector mode of the measuring instrument.