

# ENGINEERING TEST REPORT

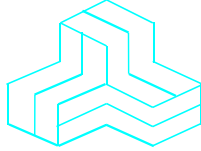

**Handheld Computer  
Model: 7545MBW  
FCC ID: GM37545MBW**

*Applicant:*

**Psion Inc  
2100 Meadowvale Boulevard  
Mississauga, ON L5N 7J9  
Canada**

*In Accordance With*

**Federal Communications Commission (FCC)  
Part 15, Subpart C, Section 15.247  
Digital Modulation Systems (DTS) Operating within 2400 – 2483.5 MHz Band**

**UltraTech's File No.: TEK-728F15C247-7545MBW**

This Test report is Issued under the Authority of  
Tri M. Luu  
Vice President of Engineering  
UltraTech Group of Labs

Date: October 21, 2013

Report Prepared by: Dan Huynh

Tested by: Mr. Hung Trinh

Issued Date: October 21, 2013

Test Dates: September 27 - October 1, 2013

- *The results in this Test Report apply only to the sample(s) tested, and the sample tested is randomly selected.*
- *This report must not be used by the client to claim product endorsement by NVLAP or any agency of the US Government.*

## UltraTech

3000 Bristol Circle, Oakville, Ontario, Canada, L6H 6G4  
Tel.: (905) 829-1570 Fax.: (905) 829-8050  
Website: [www.ultratech-labs.com](http://www.ultratech-labs.com), Email: [vic@ultratech-labs.com](mailto:vic@ultratech-labs.com), Email: [tri@ultratech-labs.com](mailto:tri@ultratech-labs.com)

FCC

91038



1309



46390-2049



NVLAP LAB CODE 200093-0



SL2-IN-E-1119R



Korea KCC-RRL  
CA2049

**TABLE OF CONTENTS**

**EXHIBIT 1. INTRODUCTION..... 1**

1.1. SCOPE ..... 1

1.2. RELATED SUBMITTAL(S)/GRANT(S) ..... 1

1.3. NORMATIVE REFERENCES ..... 1

**EXHIBIT 2. PERFORMANCE ASSESSMENT..... 2**

2.1. CLIENT INFORMATION ..... 2

2.2. EQUIPMENT UNDER TEST (EUT) INFORMATION ..... 2

2.3. EUT’S TECHNICAL SPECIFICATIONS..... 3

2.4. ASSOCIATED ANTENNA DESCRIPTION ..... 3

2.5. LIST OF EUT’S PORTS..... 3

2.6. ANCILLARY EQUIPMENT ..... 3

**EXHIBIT 3. EUT OPERATING CONDITIONS AND CONFIGURATIONS DURING TESTS..... 4**

3.1. CLIMATE TEST CONDITIONS ..... 4

3.2. OPERATIONAL TEST CONDITIONS & ARRANGEMENT FOR TESTS..... 4

**EXHIBIT 4. SUMMARY OF TEST RESULTS ..... 5**

4.1. LOCATION OF TESTS ..... 5

4.2. APPLICABILITY & SUMMARY OF EMC EMISSION TEST RESULTS ..... 5

4.3. MODIFICATIONS INCORPORATED IN THE EUT FOR COMPLIANCE PURPOSES..... 5

**EXHIBIT 5. TEST DATA ..... 6**

5.1. OCCUPIED BANDWIDTH [§ 15.215(c)] ..... 6

5.2. PEAK CONDUCTED OUTPUT POWER - DTS [§ 15.247(b)(3)] ..... 10

5.3. TRANSMITTER BAND-EDGE & SPURIOUS CONDUCTED EMISSIONS [§ 15.247(d)] ..... 14

5.4. TRANSMITTER SPURIOUS RADIATED EMISSIONS AT 3 METERS [§§ 15.247(d), 15.209 & 15.205] ..... 36

**EXHIBIT 6. TEST EQUIPMENT LIST ..... 38**

**EXHIBIT 7. MEASUREMENT UNCERTAINTY ..... 39**

7.1. LINE CONDUCTED EMISSION MEASUREMENT UNCERTAINTY ..... 39

7.2. RADIATED EMISSION MEASUREMENT UNCERTAINTY ..... 39

## EXHIBIT 1. INTRODUCTION

### 1.1. SCOPE

<b>Reference:</b>	FCC Part 15, Subpart C, Section 15.247
<b>Title:</b>	Code of Federal Regulations (CFR), Title 47 – Telecommunication, Part 15 – Radio Frequency Devices
<b>Purpose of Test:</b>	Class II Permissive Change for software change to add additional frequencies.
<b>Test Procedures:</b>	<ul style="list-style-type: none"> <li>▪ ANSI C63.4-2009</li> <li>▪ ANSI C63.10</li> <li>▪ FCC KDB Publication No. 558074 D01</li> </ul>
<b>Environmental Classification:</b>	<input checked="" type="checkbox"/> Commercial, industrial or business environment <input type="checkbox"/> Residential environment

### 1.2. RELATED SUBMITTAL(S)/GRANT(S)

None.

### 1.3. NORMATIVE REFERENCES

Publication	Year	Title
47 CFR Parts 0-19	2013	Code of Federal Regulations (CFR), Title 47 – Telecommunication
ANSI C63.4	2009	American National Standard for Methods of Measurement of Radio-Noise Emissions from Low-Voltage Electrical and Electronic Equipment in the Range of 9 KHz to 40 GHz
ANSI C63.10	2009	American National Standard for Testing Unlicensed Wireless Devices
CISPR 22 & EN 55022	2008-09, Edition 6.0 2006	Information Technology Equipment - Radio Disturbance Characteristics - Limits and Methods of Measurement
CISPR 16-1-1 +A1 +A2	2006 2006 2007	Specification for radio disturbance and immunity measuring apparatus and methods. Part 1-1: Measuring Apparatus
CISPR 16-1-2 +A1 +A2	2003 2004 2006	Specification for radio disturbance and immunity measuring apparatus and methods. Part 1-2: Conducted disturbances
D01 DTS Meas Guidance v03r01	2013	Guidance for Performing Compliance Measurements on Digital Transmission Systems (DTS) Operating Under §15.247

## EXHIBIT 2. PERFORMANCE ASSESSMENT

### 2.1. CLIENT INFORMATION

APPLICANT	
<b>Name:</b>	Psion Inc
<b>Address:</b>	2100 Meadowvale Boulevard Mississauga, ON L5N 7J9 Canada
<b>Contact Person:</b>	Mr. Sada Dharwarkar Phone #: 905 812 6200 Ext. 3358 Fax #: 905 812 6301 Email Sada.Dharwarkar@motorolasolutions.com

MANUFACTURER	
<b>Name:</b>	Psion Inc
<b>Address:</b>	2100 Meadowvale Boulevard Mississauga, ON L5N 7J9 Canada
<b>Contact Person:</b>	Mr. Sada Dharwarkar Phone #: 905 812 6200 Ext. 3358 Fax #: 905 812 6301 Email Sada.Dharwarkar@motorolasolutions.com

### 2.2. EQUIPMENT UNDER TEST (EUT) INFORMATION

The following information (with the exception of the Date of Receipt) has been supplied by the applicant.

<b>Brand Name:</b>	Psion Inc
<b>Product Name:</b>	Handheld Computer
<b>Model Name or Number:</b>	7545MBW
<b>Serial Number:</b>	Test Sample
<b>Type of Equipment:</b>	Digital Transmission System (DTS)
<b>Input Power Supply Type:</b>	Lithium-Ion Battery
<b>Primary User Functions of EUT:</b>	Transmit and receive data

**2.3. EUT’S TECHNICAL SPECIFICATIONS**

<b>Transmitter</b>	
<b>Equipment Type:</b>	Portable
<b>Intended Operating Environment:</b>	Commercial, industrial or business
<b>Power Supply Requirement:</b>	3.7 V DC
<b>RF Output Power Rating:</b>	Channel 01 to 11 (2412 MHz to 2462 MHz): 802.11b : 19.24 dBm (0.084 W) 802.11g : 24.51 dBm (0.282 W) 802.11n HT 20: 23.74 dBm (0.237 W)  Channel 12 (2467 MHz) and Channel 13 (2472 MHz): 802.11b : 11.13 dBm (0.013 W) 802.11g : 13.76 dBm (0.024 W) 802.11n HT 20: 13.77dBm (0.024 W)
<b>Operating Frequency Range:</b>	2412 – 2472 MHz
<b>RF Output Impedance:</b>	50 Ω
<b>Channel Spacing:</b>	5 MHz
<b>Duty Cycle:</b>	100%
<b>Modulation Type(s):</b>	802.11b: DSSS / 802.11g/n: OFDM
<b>Oscillator Frequency(ies):</b>	32 MHz
<b>Antenna Connector Types:</b>	U.FL

**2.4. ASSOCIATED ANTENNA DESCRIPTION**

Manufacturer:	Psion Inc.
Type:	PCB
Model:	1004856
Frequency Range:	2400-2484 MHz
Impedance:	50 Ω
Gain (dBi):	1.9 dBi

**2.5. LIST OF EUT’S PORTS**

Port Number	EUT’s Port Description	Number of Identical Ports	Connector Type	Cable Type (Shielded/Non-shielded)
1	Docking Port	1	Pogo	None

**2.6. ANCILLARY EQUIPMENT**

None.

**EXHIBIT 3. EUT OPERATING CONDITIONS AND CONFIGURATIONS DURING TESTS**

**3.1. CLIMATE TEST CONDITIONS**

The climate conditions of the test environment are as follows:

Temperature:	21 to 23 °C
Humidity:	45 to 58%
Pressure:	102 kPa
Power Input Source:	3.7 V Lithium-Ion Battery

**3.2. OPERATIONAL TEST CONDITIONS & ARRANGEMENT FOR TESTS**

<b>Operating Modes:</b>	EUT configured for continuous transmit mode with typical modulation being applied during testing.
<b>Special Test Software:</b>	Special software provided by the Applicant to operate the EUT at desired channel frequency continuously during testing in a range of typical modulation modes of operation,
<b>Special Hardware Used:</b>	N/A
<b>Transmitter Test Antenna:</b>	The EUT is tested with the transmitter antenna port terminated to a 50 Ω Load.

<b>Transmitter Test Signals</b>	
<b>Frequency Band(s):</b>	2412 – 2472 MHz
<b>Frequency(ies) Tested:</b>	2472 MHz (highest channel to extend operating frequency range )
<b>RF Power Output:</b>	13.77dBm (0.024 W) Peak (at reduced power level)
<b>Normal Test Modulation:</b>	802.11b : DSSS 802.11g/n : OFDM
<b>Modulating Signal Source:</b>	Internal

**EXHIBIT 4. SUMMARY OF TEST RESULTS**

**4.1. LOCATION OF TESTS**

All of the measurements described in this report were performed at Ultratech Group of Labs located in the city of Oakville, Province of Ontario, Canada.

- AC Power Line Conducted Emissions were performed in UltraTech's shielded room, 24'(L) by 16'(W) by 8'(H).
- Radiated Emissions were performed at the Ultratech's 3-10 TDK Semi-Anechoic Chamber situated in the Town of Oakville, province of Ontario. This test site been calibrated in accordance with ANSI C63.4, and found to be in compliance with the requirements of Sec. 2.948 of the FCC Rules. The descriptions and site measurement data of the Oakville 3-10 TDK Semi-Anechoic Chamber has been filed with FCC office (FCC File No.: 91038) and Industry Canada office (Industry Canada File No.: 2049A-3). Expiry Date: 2014-04-04.

**4.2. APPLICABILITY & SUMMARY OF EMC EMISSION TEST RESULTS**

FCC Section(s)	Test Requirements	Compliance (Yes/No)
15.203	Antenna requirements	Yes*
15.207(a)	AC Power Line Conducted Emissions	n/a
15.215 (c)	20 dB Bandwidth	Yes
15.247(a)(2)	6 dB Bandwidth	n/a
15.247(b)(3)	Peak Conducted Output Power - DTS	Yes
15.247(d)	Band-Edge and RF Conducted Spurious Emissions at the Transmitter Antenna Terminal	Yes
15.247(d), 15.209 & 15.205	Transmitter Spurious Radiated Emissions	Yes
15.247(e)	Power Spectral Density	n/a
15.247(i) 1.1307, 1.1310, 2.1091 & 2.1093	RF Exposure	Yes**

\* The EUT complies with the requirement; it employs an integral antenna.

\*\* This class II permissive change for software change to add additional frequencies at reduced power does not have any impact on the SAR parameters or highest measured SAR in the original filing.

**4.3. MODIFICATIONS INCORPORATED IN THE EUT FOR COMPLIANCE PURPOSES**

None.

**EXHIBIT 5. TEST DATA**

**5.1. OCCUPIED BANDWIDTH [§ 15.215(c)]**

**5.1.1. Limit(s)**

§ 15.215(c): Intentional radiators operating under the alternative provisions to the general emission limits, as contained in §§ 15.217 through 15.257 and in Subpart E of this part, must be designed to ensure that the 20 dB bandwidth of the emission, or whatever bandwidth may otherwise be specified in the specific rule section under which the equipment operates, is contained within the frequency band designated in the rule section under which the equipment is operated. The requirement to contain the designated bandwidth of the emission within the specified frequency band includes the effects from frequency sweeping, frequency hopping and other modulation techniques that may be employed as well as the frequency stability of the transmitter over expected variations in temperature and supply voltage. If a frequency stability is not specified in the regulations, it is recommended that the fundamental emission be kept within at least the central 80% of the permitted band in order to minimize the possibility of out-of-band operation.

**5.1.2. Method of Measurements**

ANSI C63.10-2009, Section 6.9.1

**5.1.3. Test Arrangement**

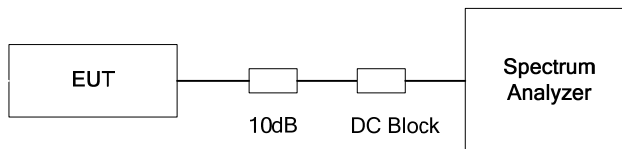

**5.1.4. Test Data**

Operating Mode	Data Rate (Mbps)	Frequency (MHz)	20 dB Bandwidth (MHz)
802.11b	1	2472	15.39
	11	2472	16.75
802.11g	6	2472	18.92
	54	2472	18.28
802.11n	6.5	2472	19.72
	65	2472	19.23

See the following plots for detailed measurements.



Plot 5.1.4.1. 20 dB Bandwidth, 802.11b, 1 Mbps Data Rate, 2472 MHz, 5 dBm Power Setting

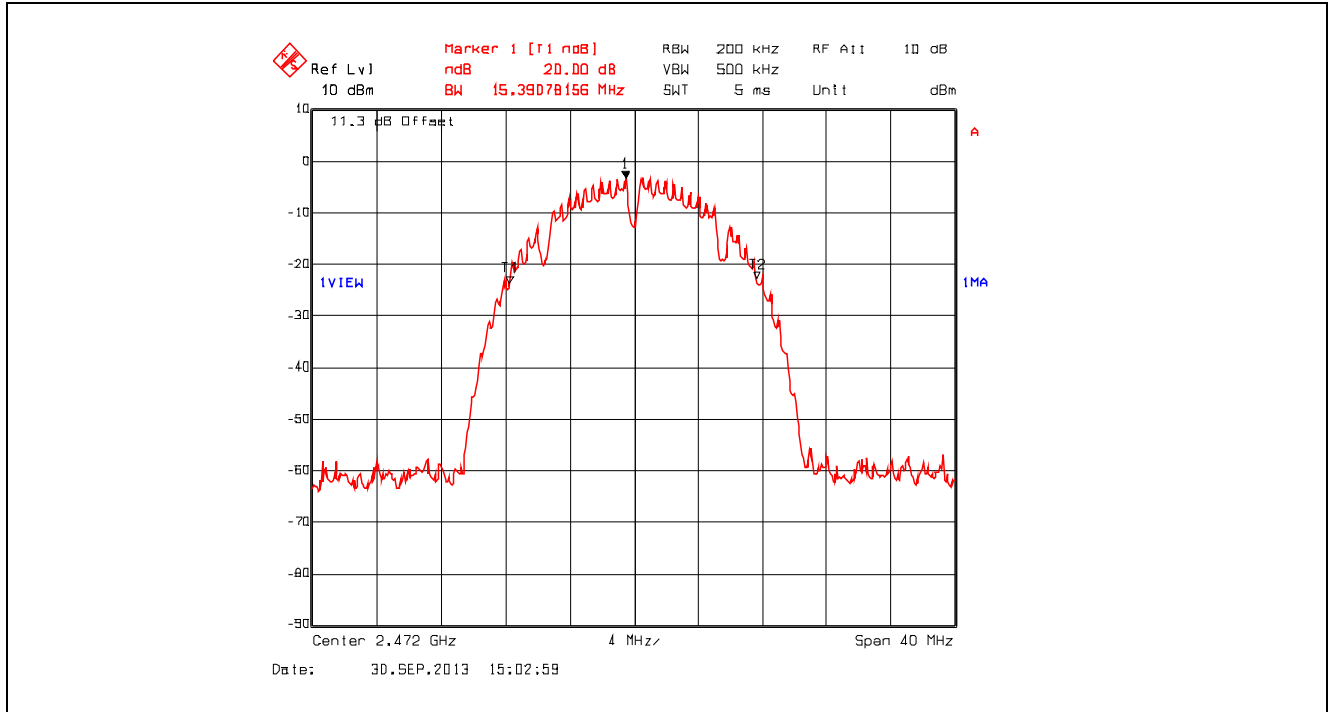

Plot 5.1.4.2. 20 dB Bandwidth, 802.11b, 11 Mbps Data Rate, 2472 MHz, 5 dBm Power Setting

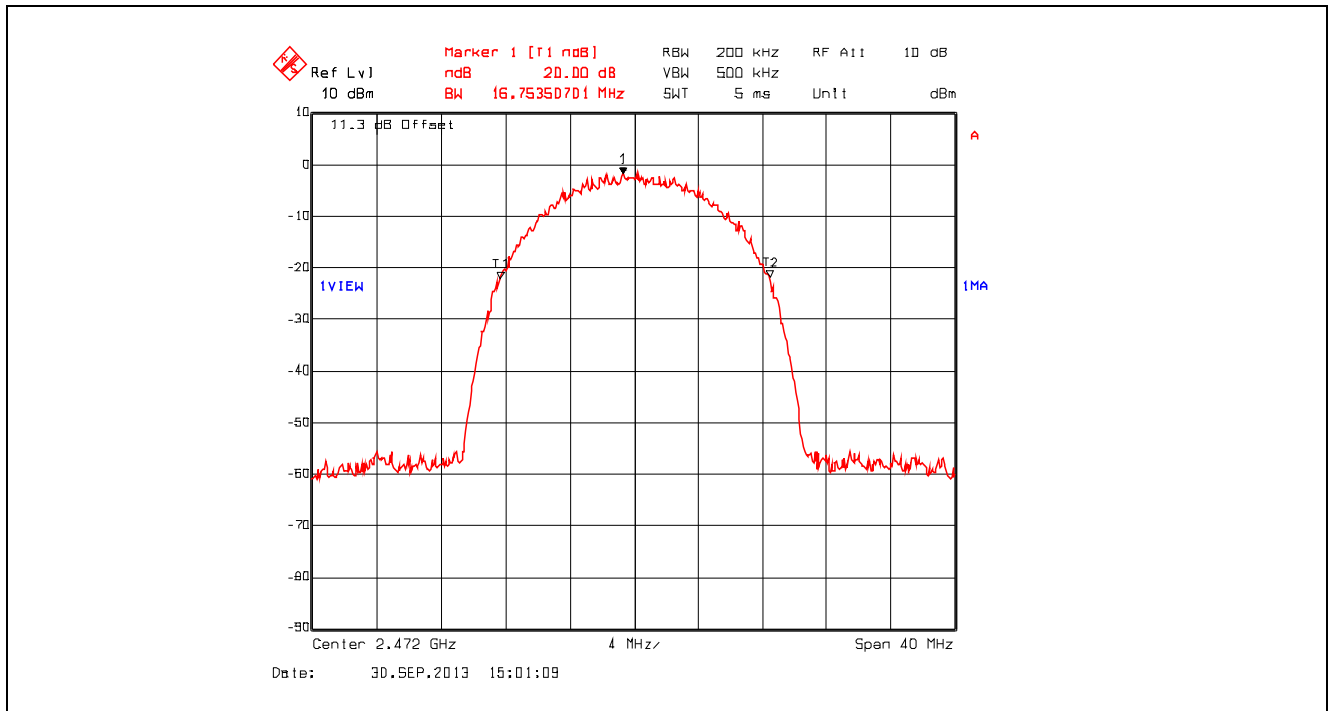

Plot 5.1.4.3. 20 dB Bandwidth, 802.11g, 6 Mbps Data Rate, 2472 MHz, 5 dBm Power Setting

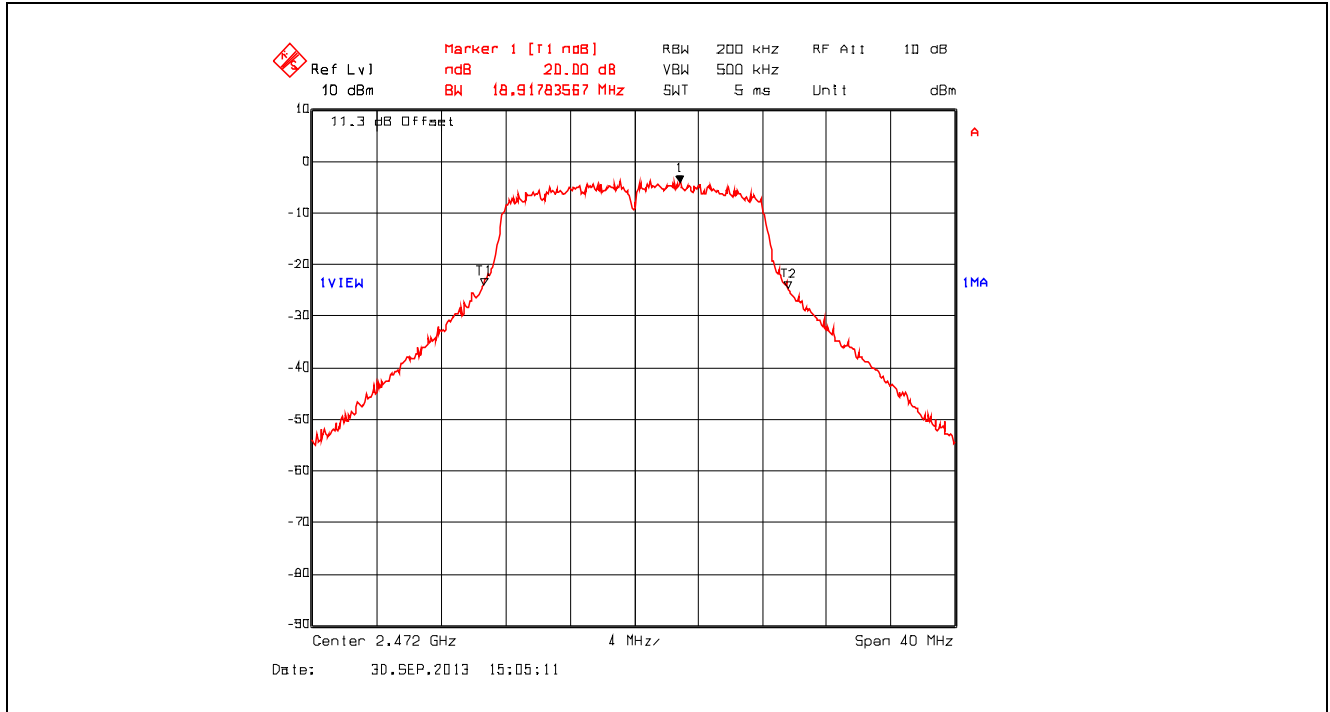

Plot 5.1.4.4. 20 dB Bandwidth, 802.11g, 54 Mbps Data Rate, 2472 MHz, 5 dBm Power Setting

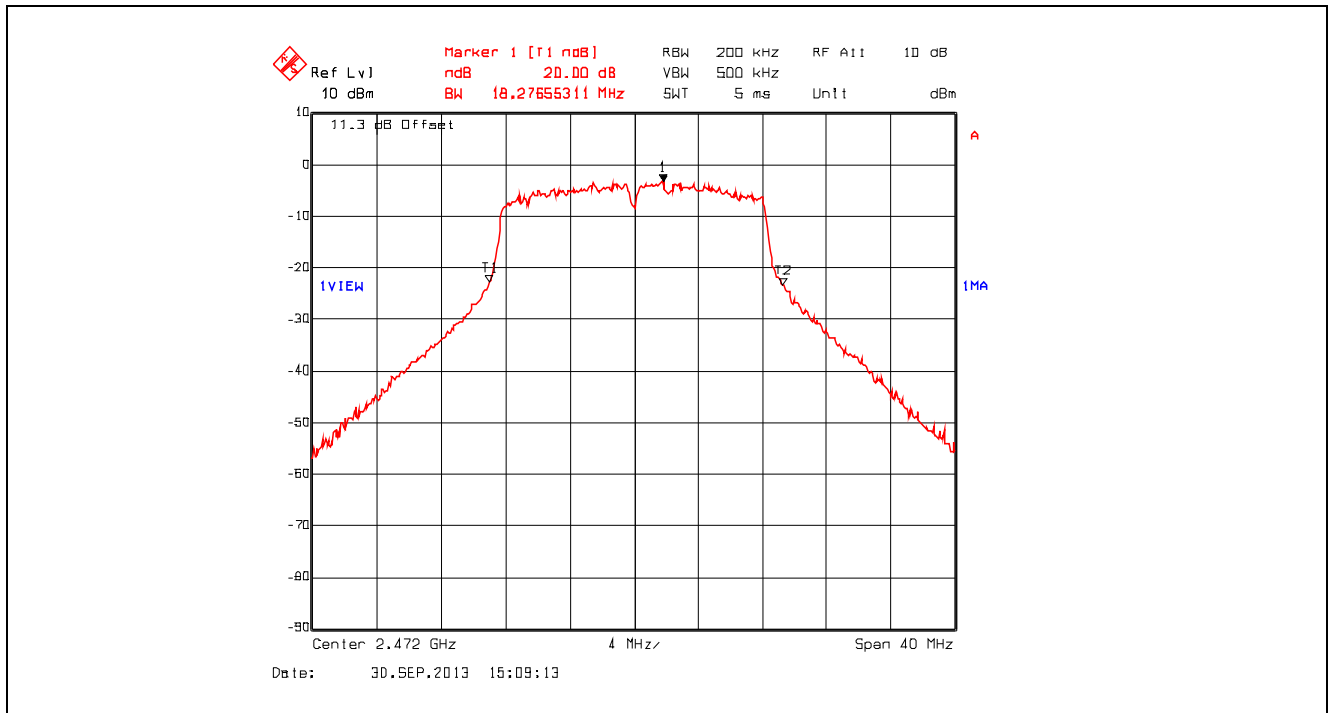

Plot 5.1.4.5. 20 dB Bandwidth, 802.11n, 6.5 Mbps Data Rate, 2472 MHz, 5 dBm Power Setting

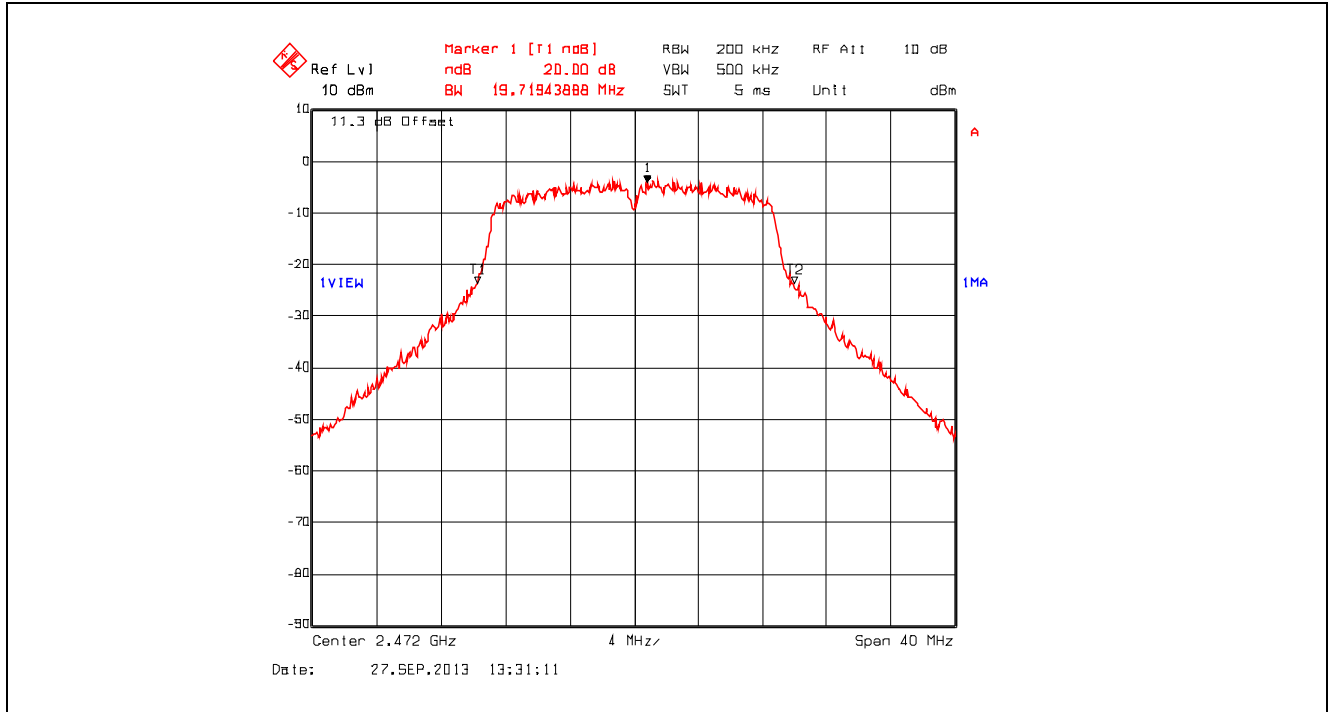

Plot 5.1.4.6. 20 dB Bandwidth, 802.11n, 65 Mbps Data Rate, 2472 MHz, 5 dBm Power Setting

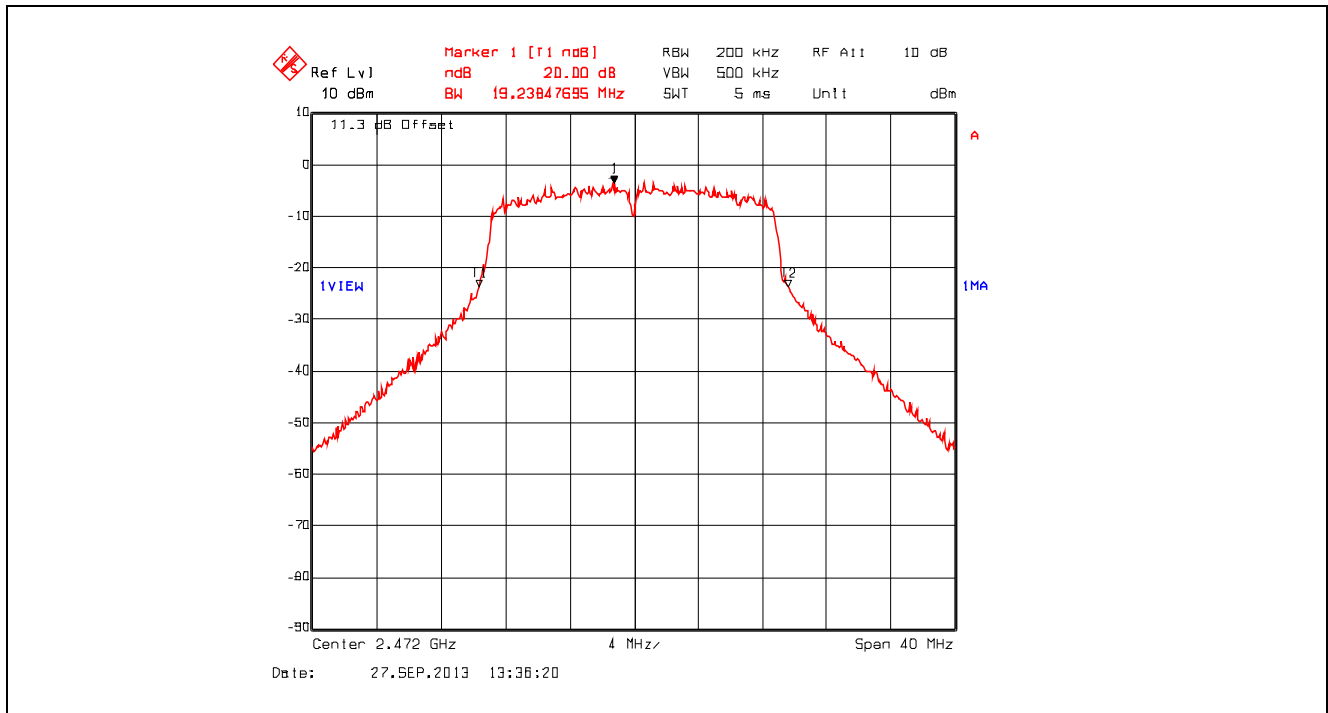

**5.2. PEAK CONDUCTED OUTPUT POWER - DTS [§ 15.247(b)(3)]**

**5.2.1. Limit(s)**

**§ 15.247(b)(3):** For systems using digital modulation in the 902-928 MHz, 2400-2483.5 MHz, and 5725-5850 MHz bands: 1 Watt. As an alternative to a peak power measurement, compliance with the one Watt limit can be based on a measurement of the maximum conducted output power. Maximum Conducted Output Power is defined as the total transmit power delivered to all antennas and antenna elements averaged across all symbols in the signaling alphabet when the transmitter is operating at its maximum power control level. Power must be summed across all antennas and antenna elements. The average must not include any time intervals during which the transmitter is off or is transmitting at a reduced power level. If multiple modes of operation are possible (e.g., alternative modulation methods), the maximum conducted output power is the highest total transmit power occurring in any mode.

**§15.247(b)(4):** The conducted output power limit specified in paragraph (b) of this section is based on the use of antennas with directional gains that do not exceed 6 dBi. Except as shown in paragraph (c) of this section, if transmitting antennas of directional gain greater than 6 dBi are used, the conducted output power from the intentional radiator shall be reduced below the stated values in paragraphs (b)(1), (b)(2), and (b)(3) of this section, as appropriate, by the amount in dB that the directional gain of the antenna exceeds 6 dBi.

**5.2.2. Method of Measurements & Test Arrangement**

KDB Publication No. 558074 D01 v03r01 Section 9.1.2 Integrated band power method

**5.2.3. Test Arrangement**

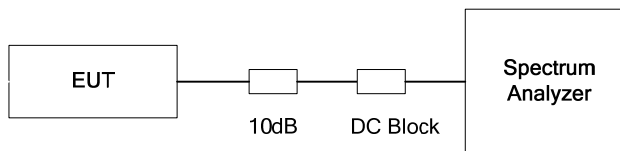

**5.2.4. Test Data**

Power Setting (dBm)	Operating Mode	Modulation	Data Rate (Mbps)	Frequency (MHz)	Max.Peak Conducted Power (dBm)
5	802.11b	DBPSK	1	2472	7.88
		CCK	11	2472	11.13
	802.11g	BPSK	6	2472	13.76
		64QAM	54	2472	13.73
	802.11n	(MCS0) BPSK	6.5	2472	13.58
		(MCS7) 64QAM	65	2472	13.77

Plot 5.2.4.1. Peak Conducted Power, 802.11b, 1 Mbps Data Rate, 2472 MHz, 5 dBm Power Setting

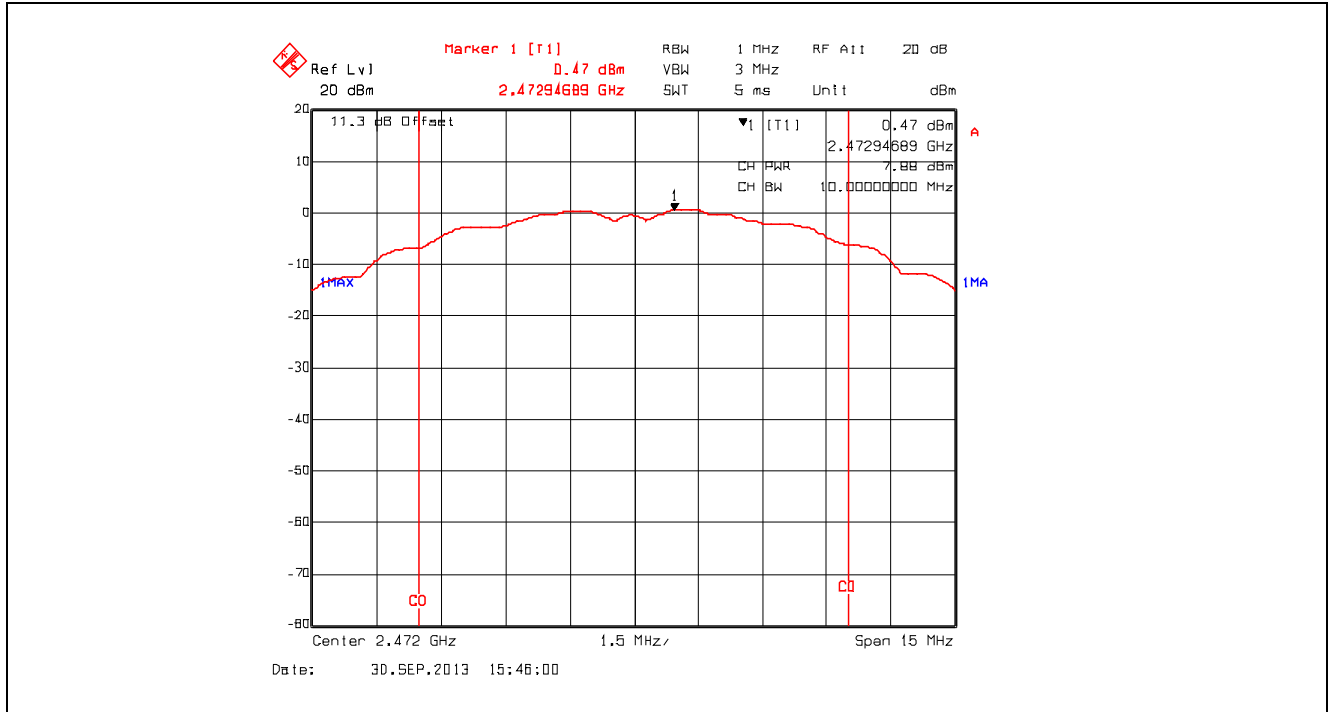

Plot 5.2.4.2. Peak Conducted Power, 802.11b, 11 Mbps Data Rate, 2472 MHz, 5 dBm Power Setting

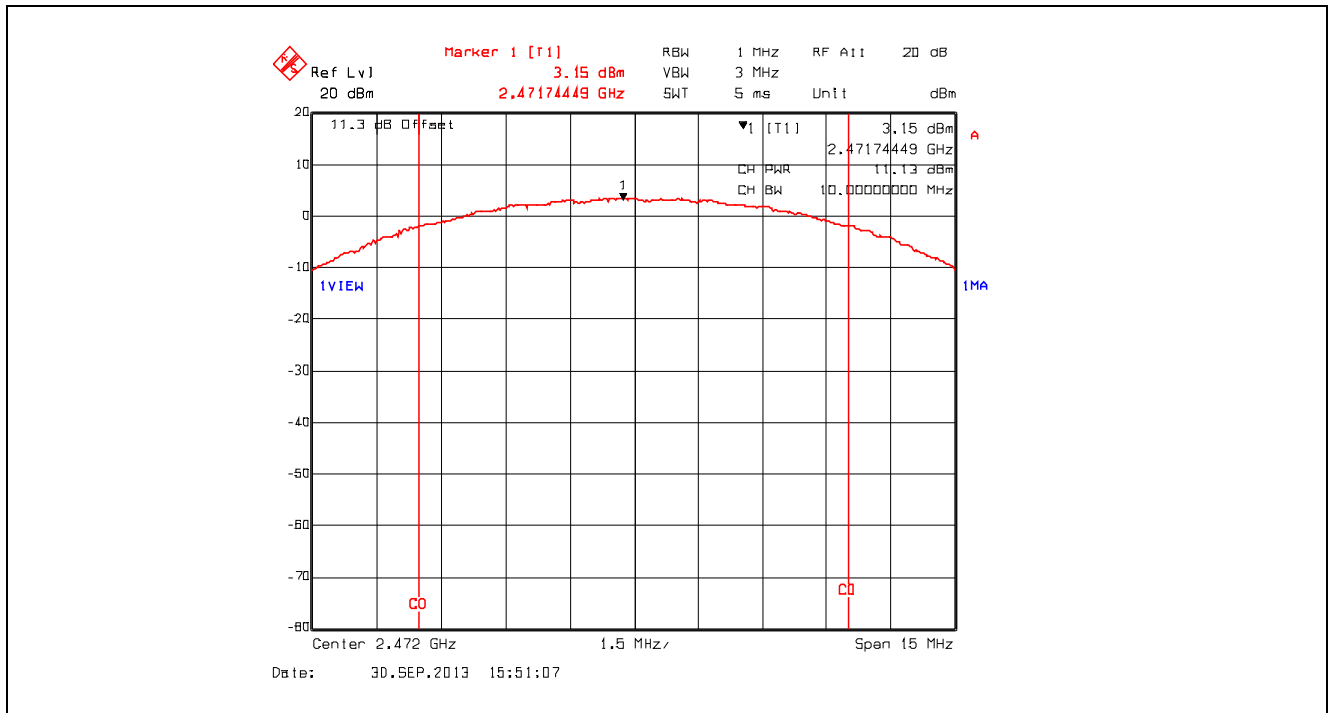

Plot 5.2.4.3. Peak Conducted Power, 802.11g, 6 Mbps Data Rate, 2472 MHz, 5 dBm Power Setting

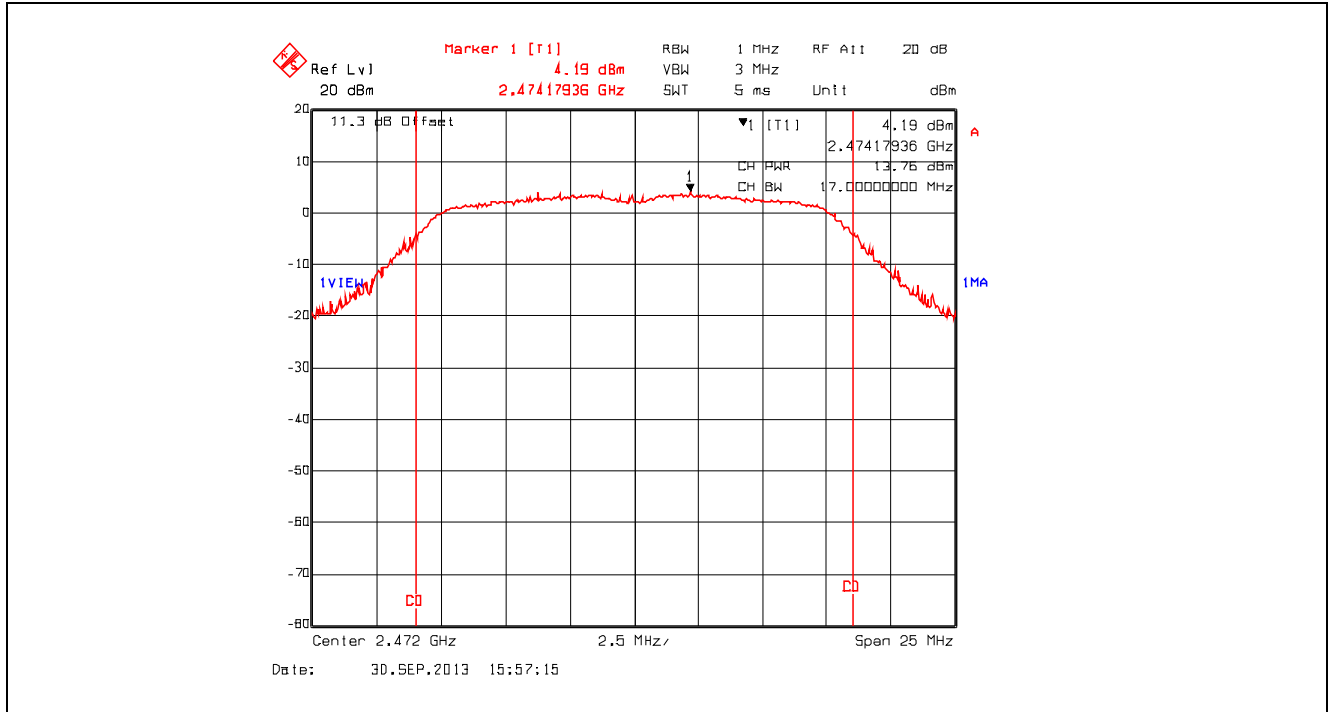

Plot 5.2.4.4. Peak Conducted Power, 802.11g, 54 Mbps Data Rate, 2472 MHz, 5 dBm Power Setting

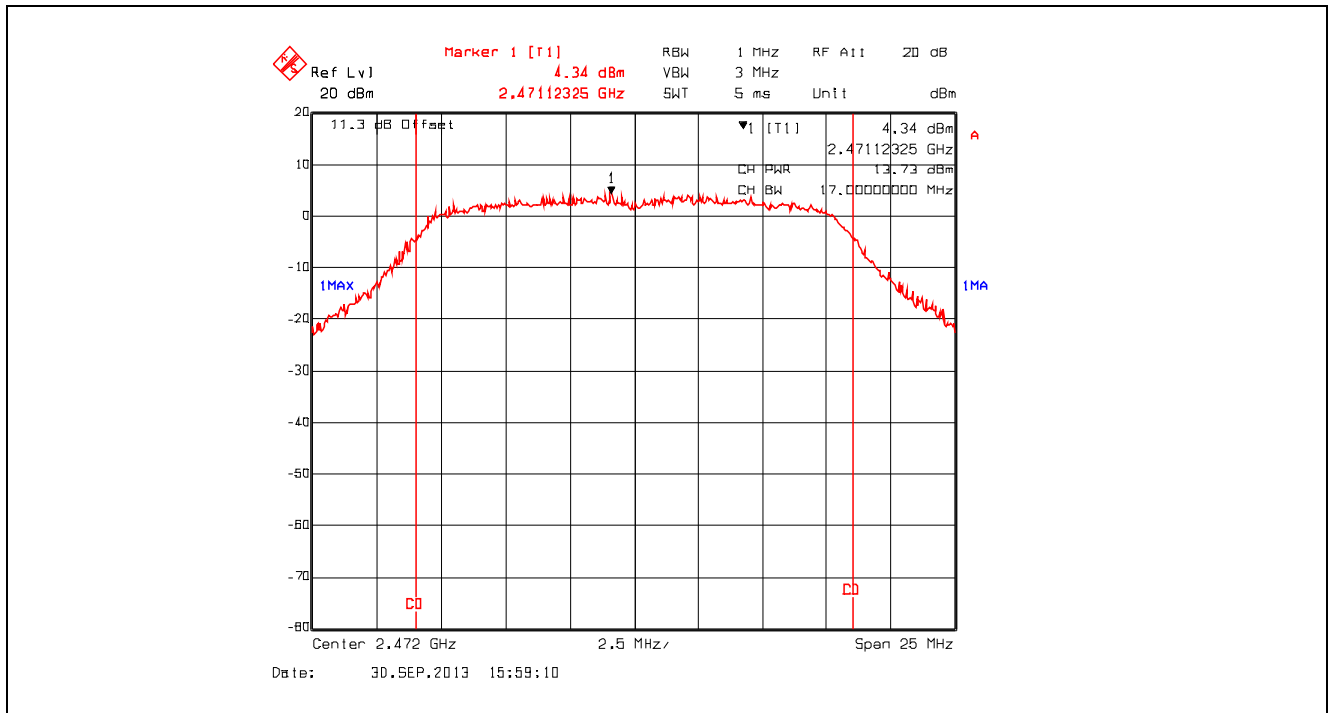

Plot 5.2.4.5. Peak Conducted Power, 802.11n, 6.5 Mbps Data Rate, 2472 MHz, 5 dBm Power Setting

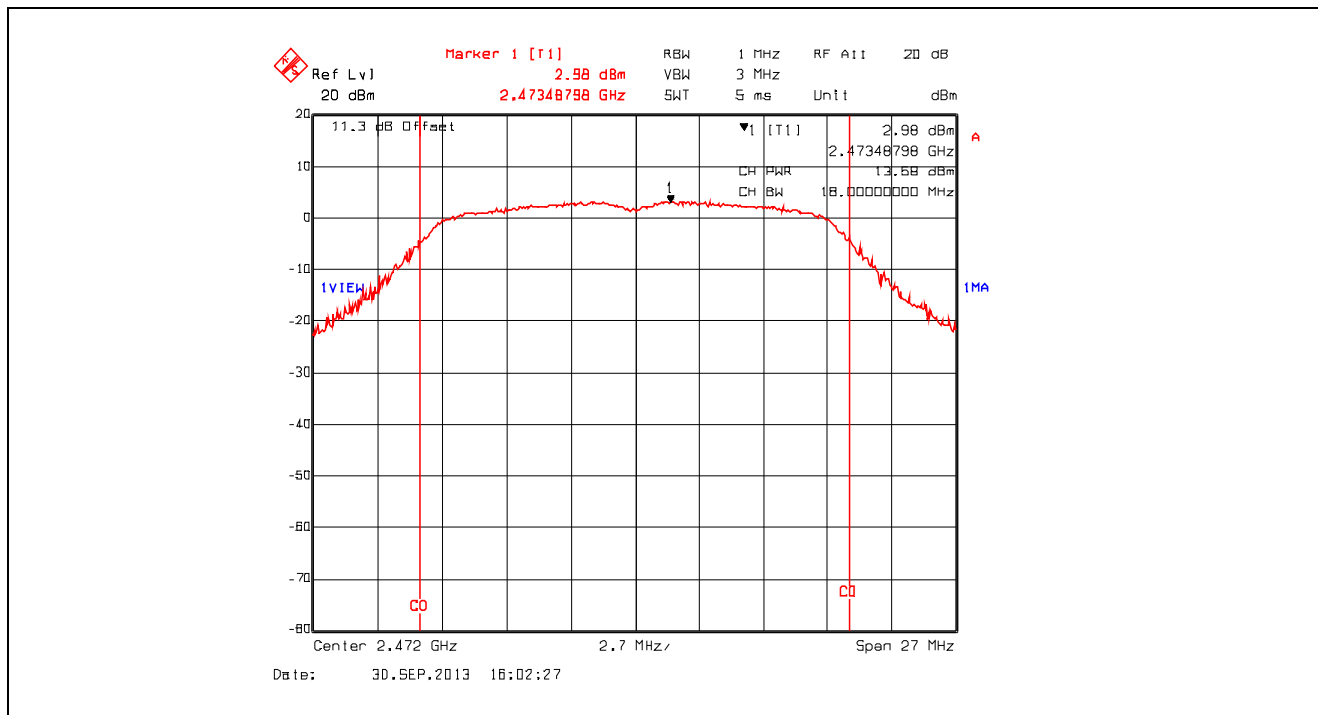

Plot 5.2.4.6. Peak Conducted Power, 802.11n, 65 Mbps Data Rate, 2472 MHz, 5 dBm Power Setting

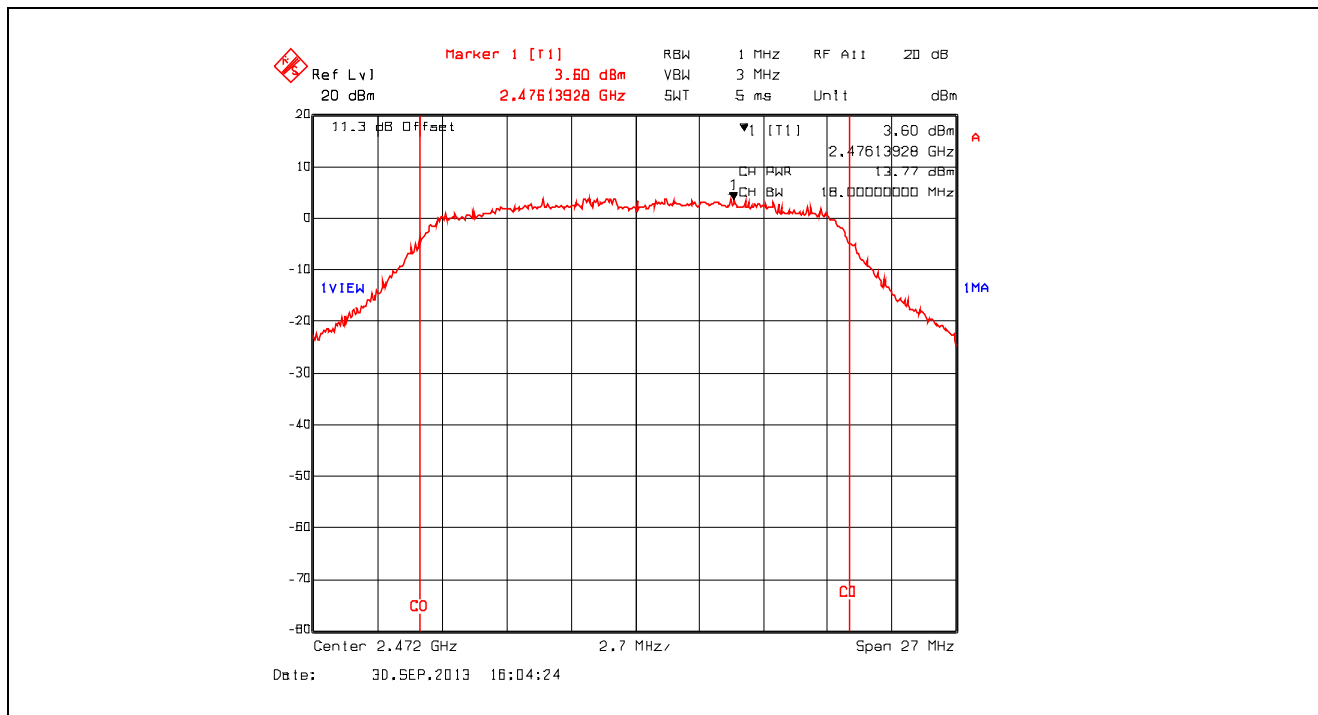

### 5.3. TRANSMITTER BAND-EDGE & SPURIOUS CONDUCTED EMISSIONS [§ 15.247(d)]

#### 5.3.1. Limit(s)

§ 15.247 (d): In any 100 kHz bandwidth outside the frequency band in which the spread spectrum or digitally modulated intentional radiator is operating, the radio frequency power that is produced by the intentional radiator shall be at least 20 dB below that in the 100 kHz bandwidth within the band that contains the highest level of the desired power, based on either an RF conducted or a radiated measurement, provided the transmitter demonstrates compliance with the peak conducted power limits. If the transmitter complies with the conducted power limits based on the use of RMS averaging over a time interval, as permitted under paragraph (b)(3) of this section, the attenuation required under this paragraph shall be 30 dB instead of 20 dB.

#### 5.3.2. Method of Measurements

KDB Publication No. 558074 D01, Sections 11.0 Emissions in non-restricted frequency bands, 12.0 Emissions in restricted frequency bands and 13.0 Band-edge measurements

#### 5.3.3. Test Arrangement

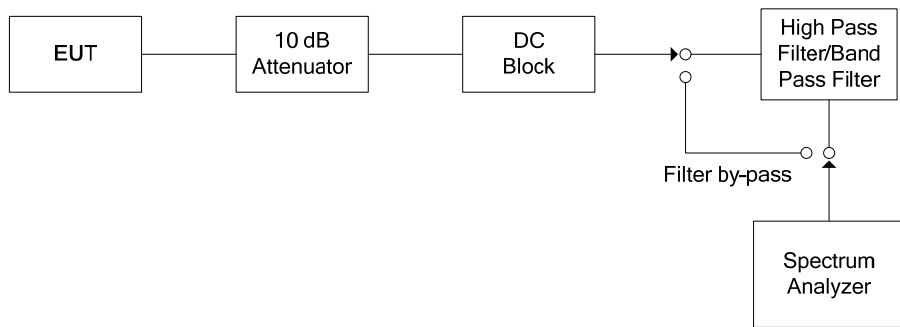



### 5.3.4. Test Data

#### 5.3.4.1. Band-Edge RF Conducted Emissions

Plot 5.3.4.1.1. Band-Edge RF Conducted Emissions, High End of Frequency Band  
802.11b, 1 Mbps Data Rate, 2472 MHz, 5 dBm Power Setting

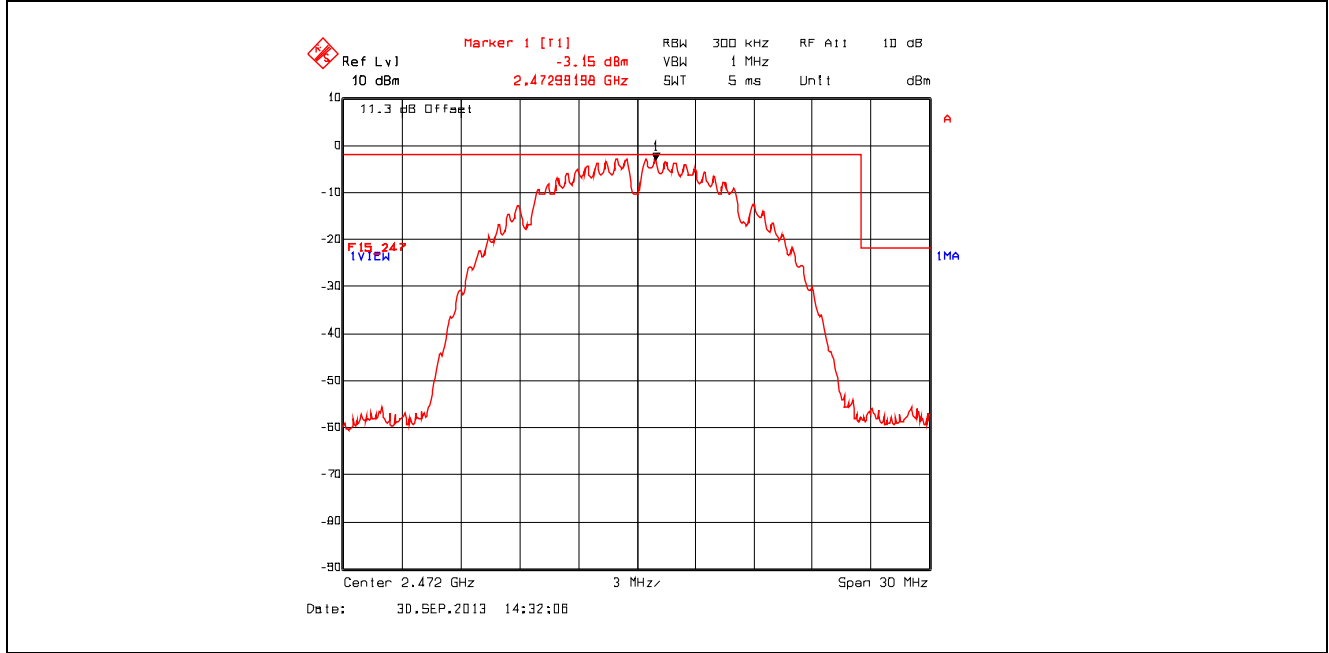

Plot 5.3.4.1.2. Band-Edge RF Conducted Emissions, High End of Frequency Band  
802.11b, 11 Mbps Data Rate, 2472 MHz, 5 dBm Power Setting

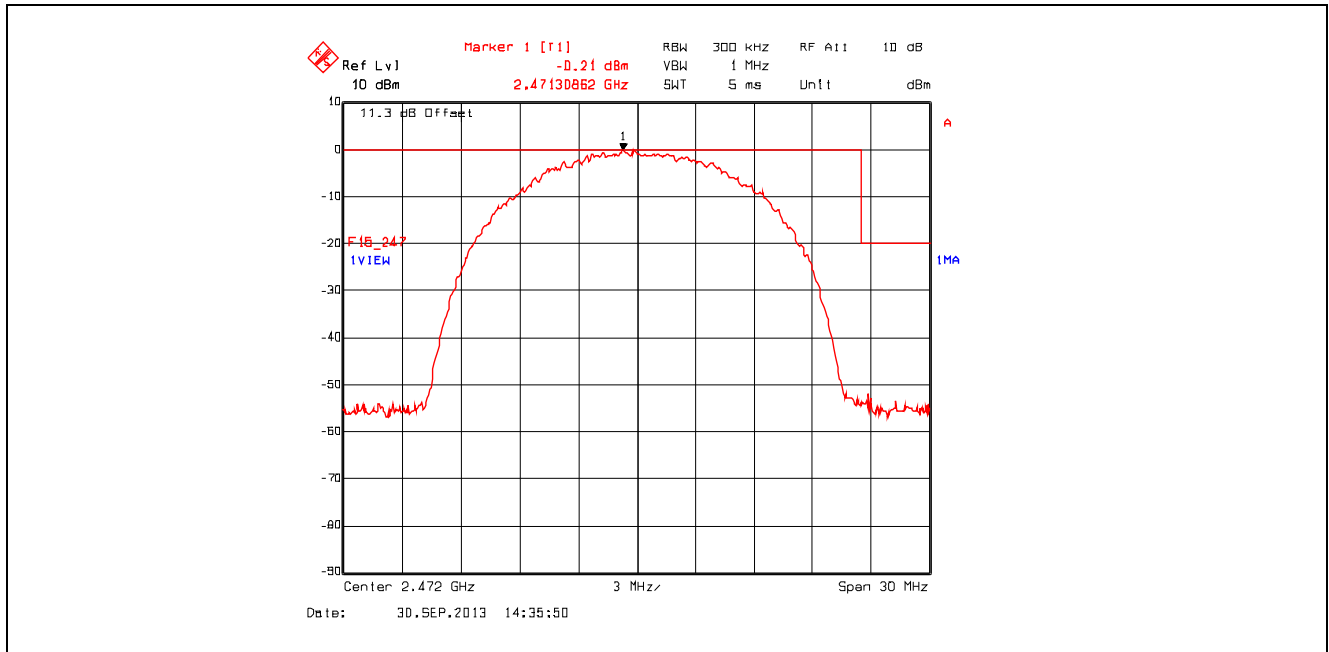

Plot 5.3.4.1.3. Band-Edge RF Conducted Emissions, High End of Frequency Band  
802.11g, 6 Mbps Data Rate, 2472 MHz, 5 dBm Power Setting

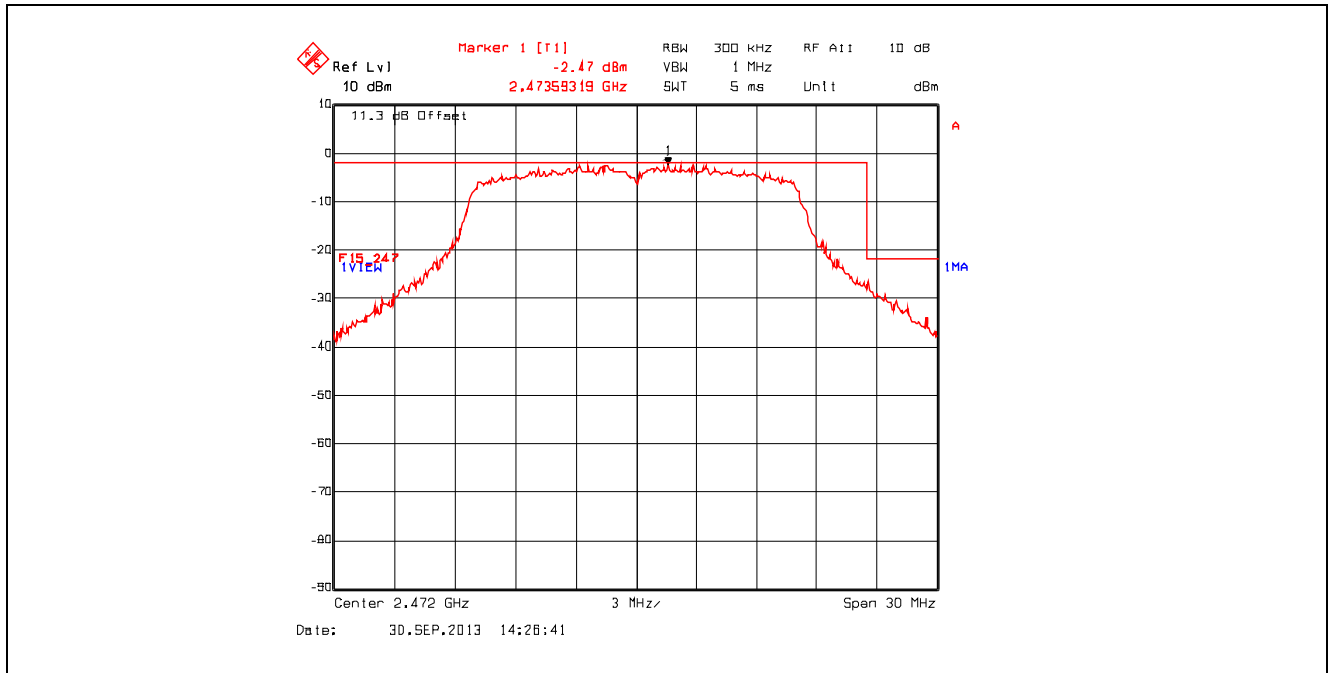

Plot 5.3.4.1.4. Band-Edge RF Conducted Emissions, High End of Frequency Band  
802.11g, 54 Mbps Data Rate, 2472 MHz, 5 dBm Power Setting

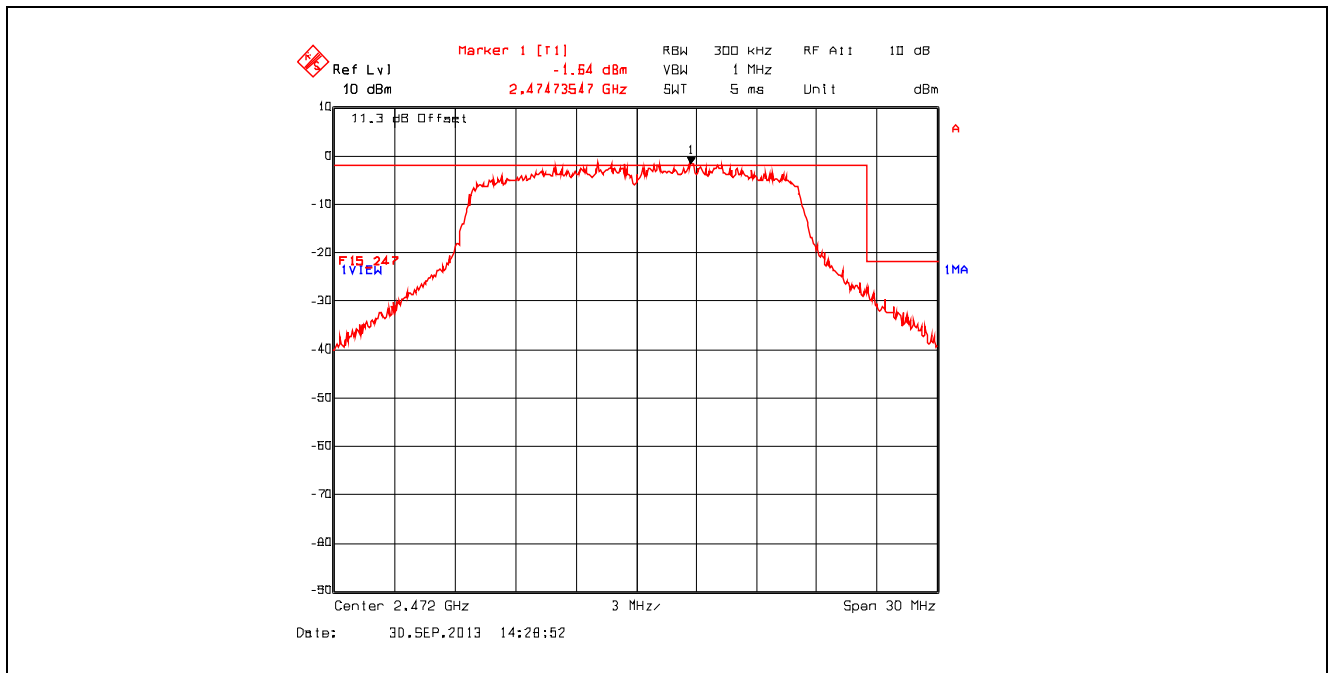

Plot 5.3.4.1.5. Band-Edge RF Conducted Emissions, High End of Frequency Band  
802.11n, 6.5 Mbps Data Rate, 2472 MHz, 5 dBm Power Setting

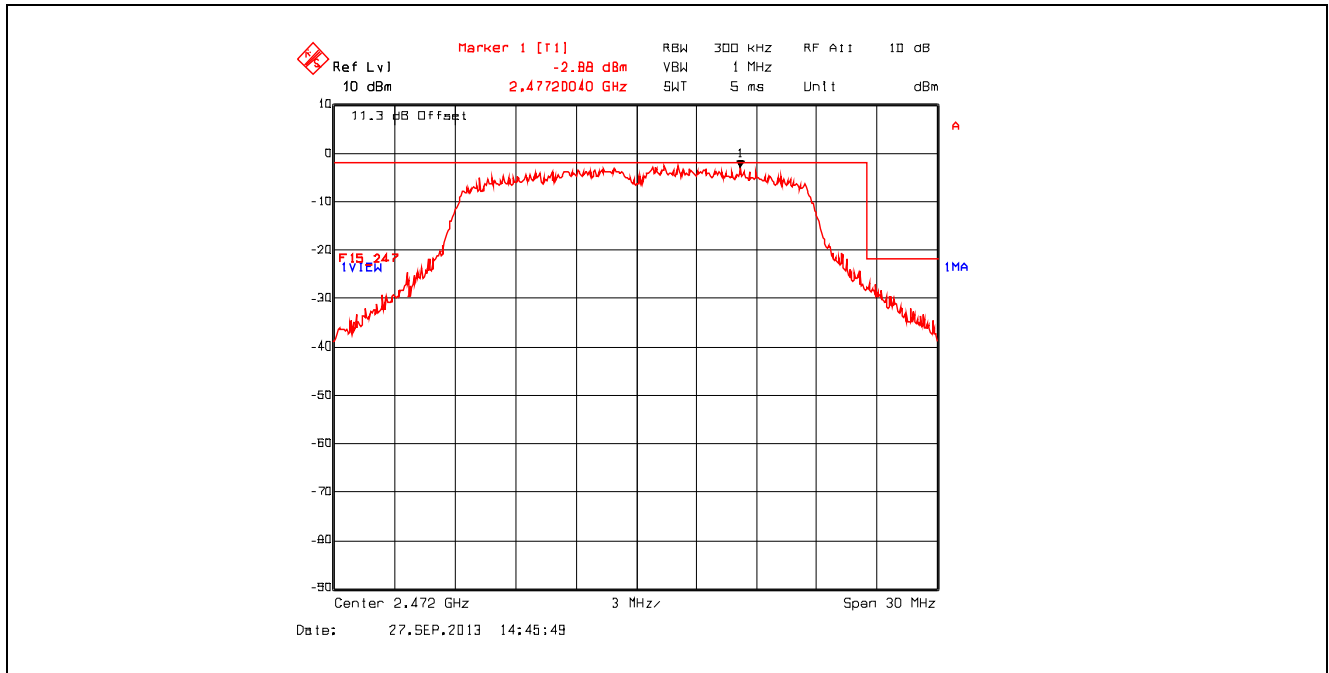

Plot 5.3.4.1.6. Band-Edge RF Conducted Emissions, High End of Frequency Band  
802.11n, 65 Mbps Data Rate, 2472 MHz, 5 dBm Power Setting

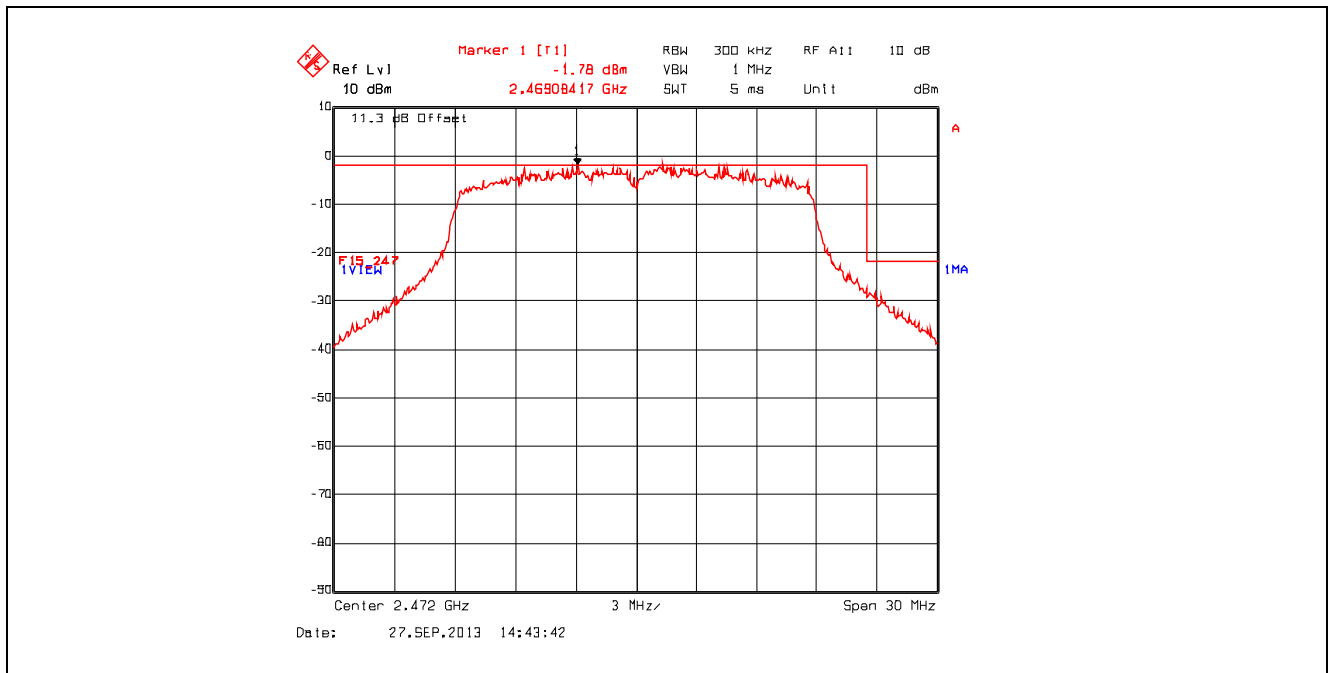

### 5.3.4.2. Conducted Spurious Emissions – Non Restricted Frequency Bands

**Plot 5.3.4.2.1.** Conducted Spurious Emissions – Non Restricted Frequency Bands  
802.11b, 1 Mbps Data Rate, 2472 MHz, 5 dBm Power Setting, 10 MHz – 2.6 GHz

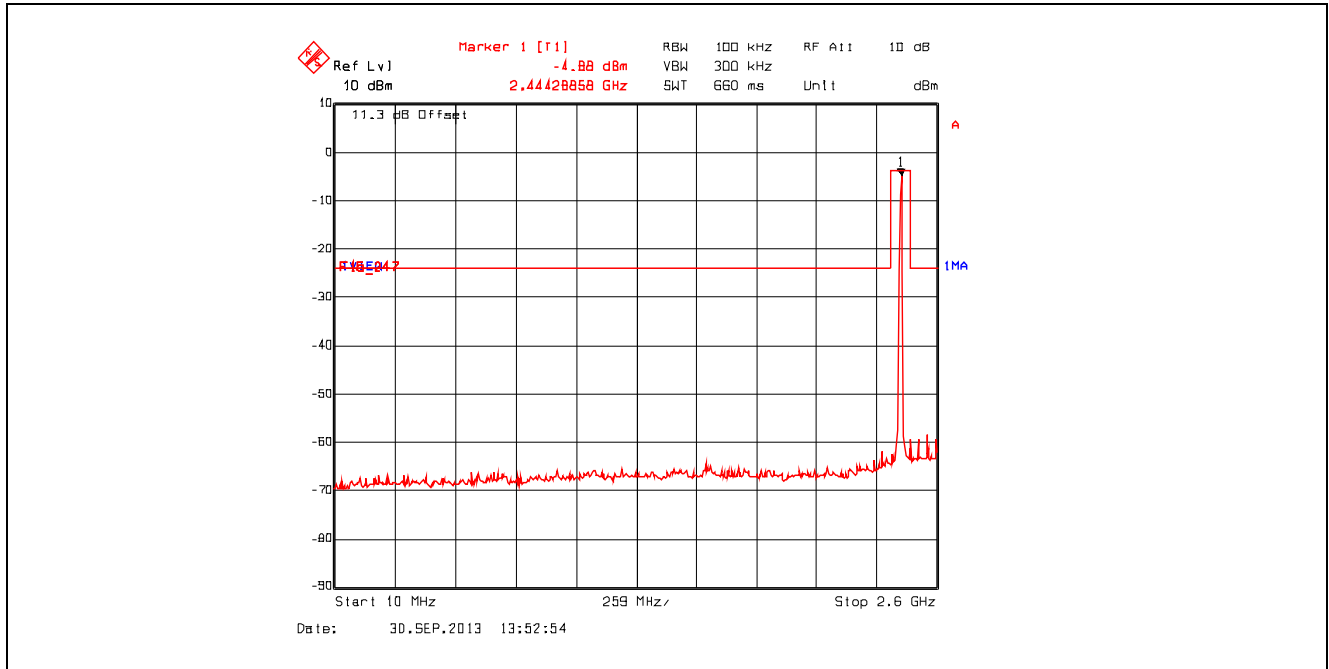

**Plot 5.3.4.2.2.** Conducted Spurious Emissions – Non Restricted Frequency Bands  
802.11b, 1 Mbps Data Rate, 2472 MHz, 5 dBm Power Setting, 2.6 GHz – 25 GHz

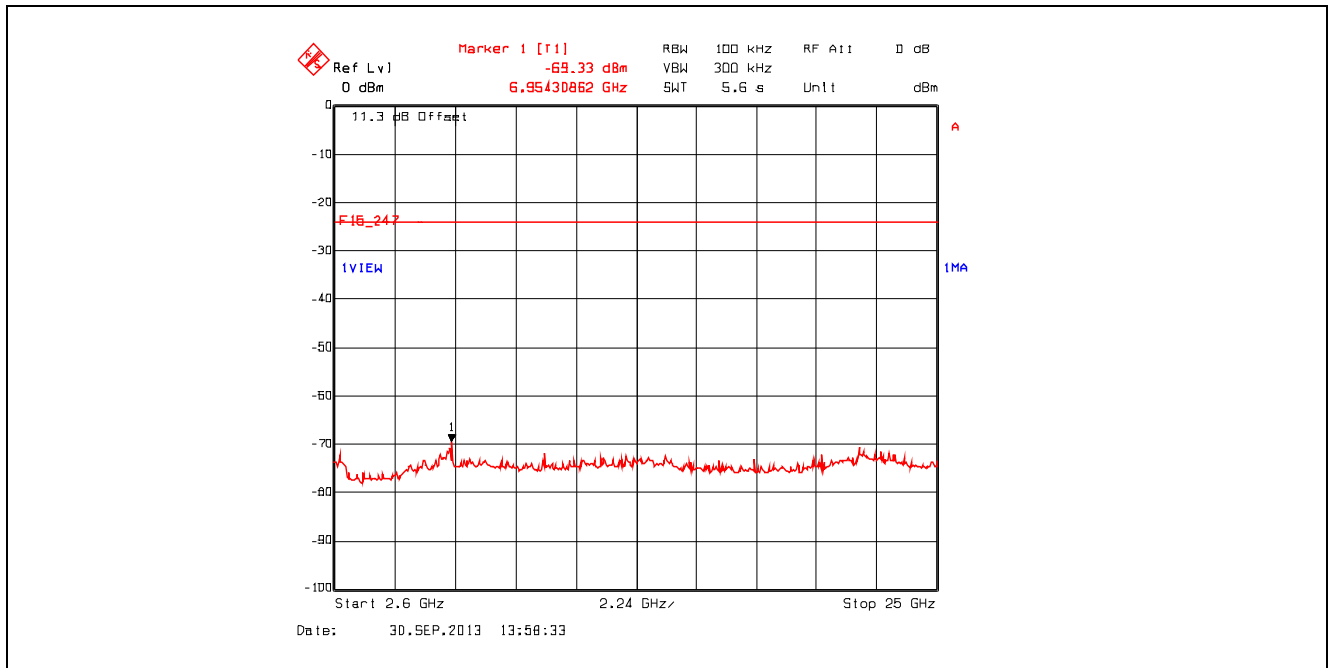

Plot 5.3.4.2.3. Conducted Spurious Emissions – Non Restricted Frequency Bands  
802.11b, 11 Mbps Data Rate, 2472 MHz, 5 dBm Power Setting, 10 MHz – 2.6 GHz

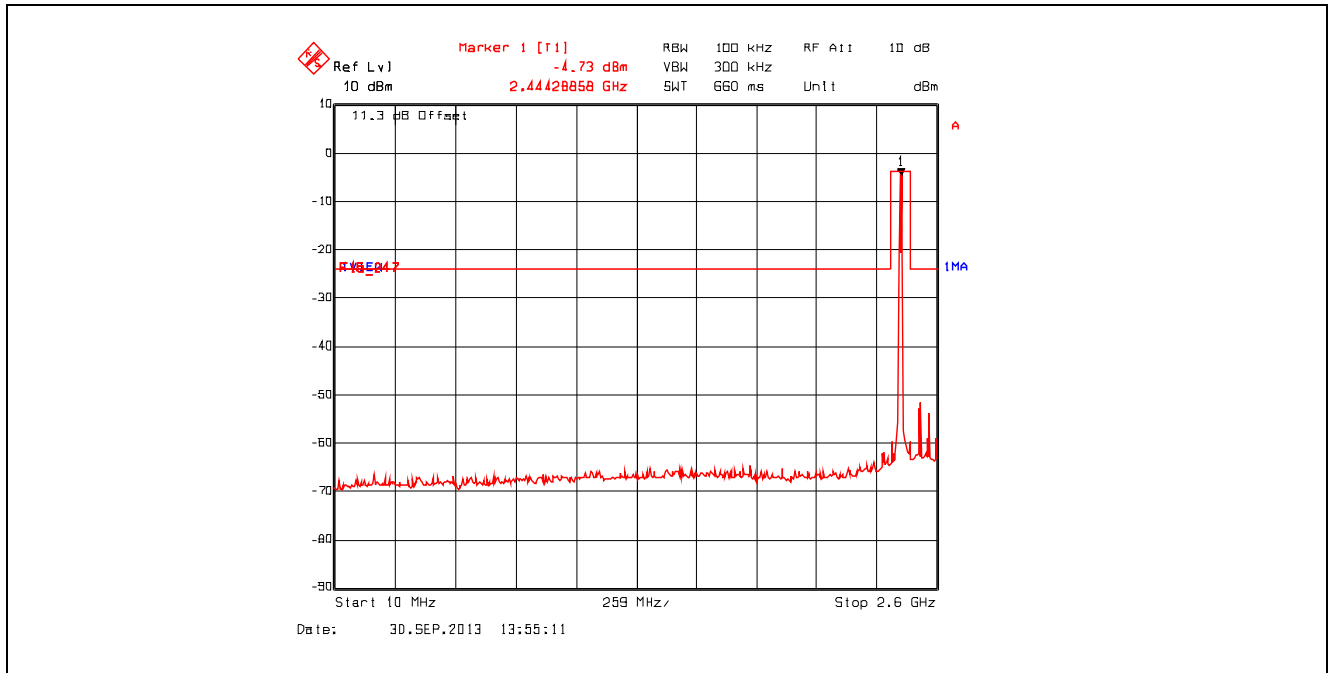

Plot 5.3.4.2.4. Conducted Spurious Emissions – Non Restricted Frequency Bands  
802.11b, 11 Mbps Data Rate, 2472 MHz, 5 dBm Power Setting, 2.6 GHz – 25 GHz

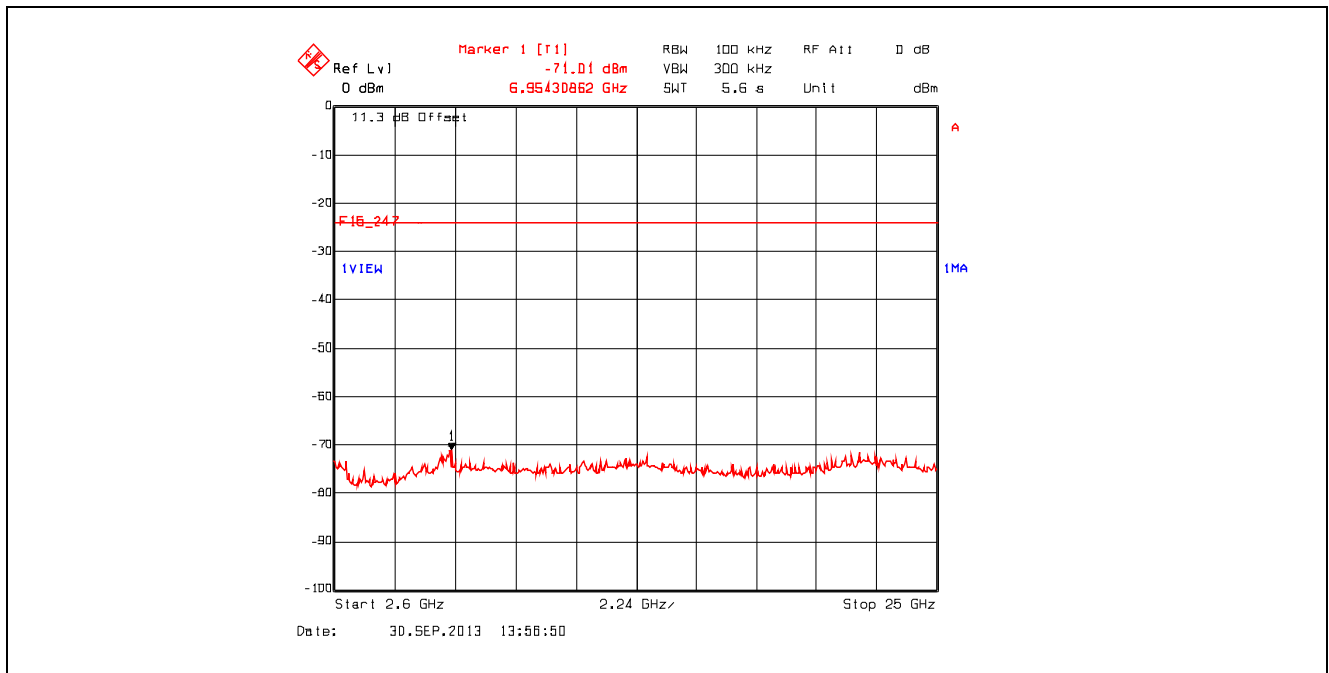

Plot 5.3.4.2.5. Conducted Spurious Emissions – Non Restricted Frequency Bands  
802.11g, 6 Mbps Data Rate, 2472 MHz, 5 dBm Power Setting, 10 MHz – 2.6 GHz

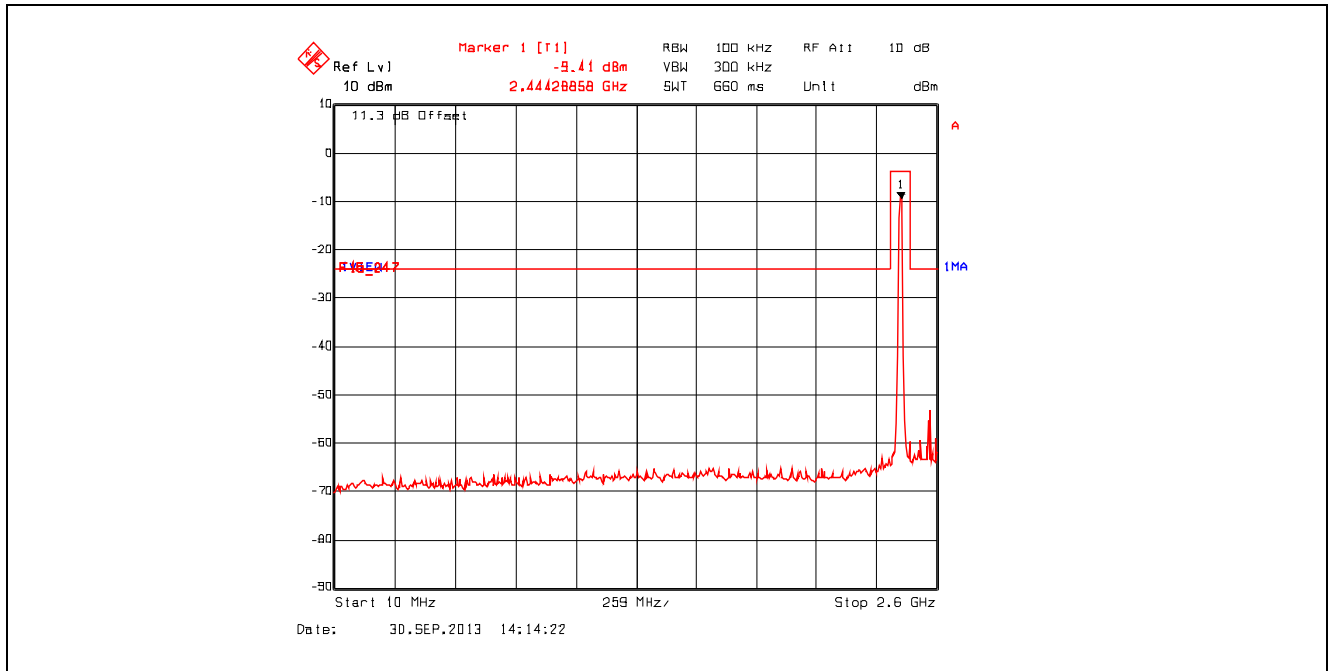

Plot 5.3.4.2.6. Conducted Spurious Emissions – Non Restricted Frequency Bands  
802.11g, 6 Mbps Data Rate, 2472 MHz, 5 dBm Power Setting, 2.6 GHz – 25 GHz

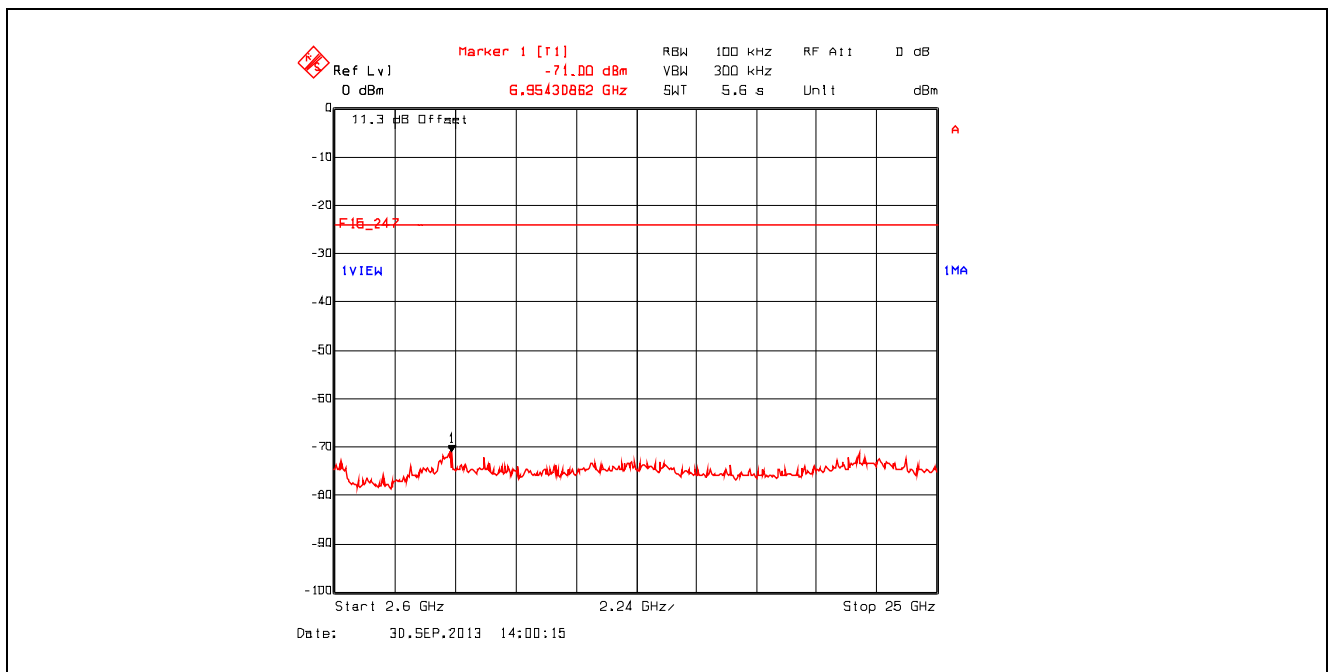

Plot 5.3.4.2.7. Conducted Spurious Emissions – Non Restricted Frequency Bands  
802.11g, 54 Mbps Data Rate, 2472 MHz, 5 dBm Power Setting, 10 MHz – 2.6 GHz

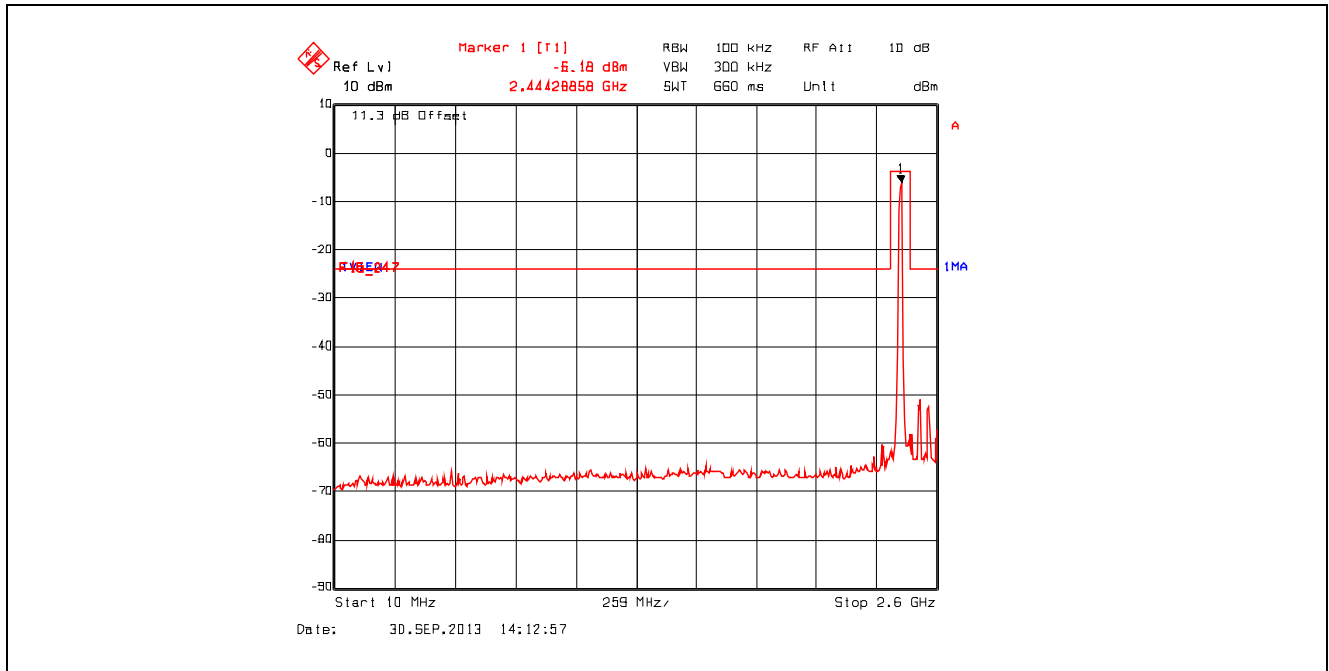

Plot 5.3.4.2.8. Conducted Spurious Emissions – Non Restricted Frequency Bands  
802.11g, 54 Mbps Data Rate, 2472 MHz, 5 dBm Power Setting, 2.6 GHz – 25 GHz

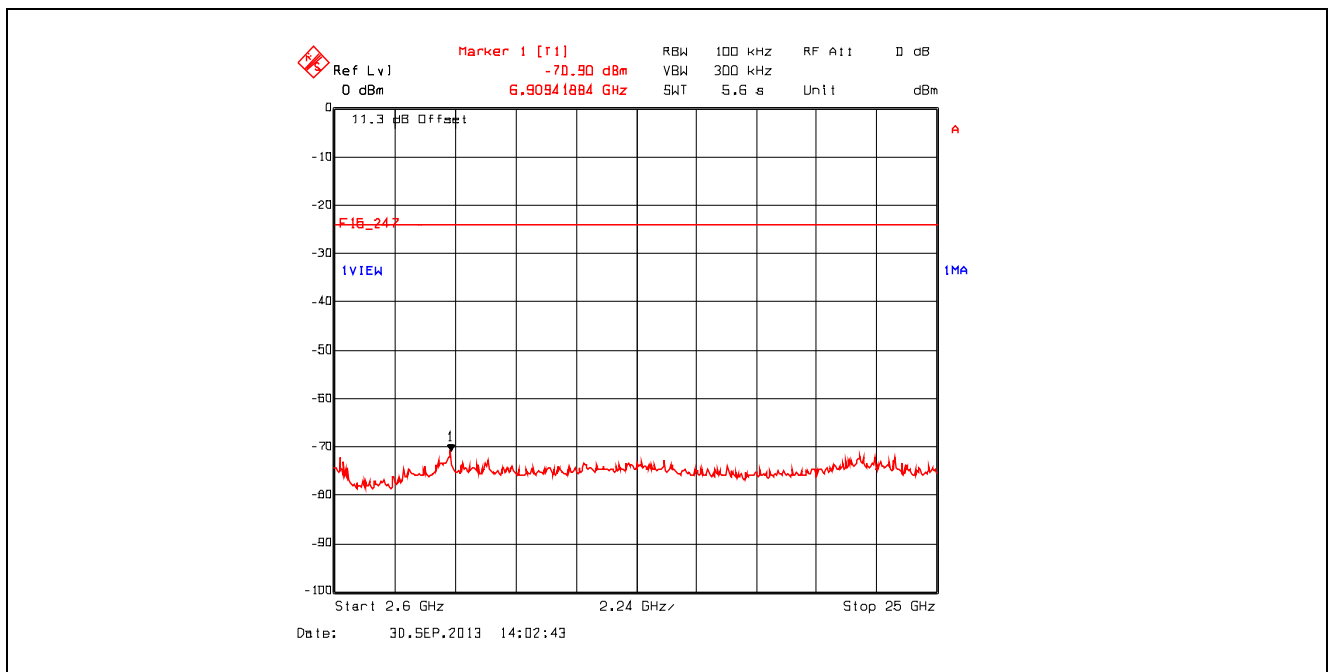

**Plot 5.3.4.2.9.** Conducted Spurious Emissions – Non Restricted Frequency Bands  
802.11n, 6.5 Mbps Data Rate, 2472 MHz, 5 dBm Power Setting, 10 MHz – 2.6 GHz

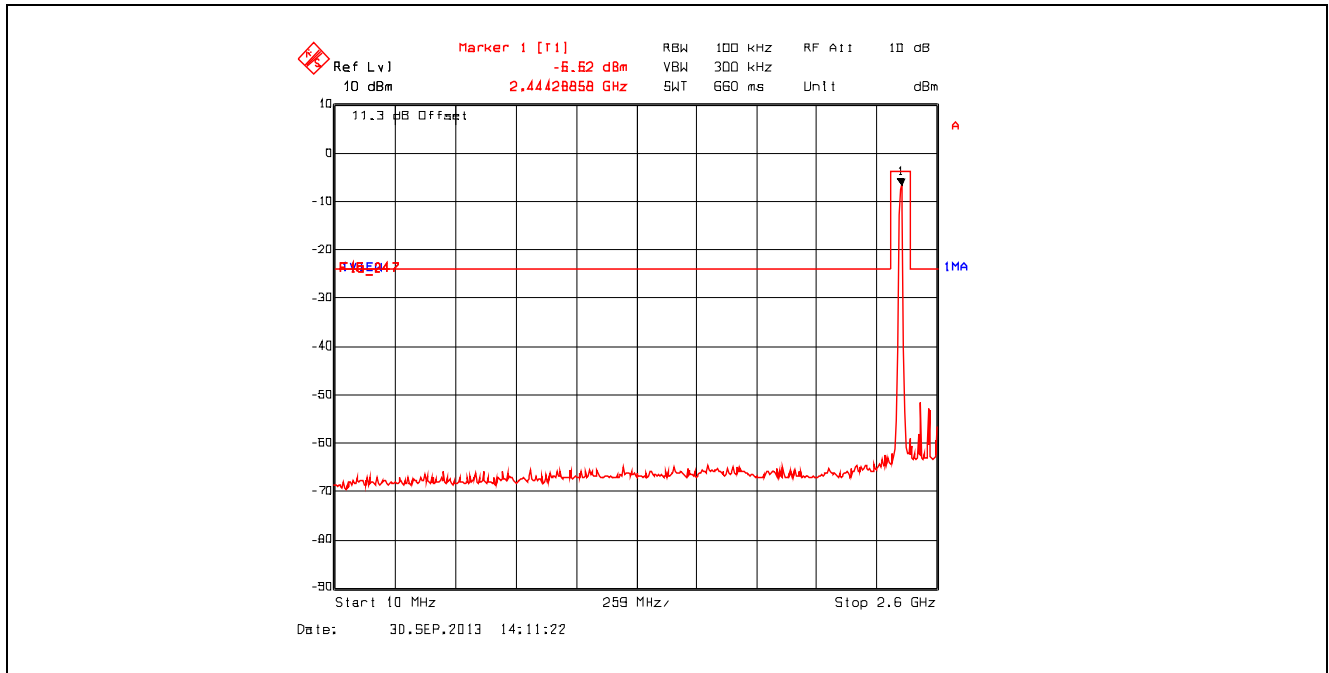

**Plot 5.3.4.2.10.** Conducted Spurious Emissions – Non Restricted Frequency Bands  
802.11n, 6.5 Mbps Data Rate, 2472 MHz, 5 dBm Power Setting, 2.6 GHz – 25 GHz

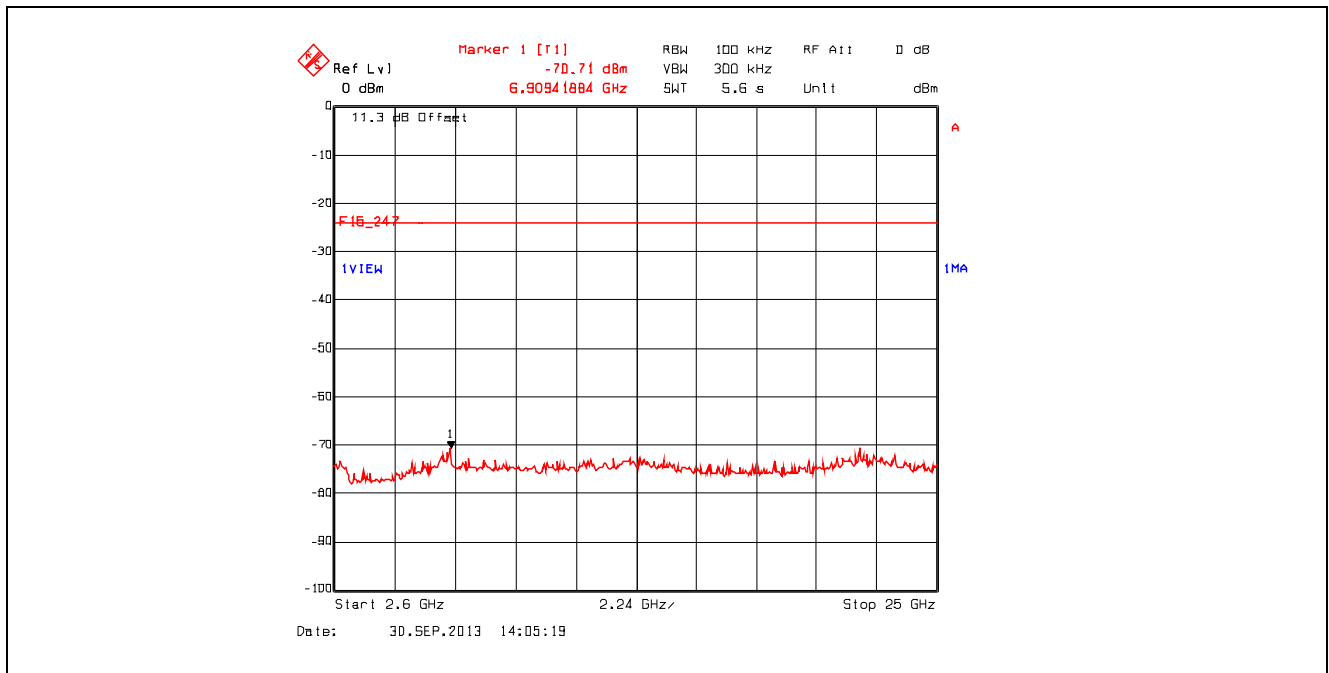



**Plot 5.3.4.2.11.** Conducted Spurious Emissions – Non Restricted Frequency Bands  
802.11n, 65 Mbps Data Rate, 2472 MHz, 5 dBm Power Setting, 10 MHz – 2.6 GHz

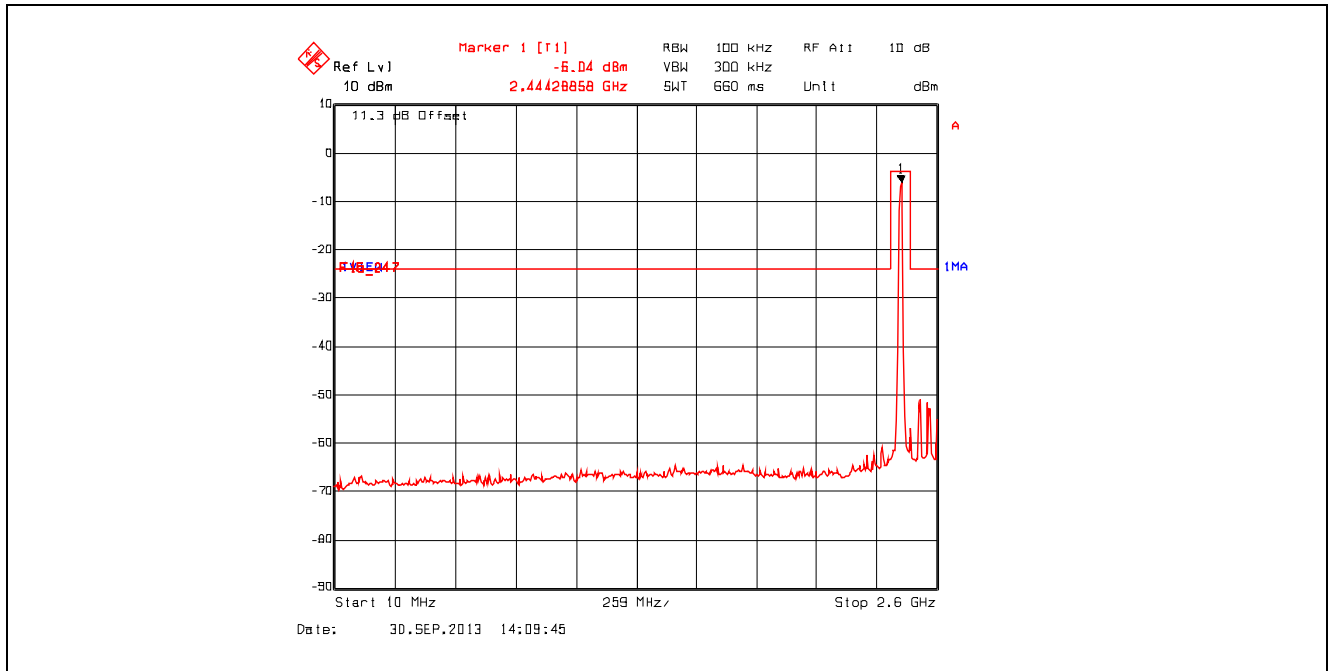

**Plot 5.3.4.2.12.** Conducted Spurious Emissions – Non Restricted Frequency Bands  
802.11n, 65 Mbps Data Rate, 2472 MHz, 5 dBm Power Setting, 2.6 GHz – 25 GHz

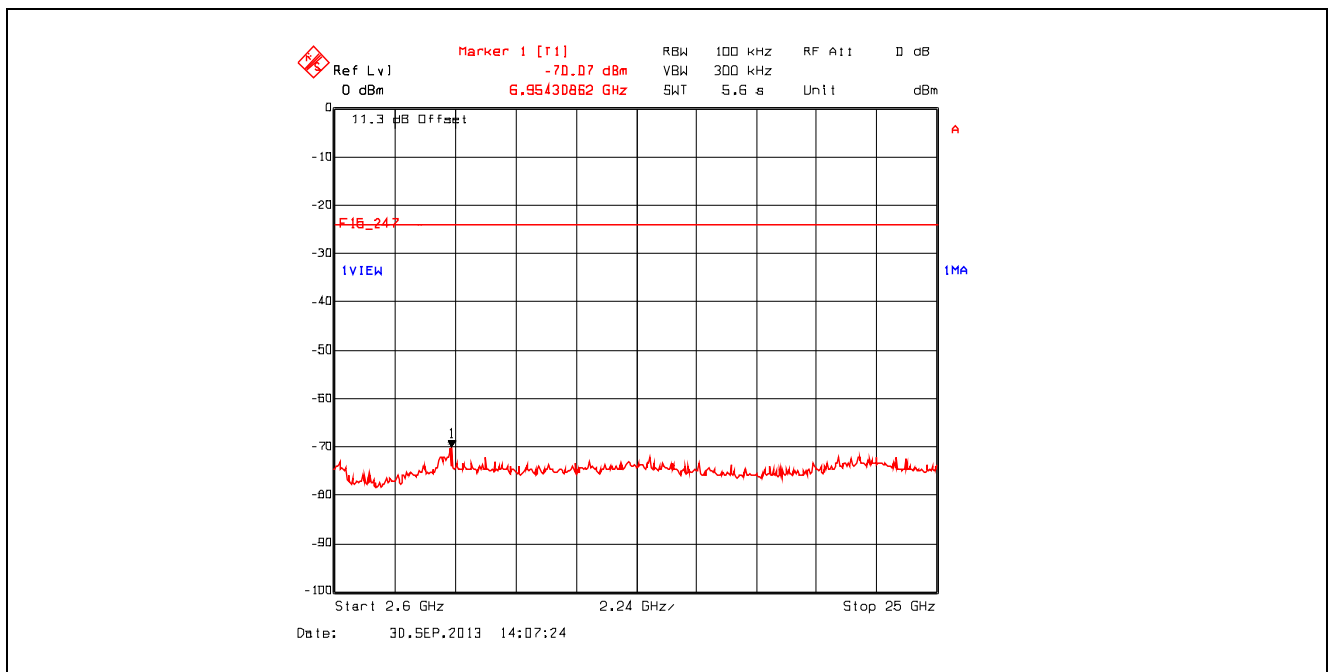

**5.3.4.3. Conducted Spurious Emissions – Restricted Bands**

Remark: Offset = Insertion Loss (11.3 dB) + Antenna Gain (2 dBi worst case) = 13. 3dB

**Plot 5.3.4.3.1. Conducted Spurious Emissions – Restricted Bands**  
 802.11b, 1 Mbps Data Rate, 2472 MHz, 5 dBm Power Setting, 9 kHz - 150 kHz, Peak Detector

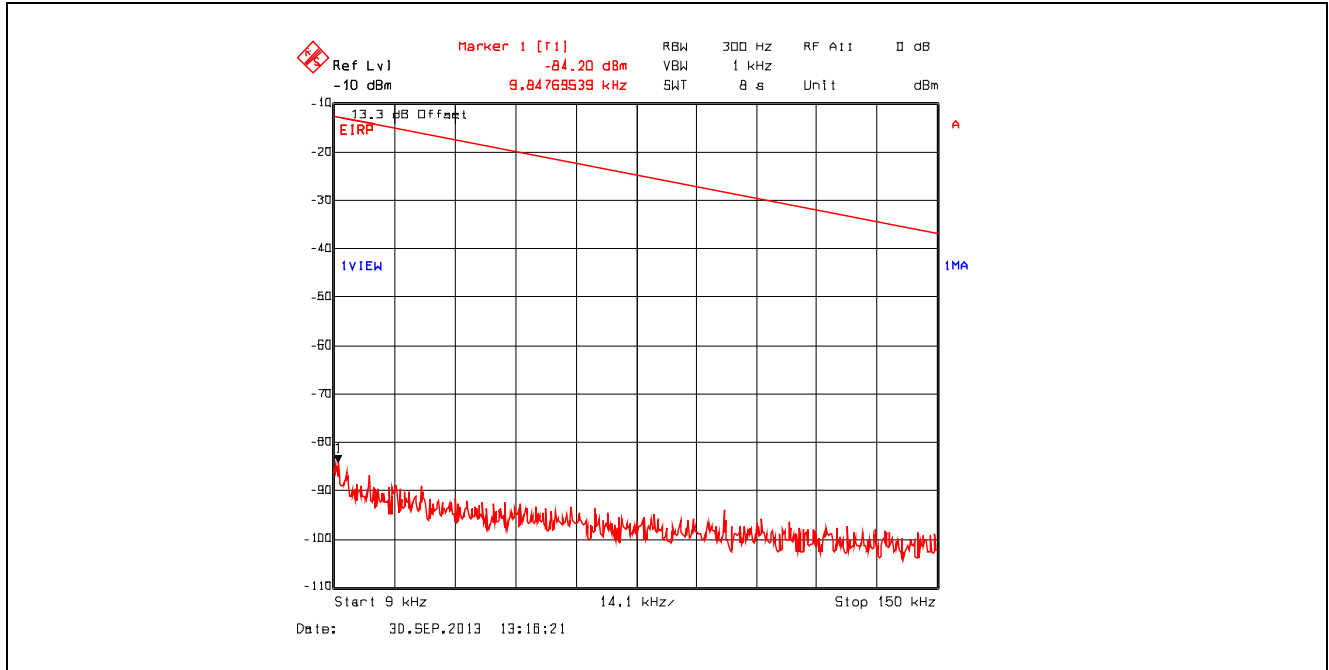

**Plot 5.3.4.3.2. Conducted Spurious Emissions – Restricted Bands**  
 802.11b, 1 Mbps Data Rate, 2472 MHz, 5 dBm Power Setting, 150 kHz - 30 MHz, Peak Detector

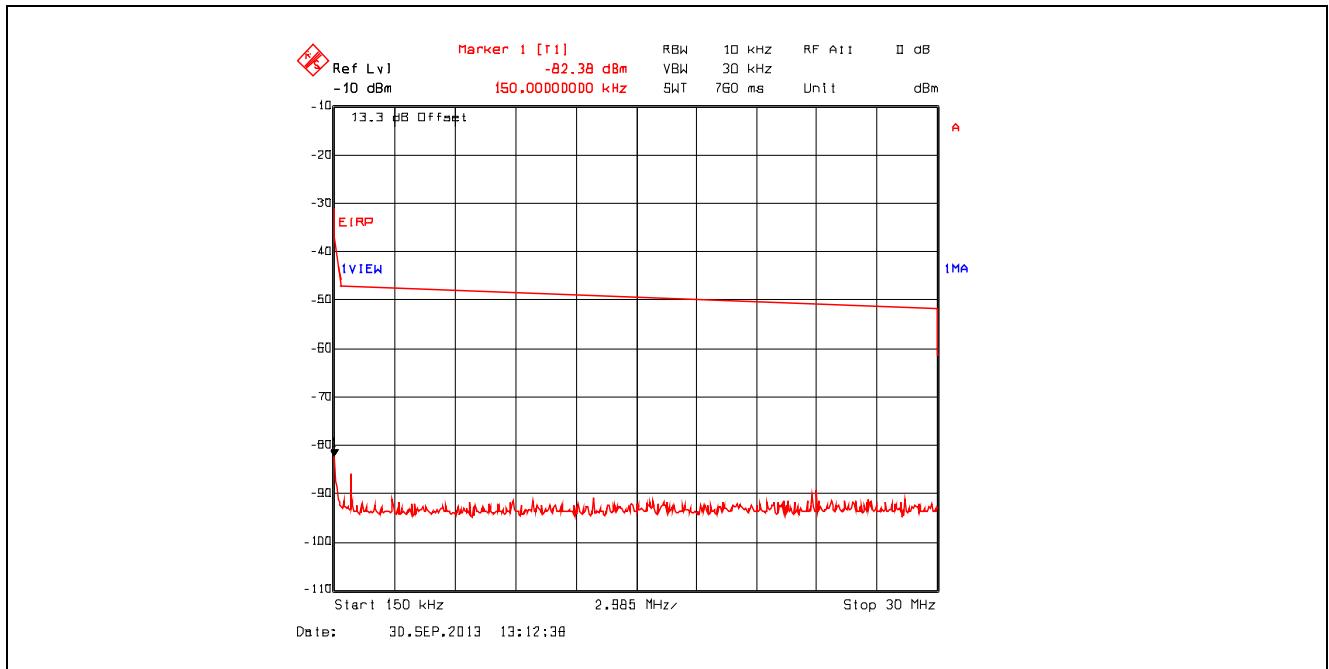

**Plot 5.3.4.3.3.** Conducted Spurious Emissions – Restricted Bands  
802.11b, 1 Mbps Data Rate, 2472 MHz, 5 dBm Power Setting, 30 MHz - 1 GHz, Peak Detector

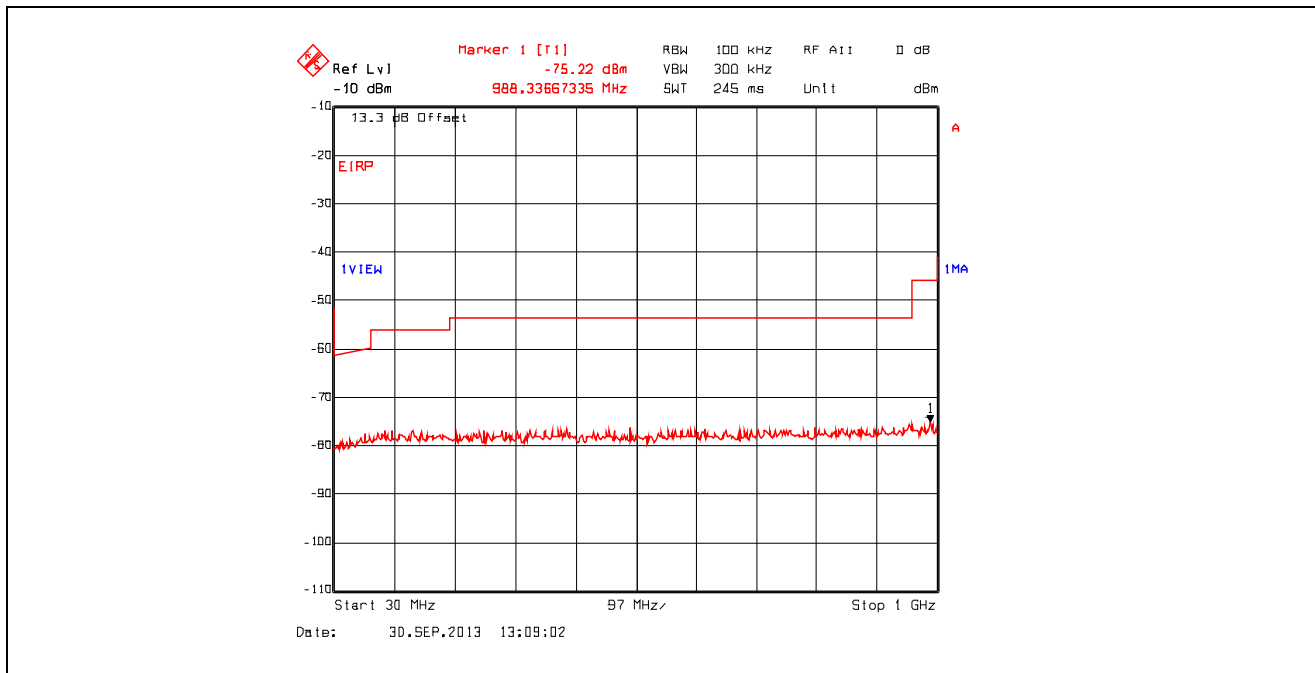

**Plot 5.3.4.3.4.** Conducted Spurious Emissions – Restricted Bands  
802.11b, 1 Mbps Data Rate, 2472 MHz, 5 dBm Power Setting, 1 GHz - 25 GHz, Power Average (RMS) Detector

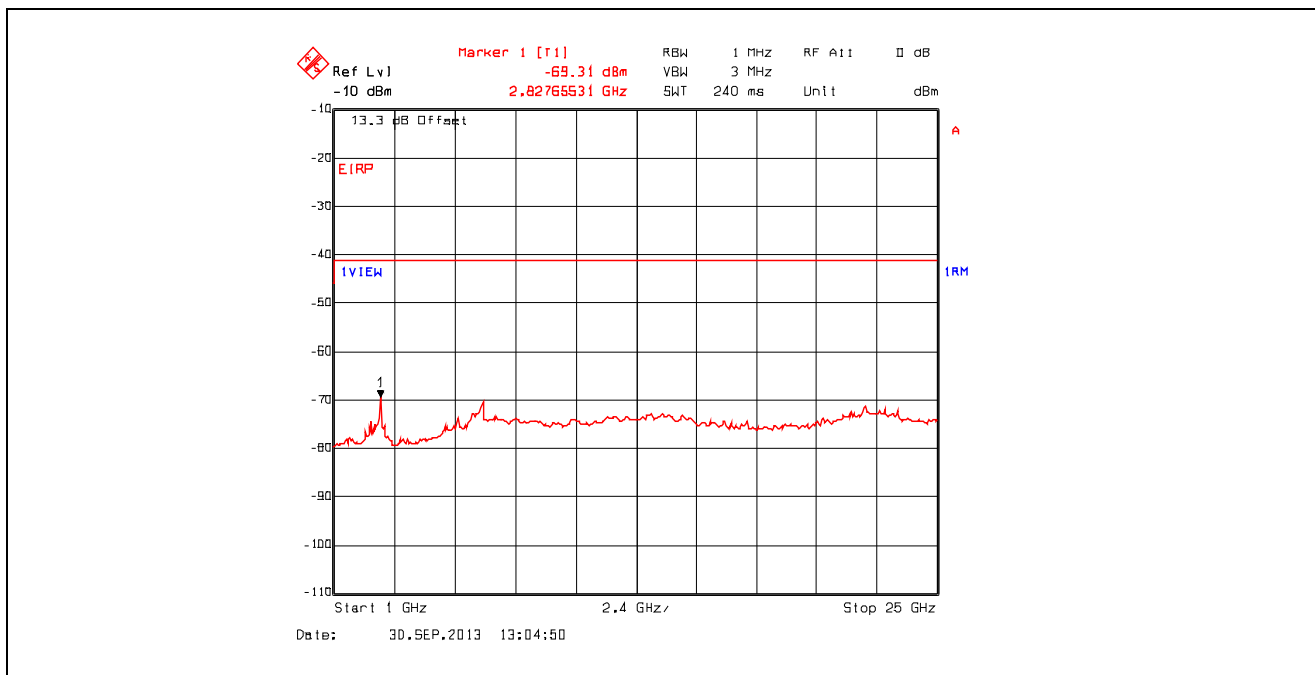

**Plot 5.3.4.3.5.** Conducted Spurious Emissions – Restricted Bands  
802.11b, 11 Mbps Data Rate, 2472 MHz, 5 dBm Power Setting, 9 kHz - 150 kHz, Peak Detector

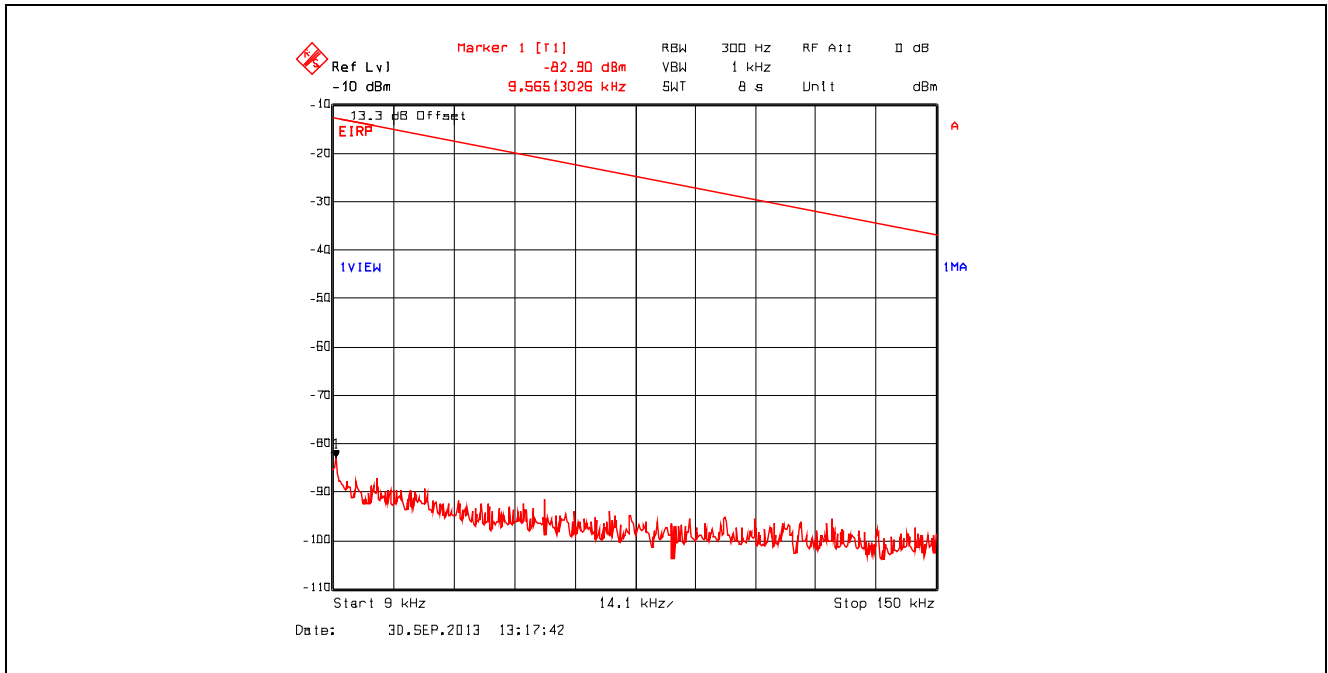

**Plot 5.3.4.3.6.** Conducted Spurious Emissions – Restricted Bands  
802.11b, 11 Mbps Data Rate, 2472 MHz, 5 dBm Power Setting, 150 kHz - 30 MHz, Peak Detector

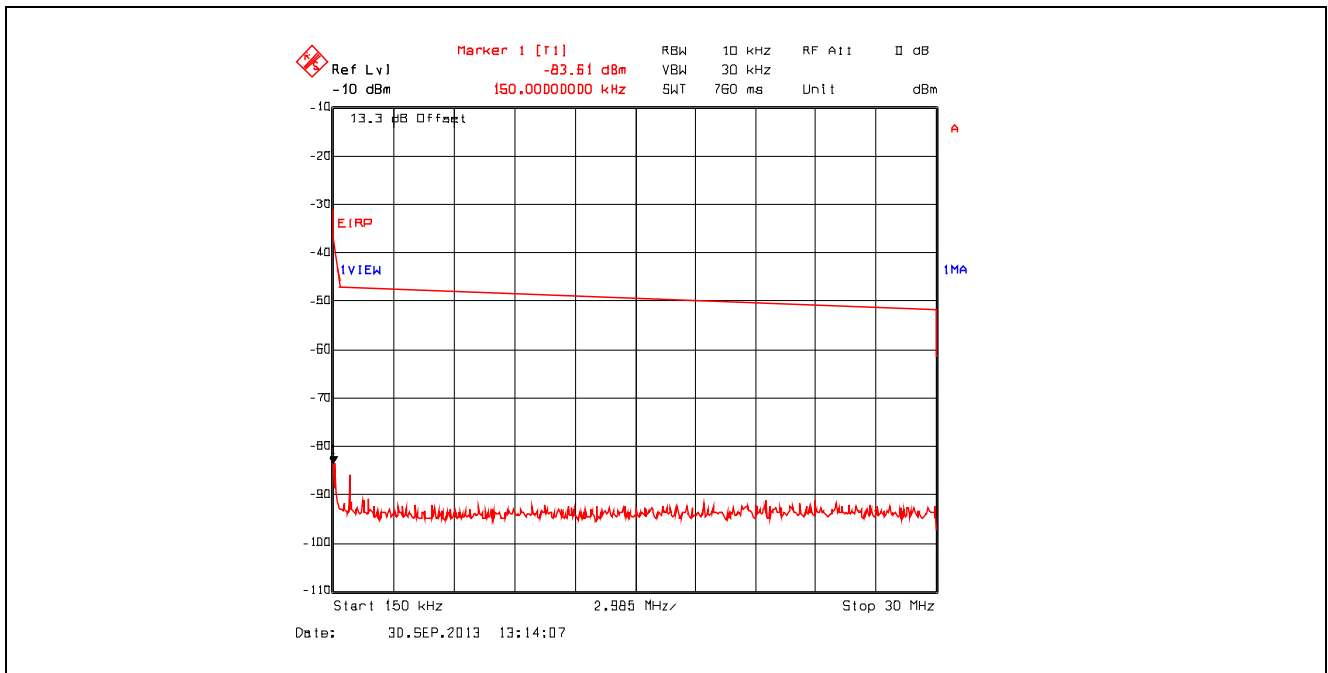

**Plot 5.3.4.3.7.** Conducted Spurious Emissions – Restricted Bands  
802.11b, 11 Mbps Data Rate, 2472 MHz, 5 dBm Power Setting, 30 MHz - 1 GHz, Peak Detector

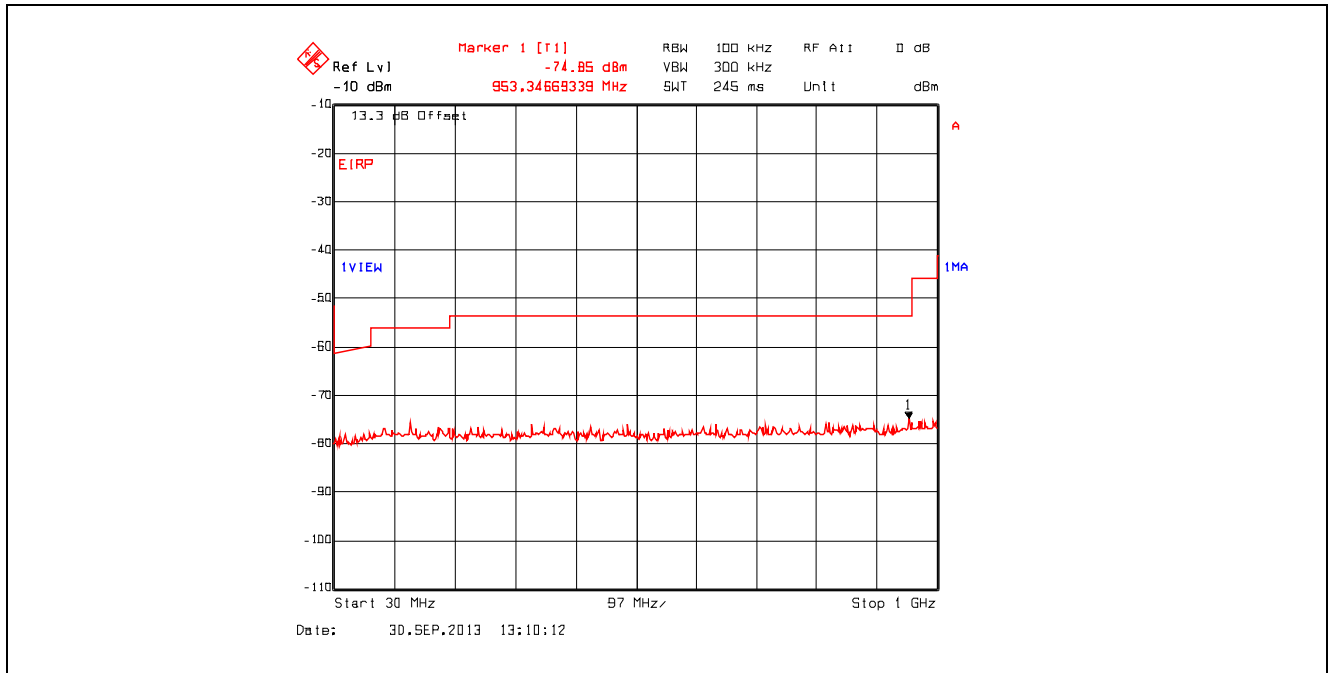

**Plot 5.3.4.3.8.** Conducted Spurious Emissions – Restricted Bands  
802.11b, 11 Mbps Data Rate, 2472 MHz, 5 dBm Power Setting, 1 GHz - 25 GHz, Power Average (RMS) Detector

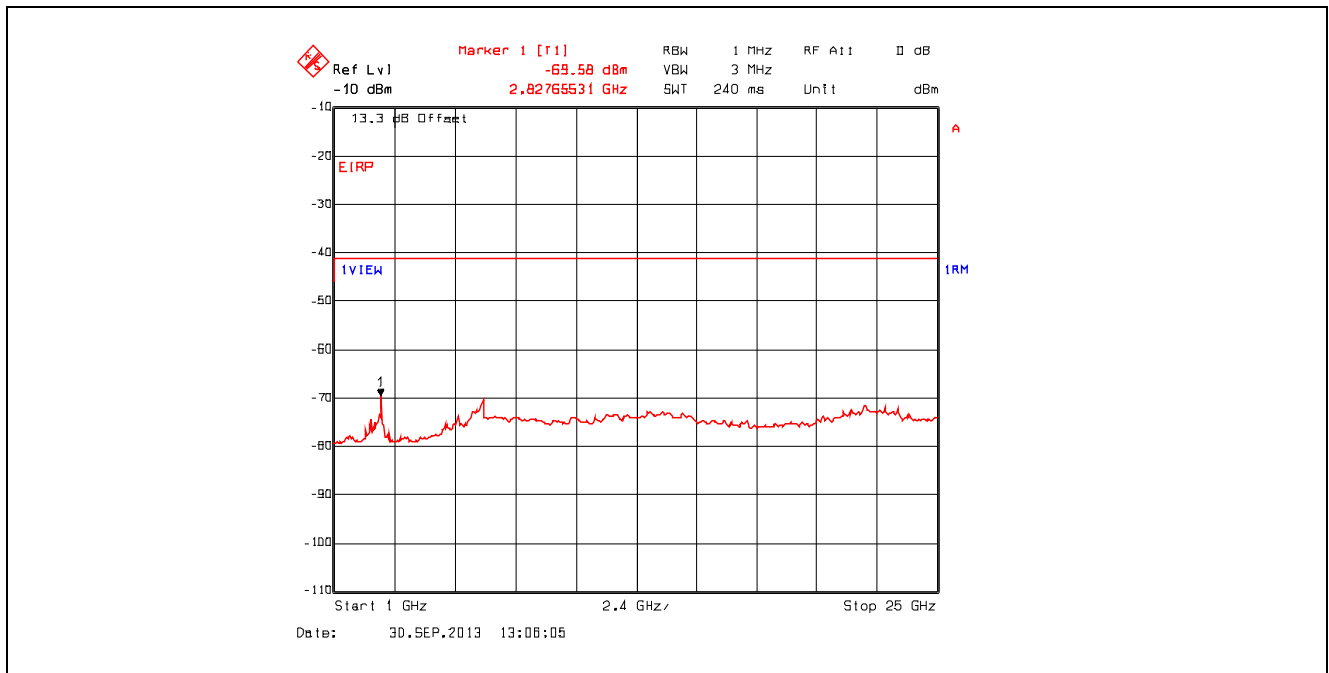

**Plot 5.3.4.3.9.** Conducted Spurious Emissions – Restricted Bands  
 802.11g, 6 Mbps Data Rate, 2472 MHz, 5 dBm Power Setting, 9 kHz - 150 kHz, Peak Detector

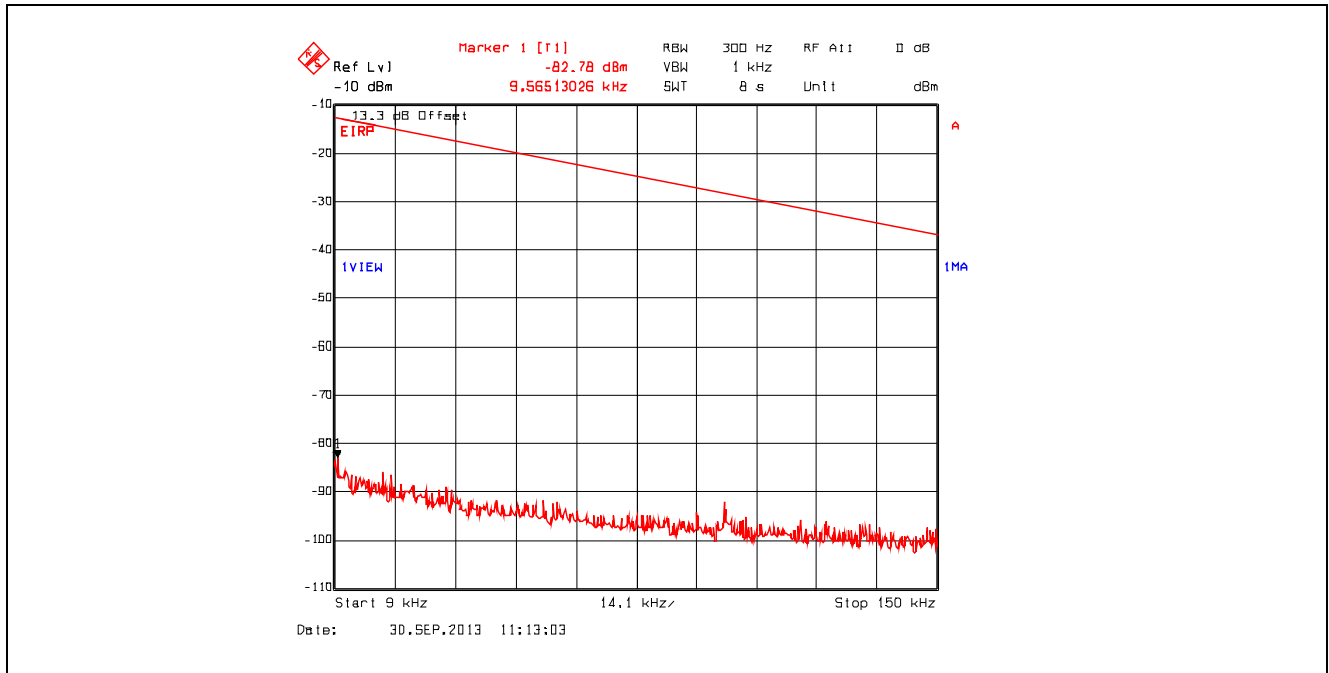

**Plot 5.3.4.3.10.** Conducted Spurious Emissions – Restricted Bands  
 802.11g, 6 Mbps Data Rate, 2472 MHz, 5 dBm Power Setting, 150 kHz - 30 MHz, Peak Detector

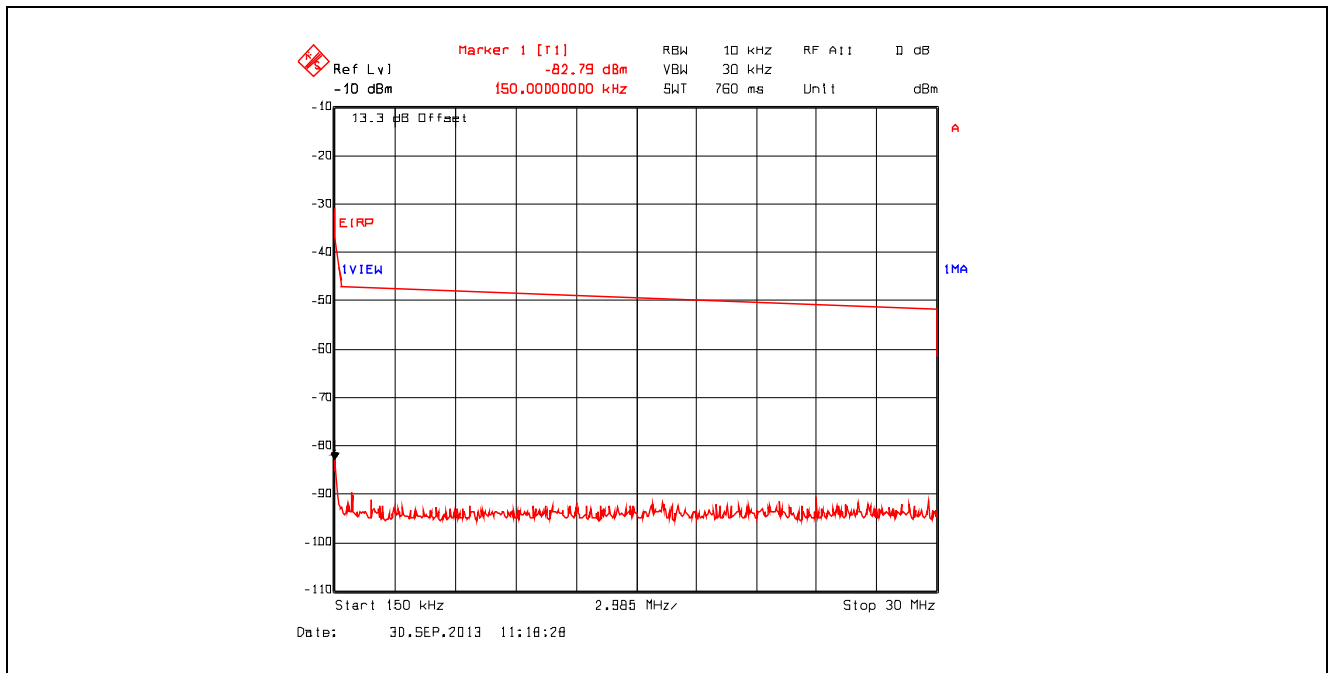

**Plot 5.3.4.3.11. Conducted Spurious Emissions – Restricted Bands**  
 802.11g, 6 Mbps Data Rate, 2472 MHz, 5 dBm Power Setting, 30 MHz - 1 GHz, Peak Detector

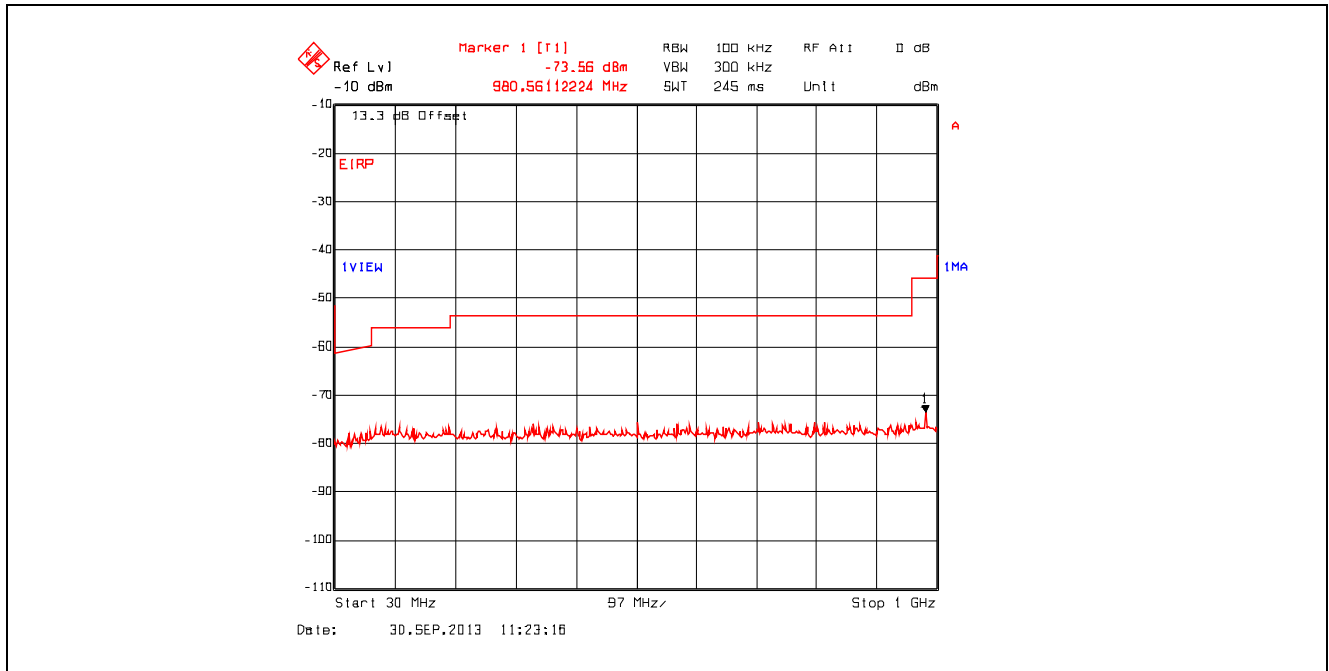

**Plot 5.3.4.3.12. Conducted Spurious Emissions – Restricted Bands**  
 802.11g, 6 Mbps Data Rate, 2472 MHz, 5 dBm Power Setting, 1 GHz - 25 GHz, Power Average (RMS) Detector

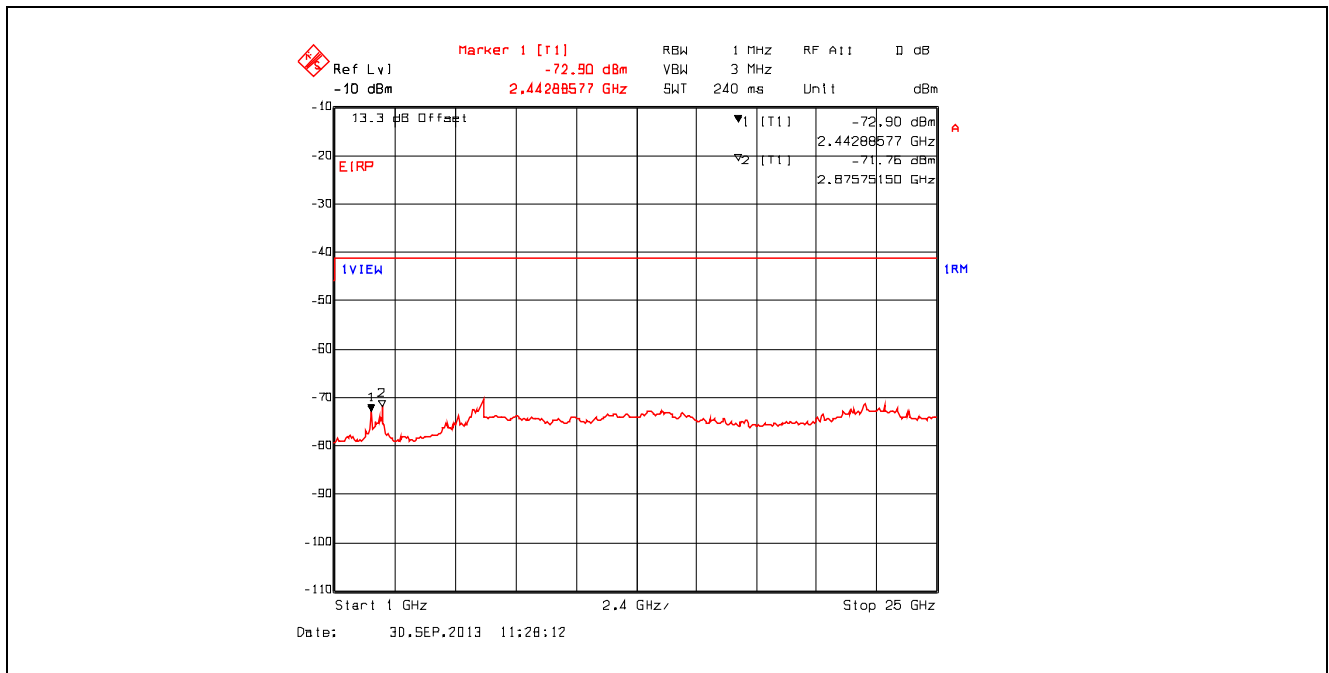

**Plot 5.3.4.3.13.** Conducted Spurious Emissions – Restricted Bands  
 802.11g, 54 Mbps Data Rate, 2472 MHz, 5 dBm Power Setting, 9 kHz - 150 kHz, Peak Detector

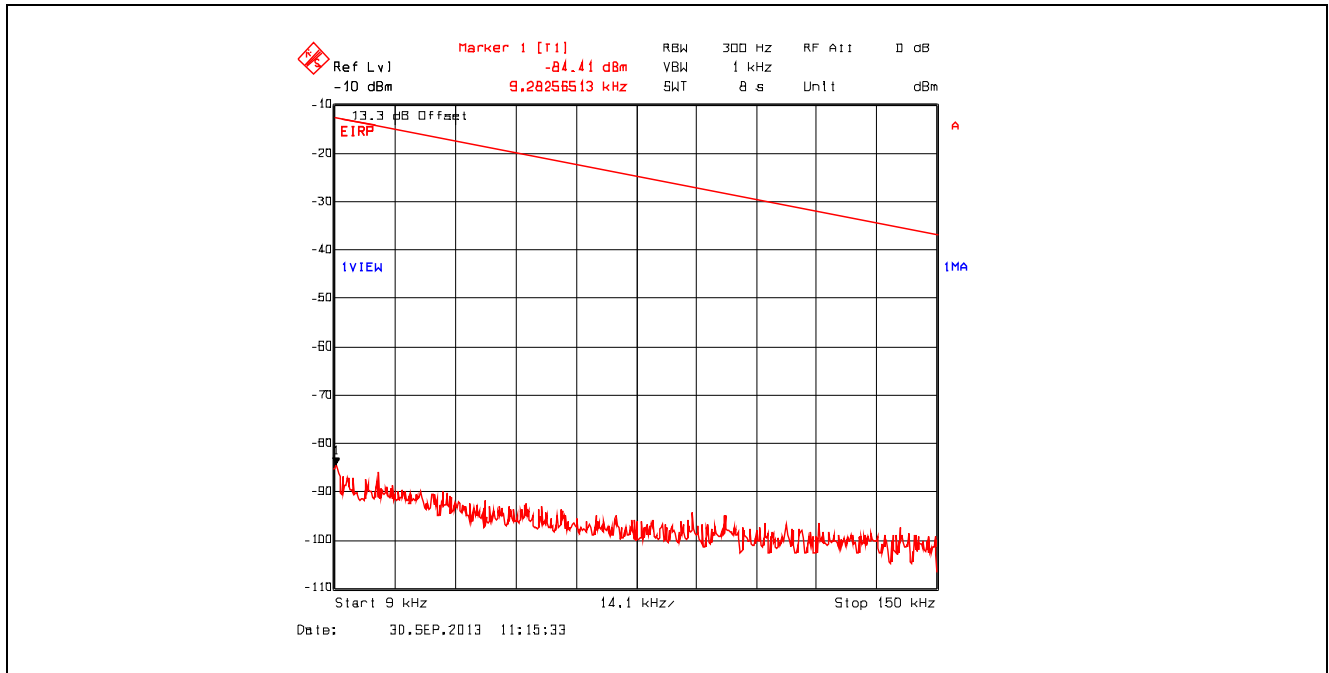

**Plot 5.3.4.3.14.** Conducted Spurious Emissions – Restricted Bands  
 802.11g, 54 Mbps Data Rate, 2472 MHz, 5 dBm Power Setting, 150 kHz - 30 MHz, Peak Detector

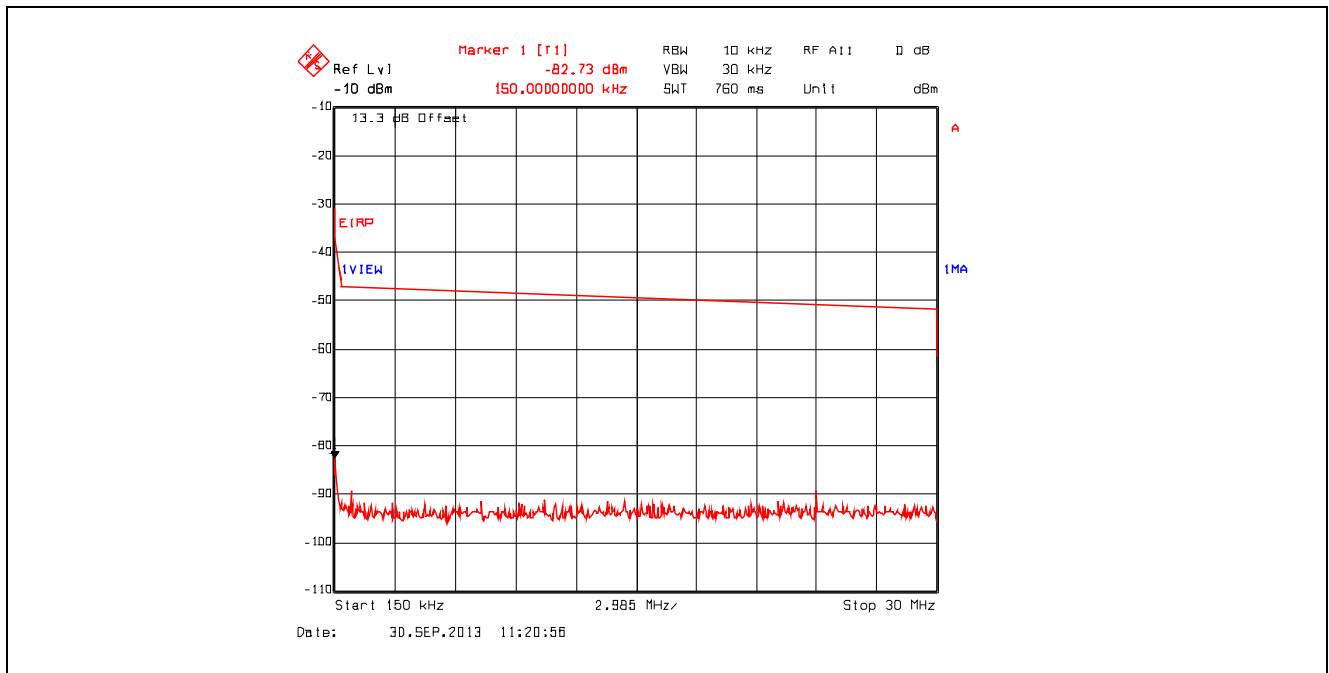



**Plot 5.3.4.3.15. Conducted Spurious Emissions – Restricted Bands**  
 802.11g, 54 Mbps Data Rate, 2472 MHz, 5 dBm Power Setting, 30 MHz - 1 GHz, Peak Detector

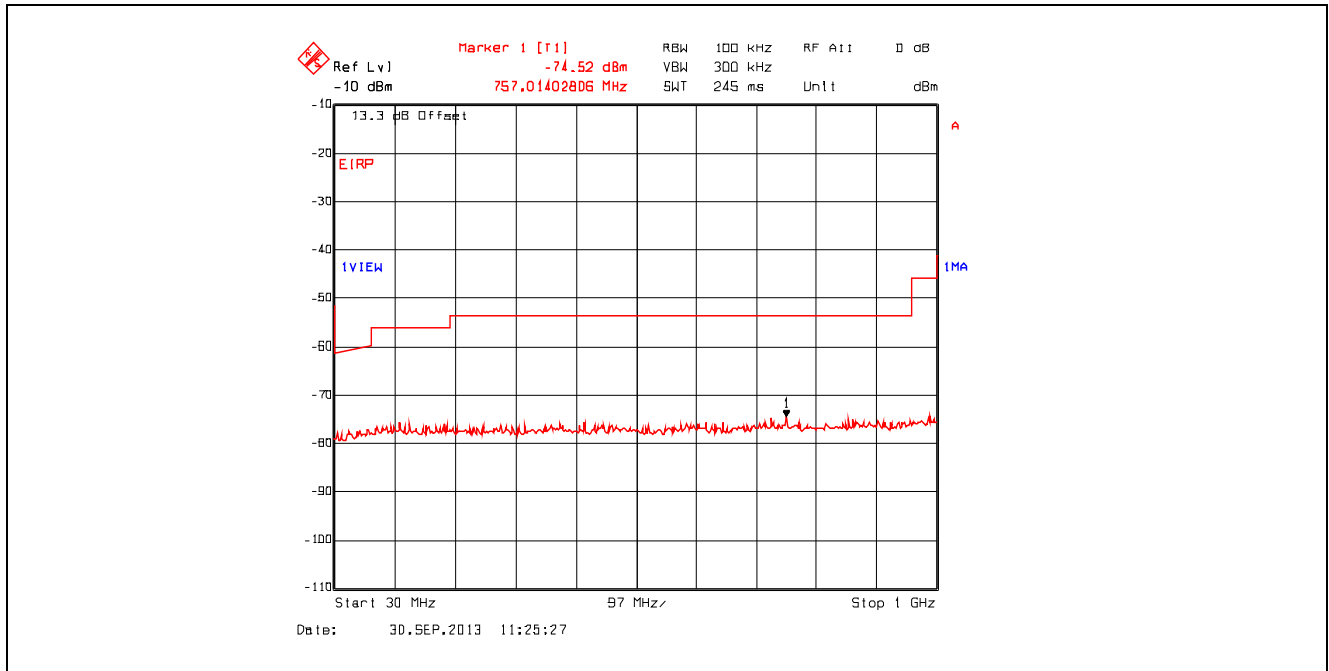

**Plot 5.3.4.3.16. Conducted Spurious Emissions – Restricted Bands**  
 802.11g, 54 Mbps Data Rate, 2472 MHz, 5 dBm Power Setting, 1 GHz - 25 GHz, Power Average (RMS) Detector

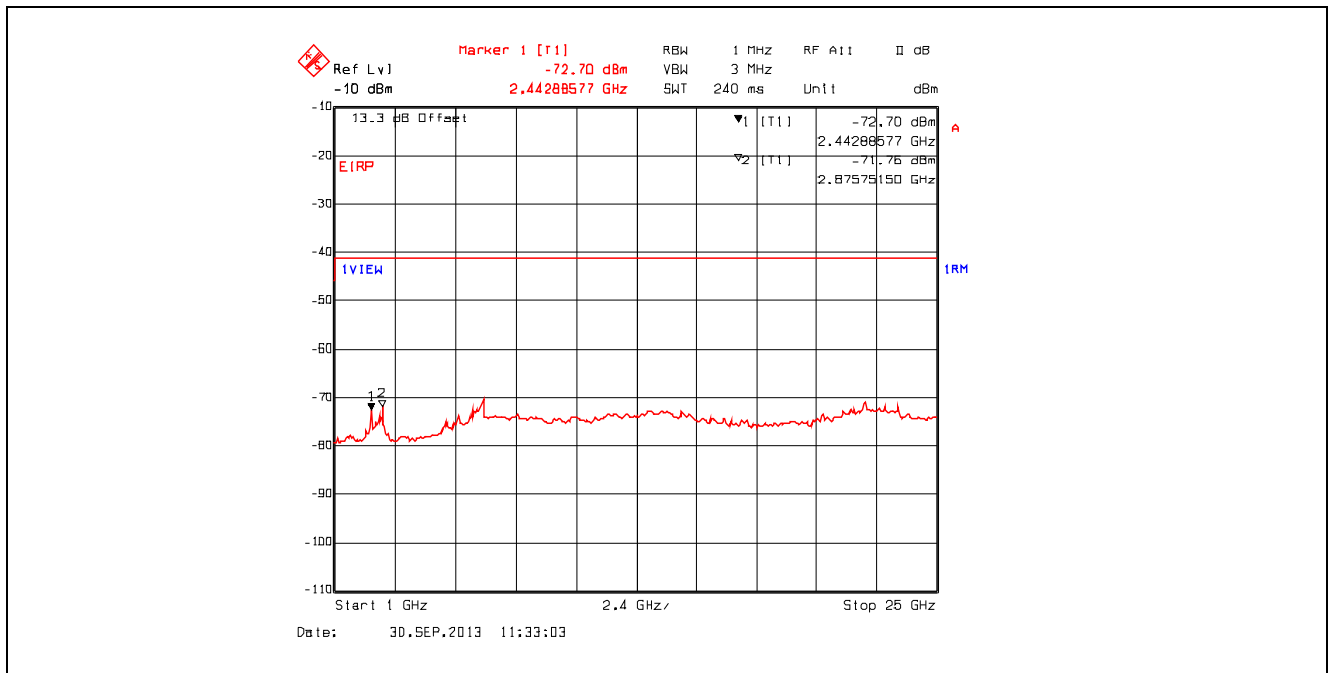

**Plot 5.3.4.3.17.** Conducted Spurious Emissions – Restricted Bands  
802.11n, 6.5 Mbps Data Rate, 2472 MHz, 5 dBm Power Setting, 9 kHz - 150 kHz, Peak Detector

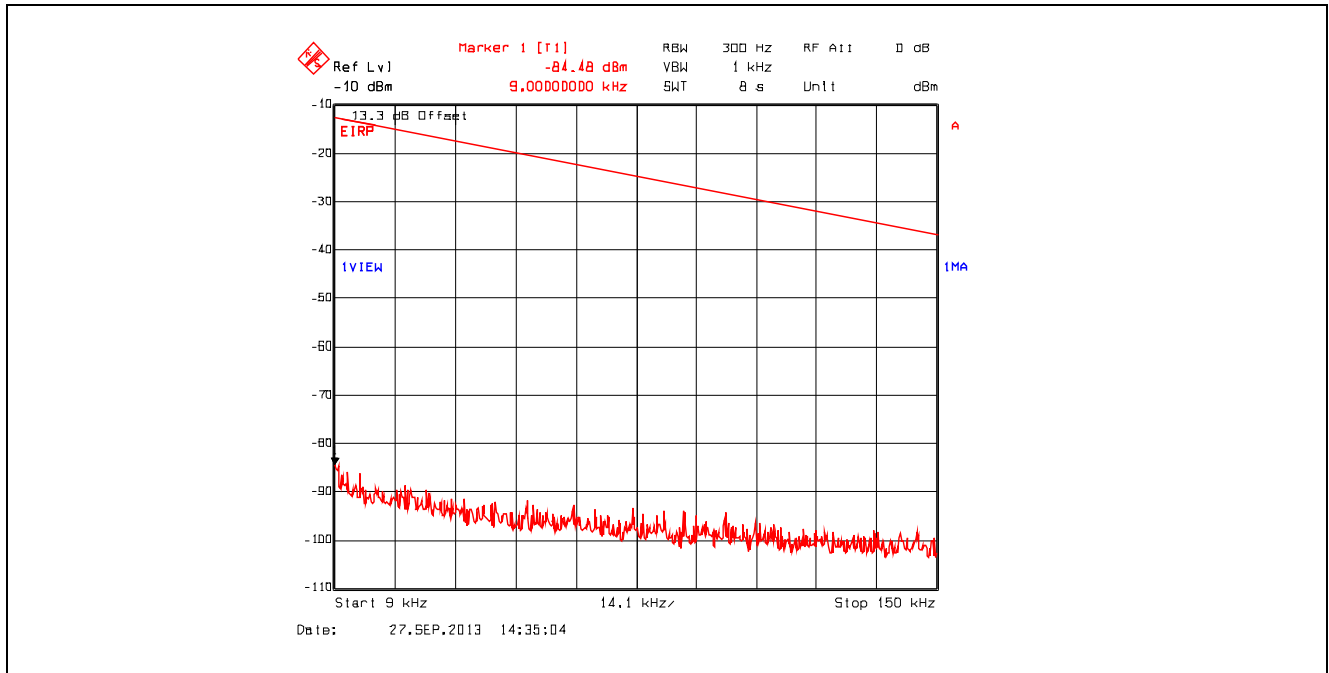

**Plot 5.3.4.3.18.** Conducted Spurious Emissions – Restricted Bands  
802.11n, 6.5 Mbps Data Rate, 2472 MHz, 5 dBm Power Setting, 150 kHz - 30 MHz, Peak Detector

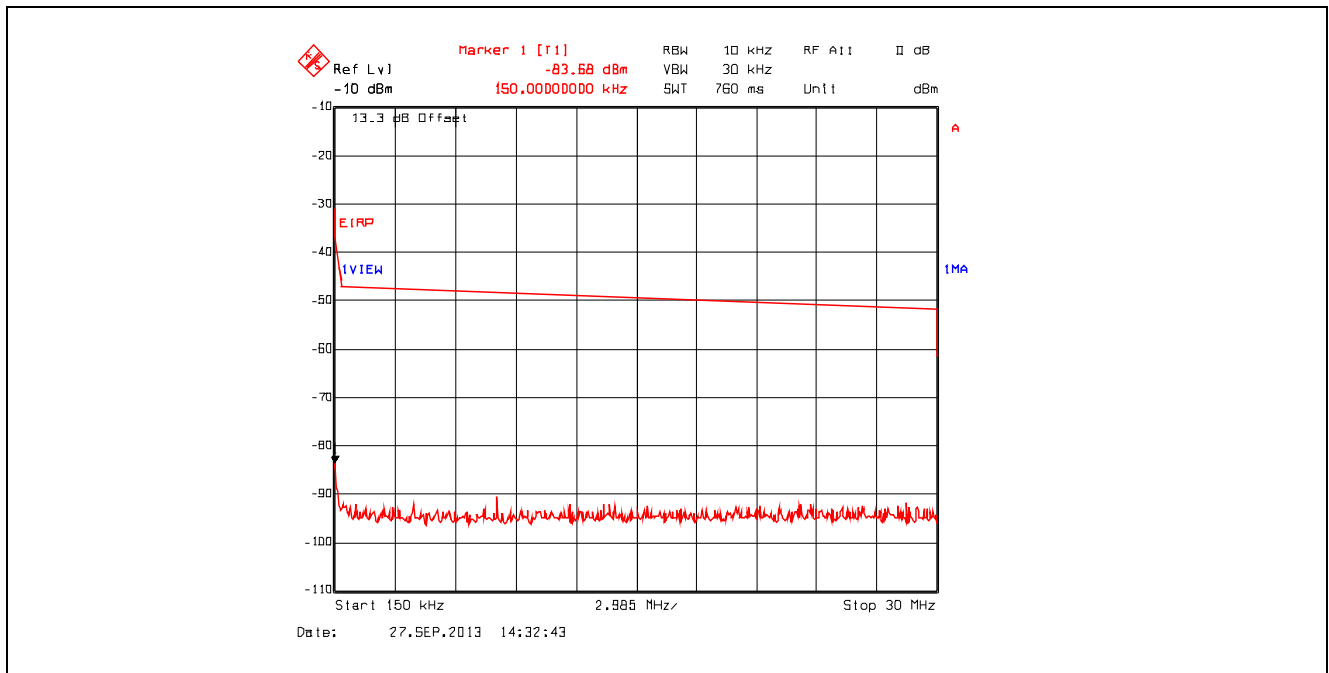

**Plot 5.3.4.3.19.** Conducted Spurious Emissions – Restricted Bands  
 802.11n, 6.5 Mbps Data Rate, 2472 MHz, 5 dBm Power Setting, 30 MHz - 1 GHz, Peak Detector

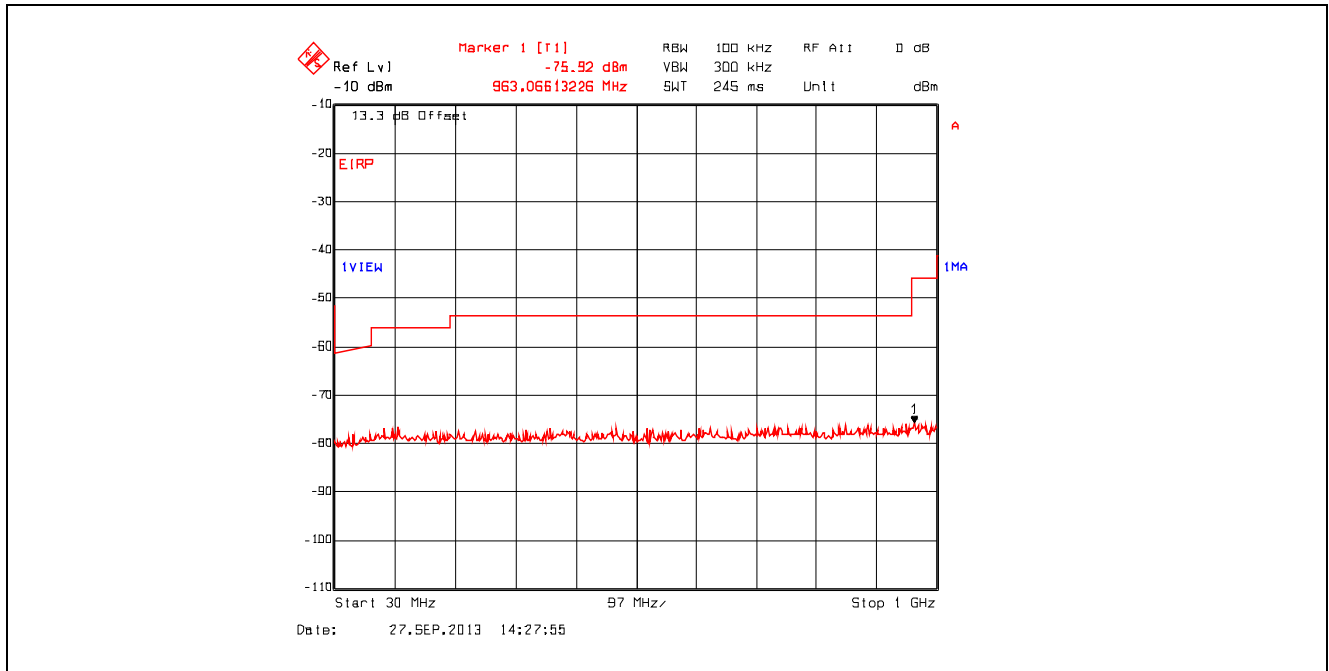

**Plot 5.3.4.3.20.** Conducted Spurious Emissions – Restricted Bands  
 802.11n, 6.5 Mbps Data Rate, 2472 MHz, 5 dBm Power Setting, 1 GHz - 25 GHz, Power Average (RMS) Detector

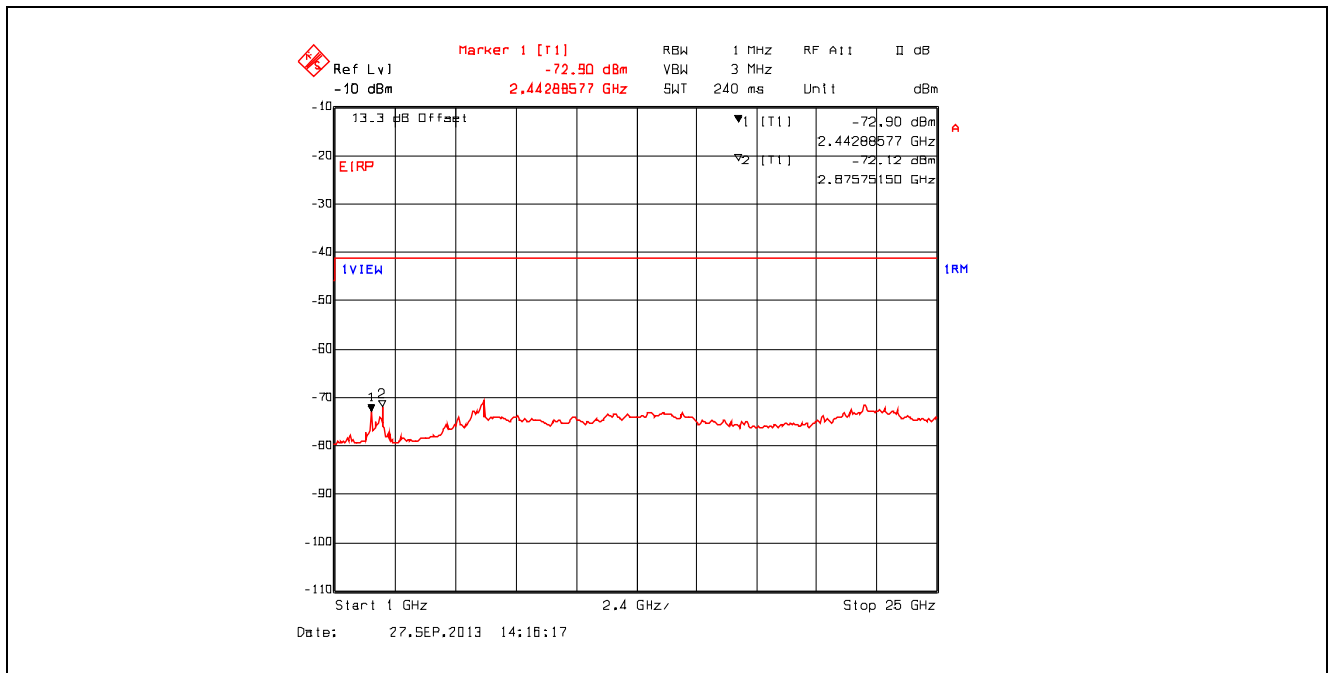

**Plot 5.3.4.3.21. Conducted Spurious Emissions – Restricted Bands**  
802.11n, 65 Mbps Data Rate, 2472 MHz, 5 dBm Power Setting, 9 kHz - 150 kHz, Peak Detector

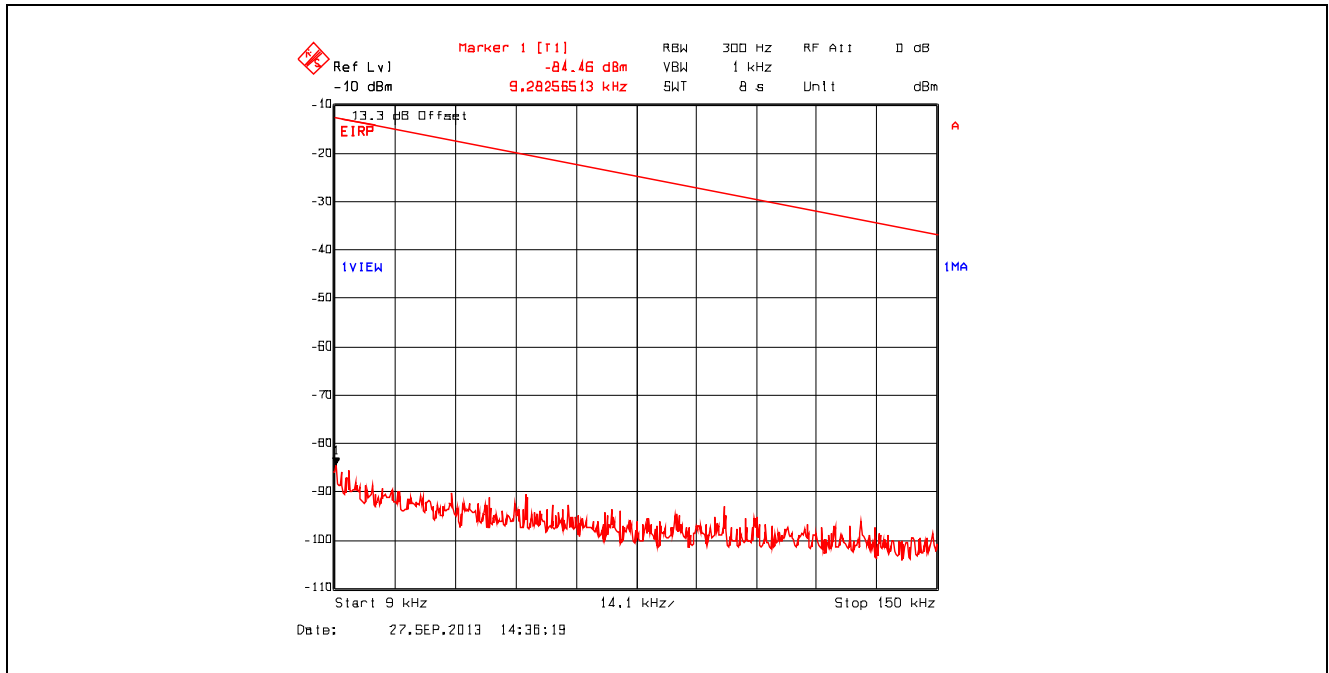

**Plot 5.3.4.3.22. Conducted Spurious Emissions – Restricted Bands**  
802.11n, 65 Mbps Data Rate, 2472 MHz, 5 dBm Power Setting, 150 kHz - 30 MHz, Peak Detector

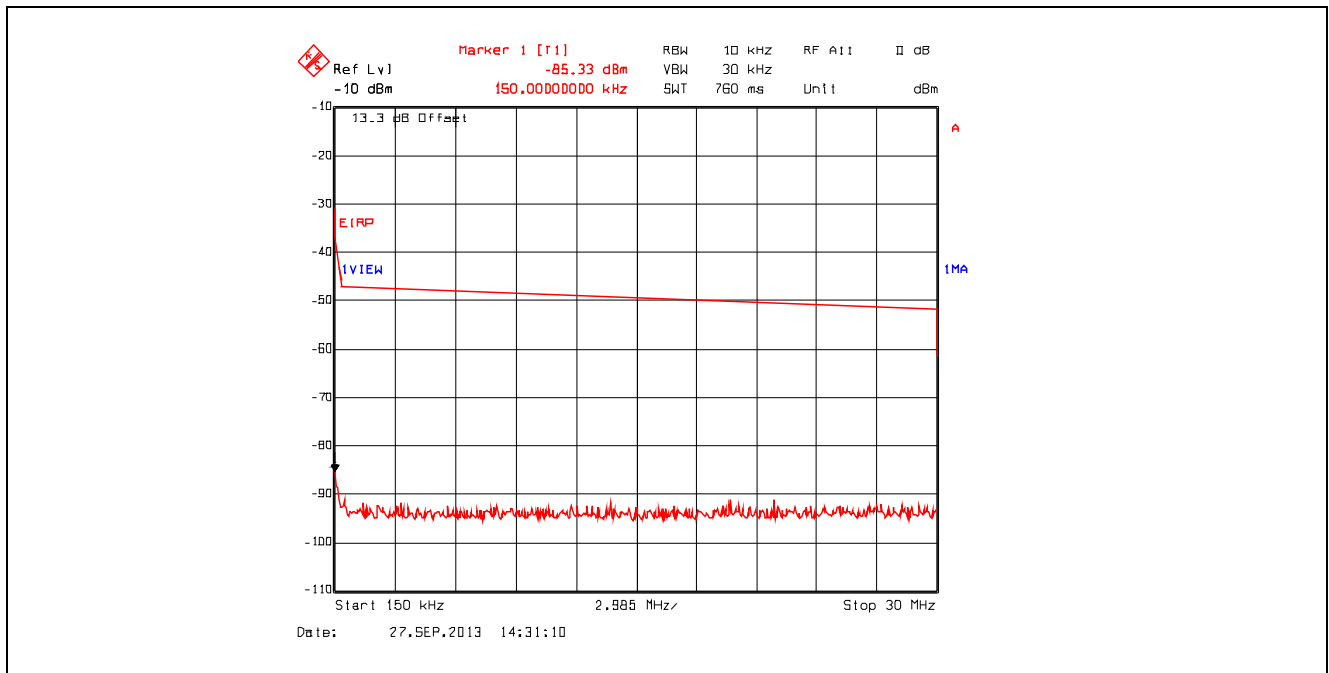

**Plot 5.3.4.3.23.** Conducted Spurious Emissions – Restricted Bands  
802.11n, 65 Mbps Data Rate, 2472 MHz, 5 dBm Power Setting, 30 MHz - 1 GHz, Peak Detector

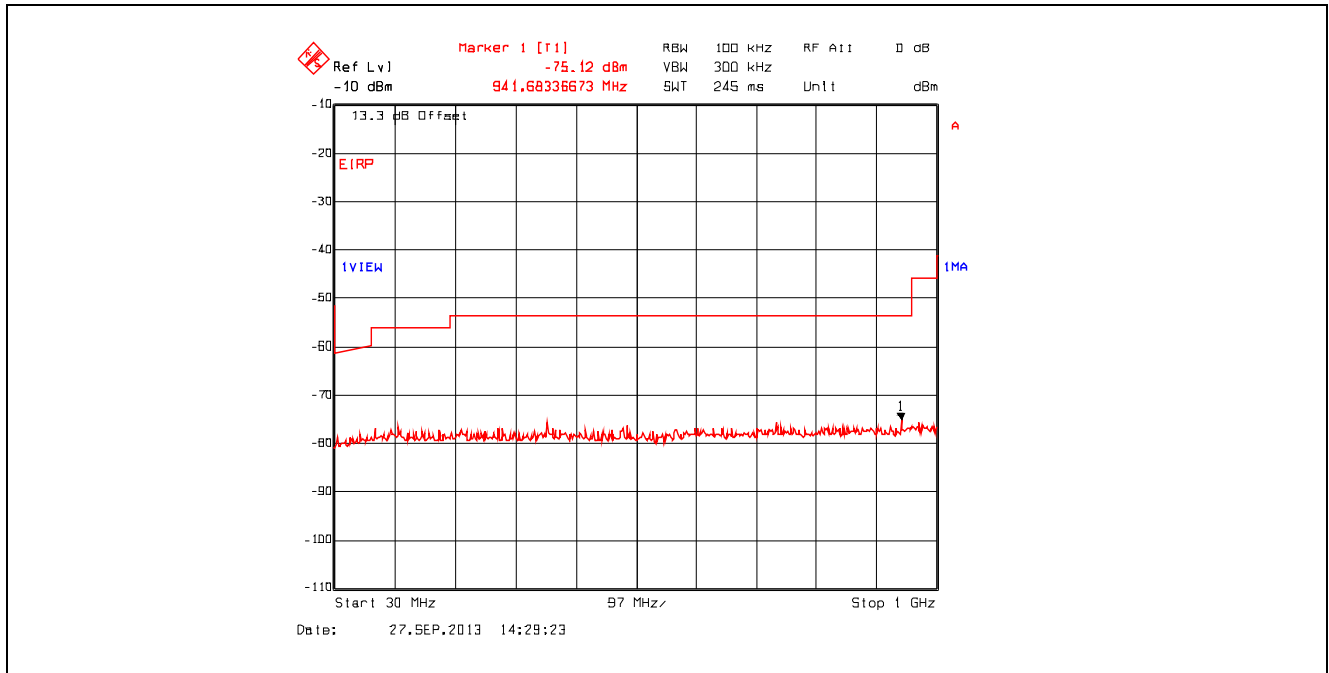

**Plot 5.3.4.3.24.** Conducted Spurious Emissions – Restricted Bands  
802.11n, 65 Mbps Data Rate, 2472 MHz, 5 dBm Power Setting, 1 GHz - 25 GHz, Power Average (RMS) Detector

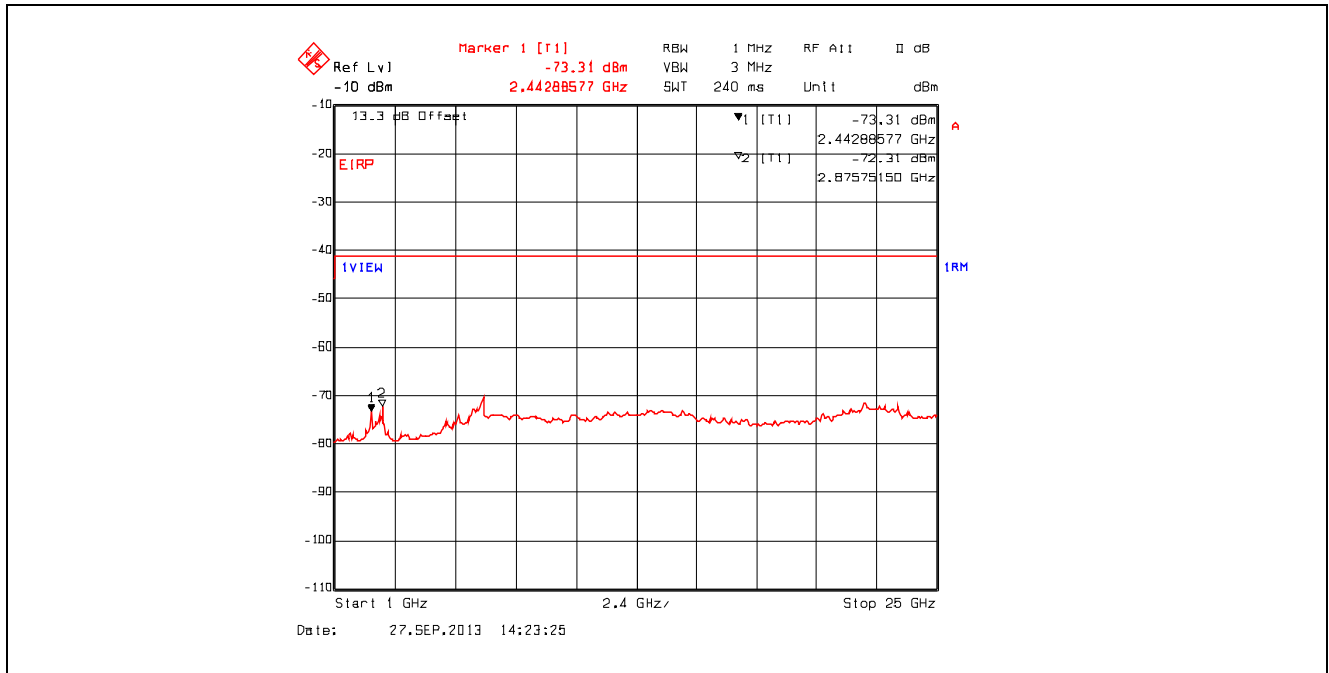

**5.4. TRANSMITTER SPURIOUS RADIATED EMISSIONS AT 3 METERS [§§ 15.247(d), 15.209 & 15.205]**

**5.4.1. Limit(s)**

§ 15.247 (d): In any 100 kHz bandwidth outside the frequency band in which the spread spectrum or digitally modulated intentional radiator is operating, the radio frequency power that is produced by the intentional radiator shall be at least 20 dB below that in the 100 kHz bandwidth within the band that contains the highest level of the desired power, based on either an RF conducted or a radiated measurement, provided the transmitter demonstrates compliance with the peak conducted power limits. If the transmitter complies with the conducted power limits based on the use of RMS averaging over a time interval, as permitted under paragraph (b)(3) of this section, the attenuation required under this paragraph shall be 30 dB instead of 20 dB. Attenuation below the general limits specified in Section 15.209(a) is not required. In addition, radiated emissions which fall in the restricted bands, as defined in Section 15.205(a), must also comply with the radiated emission limits specified in Section 15.209(a) (see Section 15.205(c)).

**Section 15.205(a) - Restricted Bands of Operation**

MHz	MHz	MHz	GHz
0.090–0.110	16.42–16.423	399.9–410	4.5–5.15
<sup>1</sup> 0.495–0.505	16.69475–16.69525	608–614	5.35–5.46
2.1735–2.1905	16.80425–16.80475	960–1240	7.25–7.75
4.125–4.128	25.5–25.67	1300–1427	8.025–8.5
4.17725–4.17775	37.5–38.25	1435–1626.5	9.0–9.2
4.20725–4.20775	73–74.6	1645.5–1646.5	9.3–9.5
6.215–6.218	74.8–75.2	1660–1710	10.6–12.7
6.26775–6.26825	108–121.94	1718.8–1722.2	13.25–13.4
6.31175–6.31225	123–138	2200–2300	14.47–14.5
8.291–8.294	149.9–150.05	2310–2390	15.35–16.2
8.362–8.366	156.52475–156.52525	2483.5–2500	17.7–21.4
8.37625–8.38675	156.7–156.9	2655–2900	22.01–23.12
8.41425–8.41475	162.0125–167.17	3260–3267	23.6–24.0
12.29–12.293	167.72–173.2	3332–3339	31.2–31.8
12.51975–12.52025	240–285	3345.8–3358	36.43–36.5
12.57675–12.57725	322–335.4	3600–4400	( <sup>2</sup> )
13.36–13.41			

<sup>1</sup> Until February 1, 1999, this restricted band shall be 0.490–0.510 MHz.  
<sup>2</sup> Above 38.6

**Section 15.209(a)  
 -- Field Strength Limits within Restricted Frequency Bands --**

Frequency (MHz)	Field Strength (microvolts/meter)	Measurement Distance (meters)
0.009 - 0.490	2,400 / F (kHz)	300
0.490 - 1.705	24,000 / F (kHz)	30
1.705 - 30.0	30	30
30 - 88	100	3
88 - 216	150	3
216 - 960	200	3
Above 960	500	3

**5.4.2. Method of Measurements**

ANSI C63.10

**5.4.3. Test Arrangement**

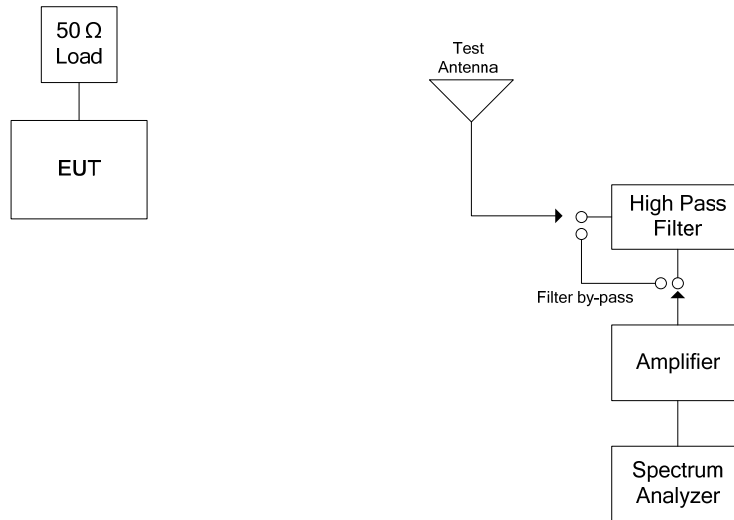

**5.4.4. Test Data**

**Remarks:**

- All spurious emissions that are in excess of 20 dB below the specified limit shall be recorded.
- EUT shall be tested in three orthogonal positions.
- The following test results are the worst-case measurements.

Fundamental Frequency:		2472 MHz					
Test Frequency Range:		30 MHz – 25 GHz					
Frequency (MHz)	RF Peak Level (dBμV/m)	RF Avg Level (dBμV/m)	Antenna Plane (H/V)	Limit 15.209 (dBμV/m)	Limit 15.247 (dBμV/m)	Margin (dB)	Pass/Fail
The harmonics and spurious emissions are more than 20 dB below the applicable limits.							

**EXHIBIT 6. TEST EQUIPMENT LIST**

Test Instruments	Manufacturer	Model No.	Serial No.	Frequency Range	Cal. Due Date
Spectrum Analyzer	Rohde & Schwarz	FSEK30	100077	20Hz–40 GHz	02 Nov 2013
Attenuator	Pasternack	PE7024-10	-	DC–26.5 GHz	Cal on use
DC Block	Hewlett Packard	11742A	12460	0.045–26.5 GHz	Cal on use
High Pass Filter	K & L	11SH10-4000/T12000	4	Cut off 2400 MHz	Cal on use
Band Pass Filter	Micro-Tronics	BRM50701	105	Cut off 2.4-2.483 GHz	Cal on use
RF Amplifier	Hewlett Packard	84498	3008A00769	1 – 26.5 GHz	25 Jun 2014
Biconi-Log Antenna	ETS Lindgren	3142C	34792	26 – 3000 MHz	26 Jun 2014
Horn Antenna	ETS Lindgren	3115	6570	1 -18 GHz	07 Jun 2014
Horn Antenna	EMCO	3160-09	118385	18 – 26.5 GHz	30 July 2014

**ULTRATECH GROUP OF LABS**

3000 Bristol Circle, Oakville, Ontario, Canada L6H 6G4  
Tel. #: 905-829-1570, Fax. #: 905-829-8050, Email: [vic@ultratech-labs.com](mailto:vic@ultratech-labs.com), Website: <http://www.ultratech-labs.com>

File #: TEK-728F15C247-7545MBW

October 21, 2013

*All test results contained in this engineering test report are traceable to National Institute of Standards and Technology (NIST)*



**EXHIBIT 7. MEASUREMENT UNCERTAINTY**

The measurement uncertainties stated were calculated in accordance with the requirements of CISPR 16-4-2 @ IEC:2003 and JCGM 100:2008 (GUM 1995) – Guide to the Expression of Uncertainty in Measurement.

**7.1. LINE CONDUCTED EMISSION MEASUREMENT UNCERTAINTY**

	Line Conducted Emission Measurement Uncertainty (9 kHz – 30 MHz):	Measured	Limit
<b>u<sub>c</sub></b>	<b>Combined standard uncertainty:</b> $u_c(y) = \sqrt{\sum_{i=1}^m u_i^2(y)}$	<b>± 1.44</b>	<b>± 1.8</b>
<b>U</b>	<b>Expanded uncertainty U:</b> U = 2u <sub>c</sub> (y)	<b>± 2.89</b>	<b>± 3.6</b>

**7.2. RADIATED EMISSION MEASUREMENT UNCERTAINTY**

	Radiated Emission Measurement Uncertainty @ 3m, Horizontal (30-1000 MHz):	Measured (dB)	Limit (dB)
<b>u<sub>c</sub></b>	<b>Combined standard uncertainty:</b> $u_c(y) = \sqrt{\sum_{i=1}^m u_i^2(y)}$	<b>± 2.39</b>	<b>± 2.6</b>
<b>U</b>	<b>Expanded uncertainty U:</b> U = 2u <sub>c</sub> (y)	<b>± 4.79</b>	<b>± 5.2</b>

	Radiated Emission Measurement Uncertainty @ 3m, Vertical (30-1000 MHz):	Measured (dB)	Limit (dB)
<b>u<sub>c</sub></b>	<b>Combined standard uncertainty:</b> $u_c(y) = \sqrt{\sum_{i=1}^m u_i^2(y)}$	<b>± 2.39</b>	<b>± 2.6</b>
<b>U</b>	<b>Expanded uncertainty U:</b> U = 2u <sub>c</sub> (y)	<b>± 4.78</b>	<b>± 5.2</b>

	Radiated Emission Measurement Uncertainty @ 3 m, Horizontal & Vertical (1 – 18 GHz):	Measured (dB)	Limit (dB)
<b>u<sub>c</sub></b>	<b>Combined standard uncertainty:</b> $u_c(y) = \sqrt{\sum_{i=1}^m u_i^2(y)}$	<b>± 1.87</b>	<b>Under consideration</b>
<b>U</b>	<b>Expanded uncertainty U:</b> U = 2u <sub>c</sub> (y)	<b>± 3.75</b>	<b>Under consideration</b>