

The Testcenter facility 'Dosimetric Test Lab' within IMST GmbH is accredited by the German National 'Deutsche Akkreditierungsstelle GmbH (DAkkS)' for testing according to the scope as listed in the accreditation certificate: D-PL-12139-01-01.

Appendix for the Report

Dosimetric Assessment of the PSION 7545MBW (FCC ID: GM37545MBW) (IC: 2739D-7545MBW)

According to the FCC Requirements

Calibration Data

February 16, 2012

IMST GmbH
Carl-Friedrich-Gauß-Str. 2
D-47475 Kamp-Lintfort

Customer
7layers AG
Borsigstrasse 11
D-40880 Ratingen



Accredited by the Swiss Accreditation Service (SAS)

Accreditation No.: **SCS 108**

The Swiss Accreditation Service is one of the signatories to the EA
Multilateral Agreement for the recognition of calibration certificates

Client **IMST**

Certificate No: **ET3-1669_Feb11**

CALIBRATION CERTIFICATE

Object **ET3DV6R - SN:1669**

Calibration procedure(s) **QA CAL-01.v7, QA CAL-12.v6, QA CAL-23.v4, QA CAL-25.v3
Calibration procedure for dosimetric E-field probes**

Calibration date: **February 21, 2011**

This calibration certificate documents the traceability to national standards, which realize the physical units of measurements (SI).
The measurements and the uncertainties with confidence probability are given on the following pages and are part of the certificate.

All calibrations have been conducted in the closed laboratory facility: environment temperature $(22 \pm 3)^\circ\text{C}$ and humidity $< 70\%$.

Calibration Equipment used (M&TE critical for calibration)

Primary Standards	ID	Cal Date (Certificate No.)	Scheduled Calibration
Power meter E4419B	GB41293874	01-Apr-10 (No. 217-01136)	Apr-11
Power sensor E4412A	MY41495277	01-Apr-10 (No. 217-01136)	Apr-11
Power sensor E4412A	MY41498087	01-Apr-10 (No. 217-01136)	Apr-11
Reference 3 dB Attenuator	SN: S5054 (3c)	30-Mar-10 (No. 217-01159)	Mar-11
Reference 20 dB Attenuator	SN: S5086 (20b)	30-Mar-10 (No. 217-01161)	Mar-11
Reference 30 dB Attenuator	SN: S5129 (30b)	30-Mar-10 (No. 217-01160)	Mar-11
Reference Probe ES3DV2	SN: 3013	29-Dec-10 (No. ES3-3013_Dec10)	Dec-11
DAE4	SN: 654	23-Apr-10 (No. DAE4-654_Apr10)	Apr-11
Secondary Standards	ID	Check Date (in house)	Scheduled Check
RF generator HP 8648C	US3642U01700	4-Aug-99 (in house check Oct-09)	In house check: Oct-11
Network Analyzer HP 8753E	US37390585	18-Oct-01 (in house check Oct-10)	In house check: Oct-11

	Name	Function	Signature
Calibrated by:	Jeton Kastrati	Laboratory Technician	
Approved by:	Katja Pokovic	Technical Manager	
			Issued: February 22, 2011
This calibration certificate shall not be reproduced except in full without written approval of the laboratory.			



Accredited by the Swiss Accreditation Service (SAS)

Accreditation No.: SCS 108

The Swiss Accreditation Service is one of the signatories to the EA
Multilateral Agreement for the recognition of calibration certificates

Glossary:

TSL	tissue simulating liquid
NORM _{x,y,z}	sensitivity in free space
ConvF	sensitivity in TSL / NORM _{x,y,z}
DCP	diode compression point
CF	crest factor (1/duty_cycle) of the RF signal
A, B, C	modulation dependent linearization parameters
Polarization Θ	Θ rotation around probe axis
Polarization ϑ	ϑ rotation around an axis that is in the plane normal to probe axis (at measurement center), i.e., $\vartheta = 0$ is normal to probe axis

Calibration is Performed According to the Following Standards:

- IEEE Std 1528-2003, "IEEE Recommended Practice for Determining the Peak Spatial-Averaged Specific Absorption Rate (SAR) in the Human Head from Wireless Communications Devices: Measurement Techniques", December 2003
- IEC 62209-1, "Procedure to measure the Specific Absorption Rate (SAR) for hand-held devices used in close proximity to the ear (frequency range of 300 MHz to 3 GHz)", February 2005

Methods Applied and Interpretation of Parameters:

- NORM_{x,y,z}**: Assessed for E-field polarization $\vartheta = 0$ ($f \leq 900$ MHz in TEM-cell; $f > 1800$ MHz: R22 waveguide). NORM_{x,y,z} are only intermediate values, i.e., the uncertainties of NORM_{x,y,z} does not affect the E^2 -field uncertainty inside TSL (see below ConvF).
- NORM(f)_{x,y,z} = NORM_{x,y,z} * frequency_response** (see Frequency Response Chart). This linearization is implemented in DASY4 software versions later than 4.2. The uncertainty of the frequency response is included in the stated uncertainty of ConvF.
- DCP_{x,y,z}**: DCP are numerical linearization parameters assessed based on the data of power sweep with CW signal (no uncertainty required). DCP does not depend on frequency nor media.
- PAR**: PAR is the Peak to Average Ratio that is not calibrated but determined based on the signal characteristics
- A_{x,y,z}; B_{x,y,z}; C_{x,y,z}** are numerical linearization parameters in dB assessed based on the data of power sweep for specific modulation signal. The parameters do not depend on frequency nor media.
- VR**: VR is the validity range of the calibration related to the average diode voltage or DAE voltage in mV.
- ConvF and Boundary Effect Parameters**: Assessed in flat phantom using E-field (or Temperature Transfer Standard for $f \leq 800$ MHz) and inside waveguide using analytical field distributions based on power measurements for $f > 800$ MHz. The same setups are used for assessment of the parameters applied for boundary compensation (alpha, depth) of which typical uncertainty values are given. These parameters are used in DASY4 software to improve probe accuracy close to the boundary. The sensitivity in TSL corresponds to NORM_{x,y,z} * ConvF whereby the uncertainty corresponds to that given for ConvF. A frequency dependent ConvF is used in DASY version 4.4 and higher which allows extending the validity from ± 50 MHz to ± 100 MHz.
- Spherical isotropy (3D deviation from isotropy)**: in a field of low gradients realized using a flat phantom exposed by a patch antenna.
- Sensor Offset**: The sensor offset corresponds to the offset of virtual measurement center from the probe tip (on probe axis). No tolerance required.

Probe ET3DV6R

SN:1669

Manufactured: February 8, 2002
Calibrated: February 21, 2011

Calibrated for DASY/EASY Systems
(Note: non-compatible with DASY2 system!)

DASY/EASY - Parameters of Probe: ET3DV6R - SN:1669

Basic Calibration Parameters

	Sensor X	Sensor Y	Sensor Z	Unc (k=2)
Norm ($\mu\text{V}/(\text{V/m})^2$) ^A	1.76	1.95	1.80	$\pm 10.1 \%$
DCP (mV) ^B	97.6	98.3	97.4	

Modulation Calibration Parameters

UID	Communication System Name	PAR		A dB	B dB	C dB	VR mV	Unc ^E (k=2)
10000	CW	0.00	X	0.00	0.00	1.00	145.7	$\pm 3.5 \%$
			Y	0.00	0.00	1.00	148.4	
			Z	0.00	0.00	1.00	142.7	

The reported uncertainty of measurement is stated as the standard uncertainty of measurement multiplied by the coverage factor k=2, which for a normal distribution corresponds to a coverage probability of approximately 95%.

^A The uncertainties of NormX,Y,Z do not affect the E²-field uncertainty inside TSL (see Pages 5 and 6).

^B Numerical linearization parameter: uncertainty not required.

^E Uncertainty is determined using the max. deviation from linear response applying rectangular distribution and is expressed for the square of the field value.

DASY/EASY - Parameters of Probe: ET3DV6R - SN:1669

Calibration Parameter Determined in Head Tissue Simulating Media

f (MHz) ^C	Relative Permittivity ^F	Conductivity (S/m) ^F	ConvF X	ConvF Y	ConvF Z	Alpha	Depth (mm)	Unct. (k=2)
450	43.5	0.87	7.24	7.24	7.24	0.19	2.22	± 13.4 %
750	41.9	0.89	6.67	6.67	6.67	0.82	1.72	± 12.0 %
900	41.5	0.97	6.23	6.23	6.23	0.70	1.91	± 12.0 %
1750	40.1	1.37	5.34	5.34	5.34	0.56	2.35	± 12.0 %
1900	40.0	1.40	5.12	5.12	5.12	0.56	2.36	± 12.0 %
1950	40.0	1.40	4.94	4.94	4.94	0.57	2.28	± 12.0 %

^C Frequency validity of ± 100 MHz only applies for DASY v4.4 and higher (see Page 2), else it is restricted to ± 50 MHz. The uncertainty is the RSS of the ConvF uncertainty at calibration frequency and the uncertainty for the indicated frequency band.

^F At frequencies below 3 GHz, the validity of tissue parameters (ϵ and σ) can be relaxed to ± 10% if liquid compensation formula is applied to measured SAR values. At frequencies above 3 GHz, the validity of tissue parameters (ϵ and σ) is restricted to ± 5%. The uncertainty is the RSS of the ConvF uncertainty for indicated target tissue parameters.

DASY/EASY - Parameters of Probe: ET3DV6R- SN:1669

Calibration Parameter Determined in Body Tissue Simulating Media

f (MHz) ^C	Relative Permittivity ^F	Conductivity (S/m) ^F	ConvF X	ConvF Y	ConvF Z	Alpha	Depth (mm)	Unct. (k=2)
450	56.7	0.94	7.53	7.53	7.53	0.14	2.31	± 13.4 %
750	55.5	0.96	6.32	6.32	6.32	0.81	1.79	± 12.0 %
900	55.0	1.05	6.15	6.15	6.15	0.70	1.98	± 12.0 %
1750	53.4	1.49	4.75	4.75	4.75	0.60	2.86	± 12.0 %
1900	53.3	1.52	4.54	4.54	4.54	0.58	2.75	± 12.0 %
1950	53.3	1.52	4.63	4.63	4.63	0.58	2.77	± 12.0 %

^C Frequency validity of ± 100 MHz only applies for DASY v4.4 and higher (see Page 2), else it is restricted to ± 50 MHz. The uncertainty is the RSS of the ConvF uncertainty at calibration frequency and the uncertainty for the indicated frequency band.

^F At frequencies below 3 GHz, the validity of tissue parameters (ϵ and σ) can be relaxed to ± 10% if liquid compensation formula is applied to measured SAR values. At frequencies above 3 GHz, the validity of tissue parameters (ϵ and σ) is restricted to ± 5%. The uncertainty is the RSS of the ConvF uncertainty for indicated target tissue parameters.

Frequency Response of E-Field (TEM-Cell:ifi110 EXX, Waveguide: R22)

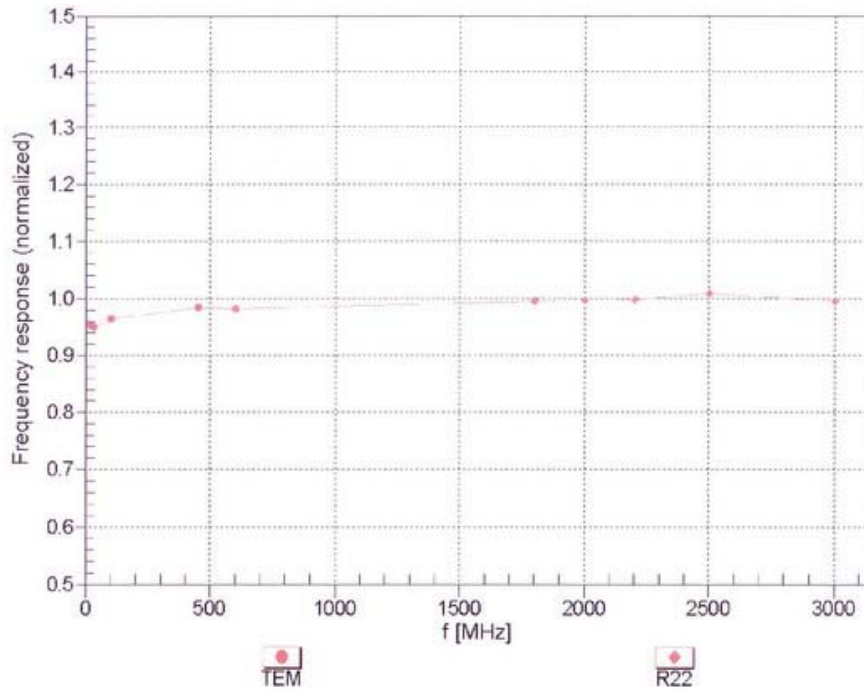

Uncertainty of Frequency Response of E-field: $\pm 6.3\%$ (k=2)

Receiving Pattern (ϕ), $\vartheta = 0^\circ$

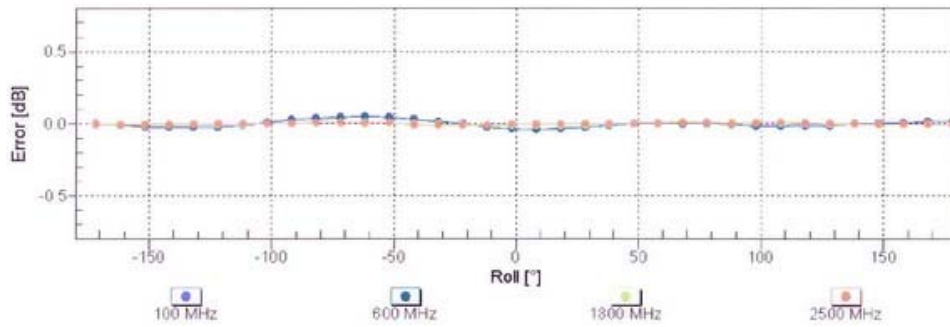
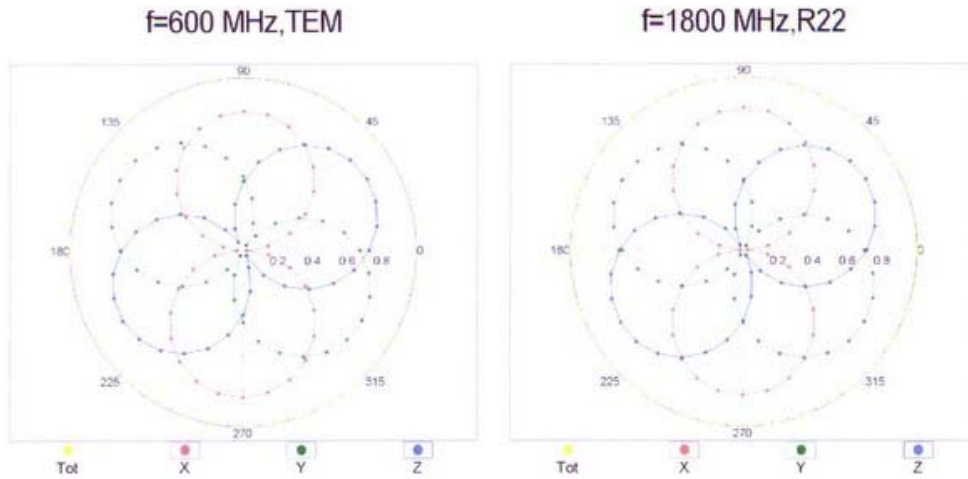

Uncertainty of Axial Isotropy Assessment: $\pm 0.5\%$ ($k=2$)

Dynamic Range f(SAR_{head}) (TEM cell , f = 900 MHz)

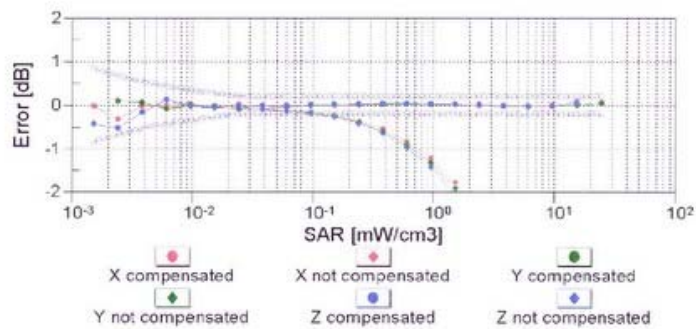
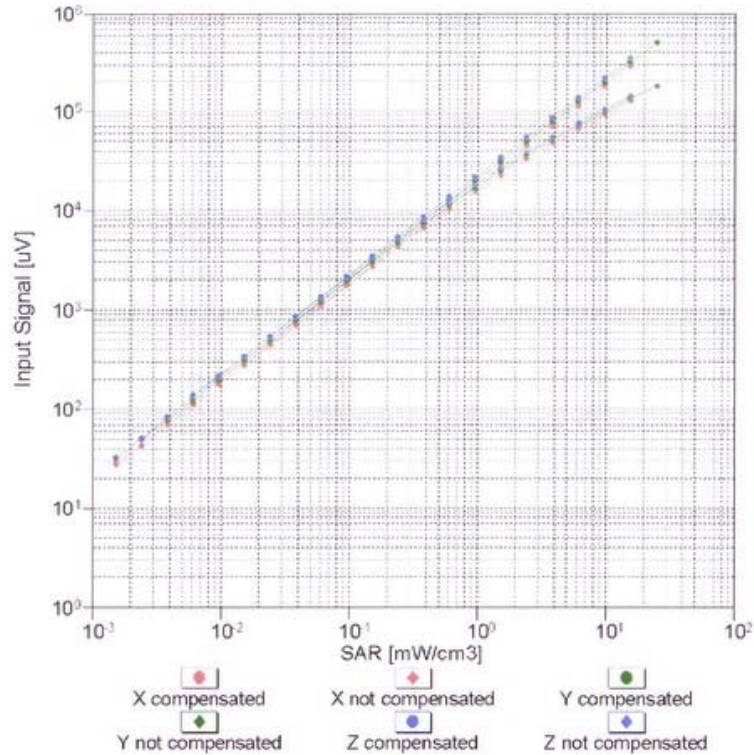

Uncertainty of Linearity Assessment: ± 0.6% (k=2)

Conversion Factor Assessment

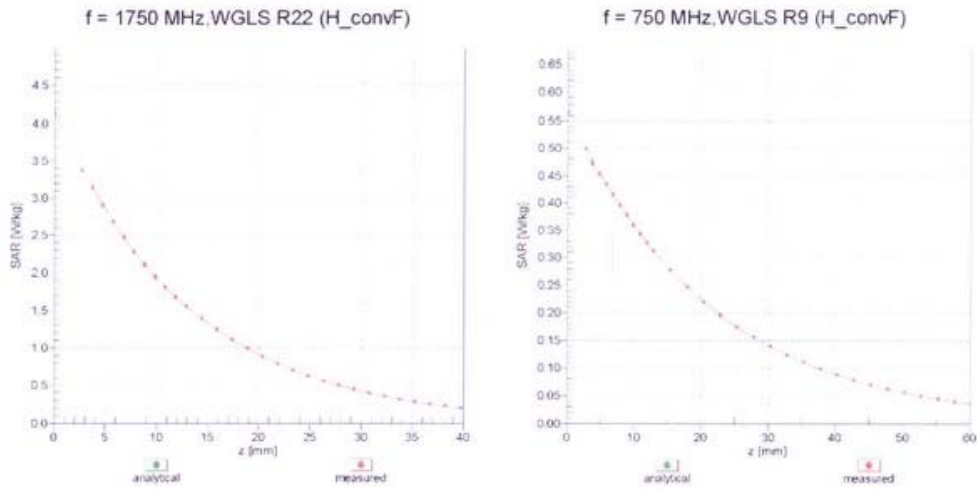

Deviation from Isotropy in Air Error (ϕ, ϑ), f = 900 MHz

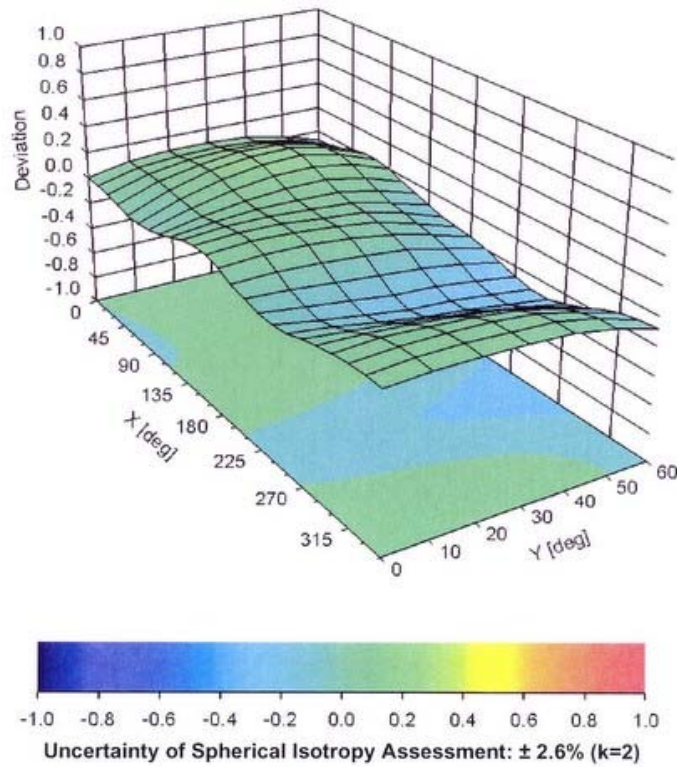

DASY/EASY - Parameters of Probe: ET3DV6R - SN:1669**Other Probe Parameters**

Sensor Arrangement	Triangular
Connector Angle (°)	Not applicable
Mechanical Surface Detection Mode	enabled
Optical Surface Detection Mode	disabled
Probe Overall Length	337 mm
Probe Body Diameter	10 mm
Tip Length	10 mm
Tip Diameter	6.8 mm
Probe Tip to Sensor X Calibration Point	2.7 mm
Probe Tip to Sensor Y Calibration Point	2.7 mm
Probe Tip to Sensor Z Calibration Point	2.7 mm
Recommended Measurement Distance from Surface	4 mm

**Calibration Laboratory of
Schmid & Partner
Engineering AG**
Zeughausstrasse 43, 8004 Zurich, Switzerland



S Schweizerischer Kalibrierdienst
S Service suisse d'étalonnage
C Servizio svizzero di taratura
S Swiss Calibration Service

Accredited by the Swiss Accreditation Service (SAS)
The Swiss Accreditation Service is one of the signatories to the EA
Multilateral Agreement for the recognition of calibration certificates

Accreditation No.: **SCS 108**

Client **IMST**

Certificate No: **EX3-3536_Sep11**

CALIBRATION CERTIFICATE

Object **EX3DV4 - SN:3536**

Calibration procedure(s) **QA CAL-01.v8, QA CAL-14.v3, QA CAL-23.v4, QA CAL-25.v4**
Calibration procedure for dosimetric E-field probes

Calibration date: **September 26, 2011**

This calibration certificate documents the traceability to national standards, which realize the physical units of measurements (SI).
The measurements and the uncertainties with confidence probability are given on the following pages and are part of the certificate.

All calibrations have been conducted in the closed laboratory facility: environment temperature $(22 \pm 3)^{\circ}\text{C}$ and humidity $< 70\%$.

Calibration Equipment used (M&TE critical for calibration)

Primary Standards	ID	Cal Date (Certificate No.)	Scheduled Calibration
Power meter E4419B	GB41293874	31-Mar-11 (No. 217-01372)	Apr-12
Power sensor E4412A	MY41498087	31-Mar-11 (No. 217-01372)	Apr-12
Reference 3 dB Attenuator	SN: S5054 (3c)	29-Mar-11 (No. 217-01369)	Apr-12
Reference 20 dB Attenuator	SN: S5086 (20b)	29-Mar-11 (No. 217-01367)	Apr-12
Reference 30 dB Attenuator	SN: S5129 (30b)	29-Mar-11 (No. 217-01370)	Apr-12
Reference Probe ES3DV2	SN: 3013	29-Dec-10 (No. ES3-3013_Dec10)	Dec-11
DAE4	SN: 654	3-May-11 (No. DAE4-654_May11)	May-12
Secondary Standards	ID	Check Date (in house)	Scheduled Check
RF generator HP 8648C	US3642U01700	4-Aug-99 (in house check Oct-09)	In house check: Oct-11
Network Analyzer HP 8753E	US37390585	18-Oct-01 (in house check Oct-10)	In house check: Oct-11

Calibrated by:	Name Katja Pokovic	Function Technical Manager	Signature
Approved by:	Niels Kuster	Quality Manager	
			Issued: September 27, 2011
This calibration certificate shall not be reproduced except in full without written approval of the laboratory.			



Accredited by the Swiss Accreditation Service (SAS)

Accreditation No.: SCS 108

The Swiss Accreditation Service is one of the signatories to the EA
Multilateral Agreement for the recognition of calibration certificates

Glossary:

TSL	tissue simulating liquid
NORM _{x,y,z}	sensitivity in free space
ConvF	sensitivity in TSL / NORM _{x,y,z}
DCP	diode compression point
CF	crest factor (1/duty_cycle) of the RF signal
A, B, C	modulation dependent linearization parameters
Polarization φ	φ rotation around probe axis
Polarization ϑ	ϑ rotation around an axis that is in the plane normal to probe axis (at measurement center), i.e., $\vartheta = 0$ is normal to probe axis

Calibration is Performed According to the Following Standards:

- IEEE Std 1528-2003, "IEEE Recommended Practice for Determining the Peak Spatial-Averaged Specific Absorption Rate (SAR) in the Human Head from Wireless Communications Devices: Measurement Techniques", December 2003
- IEC 62209-1, "Procedure to measure the Specific Absorption Rate (SAR) for hand-held devices used in close proximity to the ear (frequency range of 300 MHz to 3 GHz)", February 2005

Methods Applied and Interpretation of Parameters:

- NORM_{x,y,z}**: Assessed for E-field polarization $\vartheta = 0$ ($f \leq 900$ MHz in TEM-cell; $f > 1800$ MHz: R22 waveguide). NORM_{x,y,z} are only intermediate values, i.e., the uncertainties of NORM_{x,y,z} does not affect the E^2 -field uncertainty inside TSL (see below ConvF).
- NORM(f)_{x,y,z} = NORM_{x,y,z} * frequency_response** (see Frequency Response Chart). This linearization is implemented in DASY4 software versions later than 4.2. The uncertainty of the frequency response is included in the stated uncertainty of ConvF.
- DCP_{x,y,z}**: DCP are numerical linearization parameters assessed based on the data of power sweep with CW signal (no uncertainty required). DCP does not depend on frequency nor media.
- PAR**: PAR is the Peak to Average Ratio that is not calibrated but determined based on the signal characteristics
- A_{x,y,z}; B_{x,y,z}; C_{x,y,z}; VR_{x,y,z}**: A, B, C are numerical linearization parameters assessed based on the data of power sweep for specific modulation signal. The parameters do not depend on frequency nor media. VR is the maximum calibration range expressed in RMS voltage across the diode.
- ConvF and Boundary Effect Parameters**: Assessed in flat phantom using E-field (or Temperature Transfer Standard for $f \leq 800$ MHz) and inside waveguide using analytical field distributions based on power measurements for $f > 800$ MHz. The same setups are used for assessment of the parameters applied for boundary compensation (alpha, depth) of which typical uncertainty values are given. These parameters are used in DASY4 software to improve probe accuracy close to the boundary. The sensitivity in TSL corresponds to NORM_{x,y,z} * ConvF whereby the uncertainty corresponds to that given for ConvF. A frequency dependent ConvF is used in DASY version 4.4 and higher which allows extending the validity from ± 50 MHz to ± 100 MHz.
- Spherical isotropy (3D deviation from isotropy)**: in a field of low gradients realized using a flat phantom exposed by a patch antenna.
- Sensor Offset**: The sensor offset corresponds to the offset of virtual measurement center from the probe tip (on probe axis). No tolerance required.

Probe EX3DV4

SN:3536

Manufactured: April 30, 2004
Calibrated: September 26, 2011

Calibrated for DASY/EASY Systems
(Note: non-compatible with DASY2 system!)

DASY/EASY - Parameters of Probe: EX3DV4 - SN:3536

Basic Calibration Parameters

	Sensor X	Sensor Y	Sensor Z	Unc (k=2)
Norm ($\mu\text{V}/(\text{V}/\text{m})^2$) ^A	0.44	0.43	0.36	$\pm 10.1\%$
DCP (mV) ^B	101.1	97.3	100.2	

Modulation Calibration Parameters

UID	Communication System Name	PAR		A dB	B dB	C dB	VR mV	Unc ^E (k=2)
10000	CW	0.00	X	0.00	0.00	1.00	108.8	$\pm 2.7\%$
			Y	0.00	0.00	1.00	101.4	
			Z	0.00	0.00	1.00	97.4	

The reported uncertainty of measurement is stated as the standard uncertainty of measurement multiplied by the coverage factor $k=2$, which for a normal distribution corresponds to a coverage probability of approximately 95%.

^A The uncertainties of NormX,Y,Z do not affect the E^2 -field uncertainty inside TSL (see Pages 5 and 6).

^B Numerical linearization parameter: uncertainty not required.

^E Uncertainty is determined using the max. deviation from linear response applying rectangular distribution and is expressed for the square of the field value.

DASY/EASY - Parameters of Probe: EX3DV4 - SN:3536

Calibration Parameter Determined in Head Tissue Simulating Media

f (MHz) ^C	Relative Permittivity ^F	Conductivity (S/m) ^F	ConvF X	ConvF Y	ConvF Z	Alpha	Depth (mm)	Unct. (k=2)
1950	40.0	1.40	8.07	8.07	8.07	0.80	0.60	± 12.0 %
2450	39.2	1.80	7.45	7.45	7.45	0.79	0.59	± 12.0 %
2600	39.0	1.96	7.28	7.28	7.28	0.71	0.63	± 12.0 %
3500	37.9	2.91	7.32	7.32	7.32	0.26	1.25	± 13.1 %
5200	36.0	4.66	5.27	5.27	5.27	0.38	1.80	± 13.1 %
5300	35.9	4.76	4.90	4.90	4.90	0.40	1.80	± 13.1 %
5600	35.5	5.07	4.61	4.61	4.61	0.50	1.80	± 13.1 %
5800	35.3	5.27	4.53	4.53	4.53	0.50	1.80	± 13.1 %

^C Frequency validity of ± 100 MHz only applies for DASY v4.4 and higher (see Page 2), else it is restricted to ± 50 MHz. The uncertainty is the RSS of the ConvF uncertainty at calibration frequency and the uncertainty for the indicated frequency band.

^F At frequencies below 3 GHz, the validity of tissue parameters (ϵ and σ) can be relaxed to ± 10% if liquid compensation formula is applied to measured SAR values. At frequencies above 3 GHz, the validity of tissue parameters (ϵ and σ) is restricted to ± 5%. The uncertainty is the RSS of the ConvF uncertainty for indicated target tissue parameters.

DASY/EASY - Parameters of Probe: EX3DV4 - SN:3536

Calibration Parameter Determined in Body Tissue Simulating Media

f (MHz) ^C	Relative Permittivity ^F	Conductivity (S/m) ^F	ConvF X	ConvF Y	ConvF Z	Alpha	Depth (mm)	Unct. (k=2)
1950	53.3	1.52	8.03	8.03	8.03	0.80	0.62	± 12.0 %
2450	52.7	1.95	7.42	7.42	7.42	0.80	0.50	± 12.0 %
2600	52.5	2.16	7.39	7.39	7.39	0.80	0.50	± 12.0 %
3500	51.3	3.31	6.82	6.82	6.82	0.34	1.21	± 13.1 %
5200	49.0	5.30	4.43	4.43	4.43	0.60	1.95	± 13.1 %
5300	48.9	5.42	4.18	4.18	4.18	0.60	1.95	± 13.1 %
5600	48.5	5.77	3.92	3.92	3.92	0.65	1.95	± 13.1 %
5800	48.2	6.00	4.03	4.03	4.03	0.65	1.95	± 13.1 %

^C Frequency validity of ± 100 MHz only applies for DASY v4.4 and higher (see Page 2), else it is restricted to ± 50 MHz. The uncertainty is the RSS of the ConvF uncertainty at calibration frequency and the uncertainty for the indicated frequency band.

^F At frequencies below 3 GHz, the validity of tissue parameters (ϵ and σ) can be relaxed to $\pm 10\%$ if liquid compensation formula is applied to measured SAR values. At frequencies above 3 GHz, the validity of tissue parameters (ϵ and σ) is restricted to $\pm 5\%$. The uncertainty is the RSS of the ConvF uncertainty for indicated target tissue parameters.

Frequency Response of E-Field (TEM-Cell:ifi110 EXX, Waveguide: R22)

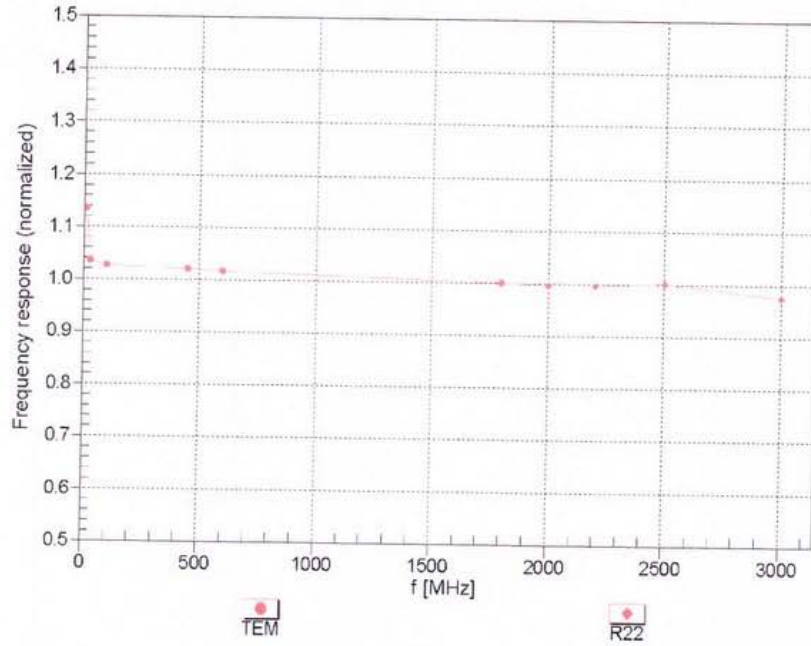

Uncertainty of Frequency Response of E-field: $\pm 6.3\%$ (k=2)

Receiving Pattern (ϕ), $\vartheta = 0^\circ$

f=600 MHz,TEM

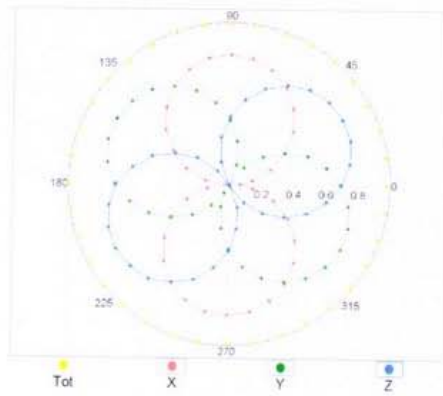

f=1800 MHz,R22

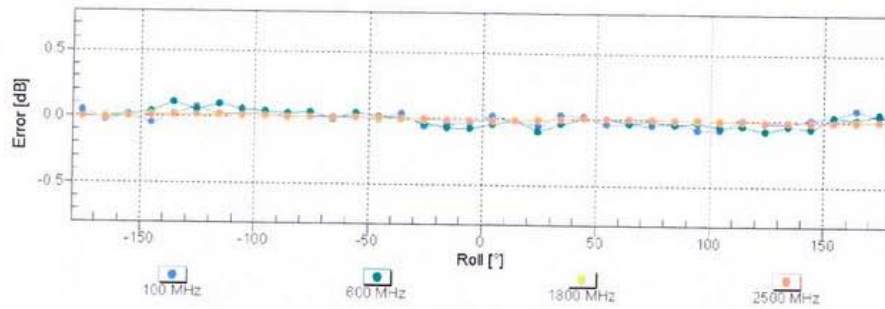
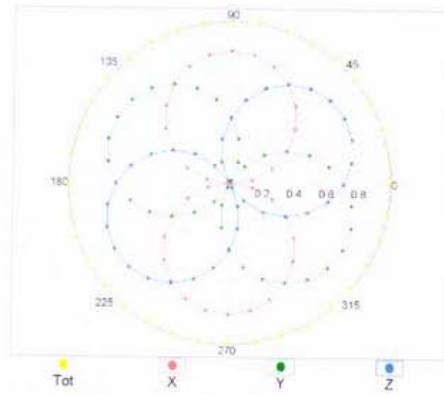

Uncertainty of Axial Isotropy Assessment: $\pm 0.5\%$ (k=2)

Dynamic Range f(SAR_{head}) (TEM cell , f = 900 MHz)

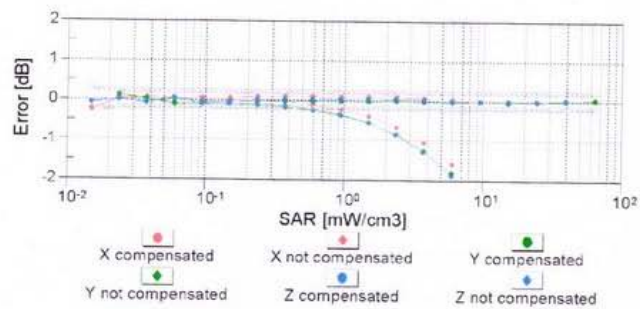
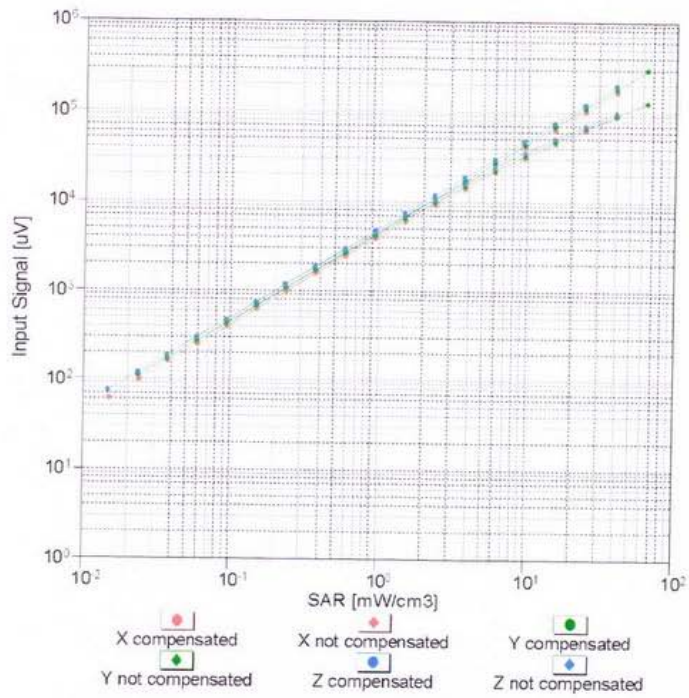

Uncertainty of Linearity Assessment: ± 0.6% (k=2)

Conversion Factor Assessment

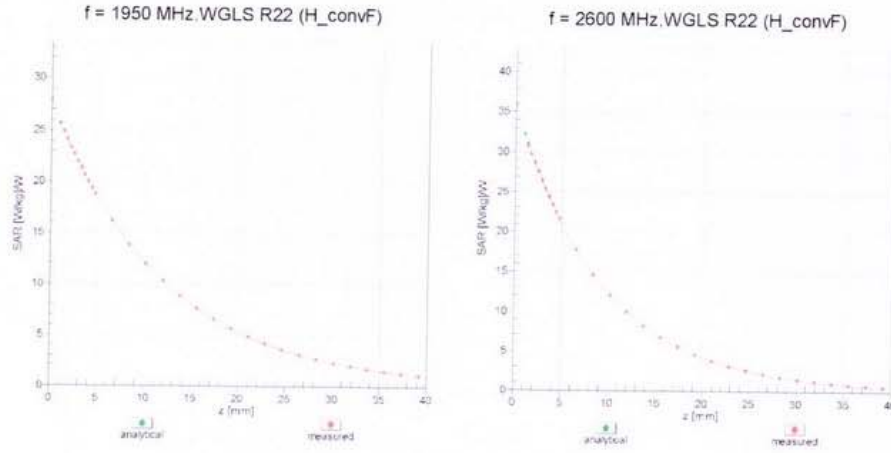

Deviation from Isotropy in Liquid

Error (ϕ, ϑ), f = 900 MHz

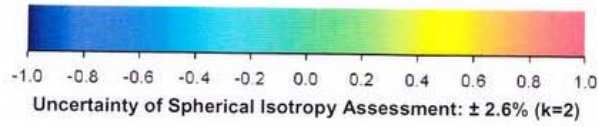
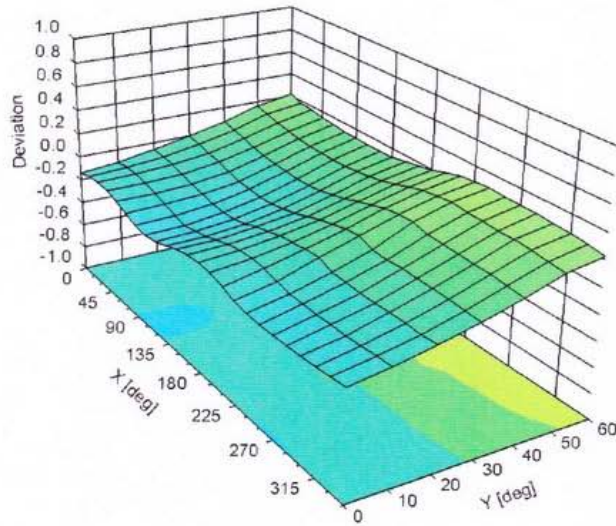

DASY/EASY - Parameters of Probe: EX3DV4 - SN:3536**Other Probe Parameters**

Sensor Arrangement	Triangular
Connector Angle (°)	Not applicable
Mechanical Surface Detection Mode	enabled
Optical Surface Detection Mode	disabled
Probe Overall Length	337 mm
Probe Body Diameter	10 mm
Tip Length	9 mm
Tip Diameter	2.5 mm
Probe Tip to Sensor X Calibration Point	1 mm
Probe Tip to Sensor Y Calibration Point	1 mm
Probe Tip to Sensor Z Calibration Point	1 mm
Recommended Measurement Distance from Surface	2 mm

DAT-P-152/98-01

Calibration Certificate

Certificate No: Cal_D835V2_SN437_0410
 Object: D835V2 SN: 437
 Date of Calibration: April 7, 2010
 Next Calibration: April 2012
 Object Condition: In Tolerance

Calibration Equipment used:

Test Equipment	Serial Number	Last calibration	Calibrated by	Next calibration
Powermeter E4416A	GB41050414	Dec 08	Agilent Techn. (ISO/IEC 17025, 1-1784162174-1)	Dec 10
Power Sensor E9301H	US40010212	Dec 08	Agilent Techn. (ISO/IEC 17025, 1-1784041195-1)	Dec 10
Powermeter E4417A	GB41050441	Dec 08	Agilent Techn. (ISO/IEC 17025, 1-1674038198-1)	Dec 10
Power Sensor E9301A	MY41495584	Dec 08	Agilent Techn. (ISO/IEC 17025, 1-1784041307-1)	Dec 10
Network Analyzer E5071C	MY46103220	Aug 09	Rohde& Schwarz (14967-DKD-00201- 2009-08)	Aug 10
Reference Probe EX3DV4	SN 1579	Jan 10	SPEAG, No ET3- 1579_Jan10	Jan 11
DAE3	SN 631	Sep 09	SPEAG, No DAE4- 631_Sep09	Sep 10

Calibration is performed according the following standards:

IEEE 1528-2003

"IEEE Recommended Practice for Determining the Peak Spatial - Averaged Specific Absorption Rate (SAR) in the Human Head from Wireless Communication Devices: Measurement Technique", December 2003

IEC 62209-1

"Procedure to measure the Specific Absorption Rate (SAR) for hand - held devices used in close proximity to the ear (frequency range of 300 MHz to 3GHz)", February 2005

Federal Communications Commission Office of Engineering & Technologies (FCCOET)

"Evaluating Compliance with FCC Guidelines for Human Exposure to Radiofrequency Electromagnetic Fields; Additional Information for Evaluating Compliance of Mobile and Portable Devices with FCC Limits for Human Exposure to Radiofrequency Emissions", Supplement C (Edition 01-01) to Bulletin 65

Additional Documentation: DASY 4 System Handbook

prepared by:



Alexander Rahn
test engineer

reviewed by:



André van den Bosch
quality assurance engineer

Measurement Conditions		
DASY Version:	Dasy 4;	V4.7
Phantom:	SAM Phantom	1059
Distance Dipole Center – TSL:	15mm	With spacer
Zoom Scan res.	dx, dy, dz = 5mm	
Frequency:	835 MHz \pm 1MHz	

Head TSL Parameters			
	Temperature	Permittivity	Conductivity
Nominal Body TSL Parameters	22.0	41.50	0.90
Measured Body TSL Parameters	22.0	41.10 \pm 6%	0.91 S/m \pm 6%

SAR result with Head TSL			
Averaged over 1g	SAR measured	250mW input power	2.56 mW/g
	SAR normalized	normalized to 1W	10.24 mW/g
	SAR for nominal Body TSL parameters	normalized to 1W	10.15 mW/g \pm 16.5 % (k=2)
Averaged over 10g	SAR measured	250mW input power	1.66 mW/g
	SAR normalized	normalized to 1W	6.64 mW/g
	SAR for nominal Body TSL parameters	normalized to 1W	6.60 mW/g \pm 16.5 % (k=2)

Body TSL Parameters			
	Temperature	Permittivity	Conductivity
Nominal Body TSL Parameters	22.0	55.20	0.97
Measured Body TSL Parameters	22.0	55.70 ± 6%	1.00 S/m ± 6%

SAR result with Body TSL			
Averaged over 1g	SAR measured	250mW input power	2.49 mW/g
	SAR normalized	normalized to 1W	9.96 mW/g
	SAR for nominal Body TSL parameters	normalized to 1W	9.83 mW/g ± 16.5 % (k=2)
Averaged over 10g	SAR measured	250mW input power	1.62 mW/g
	SAR normalized	normalized to 1W	6.48 mW/g
	SAR for nominal Body TSL parameters	normalized to 1W	6.44 mW/g ± 16.5 % (k=2)

General Antenna Parameters		
Antenna Parameter with Head TSL	Impedance, transformed to feed point	46.34 jΩ - 4.8 jΩ
	Return Loss	-24.06 dB
Antenna Parameter with Body TSL	Impedance, transformed to feed point	49.35 jΩ - 8.93 jΩ
	Return Loss	-20.94 dB

After long term use with 100W radiated power, only a slight warming of the dipole near the feedpoint can be measured. The dipole is made of standard semirigid coaxial cable. The center conductor of the feeding line is directly connected to the second arm of the dipole. The antenna is therefore short-circuited for DC signals.

Additional EUT Data	
Manufactured by:	SPEAG
Manufactured on:	December 15, 2000

SAR results with Head TSL

Test Laboratory: Imst GmbH, DASY Yellow (II); File Name: [070410_y_1579.da4](#)

DUT: Dipole 835 MHz SN437; Type: D835V2; Serial: D835V2 - SN:437

Program Name: System Performance Check at 835 MHz

Communication System: CW; Frequency: 835 MHz; Duty Cycle: 1:1

Medium parameters used: $f = 835$ MHz; $\sigma = 0.91$ mho/m; $\epsilon_r = 41.1$; $\rho = 1000$ kg/m³

Phantom section: Flat Section

DASY4 Configuration:

- Probe: ET3DV6R - SN1579; ConvF(6.34, 6.34, 6.34); Calibrated: 20.01.2010

- Sensor-Surface: 4mm (Mechanical Surface Detection)

- Electronics: DAE4 Sn631; Calibrated: 14.09.2009

- Phantom: SAM Sugar 1059; Type: Speag; Serial: 1059

- Measurement SW: DASY4, V4.7 Build 80; Postprocessing SW: SEMCAD, V1.8 Build 186

d=10mm, Pin=250mW/Area Scan (7x7x1): Measurement grid: dx=15mm, dy=15mm

Maximum value of SAR (measured) = 2.80 mW/g

d=10mm, Pin=250mW/Zoom Scan (7x7x7)/Cube 0: Measurement grid: dx=5mm, dy=5mm, dz=5mm

Reference Value = 57.5 V/m; Power Drift = -0.070 dB

Peak SAR (extrapolated) = 3.77 W/kg

SAR(1 g) = 2.56 mW/g; SAR(10 g) = 1.66 mW/g

Maximum value of SAR (measured) = 2.78 mW/g

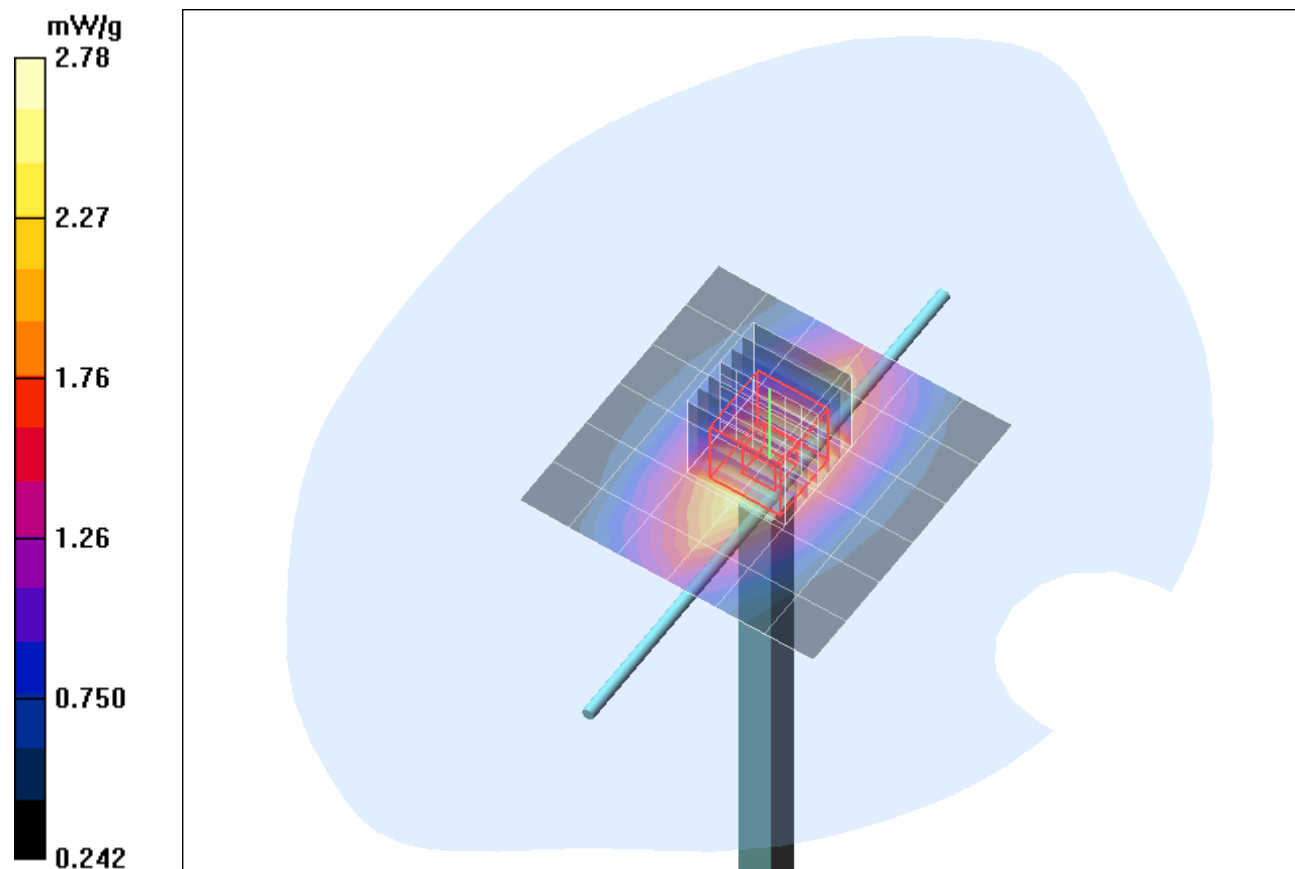

Impedance Measurements Plot for Head TSL

Tr1 S11 Smith (R+jX) scale 1.000u [F1]

>1 835.00000 MHz 46.342 Ω 4.8089 Ω 916.59 pF

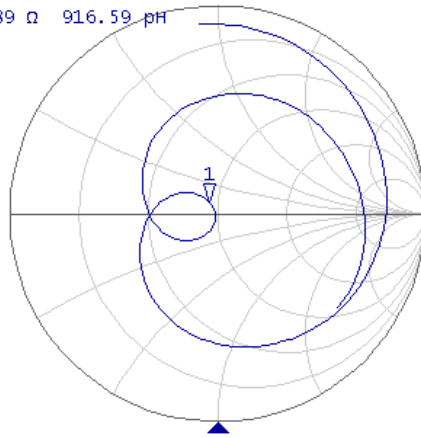

Tr2 S11 Log Mag 10.00dB/ Ref 0.000dB [F1]

>1 835.00000 MHz -24.064 dB

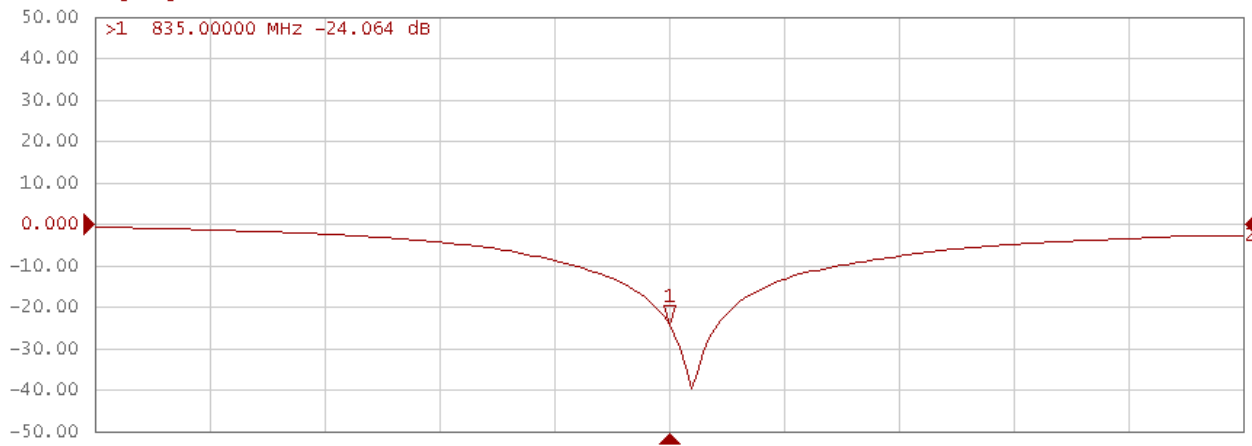

SAR results with Body TSL

Test Laboratory: IMST GmbH, DASY Blue (I); File Name: [070410_b_1579.da4](#)

DUT: Dipole 835 MHz SN437; Type: D835V2; Serial: D835V2 - SN:437

Program Name: System Performance Check at 835 MHz

Communication System: CW; Frequency: 835 MHz; Duty Cycle: 1:1
Medium parameters used: $f = 835$ MHz; $\sigma = 1$ mho/m; $\epsilon_r = 55.7$; $\rho = 1000$ kg/m³
Phantom section: Flat Section

DASY4 Configuration:

- Probe: ET3DV6R - SN1579; ConvF(6.21, 6.21, 6.21); Calibrated: 20.01.2010
- Sensor-Surface: 4mm (Mechanical Surface Detection)
- Electronics: DAE4 Sn631; Calibrated: 14.09.2009
- Phantom: SAM Sugar 1059; Type: Speag; Serial: 1059
- Measurement SW: DASY4, V4.7 Build 80; Postprocessing SW: SEMCAD, V1.8 Build 186

d=10mm, Pin=250mW/Area Scan (7x7x1): Measurement grid: dx=15mm, dy=15mm

Maximum value of SAR (measured) = 2.49 mW/g

d=10mm, Pin=250mW/Zoom Scan (7x7x7)/Cube 0: Measurement grid: dx=5mm, dy=5mm, dz=5mm

Reference Value = 52.7 V/m; Power Drift = -0.060 dB

Peak SAR (extrapolated) = 3.61 W/kg

SAR(1 g) = 2.49 mW/g; SAR(10 g) = 1.62 mW/g

Maximum value of SAR (measured) = 2.69 mW/g

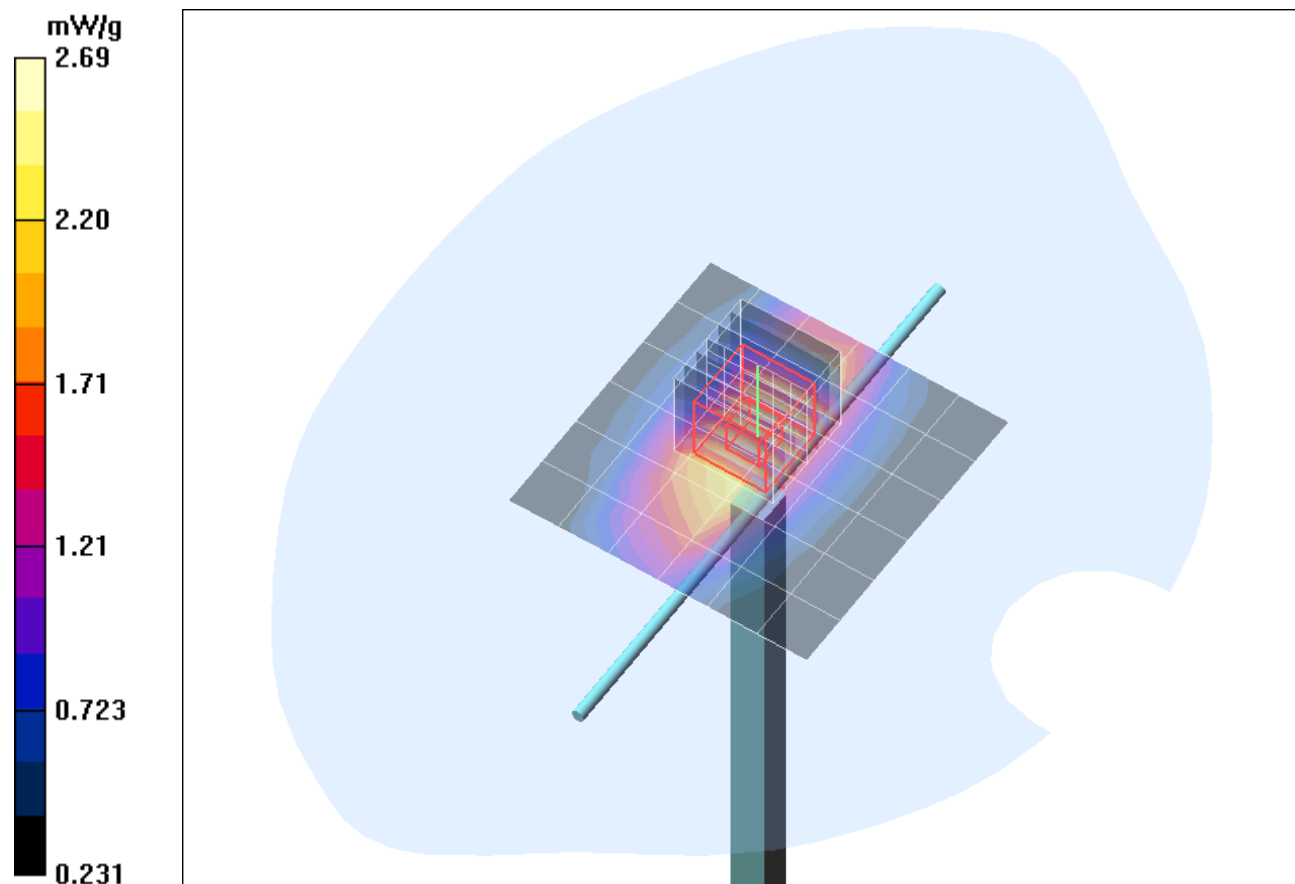

Impedance Measurements Plot for Body TSL

Tr1 S11 Smith (R+jX) scale 1.000U [F1]

>1 835.00000 MHz 49.352 Ω 8.9281 Ω 1.7017 nH

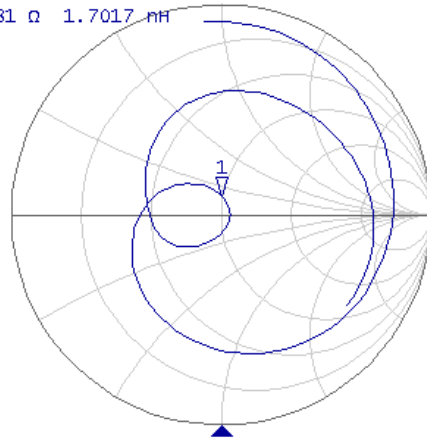

Tr2 S11 Log Mag 10.00dB/ Ref 0.000dB [F1]

>1 835.00000 MHz -20.941 dB

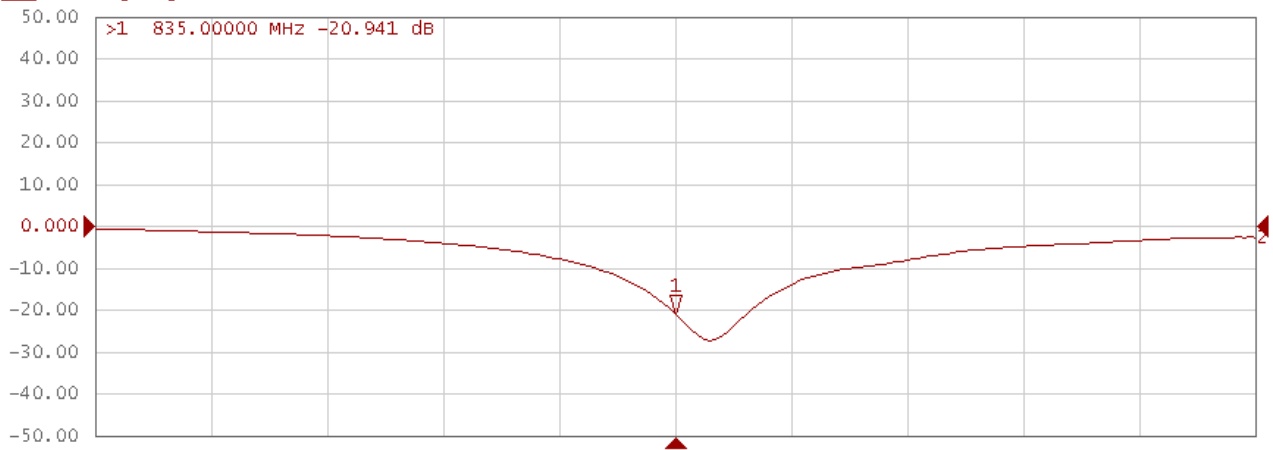

The Testcenter facility 'Dosimetric Test Lab' within IMST GmbH is accredited by the German National 'Deutsche Akkreditierungsstelle GmbH (DAkkS)' for testing according to the scope as listed in the accreditation certificate: D-PL-12139-01-01.

Calibration Certificate

Certificate No: Cal_D1900V2_SN5d051_Sep2011
 Object: D1900V2 SN: 5d051
 Date of Calibration: September 30, 2011
 Next Calibration: September 2013
 Object Condition: In Tolerance

Calibration Equipment used:

Test Equipment	Serial Number	Last calibration	Calibrated by	Next calibration
Powermeter E4416A	GB41050414	Dec 10	Agilent Techn. (ISO/IEC 17025, 1-1784162174-1)	Dec 12
Power Sensor E9301H	US40010212	Dec 10	Agilent Techn. (ISO/IEC 17025, 1-1784041195-1)	Dec 12
Powermeter E4417A	GB41050441	Dec 10	Agilent Techn. (ISO/IEC 17025, 1-1674038198-1)	Dec 12
Power Sensor E9301A	MY41495584	Dec 10	Agilent Techn. (ISO/IEC 17025, 1-1784041307-1)	Dec 12
Network Analyzer E5071C	MY46103220	Aug 11	Rohde& Schwarz (14967-DKD-00201- 2009-08)	Aug 12
Reference Probe ET3DV6	SN 1669	Feb 11	SPEAG, No ET3- 1669_Feb09	Feb 12
DAE3	SN 335	Feb 11	SPEAG, No DAE3- 335_Feb09	Feb 12

Calibration is performed according the following standards:

IEEE 1528-2003

"IEEE Recommended Practice for Determining the Peak Spatial - Averaged Specific Absorption Rate (SAR) in the Human Head from Wireless Communication Devices: Measurement Technique", December 2003

EN 62209-1

"Procedure to measure the Specific Absorption Rate (SAR) for hand - held devices used in close proximity to the ear (frequency range of 300 MHz to 3GHz)", March 2007

Federal Communications Commission Office of Engineering & Technologies (FCCOET)

"Evaluating Compliance wit FCC Guidelines for Human Exposure to Radiofrequency Electromagnetic Fields; Additional Information for Evaluating Compliance of Mobile and Portable Devices with FCC Limits for Human Exposure to Radiofrequency Emissions", Supplement C (Edition 01-01) to Bulletin 65

Additional Documentation: DASY 4 System Handbook

prepared by: 
Alexander Rahn
test engineer

reviewed by: 
André van den Bosch
quality assurance engineer

Measurement Conditions		
DASY Version:	Dasy 4;	V4.7
Phantom:	SAM Phantom	1340
Distance Dipole Center – TSL:	10mm	With spacer
Zoom Scan res.	dx, dy, dz = 5mm	
Frequency:	1900 MHz \pm 1MHz	

Head TSL Parameters			
	Temperature	Permittivity	Conductivity
Nominal Head TSL Parameters	22.0	40.0	1.40
Measured Head TSL Parameters	22.8	39.4 \pm 6%	1.43 S/m \pm 6%

SAR Result with Head TSL			
Averaged over 1g	SAR measured	250mW input power	9.53 mW/g
	SAR normalized	normalized to 1W	38.12 mW/g
	SAR for nominal Head TSL parameters	normalized to 1W	37.51 mW/g \pm 16.5 % (k=2)
Averaged over 10g	SAR measured	250mW input power	4.93 mW/g
	SAR normalized	normalized to 1W	19.72 mW/g
	SAR for nominal Head TSL parameters	normalized to 1W	19.52 mW/g \pm 16.5 % (k=2)

Body TSL Parameters			
	Temperature	Permittivity	Conductivity
Nominal Body TSL Parameters	22.0	53.30	1.52
Measured Body TSL Parameters	23.3	52.10 ± 6%	1.54 S/m ± 6%

SAR Result with Body TSL			
Averaged over 1g	SAR measured	250mW input power	9.66 mW/g
	SAR normalized	normalized to 1W	38.64 mW/g
	SAR for nominal Body TSL parameters	normalized to 1W	38.14 mW/g ± 16.5 % (k=2)
Averaged over 10g	SAR measured	250mW input power	5.10 mW/g
	SAR normalized	normalized to 1W	20.40 mW/g
	SAR for nominal Body TSL parameters	normalized to 1W	20.23 mW/g ± 16.5 % (k=2)

General Antenna Parameters		
Antenna Parameters with Head TSL	Impedance, transformed to feed point	48.4 jΩ - 0.7 jΩ
	Return Loss	-35.2 dB
Antenna Parameter with Body TSL	Impedance, transformed to feed point	52.8 jΩ - 1.8 jΩ
	Return Loss	-29.9 dB
<p>After long term use with 100W radiated power, only a slight warming of the dipole near the feedpoint can be measured. The dipole is made of standard semigrd coaxial cable. The center conductor of the feeding line is directly connected to the second arm of the dipole. The antenna is therefore short-circuited for DC signals.</p>		

Additional EUT Data	
Manufactured by:	SPEAG
Manufactured on:	January 15, 1998

SAR Result with Head TSL

Test Laboratory: Imst GmbH, DASYS Yellow (II); File Name: [300911_y_1669.da4](#)

DUT: Dipole 1900 MHz SN: 5d051; Type: D1900V2; Serial: D1900V2 - SN5d051
Program Name: System Performance Check at 1900 MHz

Communication System: CW; Frequency: 1900 MHz; Duty Cycle: 1:1
Medium parameters used: $f = 1900$ MHz; $\sigma = 1.43$ mho/m; $\epsilon_r = 39.4$; $\rho = 1000$ kg/m³
Phantom section: Flat Section

DASY4 Configuration:

- Probe: ET3DV6R - SN1669; ConvF(5.12, 5.12, 5.12); Calibrated: 21.02.2011
- Sensor-Surface: 4mm (Mechanical Surface Detection)
- Electronics: DAE3 Sn335; Calibrated: 22.02.2011
- Phantom: SAM Glycol 1340; Type: QD 000 P40 CB; Serial: TP-1340
- Measurement SW: DASY4, V4.7 Build 80; Postprocessing SW: SEMCAD, V1.8 Build 186

d=10mm, Pin=250mW/Area Scan (7x7x1): Measurement grid: dx=10mm, dy=10mm

Maximum value of SAR (measured) = 10.4 mW/g

d=10mm, Pin=250mW/Zoom Scan (7x7x7)/Cube 0: Measurement grid: dx=5mm, dy=5mm, dz=5mm

Reference Value = 90.3 V/m; Power Drift = -0.025 dB

Peak SAR (extrapolated) = 17.0 W/kg

SAR(1 g) = 9.53 mW/g; SAR(10 g) = 4.93 mW/g

Maximum value of SAR (measured) = 10.7 mW/g

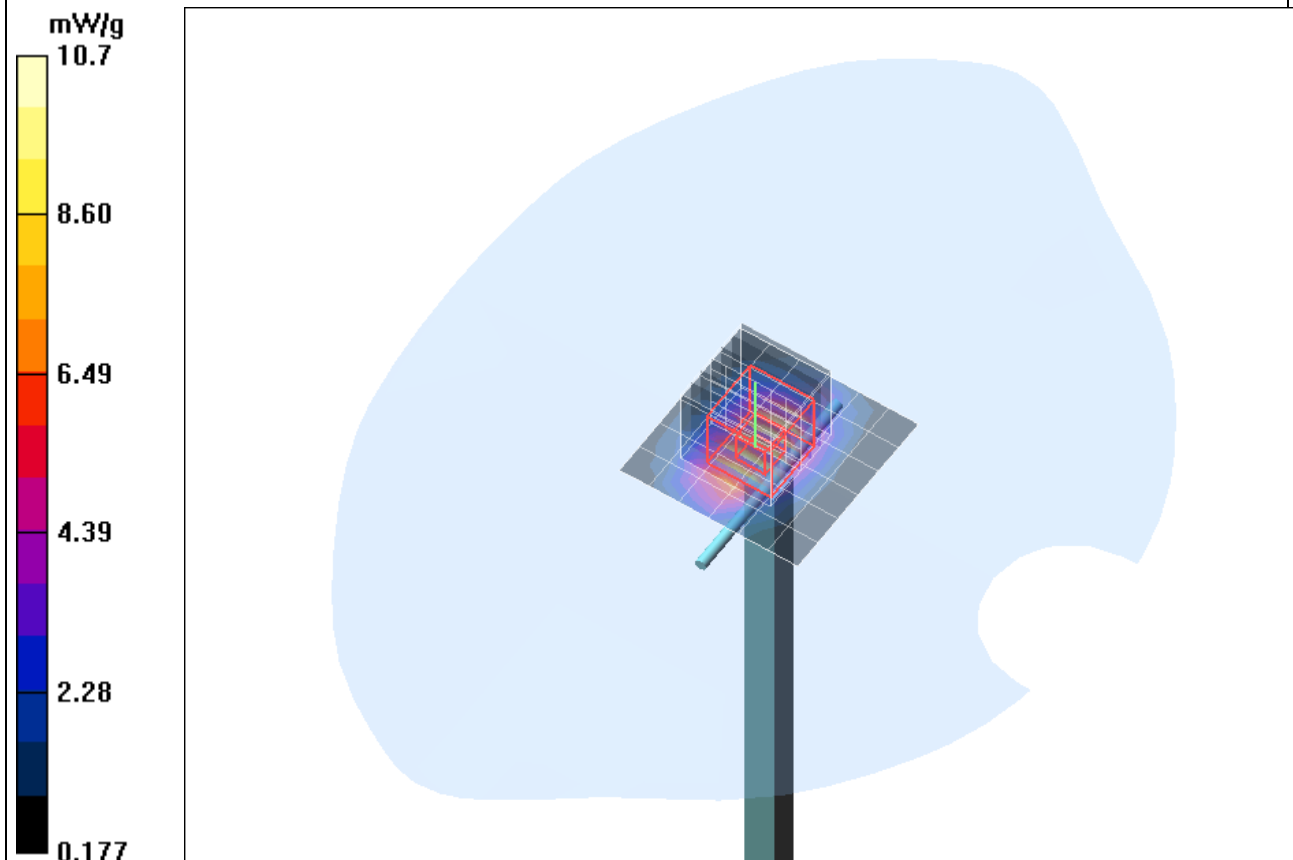

SAR Result with Body TSL

Test Laboratory: Imst GmbH, DASY Yellow (II); File Name: [300911_y_1669.da4](#)

DUT: Dipole 1900 MHz SN: 5d051; Type: D1900V2; Serial: D1900V2 - SN5d051
Program Name: System Performance Check at 1900 MHz

Communication System: CW; Frequency: 1900 MHz; Duty Cycle: 1:1
Medium parameters used: $f = 1900$ MHz; $\sigma = 1.54$ mho/m; $\epsilon_r = 52.1$; $\rho = 1000$ kg/m³
Phantom section: Flat Section

DASY4 Configuration:

- Probe: ET3DV6R - SN1669; ConvF(4.54, 4.54, 4.54); Calibrated: 21.02.2011
- Sensor-Surface: 4mm (Mechanical Surface Detection)
- Electronics: DAE3 Sn335; Calibrated: 22.02.2011
- Phantom: SAM Glycol 1340; Type: QD 000 P40 CB; Serial: TP-1340
- Measurement SW: DASY4, V4.7 Build 80; Postprocessing SW: SEMCAD, V1.8 Build 186

d=10mm, Pin=250mW/Area Scan (7x7x1): Measurement grid: dx=10mm, dy=10mm

Maximum value of SAR (measured) = 10.6 mW/g

d=10mm, Pin=250mW/Zoom Scan (7x7x7)/Cube 0: Measurement grid: dx=5mm, dy=5mm, dz=5mm

Reference Value = 89.6 V/m; Power Drift = 0.004 dB

Peak SAR (extrapolated) = 16.3 W/kg

SAR(1 g) = 9.66 mW/g; SAR(10 g) = 5.1 mW/g

Maximum value of SAR (measured) = 11.0 mW/g

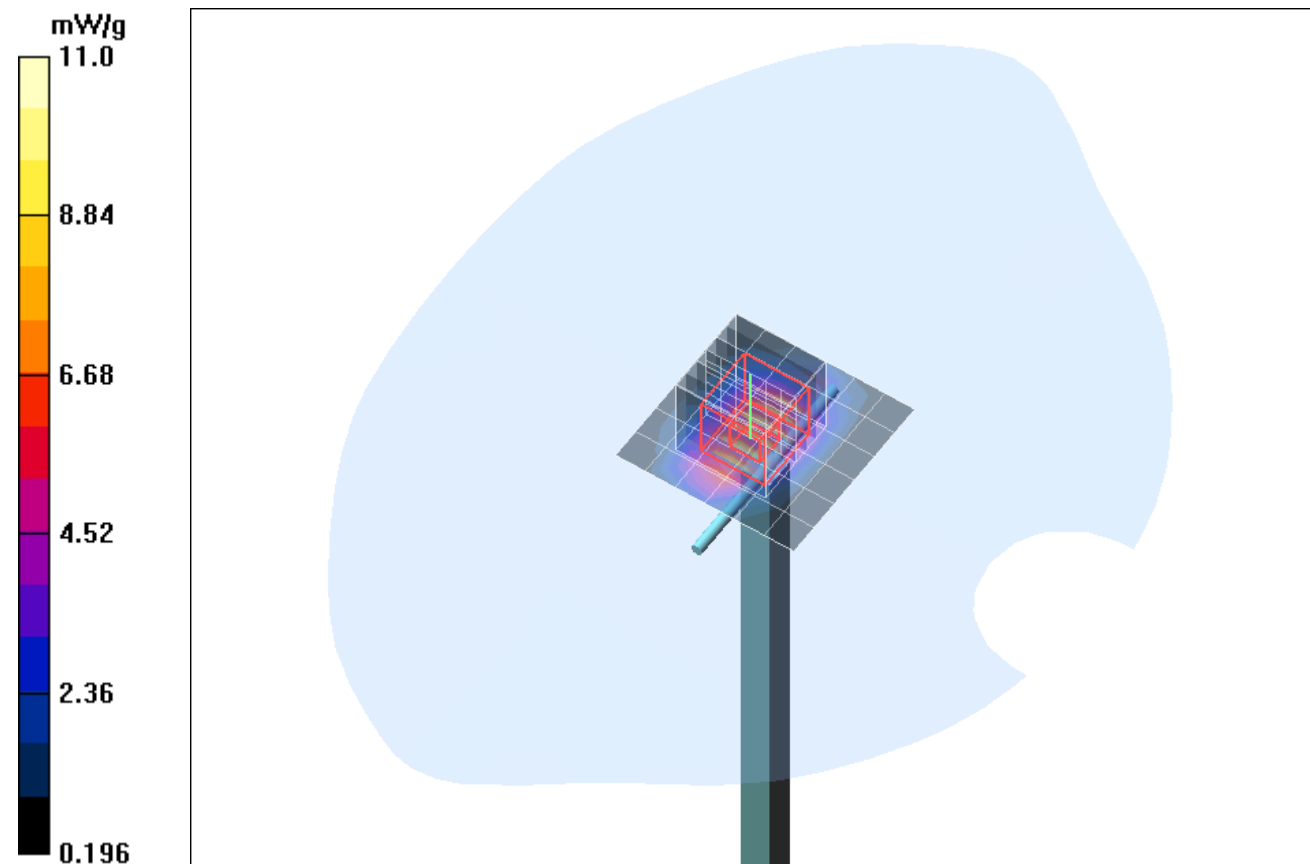

Impedance Measurements Plot for Head TSL

>1 1.9000000 GHz 48.454 Ω -710.06 m Ω 117.97 pF

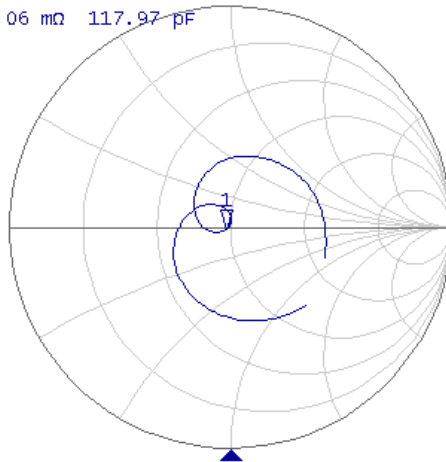

Tr2 S11 Log Mag 10.00dB/ Ref 0.000dB [F1]

>1 1.9000000 GHz -35.250 dB

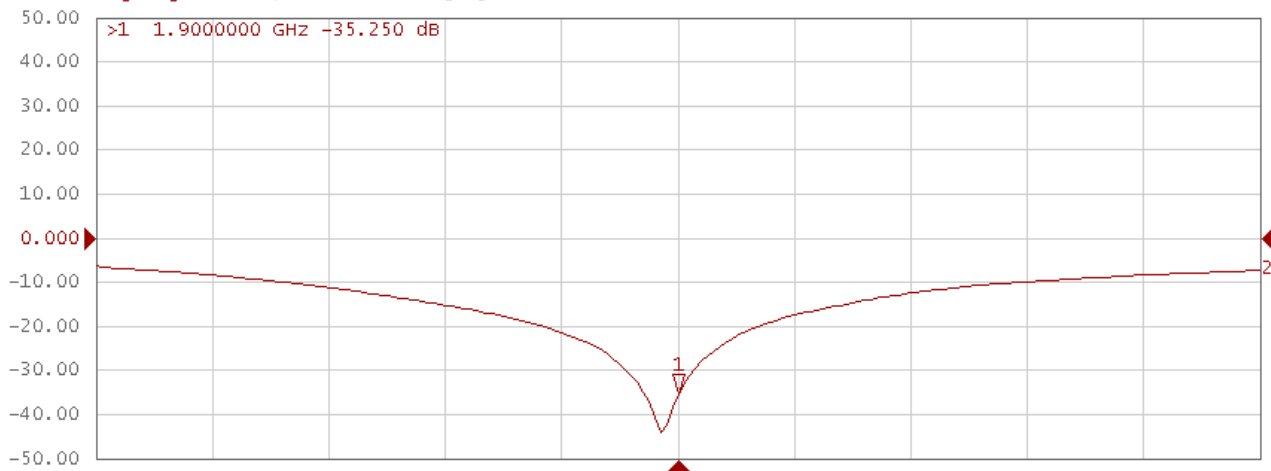

Impedance Measurements Plot for Body TSL

>1 1.9000000 GHz 52.766 Ω -1.7748 Ω 47.198 pF

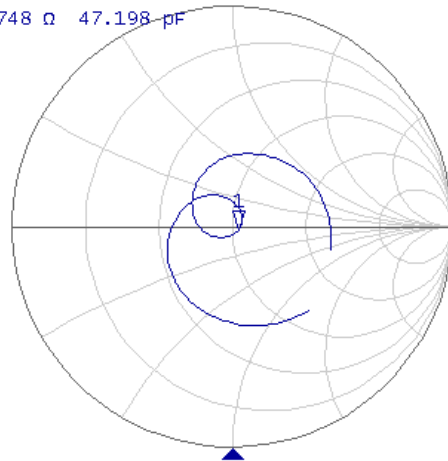

Tr2 S11 Log Mag 10.00dB/ Ref 0.000dB [F1]

>1 1.9000000 GHz -29.904 dB

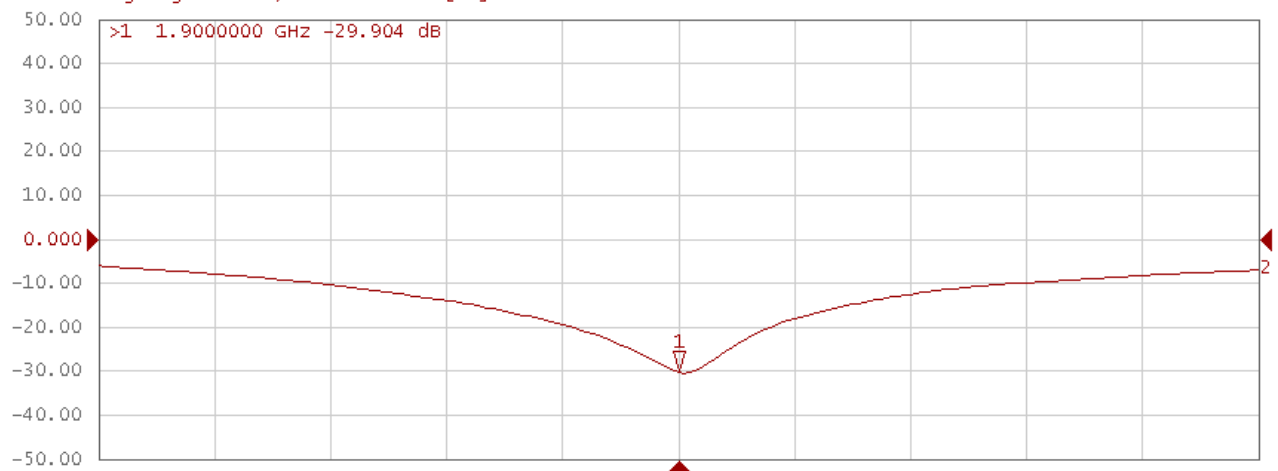

The Testcenter facility 'Dosimetric Test Lab' within IMST GmbH is accredited by the German National 'Deutsche Akkreditierungsstelle GmbH (DAkkS)' for testing according to the scope as listed in the accreditation certificate: D-PL-12139-01-01.

Calibration Certificate

Certificate No: Cal_D2450V2_SN709_1211
 Object: D2450V2 SN: 709
 Date of Calibration: December 30, 2011
 Next Calibration: December 2013
 Object Condition: In Tolerance

Calibration Equipment used:

Test Equipment	Serial Number	Last calibration	Calibrated by	Next calibration
Powermeter E4416A	GB41050414	Nov 10	Rohde&Schwarz (200954-D-K-15012-01-00-2010-11)	Nov 12
Power Sensor E9301H	US40010212	Nov 10	Rohde&Schwarz (200944-D-K-15012-01-00-2010-11)	Nov 12
Powermeter E4417A	GB41050441	Nov 10	Rohde&Schwarz (200952-D-K-15012-01-00-2010-11)	Nov 12
Power Sensor E9301A	MY41495584	Nov 10	Rohde&Schwarz (200953-D-K-15012-01-00-2010-11)	Nov 12
Network Analyzer E5071C	MY46103220	Aug 11	Rohde& Schwarz (14967-DKD-00201-2009-08)	Aug 13
Reference Probe EX3DV4	SN 3536	Sep 11	SPEAG, No EX-3-3536_Sep11	Sep 12
DAE4	SN 661	Sep 11	SPEAG, No DAE4-661_Sep11	Sep 12

Calibration is performed according the following standards:**IEEE 1528-2003**

"IEEE Recommended Practice for Determining the Peak Spatial - Averaged Specific Absorption Rate (SAR) in the Human Head from Wireless Communication Devices: Measurement Technique", December 2003

EN 62209-1

"Procedure to measure the Specific Absorption Rate (SAR) for hand - held devices used in close proximity to the ear (frequency range of 300 MHz to 3GHz)", March 2007

Federal Communications Commission Office of Engineering & Technologies (FCCOET)

"Evaluating Compliance with FCC Guidelines for Human Exposure to Radiofrequency Electromagnetic Fields; Additional Information for Evaluating Compliance of Mobile and Portable Devices with FCC Limits for Human Exposure to Radiofrequency Emissions", Supplement C (Edition 01-01) to Bulletin 65

Additional Documentation: DASY 4 System Handbook

prepared by:



Alexander Rahn
test engineer

reviewed by:



André van den Bosch
quality assurance engineer

Measurement Conditions		
DASY Version:	Dasy 4;	V4.7
Phantom:	SAM Phantom	1340
Distance Dipole Center – TSL:	10mm	With spacer
Zoom Scan res.	dx, dy, dz = 5mm	
Frequency:	2450 MHz \pm 1MHz	

Head TSL Parameters			
	Temperature	Permittivity	Conductivity
Nominal Head TSL Parameters	22.0	39.20	1.80
Measured Head TSL Parameters	21.6	39.90 \pm 6%	1.84 S/m \pm 6%

SAR Result with Head TSL			
Averaged over 1g	SAR measured	250mW input power	13.90 mW/g
	SAR normalized	normalized to 1W	55.60 mW/g
	SAR for nominal Head TSL parameters	normalized to 1W	55.23 mW/g \pm 16.5 % (k=2)
Averaged over 10g	SAR measured	250mW input power	6.26 mW/g
	SAR normalized	normalized to 1W	25.04 mW/g
	SAR for nominal Head TSL parameters	normalized to 1W	24.97 mW/g \pm 16.5 % (k=2)

Body TSL Parameters			
	Temperature	Permittivity	Conductivity
Nominal Body TSL Parameters	22.0	52.70	1.95
Measured Body TSL Parameters	21.5	51.20 ± 6%	2.00 S/m ± 6%

SAR Result with Body TSL			
Averaged over 1g	SAR measured	250mW input power	13.70 mW/g
	SAR normalized	normalized to 1W	54.80 mW/g
	SAR for nominal Body TSL parameters	normalized to 1W	53.77 mW/g ± 16.5 % (k=2)
Averaged over 10g	SAR measured	250mW input power	6.15 mW/g
	SAR normalized	normalized to 1W	24.60 mW/g
	SAR for nominal Body TSL parameters	normalized to 1W	24.33 mW/g ± 16.5 % (k=2)

General Antenna Parameters		
Antenna Parameters with Head TSL	Impedance, transformed to feed point	48.64 jΩ - 2.97 jΩ
	Return Loss	-29.60 dB
Antenna Parameter with Body TSL	Impedance, transformed to feed point	48.98 jΩ - 1.17 jΩ
	Return Loss	-36.09 dB
<p>After long term use with 100W radiated power, only a slight warming of the dipole near the feedpoint can be measured. The dipole is made of standard semigrd coaxial cable. The center conductor of the feeding line is directly connected to the second arm of the dipole. The antenna is therefore short-circuited for DC signals.</p>		

Additional EUT Data	
Manufactured by:	SPEAG
Manufactured on:	July 5, 2002

SAR Result with Head TSL

Test Laboratory: Imst GmbH, DASY Yellow (II); **File Name:** [29122011_y_3536.da4](#)

DUT: Dipole 2450 MHz SN: 709; **Type:** D2450V2; **Serial:** D2450V2 - SN:709
Program Name: System Performance Check at 2450 MHz

Communication System: CW; Frequency: 2450 MHz; Duty Cycle: 1:1
 Medium parameters used: $f = 2450 \text{ MHz}$; $\sigma = 1.84 \text{ mho/m}$; $\epsilon_r = 39.9$; $\rho = 1000 \text{ kg/m}^3$
 Phantom section: Flat Section

DASY4 Configuration:

- Probe: EX3DV4 - SN3536; ConvF(7.45, 7.45, 7.45); Calibrated: 26.09.2011
- Sensor-Surface: 4mm (Mechanical Surface Detection)
- Electronics: DAE4 Sn631; Calibrated: 21.09.2011
- Phantom: SAM Glycol 1340; Type: QD 000 P40 CB; Serial: TP-1340
- Measurement SW: DASY4, V4.7 Build 80; Postprocessing SW: SEMCAD, V1.8 Build 186

d=10mm, Pin=250mW/Area Scan (7x7x1): Measurement grid: dx=10mm, dy=10mm

Maximum value of SAR (measured) = 15.5 mW/g

d=10mm, Pin=250mW/Zoom Scan (7x7x7)/Cube 0: Measurement grid: dx=5mm, dy=5mm, dz=5mm

Reference Value = 92.7 V/m; Power Drift = 0.030 dB

Peak SAR (extrapolated) = 31.5 W/kg

SAR(1 g) = 13.9 mW/g; SAR(10 g) = 6.26 mW/g

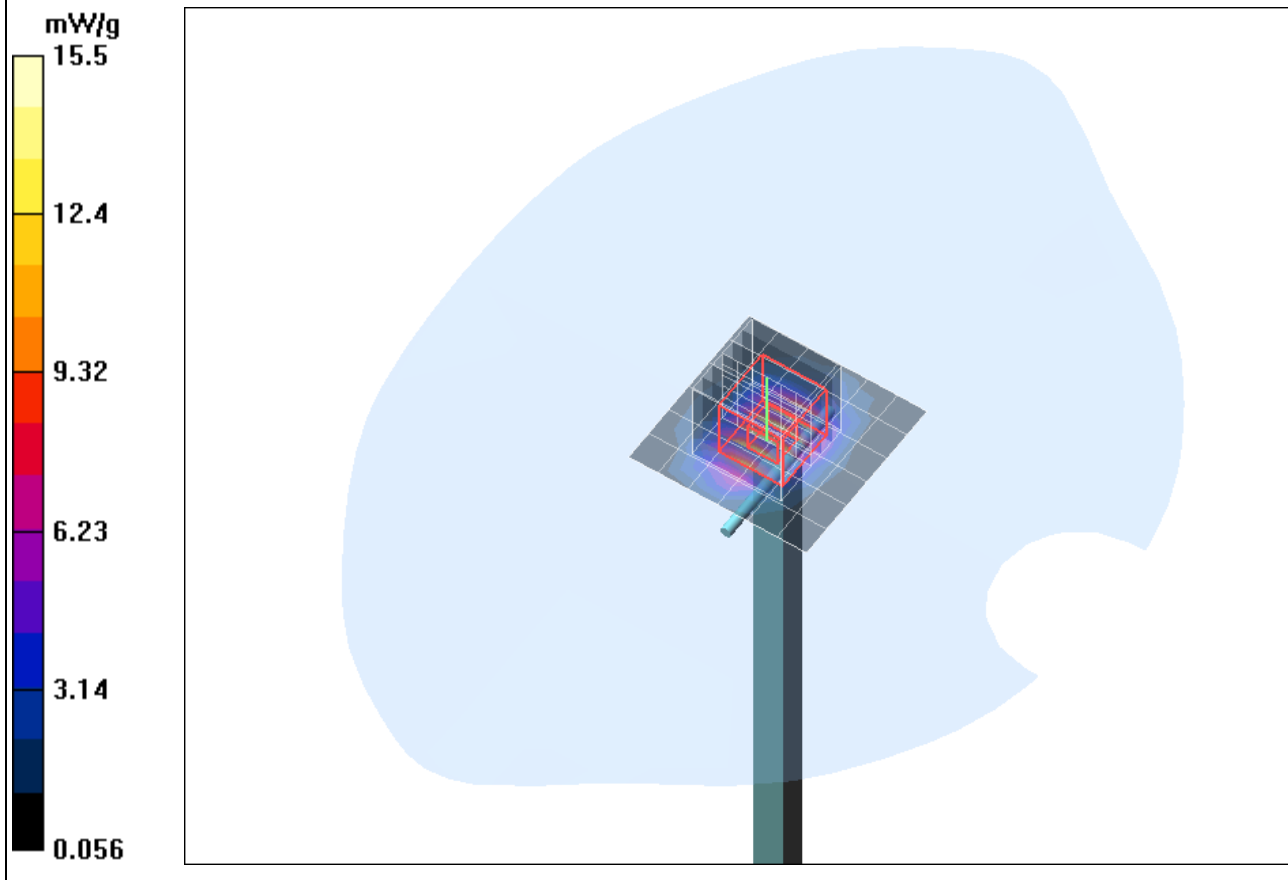

SAR Result with Body TSL

Test Laboratory: Imst GmbH, DASY Yellow (II); File Name: [301211_y_3536_2450.da4](#)

DUT: Dipole 2450 MHz SN: 709; Type: D2450V2; Serial: D2450V2 - SN:709
Program Name: System Performance Check at 2450 MHz

Communication System: CW; Frequency: 2450 MHz; Duty Cycle: 1:1
Medium parameters used: $f = 2450$ MHz; $\sigma = 2$ mho/m; $\epsilon_r = 51.2$; $\rho = 1000$ kg/m³
Phantom section: Flat Section

DASY4 Configuration:

- Probe: EX3DV4 - SN3536; ConvF(7.42, 7.42, 7.42); Calibrated: 26.09.2011
- Sensor-Surface: 4mm (Mechanical Surface Detection)
- Electronics: DAE4 Sn631; Calibrated: 21.09.2011
- Phantom: SAM Glycol 1340; Type: QD 000 P40 CB; Serial: TP-1340
- Measurement SW: DASY4, V4.7 Build 80; Postprocessing SW: SEMCAD, V1.8 Build 186

d=10mm, Pin=250mW/Area Scan (7x7x1): Measurement grid: dx=10mm, dy=10mm

Maximum value of SAR (measured) = 15.5 mW/g

d=10mm, Pin=250mW/Zoom Scan (7x7x7)/Cube 0: Measurement grid: dx=5mm, dy=5mm, dz=5mm

Reference Value = 88.7 V/m; Power Drift = -0.036 dB

Peak SAR (extrapolated) = 30.2 W/kg

SAR(1 g) = 13.7 mW/g; SAR(10 g) = 6.15 mW/g

Maximum value of SAR (measured) = 15.6 mW/g

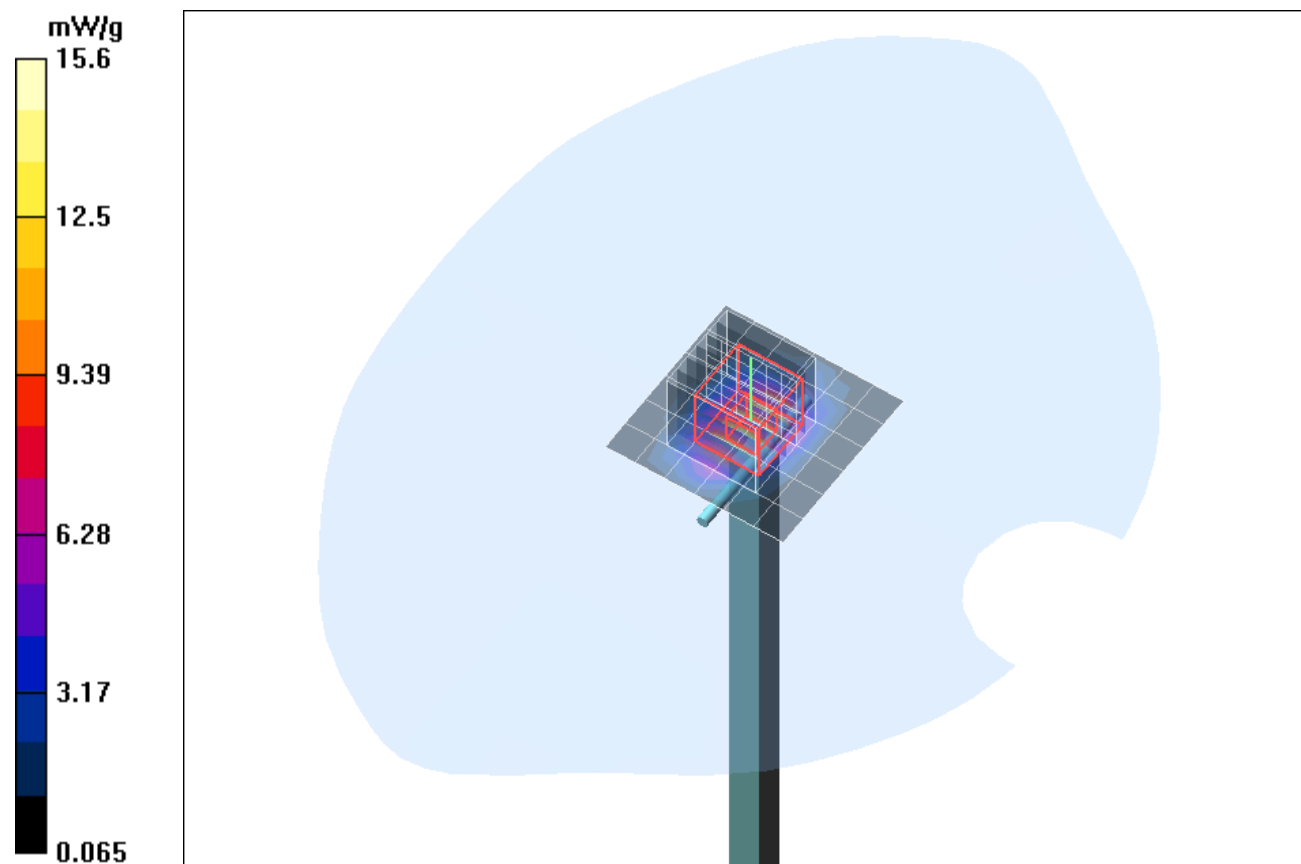

Impedance Measurements Plot for Head TSL

Tr1 S11 Smith (R+jX) scale 1.000u [F1]

>1 2.4500000 GHz 48.640 Ω 2.9709 Ω 193.00 pF

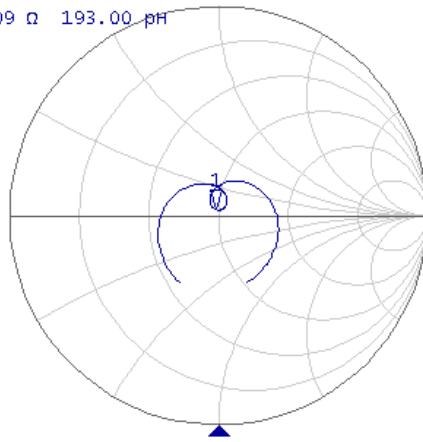

Tr2 S11 Log Mag 10.00dB/ Ref 0.000dB [F1]

>1 2.4500000 GHz -29.601 dB

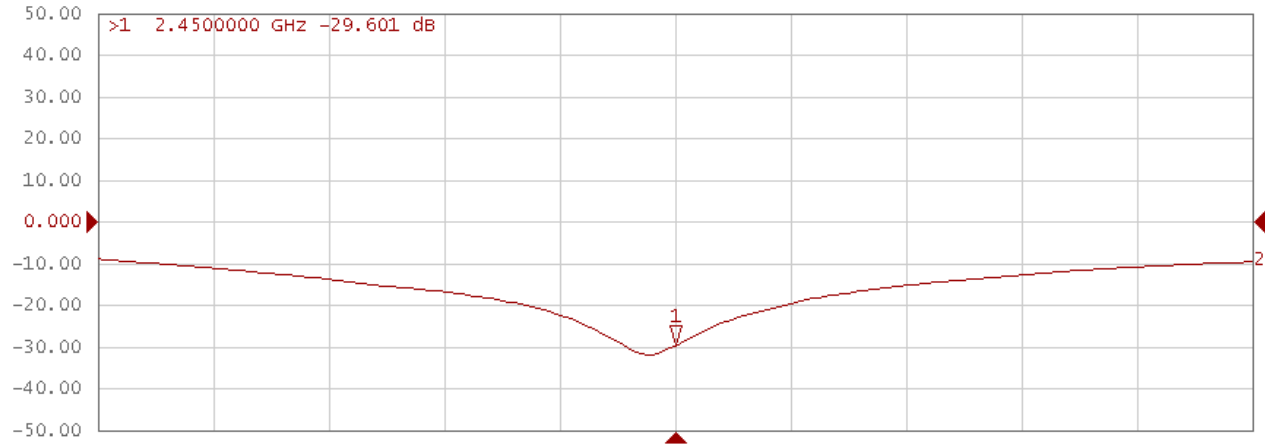

Impedance Measurements Plot for Body TSL

Tr1 S11 Smith (R+jX) scale 1.000U [F1]

>1 2.4500000 GHz 48.978 Ω 1.1698 Ω 75.993 μH

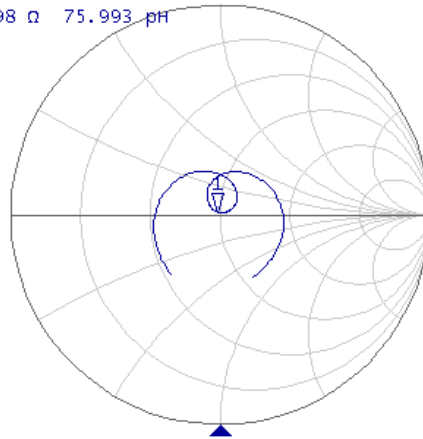

Tr2 S11 Log Mag 10.00dB/ Ref 0.000dB [F1]

>1 2.4500000 GHz -36.086 dB

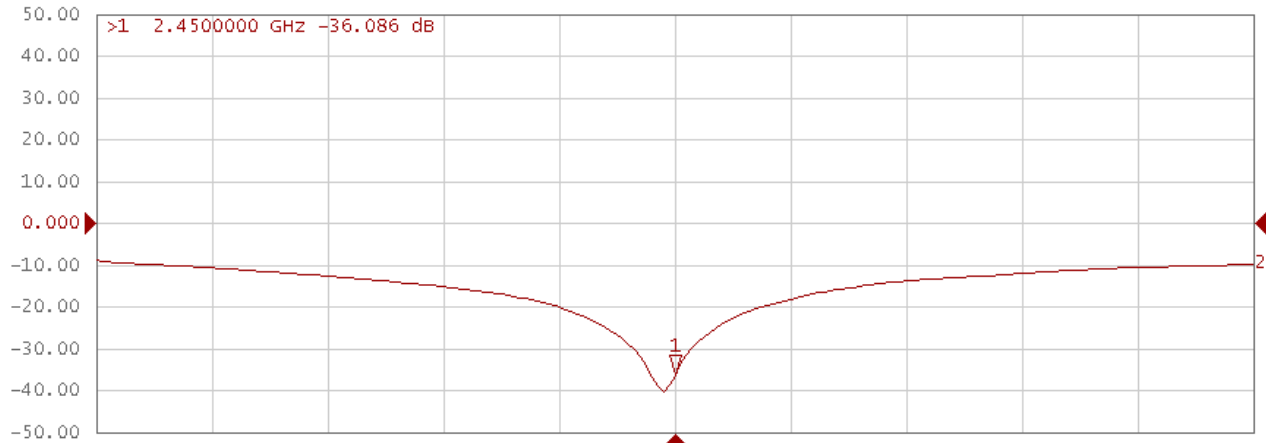

DAT-P-152/98-01

Calibration Certificate

Certificate No: Cal_D5GHzV2_SN1028_0410
 Object: D5GHzV2 SN: 1028
 Date of Calibration: April 27, 2010
 Next Calibration: April 2012
 Object Condition: In Tolerance

Calibration Equipment used:

Test Equipment	Serial Number	Last calibration	Calibrated by	Next calibration
Powermeter E4416A	GB41050414	Dec 08	Agilent Techn. (ISO/IEC 17025, 1-1784162174-1)	Dec 10
Power Sensor E9301H	US40010212	Dec 08	Agilent Techn. (ISO/IEC 17025, 1-1784041195-1)	Dec 10
Powermeter E4417A	GB41050441	Dec 08	Agilent Techn. (ISO/IEC 17025, 1-1674038198-1)	Dec 10
Power Sensor E9301A	MY41495584	Dec 08	Agilent Techn. (ISO/IEC 17025, 1-1784041307-1)	Dec 10
Network Analyzer E5071C	MY46103220	Aug 09	Rohde& Schwarz (14967-DKD-00201- 2009-08)	Aug 10
Reference Probe EX3DV4	SN 3536	Sep 09	SPEAG, No EX- 3536_Sep09	Sep 10
DAE4	SN 335	Feb 10	SPEAG, No DAE3- 335_Feb10	Feb 11

Calibration is performed according the following standards:**IEC 62209-1**

"Procedure to measure the Specific Absorption Rate (SAR) for hand - held devices used in close proximity to the ear (frequency range of 300 MHz to 3GHz)", February 2005

IEC 62209-2

"Evaluation of Human Exposure to Radio Frequency Fields from Handheld and Body-Mounted Wireless Communication Devices in the Frequency Range of 30 MHz to 6 GHz: Human models, Instrumentation, and Procedures ", Part 2: "Procedure to determine the Specific Absorption Rate (SAR) for including accessories and multiple transmitters" Edition 1.0, 2010-01

Federal Communications Commission Office of Engineering & Technologies (FCCOET)

"Evaluating Compliance wit FCC Guidelines for Human Exposure to Radiofrequency Electromagnetic Fields; Additional Information for Evaluating Compliance of Mobile and Portable Devices with FCC Limits for Human Exposure to Radiofrequency Emissions", Supplement C (Edition 01-01) to Bulletin 65

Additional Documentation: DASY 4/5 System Handbook

prepared by:



Alexander Rahn
test engineer

reviewed by:



André van den Bosch
quality assurance engineer

Measurement Conditions		
DASY Version:	Dasy 4;	V4.7
Phantom:	SAM Phantom	1176
Distance Dipole Center – TSL:	10mm	With spacer
Area Scan res.	dx, dy = 7.5mm	
Zoom Scan res.	dx, dy = 4.3mm, dz = 3mm	
Frequency:	5200 MHz ± 1MHz 5500 MHz ± 1MHz 5800 MHz ± 1MHz	

Head TSL Parameters at 5200 MHz			
	Temperature	Permittivity	Conductivity
Nominal Head TSL Parameters	22.0	36.0	4.66
Measured Head TSL Parameters	22.0	37.5 ± 6%	4.89 S/m ± 6%

SAR result with Head TSL at 5200 MHz			
Averaged over 1g	SAR measured	250 mW input power	20.90
	SAR normalized	normalized to 1W	83.60 mW/g
	SAR for nominal Head TSL parameters	normalized to 1W	84.41 mW/g ± 16.5 % (k=2)
Averaged over 10g	SAR measured	250 mW input power	5.96 mW/g
	SAR normalized	normalized to 1W	23.84 mW/g
	SAR for nominal Head TSL parameters	normalized to 1W	24.16 mW/g ± 16.5 % (k=2)

Head TSL Parameters at 5500 MHz			
	Temperature	Permittivity	Conductivity
Nominal Head TSL Parameters	22.0	35.6	4.96
Measured Head TSL Parameters	22.0	36.8 ± 6%	5.21 S/m ± 6%

SAR result with Head TSL at 5500 MHz			
Averaged over 1g	SAR measured	250 mW input power	21.50 mW/g
	SAR normalized	normalized to 1W	86.00 mW/g
	SAR for nominal Head TSL parameters	normalized to 1W	86.76 mW/g ± 16.5 % (k=2)
Averaged over 10g	SAR measured	250 mW input power	6.00 mW/g
	SAR normalized	normalized to 1W	24.00 mW/g
	SAR for nominal Head TSL parameters	normalized to 1W	24.27 mW/g ± 16.5 % (k=2)

Head TSL Parameters at 5800 MHz			
	Temperature	Permittivity	Conductivity
Nominal Head TSL Parameters	22.0	35.3	5.27
Measured Head TSL Parameters	22.0	36.1 ± 6%	5.53 S/m ± 6%

SAR result with Head TSL at 5800 MHz			
Averaged over 1g	SAR measured	250 mW input power	20.80 mW/g
	SAR normalized	normalized to 1W	83.20 mW/g
	SAR for nominal Head TSL parameters	normalized to 1W	83.76 mW/g ± 16.5 % (k=2)
Averaged over 10g	SAR measured	250 mW input power	5.82 mW/g
	SAR normalized	normalized to 1W	23.28 mW/g
	SAR for nominal Head TSL parameters	normalized to 1W	23.45 mW/g ± 16.5 % (k=2)

Body TSL Parameters at 5200 MHz			
	Temperature	Permittivity	Conductivity
Nominal Body TSL Parameters	22.0	49.0	5.30
Measured Body TSL Parameters	22.0	47.3 ± 6%	5.38 S/m ± 6%

SAR result with Body TSL at 5200 MHz			
Averaged over 1g	SAR measured	250 mW input power	20.10 mW/g
	SAR normalized	normalized to 1W	80.40 mW/g
	SAR for nominal Body TSL parameters	normalized to 1W	79.98 mW/g ± 16.5 % (k=2)
Averaged over 10g	SAR measured	250 mW input power	5.69 mW/g
	SAR normalized	normalized to 1W	22.76 mW/g
	SAR for nominal Body TSL parameters	normalized to 1W	22.64 mW/g ± 16.5 % (k=2)

Body TSL Parameters at 5500 MHz			
	Temperature	Permittivity	Conductivity
Nominal Body TSL Parameters	22.0	48.6	5.65
Measured Body TSL Parameters	22.0	46.80 ± 6%	5.84 S/m ± 6%

SAR result with Body TSL at 5500 MHz			
Averaged over 1g	SAR measured	250 mW input power	21.20 mW/g
	SAR normalized	normalized to 1W	84.80 mW/g
	SAR for nominal Body TSL parameters	normalized to 1W	84.29 mW/g ± 16.5 % (k=2)
Averaged over 10g	SAR measured	250 mW input power	5.84 mW/g
	SAR normalized	normalized to 1W	23.36 mW/g
	SAR for nominal Body TSL parameters	normalized to 1W	23.17 mW/g ± 16.5 % (k=2)

Body TSL Parameters at 5800 MHz			
	Temperature	Permittivity	Conductivity
Nominal Body TSL Parameters	22.0	48.20	6.00
Measured Body TSL Parameters	22.0	46.10 ± 6%	6.29 S/m ± 6%

SAR result with Body TSL at 5800 MHz			
Averaged over 1g	SAR measured	250 mW input power	19.10 mW/g
	SAR normalized	normalized to 1W	76.40 mW/g
	SAR for nominal Body TSL parameters	normalized to 1W	75.90 mW/g ± 16.5 % (k=2)
Averaged over 10g	SAR measured	250 mW input power	5.32 mW/g
	SAR normalized	normalized to 1W	21.28 mW/g
	SAR for nominal Body TSL parameters	normalized to 1W	21.08 mW/g ± 16.5 % (k=2)

General Antenna Parameters at 5200 MHz		
Antenna Parameters with Head TSL	Impedance, transformed to feed point	44.6 Ω – 6.96 jΩ
	Return Loss	-20.68 dB
Antenna Parameter with Body TSL	Impedance, transformed to feed point	45.4 Ω - 4.59 jΩ
	Return Loss	-23.38 dB

General Antenna Parameters at 5500 MHz		
Antenna Parameters with Head TSL	Impedance, transformed to feed point	50.0 Ω - -5.06 jΩ
	Return Loss	-25.93 dB
Antenna Parameter with Body TSL	Impedance, transformed to feed point	51.3 Ω - -2.48 jΩ
	Return Loss	-25.93 dB

General Antenna Parameters at 5800 MHz		
Antenna Parameters with Head TSL	Impedance, transformed to feed point	59.3 Ω - -0.50 jΩ
	Return Loss	-21.35 dB
Antenna Parameter with Body TSL	Impedance, transformed to feed point	57.6 Ω - 3.40 jΩ
	Return Loss	-22.25 dB

After long term use with 40W radiated power, only a slight warming of the dipole near the feedpoint can be measured. The dipole is made of standard semigrd coaxial cable. The center conductor of the feeding line is directly connected to the second arm of the dipole. The antenna is therefore short-circuited for DC signals.

Additional EUT Data	
Manufactured by:	SPEAG
Manufactured on:	July 9, 2004

SAR result with Head TSL at 5200 MHz

Test Laboratory: IMST GmbH, DASY Blue (I); File Name: [270410_b_3536_5200.da4](#)

DUT: Dipole 5GHz SN: 1028; Type: D5GHzV2; Serial: D5GHzV2 - SN:1028
Program Name: System Performance Check at 5200 MHz

Communication System: CW; Frequency: 5200 MHz; Duty Cycle: 1:1
Medium parameters used: $f = 5200$ MHz; $\sigma = 4.89$ mho/m; $\epsilon_r = 37.5$; $\rho = 1000$ kg/m³
Phantom section: Flat Section

DASY4 Configuration:

- Probe: EX3DV4 - SN3536; ConvF(5.24, 5.24, 5.24); Calibrated: 18.09.2009
- Sensor-Surface: 2mm (Mechanical Surface Detection)
- Electronics: DAE3 Sn335; Calibrated: 10.02.2010
- Phantom: SAM Glycol 1176; Type: Speag; Serial: 1176
- Measurement SW: DASY4, V4.7 Build 80; Postprocessing SW: SEMCAD, V1.8 Build 186

d=10mm, Pin=250mW/Area Scan (14x14x1): Measurement grid: dx=7.5mm, dy=7.5mm

Maximum value of SAR (measured) = 37.3 mW/g

d=10mm, Pin=250mW/Zoom Scan (8x8x8)/Cube 0: Measurement grid: dx=4.3mm, dy=4.3mm, dz=3mm

Reference Value = 89.7 V/m; Power Drift = -0.063 dB

Peak SAR (extrapolated) = 85.3 W/kg

SAR(1 g) = 20.9 mW/g; SAR(10 g) = 5.96 mW/g

Maximum value of SAR (measured) = 39.9 mW/g

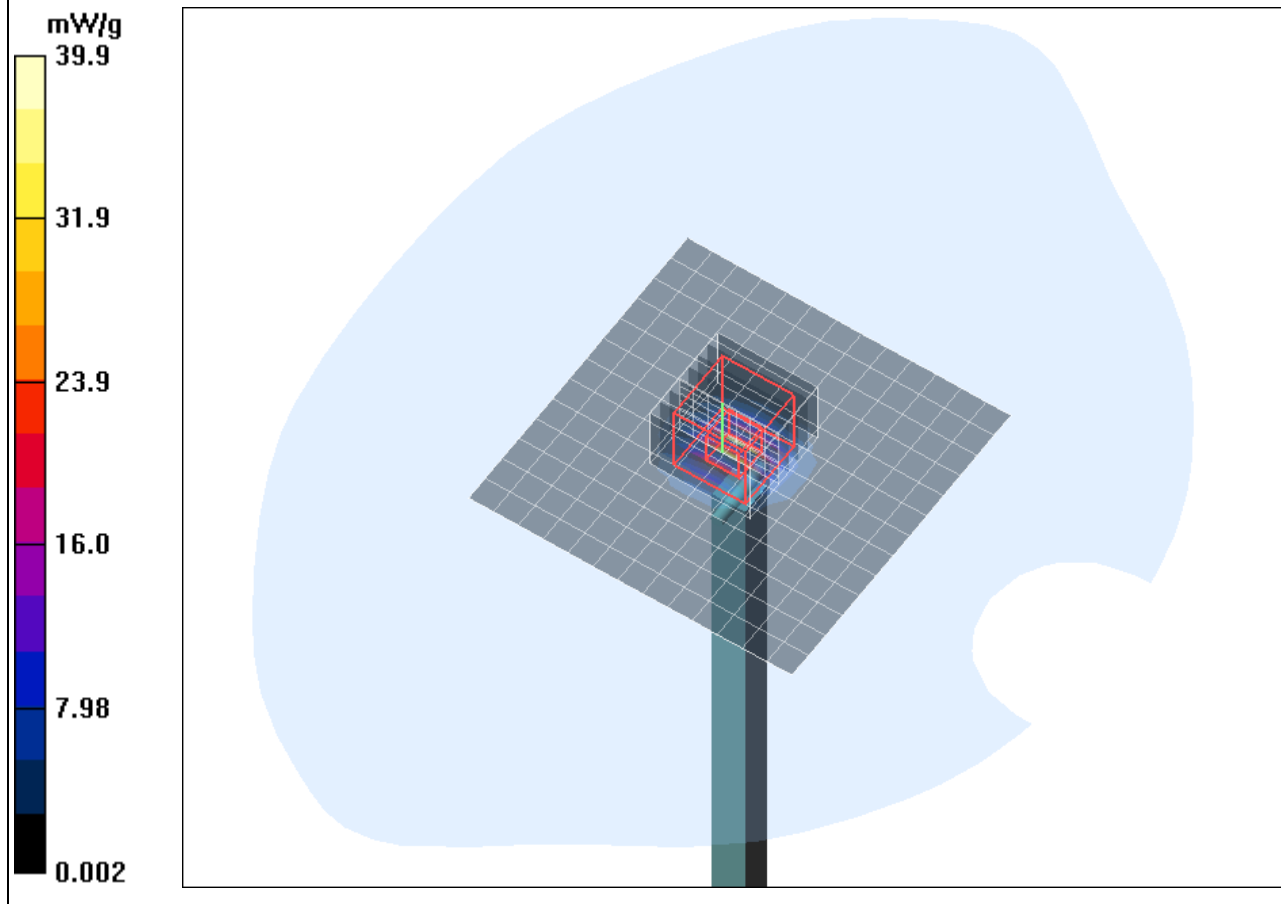

SAR result with Head TSL at 5500 MHz

Test Laboratory: IMST GmbH, DASY Blue (I); File Name: [270410_b_3536_5500.da4](#)

DUT: Dipole 5GHz SN: 1028; Type: D5GHzV2; Serial: D5GHzV2 - SN:1028
 Program Name: System Performance Check at 5500 MHz

Communication System: CW; Frequency: 5500 MHz; Duty Cycle: 1:1
 Medium parameters used: $f = 5500 \text{ MHz}$; $\sigma = 5.21 \text{ mho/m}$; $\epsilon_r = 36.8$; $\rho = 1000 \text{ kg/m}^3$
 Phantom section: Flat Section

DASY4 Configuration:

- Probe: EX3DV4 - SN3536; ConvF(4.93, 4.93, 4.93); Calibrated: 18.09.2009
- Sensor-Surface: 2mm (Mechanical Surface Detection)
- Electronics: DAE3 Sn335; Calibrated: 10.02.2010
- Phantom: SAM Glycol 1176; Type: Speag; Serial: 1176
- Measurement SW: DASY4, V4.7 Build 80; Postprocessing SW: SEMCAD, V1.8 Build 186

d=10mm, Pin=250mW/Area Scan (14x14x1): Measurement grid: dx=7.5mm, dy=7.5mm

Maximum value of SAR (measured) = 38.6 mW/g

d=10mm, Pin=250mW/Zoom Scan (8x8x8)/Cube 0: Measurement grid: dx=4.3mm, dy=4.3mm, dz=3mm

Reference Value = 87.5 V/m; Power Drift = 0.065 dB

Peak SAR (extrapolated) = 94.5 W/kg

SAR(1 g) = 21.5 mW/g; SAR(10 g) = 6 mW/g

Maximum value of SAR (measured) = 42.5 mW/g

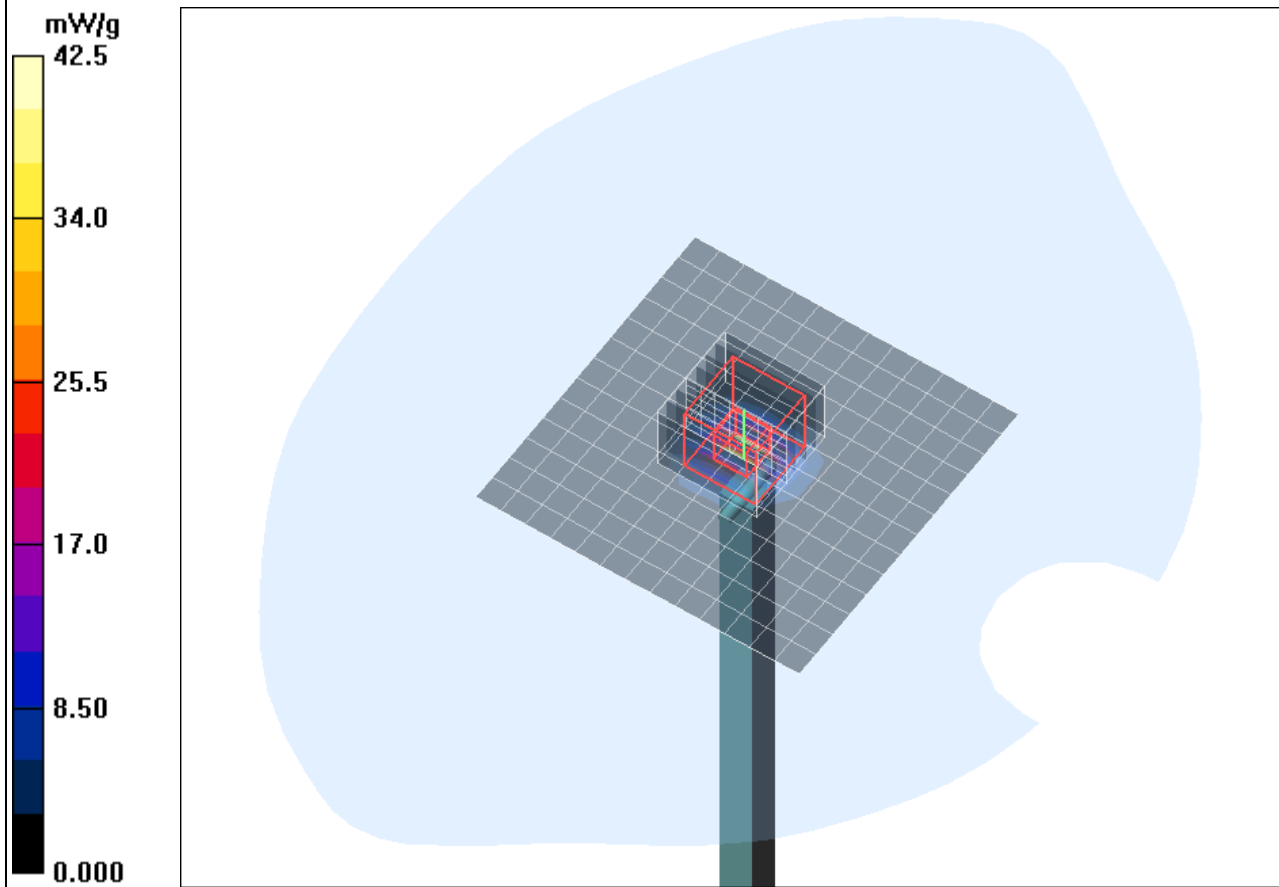

SAR result with Head TSL at 5800 MHz

Test Laboratory: IMST GmbH, DASY Blue (I); File Name: [270410_b_3536_5800.da4](#)

DUT: Dipole 5GHz SN: 1028; Type: D5GHzV2; Serial: D5GHzV2 - SN:1028
 Program Name: System Performance Check at 5800 MHz

Communication System: CW; Frequency: 5800 MHz; Duty Cycle: 1:1
 Medium parameters used: $f = 5800 \text{ MHz}$; $\sigma = 5.53 \text{ mho/m}$; $\epsilon_r = 36.1$; $\rho = 1000 \text{ kg/m}^3$
 Phantom section: Flat Section

DASY4 Configuration:

- Probe: EX3DV4 - SN3536; ConvF(4.63, 4.63, 4.63); Calibrated: 18.09.2009
- Sensor-Surface: 2mm (Mechanical Surface Detection)
- Electronics: DAE3 Sn335; Calibrated: 10.02.2010
- Phantom: SAM Glycol 1176; Type: Speag; Serial: 1176
- Measurement SW: DASY4, V4.7 Build 80; Postprocessing SW: SEMCAD, V1.8 Build 186

d=10mm, Pin=250mW/Area Scan (14x14x1): Measurement grid: dx=7.5mm, dy=7.5mm

Maximum value of SAR (measured) = 39.4 mW/g

d=10mm, Pin=250mW/Zoom Scan (8x8x8)/Cube 0: Measurement grid: dx=4.3mm, dy=4.3mm, dz=3mm

Reference Value = 85.1 V/m; Power Drift = 0.024 dB

Peak SAR (extrapolated) = 91.7 W/kg

SAR(1 g) = 20.8 mW/g; SAR(10 g) = 5.82 mW/g

Maximum value of SAR (measured) = 40.1 mW/g

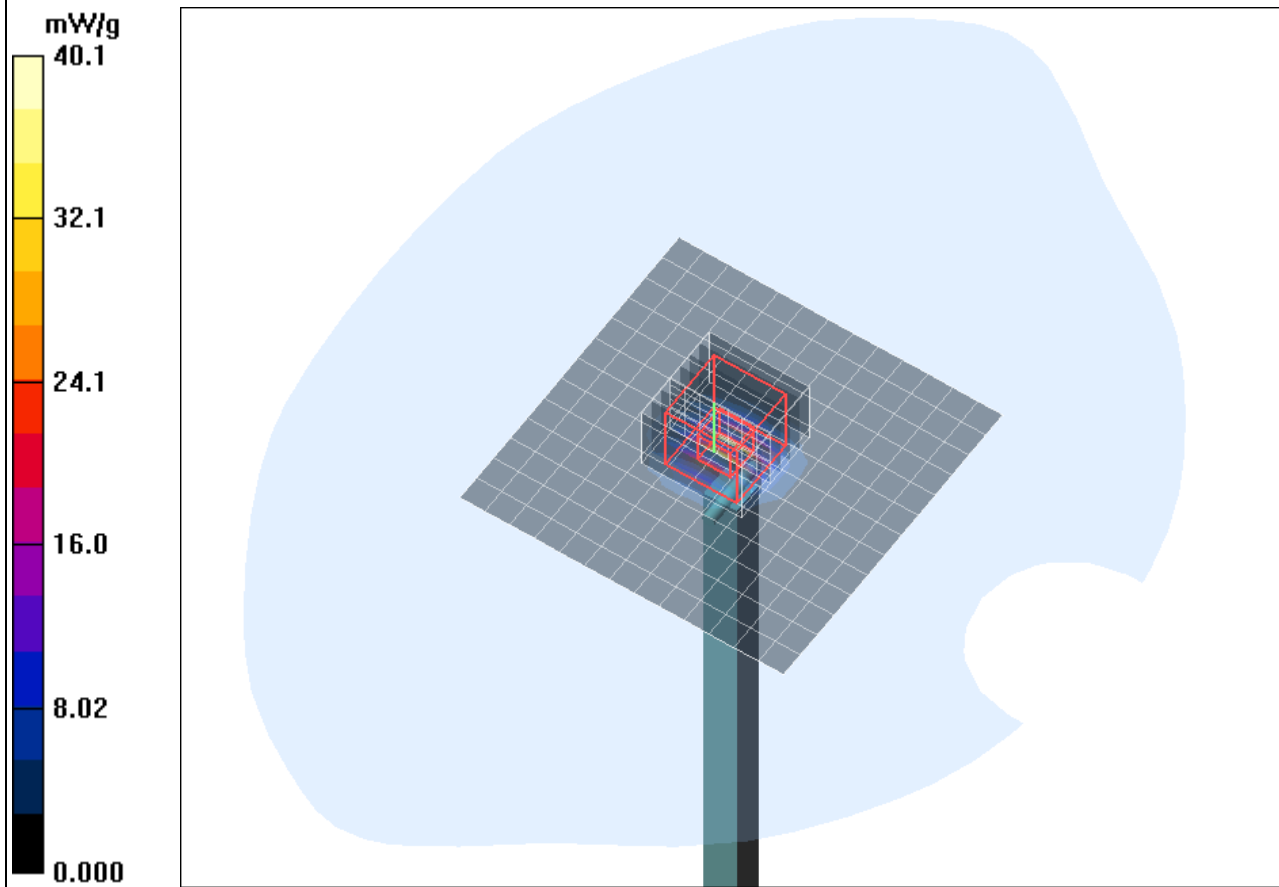

SAR result with Body TSL at 5200 MHz

Test Laboratory: IMST GmbH, DASY Blue (I); File Name: [260410_b_3536_5200.da4](#)

DUT: Dipole 5GHz SN: 1028; Type: D5GHzV2; Serial: D5GHzV2 - SN:1028
Program Name: System Performance Check at 5200 MHz

Communication System: CW; Frequency: 5200 MHz; Duty Cycle: 1:1
Medium parameters used: $f = 5200$ MHz; $\sigma = 5.38$ mho/m; $\epsilon_r = 47.3$; $\rho = 1000$ kg/m³
Phantom section: Flat Section

DASY4 Configuration:

- Probe: EX3DV4 - SN3536; ConvF(4.54, 4.54, 4.54); Calibrated: 18.09.2009
- Sensor-Surface: 2mm (Mechanical Surface Detection)
- Electronics: DAE3 Sn335; Calibrated: 10.02.2010
- Phantom: SAM Glycol 1176; Type: Speag; Serial: 1176
- Measurement SW: DASY4, V4.7 Build 80; Postprocessing SW: SEMCAD, V1.8 Build 186

d=10mm, Pin=250mW/Area Scan (14x14x1): Measurement grid: dx=7.5mm, dy=7.5mm

Maximum value of SAR (measured) = 35.2 mW/g

d=10mm, Pin=250mW/Zoom Scan (8x8x8)/Cube 0: Measurement grid: dx=4.3mm, dy=4.3mm, dz=3mm

Reference Value = 85.5 V/m; Power Drift = 0.071 dB

Peak SAR (extrapolated) = 75.9 W/kg

SAR(1 g) = 20.1 mW/g; SAR(10 g) = 5.69 mW/g

Maximum value of SAR (measured) = 38.1 mW/g

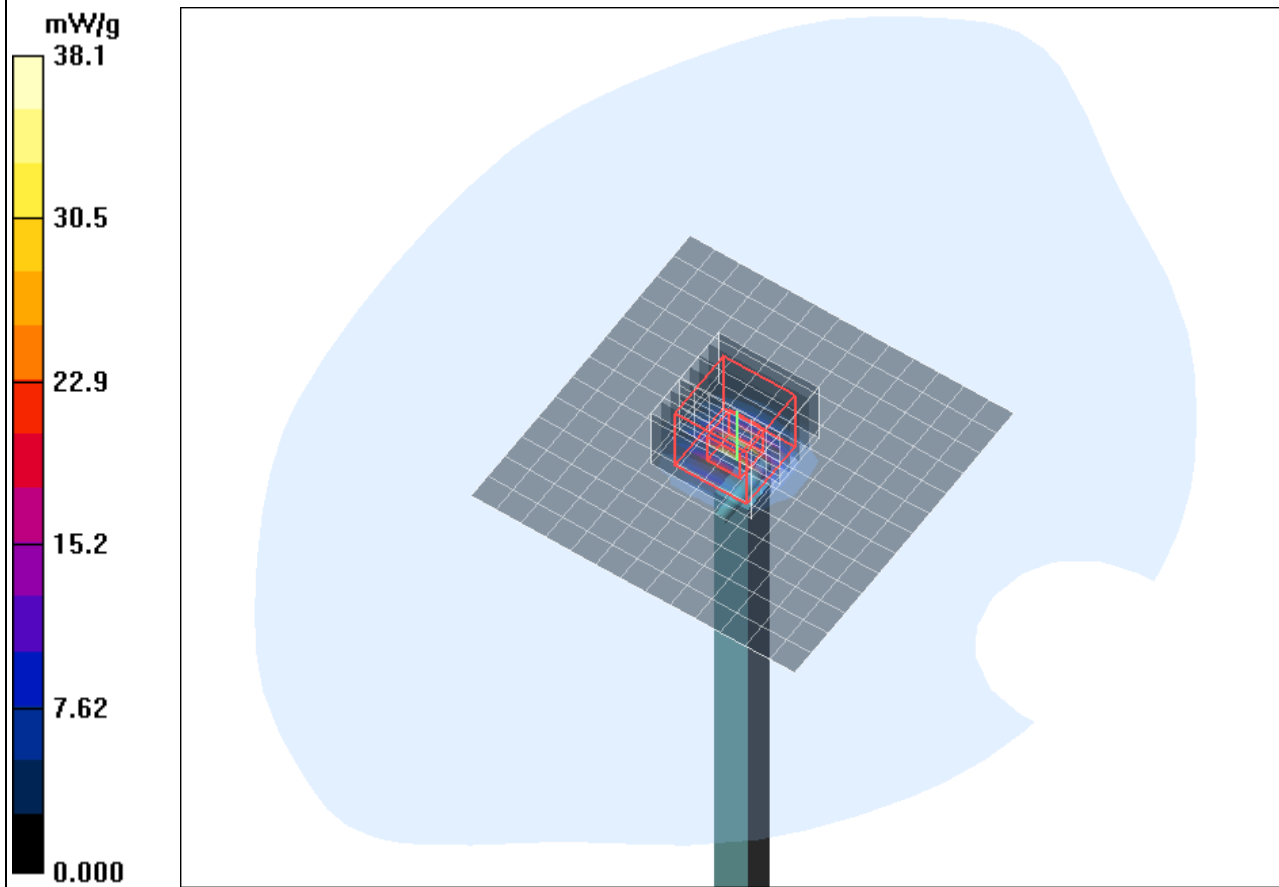

SAR result with Body TSL at 5500 MHz

Test Laboratory: IMST GmbH, DASY Blue (I); File Name: [260410_b_3536_5500.da4](#)

DUT: Dipole 5GHz SN: 1028; Type: D5GHzV2; Serial: D5GHzV2 - SN:1028
Program Name: System Performance Check at 5500 MHz

Communication System: CW; Frequency: 5500 MHz; Duty Cycle: 1:1
Medium parameters used: $f = 5500$ MHz; $\sigma = 5.84$ mho/m; $\epsilon_r = 46.8$; $\rho = 1000$ kg/m³
Phantom section: Flat Section

DASY4 Configuration:

- Probe: EX3DV4 - SN3536; ConvF(4.22, 4.22, 4.22); Calibrated: 18.09.2009
- Sensor-Surface: 2mm (Mechanical Surface Detection)
- Electronics: DAE3 Sn335; Calibrated: 10.02.2010
- Phantom: SAM Glycol 1176; Type: Speag; Serial: 1176
- Measurement SW: DASY4, V4.7 Build 80; Postprocessing SW: SEMCAD, V1.8 Build 186

d=10mm, Pin=250mW/Area Scan (14x14x1): Measurement grid: dx=7.5mm, dy=7.5mm

Maximum value of SAR (measured) = 39.9 mW/g

d=10mm, Pin=250mW/Zoom Scan (8x8x8)/Cube 0: Measurement grid: dx=4.3mm, dy=4.3mm, dz=3mm

Reference Value = 82.8 V/m; Power Drift = 0.111 dB

Peak SAR (extrapolated) = 86.8 W/kg

SAR(1 g) = 21.2 mW/g; SAR(10 g) = 5.84 mW/g

Maximum value of SAR (measured) = 42.5 mW/g

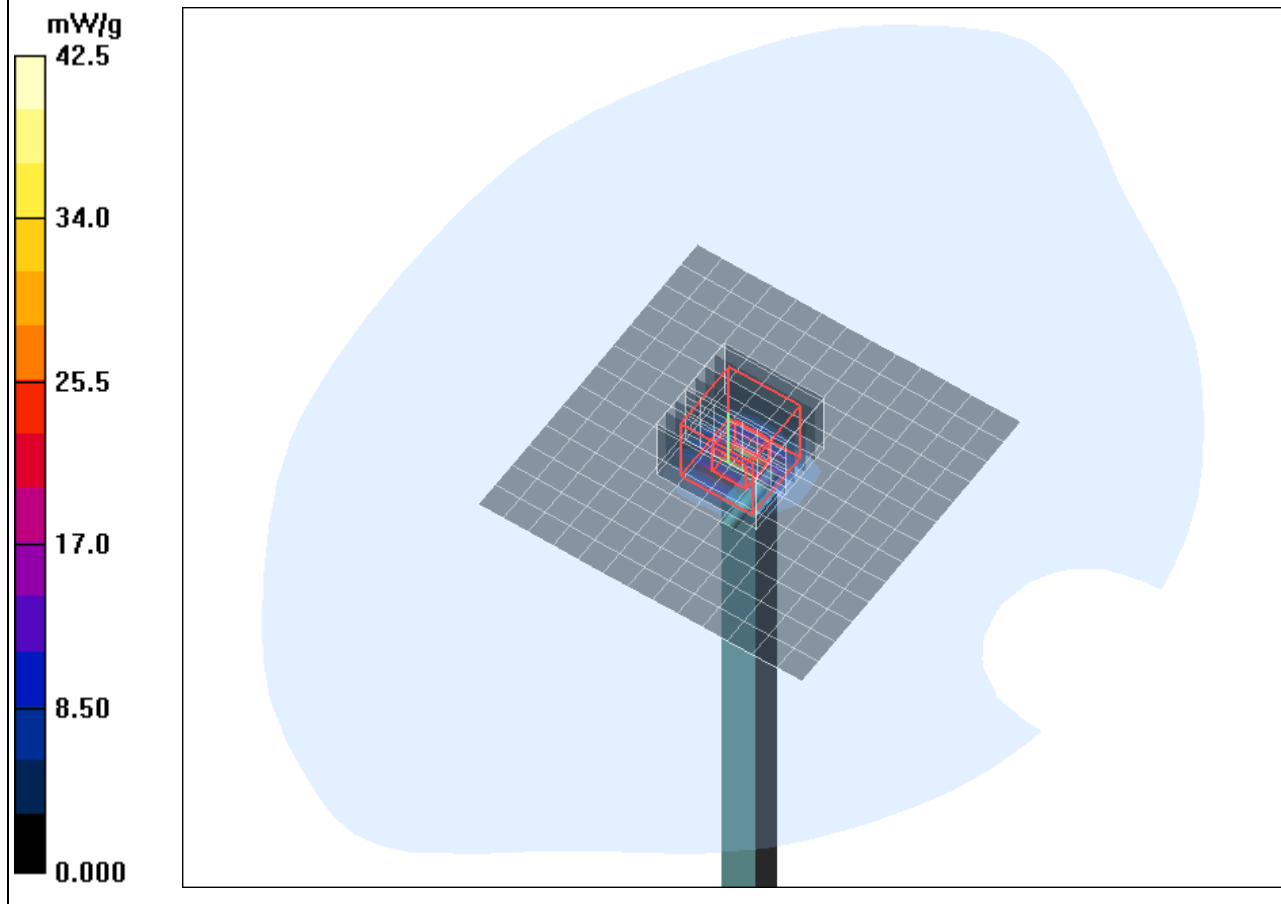

SAR result with Body TSL at 5800 MHz

Test Laboratory: IMST GmbH, DASY Blue (I); File Name: [260410_b_3536_5800.da4](#)

DUT: Dipole 5GHz SN: 1028; Type: D5GHzV2; Serial: D5GHzV2 - SN:1028
Program Name: System Performance Check at 5800 MHz

Communication System: CW; Frequency: 5800 MHz; Duty Cycle: 1:1
Medium parameters used: $f = 5800$ MHz; $\sigma = 6.29$ mho/m; $\epsilon_r = 46.1$; $\rho = 1000$ kg/m³
Phantom section: Flat Section

DASY4 Configuration:

- Probe: EX3DV4 - SN3536; ConvF(4.2, 4.2, 4.2); Calibrated: 18.09.2009
- Sensor-Surface: 2mm (Mechanical Surface Detection)
- Electronics: DAE3 Sn335; Calibrated: 10.02.2010
- Phantom: SAM Glycol 1176; Type: Speag; Serial: 1176
- Measurement SW: DASY4, V4.7 Build 80; Postprocessing SW: SEMCAD, V1.8 Build 186

d=10mm, Pin=250mW/Area Scan (14x14x1): Measurement grid: dx=7.5mm, dy=7.5mm

Maximum value of SAR (measured) = 36.0 mW/g

d=10mm, Pin=250mW/Zoom Scan (8x8x8)/Cube 0: Measurement grid: dx=4.3mm, dy=4.3mm, dz=3mm

Reference Value = 78.0 V/m; Power Drift = 0.005 dB

Peak SAR (extrapolated) = 76.8 W/kg

SAR(1 g) = 19.1 mW/g; SAR(10 g) = 5.32 mW/g

Maximum value of SAR (measured) = 38.2 mW/g

