

Plot 1: 5180MHz Right Touch

Date/Time: 4/15/2011 11:34:58 AM, Date/Time: 4/15/2011 11:46:23 AM

DUT: Psion; Serial: STC02A393348E2

Communication System: IEEE 802.11a/h WiFi 5 GHz (OFDM, 12 Mbps); Frequency: 5180 MHz

Medium parameters used: $f = 5180$ MHz; $\sigma = 4.52$ mho/m; $\epsilon_r = 37.3$; $\rho = 1000$ kg/m³

Phantom section: Right Section

DASY5 Configuration:

- Probe: EX3DV4 - SN3739; ConvF(5.52, 5.52, 5.52);
- Sensor-Surface: 2mm (Mechanical Surface Detection)
- Electronics: DAE4 Sn1233; Calibrated: 10/13/2010
- Phantom: SAM; Type: QD 000 P40 CC; Serial: 1592
- Measurement SW: DASY52, V52.2 Build 0;

Right-Hand-Side HSL/Touch Position -5180/Area Scan (13x11x1): Measurement grid: dx=14mm, dy=14mm

Maximum value of SAR (measured) = 0.011 mW/g

Right-Hand-Side HSL/Touch Position -5180/Zoom Scan (8x8x10)/Cube 0: Measurement grid:

dx=4mm, dy=4mm, dz=2.5mm

Reference Value = 0.895 V/m; Power Drift = -0.163 dB

Peak SAR (extrapolated) = 0.047 W/kg

SAR(1 g) = 0.00681 mW/g; SAR(10 g) = 0.00247 mW/g

Maximum value of SAR (measured) = 0.013 mW/g

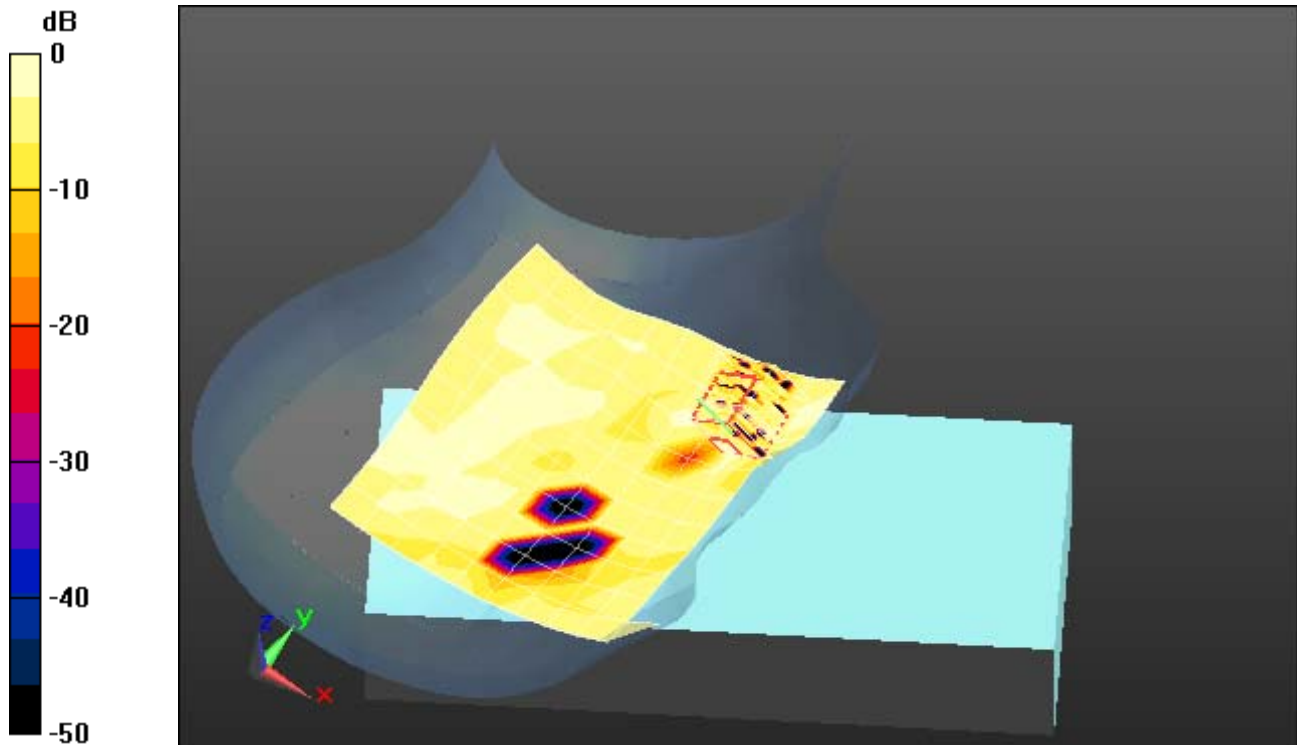

0 dB = 0.013mW/g

Plot 2: 5180MHz Right Tilt

Date/Time: 4/15/2011 1:17:22 PM, Date/Time: 4/15/2011 1:28:48 PM

DUT: Psion; Serial: STC02A393348E2

Communication System: IEEE 802.11a/h WiFi 5 GHz (OFDM, 12 Mbps); Frequency: 5180 MHz

Medium parameters used: $f = 5180$ MHz; $\sigma = 4.52$ mho/m; $\epsilon_r = 37.3$; $\rho = 1000$ kg/m³

Phantom section: Right Section

DASY5 Configuration:

- Probe: EX3DV4 - SN3739; ConvF(5.52, 5.52, 5.52);
- Sensor-Surface: 2mm (Mechanical Surface Detection)
- Electronics: DAE4 Sn1233; Calibrated: 10/13/2010
- Phantom: SAM; Type: QD 000 P40 CC; Serial: 1592
- Measurement SW: DASY52, V52.2 Build 0;

Right-Hand-Side HSL/Tilt Position - 5180/Area Scan (13x11x1): Measurement

grid: dx=14mm, dy=14mm

Maximum value of SAR (measured) = 0.014 mW/g

Right-Hand-Side HSL/Tilt Position - 5180/Zoom Scan (8x8x10)/Cube 0:

Measurement grid: dx=4mm, dy=4mm, dz=2.5mm

Reference Value = 1.16 V/m; Power Drift = -0.169 dB

Peak SAR (extrapolated) = 0.048 W/kg

SAR(1 g) = 0.019 mW/g; SAR(10 g) = 0.00816 mW/g

Maximum value of SAR (measured) = 0.037 mW/g

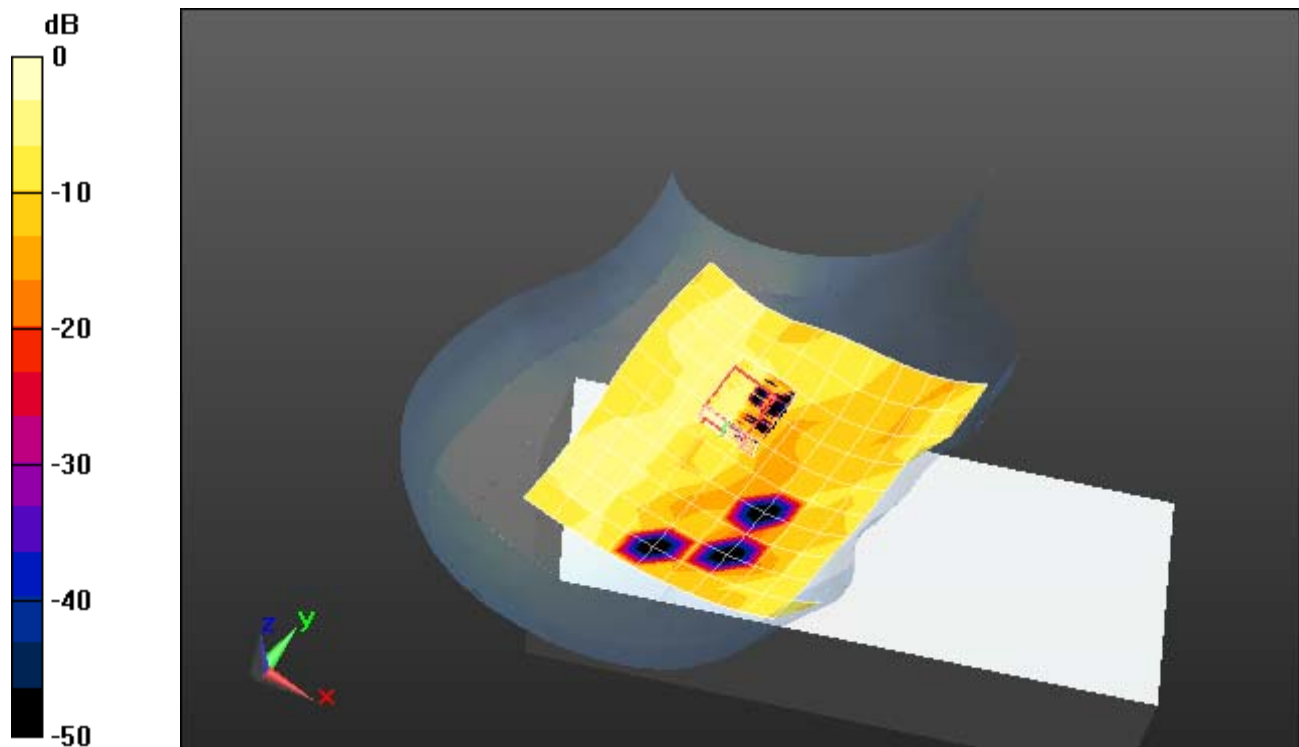

0 dB = 0.037mW/g

Plot 3: 5180MHz Left Touch

Date/Time: 4/16/2011 3:04:22 PM, Date/Time: 4/16/2011 3:16:02 PM

DUT: Psion; Serial: STC02A393348E2

Communication System: IEEE 802.11a/h WiFi 5 GHz (OFDM, 12 Mbps); Frequency: 5180 MHz

Medium parameters used: $f = 5180$ MHz; $\sigma = 4.65$ mho/m; $\epsilon_r = 37.6$; $\rho = 1000$ kg/m³

Phantom section: Left Section

DASY5 Configuration:

- Probe: EX3DV4 - SN3739; ConvF(5.52, 5.52, 5.52);
- Sensor-Surface: 2mm (Mechanical Surface Detection)
- Electronics: DAE4 Sn1233; Calibrated: 10/13/2010
- Phantom: SAM; Type: QD 000 P40 CC; Serial: 1592
- Measurement SW: DASY52, V52.2 Build 0;

Left-Hand-Side HSL/Touch Position - 5180/Area Scan (13x11x1):

Measurement grid: dx=14mm, dy=14mm

Maximum value of SAR (measured) = 0.028 mW/g

Left-Hand-Side HSL/Touch Position - 5180/Zoom Scan (8x8x10)/Cube 0:

Measurement grid: dx=4mm, dy=4mm, dz=2.5mm

Reference Value = 1.08 V/m; Power Drift = -0.201 dB

Peak SAR (extrapolated) = 0.130 W/kg

SAR(1 g) = 0.018 mW/g; SAR(10 g) = 0.00609 mW/g

Maximum value of SAR (measured) = 0.038 mW/g

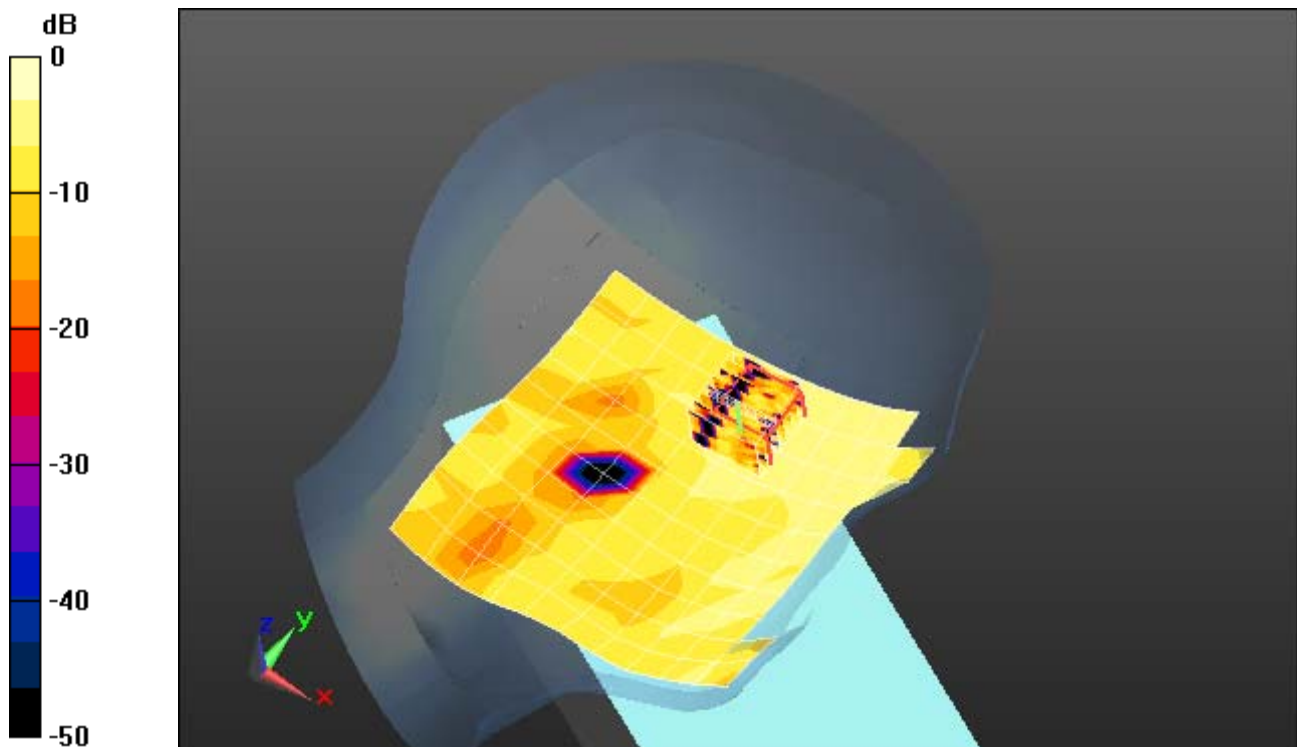

0 dB = 0.038mW/g

Plot 4: 5180MHz Left Tilt

Date/Time: 4/16/2011 4:00:04 PM, Date/Time: 4/16/2011 4:11:46 PM

DUT: Psion; Serial: STC02A393348E2

Communication System: IEEE 802.11a/h WiFi 5 GHz (OFDM, 12 Mbps); Frequency: 5180 MHz

Medium parameters used: $f = 5180$ MHz; $\sigma = 4.65$ mho/m; $\epsilon_r = 37.6$; $\rho = 1000$ kg/m³

Phantom section: Left Section

DASY5 Configuration:

- Probe: EX3DV4 - SN3739; ConvF(5.52, 5.52, 5.52);
- Sensor-Surface: 2mm (Mechanical Surface Detection)
- Electronics: DAE4 Sn1233; Calibrated: 10/13/2010
- Phantom: SAM; Type: QD 000 P40 CC; Serial: 1592
- Measurement SW: DASY52, V52.2 Build 0;

Left-Hand-Side HSL/Tilt Position - 5180/Area Scan (13x11x1): Measurement

grid: dx=14mm, dy=14mm

Maximum value of SAR (measured) = 0.019 mW/g

Left-Hand-Side HSL/Tilt Position - 5180/Zoom Scan (8x8x10)/Cube 0:

Measurement grid: dx=4mm, dy=4mm, dz=2.5mm

Reference Value = 0.752 V/m; Power Drift = -0.155 dB

Peak SAR (extrapolated) = 0.069 W/kg

SAR(1 g) = 0.019 mW/g; SAR(10 g) = 0.011 mW/g

Maximum value of SAR (measured) = 0.029 mW/g

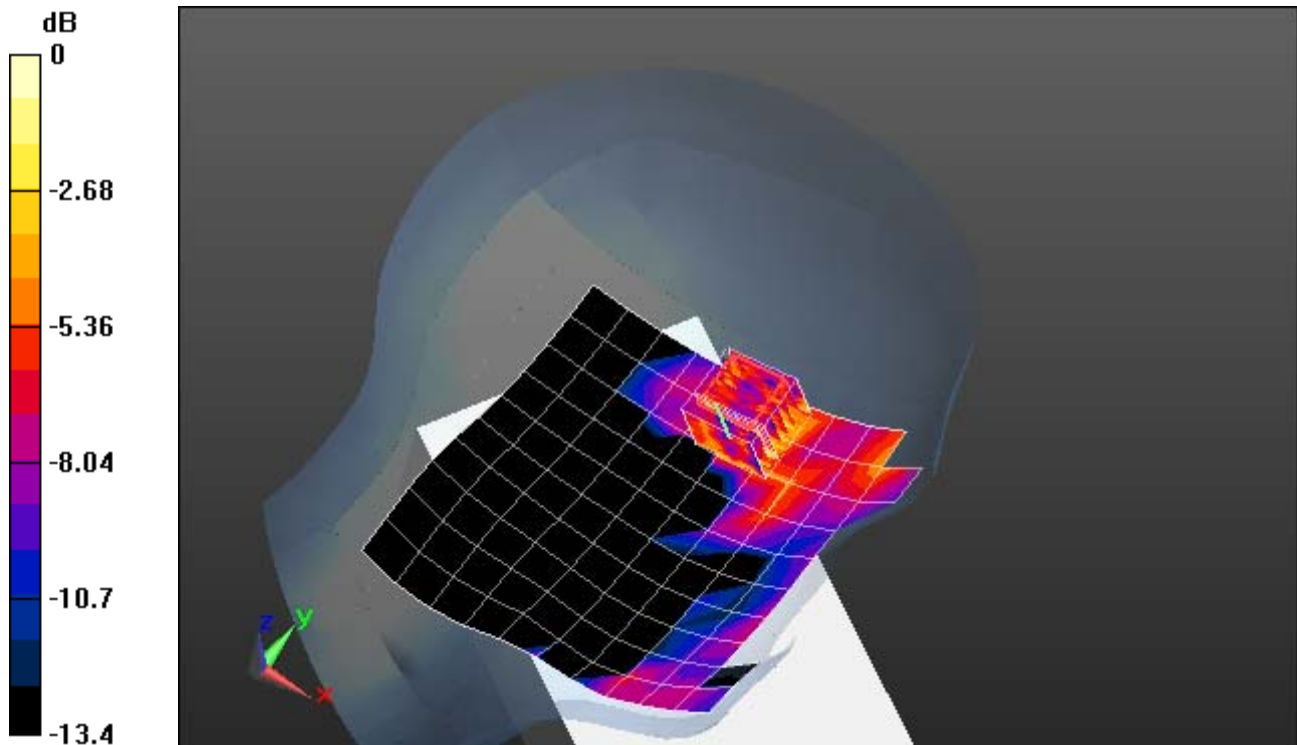

0 dB = 0.029mW/g

Plot 5: 5180MHz Right Edge 5mm

Date/Time: 5/16/2011 2:30:42 PM, Date/Time: 5/16/2011 2:39:45 PM

DUT: Psion; Serial: STC02A393348E2

Communication System: IEEE 802.11a/h WiFi 5 GHz (OFDM, 12 Mbps); Frequency: 5190 MHz
 Medium parameters used (interpolated): $f = 5180$ MHz; $\sigma = 5.26$ mho/m; $\epsilon_r = 49.4$; $\rho = 1000$ kg/m³
 Phantom section: Flat Section

DASY5 Configuration:

- Probe: EX3DV4 - SN3739; ConvF(3.98, 3.98, 3.98);
- Sensor-Surface: 2mm (Mechanical Surface Detection)
- Electronics: DAE4 Sn1233; Calibrated: 10/13/2010
- Phantom: ELI 4.0; Type: QDOVA001BA; Serial: xxxx
- Measurement SW: DASY52, V52.2 Build 0;

Flat-Section MSL Right Edge/Right Edge 5180 5mm 2/Area Scan (8x11x1): Measurement grid:

$dx=14$ mm, $dy=14$ mm

Maximum value of SAR (measured) = 0.015 mW/g

Flat-Section MSL Right Edge/Right Edge 5180 5mm 2/Zoom Scan (4x4x2.5mm), dist=2mm

(8x8x10)/Cube 0: Measurement grid: $dx=4$ mm, $dy=4$ mm, $dz=2.5$ mm

Reference Value = 1.04 V/m; Power Drift = -0.119 dB

Peak SAR (extrapolated) = 0.072 W/kg

SAR(1 g) = 0.00621 mW/g; SAR(10 g) = 0.00243 mW/g

Maximum value of SAR (measured) = 0.024 mW/g

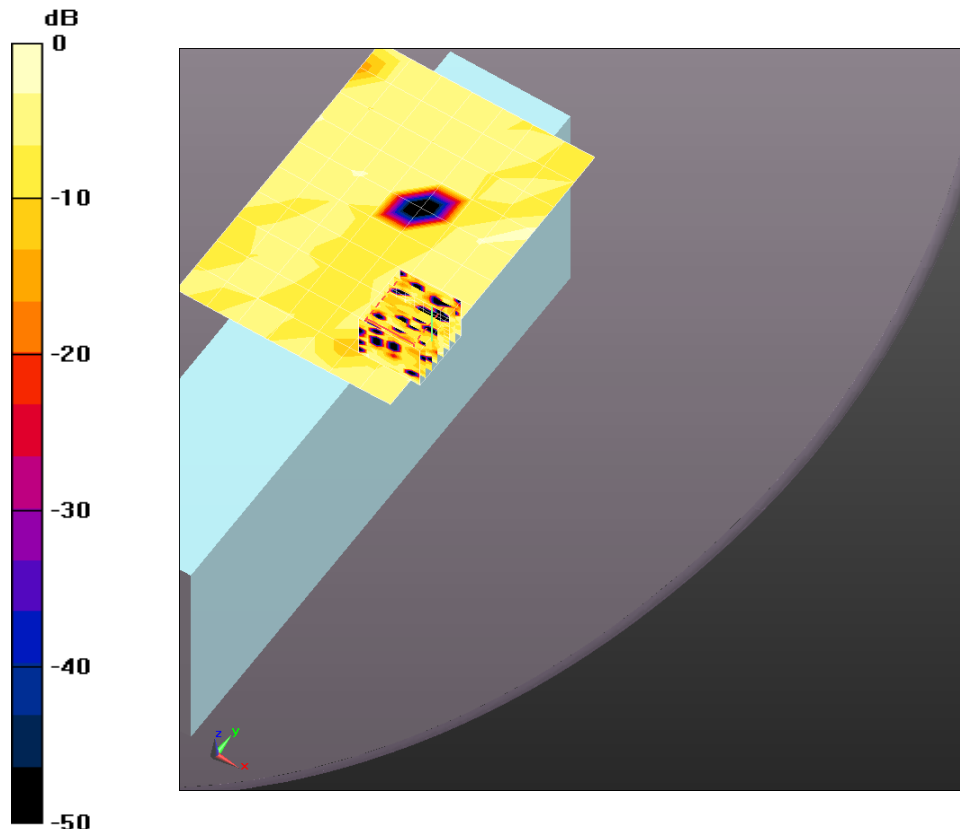

0 dB = 0.024mW/g

Plot 6: 5180MHz Back 5mm

Date/Time: 5/16/2011 10:47:35 AM, Date/Time: 5/16/2011 10:57:45 AM

DUT: Psion; Serial: STC02A393348E2

Communication System: IEEE 802.11a/h WiFi 5 GHz (OFDM, 12 Mbps); Frequency: 5180 MHz

Medium parameters used: $f = 5180 \text{ MHz}$; $\sigma = 5.26 \text{ mho/m}$; $\epsilon_r = 49.4$; $\rho = 1000 \text{ kg/m}^3$

Phantom section: Flat Section

DASY5 Configuration:

- Probe: EX3DV4 - SN3739; ConvF(3.98, 3.98, 3.98);
- Sensor-Surface: 2mm (Mechanical Surface Detection)
- Electronics: DAE4 Sn1233; Calibrated: 10/13/2010
- Phantom: ELI 4.0; Type: QDOVA001BA; Serial: xxxx
- Measurement SW: DASY52, V52.2 Build 0;

Flat-Section MSL/Back 5180 5mm/Area Scan (9x11x1): Measurement grid: $dx=14\text{mm}$, $dy=14\text{mm}$

Maximum value of SAR (measured) = 0.030 mW/g

Flat-Section MSL/Back 5180 5mm/Zoom Scan (4x4x2.5mm), dist=2mm (8x8x10)/Cube 0:

Measurement grid: $dx=4\text{mm}$, $dy=4\text{mm}$, $dz=2.5\text{mm}$

Reference Value = 2.06 V/m; Power Drift = -0.157 dB

Peak SAR (extrapolated) = 0.177 W/kg

SAR(1 g) = 0.016 mW/g; SAR(10 g) = 0.00391 mW/g

Maximum value of SAR (measured) = 0.033 mW/g

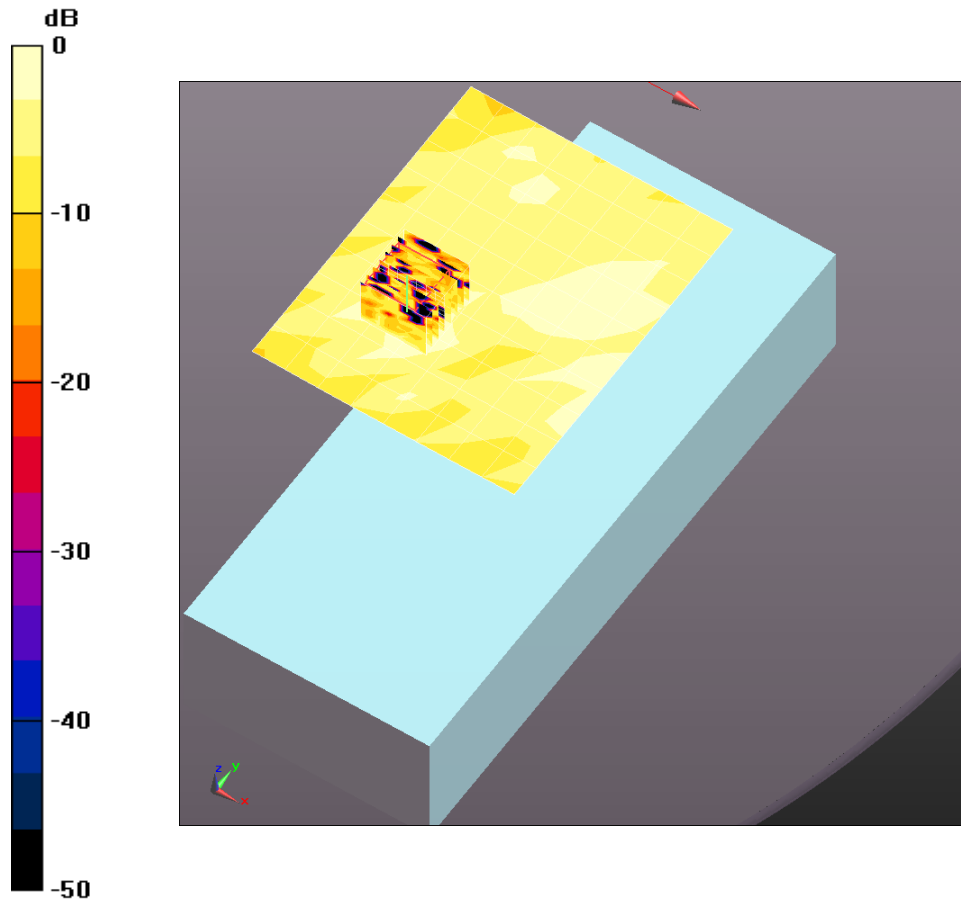

0 dB = 0.033mW/g

Plot 7: 5260MHz Right Touch

Date/Time: 4/15/2011 2:35:34 PM, Date/Time: 4/15/2011 2:46:59 PM

DUT: Psion; Serial: STC02A393348E2

Communication System: IEEE 802.11a/h WiFi 5 GHz (OFDM, 12 Mbps); Frequency: 5260 MHz

Medium parameters used: $f = 5260$ MHz; $\sigma = 4.57$ mho/m; $\epsilon_r = 37.2$; $\rho = 1000$ kg/m³

Phantom section: Right Section

DASY5 Configuration:

- Probe: EX3DV4 - SN3739; ConvF(5.52, 5.52, 5.52);
- Sensor-Surface: 2mm (Mechanical Surface Detection)
- Electronics: DAE4 Sn1233; Calibrated: 10/13/2010
- Phantom: SAM; Type: QD 000 P40 CC; Serial: 1592
- Measurement SW: DASY52, V52.2 Build 0;

Right-Hand-Side HSL/Touch Position -5260/Area Scan (13x11x1):

Measurement grid: dx=14mm, dy=14mm

Maximum value of SAR (measured) = 0.018 mW/g

Right-Hand-Side HSL/Touch Position -5260/Zoom Scan (8x8x10)/Cube 0:

Measurement grid: dx=4mm, dy=4mm, dz=2.5mm

Reference Value = 1.09 V/m; Power Drift = -0.182 dB

Peak SAR (extrapolated) = 0.130 W/kg

SAR(1 g) = 0.013 mW/g; SAR(10 g) = 0.00473 mW/g

Maximum value of SAR (measured) = 0.022 mW/g

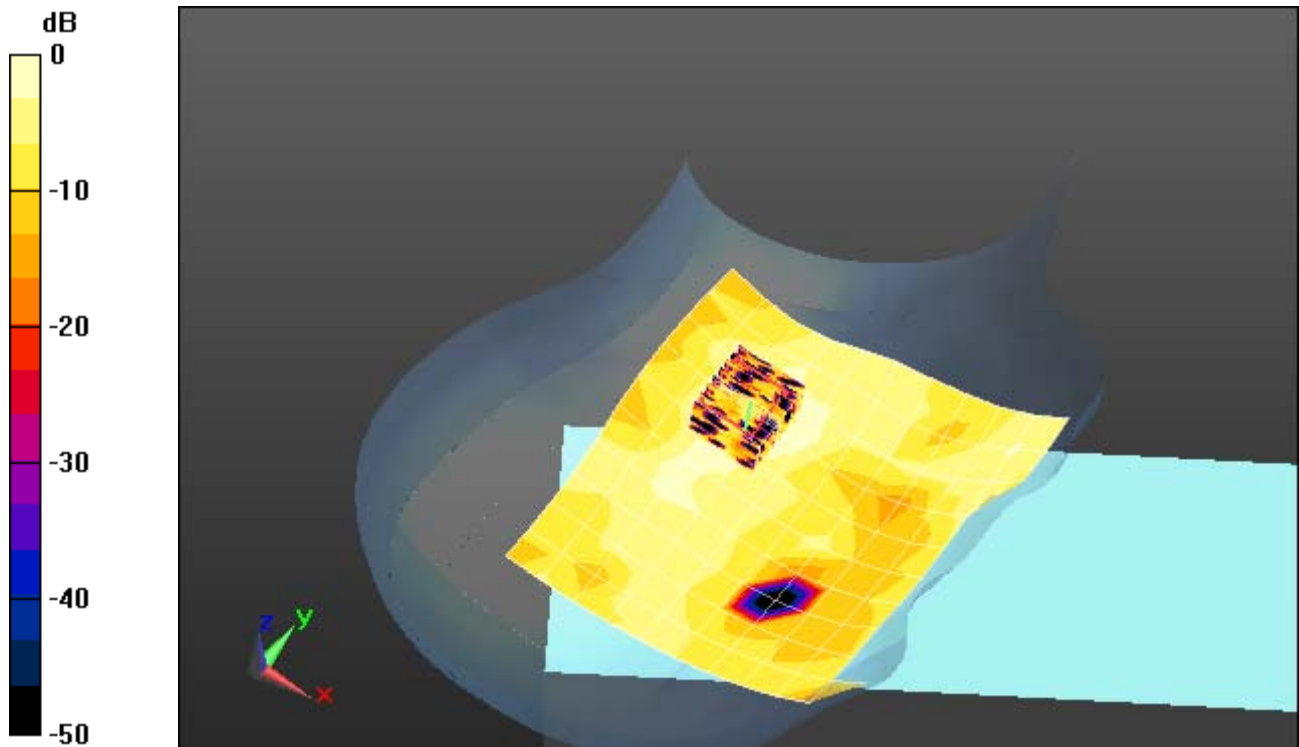

0 dB = 0.022mW/g

Plot 8: 5260MHz Right Tilt

Date/Time: 4/15/2011 1:57:45 PM, Date/Time: 4/15/2011 2:09:09 PM

Communication System: IEEE 802.11a/h WiFi 5 GHz (OFDM, 12 Mbps); Frequency: 5260 MHz

Medium parameters used: $f = 5260$ MHz; $\sigma = 4.57$ mho/m; $\epsilon_r = 37.2$; $\rho = 1000$ kg/m³

Phantom section: Right Section

DASY5 Configuration:

- Probe: EX3DV4 - SN3739; ConvF(5.52, 5.52, 5.52);
- Sensor-Surface: 2mm (Mechanical Surface Detection)
- Electronics: DAE4 Sn1233; Calibrated: 10/13/2010
- Phantom: SAM; Type: QD 000 P40 CC; Serial: 1592
- Measurement SW: DASY52, V52.2 Build 0;

Right-Hand-Side HSL/Tilt Position - 5260/Area Scan (13x11x1): Measurement

grid: dx=14mm, dy=14mm

Maximum value of SAR (measured) = 0.0084 mW/g

Right-Hand-Side HSL/Tilt Position - 5260/Zoom Scan (8x8x10)/Cube 0:

Measurement grid: dx=4mm, dy=4mm, dz=2.5mm

Reference Value = 0.710 V/m; Power Drift = -0.203 dB

Peak SAR (extrapolated) = 0.018 W/kg

SAR(1 g) = 0.000174 mW/g; SAR(10 g) = 1.15e-005 mW/g

Maximum value of SAR (measured) = 0.012 mW/g

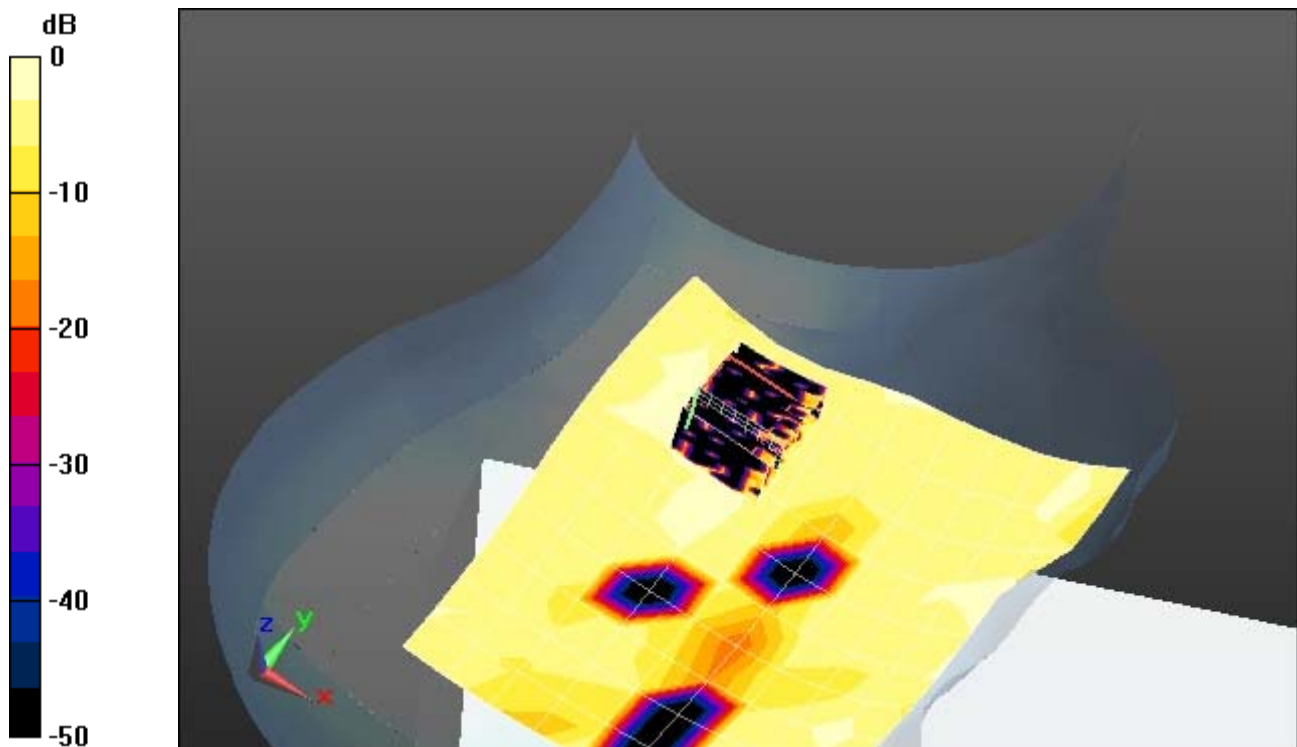

0 dB = 0.012mW/g

Plot 9: 5260MHz Left Touch

Date/Time: 4/16/2011 5:12:16 PM, Date/Time: 4/16/2011 5:23:57 PM

DUT: Psion; Serial: STC02A393348E2

Communication System: IEEE 802.11a/h WiFi 5 GHz (OFDM, 12 Mbps); Frequency: 5260 MHz

Medium parameters used: $f = 5260$ MHz; $\sigma = 4.75$ mho/m; $\epsilon_r = 37.4$; $\rho = 1000$ kg/m³

Phantom section: Left Section

DASY5 Configuration:

- Probe: EX3DV4 - SN3739; ConvF(5.52, 5.52, 5.52);
- Sensor-Surface: 2mm (Mechanical Surface Detection)
- Electronics: DAE4 Sn1233; Calibrated: 10/13/2010
- Phantom: SAM; Type: QD 000 P40 CC; Serial: 1592
- Measurement SW: DASY52, V52.2 Build 0;

Left-Hand-Side HSL/Touch Position - 5260/Area Scan (13x11x1):

Measurement grid: dx=14mm, dy=14mm

Maximum value of SAR (measured) = 0.038 mW/g

Left-Hand-Side HSL/Touch Position - 5260/Zoom Scan (8x8x10)/Cube 0:

Measurement grid: dx=4mm, dy=4mm, dz=2.5mm

Reference Value = 0 V/m; Power Drift = 0 dB

Peak SAR (extrapolated) = 0.156 W/kg

SAR(1 g) = 0.019 mW/g; SAR(10 g) = 0.00731 mW/g

Maximum value of SAR (measured) = 0.046 mW/g

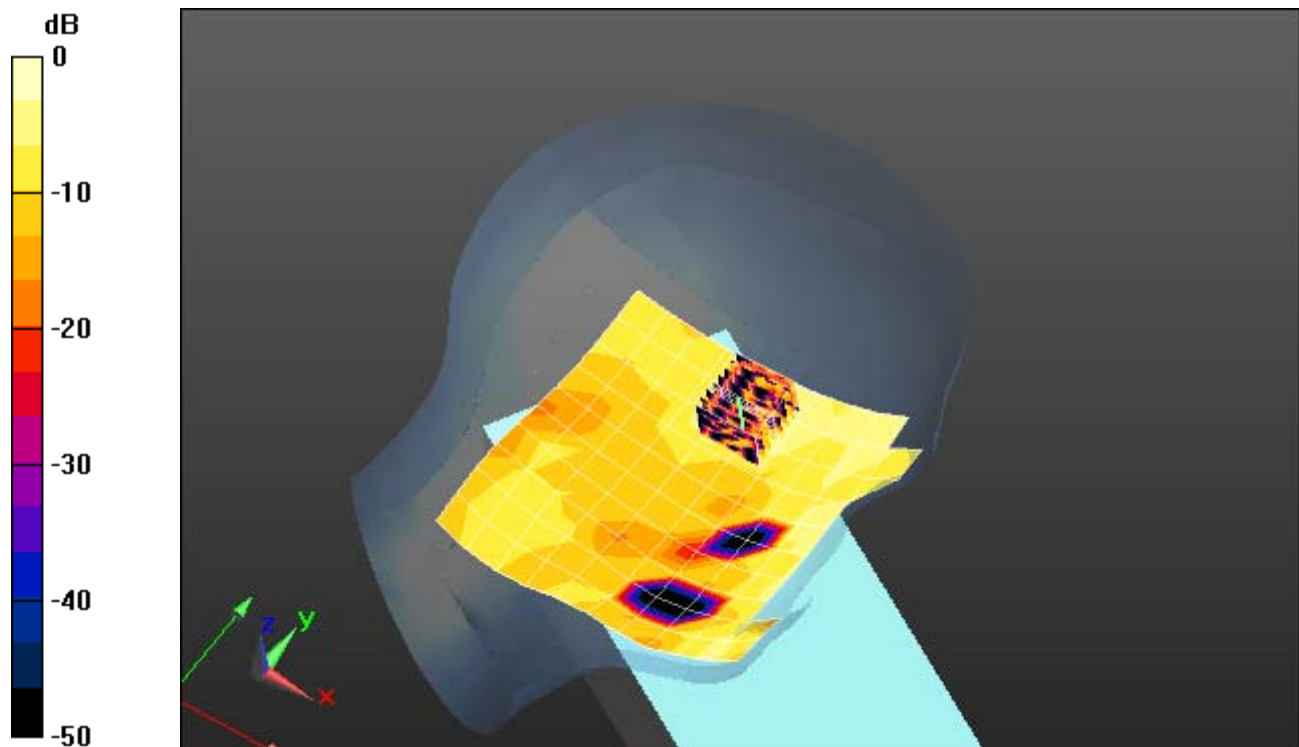

0 dB = 0.046mW/g

Plot 10: 5260MHz Left Tilt

Date/Time: 4/16/2011 4:35:40 PM, Date/Time: 4/16/2011 4:47:23 PM

DUT: Psion; Serial: STC02A393348E2

Communication System: IEEE 802.11a/h WiFi 5 GHz (OFDM, 12 Mbps); Frequency: 5260 MHz

Medium parameters used: $f = 5260$ MHz; $\sigma = 4.75$ mho/m; $\epsilon_r = 37.4$; $\rho = 1000$ kg/m³

Phantom section: Left Section

DASY5 Configuration:

- Probe: EX3DV4 - SN3739; ConvF(5.52, 5.52, 5.52);
- Sensor-Surface: 2mm (Mechanical Surface Detection)
- Electronics: DAE4 Sn1233; Calibrated: 10/13/2010
- Phantom: SAM; Type: QD 000 P40 CC; Serial: 1592
- Measurement SW: DASY52, V52.2 Build 0;

Left-Hand-Side HSL/Tilt Position - 5260/Area Scan (13x11x1): Measurement

grid: dx=14mm, dy=14mm

Maximum value of SAR (measured) = 0.033 mW/g

Left-Hand-Side HSL/Tilt Position - 5260/Zoom Scan (8x8x10)/Cube 0:

Measurement grid: dx=4mm, dy=4mm, dz=2.5mm

Reference Value = 0.432 V/m; Power Drift = -0.209 dB

Peak SAR (extrapolated) = 0.127 W/kg

SAR(1 g) = 0.015 mW/g; SAR(10 g) = 0.00619 mW/g

Maximum value of SAR (measured) = 0.035 mW/g

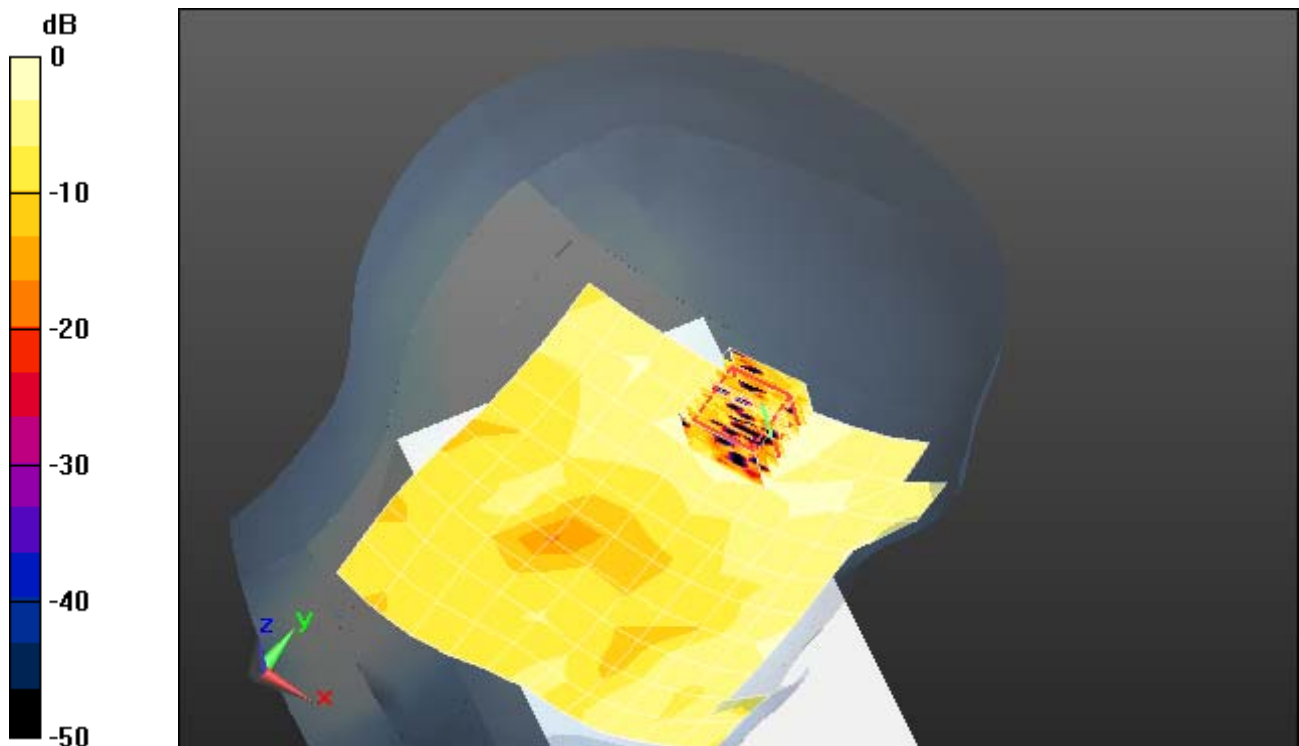

0 dB = 0.035mW/g

Plot 11: 5260MHz Right Edge 5mm

Date/Time: 5/16/2011 3:37:54 PM, Date/Time: 5/16/2011 3:47:19 PM

DUT: Psion; Serial: STC02A393348E2

Communication System: IEEE 802.11a/h WiFi 5 GHz (OFDM, 12 Mbps); Frequency: 5260 MHz

Medium parameters used: $f = 5260 \text{ MHz}$; $\sigma = 5.44 \text{ mho/m}$; $\epsilon_r = 49.3$; $\rho = 1000 \text{ kg/m}^3$

Phantom section: Flat Section

DASY5 Configuration:

- Probe: EX3DV4 - SN3739; ConvF(3.98, 3.98, 3.98);
- Sensor-Surface: 2mm (Mechanical Surface Detection)
- Electronics: DAE4 Sn1233; Calibrated: 10/13/2010
- Phantom: ELI 4.0; Type: QDOVA001BA; Serial: xxxx
- Measurement SW: DASY52, V52.2 Build 0;

Flat-Section MSL Right Edge/Right Edge 5260 5mm 2/Area Scan (8x11x1): Measurement grid:

$dx=14\text{mm}$, $dy=14\text{mm}$

Maximum value of SAR (measured) = 0.013 mW/g

Flat-Section MSL Right Edge/Right Edge 5260 5mm 2/Zoom Scan (4x4x2.5mm), dist=2mm

(8x8x10)/Cube 0: Measurement grid: $dx=4\text{mm}$, $dy=4\text{mm}$, $dz=2.5\text{mm}$

Reference Value = 0.504 V/m; Power Drift = -0.142 dB

Peak SAR (extrapolated) = 0.060 W/kg

SAR(1 g) = 0.00478 mW/g; SAR(10 g) = 0.00184 mW/g

Maximum value of SAR (measured) = 0.016 mW/g

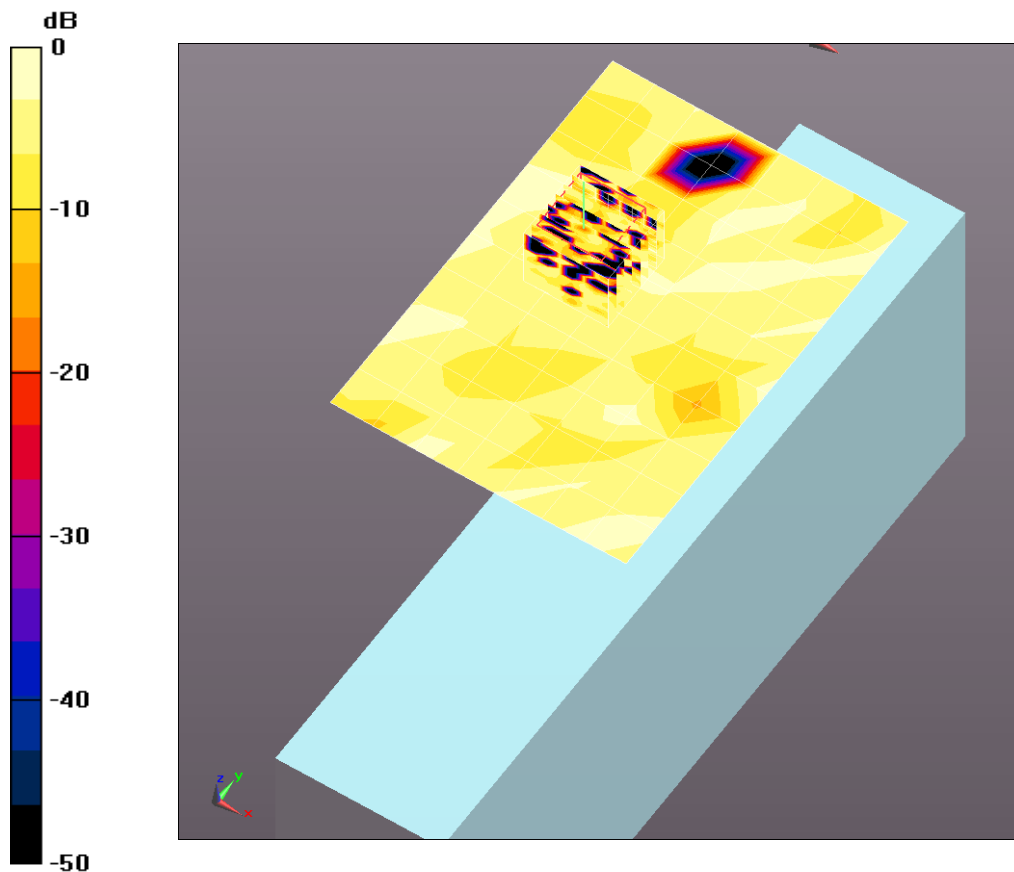

0 dB = 0.016mW/g

Plot 12: 5260MHz Back 5mm

Date/Time: 5/16/2011 4:07:37 PM, Date/Time: 5/16/2011 4:17:58 PM

DUT: Psion; Serial: STC02A393348E2

Communication System: IEEE 802.11a/h WiFi 5 GHz (OFDM, 12 Mbps); Frequency: 5260 MHz

Medium parameters used: $f = 5260 \text{ MHz}$; $\sigma = 5.44 \text{ mho/m}$; $\epsilon_r = 49.3$; $\rho = 1000 \text{ kg/m}^3$

Phantom section: Flat Section

DASY5 Configuration:

- Probe: EX3DV4 - SN3739; ConvF(3.98, 3.98, 3.98);
- Sensor-Surface: 2mm (Mechanical Surface Detection)
- Electronics: DAE4 Sn1233; Calibrated: 10/13/2010
- Phantom: ELI 4.0; Type: QDOVA001BA; Serial: xxxx
- Measurement SW: DASY52, V52.2 Build 0;

Flat-Section MSL/Back 5260 5mm/Area Scan (9x11x1): Measurement grid: $dx=14\text{mm}$, $dy=14\text{mm}$

Maximum value of SAR (measured) = 0.046 mW/g

Flat-Section MSL/Back 5260 5mm/Zoom Scan (4x4x2.5mm), dist=2mm (8x8x10)/Cube 0:

Measurement grid: $dx=4\text{mm}$, $dy=4\text{mm}$, $dz=2.5\text{mm}$

Reference Value = 1.39 V/m; Power Drift = -0.204 dB

Peak SAR (extrapolated) = 0.295 W/kg

SAR(1 g) = 0.029 mW/g; SAR(10 g) = 0.012 mW/g

Maximum value of SAR (measured) = 0.057 mW/g

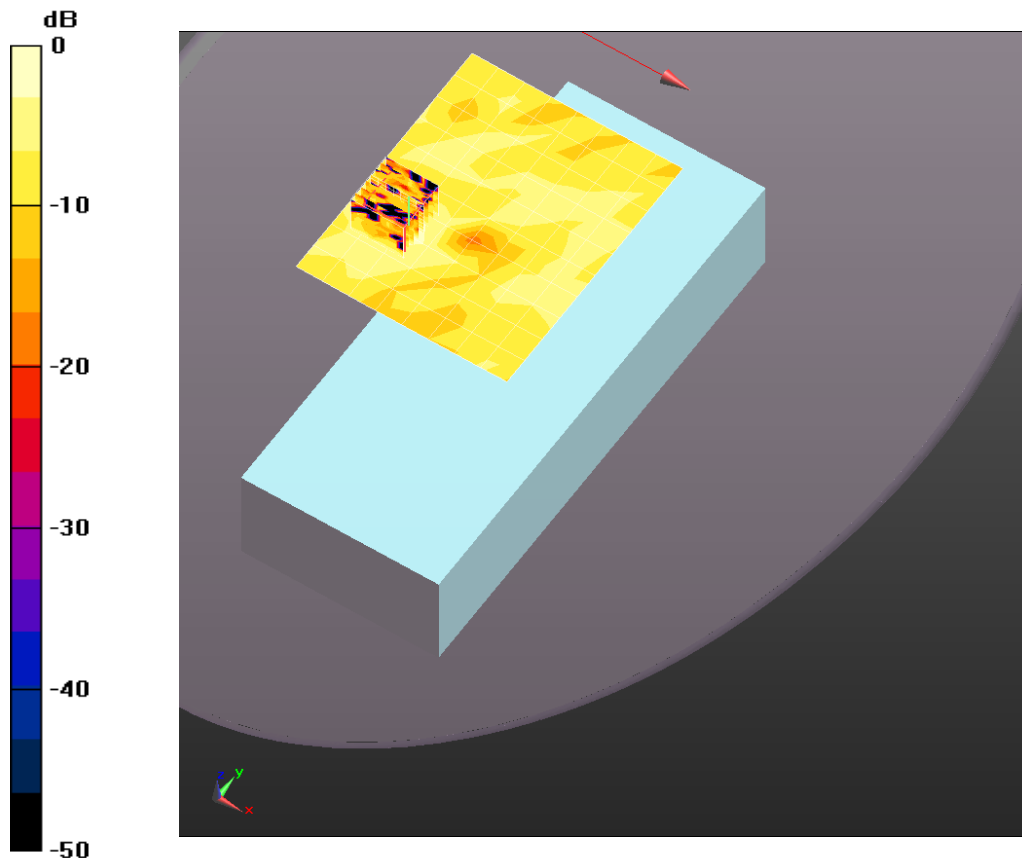

0 dB = 0.057mW/g

Plot 13: 5520MHz Right Touch

Date/Time: 4/15/2011 3:20:14 PM, Date/Time: 4/15/2011 3:31:37 PM

DUT: Psion; Serial: STC02A393348E2

Communication System: IEEE 802.11a/h WiFi 5 GHz (OFDM, 12 Mbps); Frequency: 5520 MHz

Medium parameters used: $f = 5520$ MHz; $\sigma = 4.77$ mho/m; $\epsilon_r = 37$; $\rho = 1000$ kg/m³

Phantom section: Right Section

DASY5 Configuration:

- Probe: EX3DV4 - SN3739; ConvF(4.97, 4.97, 4.97);
- Sensor-Surface: 2mm (Mechanical Surface Detection)
- Electronics: DAE4 Sn1233; Calibrated: 10/13/2010
- Phantom: SAM; Type: QD 000 P40 CC; Serial: 1592
- Measurement SW: DASY52, V52.2 Build 0;

Right-Hand-Side HSL/Touch Position -5520/Area Scan (13x11x1):

Measurement grid: dx=14mm, dy=14mm

Maximum value of SAR (measured) = 0.023 mW/g

Right-Hand-Side HSL/Touch Position -5520/Zoom Scan (8x8x10)/Cube 0:

Measurement grid: dx=4mm, dy=4mm, dz=2.5mm

Reference Value = 0 V/m; Power Drift = 0 dB

Peak SAR (extrapolated) = 0.157 W/kg

SAR(1 g) = 0.016 mW/g; SAR(10 g) = 0.00438 mW/g

Maximum value of SAR (measured) = 0.028 mW/g

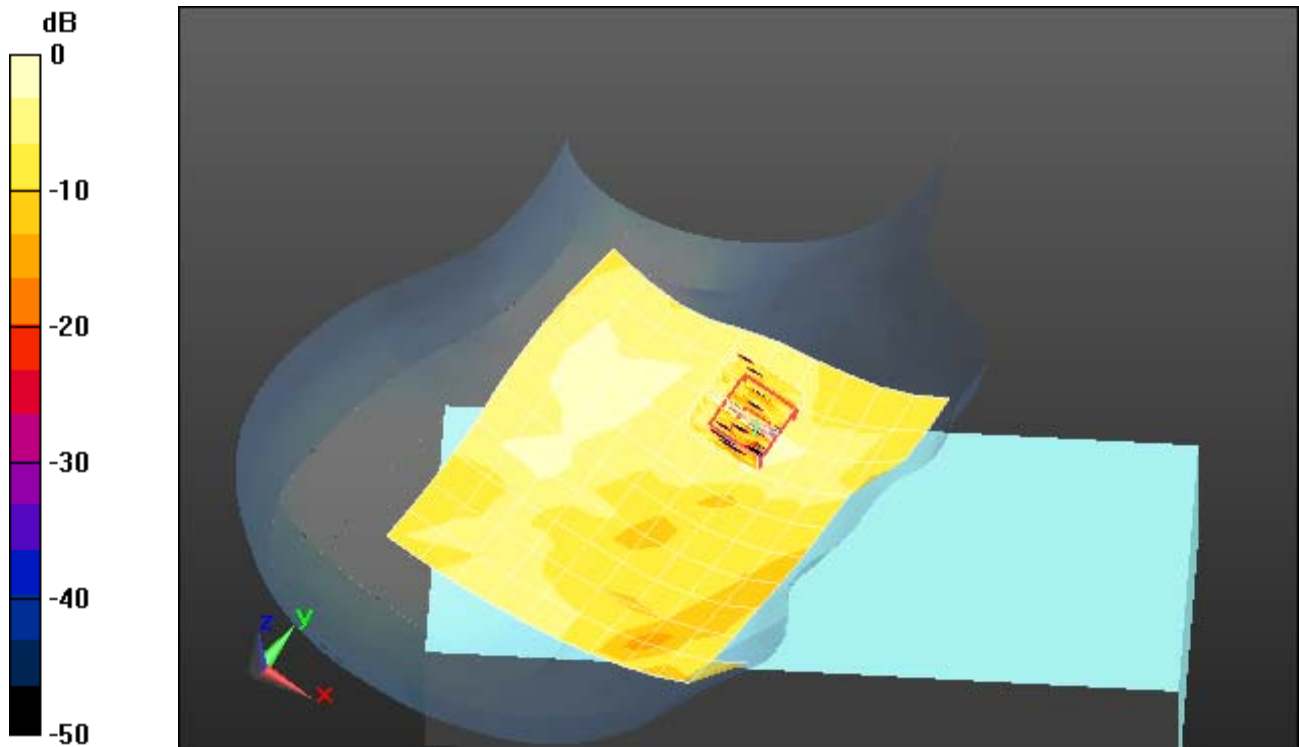

0 dB = 0.028mW/g

Plot 14: 5520MHz Right Tilt

Date/Time: 4/15/2011 4:05:22 PM, Date/Time: 4/15/2011 4:16:48 PM

DUT: Psion; Serial: STC02A393348E2

Communication System: IEEE 802.11a/h WiFi 5 GHz (OFDM, 12 Mbps); Frequency: 5745 MHz

Medium parameters used: $f = 5745 \text{ MHz}$; $\sigma = 5.07 \text{ mho/m}$; $\epsilon_r = 36.6$; $\rho = 1000 \text{ kg/m}^3$

Phantom section: Right Section

DASY5 Configuration:

- Probe: EX3DV4 - SN3739; ConvF(4.67, 4.67, 4.67);
- Sensor-Surface: 2mm (Mechanical Surface Detection)
- Electronics: DAE4 Sn1233; Calibrated: 10/13/2010
- Phantom: SAM; Type: QD 000 P40 CC; Serial: 1592
- Measurement SW: DASY52, V52.2 Build 0;

Right-Hand-Side HSL/Tilt Position - 5520/Area Scan (13x11x1): Measurement

grid: dx=14mm, dy=14mm

Maximum value of SAR (measured) = 0.038 mW/g

Right-Hand-Side HSL/Tilt Position - 5520/Zoom Scan (8x8x10)/Cube 0:

Measurement grid: dx=4mm, dy=4mm, dz=2.5mm

Reference Value = 0.666 V/m; Power Drift = -0.203 dB

Peak SAR (extrapolated) = 0.196 W/kg

SAR(1 g) = 0.019 mW/g; SAR(10 g) = 0.00585 mW/g

Maximum value of SAR (measured) = 0.032 mW/g

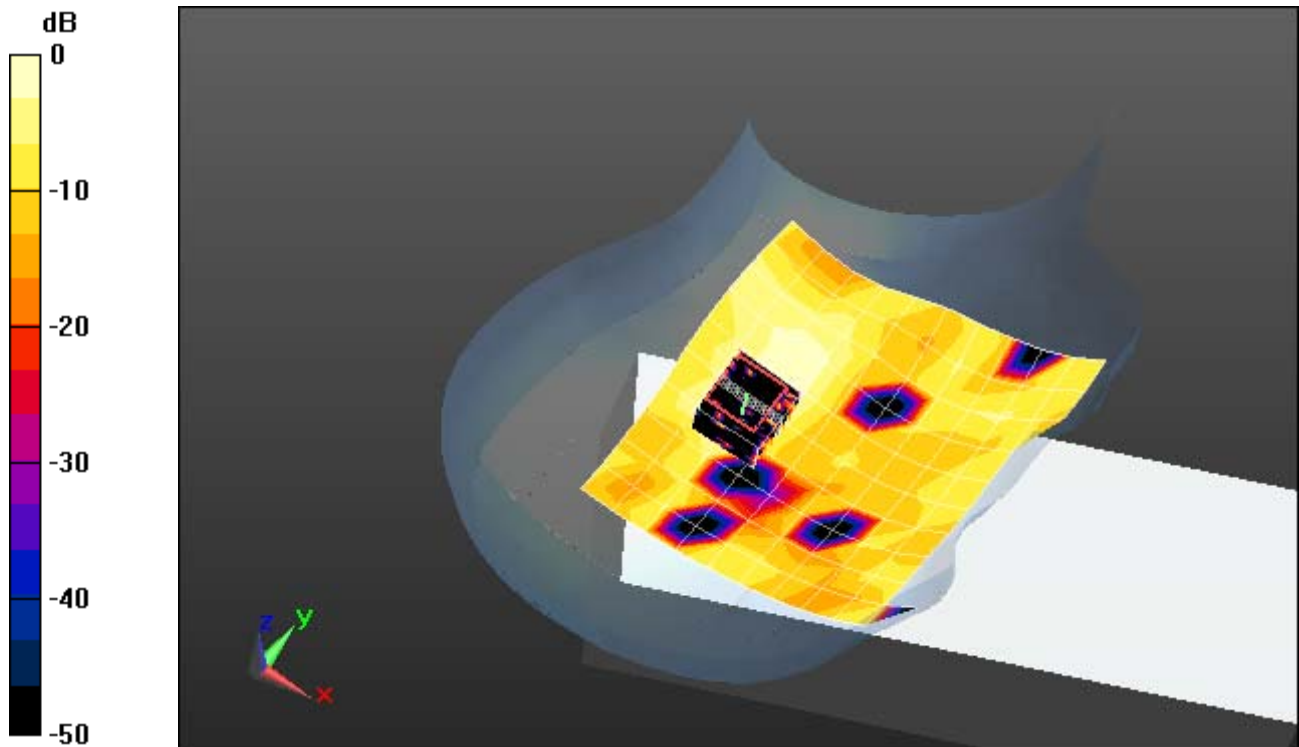

0 dB = 0.032mW/g

Plot 15: 5520MHz Left Touch

Date/Time: 4/20/2011 9:59:52 AM, Date/Time: 4/20/2011 10:11:35 AM

DUT: Psion; Serial: STC02A393348E2

Communication System: IEEE 802.11a/h WiFi 5 GHz (OFDM, 12 Mbps); Frequency: 5520 MHz

Medium parameters used: $f = 5520 \text{ MHz}$; $\sigma = 4.95 \text{ mho/m}$; $\epsilon_r = 37.1$; $\rho = 1000 \text{ kg/m}^3$

Phantom section: Left Section

DASY5 Configuration:

- Probe: EX3DV4 - SN3739; ConvF(4.97, 4.97, 4.97);
- Sensor-Surface: 2mm (Mechanical Surface Detection)
- Electronics: DAE4 Sn1233; Calibrated: 10/13/2010
- Phantom: SAM; Type: QD 000 P40 CC; Serial: 1592
- Measurement SW: DASY52, V52.2 Build 0;

Left-Hand-Side HSL/Touch Position - 5520/Area Scan (13x11x1):

Measurement grid: $dx=14\text{mm}$, $dy=14\text{mm}$

Maximum value of SAR (measured) = 0.065 mW/g

Left-Hand-Side HSL/Touch Position - 5520/Zoom Scan (8x8x10)/Cube 0:

Measurement grid: $dx=4\text{mm}$, $dy=4\text{mm}$, $dz=2.5\text{mm}$

Reference Value = 1.22 V/m; Power Drift = -0.127 dB

Peak SAR (extrapolated) = 0.221 W/kg

SAR(1 g) = 0.026 mW/g; SAR(10 g) = 0.00428 mW/g

Maximum value of SAR (measured) = 0.147 mW/g

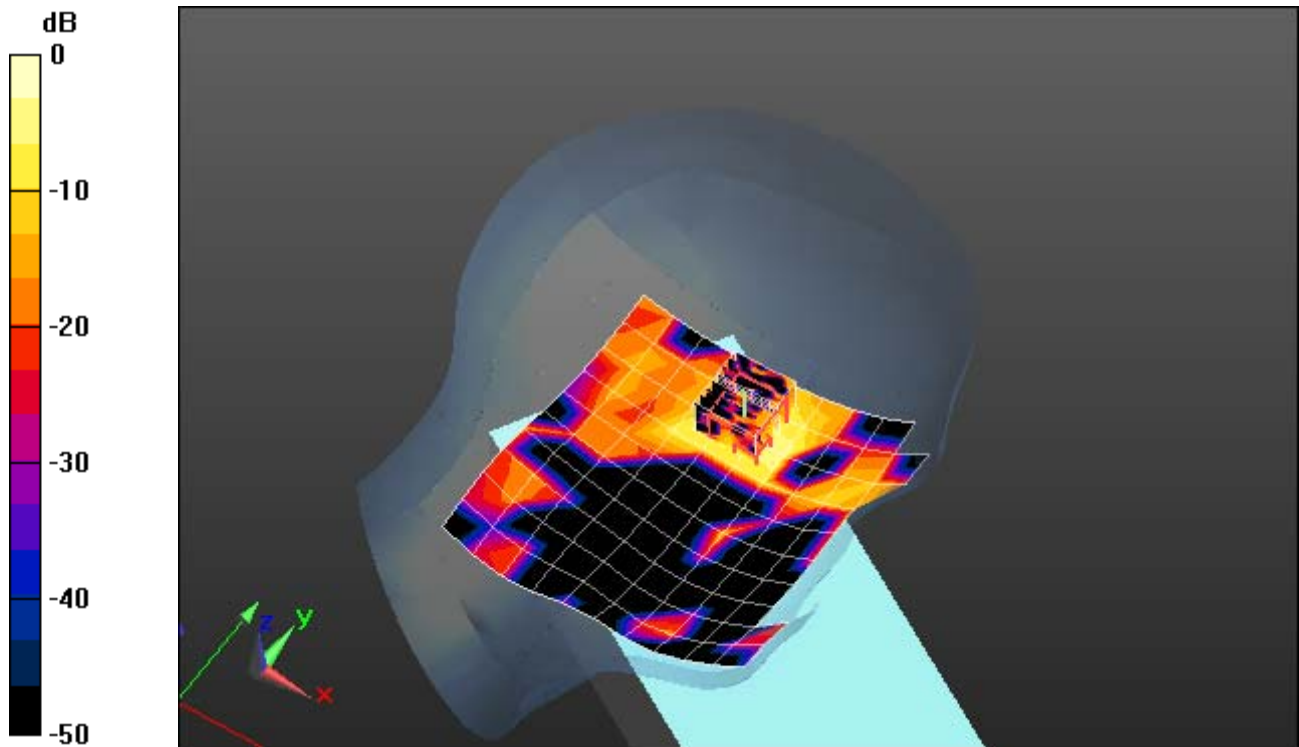

0 dB = 0.147mW/g

Plot 16: 5520MHz Left Tilt

Date/Time: 4/20/2011 10:35:52 AM, Date/Time: 4/20/2011 10:47:35 AM

DUT: Psion; Serial: STC02A393348E2

Communication System: IEEE 802.11a/h WiFi 5 GHz (OFDM, 12 Mbps); Frequency: 5520 MHz

Medium parameters used: $f = 5520$ MHz; $\sigma = 4.95$ mho/m; $\epsilon_r = 37.1$; $\rho = 1000$ kg/m³

Phantom section: Left Section

DASY5 Configuration:

- Probe: EX3DV4 - SN3739; ConvF(4.97, 4.97, 4.97);
- Sensor-Surface: 2mm (Mechanical Surface Detection)
- Electronics: DAE4 Sn1233; Calibrated: 10/13/2010
- Phantom: SAM; Type: QD 000 P40 CC; Serial: 1592
- Measurement SW: DASY52, V52.2 Build 0;

Left-Hand-Side HSL/Tilt Position - 5520/Area Scan (13x11x1): Measurement

grid: dx=14mm, dy=14mm

Maximum value of SAR (measured) = 0.044 mW/g

Left-Hand-Side HSL/Tilt Position - 5520/Zoom Scan (8x8x10)/Cube 0:

Measurement grid: dx=4mm, dy=4mm, dz=2.5mm

Reference Value = 0 V/m; Power Drift = 0 dB

Peak SAR (extrapolated) = 0.190 W/kg

SAR(1 g) = 0.027 mW/g; SAR(10 g) = 0.00951 mW/g

Maximum value of SAR (measured) = 0.156 mW/g

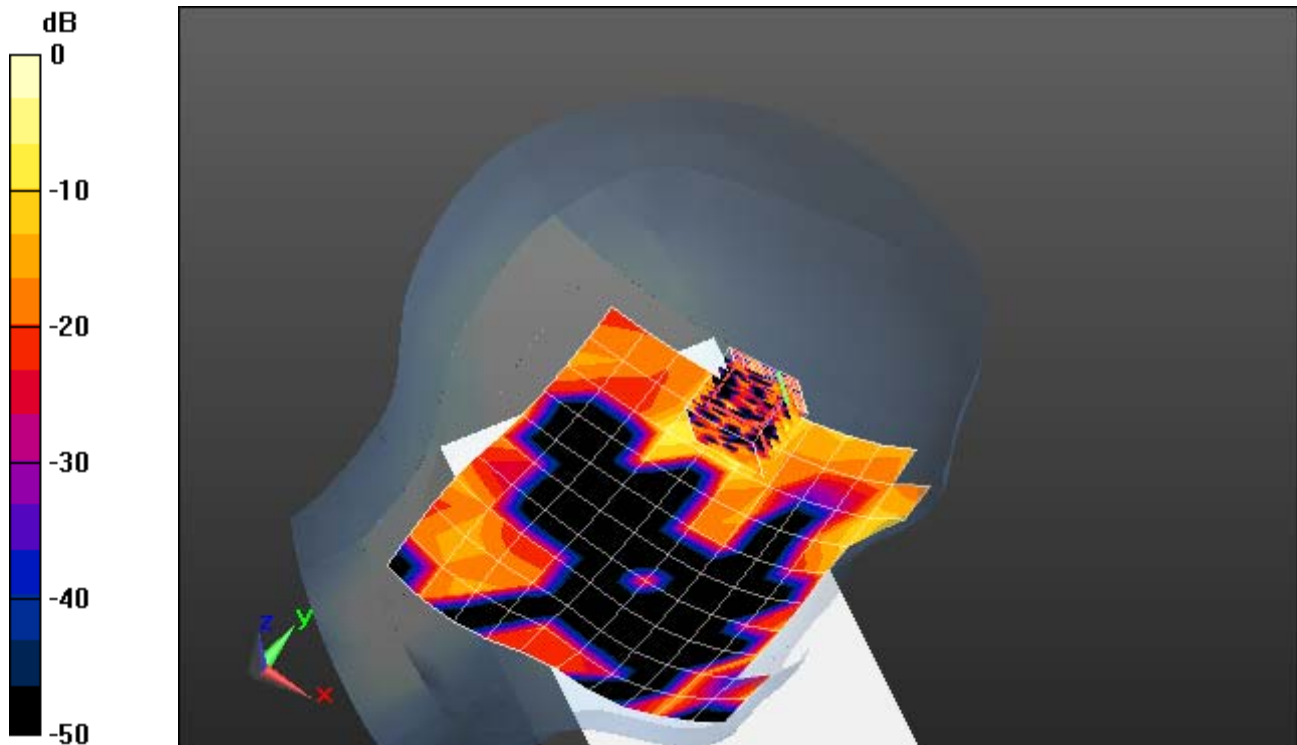

0 dB = 0.156mW/g

Plot 17: 5520MHz Right Edge 5mm

Date/Time: 5/17/2011 10:57:19 AM, Date/Time: 5/17/2011 11:06:26 AM

DUT: Psion; Serial: STC02A393348E2

Communication System: IEEE 802.11a/h WiFi 5 GHz (OFDM, 12 Mbps); Frequency: 5520 MHz

Medium parameters used: $f = 5520$ MHz; $\sigma = 5.77$ mho/m; $\epsilon_r = 49$; $\rho = 1000$ kg/m³

Phantom section: Flat Section

DASY5 Configuration:

- Probe: EX3DV4 - SN3739; ConvF(3.59, 3.59, 3.59);
- Sensor-Surface: 2mm (Mechanical Surface Detection)
- Electronics: DAE4 Sn1233; Calibrated: 10/13/2010
- Phantom: ELI 4.0; Type: QDOVA001BA; Serial: xxxx
- Measurement SW: DASY52, V52.2 Build 0;

Flat-Section MSL Right Edge/Right Edge 5520 5mm 3/Area Scan

(8x11x1): Measurement grid: dx=14mm, dy=14mm

Maximum value of SAR (measured) = 0.023 mW/g

Flat-Section MSL Right Edge/Right Edge 5520 5mm 3/Zoom Scan

(4x4x2.5mm), dist=2mm (8x8x10)/Cube 0: Measurement grid: dx=4mm, dy=4mm, dz=2.5mm

Reference Value = 1.12 V/m; Power Drift = -0.143 dB

Peak SAR (extrapolated) = 0.109 W/kg

SAR(1 g) = 0.0081 mW/g; SAR(10 g) = 0.0027 mW/g.

Maximum value of SAR (measured) = 0.029 mW/g

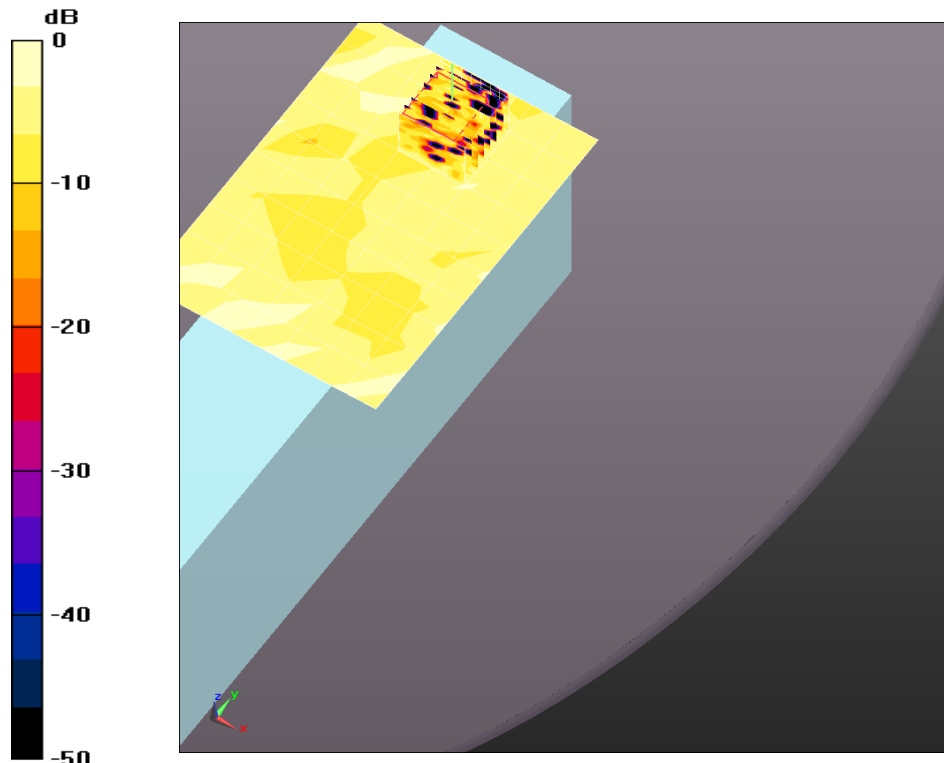

0 dB = 0.029mW/g

Plot 18: 5520MHz Back 5mm

Date/Time: 5/17/2011 1:52:42 PM, Date/Time: 5/17/2011 2:03:01 PM

DUT: Psion; Serial: STC02A393348E2

Communication System: IEEE 802.11a/h WiFi 5 GHz (OFDM, 12 Mbps); Frequency: 5520 MHz

Medium parameters used: $f = 5520 \text{ MHz}$; $\sigma = 5.77 \text{ mho/m}$; $\epsilon_r = 49$; $\rho = 1000 \text{ kg/m}^3$

Phantom section: Flat Section

DASY5 Configuration:

- Probe: EX3DV4 - SN3739; ConvF(3.59, 3.59, 3.59);
- Sensor-Surface: 2mm (Mechanical Surface Detection)
- Electronics: DAE4 Sn1233; Calibrated: 10/13/2010
- Phantom: ELI 4.0; Type: QDOVA001BA; Serial: xxxx
- Measurement SW: DASY52, V52.2 Build 0;

Flat-Section MSL/Back 5520 5mm/Area Scan (9x11x1): Measurement grid:

$dx=14\text{mm}$, $dy=14\text{mm}$

Maximum value of SAR (measured) = 0.097 mW/g

Flat-Section MSL/Back 5520 5mm/Zoom Scan (4x4x2.5mm), dist=2mm

(8x8x10)/Cube 0: Measurement grid: $dx=4\text{mm}$, $dy=4\text{mm}$, $dz=2.5\text{mm}$

Reference Value = 1.32 V/m; Power Drift = -0.172 dB

Peak SAR (extrapolated) = 0.290 W/kg

SAR(1 g) = 0.058 mW/g; SAR(10 g) = 0.023 mW/g

Maximum value of SAR (measured) = 0.124 mW/g

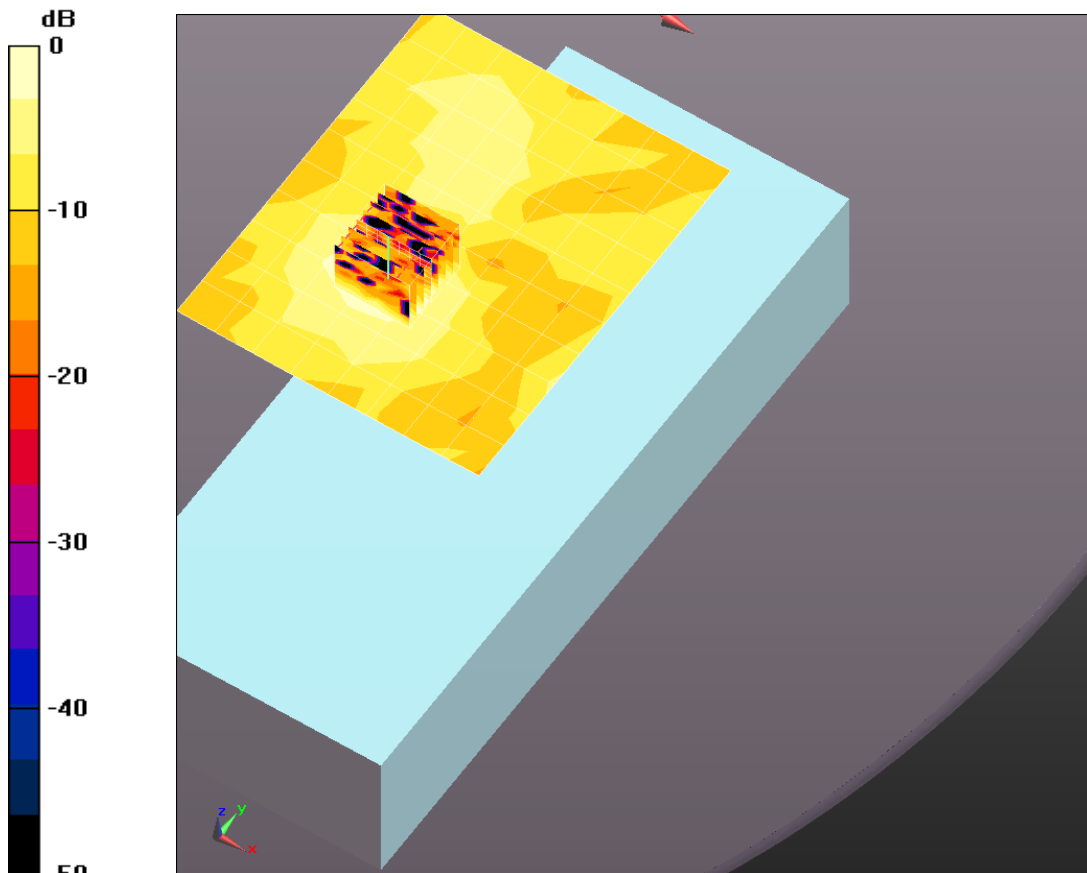

0 dB = 0.124mW/g

Plot 19: 5745MHz Right Touch

Date/Time: 4/15/2011 6:03:35 PM, Date/Time: 4/15/2011 6:14:59 PM

DUT: Psion; Serial: STC02A393348E2

Communication System: IEEE 802.11a/h WiFi 5 GHz (OFDM, 12 Mbps); Frequency: 5745 MHz

Medium parameters used: $f = 5745 \text{ MHz}$; $\sigma = 5.07 \text{ mho/m}$; $\epsilon_r = 36.6$; $\rho = 1000 \text{ kg/m}^3$

Phantom section: Right Section

DASY5 Configuration:

- Probe: EX3DV4 - SN3739; ConvF(4.67, 4.67, 4.67);
- Sensor-Surface: 2mm (Mechanical Surface Detection)
- Electronics: DAE4 Sn1233; Calibrated: 10/13/2010
- Phantom: SAM; Type: QD 000 P40 CC; Serial: 1592
- Measurement SW: DASY52, V52.2 Build 0;

Right-Hand-Side HSL/Touch Position -5745/Area Scan (13x11x1):

Measurement grid: $dx=14\text{mm}$, $dy=14\text{mm}$

Maximum value of SAR (measured) = 0.017 mW/g

Right-Hand-Side HSL/Touch Position -5745/Zoom Scan (8x8x10)/Cube 0:

Measurement grid: $dx=4\text{mm}$, $dy=4\text{mm}$, $dz=2.5\text{mm}$

Reference Value = 0 V/m; Power Drift = 0 dB

Peak SAR (extrapolated) = 0.066 W/kg

SAR(1 g) = 0.012 mW/g; SAR(10 g) = 0.00324 mW/g

Maximum value of SAR (measured) = 0.025 mW/g

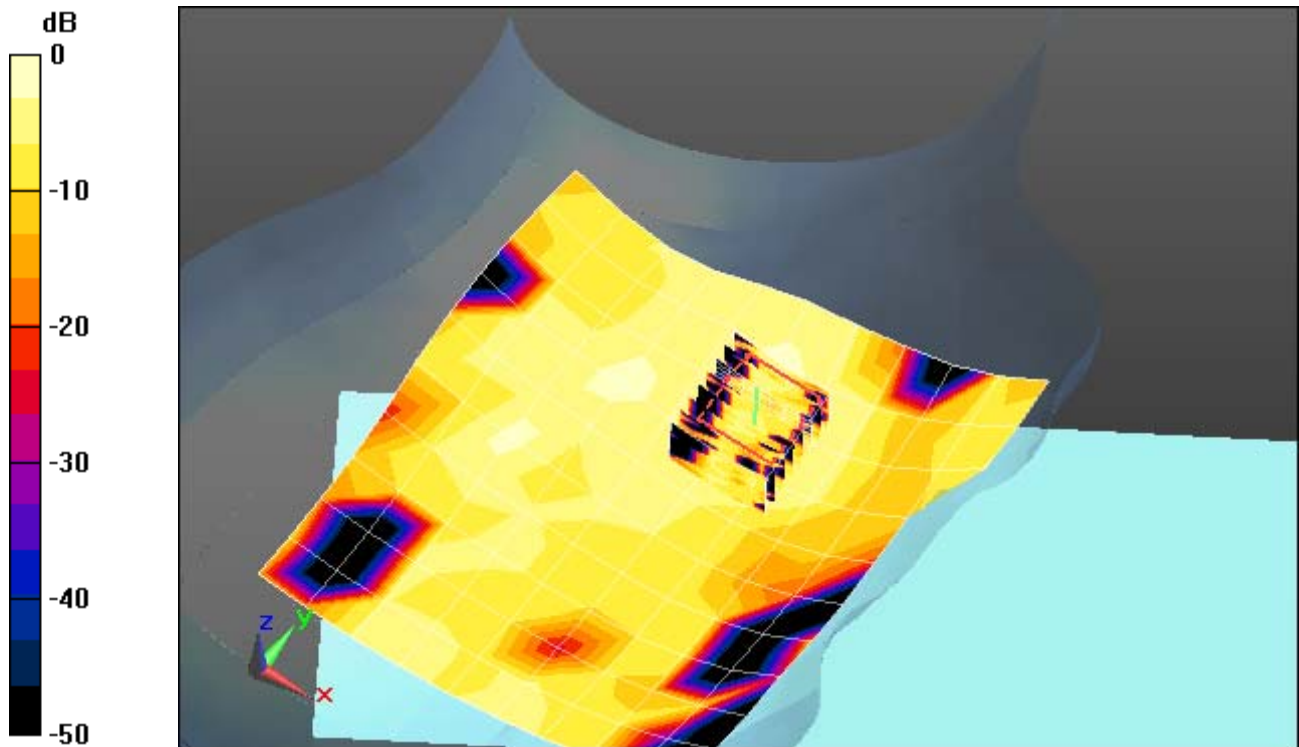

0 dB = 0.025mW/g

Plot 20: 5745MHz Right Tilt

Date/Time: 4/15/2011 5:29:20 PM, Date/Time: 4/15/2011 5:40:45 PM

DUT: Psion; Serial: STC02A393348E2

Communication System: IEEE 802.11a/h WiFi 5 GHz (OFDM, 12 Mbps); Frequency: 5745 MHz

Medium parameters used: $f = 5745 \text{ MHz}$; $\sigma = 5.07 \text{ mho/m}$; $\epsilon_r = 36.6$; $\rho = 1000 \text{ kg/m}^3$

Phantom section: Right Section

DASY5 Configuration:

- Probe: EX3DV4 - SN3739; ConvF(4.67, 4.67, 4.67);
- Sensor-Surface: 2mm (Mechanical Surface Detection)
- Electronics: DAE4 Sn1233; Calibrated: 10/13/2010
- Phantom: SAM; Type: QD 000 P40 CC; Serial: 1592
- Measurement SW: DASY52, V52.2 Build 0;

Right-Hand-Side HSL/Tilt Position - 5745/Area Scan (13x11x1): Measurement

grid: $dx=14\text{mm}$, $dy=14\text{mm}$

Maximum value of SAR (measured) = 0.017 mW/g

Right-Hand-Side HSL/Tilt Position - 5745/Zoom Scan (8x8x10)/Cube 0:

Measurement grid: $dx=4\text{mm}$, $dy=4\text{mm}$, $dz=2.5\text{mm}$

Reference Value = 0.640 V/m; Power Drift = -0.193 dB

Peak SAR (extrapolated) = 0.013 W/kg

SAR(1 g) = 0.000438 mW/g; SAR(10 g) = 4.36e-005 mW/g

Maximum value of SAR (measured) = 0.00984 mW/g

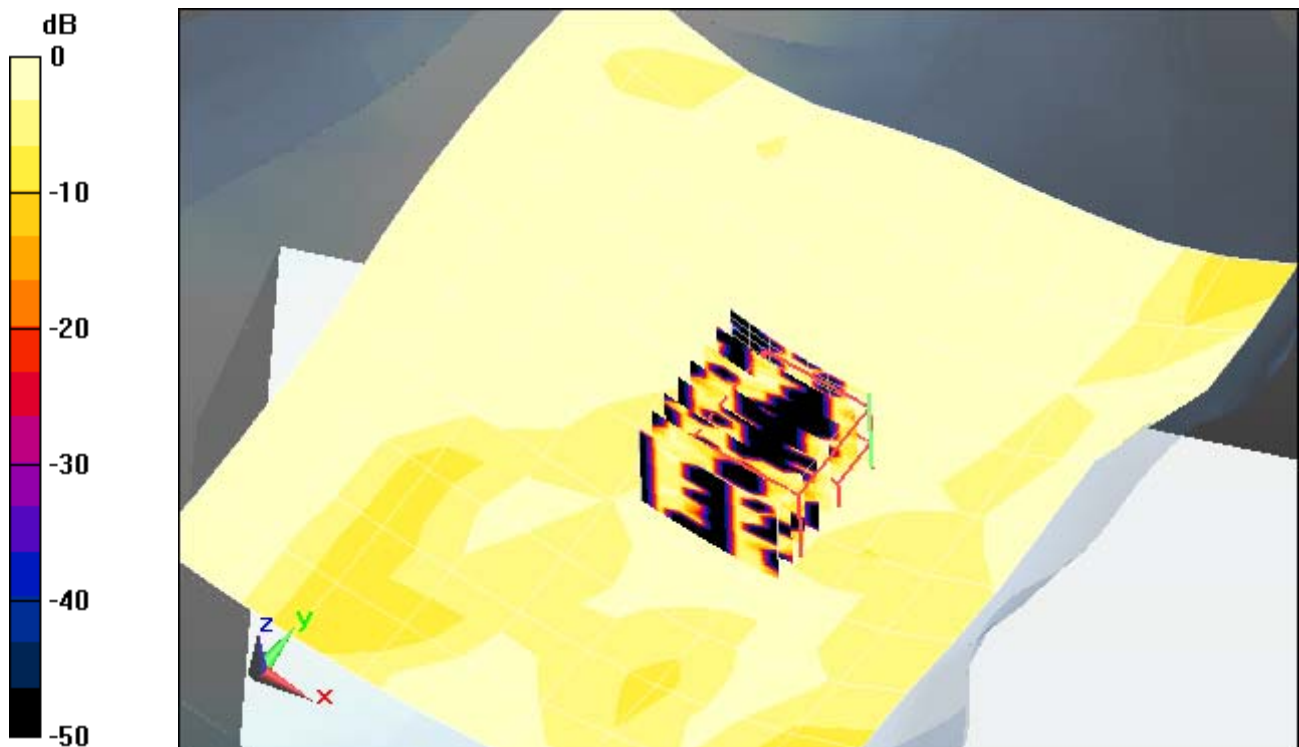

0 dB = 0.00984mW/g

Plot 21: 5745MHz Left Touch

Date/Time: 4/20/2011 11:46:28 AM, Date/Time: 4/20/2011 11:58:09 AM

DUT: Psion; Serial: STC02A393348E2

Communication System: IEEE 802.11a/h WiFi 5 GHz (OFDM, 12 Mbps); Frequency: 5745 MHz

Medium parameters used: $f = 5745$ MHz; $\sigma = 5.3$ mho/m; $\epsilon_r = 36.8$; $\rho = 1000$ kg/m³

Phantom section: Left Section

DASY5 Configuration:

- Probe: EX3DV4 - SN3739; ConvF(4.67, 4.67, 4.67);
- Sensor-Surface: 2mm (Mechanical Surface Detection)
- Electronics: DAE4 Sn1233; Calibrated: 10/13/2010
- Phantom: SAM; Type: QD 000 P40 CC; Serial: 1592
- Measurement SW: DASY52, V52.2 Build 0;

Left-Hand-Side HSL/Touch Position - 5745/Area Scan (13x11x1):

Measurement grid: dx=14mm, dy=14mm

Maximum value of SAR (measured) = 0.032 mW/g

Left-Hand-Side HSL/Touch Position - 5745/Zoom Scan (8x8x10)/Cube 0:

Measurement grid: dx=4mm, dy=4mm, dz=2.5mm

Reference Value = 0.606 V/m; Power Drift = -0.208 dB

Peak SAR (extrapolated) = 0.137 W/kg

SAR(1 g) = 0.022 mW/g; SAR(10 g) = 0.00843 mW/g

Maximum value of SAR (measured) = 0.050 mW/g

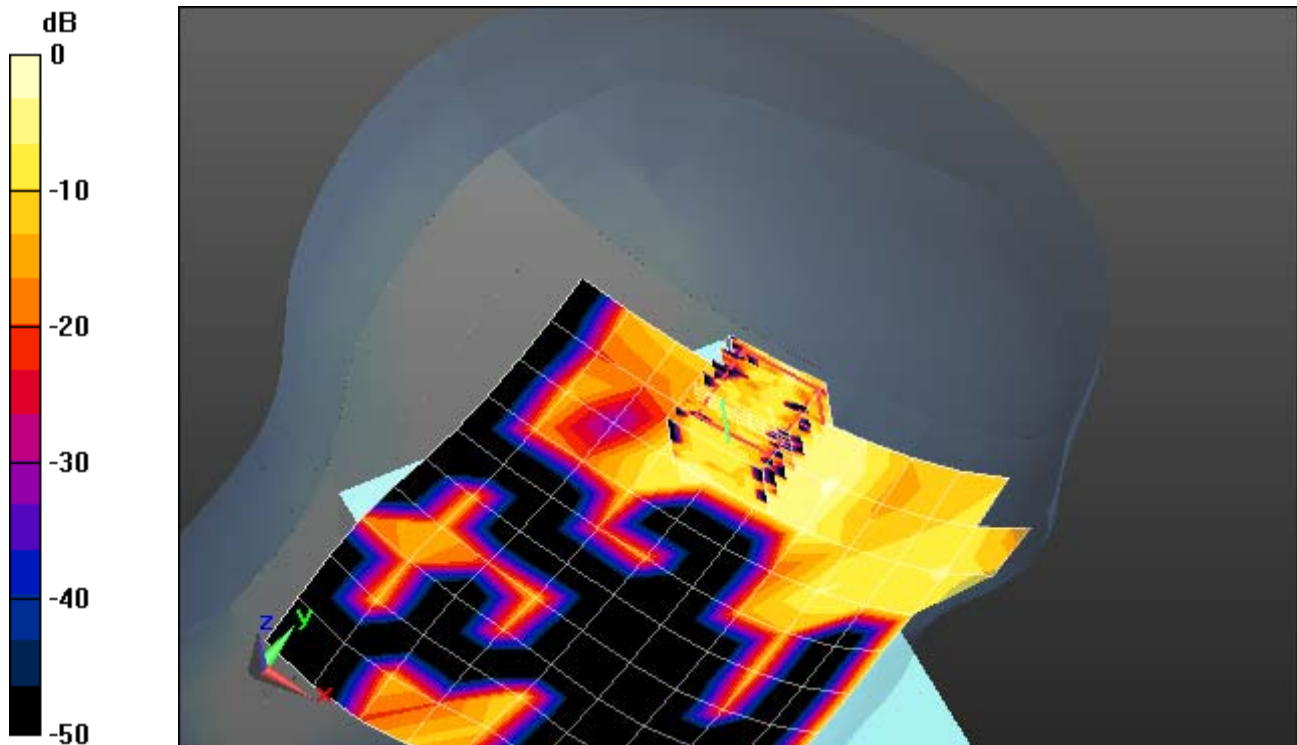

0 dB = 0.050mW/g

Plot 22: 5745MHz Left Tilt

Date/Time: 4/20/2011 11:11:29 AM, Date/Time: 4/20/2011 11:23:12 AM

DUT: Psion; Serial: STC02A393348E2

Communication System: IEEE 802.11a/h WiFi 5 GHz (OFDM, 12 Mbps); Frequency: 5745 MHz

Medium parameters used: $f = 5745 \text{ MHz}$; $\sigma = 5.3 \text{ mho/m}$; $\epsilon_r = 36.8$; $\rho = 1000 \text{ kg/m}^3$

Phantom section: Left Section

DASY5 Configuration:

- Probe: EX3DV4 - SN3739; ConvF(4.67, 4.67, 4.67);
- Sensor-Surface: 2mm (Mechanical Surface Detection)
- Electronics: DAE4 Sn1233; Calibrated: 10/13/2010
- Phantom: SAM; Type: QD 000 P40 CC; Serial: 1592
- Measurement SW: DASY52, V52.2 Build 0;

Left-Hand-Side HSL/Tilt Position - 5745/Area Scan (13x11x1): Measurement

grid: dx=14mm, dy=14mm

Maximum value of SAR (measured) = 0.033 mW/g

Left-Hand-Side HSL/Tilt Position - 5745/Zoom Scan (8x8x10)/Cube 0:

Measurement grid: dx=4mm, dy=4mm, dz=2.5mm

Reference Value = 0 V/m; Power Drift = 0 dB

Peak SAR (extrapolated) = 0.103 W/kg

SAR(1 g) = 0.000263 mW/g; SAR(10 g) = 8.11e-005 mW/g

Maximum value of SAR (measured) = 0.103 mW/g

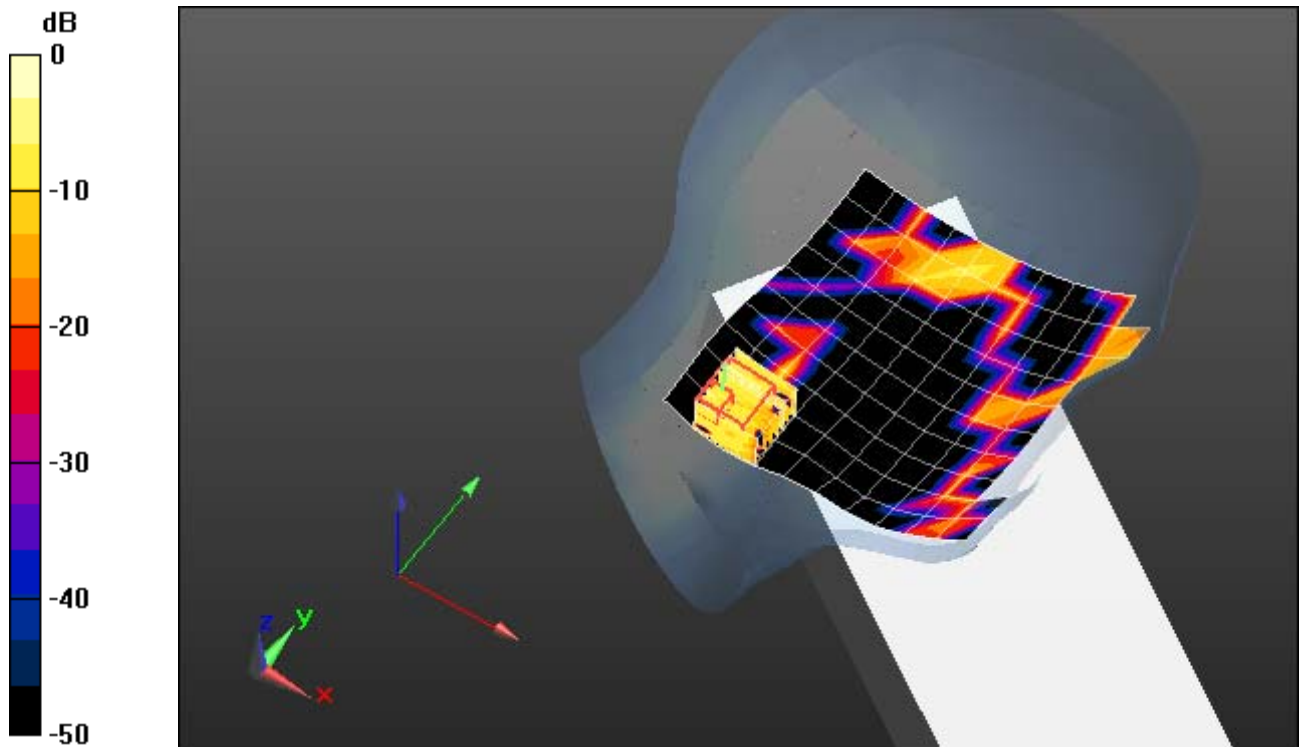

0 dB = 0.103mW/g

Plot 23: 5745MHz Right Edge 5mm

Date/Time: 5/17/2011 3:06:28 PM, Date/Time: 5/17/2011 3:15:54 PM

DUT: Psion; Serial: STC02A393348E2

Communication System: IEEE 802.11a/h WiFi 5 GHz (OFDM, 12 Mbps); Frequency: 5745 MHz

Medium parameters used: $f = 5745 \text{ MHz}$; $\sigma = 6.05 \text{ mho/m}$; $\epsilon_r = 48.5$; $\rho = 1000 \text{ kg/m}^3$

Phantom section: Flat Section

DASY5 Configuration:

- Probe: EX3DV4 - SN3739; ConvF(3.71, 3.71, 3.71);
- Sensor-Surface: 2mm (Mechanical Surface Detection)
- Electronics: DAE4 Sn1233; Calibrated: 10/13/2010
- Phantom: ELI 4.0; Type: QDOVA001BA; Serial: xxxx
- Measurement SW: DASY52, V52.2 Build 0;

Flat-Section MSL Right Edge/Right Edge 5745 5mm 2/Area Scan (8x11x1): Measurement grid:

$dx=14\text{mm}$, $dy=14\text{mm}$

Maximum value of SAR (measured) = 0.010 mW/g

Flat-Section MSL Right Edge/Right Edge 5745 5mm 2/Zoom Scan (4x4x2.5mm), dist=2mm

(8x8x10)/Cube 0: Measurement grid: $dx=4\text{mm}$, $dy=4\text{mm}$, $dz=2.5\text{mm}$

Reference Value = 0.496 V/m; Power Drift = 0.111 dB

Peak SAR (extrapolated) = 0.026 W/kg

SAR(1 g) = 0.00155 mW/g; SAR(10 g) = 0.000455 mW/g

Maximum value of SAR (measured) = 0.018 mW/g

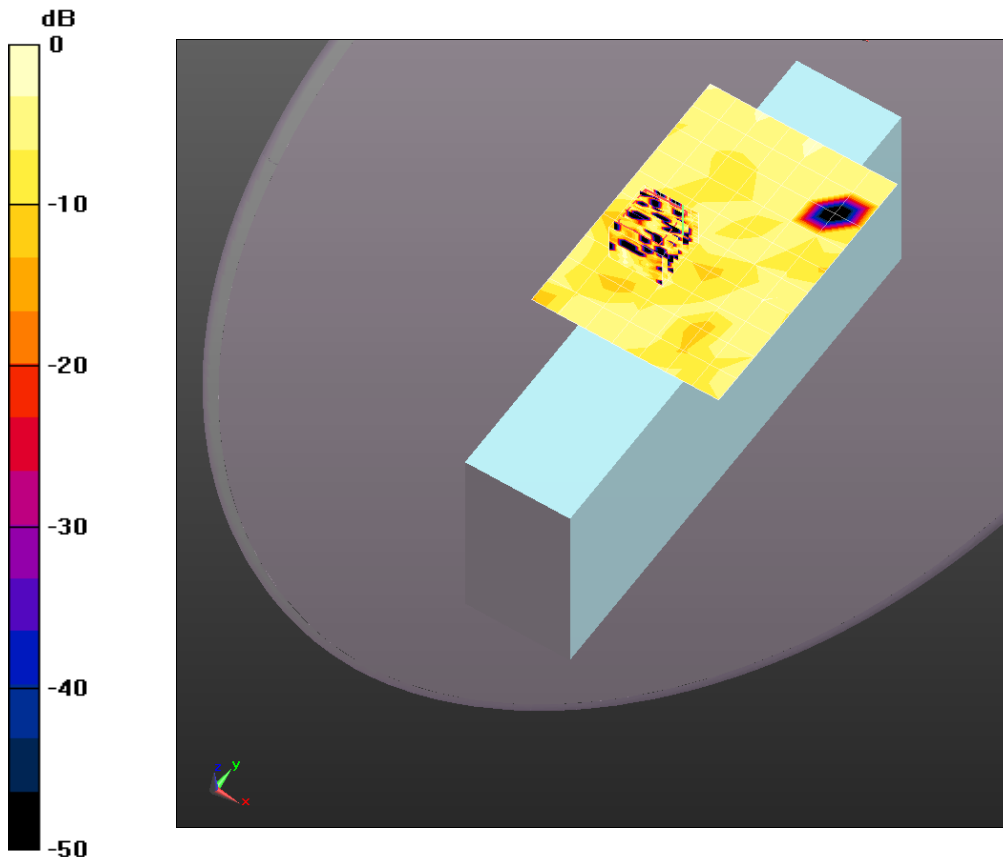

0 dB = 0.018mW/g

Plot 24: 5745MHz Back 5mm

Date/Time: 5/17/2011 1:08:49 PM, Date/Time: 5/17/2011 1:19:07 PM

DUT: Psion; Serial: STC02A393348E2

Communication System: IEEE 802.11a/h WiFi 5 GHz (OFDM, 12 Mbps); Frequency: 5745 MHz

Medium parameters used: $f = 5745 \text{ MHz}$; $\sigma = 6.05 \text{ mho/m}$; $\epsilon_r = 48.5$; $\rho = 1000 \text{ kg/m}^3$

Phantom section: Flat Section

DASY5 Configuration:

- Probe: EX3DV4 - SN3739; ConvF(3.71, 3.71, 3.71);
- Sensor-Surface: 2mm (Mechanical Surface Detection)
- Electronics: DAE4 Sn1233; Calibrated: 10/13/2010
- Phantom: ELI 4.0; Type: QDOVA001BA; Serial: xxxx
- Measurement SW: DASY52, V52.2 Build 0;

Flat-Section MSL/Back 5745 5mm/Area Scan (9x11x1): Measurement grid: $dx=14\text{mm}$, $dy=14\text{mm}$

Maximum value of SAR (measured) = 0.042 mW/g

Flat-Section MSL/Back 5745 5mm/Zoom Scan (4x4x2.5mm), dist=2mm (8x8x10)/Cube 0:

Measurement grid: $dx=4\text{mm}$, $dy=4\text{mm}$, $dz=2.5\text{mm}$

Reference Value = 1.38 V/m; Power Drift = -0.152 dB

Peak SAR (extrapolated) = 0.281 W/kg

SAR(1 g) = 0.030 mW/g; SAR(10 g) = 0.013 mW/g

Maximum value of SAR (measured) = 0.062 mW/g

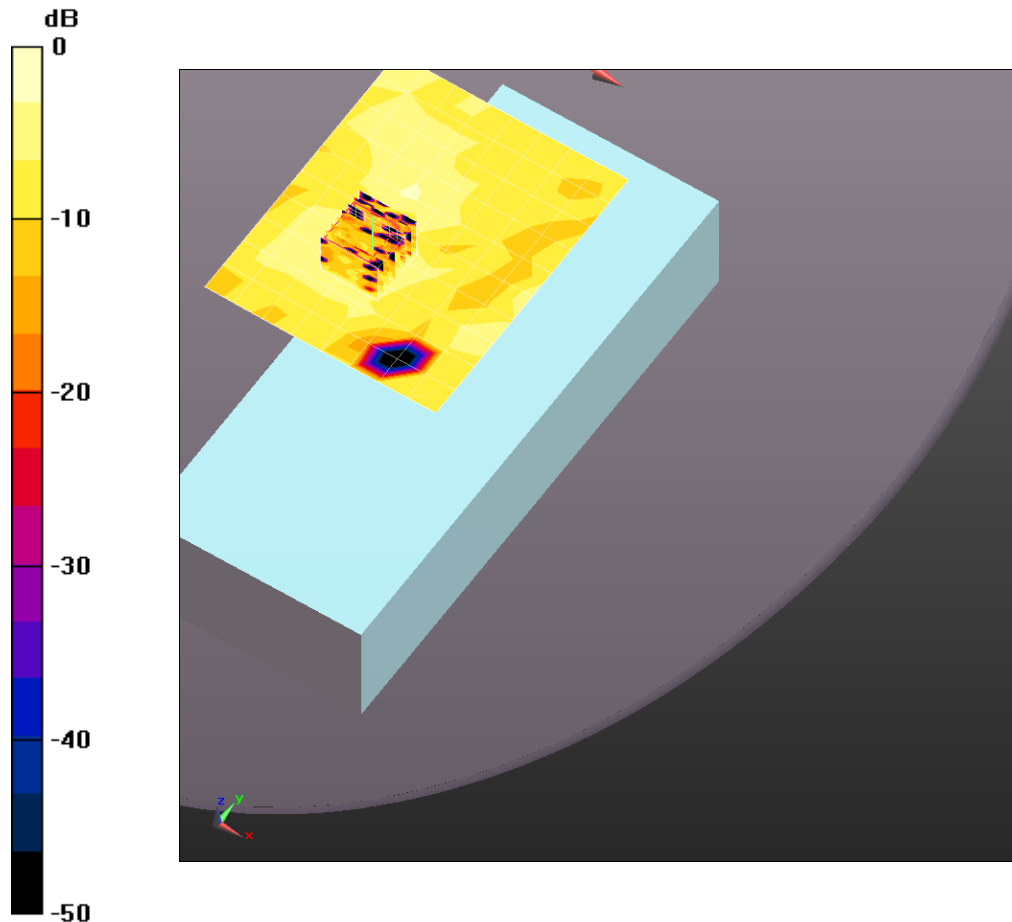

0 dB = 0.062mW/g

Plot 25: 2462MHz Right Touch

Date/Time: 4/28/2011 12:53:45 PM, Date/Time: 4/28/2011 1:05:14 PM

DUT: Psion; Serial: STC02A393348E2

Communication System: IEEE 802.11g WiFi 2.4 GHz (DSSS/OFDM, 12 Mbps); Frequency: 2462 MHz

Medium parameters used (interpolated): $f = 2462$ MHz; $\sigma = 1.87$ mho/m; $\epsilon_r = 38.1$; $\rho = 1000$ kg/m³

Phantom section: Right Section

DASY5 Configuration:

- Probe: ES3DV3 - SN3244; ConvF(4.48, 4.48, 4.48);
- Sensor-Surface: 4mm (Mechanical Surface Detection)
- Electronics: DAE4 Sn1233; Calibrated: 10/13/2010
- Phantom: SAM; Type: QD 000 P40 CC; Serial: 1592
- Measurement SW: DASY52, V52.2 Build 0;

Right-Hand-Side HSL US 4-28-11/Touch Position - High/Area Scan (13x11x1): Measurement grid:

dx=14mm, dy=14mm

Info: [Interpolated medium parameters used for SAR evaluation.](#)

Maximum value of SAR (measured) = 0.00992 mW/g

Right-Hand-Side HSL US 4-28-11/Touch Position - High/Zoom Scan (7x7x7)/Cube 0: Measurement

grid: dx=5mm, dy=5mm, dz=5mm

Reference Value = 0 V/m; Power Drift = 0 dB

Peak SAR (extrapolated) = 0.020 W/kg

SAR(1 g) = 0.011 mW/g; SAR(10 g) = 0.0058 mW/gInfo: [Interpolated medium parameters used for SAR evaluation.](#)

Maximum value of SAR (measured) = 0.012 mW/g

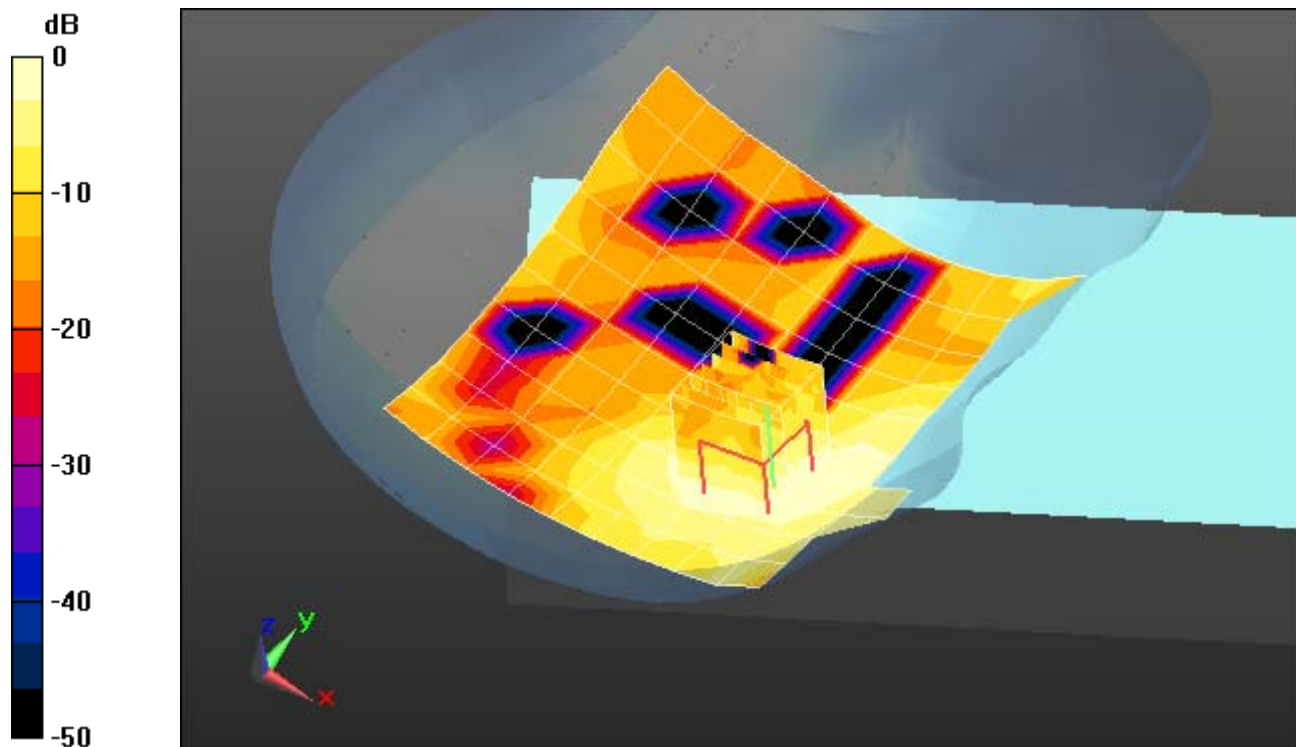

0 dB = 0.012mW/g

Plot 26: 2462MHz Right Tilt

Date/Time: 4/28/2011 1:22:46 PM, Date/Time: 4/28/2011 1:34:17 PM

DUT: Psion; Serial: STC02A393348E2

Communication System: IEEE 802.11g WiFi 2.4 GHz (DSSS/OFDM, 12 Mbps); Frequency: 2462 MHz

Medium parameters used (interpolated): $f = 2462$ MHz; $\sigma = 1.87$ mho/m; $\epsilon_r = 38.1$; $\rho = 1000$ kg/m³

Phantom section: Right Section

DASY5 Configuration:

- Probe: ES3DV3 - SN3244; ConvF(4.48, 4.48, 4.48);
- Sensor-Surface: 4mm (Mechanical Surface Detection)
- Electronics: DAE4 Sn1233; Calibrated: 10/13/2010
- Phantom: SAM; Type: QD 000 P40 CC; Serial: 1592
- Measurement SW: DASY52, V52.2 Build 0;

Right-Hand-Side HSL US 4-28-11/Tilt Position - High/Area Scan (13x11x1): Measurement grid:

$dx=14$ mm, $dy=14$ mm

[Info: Interpolated medium parameters used for SAR evaluation.](#)

Maximum value of SAR (measured) = 0.00713 mW/g

Right-Hand-Side HSL US 4-28-11/Tilt Position - High/Zoom Scan (7x7x7)/Cube 0: Measurement grid:

$dx=5$ mm, $dy=5$ mm, $dz=5$ mm

Reference Value = 0.241 V/m; Power Drift = -0.182 dB

Peak SAR (extrapolated) = 0.029 W/kg

SAR(1 g) = 0.00762 mW/g; SAR(10 g) = 0.00412 mW/g

[Info: Interpolated medium parameters used for SAR evaluation.](#)

Maximum value of SAR (measured) = 0.00841 mW/g

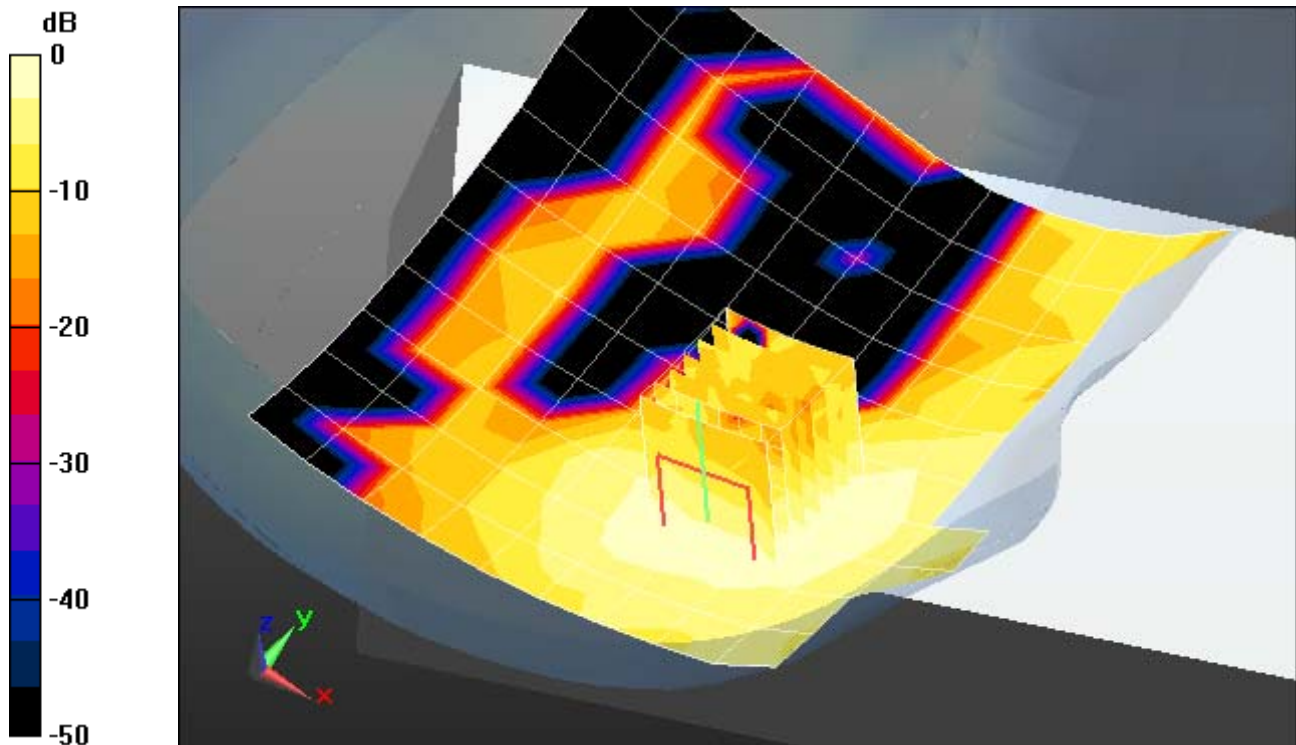

0 dB = 0.00841mW/g

Plot 27: 2462MHz Left Touch

Date/Time: 4/28/2011 10:36:57 AM, Date/Time: 4/28/2011 10:48:38 AM

DUT: Psion; Serial: STC02A393348E2

Communication System: IEEE 802.11g WiFi 2.4 GHz (DSSS/OFDM, 12 Mbps); Frequency: 2462 MHz

Medium parameters used (interpolated): $f = 2462$ MHz; $\sigma = 1.87$ mho/m; $\epsilon_r = 38.1$; $\rho = 1000$ kg/m³

Phantom section: Left Section

DASY5 Configuration:

- Probe: ES3DV3 - SN3244; ConvF(4.48, 4.48, 4.48);
- Sensor-Surface: 4mm (Mechanical Surface Detection)
- Electronics: DAE4 Sn1233; Calibrated: 10/13/2010
- Phantom: SAM; Type: QD 000 P40 CC; Serial: 1592
- Measurement SW: DASY52, V52.2 Build 0;

Left-Hand-Side HSL US 4-28-11/Touch Position - High/Area Scan (13x11x1): Measurement grid:

$dx=14$ mm, $dy=14$ mm

Info: [Interpolated medium parameters used for SAR evaluation.](#)

Maximum value of SAR (measured) = 0.00809 mW/g

Left-Hand-Side HSL US 4-28-11/Touch Position - High/Zoom Scan (7x7x7)/Cube 0: Measurement

grid: $dx=5$ mm, $dy=5$ mm, $dz=5$ mm

Reference Value = 0.319 V/m; Power Drift = 0.177 dB

Peak SAR (extrapolated) = 0.024 W/kg

SAR(1 g) = 0.010 mW/g; SAR(10 g) = 0.00583 mW/g

Info: [Interpolated medium parameters used for SAR evaluation.](#)

Maximum value of SAR (measured) = 0.011 mW/g

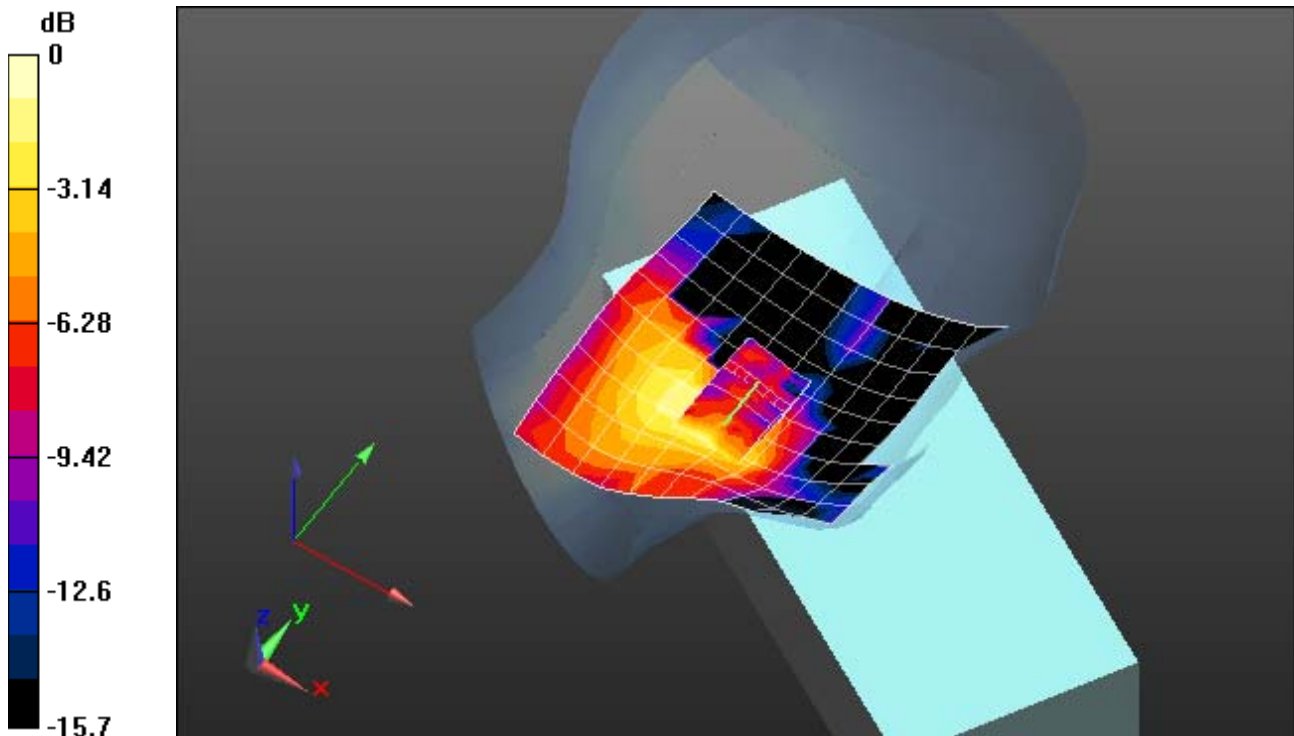

0 dB = 0.011mW/g

Plot 28: 2462MHz Left Tilt

Date/Time: 4/28/2011 11:42:26 AM, Date/Time: 4/28/2011 12:07:13 PM

DUT: Psion; Serial: STC02A393348E2

Communication System: IEEE 802.11g WiFi 2.4 GHz (DSSS/OFDM, 12 Mbps); Frequency: 2462 MHz

Medium parameters used (interpolated): $f = 2462$ MHz; $\sigma = 1.87$ mho/m; $\epsilon_r = 38.1$; $\rho = 1000$ kg/m³

Phantom section: Left Section

DASY5 Configuration:

- Probe: ES3DV3 - SN3244; ConvF(4.48, 4.48, 4.48);
- Sensor-Surface: 4mm (Mechanical Surface Detection)
- Electronics: DAE4 Sn1233; Calibrated: 10/13/2010
- Phantom: SAM; Type: QD 000 P40 CC; Serial: 1592
- Measurement SW: DASY52, V52.2 Build 0;

Left-Hand-Side HSL US 4-28-11/Tilt Position - High 2/Area Scan (19x16x1): Measurement grid:

$dx=10$ mm, $dy=10$ mm

Info: [Interpolated medium parameters used for SAR evaluation.](#)

Maximum value of SAR (measured) = 0.00583 mW/g

Left-Hand-Side HSL US 4-28-11/Tilt Position - High 2/Zoom Scan (7x7x7)/Cube 0: Measurement grid:

$dx=5$ mm, $dy=5$ mm, $dz=5$ mm

Reference Value = 0 V/m; Power Drift = 0 dB

Peak SAR (extrapolated) = 0.023 W/kg

SAR(1 g) = 0.00477 mW/g; SAR(10 g) = 0.00214 mW/g

Info: [Interpolated medium parameters used for SAR evaluation.](#)

Maximum value of SAR (measured) = 0.00524 mW/g

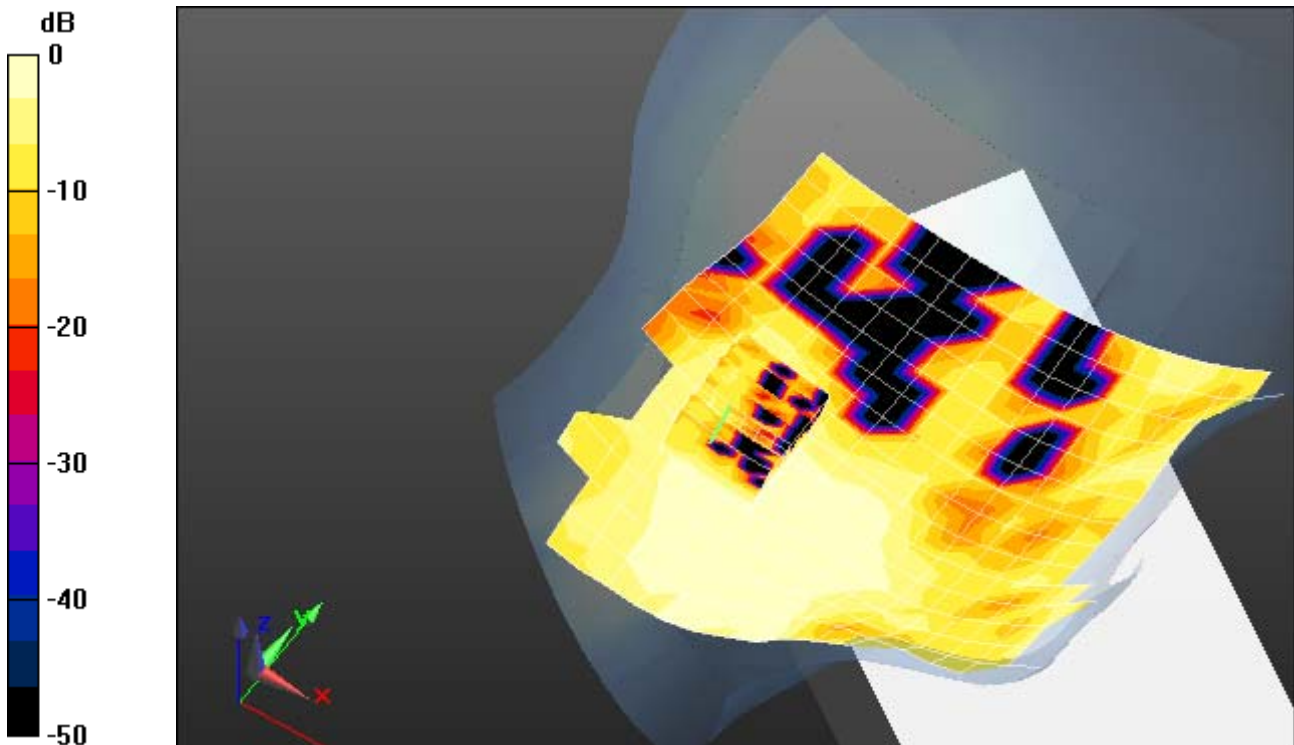

0 dB = 0.00524mW/g

Plot 29: 2462MHz Left Edge 5mm

Date/Time: 5/13/2011 3:51:12 PM, Date/Time: 5/13/2011 3:59:46 PM

DUT: Psion; Serial: STC02A393348E2

Communication System: IEEE 802.11g WiFi 2.4 GHz (DSSS/OFDM, 12 Mbps); Frequency: 2462 MHz

Medium parameters used: $f = 2462$ MHz; $\sigma = 2.05$ mho/m; $\epsilon_r = 50.3$; $\rho = 1000$ kg/m³

Phantom section: Flat Section

DASY5 Configuration:

- Probe: ES3DV3 - SN3244; ConvF(4.24, 4.24, 4.24);
- Sensor-Surface: 4mm (Mechanical Surface Detection)
- Electronics: DAE4 Sn1233; Calibrated: 10/13/2010
- Phantom: ELI 4.0; Type: QDOVA001BB; Serial: 1092
- Measurement SW: DASY52, V52.2 Build 0;

Flat-Section MSL _Side Edge/Left Edge Ch11 5mm/Area Scan (8x11x1):

Measurement grid: dx=14mm, dy=14mm

Maximum value of SAR (measured) = 0.163 mW/g

Flat-Section MSL _Side Edge/Left Edge Ch11 5mm/Zoom Scan**(7x7x7)/Cube 0:** Measurement grid: dx=5mm, dy=5mm, dz=5mm

Reference Value = 7.48 V/m; Power Drift = -0.187 dB

Peak SAR (extrapolated) = 0.310 W/kg

SAR(1 g) = 0.155 mW/g; SAR(10 g) = 0.089 mW/g

Maximum value of SAR (measured) = 0.166 mW/g

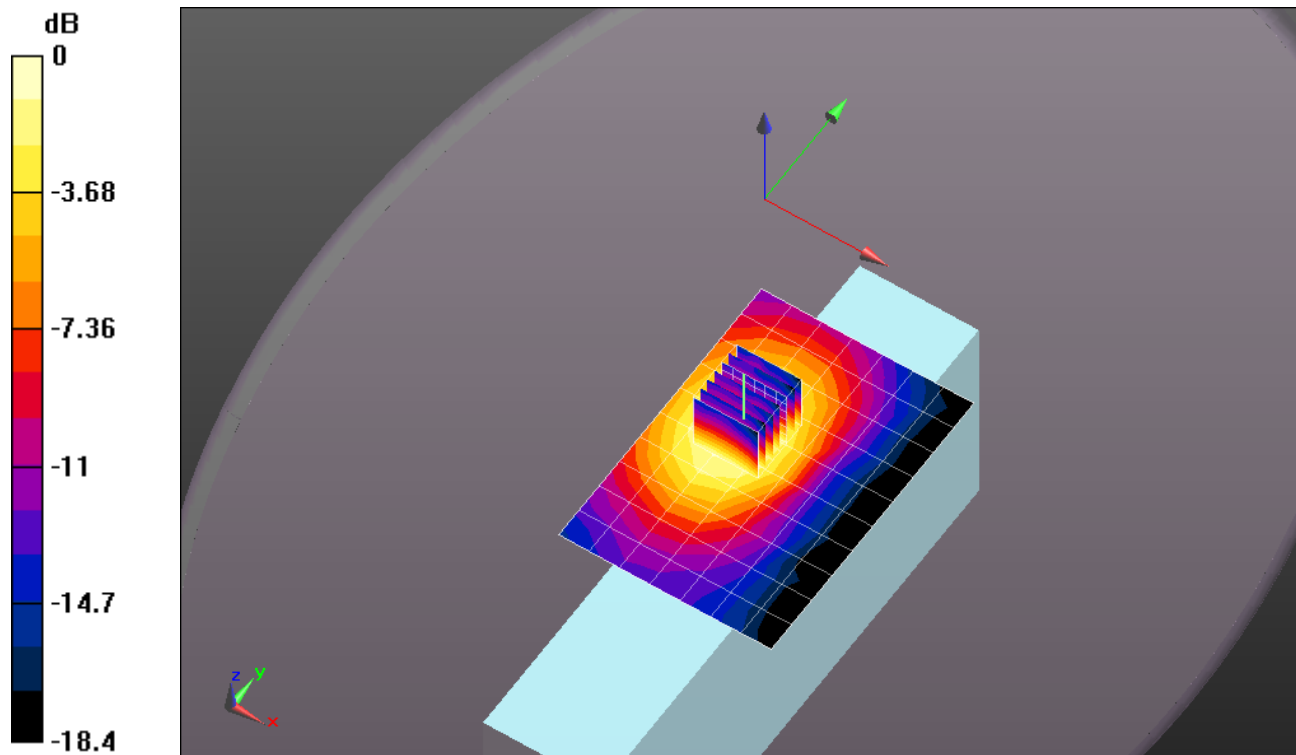

0 dB = 0.166mW/g

Plot 30: 2462MHz Front 5mm

Date/Time: 5/13/2011 2:39:46 PM, Date/Time: 5/13/2011 2:55:44 PM

DUT: Psion; Serial: STC02A393348E2

Communication System: IEEE 802.11g WiFi 2.4 GHz (DSSS/OFDM, 12 Mbps); Frequency: 2462 MHz

Medium parameters used: $f = 2462 \text{ MHz}$; $\sigma = 2.05 \text{ mho/m}$; $\epsilon_r = 50.3$; $\rho = 1000 \text{ kg/m}^3$

Phantom section: Flat Section

DASY5 Configuration:

- Probe: ES3DV3 - SN3244; ConvF(4.24, 4.24, 4.24);
- Sensor-Surface: 4mm (Mechanical Surface Detection)
- Electronics: DAE4 Sn1233; Calibrated: 10/13/2010
- Phantom: ELI 4.0; Type: QDOVA001BB; Serial: 1092
- Measurement SW: DASY52, V52.2 Build 0;

Flat-Section MSL/Front Ch11 5mm/Area Scan (11x15x1): Measurement grid: $dx=14\text{mm}$, $dy=14\text{mm}$

Maximum value of SAR (measured) = 0.027 mW/g

Flat-Section MSL/Front Ch11 5mm/Zoom Scan (7x7x7)/Cube 0: Measurement grid: $dx=5\text{mm}$,

$dy=5\text{mm}$, $dz=5\text{mm}$

Reference Value = 0.722 V/m; Power Drift = -0.163 dB

Peak SAR (extrapolated) = 0.050 W/kg

SAR(1 g) = 0.025 mW/g; SAR(10 g) = 0.013 mW/g

Maximum value of SAR (measured) = 0.028 mW/g

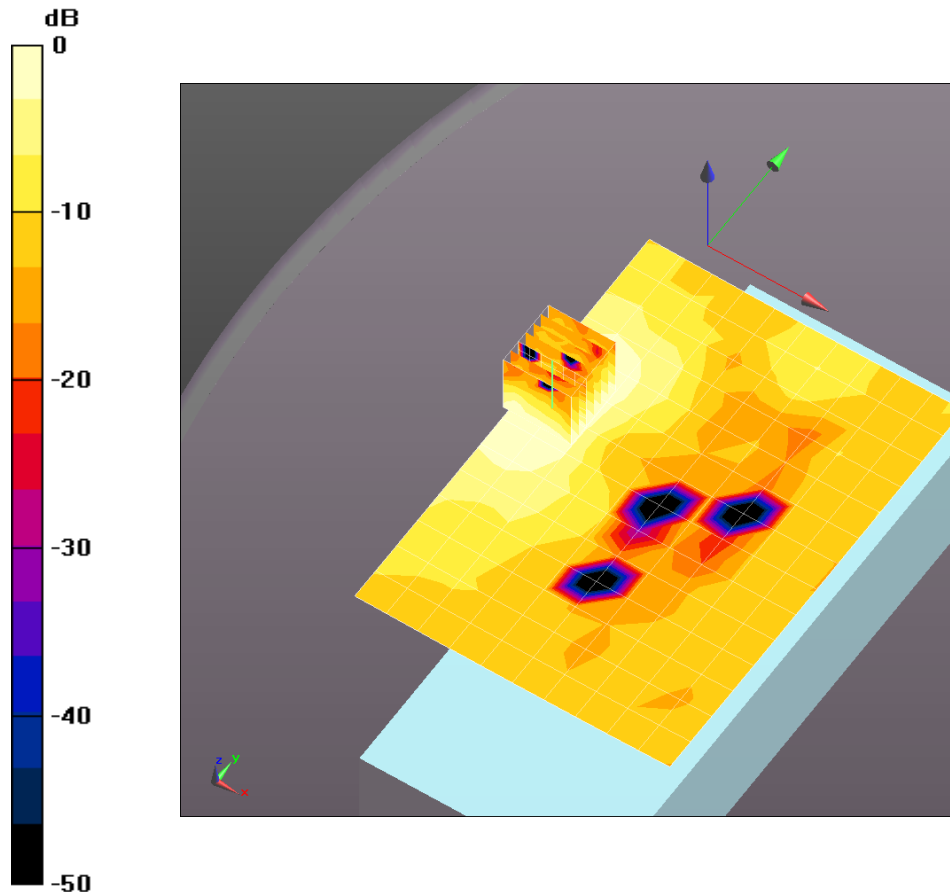

0 dB = 0.028mW/g

Plot 31: 2462MHz Back 5mm

Date/Time: 5/13/2011 3:11:00 PM, Date/Time: 5/13/2011 3:27:16 PM

DUT: Psion; Serial: STC02A393348E2

Communication System: IEEE 802.11g WiFi 2.4 GHz (DSSS/OFDM, 12 Mbps); Frequency: 2462 MHz

Medium parameters used: $f = 2462$ MHz; $\sigma = 2.05$ mho/m; $\epsilon_r = 50.3$; $\rho = 1000$ kg/m³

Phantom section: Flat Section

DASY5 Configuration:

- Probe: ES3DV3 - SN3244; ConvF(4.24, 4.24, 4.24);
- Sensor-Surface: 4mm (Mechanical Surface Detection)
- Electronics: DAE4 Sn1233; Calibrated: 10/13/2010
- Phantom: ELI 4.0; Type: QDOVA001BB; Serial: 1092
- Measurement SW: DASY52, V52.2 Build 0;

Flat-Section MSL/Back Ch11 5mm/Area Scan (11x15x1): Measurement grid:

dx=14mm, dy=14mm

Maximum value of SAR (measured) = 0.146 mW/g

Flat-Section MSL/Back Ch11 5mm/Zoom Scan (7x7x7)/Cube 0: Measurement

grid: dx=5mm, dy=5mm, dz=5mm

Reference Value = 1.31 V/m; Power Drift = -0.198 dB

Peak SAR (extrapolated) = 0.286 W/kg

SAR(1 g) = 0.151 mW/g; SAR(10 g) = 0.082 mW/g

Maximum value of SAR (measured) = 0.164 mW/g

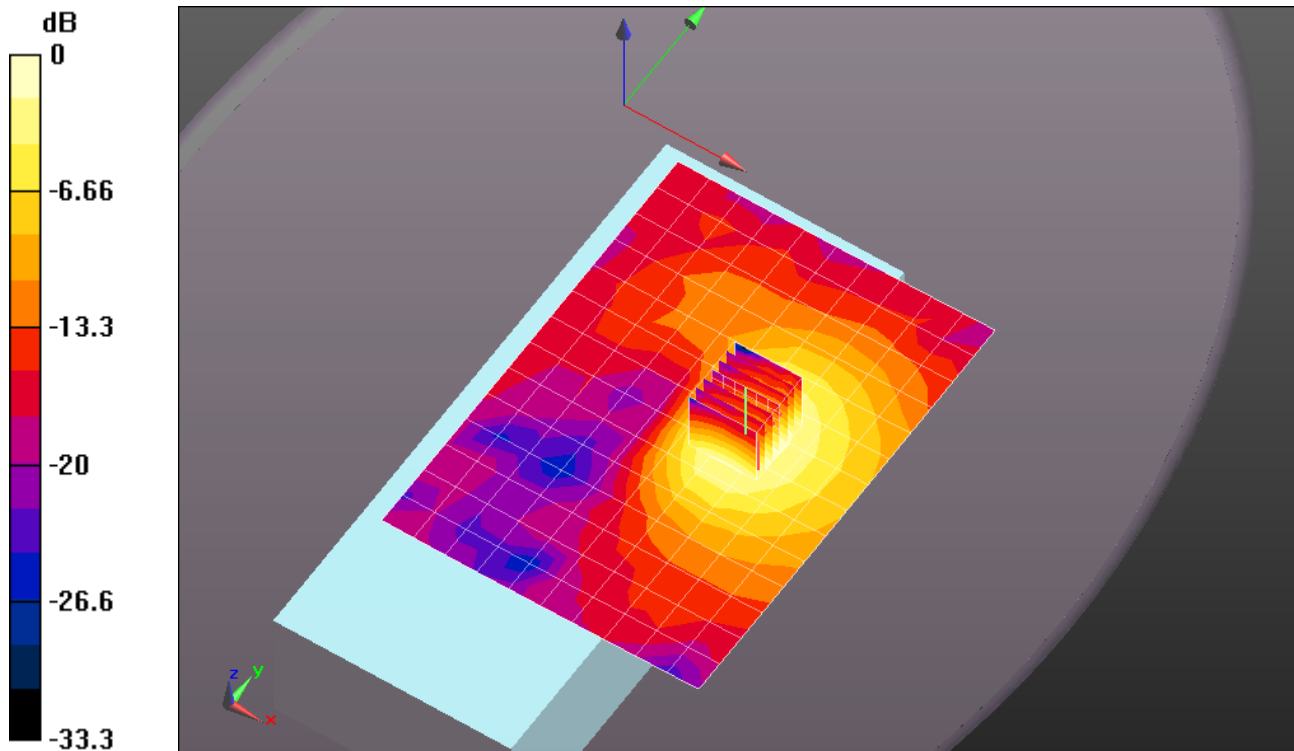

Plot 32: Dipole Verification, 2450MHz, 2011/04/27

Date/Time: 4/27/2011 12:34:05 PM, Date/Time: 4/27/2011 12:39:07 PM

DUT: Dipole 2450 MHz D2450V2; Serial: D2450V2 - SN:859

Communication System: CW; Frequency: 2450 MHz

Medium parameters used: $f = 2450$ MHz; $\sigma = 1.85$ mho/m; $\epsilon_r = 38.1$; $\rho = 1000$ kg/m³

Phantom section: Flat Section

DASY5 Configuration:

- Probe: ES3DV3 - SN3244; ConvF(4.48, 4.48, 4.48);
- Sensor-Surface: 3mm (Mechanical Surface Detection)
- Electronics: DAE4 Sn1233; Calibrated: 10/13/2010
- Phantom: SAM; Type: QD 000 P40 CC; Serial: 1592
- Measurement SW: DASY52, V52.2 Build 0;

System Performance Check at Frequencies above 1 GHz/d=10mm, Pin=xx mW, dist=3.0mm (ES-Probe)/Area Scan (7x7x1): Measurement grid: dx=15mm, dy=15mm

Maximum value of SAR (measured) = 63.1 mW/g

System Performance Check at Frequencies above 1 GHz/d=10mm, Pin=xx mW, dist=3.0mm (ES-Probe)/Zoom Scan (7x7x7) (7x7x7)/Cube 0:

Measurement grid: dx=5mm, dy=5mm, dz=5mm

Reference Value = 205.7 V/m; Power Drift = -0.038 dB

Peak SAR (extrapolated) = 116.6 W/kg

SAR(1 g) = 54.1 mW/g; SAR(10 g) = 24.1 mW/g

Maximum value of SAR (measured) = 72.1 mW/g

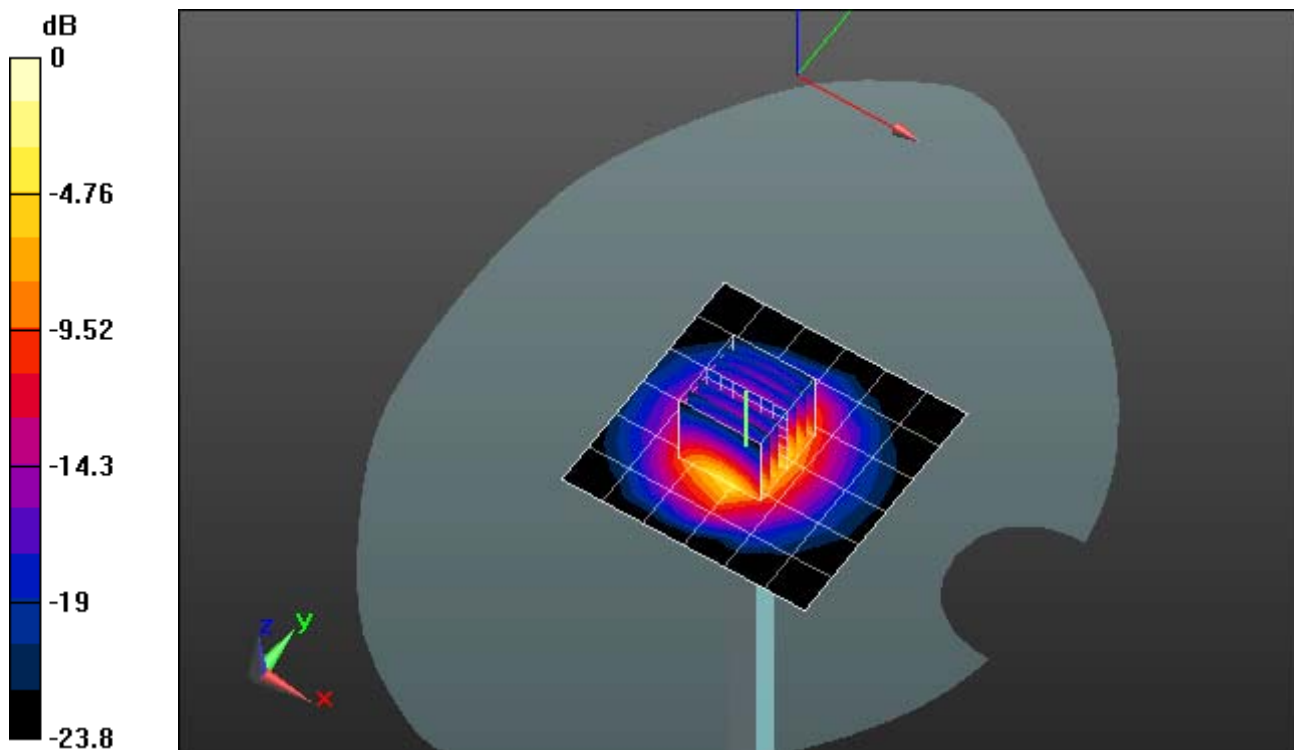

0 dB = 72.1mW/g

Plot 33: Dipole Verification, 2450MHz, 2011/05/13

Date/Time: 5/13/2011 2:09:07 PM, Date/Time: 5/13/2011 2:14:11 PM

DUT: Dipole 2450 MHz D2450V2; Serial: D2450V2 - SN:859

Communication System: CW; Frequency: 2450 MHz

Medium parameters used: $f = 2450$ MHz; $\sigma = 2.03$ mho/m; $\epsilon_r = 50.4$; $\rho = 1000$ kg/m³

Phantom section: Flat Section

DASY5 Configuration:

- Probe: ES3DV3 - SN3244; ConvF(4.24, 4.24, 4.24);
- Sensor-Surface: 3mm (Mechanical Surface Detection)
- Electronics: DAE4 Sn1233; Calibrated: 10/13/2010
- Phantom: ELI 4.0; Type: QDOVA001BA; Serial: xxxx
- Measurement SW: DASY52, V52.2 Build 0;

System Performance Check at Frequencies above 1 GHz/d=10mm, Pin=xx mW, dist=3.0mm (ES-Probe)/Area Scan (7x7x1): Measurement grid: dx=15mm, dy=15mm

Maximum value of SAR (measured) = 47.8 mW/g

System Performance Check at Frequencies above 1 GHz/d=10mm, Pin=xx mW, dist=3.0mm (ES-Probe)/Zoom Scan (7x7x7) (7x7x7)/Cube 0: Measurement grid: dx=5mm, dy=5mm, dz=5mm

Reference Value = 177.6 V/m; Power Drift = 0.101 dB

Peak SAR (extrapolated) = 97.8 W/kg

SAR(1 g) = 46 mW/g; SAR(10 g) = 21.2 mW/g

Maximum value of SAR (measured) = 60.3 mW/g

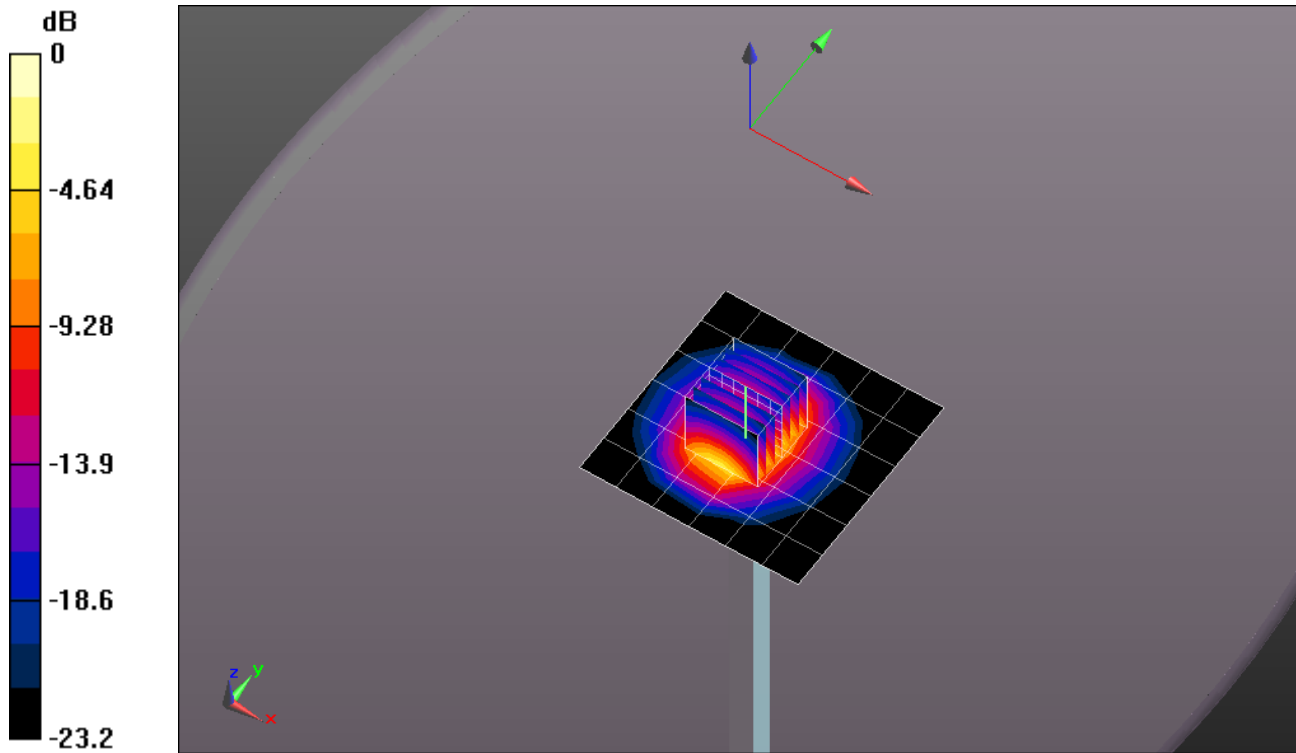

0 dB = 60.3mW/g

Plot 34: Dipole Verification, 5200MHz, 2011/04/14

Date/Time: 4/14/2011 5:18:54 PM, Date/Time: 4/14/2011 5:29:04 PM

DUT: Dipole D5GHzV2; Serial: D5GHzV2 - SN:1096

Communication System: CW-5GHz; Frequency: 5200 MHz

Medium parameters used: $f = 5200$ MHz; $\sigma = 4.48$ mho/m; $\epsilon_r = 37.4$; $\rho = 1000$ kg/m³

Phantom section: Flat Section

DASY5 Configuration:

- Probe: EX3DV4 - SN3739; ConvF(5.52, 5.52, 5.52);
- Sensor-Surface: 2mm (Mechanical Surface Detection)
- Electronics: DAE4 Sn1233; Calibrated: 10/13/2010
- Phantom: SAM; Type: QD 000 P40 CC; Serial: 1592
- Measurement SW: DASY52, V52.2 Build 0;

System Performance Check with D5GHzV2 Dipole (uniform grid)/d=10mm, Pin=100mW, f=5200 MHz/Area Scan (10x10x1): Measurement

grid: dx=10mm, dy=10mm

Maximum value of SAR (measured) = 9.84 mW/g

System Performance Check with D5GHzV2 Dipole (uniform grid)/d=10mm, Pin=100mW, f=5200 MHz/Zoom Scan (4x4x2.5mm), dist=2mm (8x8x10)/Cube 0: Measurement grid: dx=4mm, dy=4mm, dz=2.5mm

Reference Value = 62.6 V/m; Power Drift = -0.00166 dB

Peak SAR (extrapolated) = 34.5 W/kg

SAR(1 g) = 7.98 mW/g; SAR(10 g) = 2.3 mW/g

Maximum value of SAR (measured) = 15.6 mW/g

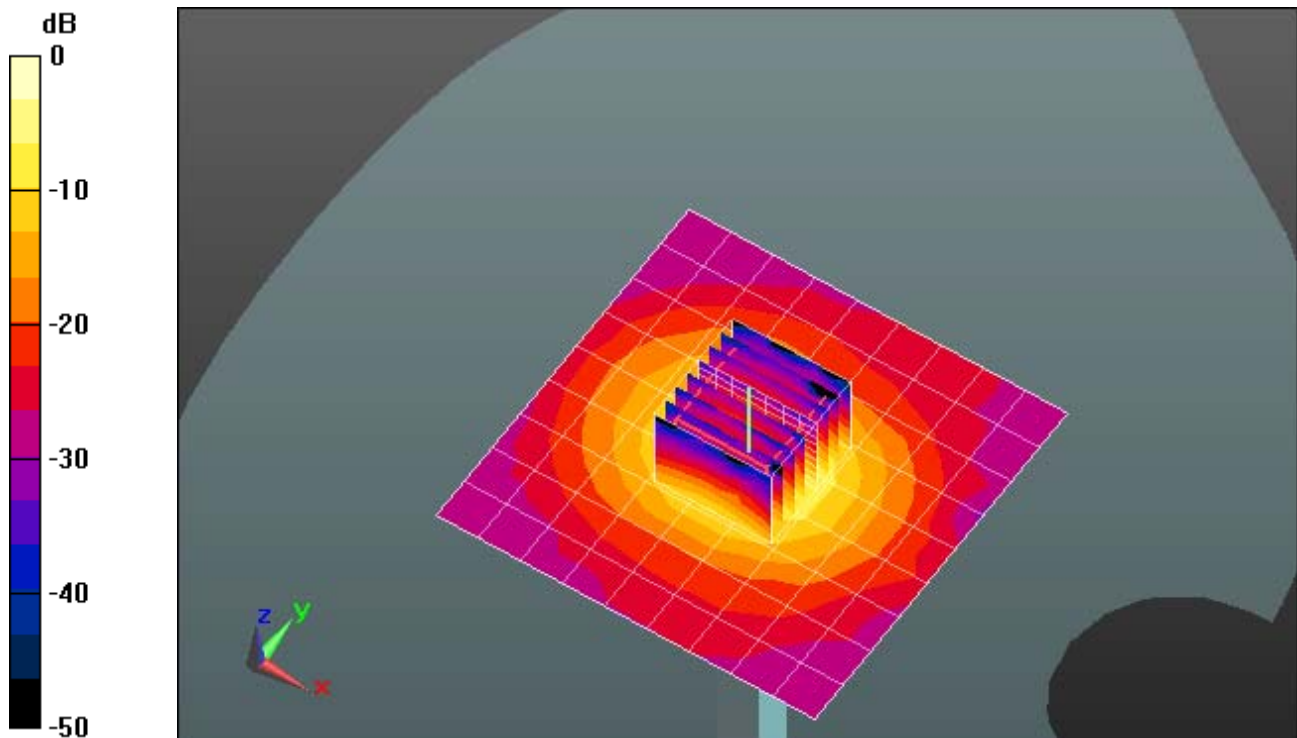

0 dB = 15.6mW/g

Plot 35: Dipole Verification, 5200MHz, 2011/04/16

Date/Time: 4/16/2011 2:17:21 PM, Date/Time: 4/16/2011 2:27:30 PM

DUT: Dipole D5GHzV2; Serial: D5GHzV2 - SN:1096

Communication System: CW-5GHz; Frequency: 5200 MHz

Medium parameters used: $f = 5200$ MHz; $\sigma = 4.68$ mho/m; $\epsilon_r = 37.6$; $\rho = 1000$ kg/m³

Phantom section: Flat Section

DASY5 Configuration:

- Probe: EX3DV4 - SN3739; ConvF(5.52, 5.52, 5.52);
- Sensor-Surface: 2mm (Mechanical Surface Detection)
- Electronics: DAE4 Sn1233; Calibrated: 10/13/2010
- Phantom: SAM; Type: QD 000 P40 CC; Serial: 1592
- Measurement SW: DASY52, V52.2 Build 0;

System Performance Check with D5GHzV2 Dipole (uniform

grid)/d=10mm, Pin=100mW, f=5200 MHz/Area Scan (10x10x1): Measurement

grid: dx=10mm, dy=10mm

Maximum value of SAR (measured) = 13.4 mW/g

System Performance Check with D5GHzV2 Dipole (uniform

grid)/d=10mm, Pin=100mW, f=5200 MHz/Zoom Scan (4x4x2.5mm),

dist=2mm (8x8x10)/Cube 0: Measurement grid: dx=4mm, dy=4mm, dz=2.5mm

Reference Value = 58.3 V/m; Power Drift = 0.050 dB

Peak SAR (extrapolated) = 34.2 W/kg

SAR(1 g) = 8 mW/g; SAR(10 g) = 2.32 mW/g

Maximum value of SAR (measured) = 15.1 mW/g

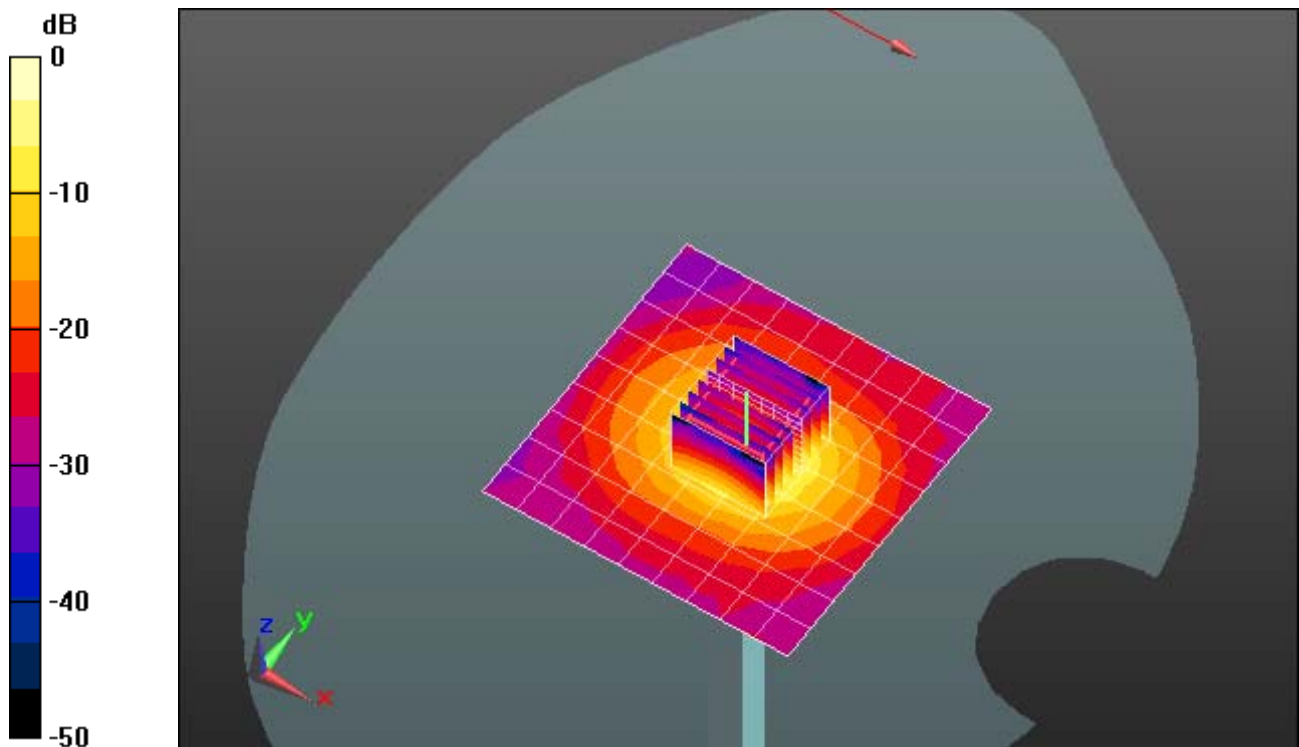

0 dB = 15.1mW/g

Plot 36: Dipole Verification, 5200, 2011/05/16

Date/Time: 5/16/2011 9:39:58 AM, Date/Time: 5/16/2011 9:50:15 AM

DUT: Dipole D5GHzV2; Serial: D5GHzV2 - SN:1096

Communication System: CW-5GHz; Frequency: 5200 MHz

Medium parameters used: $f = 5200$ MHz; $\sigma = 5.36$ mho/m; $\epsilon_r = 49.5$; $\rho = 1000$ kg/m³

Phantom section: Flat Section

DASY5 Configuration:

- Probe: EX3DV4 - SN3739; ConvF(3.98, 3.98, 3.98);
- Sensor-Surface: 2mm (Mechanical Surface Detection)
- Electronics: DAE4 Sn1233; Calibrated: 10/13/2010
- Phantom: ELI 4.0; Type: QDOVA001BB; Serial: 1092
- Measurement SW: DASY52, V52.2 Build 0;

System Performance Check with D5GHzV2 Dipole (uniform grid)/d=10mm, Pin=100mW, f=5200

MHz 2/Area Scan (10x10x1): Measurement grid: dx=10mm, dy=10mm

Maximum value of SAR (measured) = 12.8 mW/g

System Performance Check with D5GHzV2 Dipole (uniform grid)/d=10mm, Pin=100mW, f=5200

MHz 2/Zoom Scan (4x4x2.5mm), dist=2mm (8x8x10)/Cube 0: Measurement grid: dx=4mm, dy=4mm, dz=2.5mm

Reference Value = 60.9 V/m; Power Drift = 0.153 dB

Peak SAR (extrapolated) = 31.4 W/kg

SAR(1 g) = 8.38 mW/g; SAR(10 g) = 2.39 mW/g

Maximum value of SAR (measured) = 16.4 mW/g

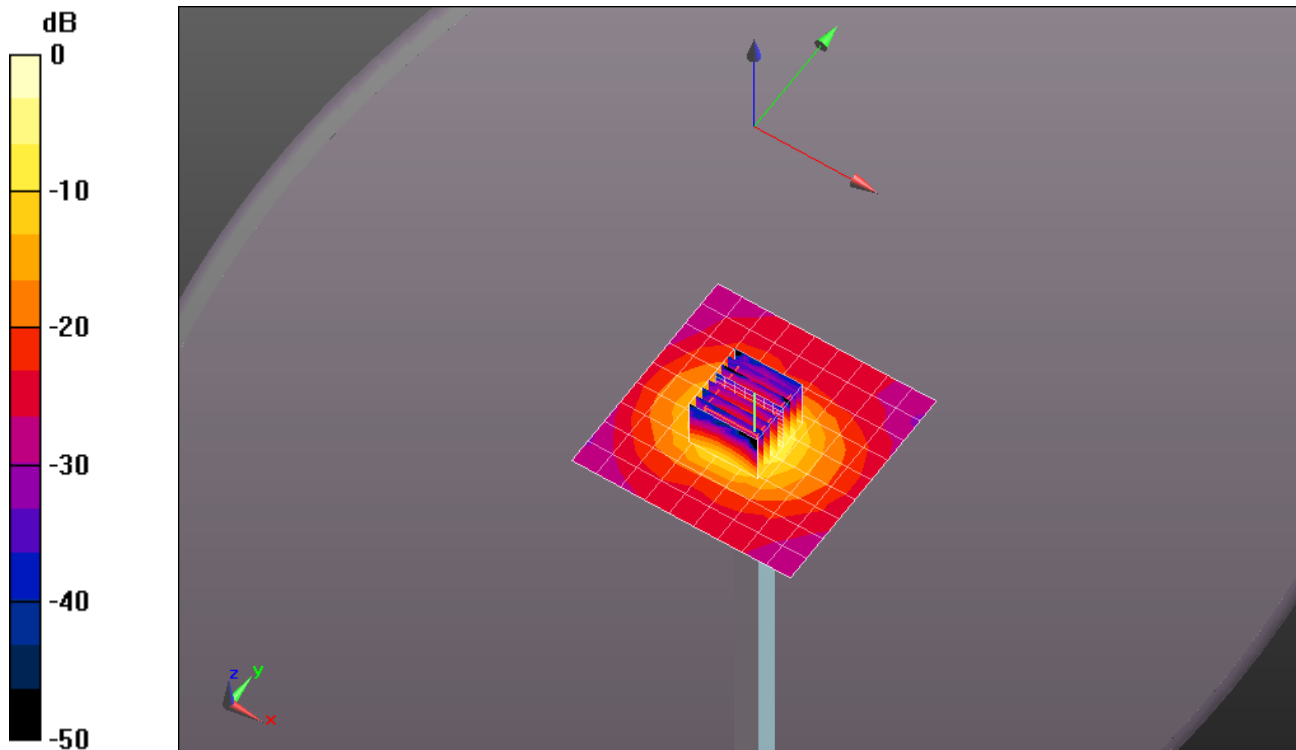

0 dB = 16.4mW/g

Plot 37: Dipole Verification, 5800MHz, 2011/04/15

Date/Time: 4/15/2011 10:38:25 AM, Date/Time: 4/15/2011 10:48:34 AM

DUT: Dipole D5GHzV2; Serial: D5GHzV2 - SN:1096

Communication System: CW-5GHz; Frequency: 5800 MHz

Medium parameters used: $f = 5800$ MHz; $\sigma = 5.18$ mho/m; $\epsilon_r = 36.8$; $\rho = 1000$ kg/m³

Phantom section: Flat Section

DASY5 Configuration:

- Probe: EX3DV4 - SN3739; ConvF(4.67, 4.67, 4.67);
- Sensor-Surface: 2mm (Mechanical Surface Detection)
- Electronics: DAE4 Sn1233; Calibrated: 10/13/2010
- Phantom: SAM; Type: QD 000 P40 CC; Serial: 1592
- Measurement SW: DASY52, V52.2 Build 0;

System Performance Check with D5GHzV2 Dipole (uniform

grid)/d=10mm, Pin=100mW, f=5800 MHz/Area Scan (10x10x1): Measurement

grid: dx=10mm, dy=10mm

Maximum value of SAR (measured) = 13.4 mW/g

System Performance Check with D5GHzV2 Dipole (uniform

grid)/d=10mm, Pin=100mW, f=5800 MHz/Zoom Scan (4x4x2.5mm),

dist=2mm (8x8x10)/Cube 0: Measurement grid: dx=4mm, dy=4mm, dz=2.5mm

Reference Value = 59.1 V/m; Power Drift = -0.023 dB

Peak SAR (extrapolated) = 36.6 W/kg

SAR(1 g) = 8.2 mW/g; SAR(10 g) = 2.36 mW/g

Maximum value of SAR (measured) = 15.9 mW/g

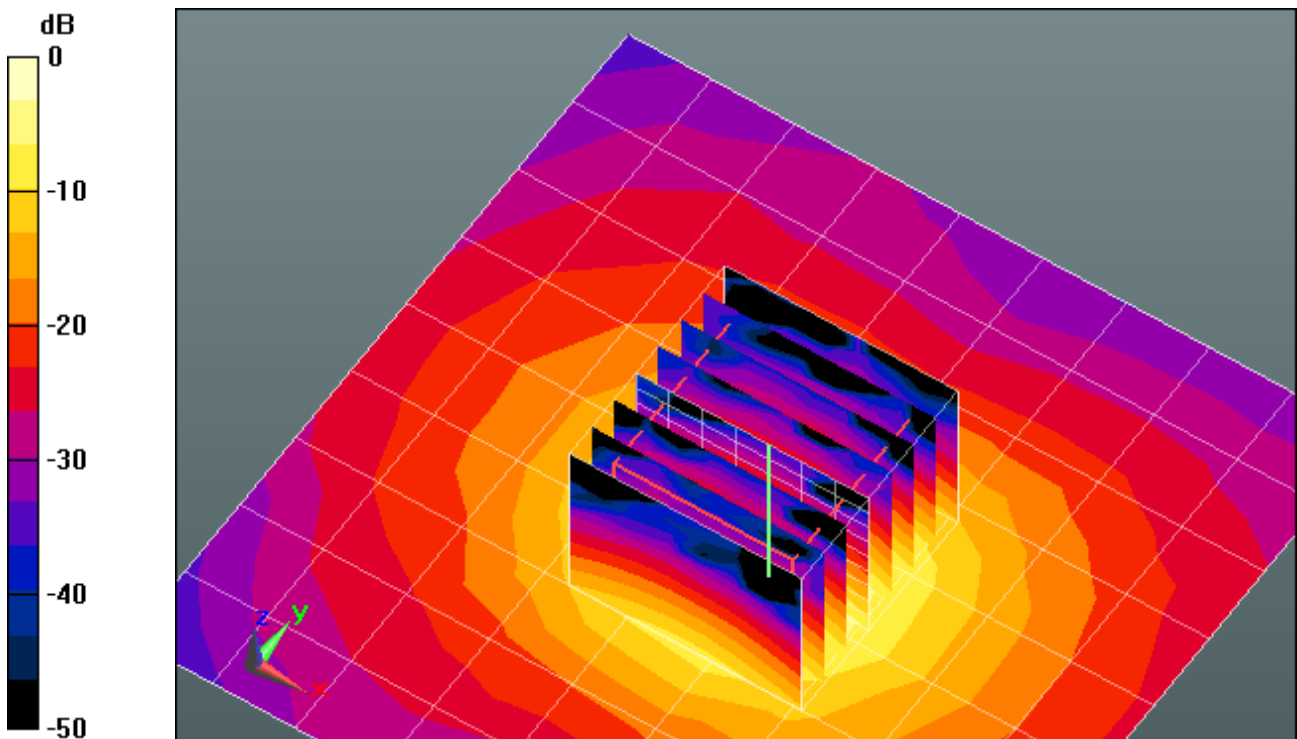

0 dB = 15.9mW/g

Plot 38: Dipole Verification, 5800MHz, 2011/04/20

Date/Time: 4/20/2011 8:39:02 AM, Date/Time: 4/20/2011 8:49:11 AM

DUT: Dipole D5GHzV2; Serial: D5GHzV2 - SN:1096

Communication System: CW-5GHz; Frequency: 5800 MHz

Medium parameters used: $f = 5800$ MHz; $\sigma = 5.36$ mho/m; $\epsilon_r = 36.7$; $\rho = 1000$ kg/m³

Phantom section: Flat Section

DASY5 Configuration:

- Probe: EX3DV4 - SN3739; ConvF(4.67, 4.67, 4.67);
- Sensor-Surface: 2mm (Mechanical Surface Detection)
- Electronics: DAE4 Sn1233; Calibrated: 10/13/2010
- Phantom: SAM; Type: QD 000 P40 CC; Serial: 1592
- Measurement SW: DASY52, V52.2 Build 0;

System Performance Check with D5GHzV2 Dipole (uniform grid)/d=10mm, Pin=100mW, f=5800 MHz/Area Scan (10x10x1): Measurement

grid: dx=10mm, dy=10mm

Maximum value of SAR (measured) = 11.6 mW/g

System Performance Check with D5GHzV2 Dipole (uniform grid)/d=10mm, Pin=100mW, f=5800 MHz/Zoom Scan (4x4x2.5mm), dist=2mm (8x8x10)/Cube 0: Measurement grid: dx=4mm, dy=4mm, dz=2.5mm

Reference Value = 63 V/m; Power Drift = -0.048 dB

Peak SAR (extrapolated) = 38.6 W/kg

SAR(1 g) = 8.89 mW/g; SAR(10 g) = 2.52 mW/g

Maximum value of SAR (measured) = 17.6 mW/g

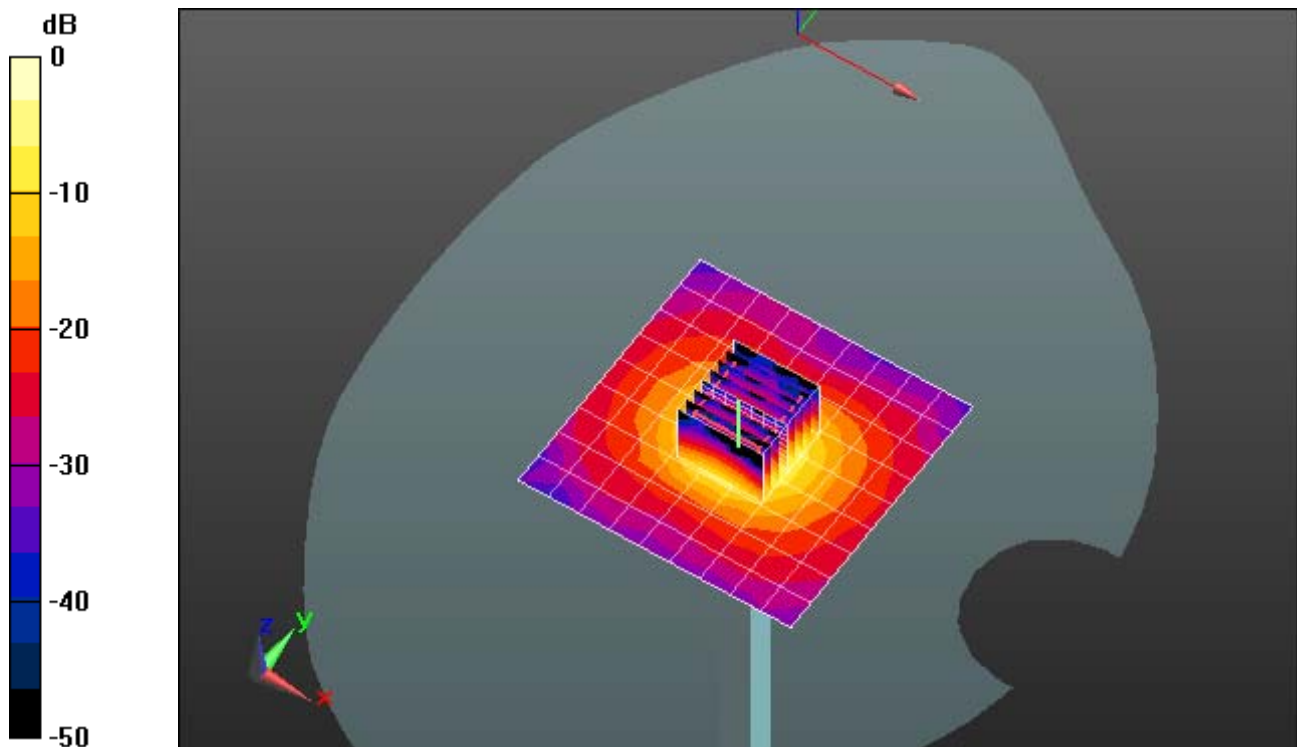

0 dB = 17.6mW/g

Plot 39: Dipole Verification, 5800MHz, 2011/05/17

Date/Time: 5/17/2011 10:02:23 AM, Date/Time: 5/17/2011 10:12:39 AM

DUT: Dipole D5GHzV2; Serial: D5GHzV2 - SN:1096

Communication System: CW-5GHz; Frequency: 5800 MHz

Medium parameters used: $f = 5800$ MHz; $\sigma = 6.2$ mho/m; $\epsilon_r = 48.5$; $\rho = 1000$ kg/m³

Phantom section: Flat Section

DASY5 Configuration:

- Probe: EX3DV4 - SN3739; ConvF(3.71, 3.71, 3.71);
- Sensor-Surface: 2mm (Mechanical Surface Detection)
- Electronics: DAE4 Sn1233; Calibrated: 10/13/2010
- Phantom: ELI 4.0; Type: QDOVA001BB; Serial: 1092
- Measurement SW: DASY52, V52.2 Build 0;

System Performance Check with D5GHzV2 Dipole (uniform grid)/d=10mm, Pin=100mW, f=5800

MHz/Area Scan (10x10x1): Measurement grid: dx=10mm, dy=10mm

Maximum value of SAR (measured) = 12 mW/g

System Performance Check with D5GHzV2 Dipole (uniform grid)/d=10mm, Pin=100mW, f=5800

MHz/Zoom Scan (4x4x2.5mm), dist=2mm (8x8x10)/Cube 0: Measurement grid: dx=4mm, dy=4mm, dz=2.5mm

Reference Value = 54.2 V/m; Power Drift = 0.106 dB

Peak SAR (extrapolated) = 29.3 W/kg

SAR(1 g) = 7.51 mW/g; SAR(10 g) = 2.12 mW/g

Maximum value of SAR (measured) = 14.9 mW/g

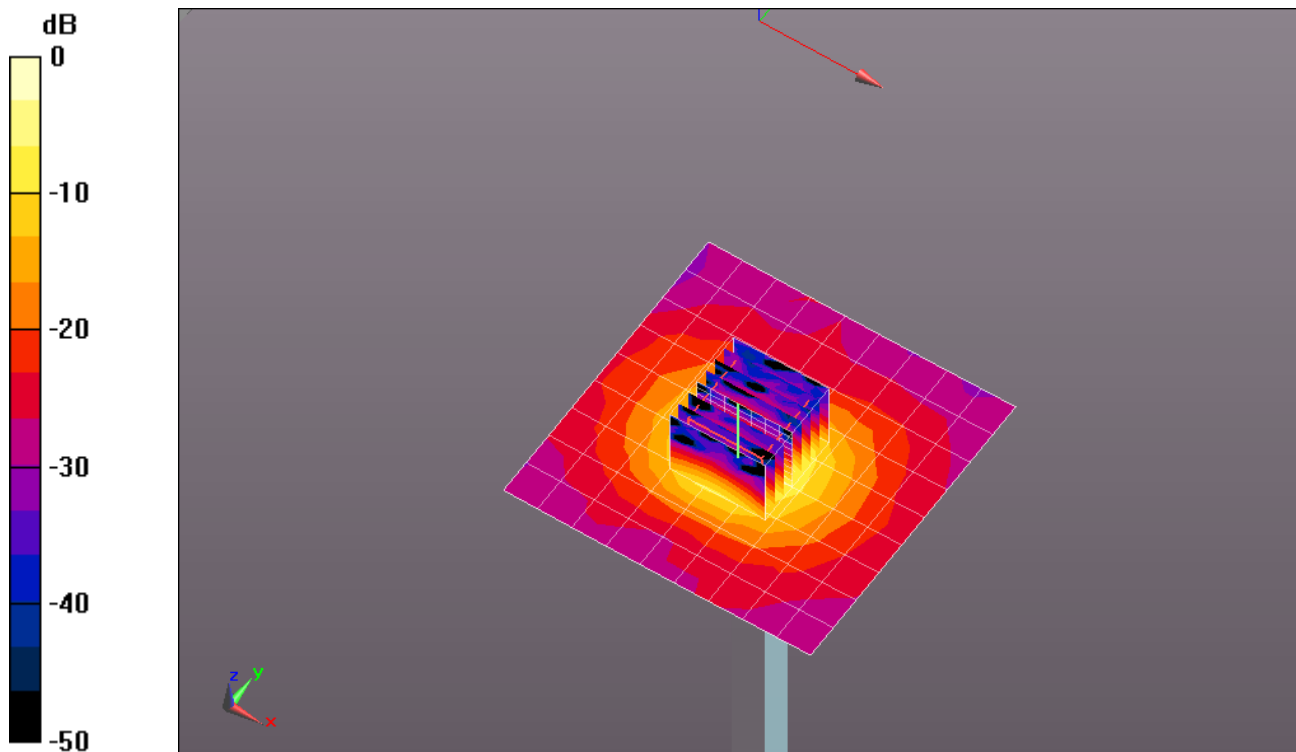

0 dB = 14.9mW/g