



FCC TEST REPORT

for

47 CFR Part 15 Subpart C and IC RSS-210

Equipment : 802.11b/g Wireless LAN CF card

Trade Name : WORKABOUT PRO

Model No. : RA2041

FCC ID : GM37527RA2041

IC ID : 2739D-BGRADA

Filing Type : Certification

Applicant : Psion Teklogix Inc.

2100 Meadowvale Boulevard, Mississauga, Ontario, L5N
7J9, Canada

- The test result refers exclusively to the test presented test model / sample.
- Without written approval of SPORTON International Inc., the test report shall not be reproduced except in full.
- **Certificate or Test Report must not be used by the applicant to claim the product in this test report endorsement by NVLAP or any agency of U.S. government.**
- The data shown in this test report were carried out on Jan. 06, 2007 at **Sporton International Inc. LAB.**
- Report No.: FR710210, Report Version: Rev. 02

Roy Wu
Deputy Manager

SPORTON International Inc.

6F, No.106, Sec. 1, Hsin Tai Wu Rd., Hsi Chih, Taipei Hsien, Taiwan, R.O.C.

SPORTON International Inc.

TEL : 886-2-2696-2468

FAX : 886-2-2696-2255

Report Version: Rev. 02



Table of Contents

History of this test report.....ii

1. General Description of Equipment under Test..... 1

 1.1 Applicant1

 1.2 Manufacturer1

 1.3 Basic Description of Equipment under Test.....1

 1.4 Details of the Accessory.....2

 1.5 Feature of Equipment under Test3

2 Test Configuration of Equipment under Test5

 2.1 Test Manner5

 2.2 Test Mode5

 2.3 Connection Diagram of Test System6

 2.4 Ancillary Equipment List.....6

3. RF Utility7

4. General Information of Test.....8

 4.1 Test Voltage8

 4.2 Standard for Methods of Measurement.....8

 4.3 Test in Compliance with8

 4.4 Frequency Range Investigated8

 4.5 Test Distance8

5. Test Data and Test Result.....9

 5.1 List of Measurements and Examinations9

 5.2 6dB Bandwidth Measurement10

 5.3 Power Spectral Density Measurement.....17

 5.4 Band Edges Measurement.....25

 5.5 Peak Output Power Measurement32

 5.6 Conducted Emission34

 5.7 Radiated Emission Measurement39

 5.8 Antenna Requirements95

6 List of Measuring Equipments Used96

7 Uncertainty Evaluation.....97

Appendix A. Photographs of EUT External

Appendix B. Photographs of EUT Internal

Appendix C. Photographs of Setup

Appendix D. Part 15C RSE Data for WLAN + Bluetooth Co-location



History of this test report

Report Issue Date: Feb. 28, 2007

Report No.	Description



1. General Description of Equipment under Test

1.1 Applicant

Psion Teklogix Inc.

2100 Meadowvale Boulevard, Mississauga, Ontario, L5N 7J9, Canada

1.2 Manufacturer

ASKEY COMPUTER CORP.

10F, No. 119, Chienkang Rd., Chung-Ho, Taipei, Taiwan, R.O.C.

1.3 Basic Description of Equipment under Test

Equipment : 802.11b/g Wireless LAN CF card
Trade Name : WORKABOUT PRO
Model No. : RA2041
FCC ID : GM37527RA2041
IC ID : 2739D-BGRADA
Power Supply Type : Switching, From Battery 3.7V
AC Power Cord : AC 120V, Wall-mount, 1.8 m, 2 pin

Remark:

1. The EUT is embedded in the specific Host 7527C / 7527S Series. It can be co-transmitted with Bluetooth on the Host.
2. The 7527S is the shorter version of model 7527C. They have the same modules and antenna. The only difference between the two models is the keypad.



1.4 Details of the Accessory

Terminal Options

Type		Model Number	Part Number	Remark
GSM	Quad-band MC75 GSM Radio with Stubby antenna	RA3030-G2	N/A	
Kit	Blackroc Endcap Kit 3-Port (RS232,TTL,IRDA); kit	BR1000-G1	1050812	
802.11g	802.11g CF Radio	RA2041	N/A	
Endcap with GSM	Imager, 2D HHP 5180 Endcap with GSM antenna	WA8110-G1	1050830	
	Imager, 1D EV15 Endcap, with GSM antenna	N/A	1050778	Endcap 1
	Scanner, 1D SE955 Endcap, with GSM antenna	N/A	1050491	Endcap 2
Endcap	Imager, 2D HHP 5180 Endcap	WA8010-G1	1050890	
	Imager, 1D Intermec EV15 Endcap	N/A	1050777	Endcap 3
	Scanner, 1D SE955 Endcap	N/A	1050492	Endcap 4
POD	Imager, 1D Intermec EV15 Pod	WA9003-G1	1050462	POD 1
	Scanner, 1D SE955 Pod	WA9002-G1	1050230	POD 2
	Scanner, 1D SE1223HP Pod	WA9000-G1	1050229	POD 3
	Imager, SX5393 Slim Pod	WA9007-G1	1050773	POD 5
	Scanner, 1D SE1223LR Pod	WA9005-G1	1051025	POD 4

Docks and Connectivity Options

Docking	Desktop Docking Station	WA4003-G2	1050955	Docking 1
	USB Cable	N/A	N/A	USB 1
	Vehicle Cradle - Powered 12V with Port Replicator	WA4005-G1 (port replicator)	1080224 (port replicator)	
	Cigarette light adaptor	WA3113-G2	1050463-001	
	Standalone Power Supply	PS1050-G1	1050465	
USB	USB to Ethernet adaptor module	WA4010-G1	1050236	USB 2
	USB to RS232 adaptor module	WA4015-G1	1050067-300	USB 3
Tether	Tether to Ethernet adaptor module	WA4025	1050255	USB 5
	Tether adaptor cable (for connecting keyboards)	WA1001	1050551	USB 4

Remark: USB Cable comes in the box as part of the Docking Station WA4003-G2.



1.5 Feature of Equipment under Test

WLAN Module

Product Feature & Specification	
1. DUT Type	802.11b/g Wireless LAN CF card
2. Trade Name	WORKABOUT PRO
3. Model Name	RA2041
4. FCC ID	GM37527RA2041
5. IC ID	2739D-BGRADA
6. Tx Frequency	2400 ~ 2483.5 MHz
7. Rx Frequency	2400 ~ 2483.5 MHz
8. Number of Channels	11
9. Carrier Frequency of Each Channel	$2412+(n-1)*5$ MHz; n=1~11
10. Antenna Connector	N/A
11. Antenna Type	PCB Antenna
12. Antenna Gain	-2.66 dBi (7527C) -2.48 dBi (7527S)
13. Maximum Output Power	802.11b : 20.65 dBm 802.11g : 22.98 dBm
14. Type of Modulation	DSSS / OFDM
15. DUT Stage	Identical Prototype
16. Application Type	Certification

**Co-transmission Bluetooth Module**

Product Feature & Specification	
1. Model Name	BTL040
2. FCC ID	GM37525BTB
3. IC ID	2739D-7525BTB
4. Tx Frequency	2400 ~ 2483.5 MHz
5. Rx Frequency	2400 ~ 2483.5 MHz
6. Number of Channels	79
7. Carrier Frequency of Each Channel	2402+ n*1 MHz, n= 0~78
8. Antenna Connector	N/A
9. Antenna Type	Chip Antenna
10. Antenna Gain	4.1 dBi
11. Maximum Output Power	0.59 dBm
12. Type of Modulation	GFSK
13. DUT Stage	Identical Prototype
14. Application Type	Certification

Host

Product Feature & Specification	
1. DUT Type	Hand-held Micro-computer
2. Trade Name	WORKABOUT PRO
3. Model Name	7527C / 7527S Series
4. FCC ID	GM37525BTB
5. IC ID	2739D-7525BTB
6. HW Version	7527C : ES3 7527S : ES2
7. SW Version	A
8. GSM Board	ES2



2 Test Configuration of Equipment under Test

2.1 Test Manner

- a. The EUT has been associated with peripherals pursuant to ANSI C63.4-2003 and configuration operated in a manner tended to maximize its emission characteristics in a typical application.
- b. For spurious emission below 1GHz, only one channel of each application was tested because it is not related to channel selection.
- c. The EUT is programmed to transmit signal continuously for all testings.
- d. Frequency range investigated: conduction 150 kHz to 30 MHz, radiation 30 MHz to 25000MHz.

2.2 Test Mode

Application		
Radiated Emission	802.11b	802.11b
	Mode 1: Tx_CH01_2412 MHz for 7527C	Mode 4: Tx_CH01_2412 MHz for 7527C
	Mode 2: Tx_CH06_2437 MHz for 7527C	Mode 5: Tx_CH06_2437 MHz for 7527C
	Mode 3: Tx_CH11_2462 MHz for 7527C	Mode 6: Tx_CH11_2462 MHz for 7527C
	Mode 7: Tx_CH01_2412 MHz for 7527S	Mode 8: Tx_CH01_2412 MHz for 7527S
Conducted Emission	Mode 1: WLAN Link Mode + BT Link + POD 4 + USB 1 + USB 2 + Docking 1 + Adapter for 7527C	
	Mode 2: WLAN Link Mode + BT Link + POD 4 + USB 1 + USB 2 + Docking 1 + Adapter for 7527S	

Remark: The radiated emission testing for WLAN and BT co-transmission on the Host 7527C can be referred in Appendix D.

2.3 Connection Diagram of Test System

<Radiated Emission>

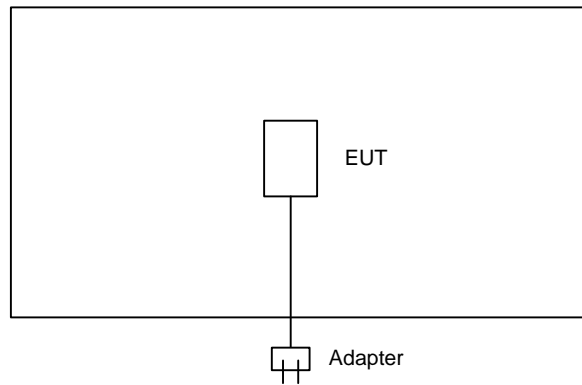

<Conducted Emission>

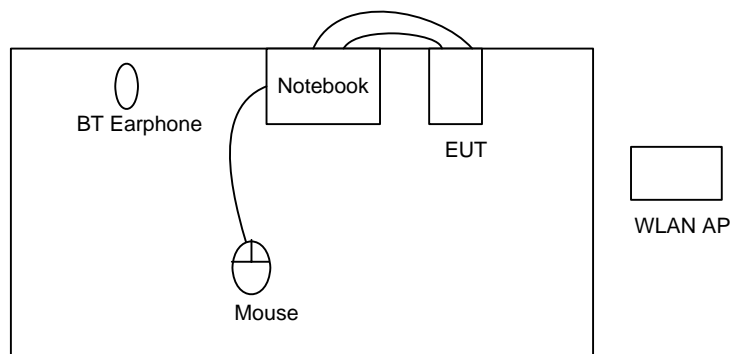

2.4 Ancillary Equipment List

Item	Asset	Model Name	Power Cord
1.	WLAN AP (SMC)	SMC-100	N/A
2.	Notebook (DELL)	D400	N/A
3.	Bluetooth Earphone(Engotech)	BH111	N/A
4.	(USB)Mouse (Microsoft)	B75-00093	Non-shielded, 1.8 m



3. RF Utility

The EUT is linked with WLAN AP for conducted emission or in WLAN continuous Tx mode controlled by RF utility for radiation emission and other conducted tests.



4. General Information of Test

Test Site Location : No. 52, Hwa Ya 1st Rd., Hwa Ya Technology Park,
Kwei-Shan Hsiang, Tao Yuan Hsien, Taiwan, R.O.C.
TEL : 886-3-327-3456
FAX : 886-3-318-0055

Test Site No : CO01-HY, 03CH06-HY, TH02-HY

4.1 Test Voltage

120V/ 60Hz

4.2 Standard for Methods of Measurement

ANSI C63.4-2003

4.3 Test in Compliance with

47 CFR Part 15 Subpart C and IC RSS-210 Issued 6

4.4 Frequency Range Investigated

- a. Conducted Emission : from 150 KHz to 30 MHz
- b. Radiated Emission : from 30 MHz to 25000 MHz

4.5 Test Distance

The test distance of radiated emission from antenna to EUT is 3 m.



5. Test Data and Test Result

5.1 List of Measurements and Examinations

The Emission Mode: Wireless LAN

FCC Rule	IC Rule	Description of Test	Result
15.207	RSS-Gen 7.2.2	Conducted Emission	Pass
15.247(a)(2)	A8.2 (1)	6dB Bandwidth	Pass
15.247(b)	A8.4 (4)	Maximum Peak Output Power	Pass
15.209(a)	2.6	Radiated Emission	Pass
15.247 (c)	A8.5	100kHz Bandwidth of Frequency Band Edges	Pass
15.247(d)	A8.2 (2)	Power Spectral Density	Pass
15.203 15.247(b)(4)	A8.4 (6)	Antenna Requirement	Pass

5.2 6dB Bandwidth Measurement

5.2.1 Measuring Instruments :

As described in chapter 6 of this test report.

5.2.2 Test Procedure :

1. The transmitter output was connected to the spectrum analyzer directly.
2. Set RBW of spectrum analyzer to 100kHz and VBW to 100kHz.
3. The 6 dB bandwidth is defined as the frequency range where the power is higher than the peak power minus 6dB.

5.2.3 Test Setup Layout :

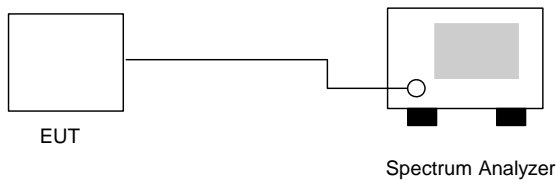

5.2.4 Test Result :

- Application Type : WLAN 802.11b/g
- Temperature : 24°C
- Relative Humidity : 48%
- Test Enginner : James

802.11b

Channel	Frequency (MHz)	6dB Emission bandwidth (MHz)	Limits (MHz)	Plot Ref. No.
01	2412	10.04	> 0.5MHz	Mode 1
06	2437	10.80	> 0.5MHz	Mode 2
11	2462	10.60	> 0.5MHz	Mode 3

802.11g

Channel	Frequency (MHz)	6dB Emission bandwidth (MHz)	Limits (MHz)	Plot Ref. No.
01	2412	16.36	> 0.5MHz	Mode 4
06	2437	16.36	> 0.5MHz	Mode 5
11	2462	16.36	> 0.5MHz	Mode 6



5.2.5 6dB Bandwidth

Mode 1

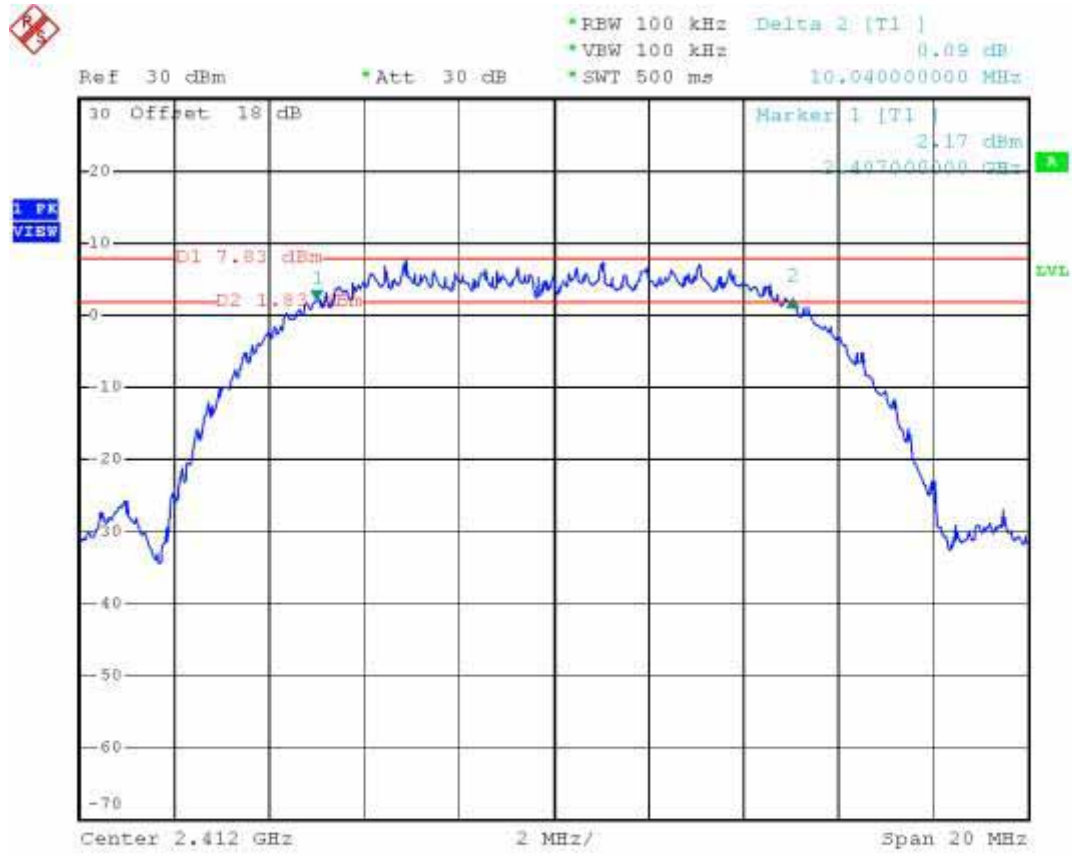

Date: 30.NOV.2006 19:30:57



Mode 2

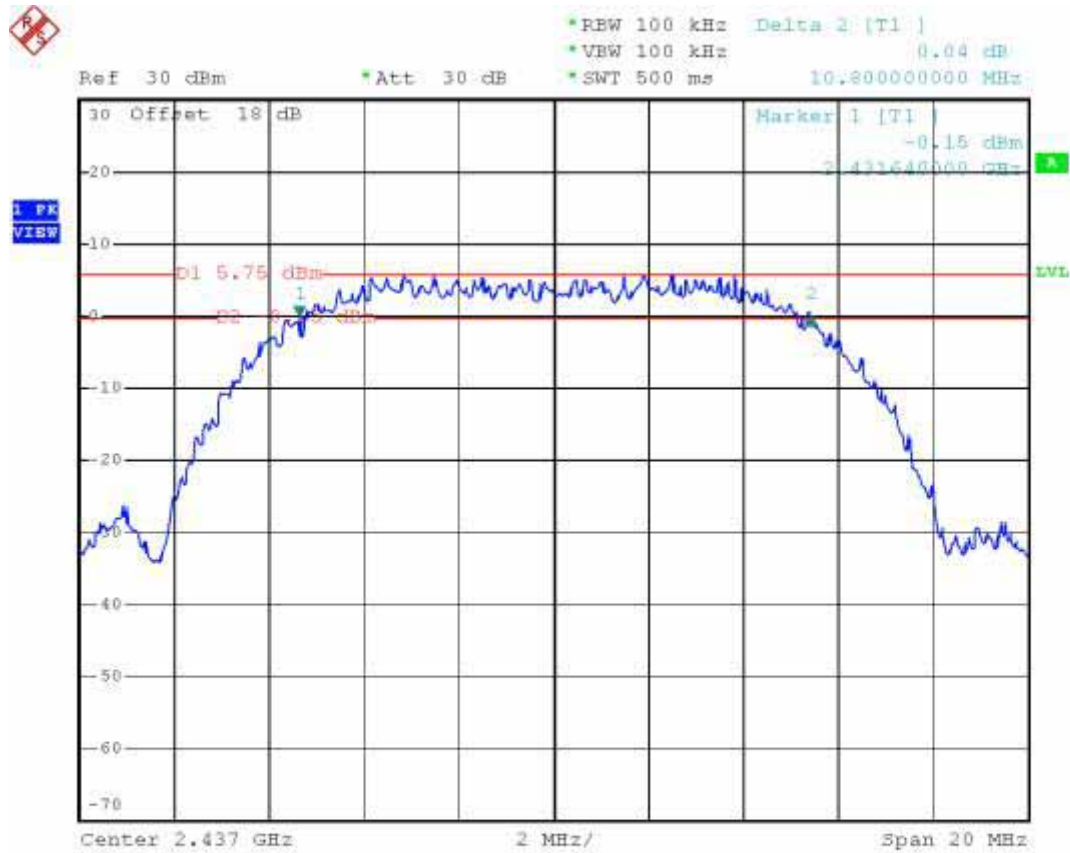

Date: 30.NOV.2006 19:34:38



Mode 3

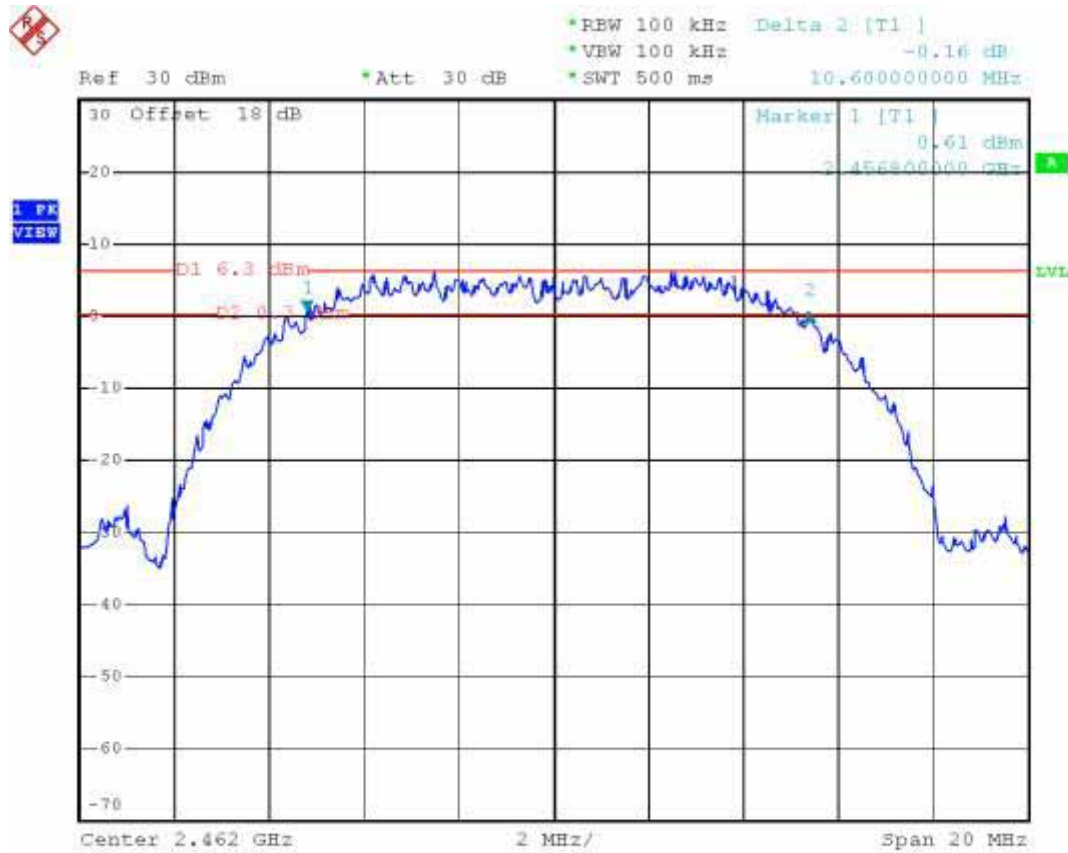

Date: 30.NOV.2006 19:35:36



Mode 4

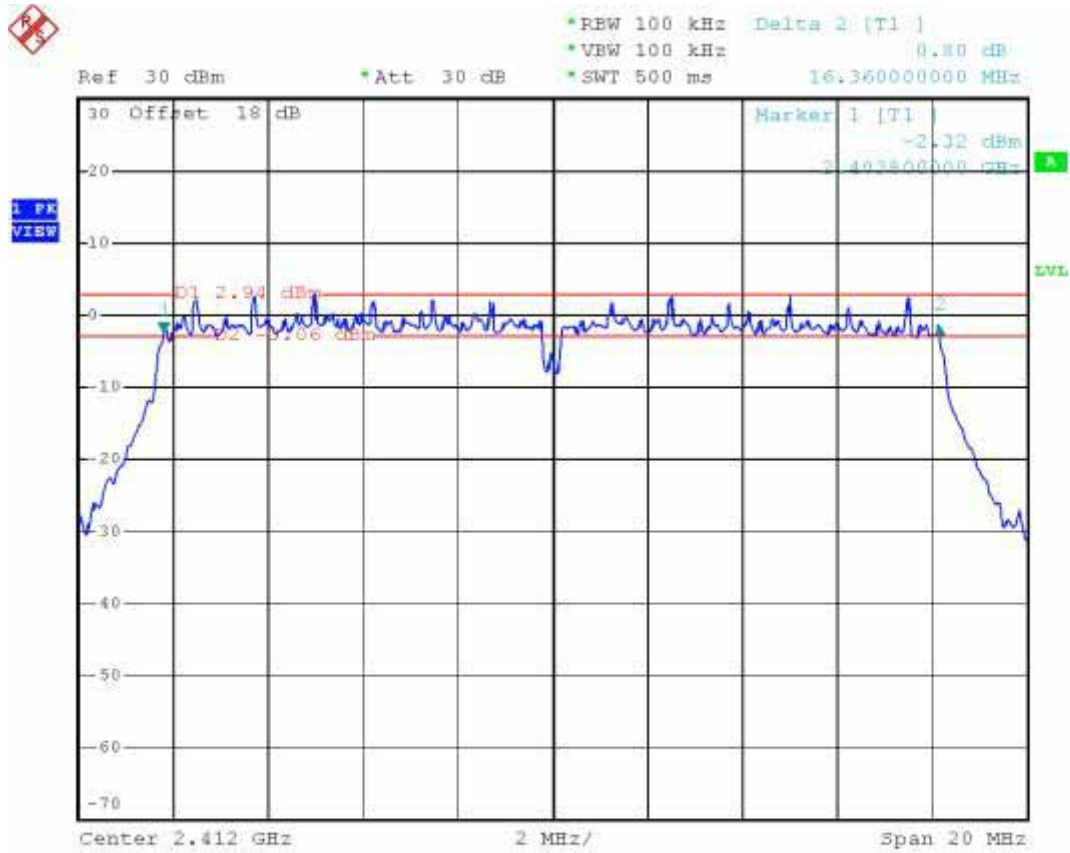

Date: 30.NOV.2006 19:54:00



Mode 5

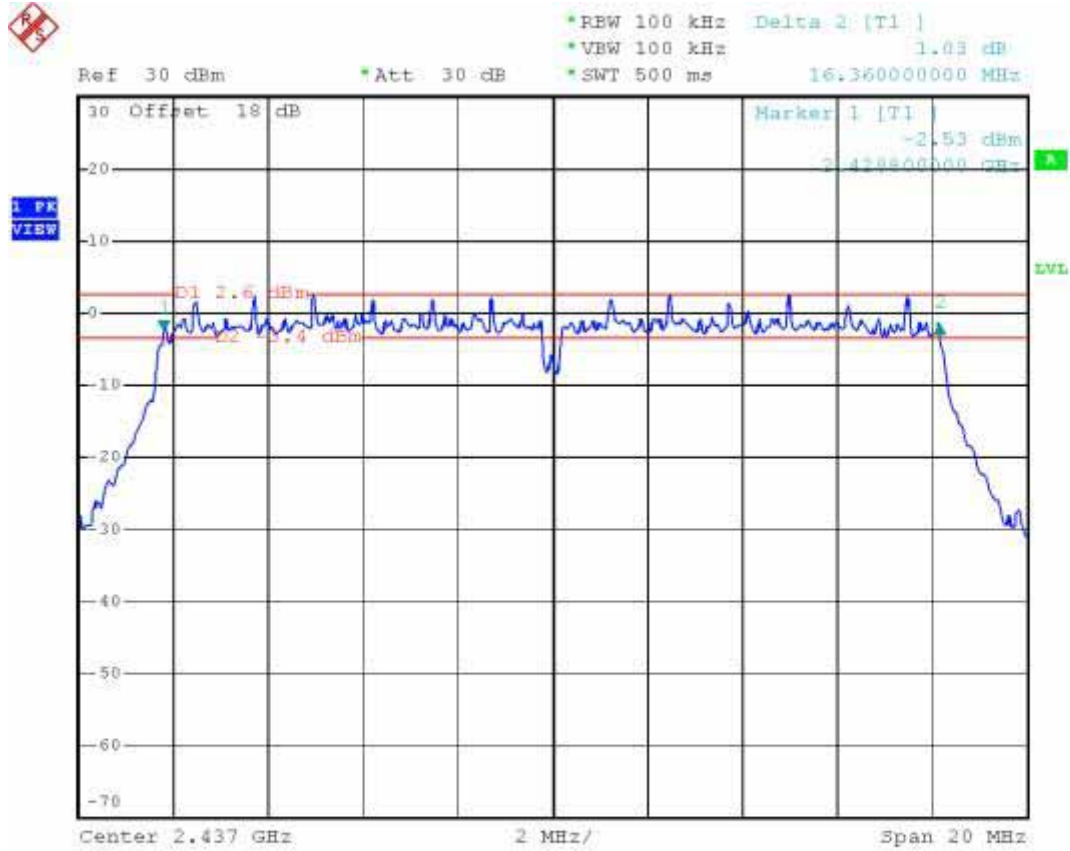

Date: 30.NOV.2006 19:53:06



Mode 6

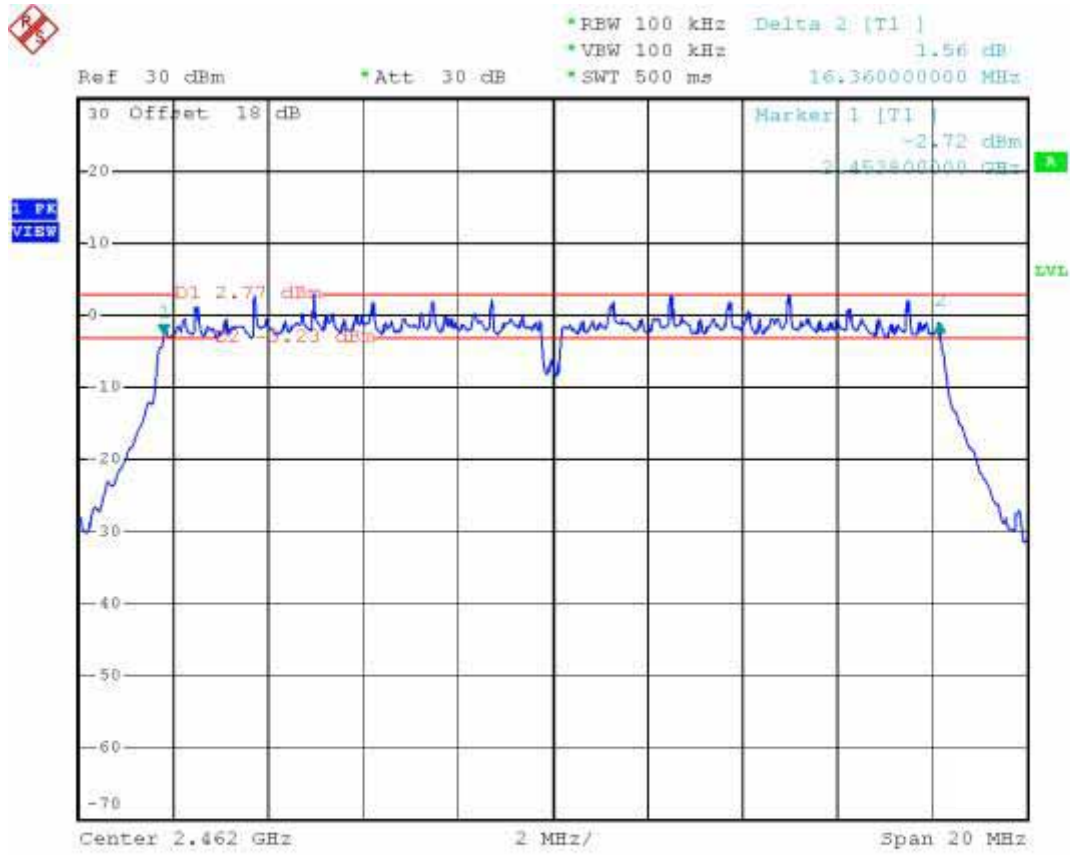

Date: 30.NOV.2006 19:52:05

5.3 Power Spectral Density Measurement

5.3.1 Measuring Instruments :

As described in chapter 6 of this test report.

5.3.2 Test Procedure :

1. The transmitter output was connected to spectrum analyzer directly.
2. The spectrum analyzer's resolution bandwidth was set at 3kHz RBW and 30kHz VBW as that of the fundamental frequency. Set the sweep time=span/3kHz.
3. The power spectral density was measured and recorded.
4. The sweep time is allowed to be longer than span/3kHz for a full response of the mixer in the spectrum analyzer.

5.3.3 Test Setup Layout :

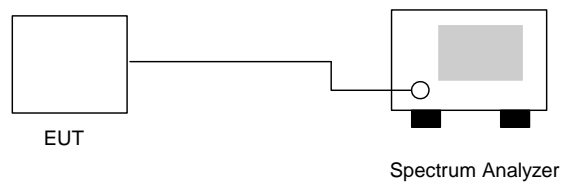



5.3.4 Test Result :

- Application Type : 802.11b/g
- Temperature : 24°C
- Relative Humidity : 48%
- Test Enginner : James

802.11b

Channel	Frequency (MHz)	Power Spectral Density (dBm)	Limits (dBm)	Plot Ref. No.
01	2412	-5.20	8	Mode 1
06	2437	-4.87	8	Mode 2
11	2462	-4.36	8	Mode 3

802.11g

Channel	Frequency (MHz)	Power Spectral Density (dBm)	Limits (dBm)	Plot Ref. No.
01	2412	-10.24	8	Mode 4
06	2437	-11.03	8	Mode 5
11	2462	-10.39	8	Mode 6



5.3.5 Power Spectral Density

Mode 1

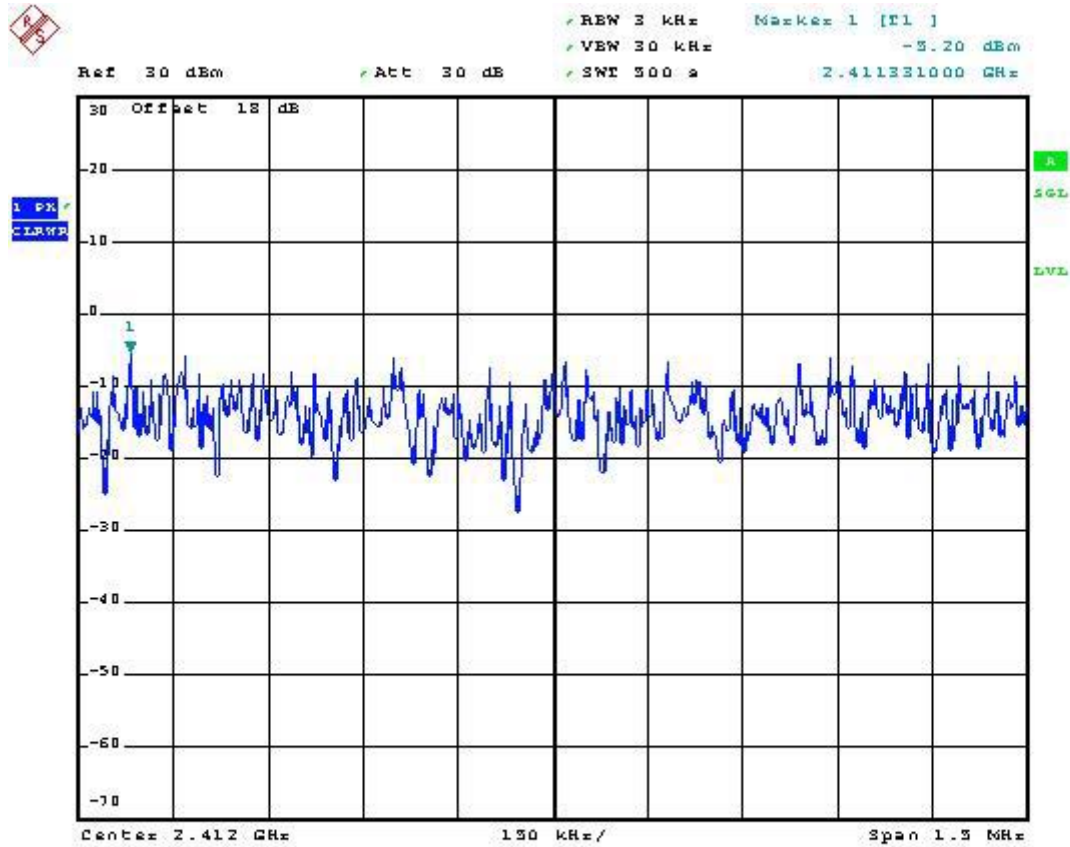

Date: 30.JAN.2007 18:54:52



Mode 2

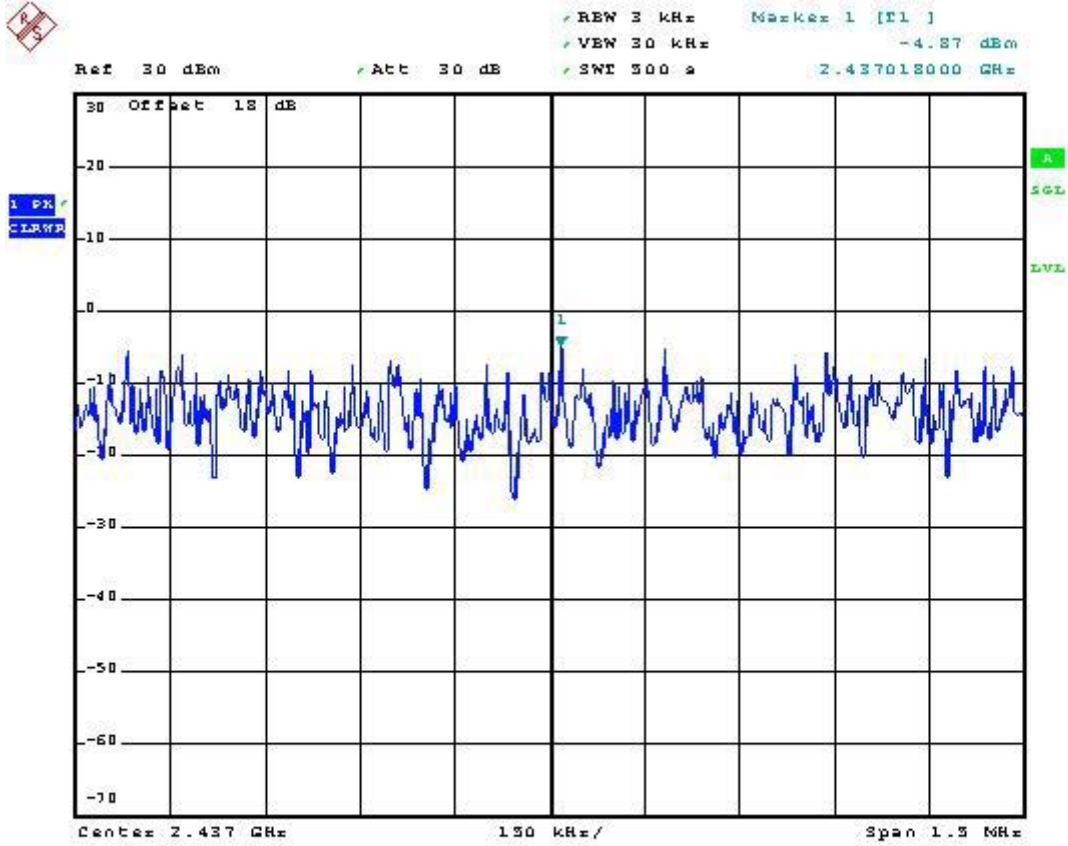

Date: 30.JAN.2007 18:55:33



Mode 3

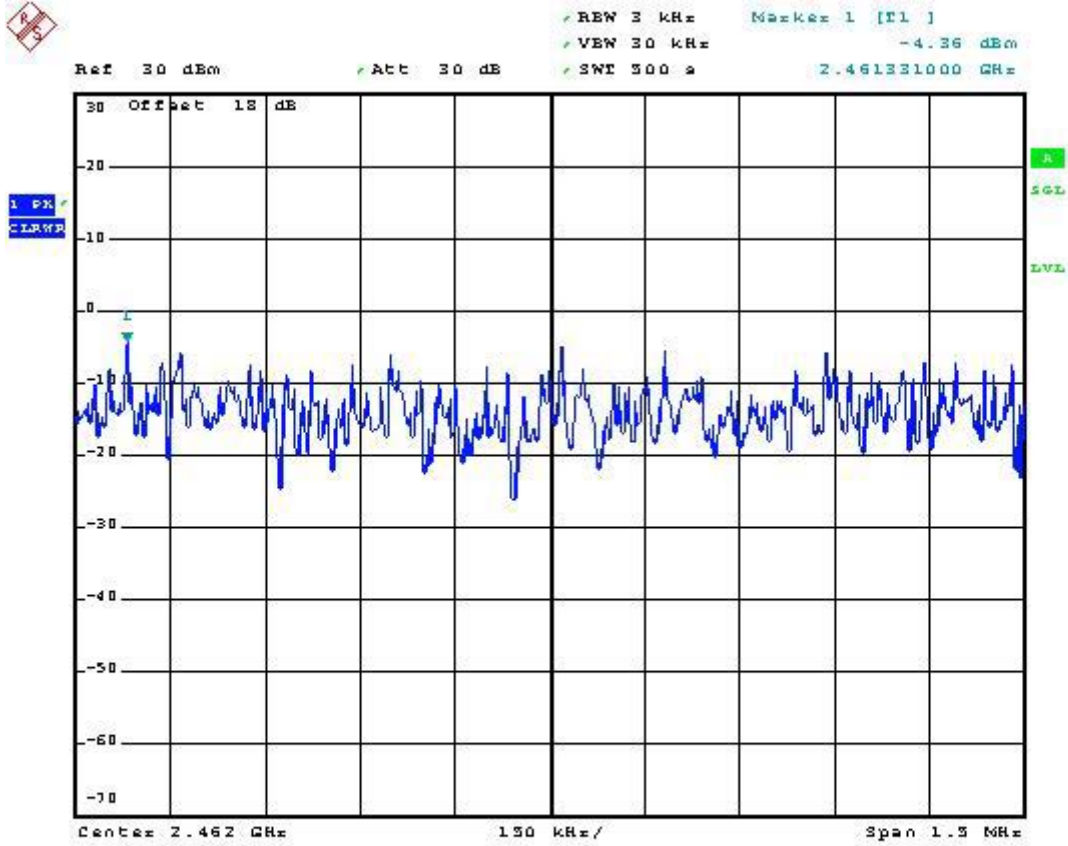

Date: 30.JAN.2007 18:56:11



Mode 4

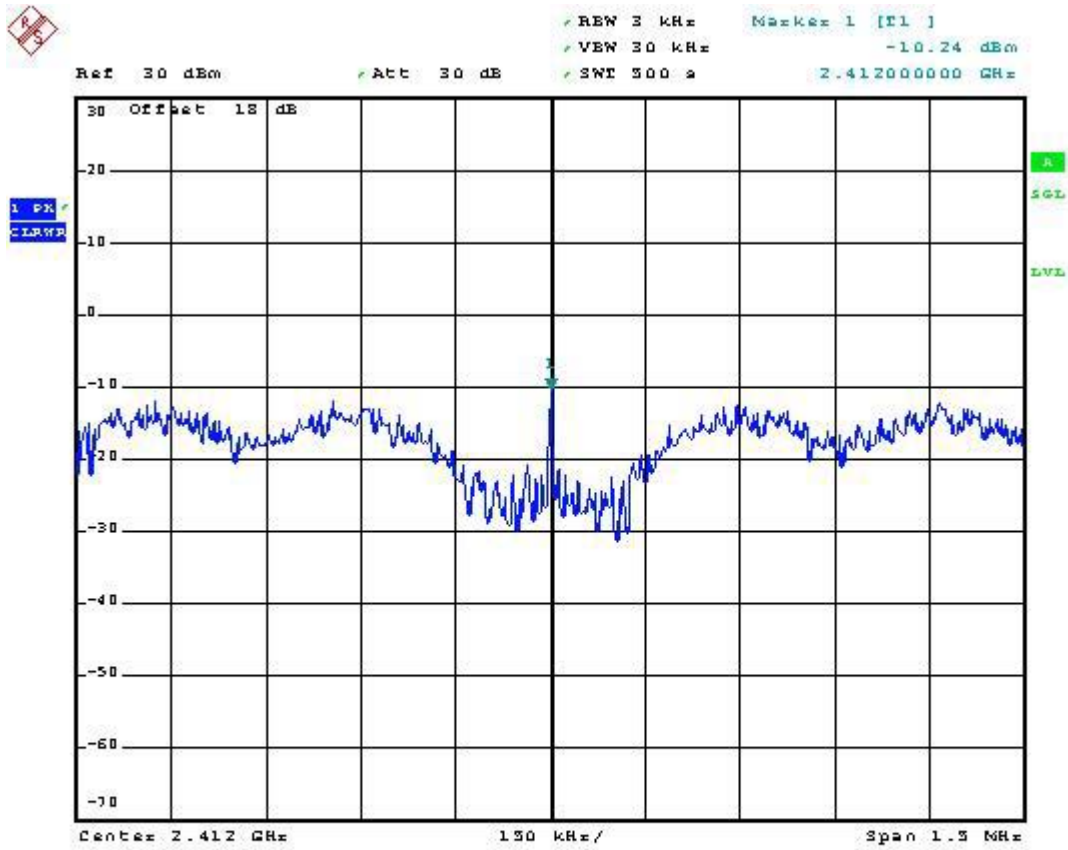

Date: 30.JAN.2007 18:57:17



Mode 5

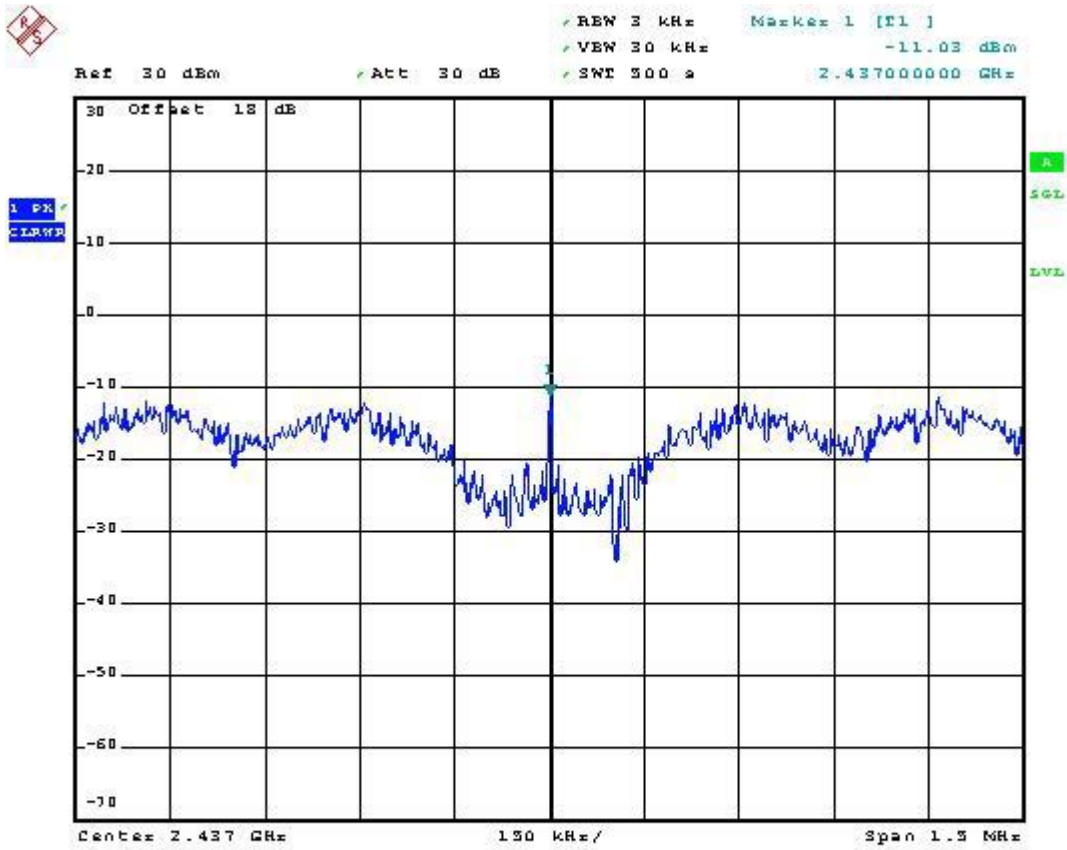

Date: 30.JAN.2007 18:57:46



Mode 6

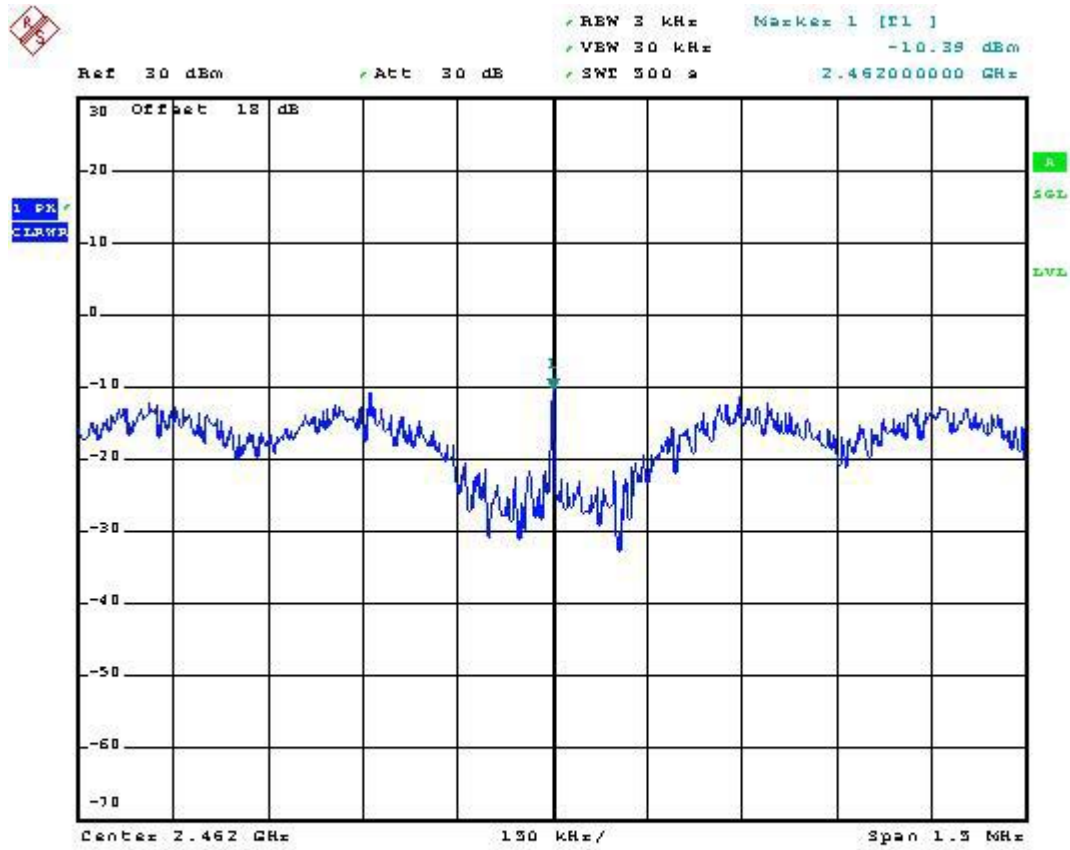

Date: 30.JAN.2007 18:58:18



5.4 Band Edges Measurement

5.4.1 Measuring Instruments :

As described in chapter 6 of this test report.

5.4.2 Test Procedure :

1. The transmitter output was connected to the spectrum analyzer via a low lose cable.
2. Set both RBW and VBW of spectrum analyzer to 100kHz with suitable frequency span including 100 kHz bandwidth from band edge.
3. The band edges was measured and recorded.

5.4.3 Test Result :

- Application Type : WLAN 802.11b/g
- Temperature : 24°C
- Relative Humidity : 48%
- Test Enginner : James

- Test Result in WLAN lower band (Channel 1) : PASS
- Test Result in WLAN higher band (Channel 11) : PASS

5.4.4 Note on Band Edge Emission :

➤WLAN 802.11b

CH01 (Horizontal)

Frequency (MHz)	Level (dBuV/m)	Over Limit (dB)	Limit Line (dBuV/m)	Read Level (dBuV)	Abtebba Factor (dB/m)	Cable Loss (dB)	Preamp Factor (dB)	Ant Pos (cm)	Table Pos (deg)	Remark
2390.0	60.32	-13.68	74.00	61.77	30.26	3.75	35.46	100	0	Peak
2390.0	48.10	-5.90	54.00	49.55	30.25	3.75	35.46	100	84	Average

CH01 (Vertical)

Frequency (MHz)	Level (dBuV/m)	Over Limit (dB)	Limit Line (dBuV/m)	Read Level (dBuV)	Abtebba Factor (dB/m)	Cable Loss (dB)	Preamp Factor (dB)	Ant Pos (cm)	Table Pos (deg)	Remark
2390.0	61.97	-12.03	74.00	63.42	30.26	3.75	35.46	100	0	Peak
2390.0	49.81	-4.19	54.00	51.26	30.26	3.75	35.46	100	179	Average



CH11 (Horizontal)

Frequency (MHz)	Level (dBuV/m)	Over Limit (dB)	Limit Line (dBuV/m)	Read Level (dBuV)	Abtebba Factor (dB/m)	Cable Loss (dB)	Preamp Factor (dB)	Ant Pos (cm)	Table Pos (deg)	Remark
2484.0	63.07	-10.93	74.00	64.43	30.29	3.86	35.51	100	0	Peak
2484.0	49.92	-4.08	54.00	51.28	30.29	3.86	35.51	126	83	Average

CH11 (Vertical)

Frequency (MHz)	Level (dBuV/m)	Over Limit (dB)	Limit Line (dBuV/m)	Read Level (dBuV)	Abtebba Factor (dB/m)	Cable Loss (dB)	Preamp Factor (dB)	Ant Pos (cm)	Table Pos (deg)	Remark
2484.0	62.72	-11.28	74.00	64.08	30.29	3.86	35.51	100	0	Peak
2484.0	49.36	-4.64	54.00	50.72	30.29	3.86	35.51	100	214	Average

➤WLAN 802.11g

CH01 (Horizontal)

Frequency (MHz)	Level (dBuV/m)	Over Limit (dB)	Limit Line (dBuV/m)	Read Level (dBuV)	Abtebba Factor (dB/m)	Cable Loss (dB)	Preamp Factor (dB)	Ant Pos (cm)	Table Pos (deg)	Remark
2390.0	65.88	-8.12	74.00	67.33	30.26	3.75	35.46	100	0	Peak
2390.0	46.86	-7.14	54.00	48.31	30.26	3.75	35.46	128	95	Average

CH01 (Vertical)

Frequency (MHz)	Level (dBuV/m)	Over Limit (dB)	Limit Line (dBuV/m)	Read Level (dBuV)	Abtebba Factor (dB/m)	Cable Loss (dB)	Preamp Factor (dB)	Ant Pos (cm)	Table Pos (deg)	Remark
2390.0	68.53	-5.47	74.00	69.98	30.26	3.75	35.46	100	0	Peak
2390.0	50.47	-3.53	54.00	51.92	30.26	3.75	35.46	121	265	Average

CH11 (Horizontal)

Frequency (MHz)	Level (dBuV/m)	Over Limit (dB)	Limit Line (dBuV/m)	Read Level (dBuV)	Abtebba Factor (dB/m)	Cable Loss (dB)	Preamp Factor (dB)	Ant Pos (cm)	Table Pos (deg)	Remark
2484.0	65.38	-8.62	74.00	66.74	30.29	3.86	35.51	100	0	Peak
2484.0	47.49	-6.51	54.00	48.85	30.29	3.86	35.51	129	83	Average



CH11 (Vertical)

Frequency (MHz)	Level (dBuV/m)	Over Limit (dB)	Limit Line (dBuV/m)	Read Level (dBuV)	Abtebba Factor (dB/m)	Cable Loss (dB)	Preamp Factor (dB)	Ant Pos (cm)	Table Pos (deg)	Remark
2484.0	69.03	-4.97	74.00	70.39	30.29	3.86	35.51	100	0	Peak
2484.0	51.74	-2.26	54.00	53.09	30.30	3.86	35.51	121	261	Average



5.4.4 20dB Band Edge

WLAN 802.11b

CH01

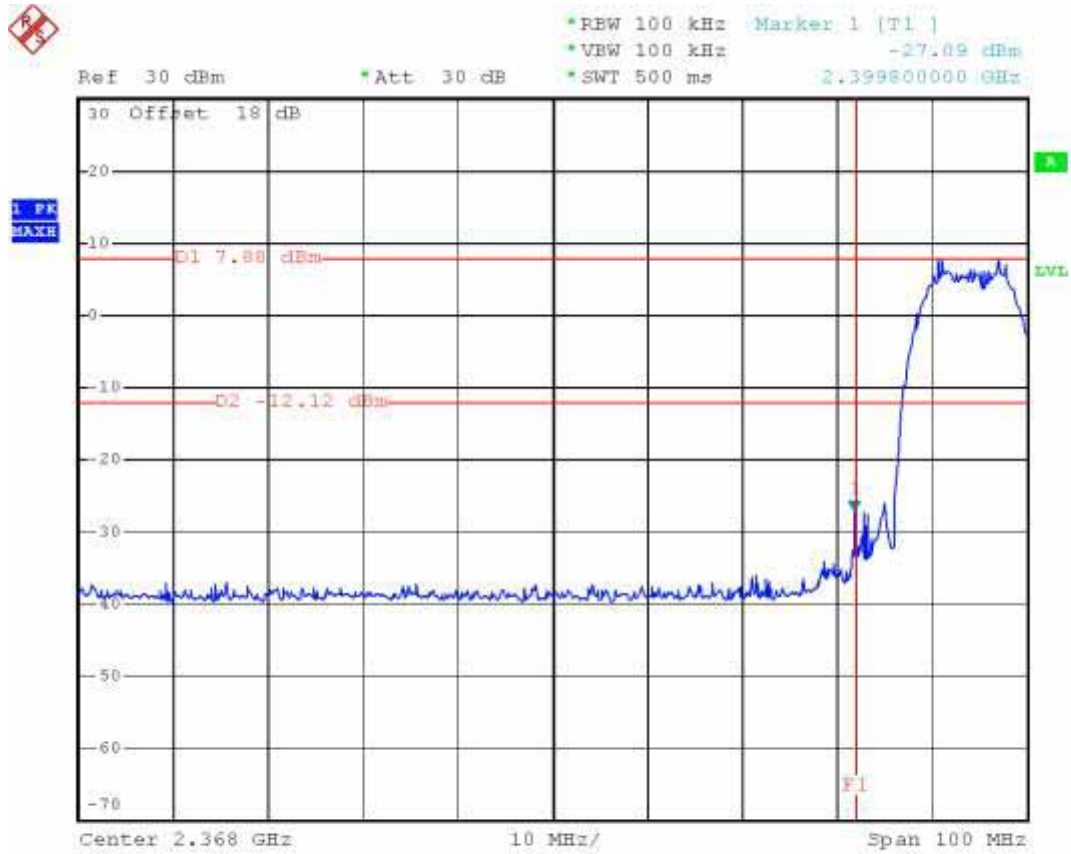

Date: 30.NOV.2006 19:46:01



CH11

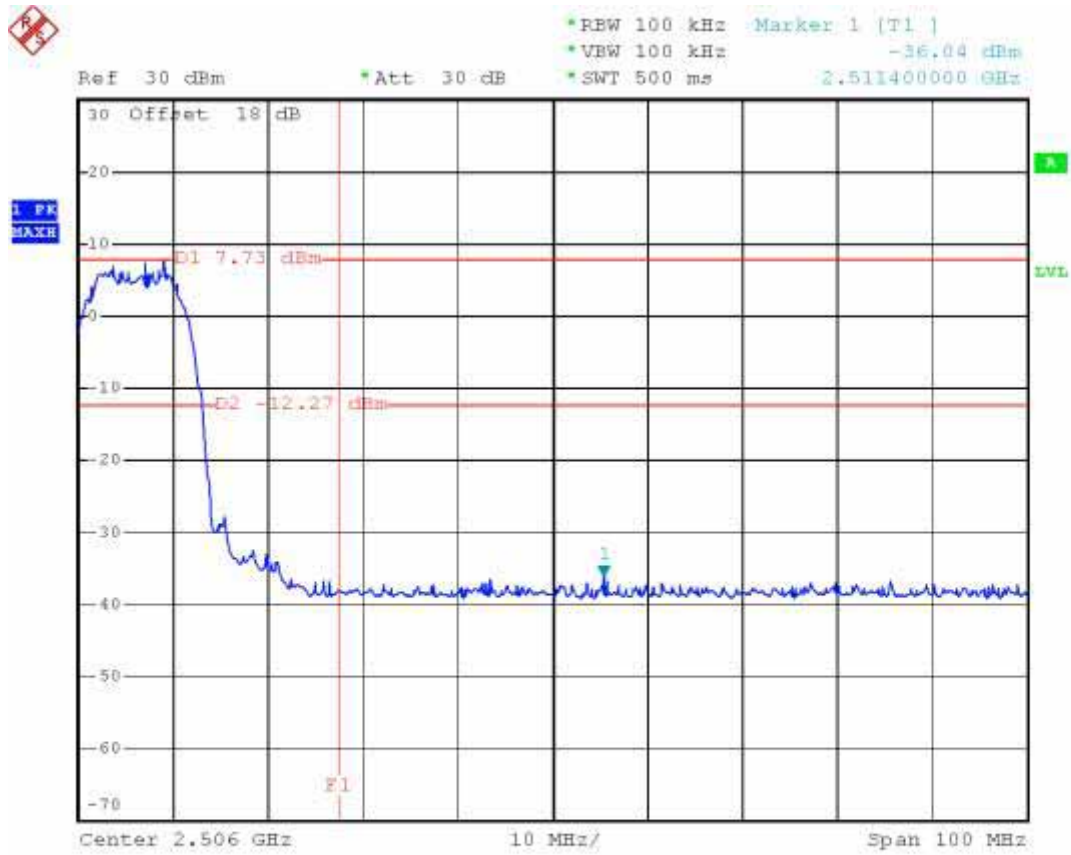

Date: 30.NOV.2006 19:37:18



WLAN 802.11g

CH01

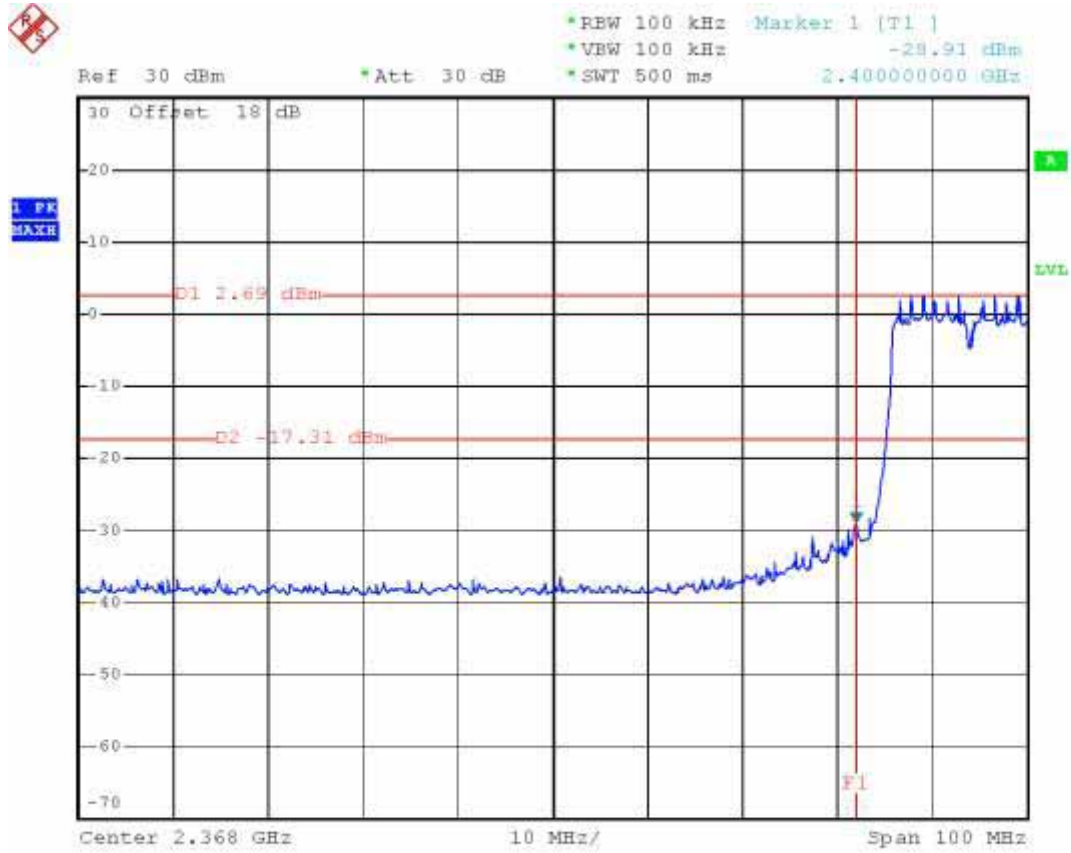

Date: 30.NOV.2006 19:42:09



CH11

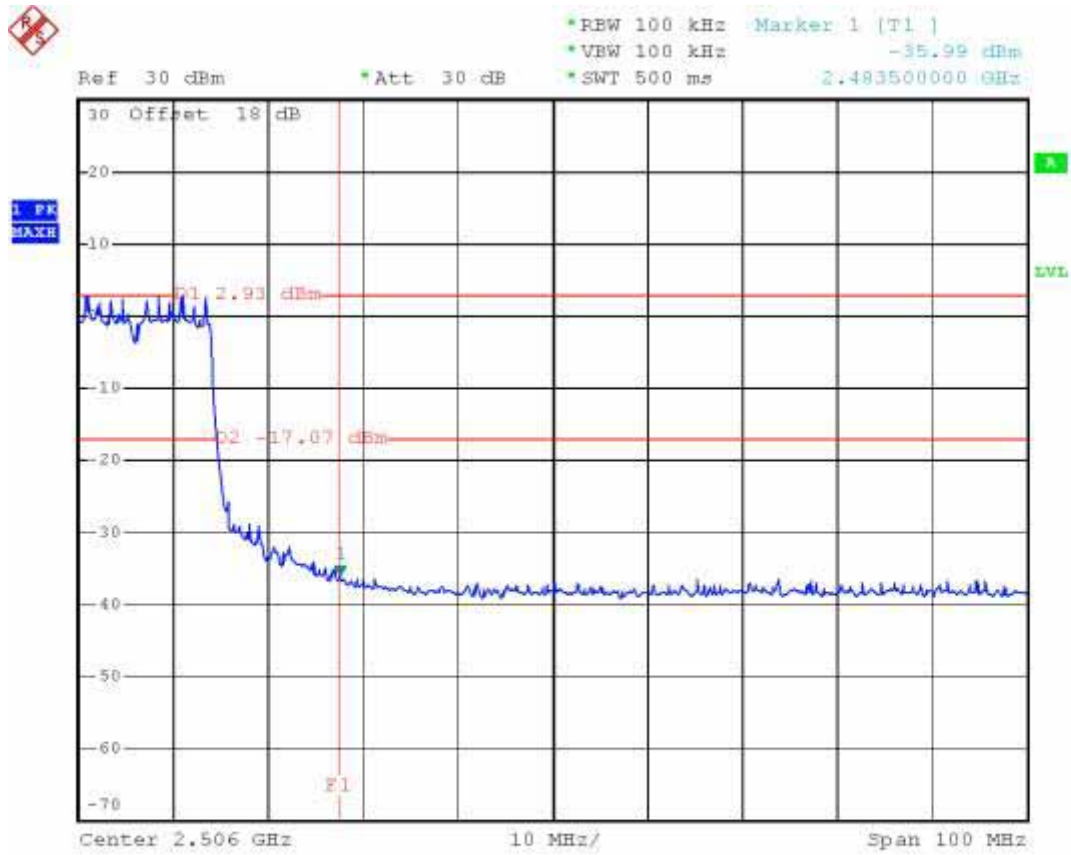

Date: 30.NOV.2006 19:50:36

5.5 Peak Output Power Measurement

5.5.1 Measuring Instruments :

As described in chapter 6 of this test report.

5.5.2 Test Procedure :

1. The antenna port (RF output) of the EUT was connected to the input (RF input) of a power meter for WLAN measurement. The power is equal to the reading level on power meter plus cable loss at the EUT antenna terminal.
2. The antenna port(RF output) of the EUT was connected to the input (RF input) of a spectrum analyzer for BT measurement. The cable loss has been offset before testing.

5.5.3 Test Setup Layout :

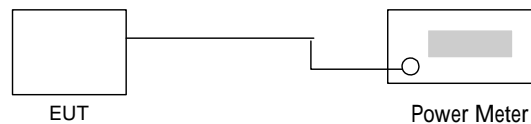

5.5.4 Test Result :

- Application Type : WLAN 802.11b/g
- Temperature : 24°C
- Relative Humidity : 48%
- Test Enginner : James

WLAN 802.11b

Channel	Frequency (MHz)	Measured Output Power (dBm)	Limits (Watt/dBm)
01	2412	20.65	1W/30 dBm
06	2437	20.32	1W/30 dBm
11	2462	20.40	1W/30 dBm



WLAN 802.11g

Channel	Frequency (MHz)	Measured Output Power (dBm)	Limits (Watt/dBm)
01	2412	22.98	1W/30 dBm
06	2437	22.07	1W/30 dBm
11	2462	22.11	1W/30 dBm



5.6 Conducted Emission

5.6.1 Measuring Instruments

As described in chapter 6 of this test Report.

5.6.2 Test Procedures :

- a. The EUT was placed 0.4 meter from the conducting wall of the shielding room was kept at least 80 centimeters from any other grounded conducting surface.
- b. Connect EUT to the power port of a line impedance stabilization network (LISN).
- c. All the support units are connected to the other LISN.
- d. The LISN provides 50 ohm coupling impedance for the measuring instrument.
- e. The FCC states that a 50 ohm, 50 microhenry LISN should be used.
- f. Both sides of AC line were checked for maximum conducted interference.
- g. The frequency range from 150 kHz to 30 MHz was searched.
- h. Set the test-receiver system to Peak Detect Function and specified bandwidth with Maximum Hold Mode.



5.6.3 Test Data

- Temperature : 24°C
- Relative Humidity : 48%
- Test Enginner : James
- Test Mode : Mode 1

The test that passed at minimum margin was marked by the frame in the following table.

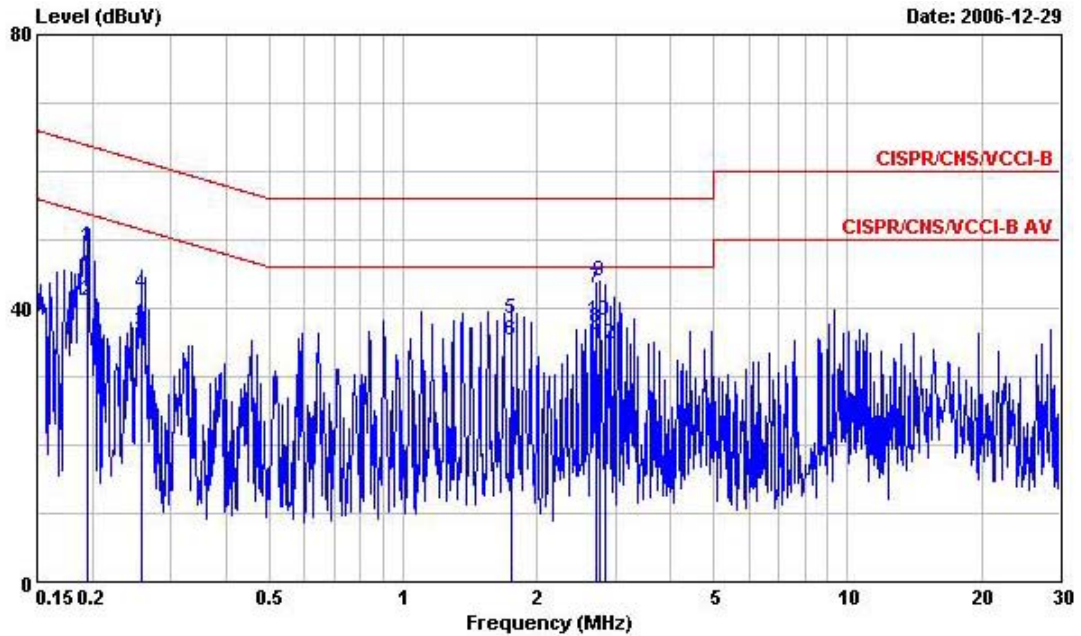

Site : CO04-HY
 Condition : CISPR/CNS/VCCI-B LISN 200604 99041 LINE
 EUT : PDA
 POWER: 120V/60Hz
 MODEL : 528
 MEMO : BT LINK+WLAN LINK
 MEMO : +ADAPTER+POD4+USB 1+USB 2+Docking 1
 MEMO :

	Freq	Level	Over Limit	Limit Line	Read Level	LISN Factor	Cable Loss	Remark
	MHz	dBuV	dB	dBuV	dBuV	dB	dB	
1	0.1944650	49.05	-14.79	63.84	48.73	0.10	0.22	QP
2	0.1944650	41.03	-12.81	53.84	40.71	0.10	0.22	Average
3	0.2575110	36.66	-14.85	51.51	36.38	0.10	0.18	Average
4	0.2575110	42.02	-19.49	61.51	41.74	0.10	0.18	QP
5	1.746	38.42	-17.58	56.00	38.12	0.10	0.20	QP
6	1.746	35.33	-10.67	46.00	35.03	0.10	0.20	Average
7	2.714	42.89	-13.11	56.00	42.52	0.10	0.27	QP
8	2.714	37.22	-8.78	46.00	36.85	0.10	0.27	Average
9	2.780	43.96	-12.04	56.00	43.58	0.10	0.28	QP
10	2.780	38.03	-7.97	46.00	37.65	0.10	0.28	Average
11	2.850	25.61	-20.39	46.00	25.22	0.10	0.29	Average
12	2.850	34.61	-21.39	56.00	34.22	0.10	0.29	QP

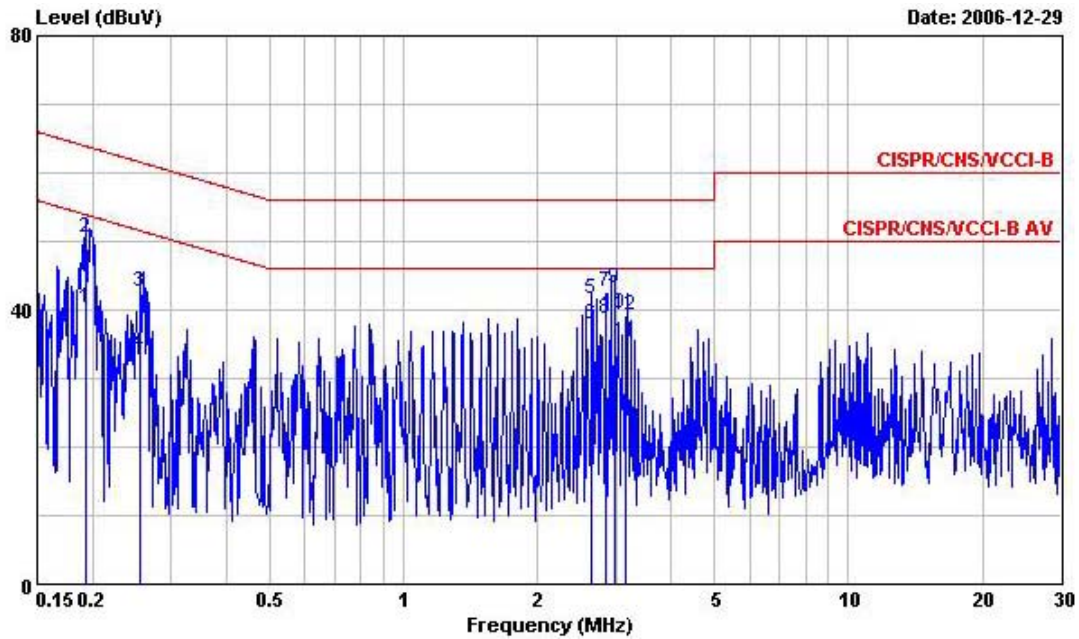

Site : CO04-HY
 Condition : CISPR/CNS/VCCI-B LISN 200604 99041 NEUTRAL
 EUT : PDA
 POWER: 120V/60Hz
 MODEL : 528
 MEMO : BT LINK+WLAN LINK
 MEMO : +ADAPTER+POD4+USB 1+USB 2+Docking 1
 MEMO :

	Freq	Level	Over	Limit	Read	LISN	Cable	Remark
	MHz	dBuV	Limit	Line	Level	Factor	Loss	
			dB	dBuV	dBuV	dB	dB	
1	0.1934380	40.29	-13.60	53.89	39.97	0.10	0.22	Average
2	0.1934380	50.45	-13.44	63.89	50.13	0.10	0.22	QP
3	0.2561610	42.73	-18.82	61.55	42.44	0.10	0.19	QP
4	0.2561610	33.76	-17.79	51.55	33.47	0.10	0.19	Average
5	2.650	41.46	-14.54	56.00	41.05	0.14	0.27	QP
6	2.650	37.97	-8.03	46.00	37.56	0.14	0.27	Average
7	2.845	42.60	-13.40	56.00	42.16	0.15	0.29	QP
8	2.845	38.68	-7.32	46.00	38.24	0.15	0.29	Average
9	2.974	43.27	-12.73	56.00	42.81	0.16	0.30	QP
10	2.974	39.41	-6.59	46.00	38.95	0.16	0.30	Average
11	3.170	35.16	-10.84	46.00	34.69	0.17	0.30	Average
12	3.170	39.20	-16.80	56.00	38.73	0.17	0.30	QP



- Temperature : 24°C
- Relative Humidity : 48%
- Test Enginner : James
- Test Mode : Mode 2

The test that passed at minimum margin was marked by the frame in the following table.

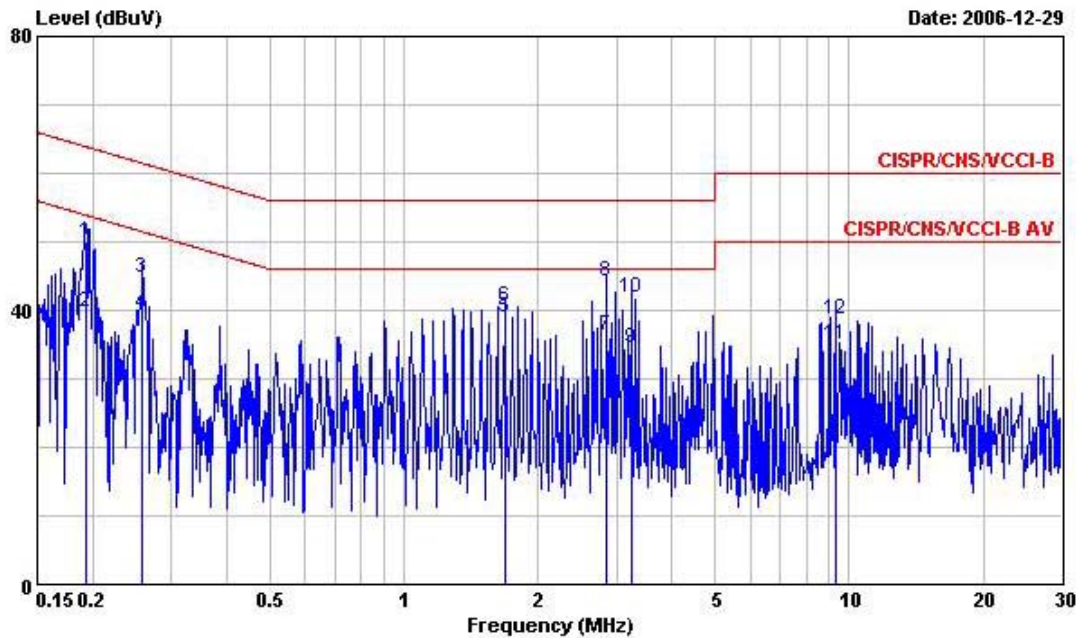

Site : CO04-HY
 Condition : CISPR/CNS/VCCI-B LISN 200604 99041 LINE
 EUT : PDA
 POWER: 120V/60Hz
 MODEL : 529
 MEMO : BT LINK+WLAN LINK
 MEMO : +ADAPTER+POD4+USB 1+USB 2+Docking 1
 MEMO :

	Freq	Level	Over	Limit	Read	LISN	Cable	Remark
	MHz	dBuV	Limit	Line	Level	Factor	Loss	
			dB	dBuV	dBuV	dB	dB	
1	0.1934380	50.09	-13.80	63.89	49.77	0.10	0.22	QP
2	0.1934380	39.77	-14.12	53.89	39.45	0.10	0.22	Average
3	0.2588790	44.62	-16.85	61.47	44.34	0.10	0.18	QP
4	0.2588790	39.40	-12.07	51.47	39.12	0.10	0.18	Average
5	1.680	39.04	-6.96	46.00	38.74	0.10	0.20	Average
6	1.680	40.59	-15.41	56.00	40.29	0.10	0.20	QP
7	2.844	36.29	-9.71	46.00	35.90	0.10	0.29	Average
8	2.844	44.10	-11.90	56.00	43.71	0.10	0.29	QP
9	3.232	34.52	-11.48	46.00	34.12	0.10	0.30	Average
10	3.232	41.83	-14.17	56.00	41.43	0.10	0.30	QP
11	9.369	34.94	-15.06	50.00	34.36	0.19	0.39	Average
12	9.369	38.72	-21.28	60.00	38.14	0.19	0.39	QP

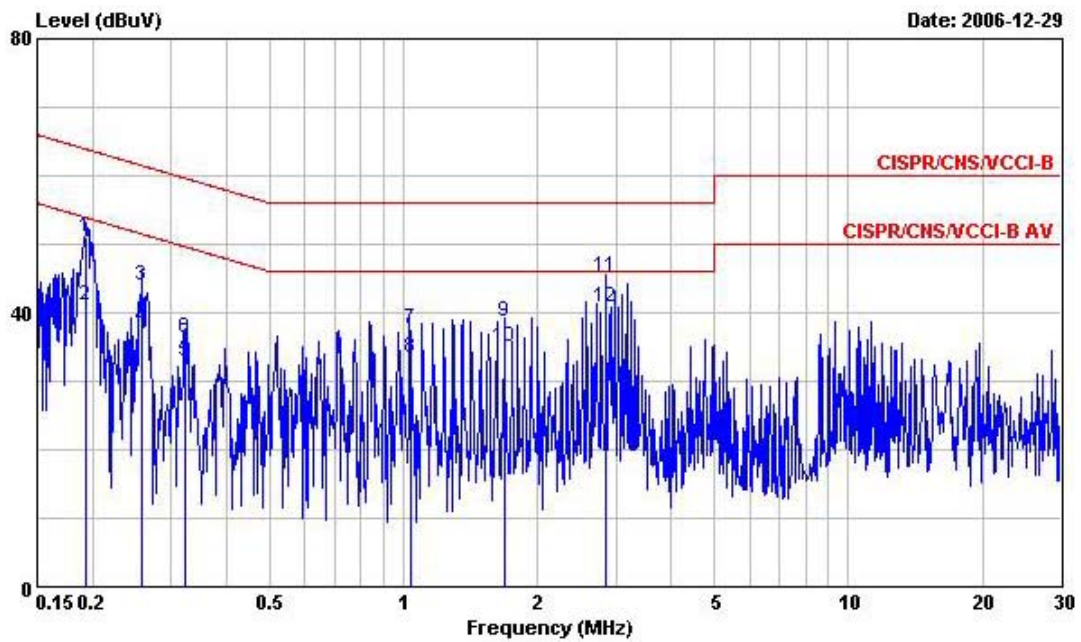

Site : CO04-HY
 Condition : CISPR/CNS/VCCI-B LISN 200604 99041 NEUTRAL
 EUT : PDA
 POWER: 120V/60Hz
 MODEL : 529
 MEMO : BT LINK+WLAN LINK
 MEMO : +ADAPTER+POD4+USB 1+USB 2+Docking 1
 MEMO :

	Freq	Level	Over Limit	Limit Line	Read Level	LISN Factor	Cable Loss	Remark
	MHz	dBuV	dB	dBuV	dBuV	dB	dB	
1	0.1934480	50.93	-12.96	63.89	50.61	0.10	0.22	QP
2	0.1934480	41.03	-12.86	53.89	40.71	0.10	0.22	Average
3	0.2588790	44.05	-17.42	61.47	43.77	0.10	0.18	QP
4	0.2588790	37.79	-13.68	51.47	37.51	0.10	0.18	Average
5	0.3236790	32.79	-16.82	49.61	32.59	0.10	0.10	Average
6	0.3236790	36.24	-23.37	59.61	36.04	0.10	0.10	QP
7	1.035	37.51	-18.49	56.00	37.21	0.10	0.20	QP
8	1.035	33.52	-12.48	46.00	33.22	0.10	0.20	Average
9	1.680	38.67	-17.33	56.00	38.37	0.10	0.20	QP
10	1.680	35.09	-10.91	46.00	34.79	0.10	0.20	Average
11	2.844	45.18	-10.82	56.00	44.74	0.15	0.29	QP
12	2.844	40.77	-5.23	46.00	40.33	0.15	0.29	Average



5.7 Radiated Emission Measurement

5.7.1 Measuring Instruments

As described in chapter 6 of this Report.

5.7.2 Test Procedures

- a. The EUT was placed on a rotatable table top 0.8 meter above ground.
- b. The EUT was set 3 meters from the interference receiving antenna which was mounted on the top of a variable height antenna tower.
- c. The table was rotated 360 degrees to determine the position of the highest radiation.
- d. The antenna is a broadband antenna and its height is varied between one meter and four meters above ground to find the maximum value of the field strength for both horizontal polarization and vertical polarization of the antenna.
- e. For each suspected emission, the EUT was arranged to its worst case and then tune the antenna tower (from 1 m to 4 m) and turntable (from 0 degree to 360 degrees) to find the maximum reading.
- f. Set the test-receiver system to Peak or CISPR quasi-peak Detect Function and specified bandwidth with Maximum Hold Mode.
- g. For testing below 1GHz, If the emission level of the EUT in peak mode was 3 dB lower than the limit specified, then testing will be stopped and peak values of EUT will be reported, otherwise, the emissions will be repeated one by one using the quasi-peak method and reported.
- h. For testing above 1GHz, the emission level of the EUT in peak mode was 20dB lower than average limit (that means the emission level in average mode also complies with the limit in average mode), then testing will be stopped and peak values of EUT will be reported, otherwise, the emissions will be measured in average mode again and reported.

5.7.3 Typical Test Setup Layout of Radiated Emission

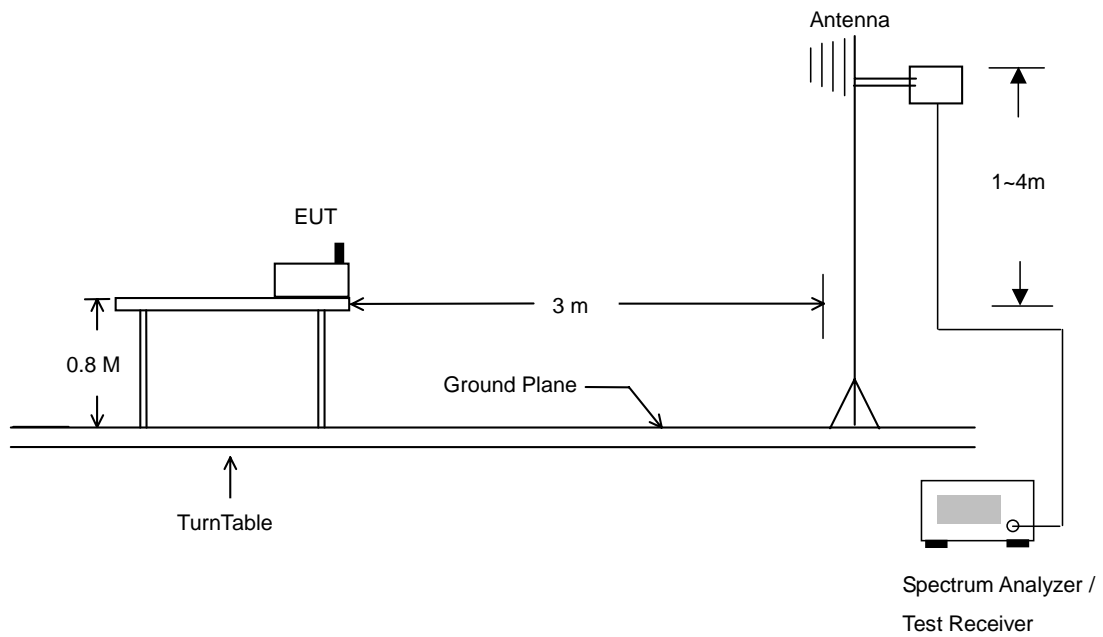



5.7.4 Test Data

- Temperature : 22.3°C
- Relative Humidity : 46%
- Test Engineer : Sam
- Test Mode : Mode 1
- Polarization : Horizontal

The test that passed at minimum margin was marked by the frame in the following table.

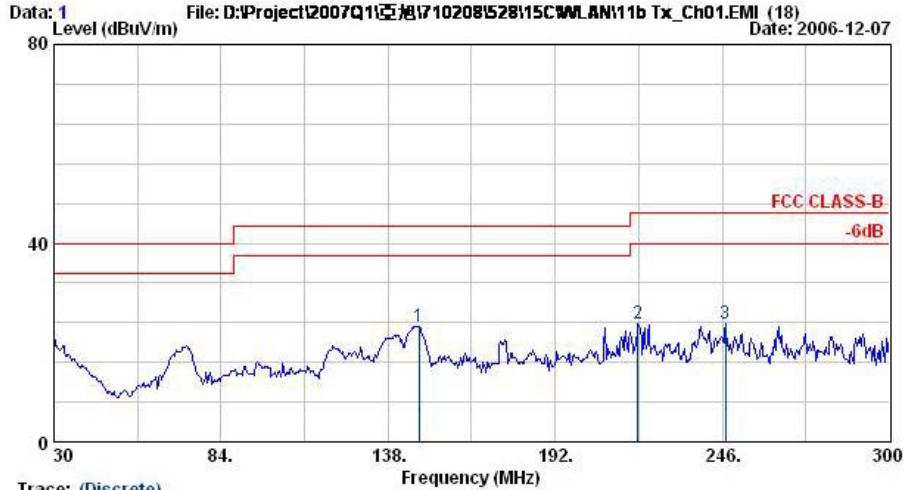

Trace: (Discrete)

Site : 08CH06-HY
 Condition : LF-ANT(951121) HORIZONTAL
 EUT : PDA with GPRS/EDGE+WLAN 11g+BT
 Power : 120Vac/60Hz
 Model : FR 710210
 Memo : 11b Tx_Ch01:2412MHz
 Plane : E2
 Data Rate : 11

	Freq	Level	Over	Limit	ReadAntenna	Cable	Preamp	Ant	Table	Remark
	MHz	dBuV/m	Limit	Line	Level	Loss	Factor	Pos	Pos	
			dB	dBuV/m	dBuV	dB	dB	cm	deg	
1	148.0	23.33	-20.17	43.50	42.21	10.37	1.81	31.06	---	Peak
2	218.7	23.92	-22.08	46.00	42.34	10.44	2.16	31.03	---	Peak
3	247.1	23.93	-22.07	46.00	40.36	12.10	2.40	30.92	---	Peak



FCC/IC TEST REPORT

Report No. : FR710210

Data: 2 File: D:\Project\2007Q1\52811528115C\WLAN11b Tx_Ch01.EMI (18) Date: 2006-12-07

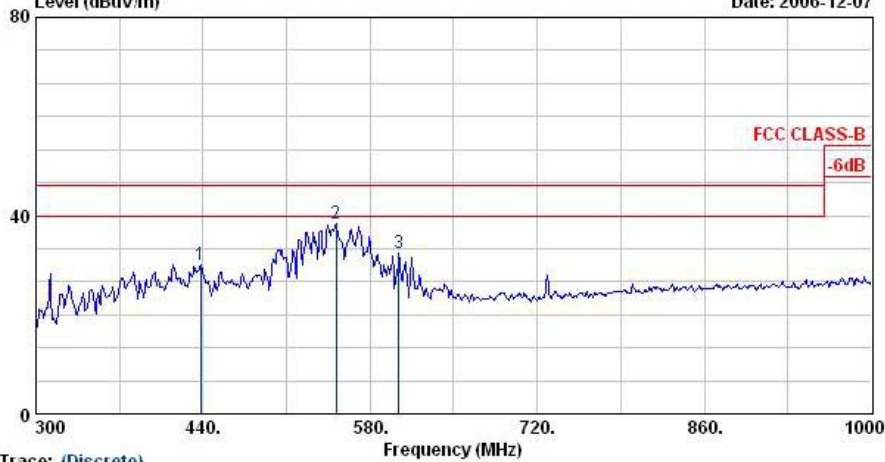

Trace: (Discrete)

Site : 03CH06-HY
 Condition : LF-ANT(051121) HORIZONTAL
 EUT : PDA with GPRS/EDGE+WLAN 11g+BT
 Power : 120Vac/60Hz
 Model : FR 710210
 Memo : 11b Tx_Ch01;2412MHz
 Plane : E2
 Data Rate : 11

	Freq	Level	Over Limit	Limit Line	Read Level	Antenna Factor	Cable Loss	Preamp Factor	Ant Pos	Table Pos	Remark
	MHz	dBuV/m	dB	dBuV/m	dBuV	dB/m	dB	dB	cm	deg	
1 @	437.90	30.15	-15.85	46.00	41.31	16.40	3.27	30.83	---	---	Peak
2 @	551.30	38.44	-7.56	46.00	47.48	17.96	3.73	30.73	100	325	Peak
3 @	603.80	32.43	-13.57	46.00	40.71	18.49	3.89	30.66	---	---	Peak

Data: 3 File: D:\Project\2007Q1\52811528115C\WLAN11b Tx_Ch01.EMI (18) Date: 2006-12-07

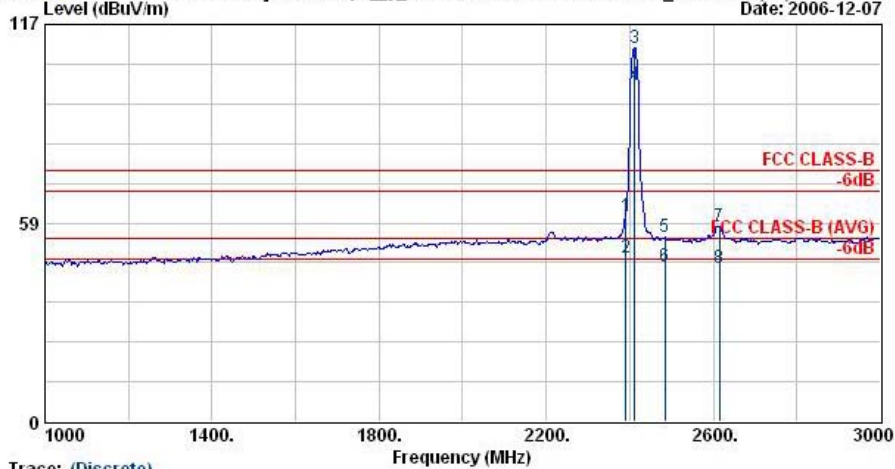

Trace: (Discrete)

Site : 03CH06-HY
 Condition : HF-ANT-060410 HORIZONTAL
 EUT : PDA with GPRS/EDGE+WLAN 11g+BT
 Power : 120Vac/60Hz
 Model : FR 710210
 Memo : 11b Tx_Ch01;2412MHz
 Plane : E2
 Data Rate : 11

	Freq	Level	Over Limit	Limit Line	Read Level	Antenna Factor	Cable Loss	Preamp Factor	Ant Pos	Table Pos	Remark
	MHz	dBuV/m	dB	dBuV/m	dBuV	dB/m	dB	dB	cm	deg	
1	2390.0	60.32	-13.68	74.00	61.77	30.26	3.75	35.46	100	0	Peak
2 !	2390.0	48.10	-5.90	54.00	49.55	30.26	3.75	35.46	100	84	Average
3 @	2412.0	110.19			111.61	30.27	3.77	35.46	100	0	Peak
4 @	2412.0	98.98			100.40	30.27	3.77	35.46	100	84	Average
5	2484.0	54.31	-19.69	74.00	55.67	30.29	3.86	35.51	100	0	Peak
6	2484.0	45.65	-8.35	54.00	47.01	30.29	3.86	35.51	100	84	Average
7	2614.0	57.47	-16.53	74.00	58.88	30.14	3.98	35.52	100	0	Peak
8	2614.0	45.05	-8.95	54.00	46.46	30.14	3.98	35.52	100	84	Average

Remark: #3 and #4 Fundamental Signal

SPORTON International Inc.

TEL : 886-2-2696-2468

FAX : 886-2-2696-2255

FCC ID : GM37527RA2041

IC ID : 2739D-BGRADA

Page No. : 42 of 98

Report Issued Date : Feb. 28, 2007

Report Version : Rev. 02



Data: 4 File: D:\Project\2007Q1\旭710208\52815C\WLAN\11b Tx_Ch01.EMI (18) Date: 2006-12-07

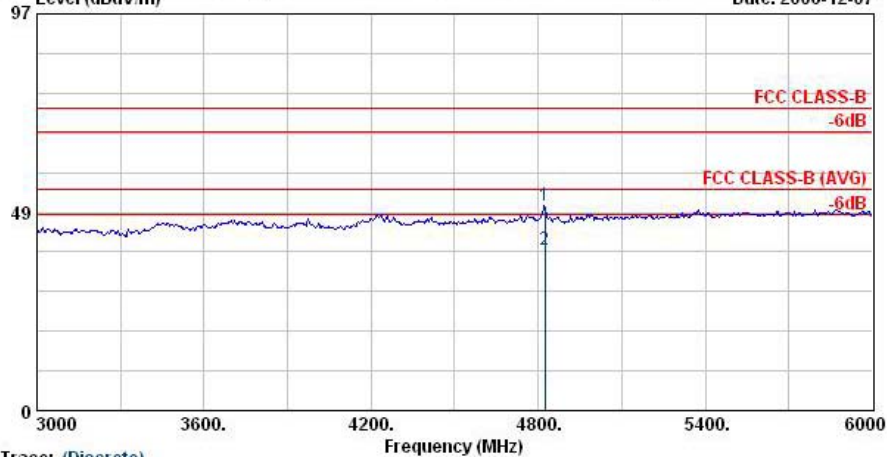

Trace: (Discrete)

Site : 08CH06-HY
 Condition : HF-ANT-060410 HORIZONTAL
 EUT : PDA with GPRS/EDGE+WLAN 11g+BT
 Power : 120Vac/60Hz
 Model : FR 710210
 Memo : 11b Tx_Ch01,2412MHz
 Plane : E2
 Data Rate : 11

	Freq	Level	Over	Limit	Read	Antenna	Cable	Preamp	Ant	Table	Remark
	MHz	dBuV/m	dB	dBuV/m	dBuV	dB/m	dB	dB	cm	deg	
1	4824.0	50.22	-23.78	74.00	47.55	32.94	5.84	36.12	100	0	Peak
2	4824.0	39.23	-14.77	54.00	36.56	32.94	5.84	36.12	100	183	Average

Data: 5 File: D:\Project\2007Q1\旭710208\52815C\WLAN\11b Tx_Ch01.EMI (18) Date: 2006-12-07

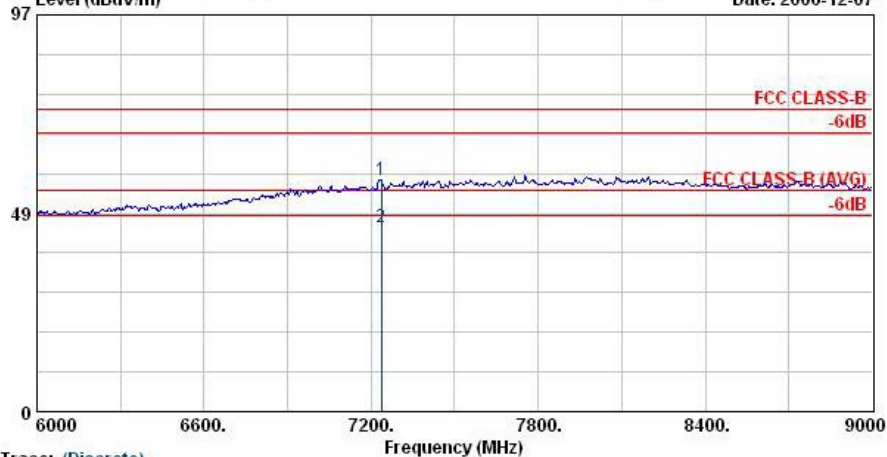

Trace: (Discrete)

Site : 08CH06-HY
 Condition : HF-ANT-060410 HORIZONTAL
 EUT : PDA with GPRS/EDGE+WLAN 11g+BT
 Power : 120Vac/60Hz
 Model : FR 710210
 Memo : 11b Tx_Ch01,2412MHz
 Plane : E2
 Data Rate : 11

	Freq	Level	Over	Limit	Read	Antenna	Cable	Preamp	Ant	Table	Remark
	MHz	dBuV/m	dB	dBuV/m	dBuV	dB/m	dB	dB	cm	deg	
1	7236.0	56.72	-17.28	74.00	46.53	38.33	7.78	35.92	100	0	Peak
2	7236.0	45.15	-8.85	54.00	34.96	38.33	7.78	35.92	100	213	Average



Data: 6 File: D:\Project\2007Q1\200710208\52815C\WLAN\11b Tx_Ch01.EMI (18) Date: 2006-12-07

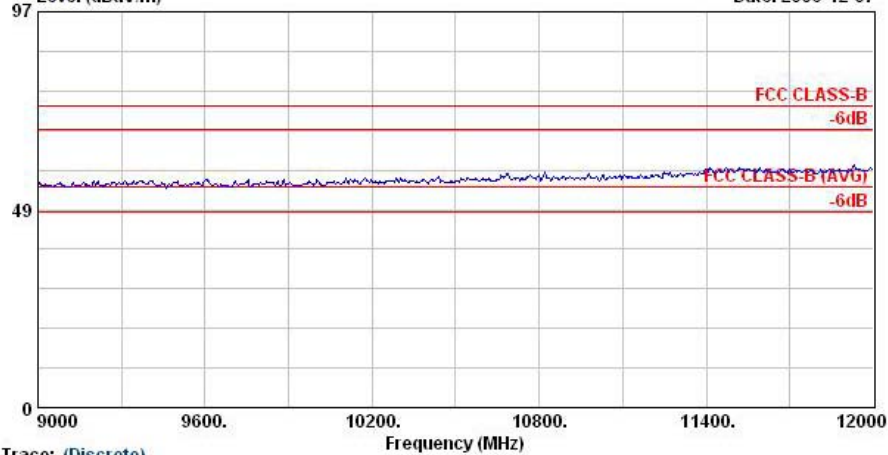

Trace: (Discrete)

Site : 08CH06-HY
 Condition : HF-ANT-060410 HORIZONTAL
 EUT : PDA with GPRS/EDGE+WLAN 11g+BT
 Power : 120Vac/60Hz
 Model : FR 710210
 Memo : 11b Tx_Ch01,2412MHz
 Plane : E2
 Data Rate : 11

Data: 17 File: D:\Project\2007Q1\200710208\52815C\WLAN\11b Tx_Ch01.EMI (18) Date: 2006-12-07

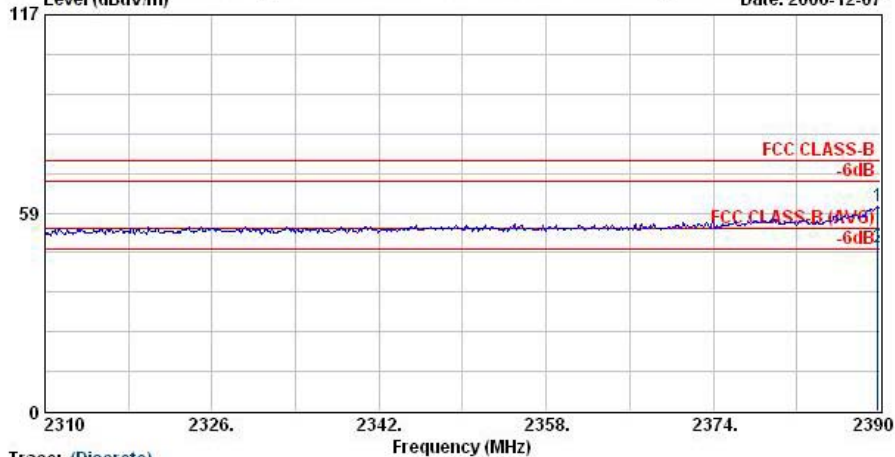

Trace: (Discrete)

Site : 08CH06-HY
 Condition : HF-ANT-060410 HORIZONTAL
 EUT : PDA with GPRS/EDGE+WLAN 11g+BT
 Power : 120Vac/60Hz
 Model : FR 710210
 Memo : 11b Tx_Ch01,2412MHz
 Plane : E2
 Data Rate : 11

	Freq	Level	Over	Limit	ReadAntenna	Cable	Preamp	Ant	Table	Remark
	MHz	dBuV/m	dB	dBuV/m	dBuV	dB/m	dB	dB	cm	deg
1	2389.8	60.32	-13.68	74.00	61.76	30.26	3.75	35.46	100	0 Peak
2	2389.8	48.10	-5.90	54.00	49.55	30.26	3.75	35.46	100	84 Average



- Polarization : Vertical

The test that passed at minimum margin was marked by the frame in the following table.



Trace: (Discrete)
 Site : 08CH06-HY
 Condition : LF-ANT(951121) VERTICAL
 EUT : PDA with GPRS/EDGE+WLAN 11g+BT
 Power : 120Vac/60Hz
 Model : FR 710210
 Memo : 11b Tx_Ch01,2412MHz
 Plane : E2
 Data Rate : 11

	Freq	Level	Over	Limit	ReadAntenna	Cable	Preamp	Ant	Table	Remark
	MHz	dBuV/m	dB	dBuV/m	dBuV	dB	dB	cm	deg	
1	33.2	31.05	-8.95	40.00	44.01	17.54	0.86	31.36	---	Peak
2	40.5	28.31	-11.69	40.00	45.57	13.01	0.92	31.19	---	Peak
3	156.1	26.92	-16.58	43.50	45.88	10.24	1.85	31.05	---	Peak

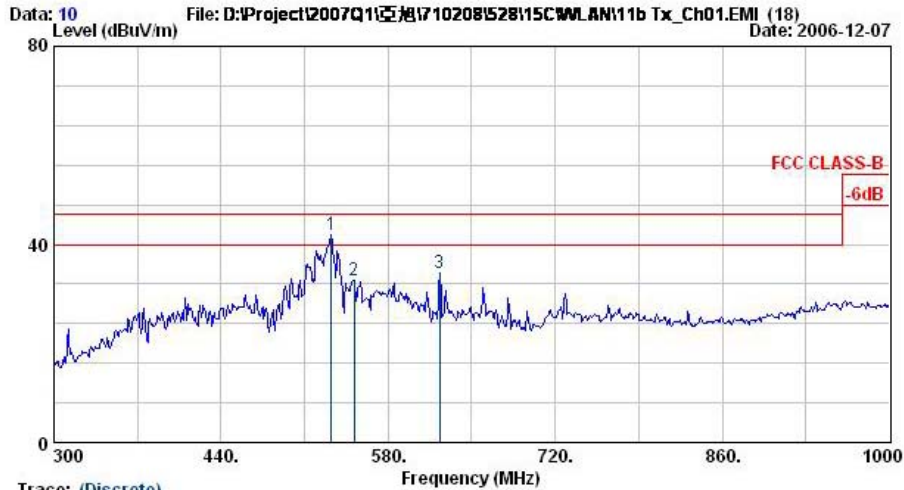

Trace: (Discrete)
 Site : 08CH06-HY
 Condition : LF-ANT(951121) VERTICAL
 EUT : PDA with GPRS/EDGE+WLAN 11g+BT
 Power : 120Vac/60Hz
 Model : FR 710210
 Memo : 11b Tx_Ch01,2412MHz
 Plane : E2
 Data Rate : 11

	Freq	Level	Over	Limit	ReadAntenna	Cable	Preamp	Ant	Table	Remark
	MHz	dBuV/m	dB	dBuV/m	dBuV	dB	dB	cm	deg	
1 @	532.4	41.91	-4.09	46.00	51.24	17.76	3.65	30.75	100	86 Peak
2	551.3	32.82	-13.18	46.00	41.86	17.96	3.73	30.73	---	Peak
3	623.4	34.32	-11.68	46.00	42.42	18.57	3.99	30.66	---	Peak



Data: 13 File: D:\Project\2007Q1\200710208\52815C\WLAN11b Tx_Ch01.EMI (18) Date: 2006-12-07

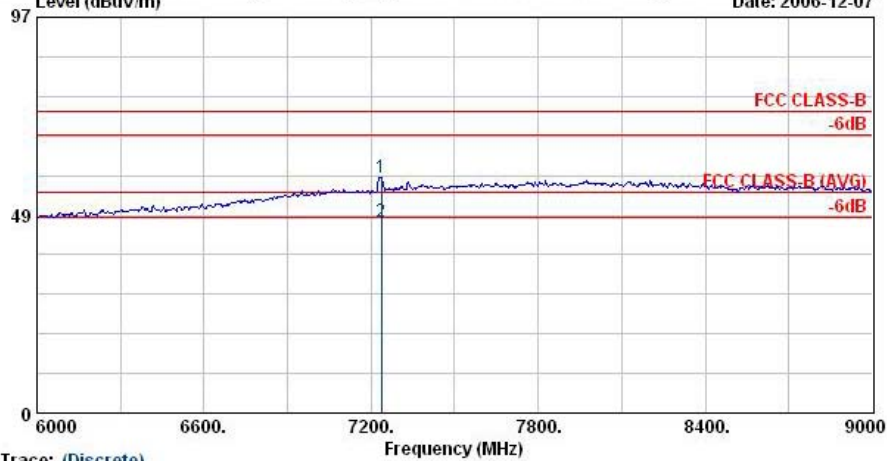

Trace: (Discrete)

Site : 03CH06-HY
 Condition : HF-ANT-060410 VERTICAL
 EUT : FDA with GPRS/EDGE+WLAN 11g+BT
 Power : 120V_{ac}/60Hz
 Model : FR 710210
 Memo : 11b Tx_Ch01;2412MHz
 Plane : E2
 Data Rate : 11

	Freq	Level	Over	Limit	Read	Antenna	Cable	Preamp	Ant	Table	Remark
	MHz	dBuV/m	dB	dBuV/m	dBuV	dB/m	dB	dB	cm	deg	
1	7236.0	57.67	-16.33	74.00	47.48	38.33	7.78	35.92	100	0	Peak
2	7236.0	46.85	-7.15	54.00	36.66	38.33	7.78	35.92	100	30	Average

Data: 14 File: D:\Project\2007Q1\200710208\52815C\WLAN11b Tx_Ch01.EMI (18) Date: 2006-12-07

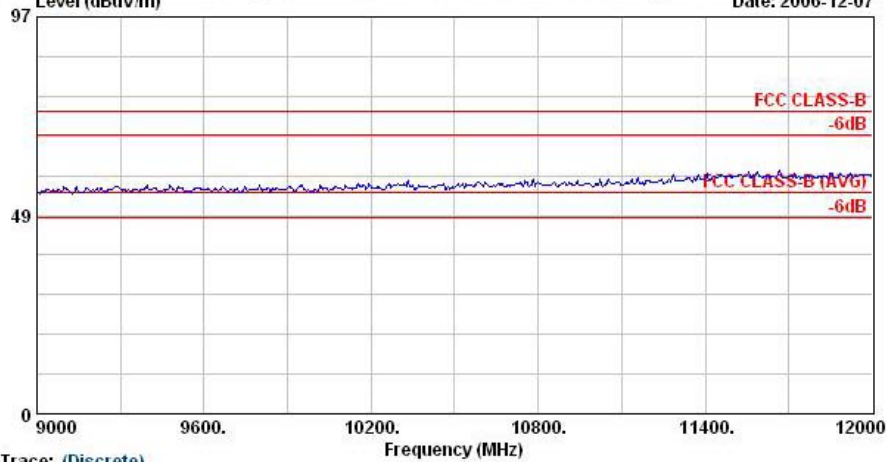

Trace: (Discrete)

Site : 03CH06-HY
 Condition : HF-ANT-060410 VERTICAL
 EUT : FDA with GPRS/EDGE+WLAN 11g+BT
 Power : 120V_{ac}/60Hz
 Model : FR 710210
 Memo : 11b Tx_Ch01;2412MHz
 Plane : E2
 Data Rate : 11



Data: 18 File: D:\Project\2007Q1\200710208\52815C\WLAN\11b Tx_Ch01.EMI (18) Date: 2006-12-07
 Level (dBuV/m)

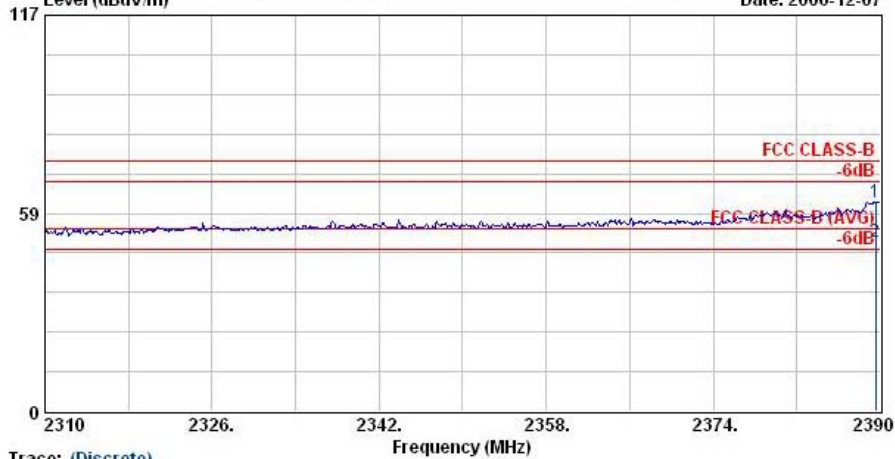

Trace: (Discrete)

Site : 03CH06-HY
 Condition : HF-ANT-060410 VERTICAL
 EUT : FDA with GPRS/EDGE+WLAN 11g+BT
 Power : 120V_{ac}/60Hz
 Model : FR 710210
 Memo : 11b Tx_Ch01;2412MHz
 Plane : E2
 Data Rate : 11

	Freq	Level	Over Limit	Limit Line	ReadAntenna Level	Antenna Factor	Cable Loss	Preamp Factor	Ant Pos	Table Pos	Remark
	MHz	dBuV/m	dB	dBuV/m	dBuV	dB/m	dB	dB	cm	deg	
1	2389.5	61.97	-12.03	74.00	63.40	30.26	3.75	35.44	100	0	Peak
2 @	2389.5	49.81	-4.19	54.00	51.24	30.26	3.75	35.44	100	179	Average

Remark: There is no more obvious spurious emission except the listings above.



- Test Mode : Mode 2
- Polarization : Horizontal

The test that passed at minimum margin was marked by the frame in the following table.

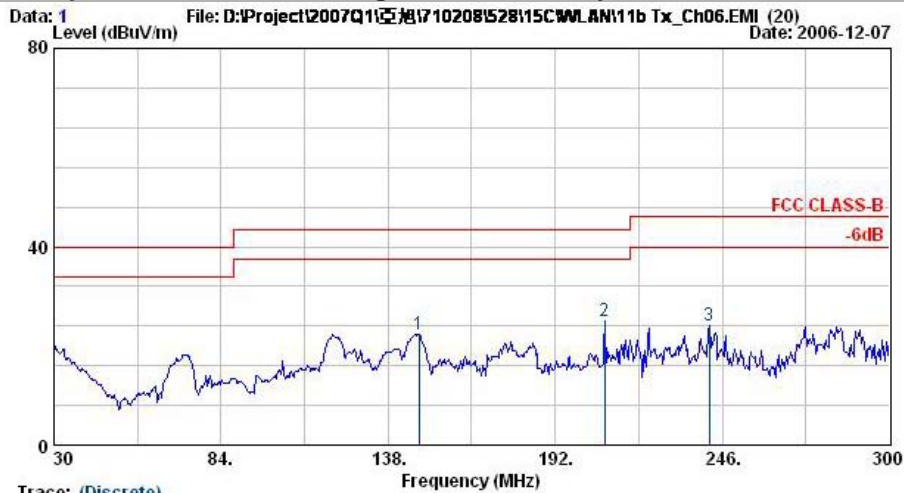

Trace: (Discrete)
 Site : 03CH06-HY
 Condition : LF-ANT(951121) HORIZONTAL
 EUT : PDA with GPRS/EDGE+WLAN 11g+BT
 Power : 120Vac/60Hz
 Model : FR 710210
 Memo : 11b Tx_Ch06;2437MHz
 Plane : E2
 Data Rate : 11

	Freq	Level	Over	Limit	ReadAntenna	Cable	Preamp	Ant	Table	Remark
	MHz	dBuV/m	dB	dBuV/m	dBuV	dB	dB	cm	deg	
1 @	148.0	22.33	-21.17	43.50	41.21	10.37	1.81	31.06	---	Peak
2 @	207.9	25.00	-18.50	43.50	44.09	9.76	2.17	31.03	---	Peak
3 @	241.7	24.21	-21.79	46.00	41.05	11.76	2.34	30.93	---	Peak

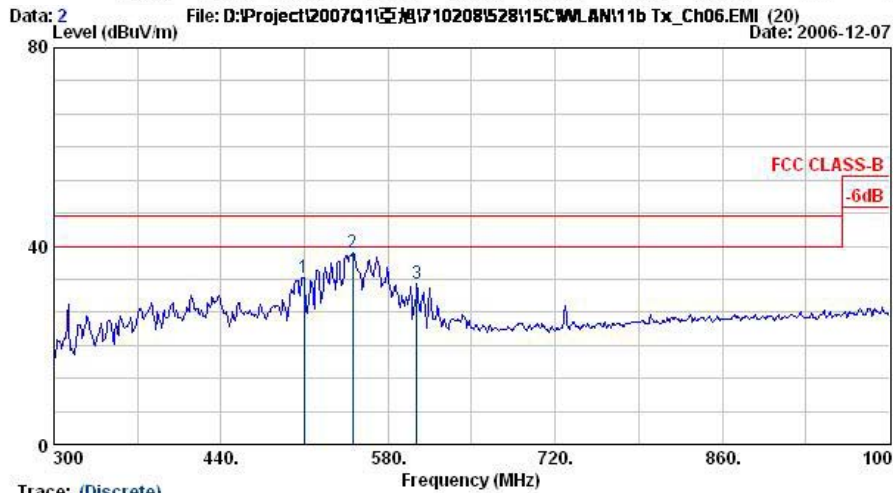

Trace: (Discrete)
 Site : 03CH06-HY
 Condition : LF-ANT(951121) HORIZONTAL
 EUT : PDA with GPRS/EDGE+WLAN 11g+BT
 Power : 120Vac/60Hz
 Model : FR 710210
 Memo : 11b Tx_Ch06;2437MHz
 Plane : E2
 Data Rate : 11

	Freq	Level	Over	Limit	ReadAntenna	Cable	Preamp	Ant	Table	Remark
	MHz	dBuV/m	dB	dBuV/m	dBuV	dB	dB	cm	deg	
1	509.30	33.54	-12.46	46.00	43.25	17.52	3.55	30.78	---	Peak
2 @	550.60	38.73	-7.27	46.00	47.77	17.96	3.73	30.73	188	Peak
3	603.80	32.43	-13.57	46.00	40.71	18.49	3.89	30.66	---	Peak



Data: 3 File: D:\Project\2007Q1\200710208\528\15C\WLAN\11b Tx_Ch06.EMI (20) Date: 2006-12-07

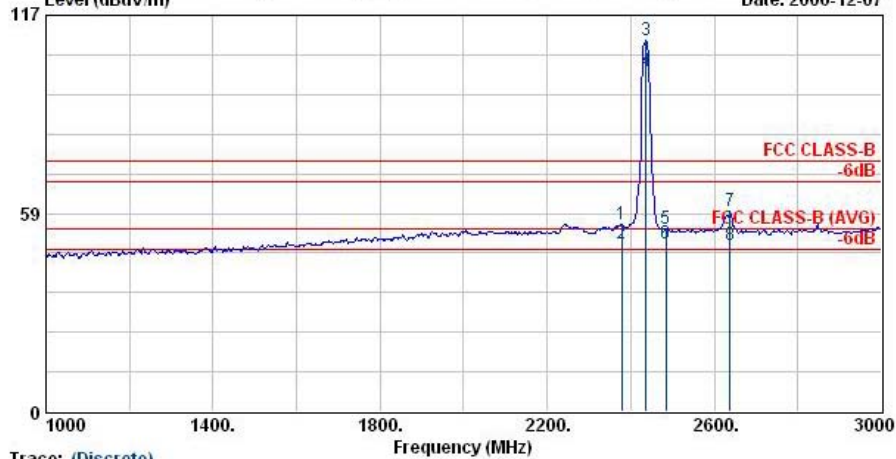

Trace: (Discrete)

Site : 08CH06-HY
 Condition : HF-ANT-060410 HORIZONTAL
 EUT : FDA with GPRS/EDGE+WLAN 11g+BT
 Power : 120Wac/60Hz
 Model : FR 710210
 Memo : 11b Tx_Ch06;2437MHz
 Plane : E2
 Data Rate : 11

	Freq	Level	Over	Limit	Read	Antenna	Cable	Preamp	Ant	Table	Remark
	MHz	dBuV/m	dB	dBuV/m	dBuV	dB/m	dB	dB	cm	deg	
1 @	2378.0	55.11	-18.89	74.00	56.55	30.25	3.75	35.44	100		0 Peak
2 @	2378.0	49.61	-4.39	54.00	51.05	30.25	3.75	35.44	100	84	Average
3 @	2437.0	109.41			110.82	30.27	3.79	35.47	100		0 Peak
4 @	2437.0	100.42			101.80	30.28	3.82	35.47	100	84	Average
5 @	2484.0	54.00	-20.00	74.00	55.36	30.29	3.86	35.51	100		0 Peak
6 @	2484.0	49.41	-4.59	54.00	50.77	30.29	3.86	35.51	100	84	Average
7 @	2638.0	59.07	-14.93	74.00	60.49	30.11	4.00	35.52	100		0 Peak
8 @	2638.0	49.19	-4.81	54.00	50.60	30.11	4.00	35.52	100	84	Average

Remark: #3 and #4 Fundamental Signal

Data: 4 File: D:\Project\2007Q1\200710208\528\15C\WLAN\11b Tx_Ch06.EMI (20) Date: 2006-12-07

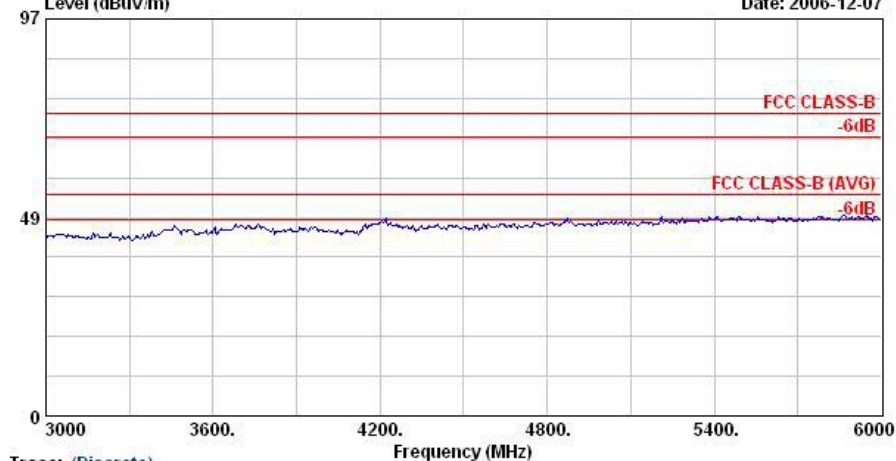

Trace: (Discrete)

Site : 08CH06-HY
 Condition : HF-ANT-060410 HORIZONTAL
 EUT : FDA with GPRS/EDGE+WLAN 11g+BT
 Power : 120Wac/60Hz
 Model : FR 710210
 Memo : 11b Tx_Ch06;2437MHz
 Plane : E2
 Data Rate : 11

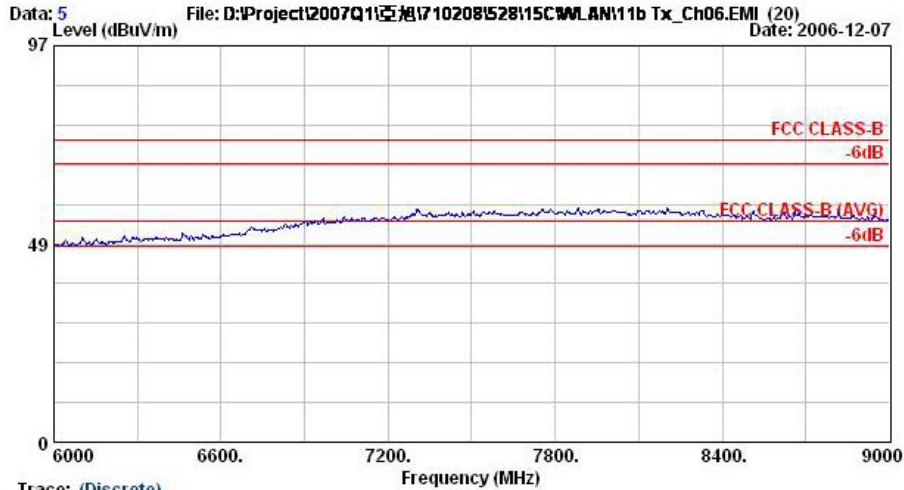

Trace: (Discrete)

Site : 08CH06-HY
Condition : HF-ANT-060410 HORIZONTAL
EUT : PDA with GPRS/EDGE+WLAN 11g+BT
Power : 120Wac/60Hz
Model : FR 710210
Memo : 11b Tx_Ch06;2437MHz
Plane : E2
Data Rate : 11

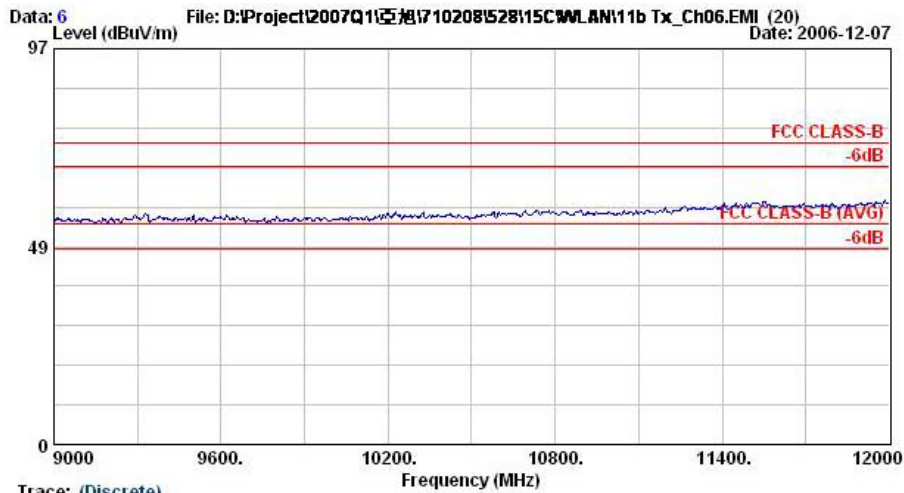

Trace: (Discrete)

Site : 08CH06-HY
Condition : HF-ANT-060410 HORIZONTAL
EUT : PDA with GPRS/EDGE+WLAN 11g+BT
Power : 120Wac/60Hz
Model : FR 710210
Memo : 11b Tx_Ch06;2437MHz
Plane : E2
Data Rate : 11



- Polarization : Vertical

The test that passed at minimum margin was marked by the frame in the following table.

Data: 11 File: D:\Project\2007Q1\52815C\WLAN11b Tx_Ch06.EMI (20) Date: 2006-12-07

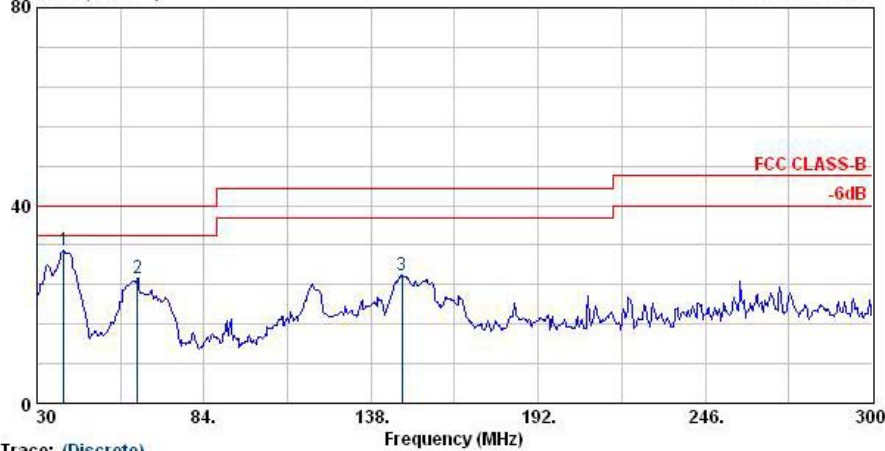

Trace: (Discrete)
 Site : 08CH06-HY
 Condition : LF-ANT(951121) VERTICAL
 EUT : PDA with GPRS/EDGE+WLAN 11g+BT
 Power : 120Vac/60Hz
 Model : FR 710210
 Memo : 11b Tx_Ch06;2437MHz
 Plane : E2
 Data Rate : 11

	Freq	Level	Over	Limit	ReadAntenna	Cable	Preamp	Ant	Table	Remark	
	MHz	dBuV/m	dB	dBuV/m	dBuV	dB/m	dB	dB	cm	deg	
1 @	38.6	30.87	-9.13	40.00	47.15	14.03	0.91	31.23	---	---	Peak
2 @	62.4	25.32	-14.68	40.00	48.68	6.67	1.17	31.20	---	---	Peak
3 @	148.0	25.79	-17.71	43.50	44.66	10.37	1.81	31.06	---	---	Peak

Data: 12 File: D:\Project\2007Q1\52815C\WLAN11b Tx_Ch06.EMI (20) Date: 2006-12-07

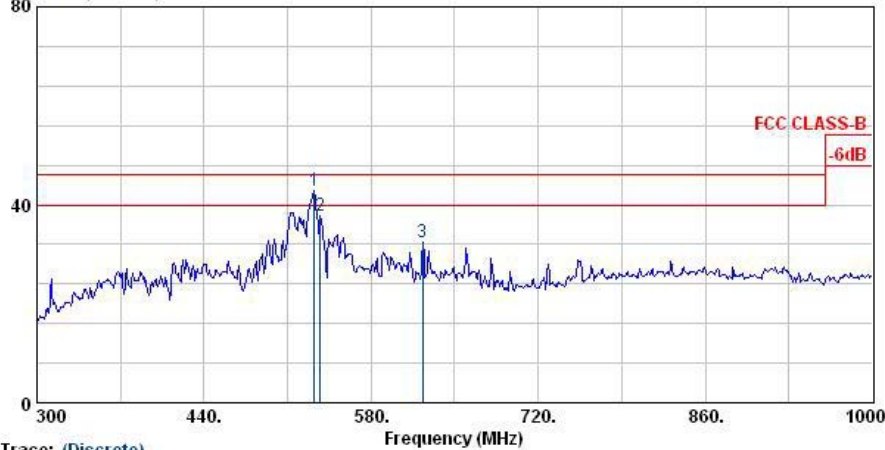

Trace: (Discrete)
 Site : 08CH06-HY
 Condition : LF-ANT(951121) VERTICAL
 EUT : PDA with GPRS/EDGE+WLAN 11g+BT
 Power : 120Vac/60Hz
 Model : FR 710210
 Memo : 11b Tx_Ch06;2437MHz
 Plane : E2
 Data Rate : 11

	Freq	Level	Over	Limit	ReadAntenna	Cable	Preamp	Ant	Table	Remark	
	MHz	dBuV/m	dB	dBuV/m	dBuV	dB/m	dB	dB	cm	deg	
1 @	532.4	42.91	-3.09	46.00	52.25	17.76	3.65	30.75	100	85	Peak
2 @	537.3	37.81	-8.19	46.00	47.07	17.81	3.67	30.75	---	---	Peak
3 @	623.4	32.32	-13.68	46.00	40.42	18.57	3.99	30.66	---	---	Peak



Data: 15 File: D:\Project\2007Q1\528152815C\WLAN11b Tx_Ch06.EMI (20) Date: 2006-12-07
 Level (dBuV/m)

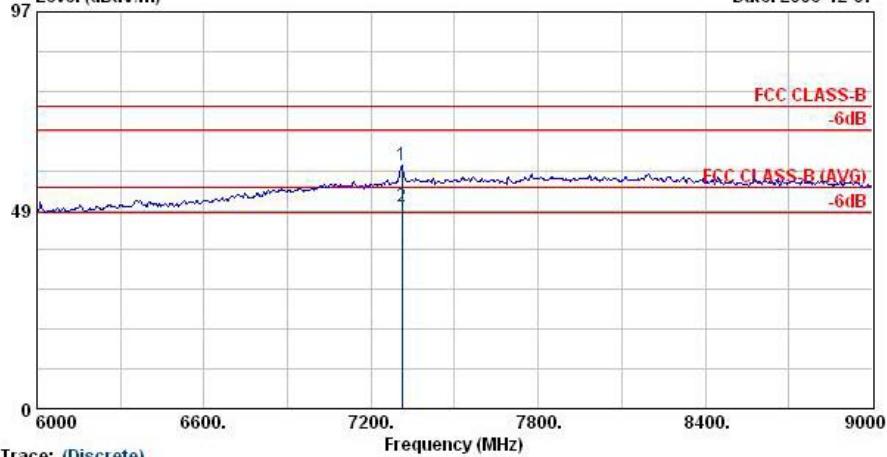

Trace: (Discrete)

Site : 08CH06-HY
 Condition : HP-ANT-060410 VERTICAL
 EUT : PDA with GPRS/EDGE+WLAN 11g+BT
 Power : 120Vac/60Hz
 Model : FR 710210
 Memo : 11b Tx_Ch06;2437MHz
 Plane : E2
 Data Rate : 11

	Freq	Level	Over	Limit	Read	Antenna	Cable	Preamp	Ant	Table	
	MHz	dBuV/m	dB	dBuV/m	dBuV	dB/m	dB	dB	cm	deg	Remark
1 @	7311.0	59.47	-14.53	74.00	49.21	38.48	7.73	35.95	100	0	Peak
2 @	7311.0	49.27	-4.73	54.00	39.01	38.48	7.73	35.95	100	329	Average

Data: 16 File: D:\Project\2007Q1\528152815C\WLAN11b Tx_Ch06.EMI (20) Date: 2006-12-07
 Level (dBuV/m)

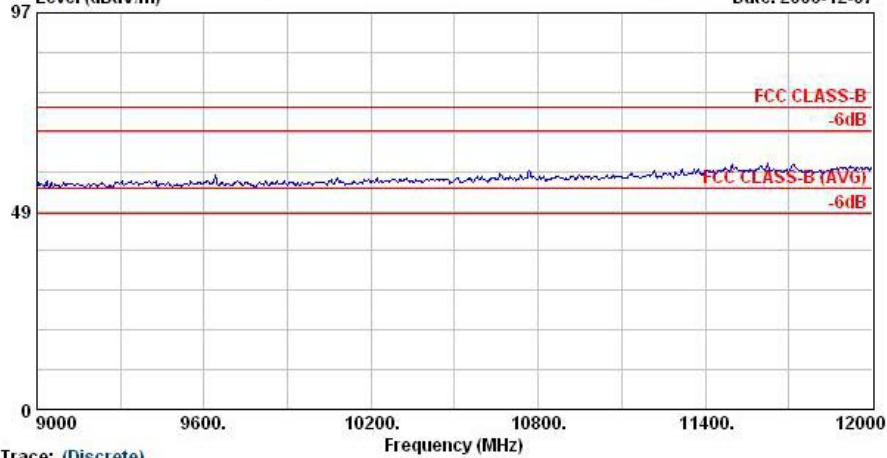

Trace: (Discrete)

Site : 08CH06-HY
 Condition : HP-ANT-060410 VERTICAL
 EUT : PDA with GPRS/EDGE+WLAN 11g+BT
 Power : 120Vac/60Hz
 Model : FR 710210
 Memo : 11b Tx_Ch06;2437MHz
 Plane : E2
 Data Rate : 11

Remark: There is no more obvious spurious emission except the listings above.



- Test Mode : Mode 3
- Polarization : Horizontal

The test that passed at minimum margin was marked by the frame in the following table.

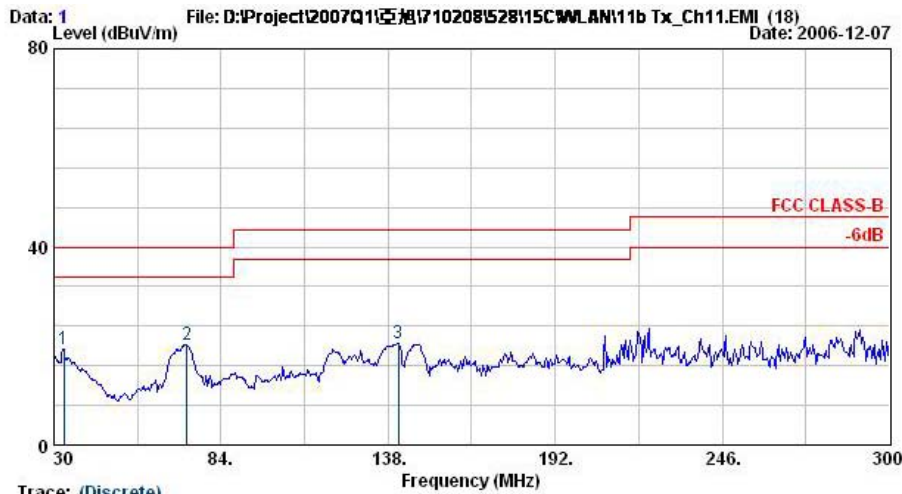

Trace: (Discrete)
 Site : 03CH06-HY
 Condition : BI-LOG-2004-1122 HORIZONTAL
 EUT : PDA with GPRS/EDGE+WLAN 11g+BT
 Power : 120Vac/60Hz
 Model : FR 710210
 Memo : 11b Tx_Ch11;2462MHz
 Plane : E2
 Data Rate : 11

	Freq	Level	Over	Limit	ReadAntenna	Cable	Preamp	Ant	Table	Remark	
	MHz	dBuV/m	dB	dBuV/m	dBuV	dB/m	dB	dB	cm	deg	
1	33.2	19.42	-20.58	40.00	32.18	17.73	0.86	31.36	---	---	Peak
2 @	72.9	20.22	-19.78	40.00	43.58	6.48	1.32	31.16	---	---	Peak
3	141.2	20.45	-23.05	43.50	39.12	10.62	1.76	31.04	---	---	Peak

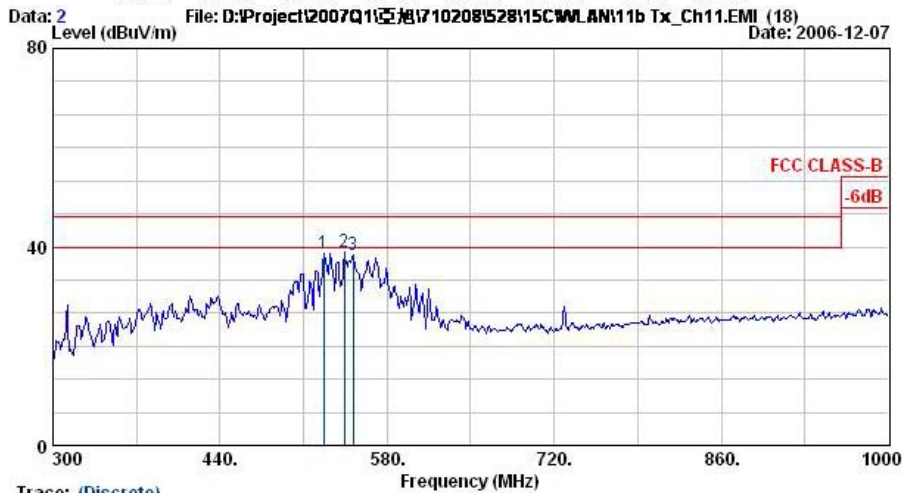

Trace: (Discrete)
 Site : 03CH06-HY
 Condition : LF-ANT(051121) HORIZONTAL
 EUT : PDA with GPRS/EDGE+WLAN 11g+BT
 Power : 120Vac/60Hz
 Model : FR 710210
 Memo : 11b Tx_Ch11;2462MHz
 Plane : E2
 Data Rate : 11

	Freq	Level	Over	Limit	ReadAntenna	Cable	Preamp	Ant	Table	Remark	
	MHz	dBuV/m	dB	dBuV/m	dBuV	dB/m	dB	dB	cm	deg	
1	526.80	38.61	-7.39	46.00	48.04	17.70	3.63	30.76	---	---	Peak
2 @	544.30	39.06	-6.94	46.00	48.21	17.88	3.70	30.74	100	175	Peak
3	551.30	38.44	-7.56	46.00	47.48	17.96	3.73	30.73	---	---	Peak



Data: 3 File: D:\Project\2007Q1\20071020\8152815C\WLAN11b Tx_Ch11.EMI (18) Date: 2006-12-07

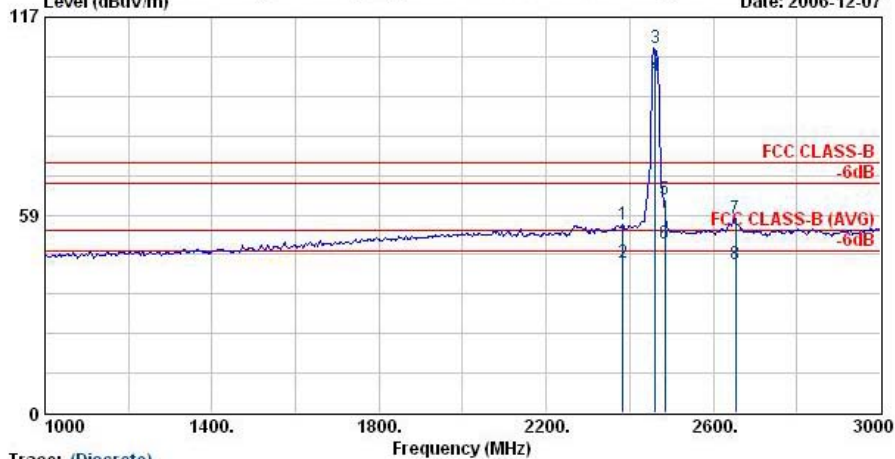

Trace: (Discrete)

Site : 08CH06-HY
 Condition : HF-ANT-060410 HORIZONTAL
 EUT : FDA with GPRS/EDGE+WLAN 11g+BT
 Power : 120V_{ac}/60Hz
 Model : FR 710210
 Memo : 11b Tx_Ch11;2462MHz
 Plane : E2
 Data Rate : 11

	Freq	Level	Over	Limit	Read	Antenna	Cable	Preamp	Ant	Table	Remark
	MHz	dBuV/m	dB	dBuV/m	dBuV	dB/m	dB	dB	cm	deg	
1 @	2384.0	55.59	-18.41	74.00	57.02	30.25	3.75	35.44	100	0	Peak
2 @	2384.0	44.52	-9.48	54.00	45.96	30.25	3.75	35.44	126	83	Average
3 @	2462.0	107.97			109.34	30.29	3.84	35.49	100	0	Peak
4 @	2462.0	99.63			101.00	30.29	3.84	35.49	126	83	Average
5 @	2484.0	63.07	-10.93	74.00	64.43	30.29	3.86	35.51	100	0	Peak
6 @	2484.0	49.92	-4.08	54.00	51.28	30.29	3.86	35.51	126	83	Average
7 @	2654.0	57.42	-16.58	74.00	58.84	30.09	4.01	35.52	100	0	Peak
8 @	2654.0	43.97	-10.03	54.00	45.39	30.09	4.01	35.52	126	83	Average

Remark: #3 and #4 Fundamental Signal

Data: 4 File: D:\Project\2007Q1\20071020\8152815C\WLAN11b Tx_Ch11.EMI (18) Date: 2006-12-07

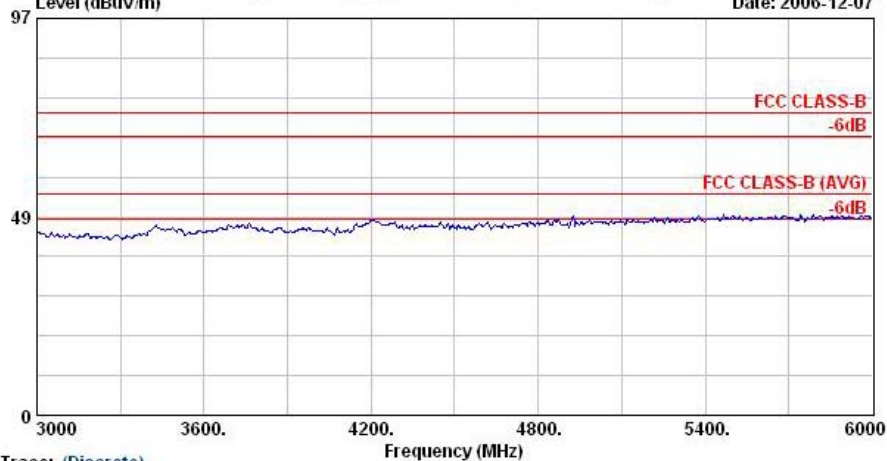

Trace: (Discrete)

Site : 08CH06-HY
 Condition : HF-ANT-060410 HORIZONTAL
 EUT : FDA with GPRS/EDGE+WLAN 11g+BT
 Power : 120V_{ac}/60Hz
 Model : FR 710210
 Memo : 11b Tx_Ch11;2462MHz
 Plane : E2
 Data Rate : 11



Data: 5 File: D:\Project\2007Q1\52815C\WLAN\11b Tx_Ch11.EMI (18) Date: 2006-12-07
Level (dBuV/m)

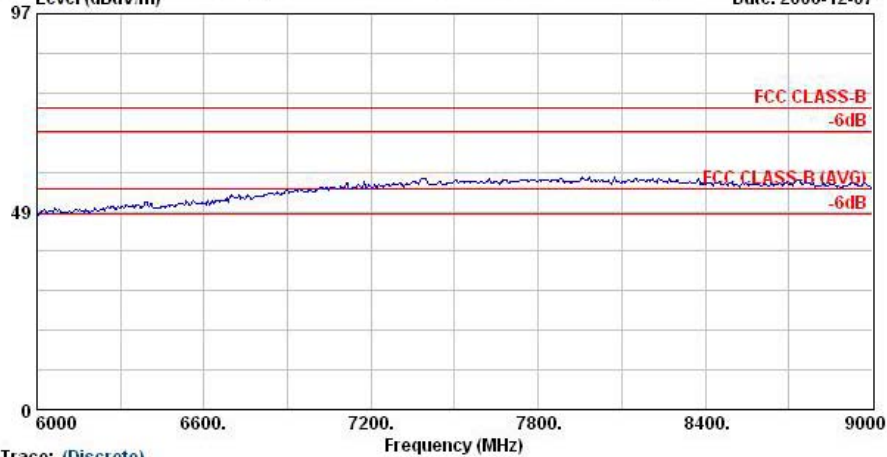

Trace: (Discrete)

Site : 08CH06-HY
Condition : HP-ANT-060410 HORIZONTAL
EUT : PDA with GPRS/EDGE+WLAN 11g+BT
Power : 120Vac/60Hz
Model : FR 710210
Memo : 11b Tx_Ch11,2462MHz
Plane : E2
Data Rate : 11

Data: 6 File: D:\Project\2007Q1\52815C\WLAN\11b Tx_Ch11.EMI (18) Date: 2006-12-07
Level (dBuV/m)

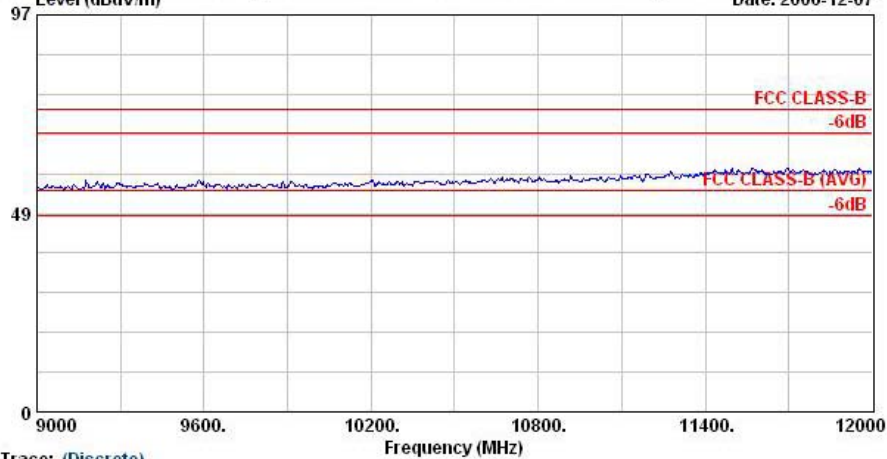

Trace: (Discrete)

Site : 08CH06-HY
Condition : HP-ANT-060410 HORIZONTAL
EUT : PDA with GPRS/EDGE+WLAN 11g+BT
Power : 120Vac/60Hz
Model : FR 710210
Memo : 11b Tx_Ch11,2462MHz
Plane : E2
Data Rate : 11



Data: 17 File: D:\Project\2007Q1\5781710208\52815C\WLAN\11b Tx_Ch11.EMI (18) Date: 2006-12-07
 Level (dBuV/m)

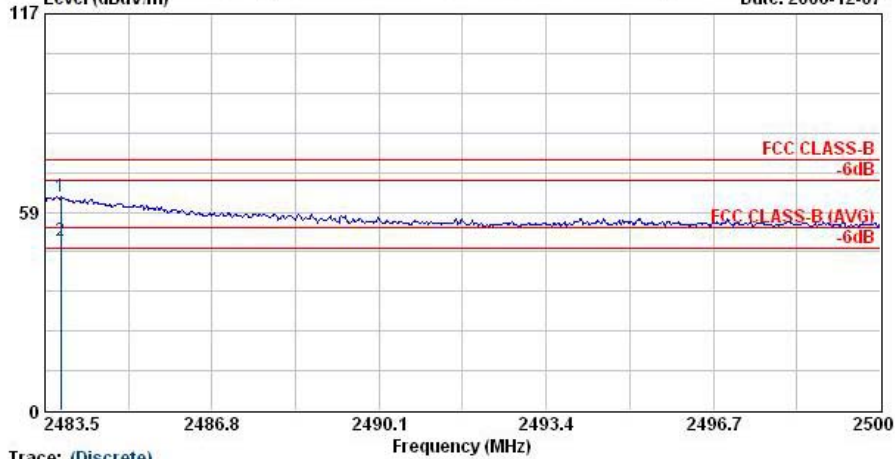

Trace: (Discrete)

Site : 08CH06-HY
 Condition : HF-ANT-060410 HORIZONTAL
 EUT : PDA with GPRS/EDGE+WLAN 11g+BT
 Power : 120V_{ac}/60Hz
 Model : FR 710210
 Memo : 11b Tx_Ch11;2462MHz
 Plane : E2
 Data Rate : 11

	Freq	Level	Over Limit	Limit Line	Read Level	Antenna Factor	Cable Loss	Preamp Factor	Ant Pos	Table Pos	Remark
	MHz	dBuV/m	dB	dBuV/m	dBuV	dB/m	dB	dB	cm	deg	
1 @	2483.8	63.07	-10.93	74.00	64.43	30.29	3.86	35.51	100	0	Peak
2 @	2483.8	49.92	-4.08	54.00	51.28	30.29	3.86	35.51	126	83	Average



- Polarization : Vertical

The test that passed at minimum margin was marked by the frame in the following table.

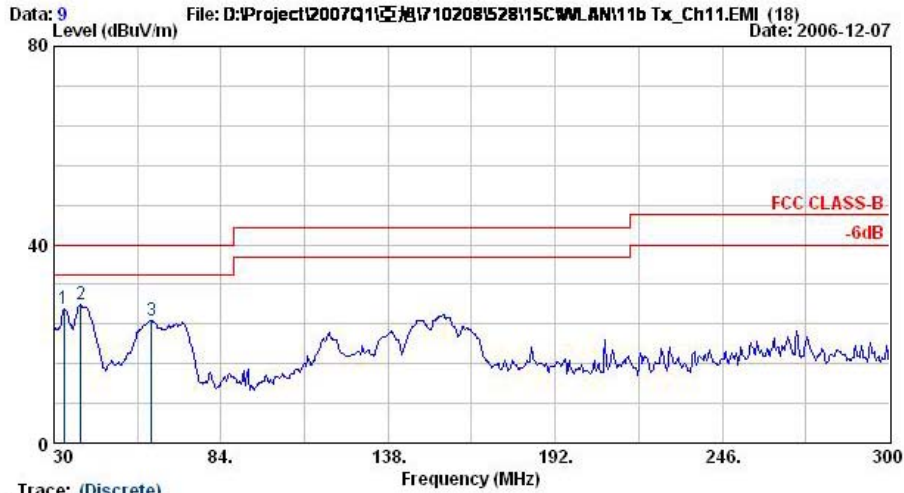

Trace: (Discrete)
 Site : 03CH06-HY
 Condition : LF-ANT(951121) VERTICAL
 EUT : PDA with GPRS/EDGE+WLAN 11g+BT
 Power : 120Wac/60Hz
 Model : FR 710210
 Memo : 11b Tx_Ch11;2462MHz
 Plane : E2
 Data Rate : 11

	Freq	Level	Over	Limit	ReadAntenna	Cable	Preamp	Ant	Table	Remark	
	MHz	dBUV/m	dB	dBUV/m	dBuV	dB/m	dB	dB	cm	deg	
1 @	33.2	27.05	-12.95	40.00	40.01	17.54	0.86	31.36	---	---	Peak
2 @	38.6	27.87	-12.13	40.00	44.15	14.03	0.91	31.23	---	---	Peak
3 @	61.6	24.79	-15.21	40.00	48.15	6.67	1.17	31.20	---	---	Peak

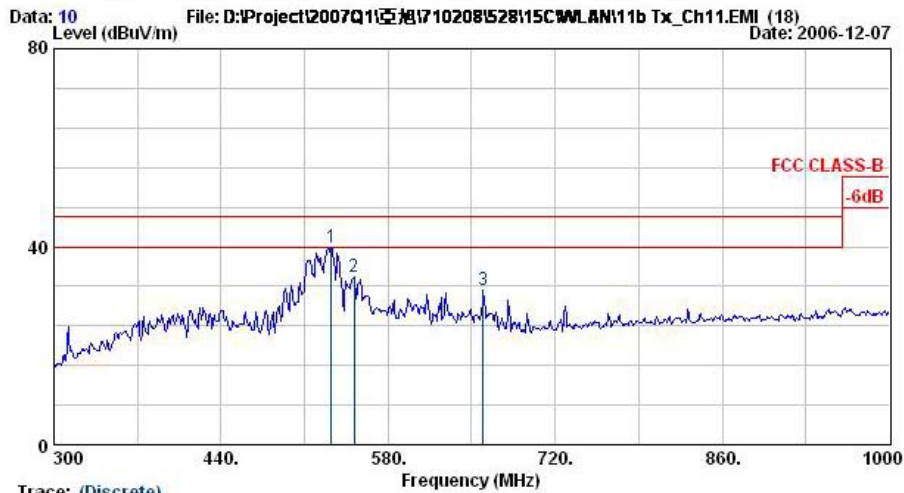

Trace: (Discrete)
 Site : 03CH06-HY
 Condition : LF-ANT(951121) VERTICAL
 EUT : PDA with GPRS/EDGE+WLAN 11g+BT
 Power : 120Wac/60Hz
 Model : FR 710210
 Memo : 11b Tx_Ch11;2462MHz
 Plane : E2
 Data Rate : 11

	Freq	Level	Over	Limit	ReadAntenna	Cable	Preamp	Ant	Table	Remark	
	MHz	dBUV/m	dB	dBUV/m	dBuV	dB/m	dB	dB	cm	deg	
1 @	532.4	39.85	-6.15	46.00	49.18	17.76	3.65	30.75	100	78	Peak
2 @	551.3	33.82	-12.18	46.00	42.86	17.96	3.73	30.73	---	---	Peak
3 @	659.8	31.12	-14.88	46.00	38.90	18.72	4.15	30.64	---	---	Peak



Data: 11 File: D:\Project\2007Q1\200710208\528\15C\WLAN\11b Tx_Ch11.EMI (18) Date: 2006-12-07

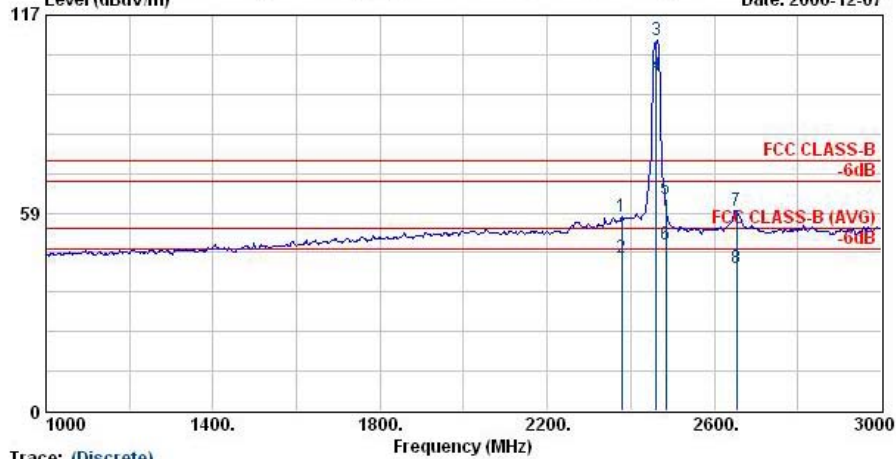

Trace: (Discrete)

Site : 08CH06-HY
 Condition : HF-ANT-060410 VERTICAL
 EUT : PDA with GPRS/EDGE+WLAN 11g+BT
 Power : 120V_{ac}/60Hz
 Model : FR 710210
 Memo : 11b Tx_Ch11;2462MHz
 Plane : E2
 Data Rate : 11

	Freq	Level	Over	Limit	Read	Antenna	Cable	Preamp	Ant	Table	Remark
	MHz	dBuV/m	dB	dBuV/m	dBuV	dB/m	dB	dB	cm	deg	
1 @	2378.0	57.48	-16.52	74.00	58.91	30.25	3.75	35.44	100	0	Peak
2 @	2378.0	45.40	-8.60	54.00	46.84	30.25	3.75	35.44	100	214	Average
3 @	2462.0	109.48			110.85	30.29	3.84	35.49	100	0	Peak
4 @	2462.0	99.13			100.50	30.29	3.84	35.49	100	214	Average
5 @	2484.0	62.72	-11.28	74.00	64.08	30.29	3.86	35.51	100	0	Peak
6 @	2484.0	49.36	-4.64	54.00	50.72	30.29	3.86	35.51	100	214	Average
7 @	2654.0	59.33	-14.67	74.00	60.75	30.09	4.01	35.52	100	0	Peak
8 @	2654.0	42.39	-11.61	54.00	43.81	30.09	4.01	35.52	100	214	Average

Remark: #3 and #4 Fundamental Signal

Data: 12 File: D:\Project\2007Q1\200710208\528\15C\WLAN\11b Tx_Ch11.EMI (18) Date: 2006-12-07

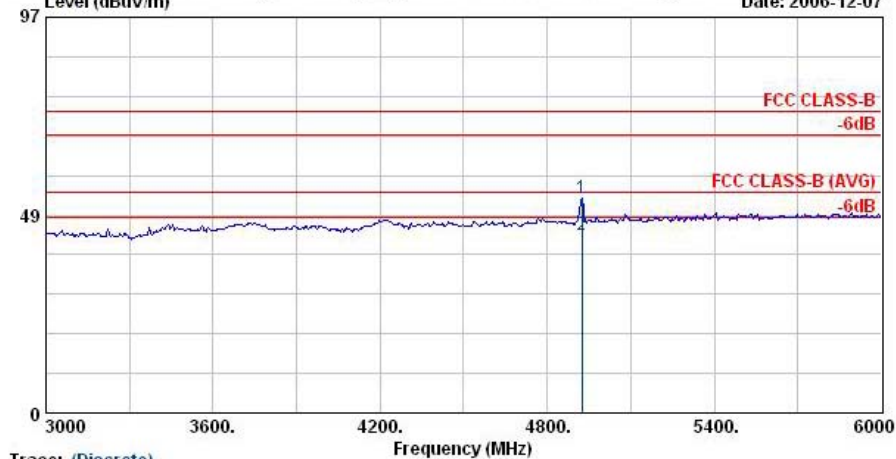

Trace: (Discrete)

Site : 08CH06-HY
 Condition : HF-ANT-060410 VERTICAL
 EUT : PDA with GPRS/EDGE+WLAN 11g+BT
 Power : 120V_{ac}/60Hz
 Model : FR 710210
 Memo : 11b Tx_Ch11;2462MHz
 Plane : E2
 Data Rate : 11

	Freq	Level	Over	Limit	Read	Antenna	Cable	Preamp	Ant	Table	Remark
	MHz	dBuV/m	dB	dBuV/m	dBuV	dB/m	dB	dB	cm	deg	
1	4924.0	52.74	-21.26	74.00	49.69	33.34	5.92	36.21	100	0	Peak
2 @	4924.0	43.54	-10.46	54.00	40.49	33.34	5.92	36.21	112	284	Average



Data: 13 File: D:\Project\2007Q1\IC ID: 2739D\52815C\WLAN\11b Tx_Ch11.EMI (18) Date: 2006-12-07

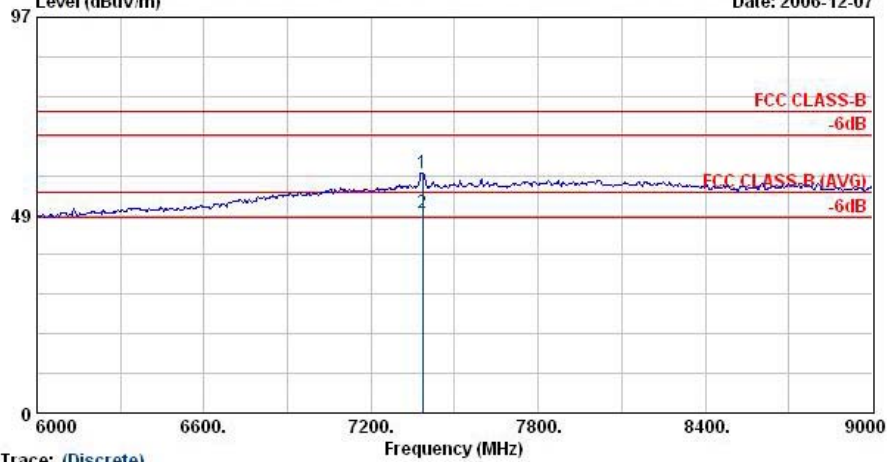

Trace: (Discrete)
 Site : 03CH06-HY
 Condition : HP-ANT-060410 VERTICAL
 EUT : PDA with GPRS/EDGE+WLAN 11g+BT
 Power : 120Vac/60Hz
 Model : FR 710210
 Memo : 11b Tx_Ch11_2462MHz
 Plane : E2
 Data Rate : 11

	Freq	Level	Over	Limit	Read	Antenna	Cable	Preamp	Ant	Table	Remark
	MHz	dBuV/m	dB	dBuV/m	dBuV	dB/m	dB	dB	cm	deg	
1 @	7386.0	58.86	-15.14	74.00	48.51	38.67	7.68	36.00	100	0	Peak
2 @	7386.0	48.87	-5.13	54.00	38.52	38.67	7.68	36.00	100	333	Average

Data: 14 File: D:\Project\2007Q1\IC ID: 2739D\52815C\WLAN\11b Tx_Ch11.EMI (18) Date: 2006-12-07

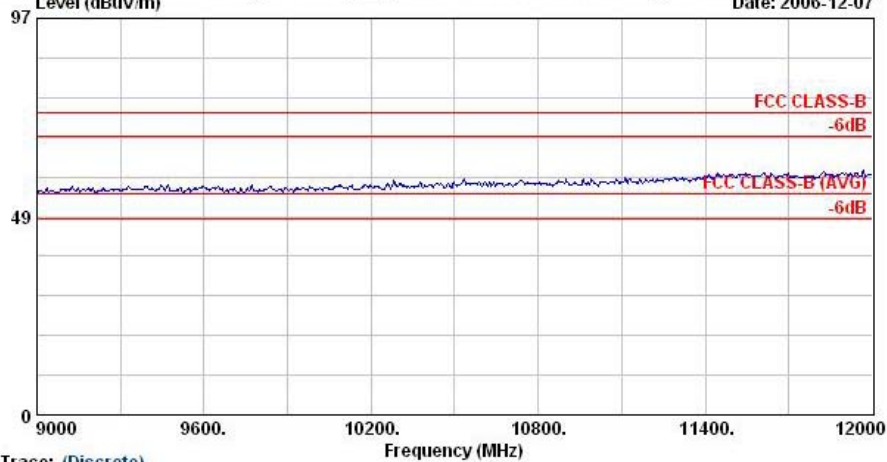

Trace: (Discrete)
 Site : 03CH06-HY
 Condition : HP-ANT-060410 VERTICAL
 EUT : PDA with GPRS/EDGE+WLAN 11g+BT
 Power : 120Vac/60Hz
 Model : FR 710210
 Memo : 11b Tx_Ch11_2462MHz
 Plane : E2
 Data Rate : 11

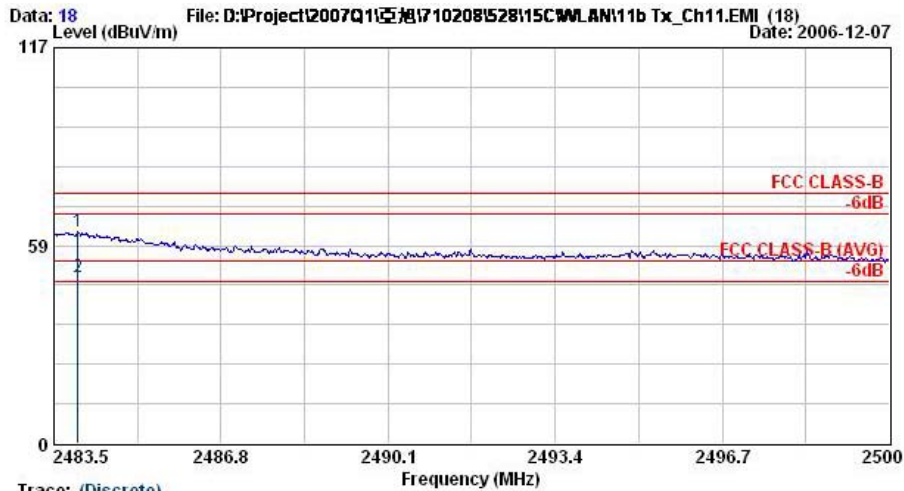

Trace: (Discrete)

Site : 08CH06-HY
Condition : HF-ANT-060410 VERTICAL
EUT : PDA with GPRS/EDGE+WLAN 11g+BT
Power : 120Vac/60Hz
Model : FR 710210
Memo : 11b Tx_Ch11;2462MHz
Flsue : E2
Data Rate : 11

	Freq	Level	Over Limit	Limit Line	Read Level	Antenna Factor	Cable Loss	Preamp Factor	Ant Pos	Table Pos	Remark
	MHz	dBuV/m	dB	dBuV/m	dBuV	dB/m	dB	dB	cm	deg	
1 @	2484.0	62.72	-11.28	74.00	64.08	30.29	3.86	35.51	100	0	Peak
2 @	2484.0	49.36	-4.64	54.00	50.72	30.29	3.86	35.51	100	214	Average

Remark: There is no more obvious spurious emission except the listings above.