



Specific Absorption Rate (SAR) Test Report
for
Psion Teklogix Inc.
on the
802.11b/g Wireless LAN CF Card

Report No. : FA710210-01-2-2-03
Trade Name : WORKABOUT PRO
Model Name : RA2041
FCC ID : GM37527RA2041
IC ID : 2739D-BGRADA
Date of Testing : Feb. 12, and May 07, 2007
Date of Report : May 11, 2007
Date of Review : May 11, 2007

- The test results refer exclusively to the presented test model / sample only.
- Without written approval of SPORTON International Inc., the test report shall not be reproduced except in full.
- Report Version: Rev. 04

SPORTON International Inc.

6F, No.106, Sec. 1, Hsin Tai Wu Rd., Hsi Chih, Taipei Hsien, Taiwan, R.O.C.



Table of Contents

- 1. Statement of Compliance** 1
- 2. Administration Data** 2
 - 2.1 Testing Laboratory 2
 - 2.2 Detail of Applicant 2
 - 2.3 Detail of Manufacturer 2
 - 2.4 Application Detail 2
- 3. Scope** 3
 - 3.1 Description of Device Under Test (DUT) 3
 - 3.2 Details of the modules 4
 - 3.3 Details of the Hosts 4
 - 3.4 Details of the Accessory 5
 - 3.5 Product Photo 6
 - 3.6 Applied Standards: 8
 - 3.7 Device Category and SAR Limits 9
 - 3.8 Test Conditions 9
 - 3.8.1 Ambient Condition: 9
 - 3.8.2 Test Configuration: 9
- 4. Specific Absorption Rate (SAR)** 10
 - 4.1 Introduction 10
 - 4.2 SAR Definition 10
- 5. SAR Measurement Setup** 11
 - 5.1 DASY4 E-Field Probe System 12
 - 5.1.1 ET3DV6 E-Field Probe Specification 13
 - 5.1.2 ET3DV6 E-Field Probe Calibration 13
 - 5.2 DATA Acquisition Electronics (DAE) 14
 - 5.3 Robot 15
 - 5.4 Measurement Server 15
 - 5.5 SAM Twin Phantom 15
 - 5.6 Data Storage and Evaluation 17
 - 5.6.1 Data Storage 17
 - 5.6.2 Data Evaluation 17
 - 5.7 Test Equipment List 20
- 6. Tissue Simulating Liquids** 21
- 7. Uncertainty Assessment** 23
- 8. SAR Measurement Evaluation** 25
 - 8.1 Purpose of System Performance check 25
 - 8.2 System Setup 25
 - 8.3 Validation Results 27
- 9. Description for DUT Testing Position** 28
- 10. Measurement Procedures** 36
 - 10.1 Spatial Peak SAR Evaluation 36
 - 10.2 Scan Procedures 37
 - 10.3 SAR Averaged Methods 37
- 11. SAR Test Results** 38
 - 11.1 Right Cheek 38
 - 11.2 Right Tilted 38
 - 11.3 Left Cheek 38
 - 11.4 Left Tilted 39
 - 11.5 Keypad Up with 1.5cm Gap 39
 - 11.6 Keypad Down with 1.5cm Gap 39
 - 11.7 Holster Left Side Touch 40
 - 11.8 Holster Right Side Touch 40
- 12. References** 41

Appendix A – System Performance Check Data



Appendix B – SAR Measurement Data
Appendix C – Calibration Data
Appendix D – GSM SAR Data



1. Statement of Compliance

The Specific Absorption Rate (SAR) maximum result found during testing for the **Psion Teklogix Inc. 802.11b/g Wireless LAN CF Card WORKABOUT PRO RA2041** on the PDA hosts **7527C / 7527S** Series are as follows (with expanded uncertainty 20.6%) :

	WLAN head (W/Kg)	WLAN body (W/Kg)
7527C Series	0.141	0.23
7527S Series	0.174	0.234

The co-location of GSM/GPRS, WLAN and Bluetooth on the hosts **7527C / 7527S** Series were also checked. It is in compliance with Specific Absorption Rate (SAR) for general population/uncontrolled exposure limits specified in FCC 47 CFR part 2 (2.1093) and ANSI/IEEE C95.1-1999 and RSS-102 Issued 2 and had been tested in accordance with the measurement methods and procedures specified in OET Bulletin 65 Supplement C (Edition 01-01) and IEEE 1528-2003.

Approved by

Roy Wu
Deputy Manager



2. Administration Data

2.1 Testing Laboratory

Company Name : Sporton International Inc.
Department : Antenna Design/SAR
Address : No.52, Hwa-Ya 1st RD., Hwa Ya Technology Park, Kwei-Shan Hsiang, TaoYuan
Hsien, Taiwan, R.O.C.
Telephone Number : 886-3-327-3456
Fax Number : 886-3-327-0973

2.2 Detail of Applicant

Company Name : Psion Teklogix Inc.
Address : 2100 Meadowvale Blvd., Mississauga, Ontario, L5N 7J9, Canada

2.3 Detail of Manufacturer

Company Name : ASKEY COMPUTER CORP.
Address : 10F, No. 119, Chienkang Rd., Chung-Ho, Taipei, Taiwan, R.O.C.

2.4 Application Detail

Date of reception of application: Jan. 02, 2007
Start of test : Feb. 12, 2007
End of test : May 07, 2007



3. Scope

3.1 Description of Device Under Test (DUT)

DUT Type :	802.11b/g Wireless LAN CF Card
Trade Name :	WORKABOUT PRO
Model Name :	RA2041
FCC ID :	GM37527RA2041
IC ID :	2739D-BGRADA
Tx Frequency :	2400 ~ 2483.5 MHz
Rx Frequency :	2400 ~ 2483.5 MHz
Number of Channels :	11
Carrier Frequency of Each Channel :	2412+(n-1)*5 MHz; n=1~11
Antenna Type :	PCB Antenna
Antenna Connector :	N/A
Antenna Gain :	-2.66 dBi (7527C) -2.48 dBi (7527S)
Maximum Output Power to Antenna :	See the table below for the details
Type of Modulation :	DSSS / OFDM
Application Type :	Certification

Test Hosts and the Embedded modules:

Maximum Output Power to Antenna			
Host	GSM850	PCS1900	Bluetooth
7527C Series	GSM: 31.54 dBm GPRS8: 31.50 dBm GPRS10: 29.95 dBm GPRS12: 27.60 dBm EDGE8: 29.60 dBm EDGE10: 27.40 dBm EDGE12: 23.10 dBm	GSM: 29.03 dBm GPRS8: 29.06 dBm GPRS10: 27.28 dBm GPRS12: 28.00 dBm EDGE8: 28.20 dBm EDGE10: 26.00 dBm EDGE12: 22.00 dBm	0.59 dBm
7527S Series	GSM: 31.53 dBm GPRS8: 31.57 dBm GPRS10: 29.98 dBm GPRS12: 27.60 dBm EDGE8: 29.50 dBm EDGE10: 27.40 dBm EDGE12: 23.30 dBm	GSM: 28.94 dBm GPRS8: 28.97 dBm GPRS10: 27.16 dBm GPRS12: 24.00 dBm EDGE8: 28.30 dBm EDGE10: 26.10 dBm EDGE12: 22.10 dBm	0.59 dBm



3.2 Details of the modules

Maximum Output Power to Antenna			
	Model Name	FCC ID	IC ID
GSM Radio	RA3030-G2	GM375273RADA	2739D-7527RADA
WLAN Radio	RA2041	GM37527RA2041	2739D-BGRADA
Bluetooth Radio	BTL040	GM37525BTB	2739D-7525BTB

3.3 Details of the Hosts

Product Feature & Specification	
DUT Type	Hand-held Micro-computer
Trade Name	WORKABOUT PRO
Model Name	7527C / 7527S Series
HW Version	7527C : ES3 7527S : ES2
SW Version	A
DUT Stage	Identical Prototype
Battery	WA3006

Remark: 7527S is the shorter version of model 7527C. They have the same RF modules and antenna. The only difference between the two models is the keypad.



3.4 Details of the Accessory

Terminal Options

		Model Number	Part Number	Remark
GSM	Quad-band MC75 GSM Radio with Stubby antenna	RA3030-G2	N/A	
Kit	Blackroc Endcap Kit 3-Port (RS232,TTL,IRDA); kit	BR1000-G1	1050812	Endcap 7
802.11g	802.11g CF Radio	RA2041	N/A	
Endcap with GSM	Imager, 2D HHP 5180 Endcap with GSM antenna	WA8110-G1	1050830	Endcap 5
	Imager, 1D EV15 Endcap, with GSM antenna	WA9113-G1	1050778	Endcap 1
	Scanner, 1D SE955 Endcap, with GSM antenna	WA9112-G1	1050491	Endcap 2
Endcap	Imager, 2D HHP 5180 Endcap	WA8010-G1	1050890	Endcap 6
	Imager, 1D Intermec EV15 Endcap	WA9103-G1	1050777	Endcap 3
	Scanner, 1D SE955 Endcap	WA9102-G1	1050492	Endcap 4
POD	Imager, 1D Intermec EV15 Pod	WA9003-G1	1050462	POD 1
	Scanner, 1D SE955 Pod	WA9002-G1	1050230	POD 2
	Scanner, 1D SE1223HP Pod	WA9000-G1	1050229	POD 3
	Imager, SX5393 Slim Pod	WA9007-G1	1050773	POD 5
	Scanner, 1D SE1223LR Pod	WA9005-G1	1051025	POD 4
	Imager, 2D HHP 5180 Pod	WA9012-G1	1050865	POD 6

Docks and Connectivity Options

Docking	Desktop Docking Station	WA4003-G2	1050955	Docking 1
	USB Cable	N/A	N/A	USB 1
	Vehicle Cradle - Powered 12V with Port Replicator	WA4005-G1 (port replicator)	1080224 (port replicator)	
	Cigarette light adaptor	WA3113-G2	1050463-001	
	Standalone Power Supply	PS1050-G1	1050465	
USB	USB to Ethernet adaptor module	WA4010-G1	1050236	USB 2
	USB to RS232 adaptor module	WA4015-G1	1050067-300	USB 3
Tether	Tether to Ethernet adaptor module	WA4025	1050255	USB 5
	Tether adaptor cable (for connecting keyboards)	WA1001	1050551	USB 4

Others

Battery	3000mAh	WA3006		B2
	4000mAh	WA3010	1050192	B3
Holster	Soft Shell Holster	WA6050	1030227	C1
Pistol Grips	Pistol Grip Symbol SE1223 Scanner	WA6001-G1	1050460	C2

Remark: USB Cable comes in the box as part of the Docking Station WA4003-G2.



3.5 Product Photo
7527C



7527S





Holster





3.6 Applied Standards:

The Specific Absorption Rate (SAR) testing specification, method and procedure for this 802.11b/g Wireless LAN CF Card is in accordance with the following standards:

RSS-102 Issued 2 (2005),
47 CFR Part 2 (2.1093),
IEEE C95.1-1999,
IEEE C95.3-2002,
IEEE P1528 -2003, and
OET Bulletin 65 Supplement C (Edition 01-01)



3.7 Device Category and SAR Limits

This device belongs to portable device category because its radiating structure is allowed to be used within 20 centimeters of the body of the user.

Limit for General Population/Uncontrolled exposure should be applied for this device, it is 1.6 W/kg as averaged over any 1 gram of tissue.

3.8 Test Conditions

3.8.1 Ambient Condition:

Item	HSL_2450 2/12	HSL_2450 5/7	MSL_2450 2/12	MSL_2450 5/7
Ambient Temperature ()	20-24			
Tissue simulating liquid temperature ()	20.8	21.7	21	21.0
Humidity (%)	<60			

3.8.2 Test Configuration:

The data rates for SAR testing are 11Mbps for 802.11b and 6Mbps for 802.11g. Engineering testing software installed on the EUT can provide continuous transmitting RF signal. This RF signal utilized in SAR measurement has almost 100% duty cycle and its crest factor is 1. The measurements were performed on the lowest, middle, and highest channel, i.e. channel 1, channel 6, and channel 11 for each testing position. However, measurements were performed only on the middle channel if the SAR is below 3 dB of limit.



4. Specific Absorption Rate (SAR)

4.1 Introduction

SAR is related to the rate at which energy is absorbed per unit mass in an object exposed to a radio field. The SAR distribution in a biological body is complicated and is usually carried out by experimental techniques or numerical modeling. The FCC recommends limits for two tiers of groups, occupational/controlled and general population/uncontrolled, based on a person’s awareness and ability to exercise control over his or her exposure. In general, occupational/controlled exposure limits are higher than the limits for general population/uncontrolled.

4.2 SAR Definition

The SAR definition is the time derivative (rate) of the incremental energy (dW) absorbed by (dissipated in) an incremental mass (dm) contained in a volume element (dv) of a given density.

). The equation description is as below:

$$\mathbf{SAR} = \frac{d}{dt} \left(\frac{dW}{dm} \right) = \frac{d}{dt} \left(\frac{dW}{\rho dv} \right)$$

SAR is expressed in units of Watts per kilogram (W/kg)

SAR measurement can be either related to the temperature elevation in tissue by

$$\mathbf{SAR} = C \frac{\delta T}{\delta t}$$

, where C is the specific head capacity, δT is the temperature rise and δt the exposure duration,

or related to the electrical field in the tissue by

$$\mathbf{SAR} = \frac{\sigma |E|^2}{\rho}$$

, where σ is the conductivity of the tissue, ρ is the mass density of the tissue and E is the rms electrical field strength.

However for evaluating SAR of low power transmitter, electrical field measurement is typically applied.

5. SAR Measurement Setup

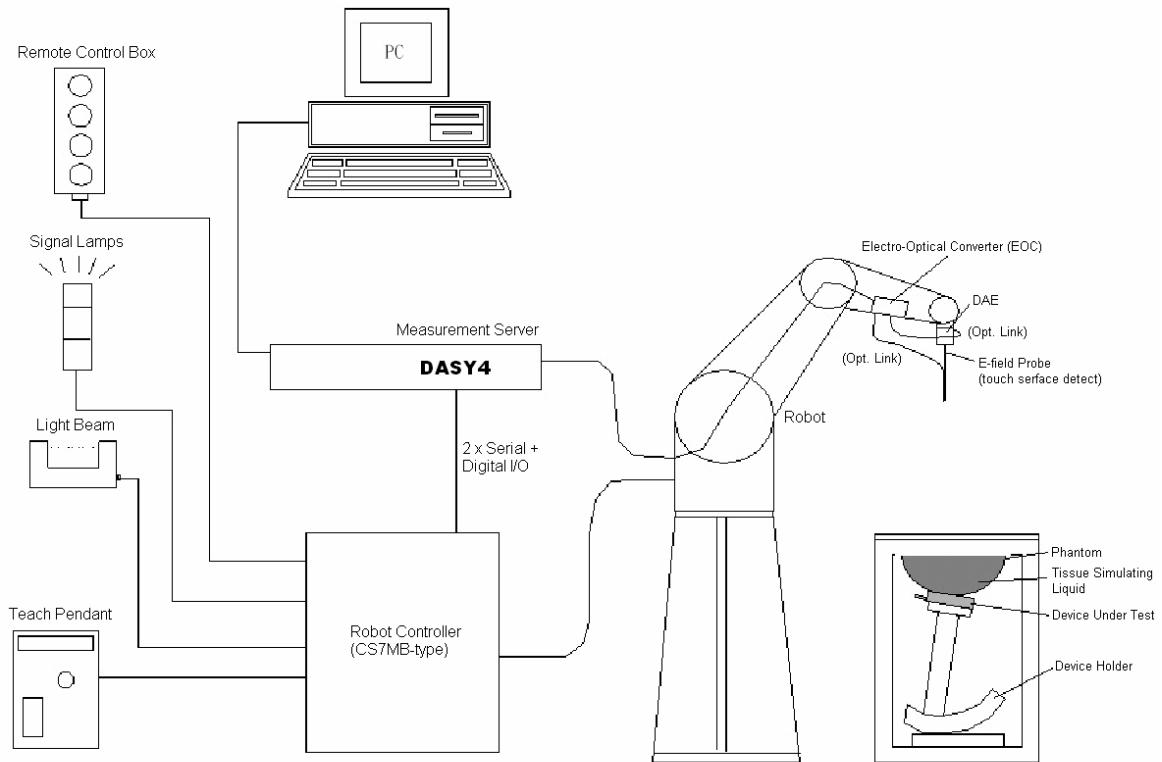

Fig. 5.1 DASY4 system



The DASY4 system for performance compliance tests is illustrated above graphically. This system consists of the following items:

- A standard high precision 6-axis robot with controller, a teach pendant and software
- A data acquisition electronic (DAE) attached to the robot arm extension
- A dosimetric probe equipped with an optical surface detector system
- The electro-optical converter (ECO) performs the conversion between optical and electrical signals
- A measurement server performs the time critical tasks such as signal filtering, control of the robot operation and fast movement interrupts.
- A probe alignment unit which improves the accuracy of the probe positioning
- A computer operating Windows XP
- DASY4 software
- Remove control with teach pendant and additional circuitry for robot safety such as warning lamps, etc.
- The SAM twin phantom
- A device holder
- Tissue simulating liquid
- Dipole for evaluating the proper functioning of the system

Some of the components are described in details in the following sub-sections.

5.1 DASY4 E-Field Probe System

The SAR measurement is conducted with the dosimetric probe ET3DV6 (manufactured by SPEAG). The probe is specially designed and calibrated for use in liquid with high permittivity. The dosimetric probe has special calibration in liquid at different frequency. This probe has a built in optical surface detection system to prevent from collision with phantom.

5.1.1 ET3DV6 E-Field Probe Specification

Construction	Symmetrical design with triangular core Built-in optical fiber for surface detection system Built-in shielding against static charges PEEK enclosure material (resistant to organic solvents)
Calibration	Simulating tissue at frequencies of 900MHz, 1.8GHz and 2.45GHz for brain and muscle (accuracy $\pm 8\%$)
Frequency	10 MHz to > 3 GHz
Directivity	± 0.2 dB in brain tissue (rotation around probe axis) ± 0.4 dB in brain tissue (rotation perpendicular to probe axis)
Dynamic Range	5μ W/g to > 100mW/g; Linearity: ± 0.2 dB
Surface Detection	± 0.2 mm repeatability in air and clear liquids on reflecting surface
Dimensions	Overall length: 330mm Tip length: 16mm Body diameter: 12mm Tip diameter: 6.8mm Distance from probe tip to dipole centers: 2.7mm
Application	General dosimetry up to 3GHz Compliance tests for mobile phones and Wireless LAN Fast automatic scanning in arbitrary phantoms



Fig. 5.2 Probe setup on robot

5.1.2 ET3DV6 E-Field Probe Calibration

Each probe needs to be calibrated according to a dosimetric assessment procedure with accuracy better than $\pm 10\%$. The spherical isotropy shall be evaluated and within ± 0.25 dB. The sensitivity parameters (NormX, NormY, and NormZ), the diode compression parameter (DCP) and the conversion factor (ConvF) of the probe are tested. The calibration data are as below:



ET3DV6 sn1787

Sensitivity	X axis : 1.57 μ V	Y axis : 1.71 μ V	Z axis : 2.09 μ V	
Diode compression point	X axis : 94 mV	Y axis : 94 mV	Z axis : 94 mV	
Conversion factor (Body)	Frequency (MHz)	X axis	Y axis	Z axis
	2350~2550	4.13	4.13	4.13
Boundary effect (Body)	Frequency (MHz)	Alpha	Depth	
	2350~2550	0.62	2.13	

ET3DV6 sn1788

Sensitivity	X axis : 1.73 μ V	Y axis : 1.67 μ V	Z axis : 1.70 μ V	
Diode compression point	X axis : 95 mV	Y axis : 101 mV	Z axis : 93 mV	
Conversion factor (Head / Body)	Frequency (MHz)	X axis	Y axis	Z axis
	2350~2550	4.66 / 4.11	4.66 / 4.11	4.66 / 4.11
Boundary effect (Head / Body)	Frequency (MHz)	Alpha	Depth	
	2350~2550	0.68 / 0.60	1.96 / 1.70	

NOTE: The probe parameters have been calibrated by the SPEAG.

5.2 DATA Acquisition Electronics (DAE)

The data acquisition electronics (DAE4) consists of a highly sensitive electrometer-grade preamplifier with auto-zeroing, a channel and gain-switching multiplexer, a fast 16 bit AD-converter and a command decoder and control logic unit. Transmission to the measurement server is accomplished through an optical downlink for data and status information as well as an optical uplink for commands and the clock.

The mechanical probe mounting device includes two different sensor systems for frontal and sideways probe contacts. They are used for mechanical surface detection and probe collision detection.

The input impedance of the DAE4 is 200M Ohm; the inputs are symmetrical and floating. Common mode rejection is above 80dB.



5.3 Robot

The DASY4 system uses the high precision robots RX90BL type out of the newer series from Stäubli SA (France). For the 6-axis controller DASY4 system, the CS7MB robot controller version from Stäubli is used. The RX robot series have many features that are important for our application:

- High precision (repeatability 0.02 mm)
- High reliability (industrial design)
- Jerk-free straight movements
- Low ELF interference (the closed metallic construction shields against motor control fields)
- 6-axis controller

5.4 Measurement Server

The DASY4 measurement server is based on a PC/104 CPU board with
166 MHz CPU
32 MB chipset and
64 MB RAM.

Communication with
the DAE4 electronic box
the 16-bit AD-converter system for optical detection and digital I/O interface.

The measurement server performs all the real-time data evaluation for field measurements and surface detection, controls robot movements and handles safety operations.

5.5 SAM Twin Phantom

The SAM twin phantom is a fiberglass shell phantom with 2mm shell thickness (except the ear region where shell thickness increases to 6mm). It has three measurement areas:

- Left head
- Right head
- Flat phantom

The bottom plate contains three pair of bolts for locking the device holder. The device holder positions are adjusted to the standard measurement positions in the three sections.



A white cover is provided to tap the phantom during off-periods to prevent water evaporation and changes in the liquid parameters.

On the phantom top, three reference markers are provided to identify the phantom position with respect to the robot.

The phantom can be used with the following tissue simulating liquids:

- *Water-sugar based liquid
- *Glycol based liquids

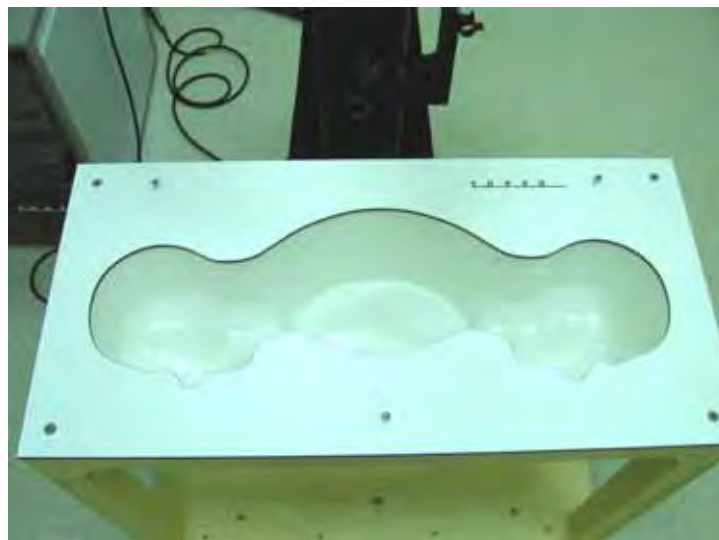

Fig. 5.3 Top view of twin phantom



Fig. 5.4 Bottom view of twin phantom



5.6 Data Storage and Evaluation

5.6.1 Data Storage

The DASY4 software stores the assessed data from the data acquisition electronics as raw data (in microvolt readings from the probe sensors), together with all the necessary software parameters for the data evaluation (probe calibration data, liquid parameters and device frequency and modulation data) in measurement files with the extension .DA4. The postprocessing software evaluates the desired unit and format for output each time the data is visualized or exported. This allows verification of the complete software setup even after the measurement and allows correction of erroneous parameter settings. For example, if a measurement has been performed with an incorrect crest factor parameter in the device setup, the parameter can be corrected afterwards and the data can be reevaluated.

The measured data can be visualized or exported in different units or formats, depending on the selected probe type (e.g., [V/m], [A/m], [mW/g]). Some of these units are not available in certain situations or give meaningless results, e.g., a SAR-output in a loseless media, will always be zero. Raw data can also be exported to perform the evaluation with other software packages.

5.6.2 Data Evaluation

The DASY4 postprocessing software (SEMCAD) automatically executes the following procedures to calculate the field units from the microvolt readings at the probe connector. The parameters used in the evaluation are stored in the configuration modules of the software :

Probe parameters :	- Sensitivity	Norm _i , a _{i0} , a _{i1} , a _{i2}
	- Conversion factor	ConvF _i
	- Diode compression point	dcp _i
Device parameters :	- Frequency	f
	- Crest factor	cf
Media parameters :	- Conductivity	
	- Density	

These parameters must be set correctly in the software. They can be found in the component documents or they can be imported into the software from the configuration files issued for the DASY components. In the direct measuring mode of the multimeter option, the parameters of the actual system setup are used. In the scan visualization and export modes, the parameters stored in the corresponding document files are used.

The first step of the evaluation is a linearization of the filtered input signal to account for the compression characteristics of the detector diode. The compensation depends on the input signal, the diode type and the DC-transmission factor from the diode to the evaluation electronics. If the exciting field is pulsed, the crest factor of the signal must be known to correctly compensate for peak power. The formula for each channel



can be given as :

$$V_i = U_i + U_i^2 \cdot \frac{cf}{dcp_i}$$

with $V_i =$ compensated signal of channel i ($i = x, y, z$)
 $U_i =$ input signal of channel i ($i = x, y, z$)
 $cf =$ crest factor of exciting field (DASY parameter)
 $dcp_i =$ diode compression point (DASY parameter)

From the compensated input signals, the primary field data for each channel can be evaluated :

E-field probes : $E_i = \sqrt{\frac{V_i}{Norm_i ConvF}}$

H-field probes : $H_i = \sqrt{V_i \frac{a_{i0} + a_{i1}f + a_{i2}f^2}{f}}$

with $V_i =$ compensated signal of channel i ($i = x, y, z$)
 $Norm_i =$ sensor sensitivity of channel i ($i = x, y, z$)
 $\mu V/(V/m)^2$ for E-field Probes
 $ConvF =$ sensitivity enhancement in solution
 $a_{ij} =$ sensor sensitivity factors for H-field probes
 $f =$ carrier frequency [GHz]
 $E_i =$ electric field strength of channel i in V/m
 $H_i =$ magnetic field strength of channel i in A/m

The RSS value of the field components gives the total field strength (Hermitian magnitude) :

$$E_{tot} = \sqrt{E_x^2 + E_y^2 + E_z^2}$$

The primary field data are used to calculate the derived field units.

$$SAR = E_{tot}^2 \cdot \frac{\sigma}{\rho \cdot 1000}$$

with $SAR =$ local specific absorption rate in mW/g
 $E_{tot} =$ total field strength in V/m
 $\sigma =$ conductivity in [mho/m] or [Siemens/m]
 $\rho =$ equivalent tissue density in g/cm³



* Note that the density is set to 1, to account for actual head tissue density rather than the density of the tissue simulating liquid.

The power flow density is calculated assuming the excitation field to be a free space field.

$$P_{pwe} = \frac{E_{tot}^2}{3770} \quad \text{or} \quad P_{pwe} = H_{tot}^2 \cdot 37.7$$

with P_{pwe} = equivalent power density of a plane wave in mW/cm²
 E_{tot} = total electric field strength in V/m
 H_{tot} = total magnetic field strength in A/m



5.7 Test Equipment List

Manufacture	Name of Equipment	Type/Model	Serial Number	Calibration	
				Last Cal.	Due Date
SPEAG	Dosimetric E-Filed Probe	ET3DV6	1788	Sep 19, 2006	Sep. 19, 2007
SPEAG	2450MHz System Validation Kit	D2450V2	736	Jul. 12, 2005	Jul. 12, 2007
SPEAG	Data Acquisition Electronics	DAE3	577	Nov. 21, 2006	Nov. 21, 2007
SPEAG	Device Holder	N/A	N/A	NCR	NCR
SPEAG	Phantom	QD 000 P40 C	TP-1150	NCR	NCR
SPEAG	Robot	Staubli RX90BL	F03/5W15A1/A/01	NCR	NCR
SPEAG	Software	DASY4 V4.7 Build 53	N/A	NCR	NCR
SPEAG	Software	SEMCAD V1.8 Build 172	N/A	NCR	NCR
SPEAG	Measurement Server	SE UMS 001 BA	1021	NCR	NCR
Agilent	ENA series Network Analyzer	E5071C	MY42403579	Feb. 21, 2007	Feb. 21, 2008
Agilent	Dielectric Probe Kit	85070D	US01440205	NCR	NCR
Agilent	Dual Directional Coupler	778D	50422	NCR	NCR
Agilent	Power Amplifier	8449B	3008A01917	NCR	NCR
R&S	Radio Communication Tester	CMU200	105513	Jul. 25, 2006	Jul. 25, 2007
Agilent	Power Meter	E4416A	GB41292344	Feb. 08, 2007	Feb. 08, 2008
Agilent	Power Sensor	E9327A	US40441548	Feb. 08, 2007	Feb. 08, 2008
Agilent	Signal Generator	E8247C	MY43320596	Mar. 01, 2006	Mar. 01, 2008

Table 5.1 Test Equipment List



6. Tissue Simulating Liquids

For the measurement of the field distribution inside the SAM phantom with DAS4, the phantom must be filled with around 25 liters of homogeneous body tissue simulating liquid. The liquid height from the bottom of the phantom body is 15.2 centimeters, which is shown in Fig. 6.1.

The following ingredients for tissue simulating liquid are used:

- **Water:** deionized water (pure H₂O), resistivity 16M - as basis for the liquid
- **Sugar:** refined sugar in crystals, as available in food shops – to reduce relative permittivity
- **Salt:** pure NaCl – to increase conductivity
- **Cellulose:** Hydroxyethyl-cellulose, medium viscosity (75-125 mPa.s, 2% in water, 20°C), CAS#54290-to increase viscosity and to keep sugar in solution.
- **Preservative:** Preventol D-7 Bayer AG, D-51368 Leverkusen, CAS#55965-84-9- to prevent the spread of bacteria and molds.
- **DGMBE:** Deithlenglycol-monobuthyl ether (DGMBE), Fluka Chemie GmbH, CAS#112-34-5 – to reduce relative permittivity.

Table 6.1 gives the recipes for one liter of tissue simulating liquid for frequency band 2450 MHz.

Ingredient	HSL-2450	MSL-2450
Water	450.0 ml	698.3 ml
DGMBE	550.0 ml	301.7 ml
Total amount	1 liter (1.0 kg)	1 liter (1.0 kg)
Dielectric Parameters at 22°	f = 2450MHz ε _r = 39.2±5%, σ = 1.8±5% S/m	f = 2450MHz ε _r = 52.7±5%, σ = 1.95±5% S/m

Table 6.1

The dielectric parameters of the liquids were verified prior to the SAR evaluation using an Agilent 85070D Dielectric Probe Kit and an Agilent Network Analyzer.

Table 6.2 shows the measuring results for muscle simulating liquid.

	Bands	Frequency(MHz)	Permittivity (ϵ_r)	Conductivity (σ)	Measurement Date
Head	2450 MHz	2412	38.6	1.73	May 07, 2007
		2437	38.2	1.74	
		2462	38.0	1.78	
Body	2450 MHz	2412	52.7	1.90	Feb. 12, 2007
		2437	52.7	1.94	
		2462	52.6	1.97	
Head	2450 MHz	2412	40.1	1.76	May 07, 2007
		2437	39.8	1.81	
		2462	39.5	1.87	
Body	2450 MHz	2412	53.0	1.91	May 07, 2007
		2437	53.0	1.95	
		2462	52.9	1.97	

Table 6.2

The measuring data are consistent with $\epsilon_r = 39.2 \pm 5\%$ and $\sigma = 1.80 \pm 5\%$ for head 2450 band and $\epsilon_r = 52.7 \pm 5\%$ and $\sigma = 1.95 \pm 5\%$ for body 2450 band.

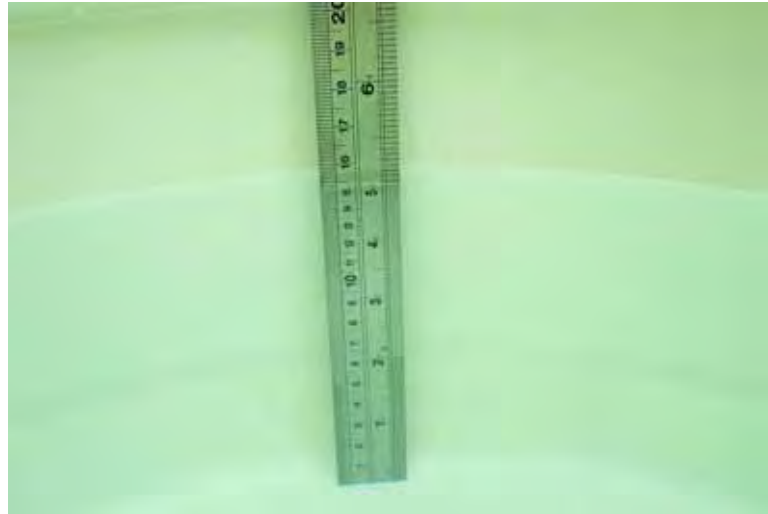

Fig. 6.1



7. Uncertainty Assessment

The component of uncertainty may generally be categorized according to the methods used to evaluate them. The evaluation of uncertainty by the statistical analysis of a series of observations is termed a Type A evaluation of uncertainty. The evaluation of uncertainty by means other than the statistical analysis of a series of observation is termed a Type B evaluation of uncertainty. Each component of uncertainty, however evaluated, is represented by an estimated standard deviation, termed standard uncertainty, which is determined by the positive square root of the estimated variance.

A Type A evaluation of standard uncertainty may be based on any valid statistical method for treating data. This includes calculating the standard deviation of the mean of a series of independent observations; using the method of least squares to fit a curve to the data in order to estimate the parameter of the curve and their standard deviations; or carrying out an analysis of variance in order to identify and quantify random effects in certain kinds of measurement.

A type B evaluation of standard uncertainty is typically based on scientific judgment using all of the relevant information available. These may include previous measurement data, experience and knowledge of the behavior and properties of relevant materials and instruments, manufacture’s specification, data provided in calibration reports and uncertainties assigned to reference data taken from handbooks. Broadly speaking, the uncertainty is either obtained from an outdoor source or obtained from an assumed distribution, such as the normal distribution, rectangular or triangular distributions indicated in Table 7.1

Uncertainty Distributions	Normal	Rectangular	Triangular	U-shape
Multiplying factor ^(a)	1/k ^(b)	1/ 3	1/ 6	1/ 2

(a) standard uncertainty is determined as the product of the multiplying factor and the estimated range of variations in the measured quantity

(b) is the coverage factor

Table 7.1

The combined standard uncertainty of the measurement result represents the estimated standard deviation of the result. It is obtained by combining the individual standard uncertainties of both Type A and Type B evaluation using the usual “root-sum-squares” (RSS) methods of combining standard deviations by taking the positive square root of the estimated variances.

Expanded uncertainty is a measure of uncertainty that defines an interval about the measurement result within which the measured value is confidently believed to lie. It is obtained by multiplying the combined standard uncertainty by a coverage factor. Typically, the coverage factor ranges from 2 to 3. Using a coverage factor allows the true value of a measured quantity to be specified with a defined probability within the specified uncertainty range. For purpose of this document, a coverage factor two is used, which corresponds to confidence interval of about 95 %. The DASY4 uncertainty Budget is showed in Table 7.2.



Error Description	Uncertainty Value \pm %	Probability Distribution	Divisor	C_i I_g	Standard Unc. (1-g)	v_i or V_{eff}
Measurement System						
Probe Calibration	± 4.8	Normal	1	1	± 4.8	
Axial Isotropy	± 4.7	Rectangular	$\sqrt{3}$	0.7	± 1.9	
Hemispherical Isotropy	± 9.6	Rectangular	$\sqrt{3}$	0.7	± 3.9	
Boundary Effect	± 1.0	Rectangular	$\sqrt{3}$	1	± 0.6	
Linearity	± 4.7	Rectangular	$\sqrt{3}$	1	± 2.7	
System Detection Limit	± 1.0	Rectangular	$\sqrt{3}$	1	± 0.6	
Readout Electronics	± 1.0	Normal	1	1	± 1.0	
Response Time	± 0.8	Rectangular	$\sqrt{3}$	1	± 0.5	
Integration time	± 2.6	Rectangular	$\sqrt{3}$	1	± 1.5	
RF Ambient Conditions	± 3.0	Rectangular	$\sqrt{3}$	1	± 1.7	
Probe Positioner Mech. Tolerance	± 0.4	Rectangular	$\sqrt{3}$	1	± 0.2	
Probe Positioning with respect to Phantom Shell	± 2.9	Rectangular	$\sqrt{3}$	1	± 1.7	
Extrapolation and Interpolation Algorithms for Max. SAR Evaluation	± 1.0	Rectangular	$\sqrt{3}$	1	± 0.6	
Test sample Related						
Test sample Positioning	± 2.9	Normal	1	1	± 2.9	145
Device Holder Uncertainty	± 3.6	Normal	1	1	± 3.6	5
Output Power Variation-SAR drift measurement	± 5.0	Rectangular	$\sqrt{3}$	1	± 2.9	
Phantom and Setup						
Phantom uncertainty(Including shape and thickness tolerances)	± 4.0	Rectangular	$\sqrt{3}$	1	± 2.3	
Liquid Conductivity Target tolerance	± 5.0	Rectangular	$\sqrt{3}$	0.64	± 1.8	
Liquid Conductivity measurement uncertainty	± 2.5	Normal	1	0.64	± 1.6	
Liquid Permittivity Target tolerance	± 5.0	Rectangular	$\sqrt{3}$	0.6	± 1.7	
Liquid Permittivity measurement uncertainty	± 2.5	Normal	1	0.6	± 1.5	
Combined standard uncertainty					± 10.3	330
Coverage Factor for 95 %		<u>K=2</u>				
Expanded uncertainty (Coverage factor = 2)			Normal (k=2) 27		± 20.6	

Table 7.2 Uncertainty Budget of DASY

8. SAR Measurement Evaluation

Each DASY system is equipped with one or more system validation kits. These units, together with the predefined measurement procedures within the DASY software, enable the user to conduct the system performance check and system validation. System validation kit includes a dipole, tripod holder to fix it underneath the flat phantom and a corresponding distance holder.

8.1 Purpose of System Performance check

The system performance check verifies that the system operates within its specifications. System and operator errors can be detected and corrected. It is recommended that the system performance check be performed prior to any usage of the system in order to guarantee reproducible results. The system performance check uses normal SAR measurements in a simplified setup with a well characterized source. This setup was selected to give a high sensitivity to all parameters that might fail or vary over time. The system check does not intend to replace the calibration of the components, but indicates situations where the system uncertainty is exceeded due to drift or failure.

8.2 System Setup

In the simplified setup for system evaluation, the DUT is replaced by a calibrated dipole and the power source is replaced by a continuous wave which comes from a signal generator at frequency 2450 MHz. The calibrated dipole must be placed beneath the flat phantom section of the SAM twin phantom with the correct distance holder. The distance holder should touch the phantom surface with a light pressure at the reference marking and be oriented parallel to the long side of the phantom. The equipment setup is shown below:

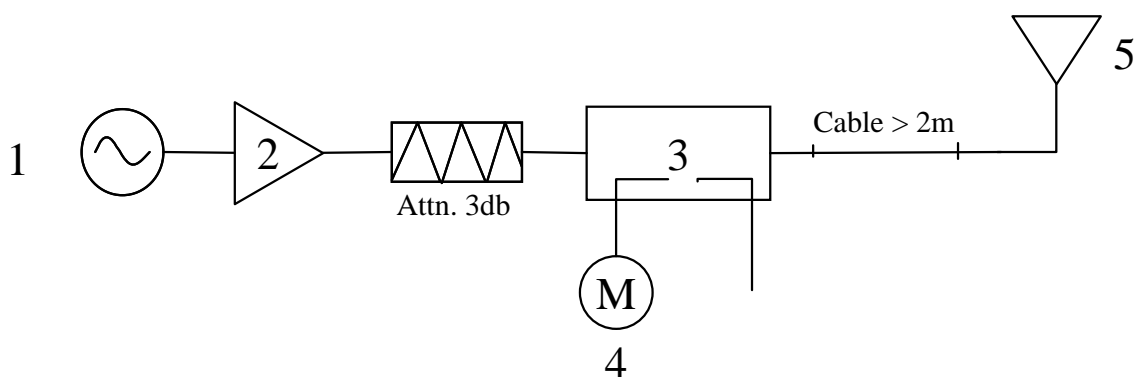

Fig. 8.1



1. Signal Generator
2. Amplifier
3. Directional Coupler
4. Power Meter
5. 2450 MHz Dipole

The output power on dipole port must be calibrated to 100 mW (20 dBm) before dipole is connected.



Fig 8.2 Dipole Setup



8.3 Validation Results

Comparing to the original SAR value provided by Speag, the validation data should within its specification of 10 %. Table 8.1 shows the target SAR and measured SAR after normalized to 1W input power.

			Target (W/kg)	Measurement data (W/kg)	Variation	Measurement date
Head	ISM band (2450 MHz)	SAR (1g)	52.8	54	2.3 %	May 07, 2007
		SAR (10g)	24.7	25.5	3.2 %	
Body	ISM band (2450 MHz)	SAR (1g)	52.8	50.1	-5.1 %	Feb. 12, 2007
		SAR (10g)	24.5	23.4	-4.5 %	
Head	ISM band (2450 MHz)	SAR (1g)	52.8	56.6	7.2 %	May 07, 2007
		SAR (10g)	24.7	26.7	8.1 %	
Body	ISM band (2450 MHz)	SAR (1g)	52.8	52.9	0.2 %	May 07, 2007
		SAR (10g)	24.5	25	2.0 %	

Table 8.1

The table above indicates the system performance check can meet the variation criterion.



9. Description for DUT Testing Position

This DUT was tested in 6 different positions. They are left cheek, left tilted, right cheek, right tilted, body worn with keypad up and body worn with keypad down as illustrated below:

- 1) “Cheek Position”
 - i) To position the device with the vertical center line of the body of the device and the horizontal line crossing the center piece in a plane parallel to the sagittal plane of the phantom. While maintaining the device in this plane, align the vertical center line with the reference plane containing the three ear and mouth reference point (M, RE and LE) and align the center of the ear piece with the line RE-LE.
 - ii) To move the device towards the phantom with the ear piece aligned with the line LE-RE until the phone touched the ear. While maintaining the device in the reference plane and maintaining the phone contact with the ear, move the bottom of the phone until any point on the front side is in contact with the cheek of the phantom or until contact with the ear is lost (see Fig. 9.1).
- 2) “Tilted Position”
 - i) To position the device in the “cheek” position described above.
 - ii) While maintaining the device the reference plane described above and pivoting against the ear, move it outward away from the mouth by an angle of 15 degrees or until contact with the ear is lost (see Fig. 9.2).
- 3) “Body Worn”
 - i) To position the device parallel to the phantom surface.
 - ii) To adjust the phone parallel to the flat phantom.
 - iii) To adjust the distance between the EUT surface and the flat phantom to 1.5 cm or the Holster surface and the flat phantom to 0 cm.

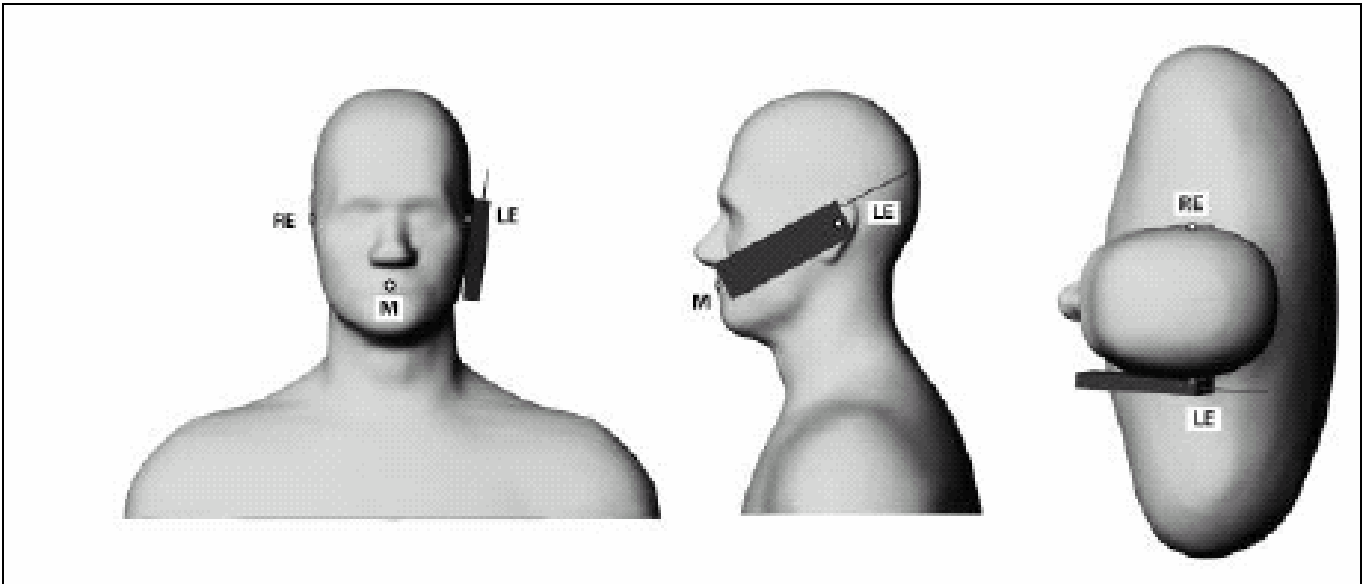

Fig. 9.1 Phone Position 1, “Cheek” or “Touch” Position. The reference points for the right ear (RE), left ear (LE) and mouth (M), which define the plane for phone positioning, are indicated.

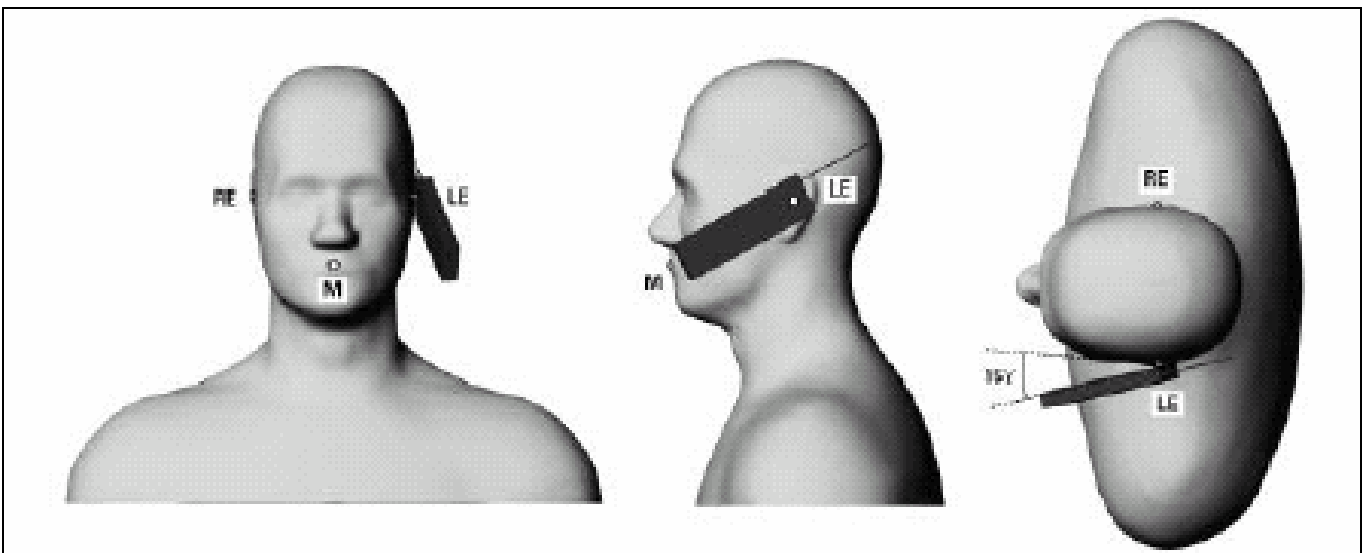

Fig. 9.2 Phone Position 2, “Tilted Position”. The reference point for the right ear (RE), left ear (LE) and mouth (M), which define the plane for phone positioning, are indicated.



Fig. 9.3 Right Cheek for 7527C



Fig. 9.4 Right Tilted for 7527C



Fig. 9.5 Left Cheek for 7527C

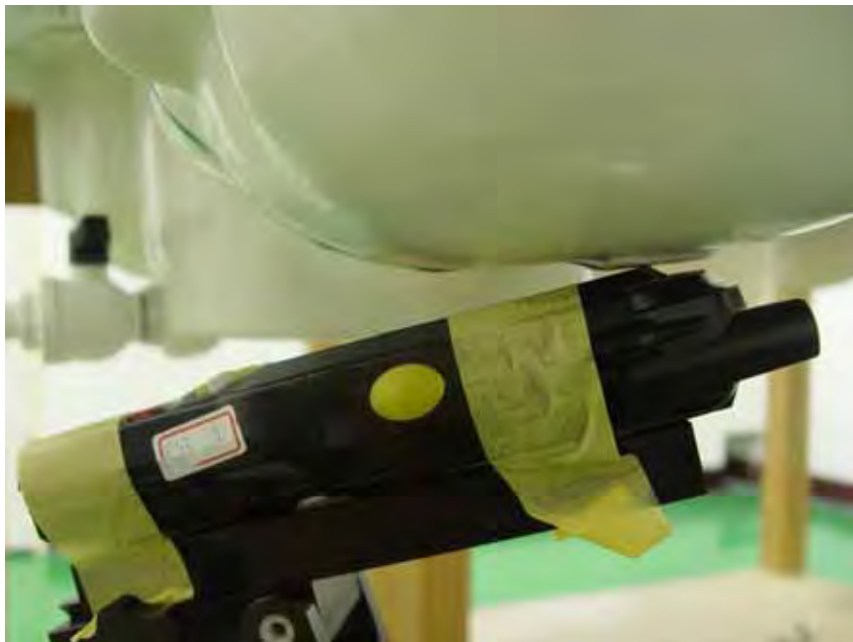

Fig. 9.6 Left Tilted for 7527C



Fig. 9.7 Right Cheek for 7527S

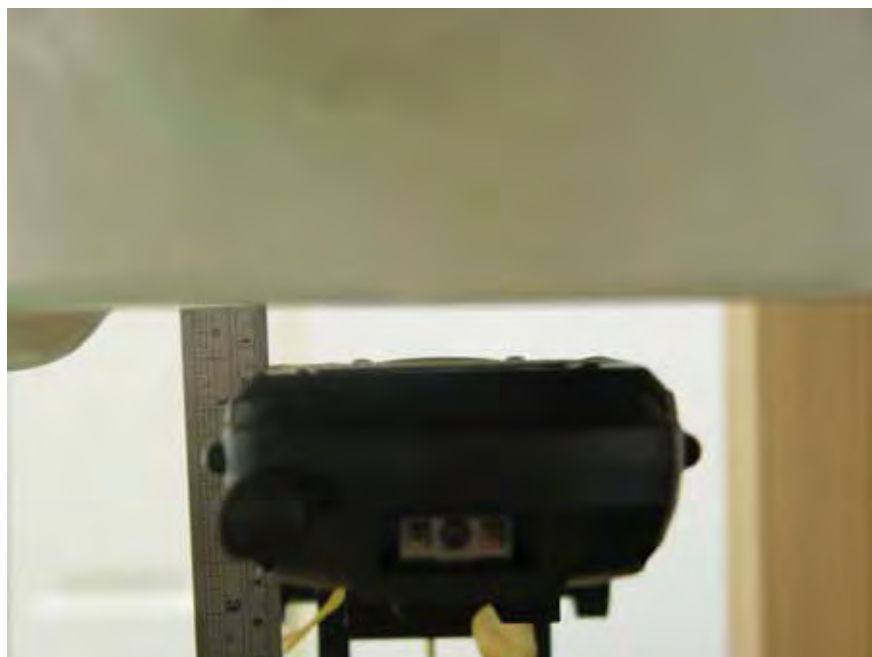

Fig. 9.8 Keypad Up with 1.5cm Gap for 7527C



Fig. 9.9 Keypad Down with 1.5cm Gap for 7527C

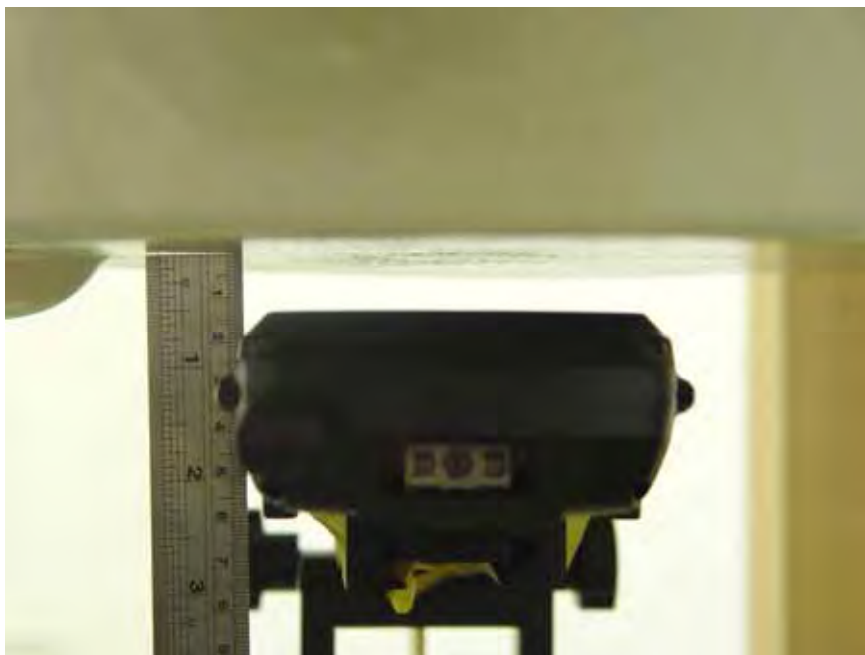

Fig. 9.10 Keypad Up with 1.5cm Gap for 7527S



Fig. 9.11 Holster Left Side Touch for 7527C



Fig. 9.12 Holster Right Side Touch for 7527C



Fig. 9.13 Holster Left Side Touch for 7527S



Fig. 9.14 Holster Right Side Touch for 7527S



10. Measurement Procedures

The measurement procedures are as follows:

- Using engineering software to transmit RF power continuously (continuous Tx) in the middle channel
- Placing the DUT in the positions described in the last section
- Setting scan area, grid size and other setting on the DASY4 software
- Taking data for the low channel
- Repeat the previous steps for the low and high channels.

According to the IEEE P1528 draft standard, the recommended procedure for assessing the peak spatial-average SAR value consists of the following steps:

- Power reference measurement
- Area scan
- Zoom scan
- Power reference measurement

10.1 Spatial Peak SAR Evaluation

The procedure for spatial peak SAR evaluation has been implemented according to the IEEE1528-2003 standard. It can be conducted for 1g and 10g, as well as for user-specific masses. The DASY4 software includes all numerical procedures necessary to evaluate the spatial peak SAR value.

Base on the Draft: SCC-34, SC-2, WG-2-Computational Dosimetry, P1528/D1.2 (Recommended Practice for Determining the Peak Spatial-Average Specific Absorption Rate (SAR) in the Human Head from Wireless Communications Devices: Measurement Techniques), a new algorithm has been implemented. The spatial-peak SAR can be computed over any required mass.

The base for the evaluation is a "cube" measurement. The measured volume must include the 1g and 10g cubes with the highest averaged SAR values. For that purpose , the center of the measured volume is aligned to the interpolated peak SAR value of a previously performed area scan.



The entire evaluation of the spatial peak values is performed within the postprocessing engine (SEMCAD). The system always gives the maximum values for the 1g and 10g cubes. The algorithm to find the cube with highest averaged SAR is divided into the following stages:

- extraction of the measured data (grid and values) from the Zoom Scan
- calculation of the SAR value at every measurement point based on all stored data (A/D values and measurement parameters)
- generation of a high-resolution mesh within the measured volume
- interpolation of all measured values from the measurement grid to the high-resolution grid
- extrapolation of the entire 3-D field distribution to the phantom surface over the distance from sensor to surface
- calculation of the averaged SAR within masses of 1g and 10g

10.2 Scan Procedures

First **Area Scan** is used to locate the approximate location(s) of the local peak SAR value(s). The measurement grid within an **Area Scan** is defined by the grid extent, grid step size and grid offset. Next, in order to determine the EM field distribution in a three-dimensional spatial extension, **Zoom Scan** is required. The **Zoom Scan** measures 5x5x7 points with step size 8, 8 and 5 mm. The **Zoom Scan** is performed around the highest E-field value to determine the averaged SAR-distribution over 1 g.

10.3 SAR Averaged Methods

In DASY4, the interpolation and extrapolation are both based on the modified Quadratic Shepard's method. The interpolation scheme combines a least-square fitted function method and a weighted average method which are the two basic types of computational interpolation and approximation.

Extrapolation routines are used to obtain SAR values between the lowest measurement points and the inner phantom surface. The extrapolation distance is determined by the surface detection distance and the probe sensor offset. The uncertainty increases with the extrapolation distance. To keep the uncertainty within 1% for the 1 g and 10 g cubes, the extrapolation distance should not be larger than 5 mm.



11. SAR Test Results

11.1 Right Cheek

Model	Mode	Accessory	Chan.	Freq (MHz)	Modulation Type	Conducted Power (dBm)	Power Drift (dB)	Measured 1g SAR (W/kg)	Limit (W/kg)	Results		
7527C	802.11b	Endcap 1+B2	1	2412(Low)	CCK	20.65	0.063	0.05	1.6	Pass		
			6	2437(Mid)	CCK	20.32	-0.115	0.041	1.6	Pass		
			11	2462(High)	CCK	20.40	0.016	0.075	1.6	Pass		
	802.11b with BT On	Endcap 1+B2	Endcap 1+B2	11	2462(High)	CCK	20.40	0.079	0.079	1.6	Pass	
				11	2462(High)	CCK	20.40	-0.063	0.098	1.6	Pass	
				11	2462(High)	CCK	20.40	-0.006	0.085	1.6	Pass	
				11	2462(High)	CCK	20.40	-0.05	0.106	1.6	Pass	
				11	2462(High)	CCK	20.40	-0.135	0.109	1.6	Pass	
				11	2462(High)	CCK	20.40	-0.056	0.095	1.6	Pass	
				11	2462(High)	CCK	20.40	-0.113	0.104	1.6	Pass	
				POD 4+B2	1	2412(Low)	CCK	20.65	0.11	0.14	1.6	Pass
					6	2437(Mid)	CCK	20.32	-0.043	0.141	1.6	Pass
				11	2462(High)	CCK	20.40	-0.056	0.113	1.6	Pass	
	POD 4+B3	11	2462(High)	CCK	20.40	-0.102	0.098	1.6	Pass			
	POD 6+B2	11	2462(High)	CCK	20.40	-0.141	0.1	1.6	Pass			
802.11g	Endcap 1+B2	Endcap 1+B2	1	2412(Low)	OFDM	22.98	-	-	-	-		
			6	2437(Mid)	OFDM	22.07	0.01	0.026	1.6	Pass		
			11	2462(High)	OFDM	22.11	-	-	-	-		
7527S	802.11b with BT On	POD 4+B2	6	2437(Mid)	CCK	20.32	-0.173	0.174	1.6	Pass		

11.2 Right Tilted

Model	Mode	Accessory	Chan.	Freq (MHz)	Modulation Type	Conducted Power (dBm)	Power Drift (dB)	Measured 1g SAR (W/kg)	Limit (W/kg)	Results	
7527C	802.11b	Endcap 1+B2	1	2412(Low)	CCK	20.65	-	-	-	-	
			6	2437(Mid)	CCK	20.32	-0.037	0.04	1.6	Pass	
			11	2462(High)	CCK	20.40	-	-	-	-	
	802.11g	Endcap 1+B2	Endcap 1+B2	1	2412(Low)	OFDM	22.98	-	-	-	-
				6	2437(Mid)	OFDM	22.07	-	-	-	-
11	2462(High)	OFDM	22.11	-	-	-	-				

11.3 Left Cheek

Model	Mode	Accessory	Chan.	Freq (MHz)	Modulation Type	Conducted Power (dBm)	Power Drift (dB)	Measured 1g SAR (W/kg)	Limit (W/kg)	Results	
7527C	802.11b	Endcap 1+B2	1	2412(Low)	CCK	20.65	-	-	-	-	
			6	2437(Mid)	CCK	20.32	-0.124	0.031	1.6	Pass	
			11	2462(High)	CCK	20.40	-	-	-	-	
	802.11g	Endcap 1+B2	Endcap 1+B2	1	2412(Low)	OFDM	22.98	-	-	-	-
				6	2437(Mid)	OFDM	22.07	-	-	-	-
11	2462(High)	OFDM	22.11	-	-	-	-				



11.4 Left Tilted

Model	Mode	Accessory	Chan.	Freq (MHz)	Modulation Type	Conducted Power (dBm)	Power Drift (dB)	Measured 1g SAR (W/kg)	Limit (W/kg)	Results
7527C	802.11b	Endcap 1+B2	1	2412(Low)	CCK	20.65	-	-	-	-
			6	2437(Mid)	CCK	20.32	0.074	0.029	1.6	Pass
			11	2462(High)	CCK	20.40	-	-	-	-
	802.11g	Endcap 1+B2	6	2437(Mid)	CCK	20.32	0.1	0.062	1.6	Pass
			1	2412(Low)	OFDM	22.98	-	-	-	-
			6	2437(Mid)	OFDM	22.07	-	-	-	-
7527S	802.11b	POD 3+B2	6	2437(Mid)	OFDM	22.07	-0.013	0.0535	1.6	Pass

11.5 Keypad Up with 1.5cm Gap

Model	Mode	Accessory	Chan.	Freq (MHz)	Modulation Type	Conducted Power (dBm)	Power Drift (dB)	Measured 1g SAR (W/kg)	Limit (W/kg)	Results
7527C	802.11b	Endcap 1+B2	1	2412(Low)	CCK	20.65	0.177	0.011	1.6	Pass
			6	2437(Mid)	CCK	20.32	0.171	0.011	1.6	Pass
			11	2462(High)	CCK	20.40	-0.175	0.00986	1.6	Pass
	802.11g	Endcap 1+B2	6	2437(Mid)	CCK	20.32	-0.171	0.012	1.6	Pass
			1	2412(Low)	OFDM	22.98	-	-	-	-
			6	2437(Mid)	OFDM	22.07	0.174	0.0067	1.6	Pass
7527S	802.11b	Endcap 1+B2	11	2462(High)	OFDM	22.11	-	-	-	-
			6	2437(Mid)	CCK	20.32	0.148	0.014	1.6	Pass
			6	2437(Mid)	CCK	20.32	0.106	0.014	1.6	Pass

11.6 Keypad Down with 1.5cm Gap

Model	Mode	Accessory	Chan.	Freq (MHz)	Modulation Type	Conducted Power (dBm)	Power Drift (dB)	Measured 1g SAR (W/kg)	Limit (W/kg)	Results
7527C	802.11b	Endcap 1+B2	1	2412(Low)	CCK	20.65	-	-	-	-
			6	2437(Mid)	CCK	20.32	-0.116	0.011	1.6	Pass
			11	2462(High)	CCK	20.40	-	-	-	-
	802.11g	Endcap 1+B2	1	2412(Low)	OFDM	22.98	-	-	-	-
			6	2437(Mid)	OFDM	22.07	-	-	-	-
			11	2462(High)	OFDM	22.11	-	-	-	-



11.7 Holster Left Side Touch

Model	Mode	Accessory	Chan.	Freq (MHz)	Modulation Type	Conducted Power (dBm)	Power Drift (dB)	Measured 1g SAR (W/kg)	Limit (W/kg)	Results
7527C	802.11b	Endcap 1+B2	1	2412(Low)	CCK	20.65	-0.004	0.15	1.6	Pass
			6	2437(Mid)	CCK	20.32	-0.168	0.154	1.6	Pass
			11	2462(High)	CCK	20.40	-0.089	0.154	1.6	Pass
		Endcap 3+B2	6	2437(Mid)	CCK	20.32	-0.165	0.198	1.6	Pass
			6	2437(Mid)	CCK	20.32	0.127	0.162	1.6	Pass
		Endcap 6+B2	1	2412(Low)	CCK	20.65	-0.192	0.23	1.6	Pass
			6	2437(Mid)	CCK	20.32	-0.12	0.216	1.6	Pass
			11	2462(High)	CCK	20.40	-0.062	0.157	1.6	Pass
		Endcap 6+B3	6	2437(Mid)	CCK	20.32	0.114	0.197	1.6	Pass
		POD 1+B2	6	2437(Mid)	CCK	20.32	-0.106	0.132	1.6	Pass
		POD 2+B2	6	2437(Mid)	CCK	20.32	-0.014	0.159	1.6	Pass
		POD 3+B2	6	2437(Mid)	CCK	20.32	-0.149	0.152	1.6	Pass
		POD 4+B2	6	2437(Mid)	CCK	20.32	0.116	0.138	1.6	Pass
		POD 6+B2	6	2437(Mid)	CCK	20.32	0.022	0.172	1.6	Pass
802.11b With BT On	Endcap 1+B2	6	2437(Mid)	CCK	20.32	-0.087	0.161	1.6	Pass	
802.11g	Endcap 1+B2	6	2437(Mid)	OFDM	22.07	-0.125	0.024	1.6	Pass	
7527S	802.11b	Endcap 6+B2	1	2412(Low)	CCK	20.65	-0.147	0.234	1.6	Pass

11.8 Holster Right Side Touch

Model	Mode	Accessory	Chan.	Freq (MHz)	Modulation Type	Conducted Power (dBm)	Power Drift (dB)	Measured 1g SAR (W/kg)	Limit (W/kg)	Results
7527C	802.11b	Endcap 1+B2	1	2412(Low)	CCK	20.65	-0.103	0.01	1.6	Pass
			6	2437(Mid)	CCK	20.32	0.107	0.012	1.6	Pass

Remark:

1. The largest summation of GSM and WLAN for head SAR on 7527C is 1.362 W/Kg and on 7527S is 1.0635 W/Kg, and its position is left tilted.
2. The largest summation of GSM/GPRS and WLAN for body SAR on 7527C is 0.466 W/Kg and its position is holster right side touch, and on 7527S is 0.503 W/Kg, and its position is keypad up with 1.5cm Gap.
3. The test data for GSM can be referred to Appendix D.

Test Engineer : John Tsai and Neil Chen



12. References

- [1] FCC 47 CFR Part 2 “Frequency Allocations and Radio Treaty Matters; General Rules and Regulations”
- [2] IEEE Std. P1528-2003, “Recommended Practice for Determining the Peak Spatial-Average Specific Absorption Rate (SAR) in the Human Head from Wireless Communications Devices: Measurement Techniques”, April 21,2003.
- [3] Supplement C (Edition 01-01) to OET Bulletin 65 (Edition 97-01), “Additional Information for Evaluating Compliance of Mobile and Portable Devices with FCC Limits for Human Exposure to RF Emissions”, June 2001
- [4] IEEE Std. C95.3-2002, “IEEE Recommended Practice for the Measurement of Potentially Hazardous Electromagnetic Fields-RF and Microwave”, 2002
- [5] IEEE Std. C95.1-1999, “IEEE Standard for Safety Levels with Respect to Human Exposure to Radio Frequency Electromagnetic Fields, 3 kHz to 300 GHz”, 1999
- [6] Robert J. Renka, “Multivariate Interpolation Of Large Sets Of Scattered Data”, University of North Texas ACM Transactions on Mathematical Software, vol. 14, no. 2, June 1988, pp. 139-148
- [7] DAYS4 System Handbook
- [8] RSS-102 Issued 2, “Radio Frequency Exposure Compliance of Radiocommunication Apparatus (All Frequency Bands)”, November 2005



Appendix A - System Performance Check Data

Test Laboratory: Sporton International Inc. SAR Testing Lab

Date/Time: 2/12/2007 7:52:26 PM

System Check_Head_2450MHz_20070212

DUT: Dipole 2450 MHz

Communication System: CW; Frequency: 2450 MHz; Duty Cycle: 1:1

Medium: HSL_2450 Medium parameters used: $f = 2450$ MHz; $\sigma = 1.76$ mho/m; $\epsilon_r = 38.1$; $\rho = 1000$ kg/m³

Ambient Temperature : 21.9 °C; Liquid Temperature : 20.8 °C

DASY4 Configuration:

- Probe: ET3DV6 - SN1788; ConvF(4.66, 4.66, 4.66); Calibrated: 9/19/2006

- Sensor-Surface: 4mm (Mechanical And Optical Surface Detection)

- Electronics: DAE3 Sn577; Calibrated: 11/21/2006

- Phantom: SAM-B; Type: QD 000 P40 C; Serial: TP-1383

- Measurement SW: DASY4, V4.7 Build 44; Postprocessing SW: SEMCAD, V1.8 Build 171

2450MHz/Area Scan (41x41x1); Measurement grid: dx=20mm, dy=20mm

Maximum value of SAR (interpolated) = 5.83 mW/g

2450MHz/Zoom Scan (7x7x7)/Cube 0; Measurement grid: dx=5mm, dy=5mm, dz=5mm

Reference Value = 57.8 V/m; Power Drift = -0.036 dB

Peak SAR (extrapolated) = 11.4 W/kg

SAR(1 g) = 5.4 mW/g; SAR(10 g) = 2.55 mW/g

Maximum value of SAR (measured) = 6.11 mW/g

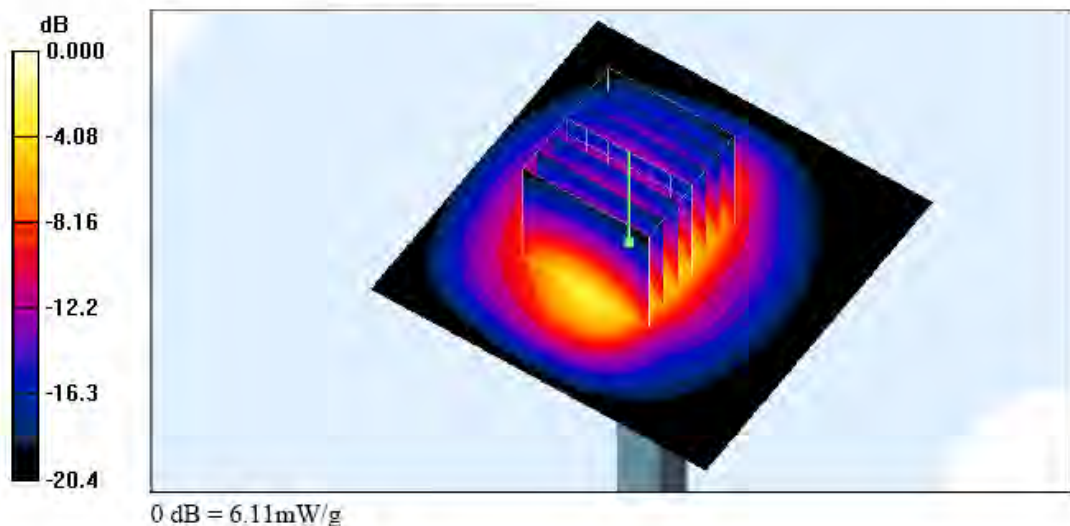



Test Laboratory: Sporton International Inc. SAR Testing Lab

Date/Time: 2/12/2007 8:08:44 AM

System Check_Body_2450MHz_20070212

DUT: Dipole 2450 MHz

Communication System: CW; Frequency: 2450 MHz; Duty Cycle: 1:1

Medium: MSL_2450 Medium parameters used: $f = 2450$ MHz; $\sigma = 1.96$ mho/m; $\epsilon_r = 52.7$; $\rho = 1000$ kg/m³

Ambient Temperature : 21.5 °C; Liquid Temperature : 21.0 °C

DASY4 Configuration:

- Probe: ET3DV6 - SN1788; ConvF(4.11, 4.11, 4.11); Calibrated: 9/19/2006
- Sensor-Surface: 4mm (Mechanical And Optical Surface Detection) Sensor-Surface: 4mm (Mechanical Surface Detection)
- Electronics: DAE3 Sn577; Calibrated: 11/21/2006
- Phantom: SAM-A; Type: QD 000 P40 C; Serial: TP-1303
- Measurement SW: DASY4, V4.7 Build 44; Postprocessing SW: SEMCAD, V1.8 Build 171

Pin=100mW/Area Scan (91x91x1): Measurement grid: dx=10mm, dy=10mm

Maximum value of SAR (interpolated) = 5.84 mW/g

Pin=100mW/Zoom Scan (7x7x7)/Cube 0: Measurement grid: dx=5mm, dy=5mm, dz=5mm

Reference Value = 55.3 V/m; Power Drift = -0.014 dB

Peak SAR (extrapolated) = 11.6 W/kg

SAR(1 g) = 5.01 mW/g; SAR(10 g) = 2.34 mW/g

Maximum value of SAR (measured) = 5.57 mW/g

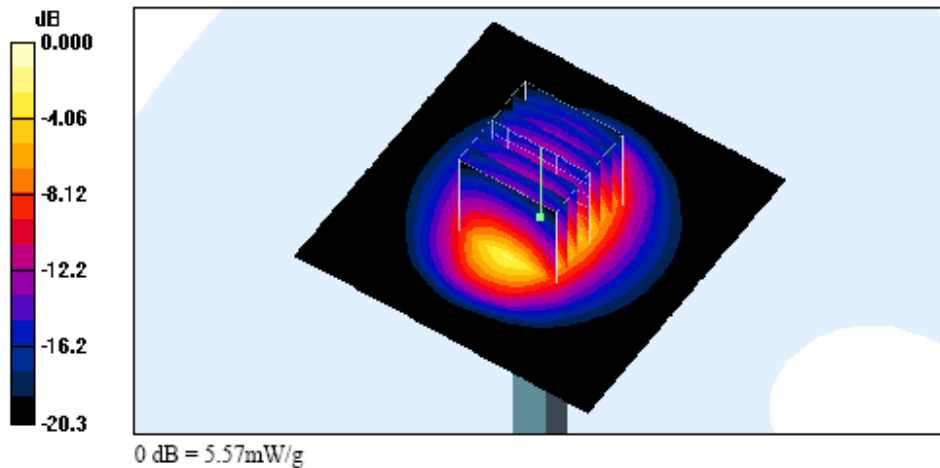



Test Laboratory: Sporton International Inc. SAR Testing Lab

Date: 5/7/2007

System Check_Head_2450MHz_20070507

DUT: Dipole 2450 MHz

Communication System: CW; Frequency: 2450 MHz; Duty Cycle: 1:1

Medium: HSL_2450 Medium parameters used: $f = 2450 \text{ MHz}$; $\sigma = 1.84 \text{ mho/m}$; $\epsilon_r = 39.6$; $\rho = 1000 \text{ kg/m}^3$

Ambient Temperature : 22.3 °C; Liquid Temperature : 21.7 °C

DASY4 Configuration:

- Probe: ET3DV6 - SN1788; ConvF(4.66, 4.66, 4.66); Calibrated: 9/19/2006
- Sensor-Surface: 4mm (Mechanical And Optical Surface Detection)
- Electronics: DAE3 Sn577; Calibrated: 11/21/2006
- Phantom: SAM-A; Type: QD 000 P40 C; Serial: TP-1303
- Measurement SW: DASY4, V4.7 Build 53; Postprocessing SW: SEMCAD, V1.8 Build 172

2450MHz/Area Scan (41x41x1): Measurement grid: dx=20mm, dy=20mm

Maximum value of SAR (interpolated) = 6.10 mW/g

2450MHz/Zoom Scan (7x7x7)/Cube 0: Measurement grid: dx=5mm, dy=5mm, dz=5mm

Reference Value = 57.8 V/m; Power Drift = -0.036 dB

Peak SAR (extrapolated) = 12.0 W/kg

SAR(1 g) = 5.66 mW/g; SAR(10 g) = 2.67 mW/g

Maximum value of SAR (measured) = 6.40 mW/g

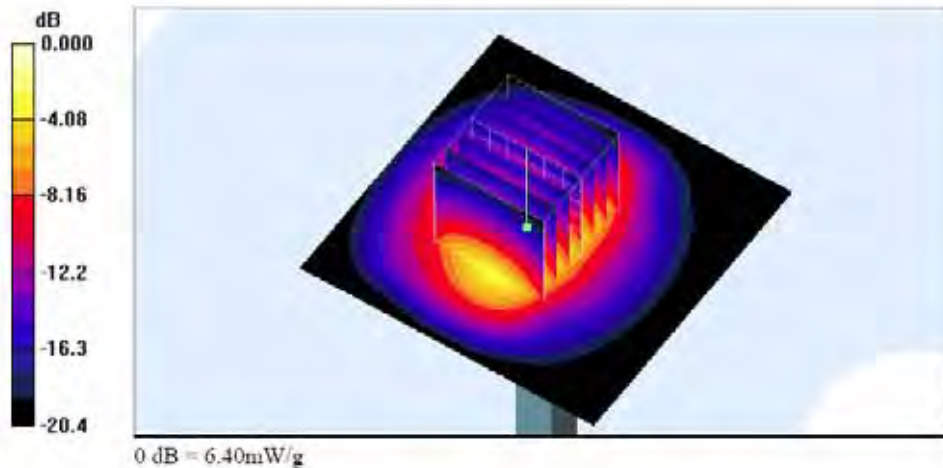



Test Laboratory: Sporton International Inc. SAR Testing Lab

Date: 2007/5/7

System Check_Body_2450MHz_20070507

DUT: Dipole 2450 MHz

Communication System: CW; Frequency: 2450 MHz; Duty Cycle: 1:1

Medium: MSL_2450 Medium parameters used: $f = 2450$ MHz; $\sigma = 1.96$ mho/m; $\epsilon_r = 53$; $\rho = 1000$ kg/m³

Ambient Temperature : 22.5 °C; Liquid Temperature : 21.0 °C

DASY4 Configuration:

- Probe: ET3DV6 - SN1787; ConvF(4.13, 4.13, 4.13); Calibrated: 2006/5/31
- Sensor-Surface: 4mm (Mechanical And Optical Surface Detection) Sensor-Surface: 4mm (Mechanical Surface Detection)
- Electronics: DAE3 Sn577; Calibrated: 2006/11/21
- Phantom: SAM-B; Type: QD 000 P40 C; Serial: TP-1383
- Measurement SW: DASY4, V4.7 Build 53; Postprocessing SW: SEMCAD, V1.8 Build 172

Pin=100mW/Area Scan (91x91x1): Measurement grid: dx=10mm, dy=10mm

Maximum value of SAR (interpolated) = 6.19 mW/g

Pin=100mW/Zoom Scan (7x7x7)/Cube 0: Measurement grid: dx=5mm, dy=5mm, dz=5mm

Reference Value = 58.2 V/m; Power Drift = 0.007 dB

Peak SAR (extrapolated) = 11.4 W/kg

SAR(1 g) = 5.29 mW/g; SAR(10 g) = 2.5 mW/g

Maximum value of SAR (measured) = 5.94 mW/g

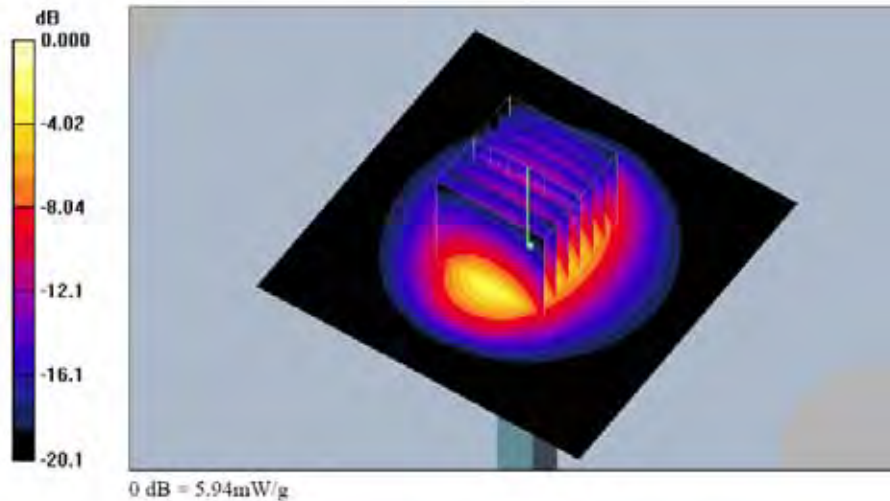



Appendix B - SAR Measurement Data

Test Laboratory: Sporton International Inc. SAR Testing Lab

Date/Time: 2/13/2007 10:48:07 AM

Right Cheek_802.11b Ch11_20070212_PC528

DUT: 710211-01

Communication System: 802.11b ; Frequency: 2462 MHz;Duty Cycle: 1:1

Medium: HSL_2450 Medium parameters used: $f = 2462$ MHz; $\sigma = 1.78$ mho/m; $\epsilon_r = 38$; $\rho = 1000$ kg/m³

Ambient Temperature : 21.5 °C ; Liquid Temperature : 20.8 °C

DASY4 Configuration:

- Probe: ET3DV6 - SN1788; ConvF(4.66, 4.66, 4.66); Calibrated: 9/19/2006
- Sensor-Surface: 4mm (Mechanical And Optical Surface Detection)
- Electronics: DAE3 Sn577; Calibrated: 11/21/2006
- Phantom: SAM-B; Type: QD 000 P40 C; Serial: TP-1383
- Measurement SW: DASY4, V4.7 Build 44; Postprocessing SW: SEMCAD, V1.8 Build 171

Ch11/Area Scan (71x181x1): Measurement grid: dx=15mm, dy=15mm

Maximum value of SAR (interpolated) = 0.082 mW/g

Ch11/Zoom Scan (5x5x7)/Cube 0: Measurement grid: dx=8mm, dy=8mm, dz=5mm

Reference Value = 5.31 V/m; Power Drift = 0.016 dB

Peak SAR (extrapolated) = 0.161 W/kg

SAR(1 g) = 0.075 mW/g; SAR(10 g) = 0.038 mW/g

Maximum value of SAR (measured) = 0.080 mW/g

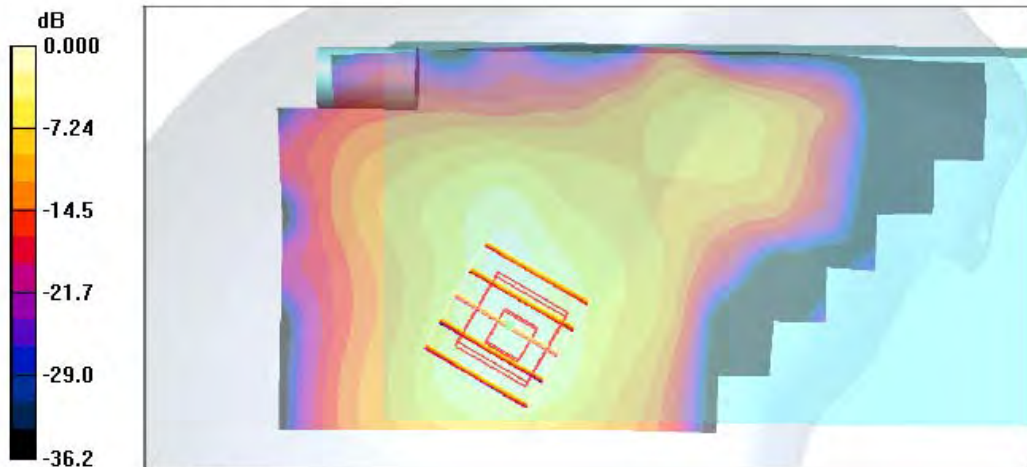



Test Laboratory: Sporton International Inc. SAR Testing Lab

Date/Time: 2/13/2007 7:48:50 AM

Right Tilted_802.11b Ch6_20070212_PC528

DUT: 710211-01

Communication System: 802.11b ; Frequency: 2437 MHz; Duty Cycle: 1:1

Medium: HSL_2450 Medium parameters used: $f = 2437$ MHz; $\sigma = 1.74$ mho/m; $\epsilon_r = 38.2$; $\rho = 1000$ kg/m³

Ambient Temperature : 21.7 °C ; Liquid Temperature : 20.8 °C

DASY4 Configuration:

- Probe: ET3DV6 - SN1788; ConvF(4.66, 4.66, 4.66); Calibrated: 9/19/2006
- Sensor-Surface: 4mm (Mechanical And Optical Surface Detection)
- Electronics: DAE3 Sn577; Calibrated: 11/21/2006
- Phantom: SAM-B; Type: QD 000 P40 C; Serial: TP-1383
- Measurement SW: DASY4, V4.7 Build 44; Postprocessing SW: SEMCAD, V1.8 Build 171

Ch6/Area Scan (71x181x1): Measurement grid: dx=15mm, dy=15mm

Maximum value of SAR (interpolated) = 0.041 mW/g

Ch6/Zoom Scan (5x5x7)/Cube 0: Measurement grid: dx=8mm, dy=8mm, dz=5mm

Reference Value = 4.08 V/m; Power Drift = -0.037 dB

Peak SAR (extrapolated) = 0.082 W/kg

SAR(1 g) = 0.040 mW/g; SAR(10 g) = 0.020 mW/g

Maximum value of SAR (measured) = 0.047 mW/g

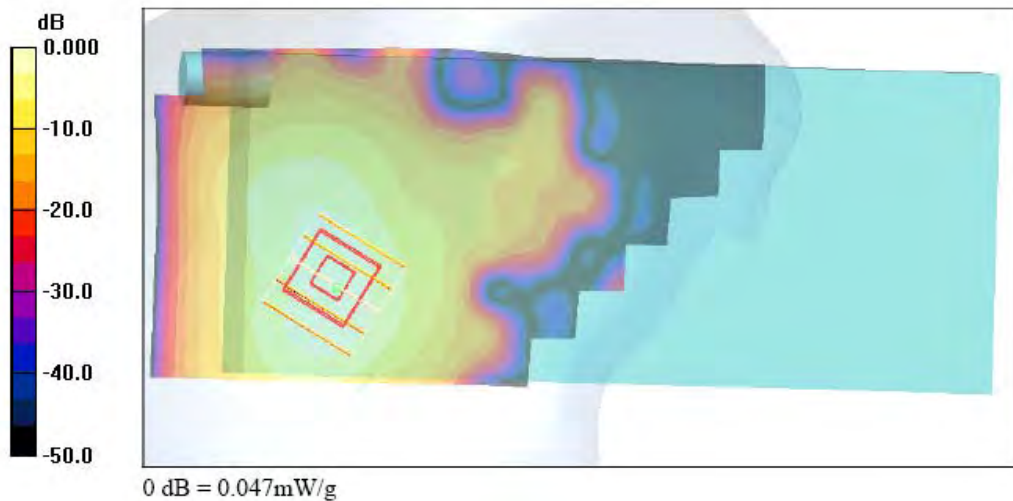



Test Laboratory: Sporton International Inc. SAR Testing Lab

Date/Time: 2/13/2007 9:12:15 AM

Left Cheek_802.11b Ch6_20070212_PC528

DUT: 710211-01

Communication System: 802.11b ; Frequency: 2437 MHz;Duty Cycle: 1:1

Medium: HSL_2450 Medium parameters used: $f = 2437$ MHz; $\sigma = 1.74$ mho/m; $\epsilon_r = 38.2$; $\rho = 1000$ kg/m³

Ambient Temperature : 21.8 °C; Liquid Temperature : 20.8 °C

DASY4 Configuration:

- Probe: ET3DV6 - SN1788; ConvF(4.66, 4.66, 4.66); Calibrated: 9/19/2006

- Sensor-Surface: 4mm (Mechanical And Optical Surface Detection)

- Electronics: DAE3 Sn577; Calibrated: 11/21/2006

- Phantom: SAM-B; Type: QD 000 P40 C; Serial: TP-1383

- Measurement SW: DASY4, V4.7 Build 44; Postprocessing SW: SEMCAD, V1.8 Build 171

Ch6/Area Scan (71x181x1): Measurement grid: dx=15mm, dy=15mm

Maximum value of SAR (interpolated) = 0.033 mW/g

Ch6/Zoom Scan (5x5x7)/Cube 0: Measurement grid: dx=8mm, dy=8mm, dz=5mm

Reference Value = 4.36 V/m; Power Drift = -0.124 dB

Peak SAR (extrapolated) = 0.062 W/kg

SAR(1 g) = 0.031 mW/g; SAR(10 g) = 0.017 mW/g

Maximum value of SAR (measured) = 0.033 mW/g

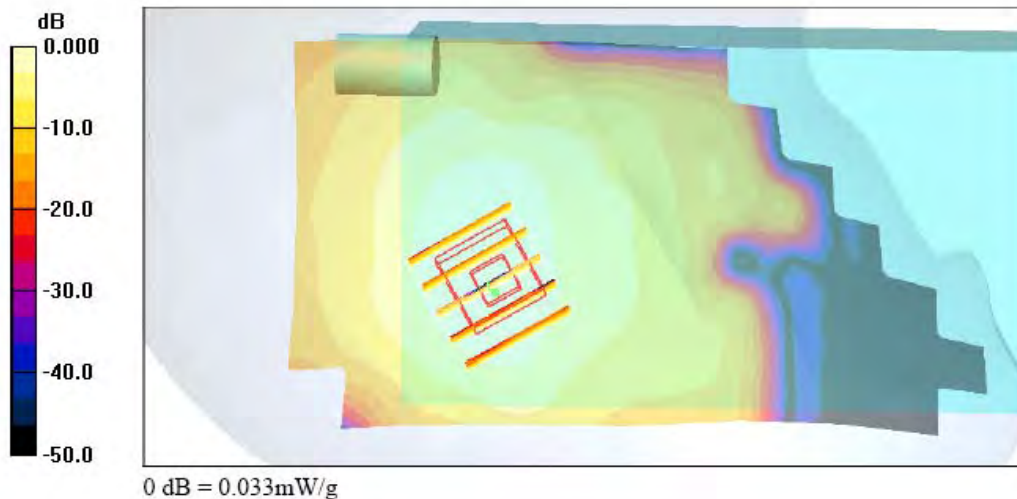



Test Laboratory: Sporton International Inc. SAR Testing Lab

Date/Time: 2/13/2007 9:42:50 AM

Left Tilted_802.11b Ch6_20070212_PC528

DUT: 710211-01

Communication System: 802.11b ; Frequency: 2437 MHz;Duty Cycle: 1:1

Medium: HSL_2450 Medium parameters used: $f = 2437$ MHz; $\sigma = 1.74$ mho/m; $\epsilon_r = 38.2$; $\rho = 1000$ kg/m³

Ambient Temperature : 21.6 °C ; Liquid Temperature : 20.8 °C

DASY4 Configuration:

- Probe: ET3DV6 - SN1788; ConvF(4.66, 4.66, 4.66); Calibrated: 9/19/2006
- Sensor-Surface: 4mm (Mechanical And Optical Surface Detection)
- Electronics: DAE3 Sn577; Calibrated: 11/21/2006
- Phantom: SAM-B; Type: QD 000 P40 C; Serial: TP-1383
- Measurement SW: DASY4, V4.7 Build 44; Postprocessing SW: SEMCAD, V1.8 Build 171

Ch6/Area Scan (71x181x1): Measurement grid: dx=15mm, dy=15mm

Maximum value of SAR (interpolated) = 0.031 mW/g

Ch6/Zoom Scan (5x5x7)/Cube 0: Measurement grid: dx=8mm, dy=8mm, dz=5mm

Reference Value = 3.98 V/m; Power Drift = 0.074 dB

Peak SAR (extrapolated) = 0.058 W/kg

SAR(1 g) = 0.029 mW/g; SAR(10 g) = 0.015 mW/g

Maximum value of SAR (measured) = 0.032 mW/g

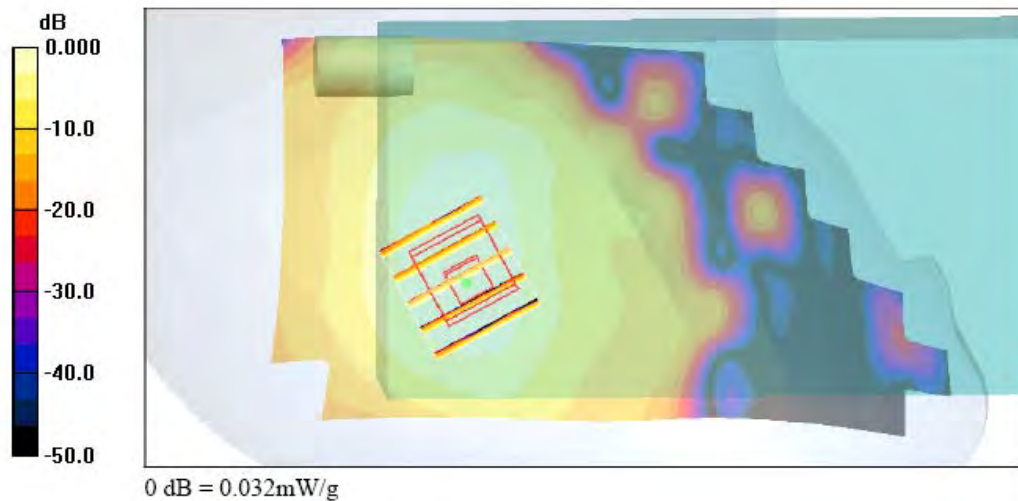



Test Laboratory: Sporton International Inc. SAR Testing Lab

Date/Time: 2/13/2007 11:09:12 AM

Right Cheek_802.11b Ch11_20070212_PC528_Bluetooth On

DUT: 710211-01

Communication System: 802.11b ; Frequency: 2462 MHz;Duty Cycle: 1:1

Medium: HSL_2450 Medium parameters used: $f = 2462$ MHz; $\sigma = 1.78$ mho/m; $\epsilon_r = 38$; $\rho = 1000$ kg/m³

Ambient Temperature : 21.4 °C; Liquid Temperature : 20.8 °C

DASY4 Configuration:

- Probe: ET3DV6 - SN1788; ConvF(4.66, 4.66, 4.66); Calibrated: 9/19/2006

- Sensor-Surface: 4mm (Mechanical And Optical Surface Detection)

- Electronics: DAE3 Sn577; Calibrated: 11/21/2006

- Phantom: SAM-B; Type: QD 000 P40 C; Serial: TP-1383

- Measurement SW: DASY4, V4.7 Build 44; Postprocessing SW: SEMCAD, V1.8 Build 171

Ch11/Area Scan (71x181x1): Measurement grid: dx=15mm, dy=15mm

Maximum value of SAR (interpolated) = 0.088 mW/g

Ch11/Zoom Scan (5x5x7)/Cube 0: Measurement grid: dx=8mm, dy=8mm, dz=5mm

Reference Value = 5.31 V/m; Power Drift = 0.079 dB

Peak SAR (extrapolated) = 0.174 W/kg

SAR(1 g) = 0.079 mW/g; SAR(10 g) = 0.040 mW/g

Maximum value of SAR (measured) = 0.084 mW/g

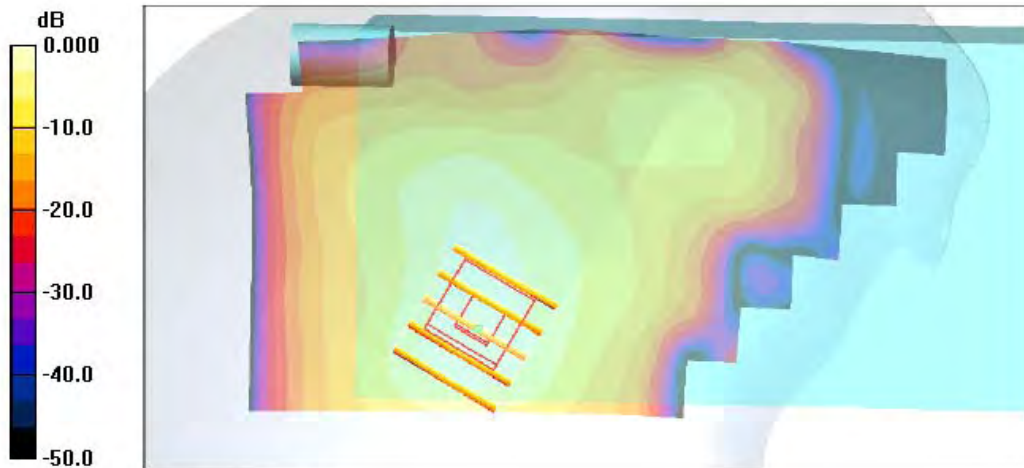

0 dB = 0.084mW/g



Test Laboratory: Sporton International Inc. SAR Testing Lab

Date/Time: 2/13/2007 8:12:12 AM

Right Cheek_802.11g Ch6_20070212_PC528

DUT: 710211-01

Communication System: 802.11g; Frequency: 2437 MHz; Duty Cycle: 1:1

Medium: HSL_2450 Medium parameters used: $f = 2437$ MHz; $\sigma = 1.74$ mho/m; $\epsilon_r = 38.2$; $\rho = 1000$ kg/m³

Ambient Temperature : 21.7 °C; Liquid Temperature : 20.8 °C

DASY4 Configuration:

- Probe: ET3DV6 - SN1788; ConvF(4.66, 4.66, 4.66); Calibrated: 9/19/2006
- Sensor-Surface: 4mm (Mechanical And Optical Surface Detection)
- Electronics: DAE3 Sn577; Calibrated: 11/21/2006
- Phantom: SAM-B; Type: QD 000 P40 C; Serial: TP-1383
- Measurement SW: DASY4, V4.7 Build 44; Postprocessing SW: SEMCAD, V1.8 Build 171

Ch6/Area Scan (71x181x1): Measurement grid: dx=15mm, dy=15mm

Maximum value of SAR (interpolated) = 0.029 mW/g

Ch6/Zoom Scan (5x5x7)/Cube 0: Measurement grid: dx=8mm, dy=8mm, dz=5mm

Reference Value = 3.07 V/m; Power Drift = 0.010 dB

Peak SAR (extrapolated) = 0.057 W/kg

SAR(1 g) = 0.026 mW/g; SAR(10 g) = 0.014 mW/g

Maximum value of SAR (measured) = 0.029 mW/g

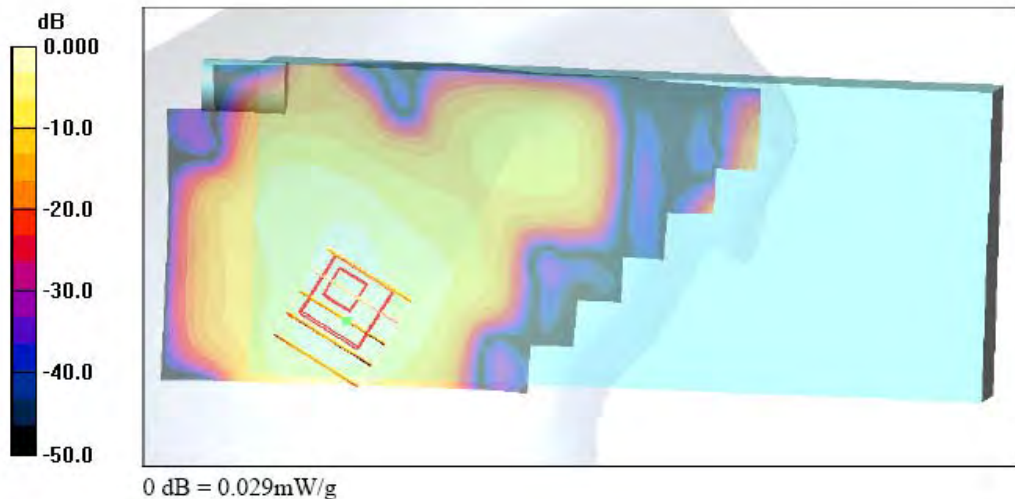



Test Laboratory: Sporton International Inc. SAR Testing Lab

Date: 2007/5/7

Right cheek_802.11b Ch11_7527C_Endcap 3_B2

Communication System: 802.11b ; Frequency: 2462 MHz;Duty Cycle: 1:1

Medium: HSL_2450 Medium parameters used: f = 2462 MHz; $\sigma = 1.87$ mho/m; $\epsilon_r = 39.5$; $\rho = 1000$ kg/m³

Ambient Temperature : 22.4 °C ; Liquid Temperature : 21.7 °C

DASY4 Configuration:

- Probe: ET3DV6 - SN1788; ConvF(4.66, 4.66, 4.66); Calibrated: 2006/9/19
- Sensor-Surface: 4mm (Mechanical Surface Detection)
- Electronics: DAE3 Sn577; Calibrated: 2006/11/21
- Phantom: SAM-A; Type: QD 000 P40 C; Serial: TP-1303
- Measurement SW: DASY4, V4.7 Build 53; Postprocessing SW: SEMCAD, V1.8 Build 172

Ch11/Area Scan (81x181x1): Measurement grid: dx=15mm, dy=15mm

Maximum value of SAR (interpolated) = 0.099 mW/g

Ch11/Zoom Scan (5x5x7)/Cube 0: Measurement grid: dx=8mm, dy=8mm, dz=5mm

Reference Value = 7.48 V/m; Power Drift = -0.063 dB

Peak SAR (extrapolated) = 0.192 W/kg

SAR(1 g) = 0.098 mW/g; SAR(10 g) = 0.054 mW/g

Maximum value of SAR (measured) = 0.106 mW/g

Ch11/Zoom Scan (5x5x7)/Cube 1: Measurement grid: dx=8mm, dy=8mm, dz=5mm

Reference Value = 7.48 V/m; Power Drift = -0.063 dB

Peak SAR (extrapolated) = 0.185 W/kg

SAR(1 g) = 0.079 mW/g; SAR(10 g) = 0.037 mW/g

Maximum value of SAR (measured) = 0.101 mW/g

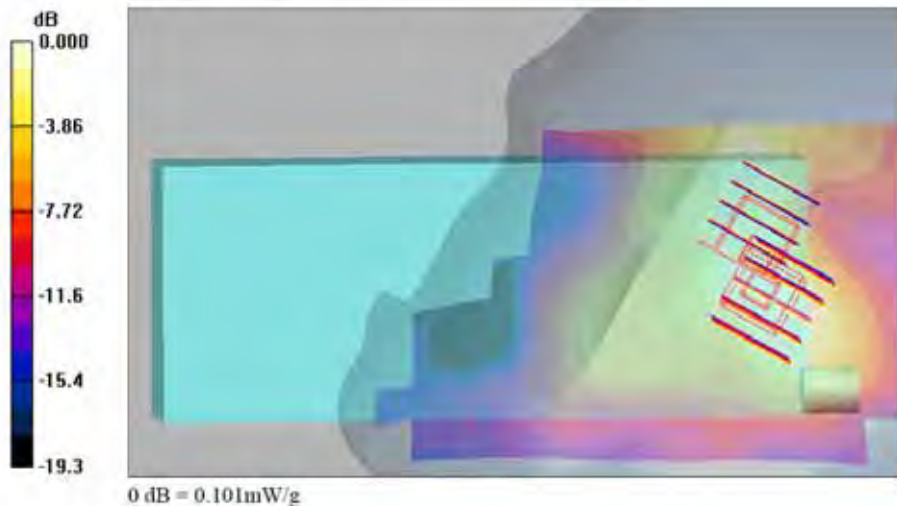



Test Laboratory: Sporton International Inc. SAR Testing Lab

Date: 2007/5/7

Right cheek_802.11b Ch11_7527C_Endcap 4_B2

Communication System: 802.11b ; Frequency: 2462 MHz;Duty Cycle: 1:1
Medium: HSL_2450 Medium parameters used: f = 2462 MHz; $\sigma = 1.87$ mho/m; $\epsilon_r = 39.5$; $\rho = 1000$ kg/m³
Ambient Temperature : 22.5 °C ; Liquid Temperature : 21.7 °C

DASY4 Configuration:

- Probe: ET3DV6 - SN1788; ConvF(4.66, 4.66, 4.66); Calibrated: 2006/9/19
- Sensor-Surface: 4mm (Mechanical Surface Detection)
- Electronics: DAE3 Sn577; Calibrated: 2006/11/21
- Phantom: SAM-A; Type: QD 000 P40 C; Serial: TP-1303
- Measurement SW: DASY4, V4.7 Build 53; Postprocessing SW: SEMCAD, V1.8 Build 172

Ch11/Area Scan (81x181x1): Measurement grid: dx=15mm, dy=15mm
Maximum value of SAR (interpolated) = 0.080 mW/g

Ch11/Zoom Scan (5x5x7)/Cube 0: Measurement grid: dx=8mm, dy=8mm, dz=5mm
Reference Value = 7.08 V/m; Power Drift = -0.006 dB
Peak SAR (extrapolated) = 0.186 W/kg
SAR(1 g) = 0.085 mW/g; SAR(10 g) = 0.043 mW/g

Maximum value of SAR (measured) = 0.088 mW/g

Ch11/Zoom Scan (5x5x7)/Cube 1: Measurement grid: dx=8mm, dy=8mm, dz=5mm
Reference Value = 7.08 V/m; Power Drift = -0.006 dB
Peak SAR (extrapolated) = 0.161 W/kg
SAR(1 g) = 0.079 mW/g; SAR(10 g) = 0.042 mW/g

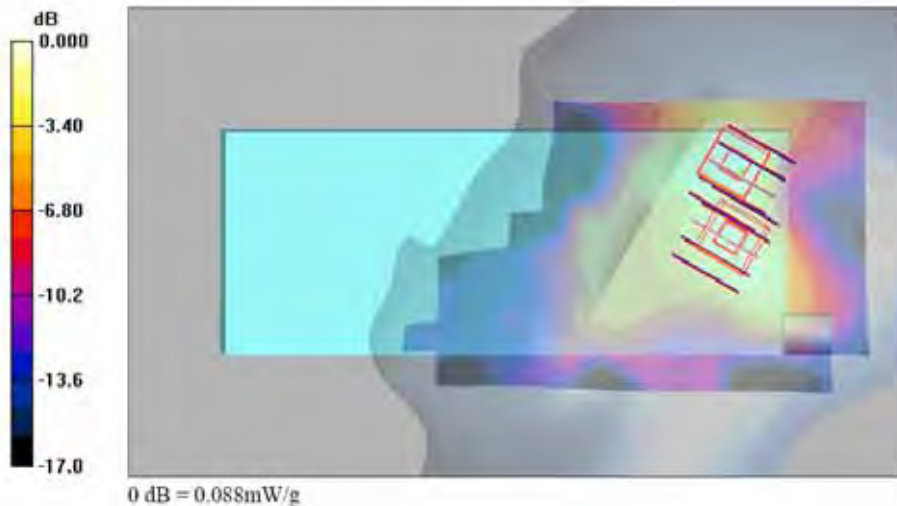



Test Laboratory: Sporton International Inc. SAR Testing Lab

Date: 2007/5/7

Right cheek_802.11b Ch11_7527C_Endcap 6_B2

Communication System: 802.11b ; Frequency: 2462 MHz;Duty Cycle: 1:1

Medium: HSL_2450 Medium parameters used: $f = 2462$ MHz; $\sigma = 1.87$ mho/m; $\epsilon_r = 39.5$; $\rho = 1000$ kg/m³

Ambient Temperature : 22.4 °C ; Liquid Temperature : 21.7 °C

DASY4 Configuration:

- Probe: ET3DV6 - SN1788; ConvF(4.66, 4.66, 4.66); Calibrated: 2006/9/19
- Sensor-Surface: 4mm (Mechanical Surface Detection)
- Electronics: DAE3 Sn577; Calibrated: 2006/11/21
- Phantom: SAM-A; Type: QD 000 P40 C; Serial: TP-1303
- Measurement SW: DASY4, V4.7 Build 53; Postprocessing SW: SEMCAD, V1.8 Build 172

Ch11/Area Scan (81x181x1): Measurement grid: dx=15mm, dy=15mm

Maximum value of SAR (interpolated) = 0.115 mW/g

Ch11/Zoom Scan (5x5x7)/Cube 0: Measurement grid: dx=8mm, dy=8mm, dz=5mm

Reference Value = 7.04 V/m; Power Drift = -0.050 dB

Peak SAR (extrapolated) = 0.222 W/kg

SAR(1 g) = 0.106 mW/g; SAR(10 g) = 0.053 mW/g

Maximum value of SAR (measured) = 0.114 mW/g

Ch11/Zoom Scan (5x5x7)/Cube 1: Measurement grid: dx=8mm, dy=8mm, dz=5mm

Reference Value = 7.04 V/m; Power Drift = -0.050 dB

Peak SAR (extrapolated) = 0.173 W/kg

SAR(1 g) = 0.089 mW/g; SAR(10 g) = 0.047 mW/g

Maximum value of SAR (measured) = 0.099 mW/g

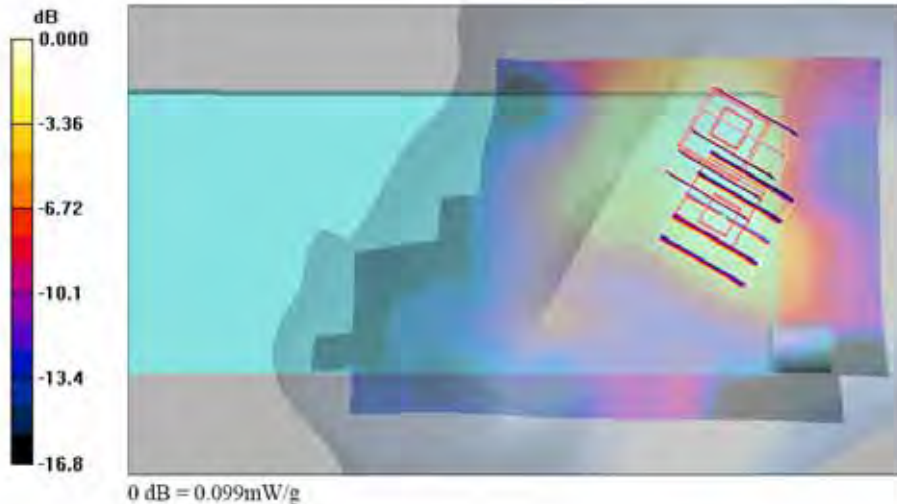



Test Laboratory: Sporton International Inc. SAR Testing Lab

Date: 2007/5/7

Right cheek_802.11b Ch11_7527C_POD 1_B2

Communication System: 802.11b ; Frequency: 2462 MHz;Duty Cycle: 1:1

Medium: HSL_2450 Medium parameters used: $f = 2462$ MHz; $\sigma = 1.87$ mho/m; $\epsilon_r = 39.5$; $\rho = 1000$ kg/m³

Ambient Temperature : 22.4 °C ; Liquid Temperature : 21.7 °C

DASY4 Configuration:

- Probe: ET3DV6 - SN1788; ConvF(4.66, 4.66, 4.66); Calibrated: 2006/9/19

- Sensor-Surface: 4mm (Mechanical Surface Detection)

- Electronics: DAE3 Sn577; Calibrated: 2006/11/21

- Phantom: SAM-A; Type: QD 000 P40 C; Serial: TP-1303

- Measurement SW: DASY4, V4.7 Build 53; Postprocessing SW: SEMCAD, V1.8 Build 172

Ch11/Area Scan (81x181x1): Measurement grid: dx=15mm, dy=15mm

Maximum value of SAR (interpolated) = 0.129 mW/g

Ch11/Zoom Scan (5x5x7)/Cube 0: Measurement grid: dx=8mm, dy=8mm, dz=5mm

Reference Value = 7.06 V/m; Power Drift = -0.135 dB

Peak SAR (extrapolated) = 0.250 W/kg

SAR(1 g) = 0.109 mW/g; SAR(10 g) = 0.057 mW/g

Maximum value of SAR (measured) = 0.114 mW/g

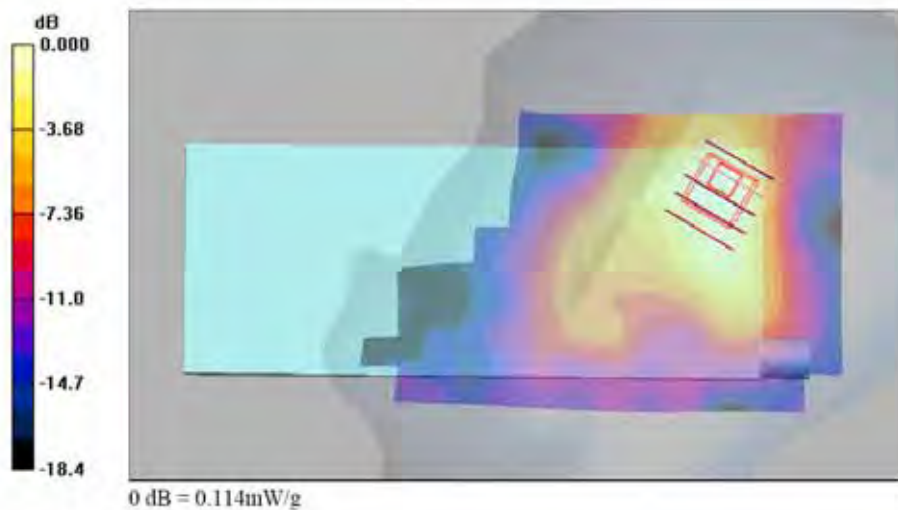



Test Laboratory: Sporton International Inc. SAR Testing Lab

Date: 2007/5/7 LWLQ

Right cheek_802.11b Ch11_7527C_POD 2_B2

Communication System: 802.11b ; Frequency: 2462 MHz;Duty Cycle: 1:1

Medium: HSL_2450 Medium parameters used: $f = 2462$ MHz; $\sigma = 1.87$ mho/m; $\epsilon_r = 39.5$; $\rho = 1000$ kg/m³

Ambient Temperature : 22.5 °C; Liquid Temperature : 21.7 °C

DASY4 Configuration:

- Probe: ET3DV6 - SN1788; ConvF(4.66, 4.66, 4.66); Calibrated: 2006/9/19

- Sensor-Surface: 4mm (Mechanical Surface Detection)

- Electronics: DAE3 Su577; Calibrated: 2006/11/21

- Phantom: SAM-A; Type: QD 000 P40 C; Serial: TP-1303

- Measurement SW: DASY4, V4.7 Build 53; Postprocessing SW: SEMCAD, V1.8 Build 172

Ch11/Area Scan (81x181x1): Measurement grid: dx=15mm, dy=15mm

Maximum value of SAR (interpolated) = 0.113 mW/g

Ch11/Zoom Scan (5x5x7)/Cube 0: Measurement grid: dx=8mm, dy=8mm, dz=5mm

Reference Value = 6.72 V/m; Power Drift = -0.056 dB

Peak SAR (extrapolated) = 0.197 W/kg

SAR(1 g) = 0.095 mW/g; SAR(10 g) = 0.049 mW/g

Maximum value of SAR (measured) = 0.103 mW/g

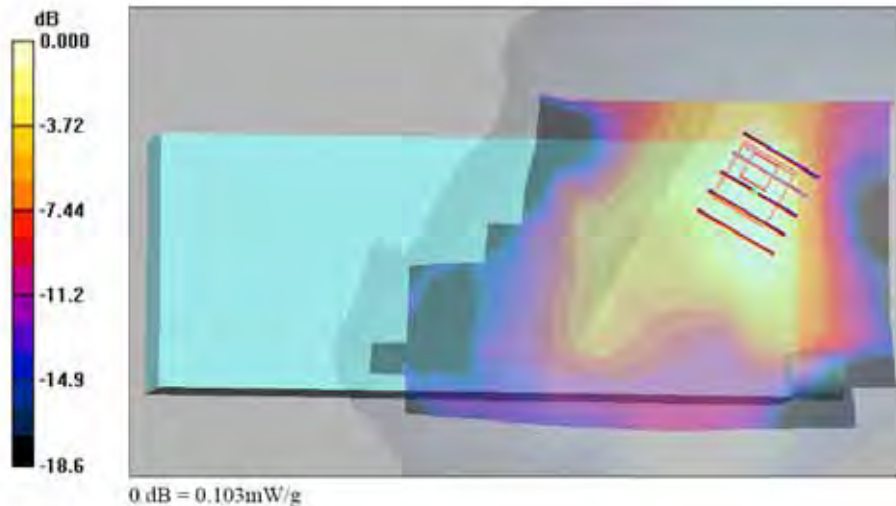



Test Laboratory: Sporton International Inc. SAR Testing Lab

Date: 2007/5/7

Right cheek_802.11b Ch11_7527C_POD 3_B2

Communication System: 802.11b ; Frequency: 2462 MHz;Duty Cycle: 1:1

Medium: HSL_2450 Medium parameters used: $f = 2462$ MHz; $\sigma = 1.87$ mho/m; $\epsilon_r = 39.5$; $\rho = 1000$ kg/m³

Ambient Temperature : 22.5 °C ; Liquid Temperature : 21.7 °C

DASY4 Configuration:

- Probe: ET3DV6 - SN1788; ConvF(4.66, 4.66, 4.66); Calibrated: 2006/9/19
- Sensor-Surface: 4mm (Mechanical Surface Detection)
- Electronics: DAE3 Sn577; Calibrated: 2006/11/21
- Phantom: SAM-A; Type: QD 000 P40 C; Serial: TP-1303
- Measurement SW: DASY4, V4.7 Build 53; Postprocessing SW: SEMCAD, V1.8 Build 172

Ch11/Area Scan (81x181x1): Measurement grid: dx=15mm, dy=15mm

Maximum value of SAR (interpolated) = 0.121 mW/g

Ch11/Zoom Scan (5x5x7)/Cube 0: Measurement grid: dx=8mm, dy=8mm, dz=5mm

Reference Value = 7.50 V/m; Power Drift = -0.113 dB

Peak SAR (extrapolated) = 0.220 W/kg

SAR(1 g) = 0.104 mW/g; SAR(10 g) = 0.054 mW/g

Maximum value of SAR (measured) = 0.119 mW/g

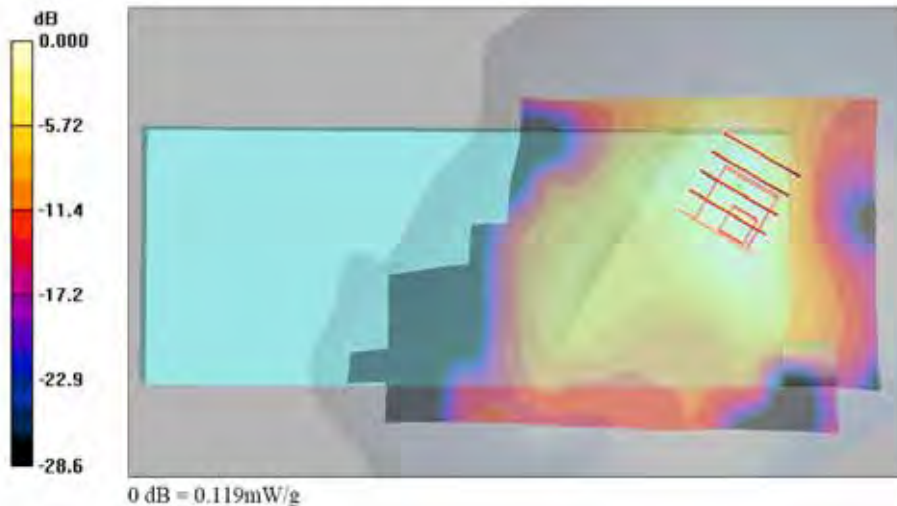



Test Laboratory: Sporton International Inc. SAR Testing Lab

Date: 2007/5/7

Right cheek_802.11b Ch6_7527C_POD 4_B2

Communication System: 802.11b ; Frequency: 2437 MHz;Duty Cycle: 1:1

Medium: HSL_2450 Medium parameters used: $f = 2437$ MHz; $\sigma = 1.81$ mho/m; $\epsilon_r = 39.8$; $\rho = 1000$ kg/m³

Ambient Temperature : 22.5 °C ; Liquid Temperature : 21.7 °C

DASY4 Configuration:

- Probe: ET3DV6 - SN1788; ConvF(4.66, 4.66, 4.66); Calibrated: 2006/9/19
- Sensor-Surface: 4mm (Mechanical Surface Detection)
- Electronics: DAE3 Sn577; Calibrated: 2006/11/21
- Phantom: SAM-A; Type: QD 000 P40 C; Serial: TP-1303
- Measurement SW: DASY4, V4.7 Build 53; Postprocessing SW: SEMCAD, V1.8 Build 172

Ch6/Area Scan (81x181x1): Measurement grid: dx=15mm, dy=15mm

Maximum value of SAR (interpolated) = 0.164 mW/g

Ch6/Zoom Scan (5x5x7)/Cube 0: Measurement grid: dx=8mm, dy=8mm, dz=5mm

Reference Value = 8.12 V/m; Power Drift = -0.043 dB

Peak SAR (extrapolated) = 0.315 W/kg

SAR(1 g) = 0.141 mW/g; SAR(10 g) = 0.074 mW/g

Maximum value of SAR (measured) = 0.151 mW/g

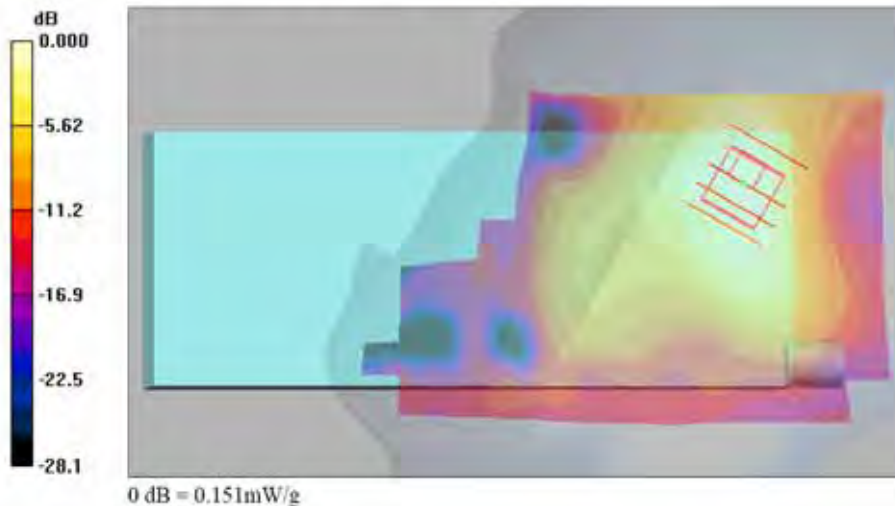



Test Laboratory: Sporton International Inc. SAR Testing Lab

Date: 2007/5/7

Right cheek_802.11b Ch11_7527C_POD 4_B3

Communication System: 802.11b ; Frequency: 2462 MHz;Duty Cycle: 1:1

Medium: HSL_2450 Medium parameters used: $f = 2462$ MHz; $\sigma = 1.87$ mho/m; $\epsilon_r = 39.5$; $\rho = 1000$ kg/m³

Ambient Temperature : 22.6 °C ; Liquid Temperature : 21.7 °C

DASY4 Configuration:

- Probe: ET3DV6 - SN1788; ConvF(4.66, 4.66, 4.66); Calibrated: 2006/9/19
- Sensor-Surface: 4mm (Mechanical Surface Detection)
- Electronics: DAE3 Sn577; Calibrated: 2006/11/21
- Phantom: SAM-A; Type: QD 000 P40 C; Serial: TP-1303
- Measurement SW: DASY4, V4.7 Build 53; Postprocessing SW: SEMCAD, V1.8 Build 172

Ch11/Area Scan (81x181x1): Measurement grid: dx=15mm, dy=15mm

Maximum value of SAR (interpolated) = 0.111 mW/g

Ch11/Zoom Scan (5x5x7)/Cube 0: Measurement grid: dx=8mm, dy=8mm, dz=5mm

Reference Value = 6.76 V/m; Power Drift = -0.102 dB

Peak SAR (extrapolated) = 0.205 W/kg

SAR(1 g) = 0.098 mW/g; SAR(10 g) = 0.051 mW/g

Maximum value of SAR (measured) = 0.108 mW/g

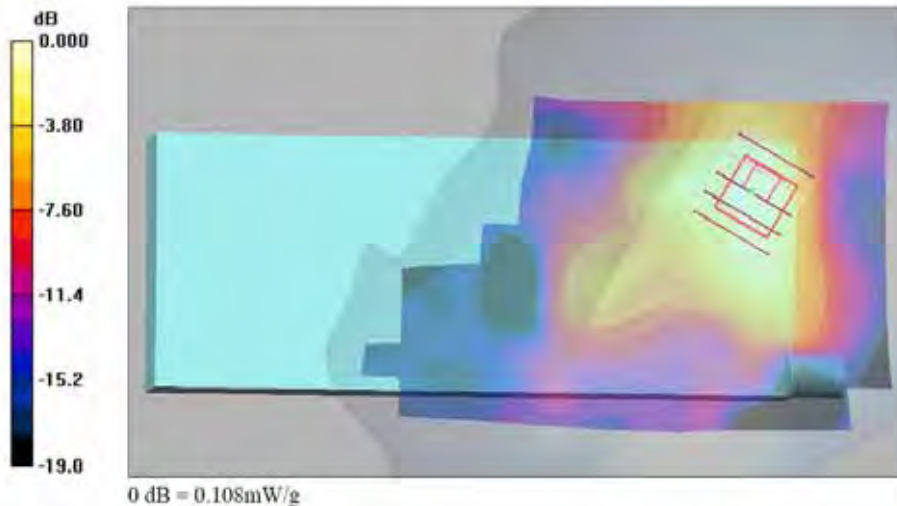



Test Laboratory: Sporton International Inc. SAR Testing Lab

Date: 2007/5/7

Right cheek_802.11b Ch11_7527C_POD 6_B2

Communication System: 802.11b ; Frequency: 2462 MHz;Duty Cycle: 1:1

Medium: HSL_2450 Medium parameters used: f = 2462 MHz; $\sigma = 1.87$ mho/m; $\epsilon_r = 39.5$; $\rho = 1000$ kg/m³

Ambient Temperature : 22.5 °C ; Liquid Temperature : 21.7 °C

DASY4 Configuration:

- Probe: ET3DV6 - SN1788; ConvF(4.66, 4.66, 4.66); Calibrated: 2006/9/19
- Sensor-Surface: 4mm (Mechanical Surface Detection)
- Electronics: DAE3 Sn577; Calibrated: 2006/11/21
- Phantom: SAM-A; Type: QD 000 P40 C; Serial: TP-1303
- Measurement SW: DASY4, V4.7 Build 53; Postprocessing SW: SEMCAD, V1.8 Build 172

Ch11/Area Scan (81x181x1): Measurement grid: dx=15mm, dy=15mm

Maximum value of SAR (interpolated) = 0.118 mW/g

Ch11/Zoom Scan (5x5x7)/Cube 0: Measurement grid: dx=8mm, dy=8mm, dz=5mm

Reference Value = 7.23 V/m; Power Drift = -0.141 dB

Peak SAR (extrapolated) = 0.230 W/kg

SAR(1 g) = 0.100 mW/g; SAR(10 g) = 0.050 mW/g

Maximum value of SAR (measured) = 0.106 mW/g

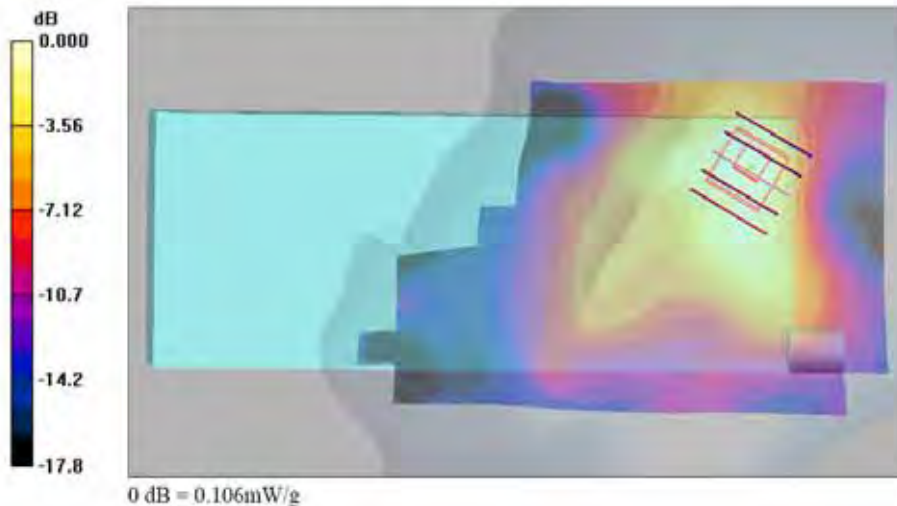



Test Laboratory: Sporton International Inc. SAR Testing Lab

Date/Time: 2/12/2007 10:20:47 PM

Body_802.11b Ch6_Keypad Up with 1.5cm Gap_20070212_PC528

DUT: 710211-01

Communication System: 802.11b ; Frequency: 2437 MHz; Duty Cycle: 1:1

Medium: MSL_2450 Medium parameters used: $f = 2437$ MHz; $\sigma = 1.94$ mho/m; $\epsilon_r = 52.7$; $\rho = 1000$ kg/m³

Ambient Temperature : 21.8 °C; Liquid Temperature : 21.0 °C

DASY4 Configuration:

- Probe: ET3DV6 - SN1788; ConvF(4.11, 4.11, 4.11); Calibrated: 9/19/2006

- Sensor-Surface: 4mm (Mechanical And Optical Surface Detection)

- Electronics: DAE3 Sn577; Calibrated: 11/21/2006

- Phantom: SAM-A; Type: QD 000 P40 C; Serial: TP-1303

- Measurement SW: DASY4, V4.7 Build 44; Postprocessing SW: SEMCAD, V1.8 Build 171

Ch6/Area Scan (71x191x1): Measurement grid: dx=15mm, dy=15mm

Maximum value of SAR (interpolated) = 0.014 mW/g

Ch6/Zoom Scan (5x5x7)/Cube 0: Measurement grid: dx=8mm, dy=8mm, dz=5mm

Reference Value = 1.04 V/m; Power Drift = 0.171 dB

Peak SAR (extrapolated) = 0.016 W/kg

SAR(1 g) = 0.011 mW/g; SAR(10 g) = 0.00593 mW/g

Maximum value of SAR (measured) = 0.014 mW/g

Ch6/Zoom Scan (5x5x7)/Cube 1: Measurement grid: dx=8mm, dy=8mm, dz=5mm

Reference Value = 1.04 V/m; Power Drift = 0.171 dB

Peak SAR (extrapolated) = 0.032 W/kg

SAR(1 g) = 0.010 mW/g; SAR(10 g) = 0.00519 mW/g

Maximum value of SAR (measured) = 0.012 mW/g

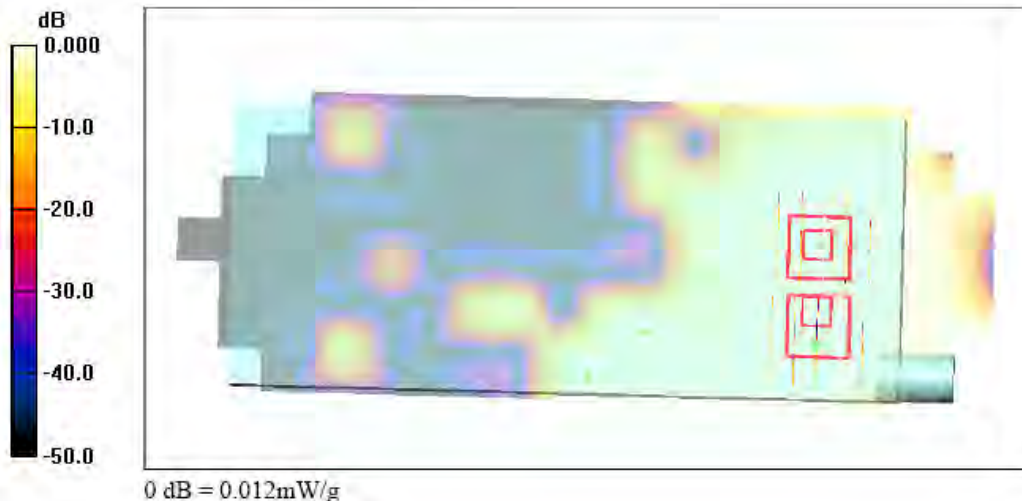



Test Laboratory: Sporton International Inc. SAR Testing Lab

Date/Time: 2/13/2007 3:09:43 AM

Body_802.11b Ch6 Keypad Up with 1.5cm Gap_20070212_PC528_Bluetooth On

DUT: 710211-01

Communication System: 802.11b ; Frequency: 2437 MHz; Duty Cycle: 1:1

Medium: MSL_2450 Medium parameters used: $f = 2437$ MHz; $\sigma = 1.94$ mho/m; $\epsilon_r = 52.7$; $\rho = 1000$ kg/m³

Ambient Temperature : 21.6 °C; Liquid Temperature : 21.0 °C

DASY4 Configuration:

- Probe: ET3DV6 - SN1788; ConvF(4.11, 4.11, 4.11); Calibrated: 9/19/2006

- Sensor-Surface: 4mm (Mechanical And Optical Surface Detection)

- Electronics: DAE3 Sn577; Calibrated: 11/21/2006

- Phantom: SAM-A; Type: QD 000 P40 C; Serial: TP-1303

- Measurement SW: DASY4, V4.7 Build 44; Postprocessing SW: SEMCAD, V1.8 Build 171

Ch6/Area Scan (71x191x1): Measurement grid: dx=15mm, dy=15mm

Maximum value of SAR (interpolated) = 0.011 mW/g

Ch6/Zoom Scan (5x5x7)/Cube 0: Measurement grid: dx=8mm, dy=8mm, dz=5mm

Reference Value = 1.14 V/m; Power Drift = -0.171 dB

Peak SAR (extrapolated) = 0.034 W/kg

SAR(1 g) = 0.012 mW/g; SAR(10 g) = 0.004 mW/g

Maximum value of SAR (measured) = 0.011 mW/g

Ch6/Zoom Scan (5x5x7)/Cube 1: Measurement grid: dx=8mm, dy=8mm, dz=5mm

Reference Value = 1.14 V/m; Power Drift = -0.171 dB

Peak SAR (extrapolated) = 0.003 W/kg

SAR(1 g) = 4.96e-005 mW/g; SAR(10 g) = 1.01e-005 mW/g

Maximum value of SAR (measured) = 0.003 mW/g



0 dB = 0.003mW/g



Test Laboratory: Sporton International Inc. SAR Testing Lab

Date/Time: 2/12/2007 10:55:51 PM

Body_802.11b Ch6_Keypad Down with 1.5cm Gap_20070212_PC528

DUT: 710211-01

Communication System: 802.11b ; Frequency: 2437 MHz; Duty Cycle: 1:1

Medium: MSL_2450 Medium parameters used: $f = 2437$ MHz; $\sigma = 1.94$ mho/m; $\epsilon_r = 52.7$; $\rho = 1000$ kg/m³

Ambient Temperature : 21.9 °C ; Liquid Temperature : 21.0 °C

DASY4 Configuration:

- Probe: ET3DV6 - SN1788; ConvF(4.11, 4.11, 4.11); Calibrated: 9/19/2006

- Sensor-Surface: 4mm (Mechanical And Optical Surface Detection)

- Electronics: DAE3 Sn577; Calibrated: 11/21/2006

- Phantom: SAM-A; Type: QD 000 P40 C; Serial: TP-1303

- Measurement SW: DASY4, V4.7 Build 44; Postprocessing SW: SEMCAD, V1.8 Build 171

Ch6/Area Scan (71x191x1): Measurement grid: dx=15mm, dy=15mm

Maximum value of SAR (interpolated) = 0.013 mW/g

Ch6/Zoom Scan (5x5x7)/Cube 0: Measurement grid: dx=8mm, dy=8mm, dz=5mm

Reference Value = 1.69 V/m; Power Drift = -0.116 dB

Peak SAR (extrapolated) = 0.016 W/kg

SAR(1 g) = 0.011 mW/g; SAR(10 g) = 0.00582 mW/g

Maximum value of SAR (measured) = 0.013 mW/g

Ch6/Zoom Scan (5x5x7)/Cube 1: Measurement grid: dx=8mm, dy=8mm, dz=5mm

Reference Value = 1.69 V/m; Power Drift = -0.116 dB

Peak SAR (extrapolated) = 0.029 W/kg

SAR(1 g) = 0.011 mW/g; SAR(10 g) = 0.00511 mW/g

Maximum value of SAR (measured) = 0.012 mW/g

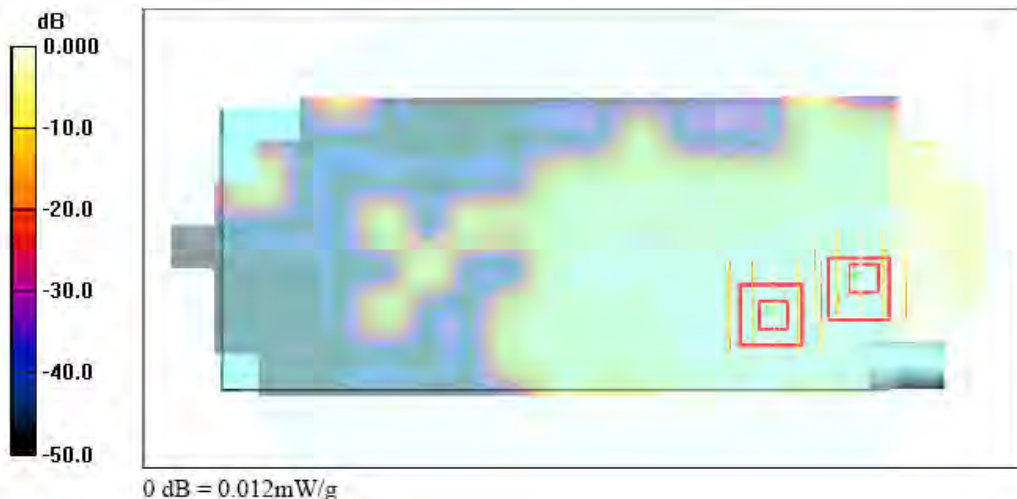



Test Laboratory: Sporton International Inc. SAR Testing Lab

Date/Time: 2/12/2007 11:42:34 PM

Body_802.11g Ch6_Keypad Up with 1.5cm Gap_20070212_PC528

DUT: 710211-01

Communication System: 802.11g; Frequency: 2437 MHz; Duty Cycle: 1:1

Medium: MSL_2450 Medium parameters used: $f = 2437$ MHz; $\sigma = 1.94$ mho/m; $\epsilon_r = 52.7$; $\rho = 1000$ kg/m³

Ambient Temperature : 21.8 °C; Liquid Temperature : 21.0 °C

DASY4 Configuration:

- Probe: ET3DV6 - SN1788; ConvF(4.11, 4.11, 4.11); Calibrated: 9/19/2006

- Sensor-Surface: 4mm (Mechanical And Optical Surface Detection)

- Electronics: DAE3 Sn577; Calibrated: 11/21/2006

- Phantom: SAM-A; Type: QD 000 P40 C; Serial: TP-1303

- Measurement SW: DASY4, V4.7 Build 44; Postprocessing SW: SEMCAD, V1.8 Build 171

Ch6/Area Scan (71x191x1): Measurement grid: dx=15mm, dy=15mm

Maximum value of SAR (interpolated) = 0.009 mW/g

Ch6/Zoom Scan (5x5x7)/Cube 1: Measurement grid: dx=8mm, dy=8mm, dz=5mm

Reference Value = 0.785 V/m; Power Drift = 0.174 dB

Peak SAR (extrapolated) = 0.031 W/kg

SAR(1 g) = 0.0067 mW/g; SAR(10 g) = 0.00274 mW/g

Maximum value of SAR (measured) = 0.005 mW/g

Ch6/Zoom Scan (5x5x7)/Cube 0: Measurement grid: dx=8mm, dy=8mm, dz=5mm

Reference Value = 0.785 V/m; Power Drift = 0.174 dB

Peak SAR (extrapolated) = 0.015 W/kg

SAR(1 g) = 0.00385 mW/g; SAR(10 g) = 0.00119 mW/g

Maximum value of SAR (measured) = 0.004 mW/g





Test Laboratory: Sporton International Inc. SAR Testing Lab

Date/Time: 2/13/2007 12:10:44 PM

Right Cheek_802.11b Ch11_20070212_PC529_Bluetooth On

DUT: 710211-01

Communication System: 802.11b ; Frequency: 2462 MHz;Duty Cycle: 1:1

Medium: HSL_2450 Medium parameters used: $f = 2462$ MHz; $\sigma = 1.78$ mho/m; $\epsilon_r = 38$; $\rho = 1000$ kg/m³

Ambient Temperature : 21.7 °C; Liquid Temperature : 20.8 °C

DASY4 Configuration:

- Probe: ET3DV6 - SN1788; ConvF(4.66, 4.66, 4.66); Calibrated: 9/19/2006
- Sensor-Surface: 4mm (Mechanical And Optical Surface Detection)
- Electronics: DAE3 Sn577; Calibrated: 11/21/2006
- Phantom: SAM-B; Type: QD 000 P40 C; Serial: TP-1383
- Measurement SW: DASY4, V4.7 Build 44; Postprocessing SW: SEMCAD, V1.8 Build 171

Ch11/Area Scan (71x171x1): Measurement grid: dx=15mm, dy=15mm

Maximum value of SAR (interpolated) = 0.099 mW/g

Ch11/Zoom Scan (5x5x7)/Cube 0: Measurement grid: dx=8mm, dy=8mm, dz=5mm

Reference Value = 4.63 V/m; Power Drift = -0.068 dB

Peak SAR (extrapolated) = 0.178 W/kg

SAR(1 g) = 0.084 mW/g; SAR(10 g) = 0.040 mW/g

Maximum value of SAR (measured) = 0.095 mW/g

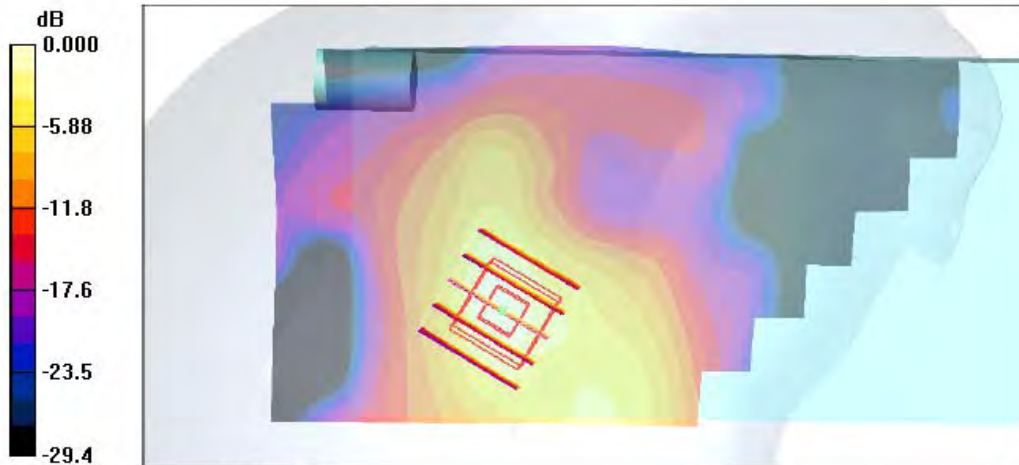



Test Laboratory: Sporton International Inc. SAR Testing Lab

Date/Time: 2/13/2007 5:07:53 AM

Body_802.11b Ch6_Keypad Up with 1.5cm Gap_20070212_PC529_Bluetooth On

DUT: 710211-01

Communication System: 802.11b : Frequency: 2437 MHz;Duty Cycle: 1:1

Medium: MSL_2450 Medium parameters used: $f = 2437$ MHz; $\sigma = 1.94$ mho/m; $\epsilon_r = 52.7$; $\rho = 1000$ kg/m³

Ambient Temperature : 21.8 °C; Liquid Temperature : 21.0 °C

DASY4 Configuration:

- Probe: ET3DV6 - SN1788; ConvF(4.11, 4.11, 4.11); Calibrated: 9/19/2006

- Sensor-Surface: 4mm (Mechanical And Optical Surface Detection)

- Electronics: DAE3 Sn577; Calibrated: 11/21/2006

- Phantom: SAM-A; Type: QD 000 P40 C; Serial: TP-1303

- Measurement SW: DASY4, V4.7 Build 44; Postprocessing SW: SEMCAD, V1.8 Build 171

Ch6/Area Scan (71x171x1): Measurement grid: dx=15mm, dy=15mm

Maximum value of SAR (interpolated) = 0.017 mW/g

Ch6/Zoom Scan (5x5x7)/Cube 0: Measurement grid: dx=8mm, dy=8mm, dz=5mm

Reference Value = 0.000 V/m; Power Drift = 0.106 dB

Peak SAR (extrapolated) = 0.018 W/kg

SAR(1 g) = 0.014 mW/g; SAR(10 g) = 0.0069 mW/g

Maximum value of SAR (measured) = 0.017 mW/g

Ch6/Zoom Scan (5x5x7)/Cube 1: Measurement grid: dx=8mm, dy=8mm, dz=5mm

Reference Value = 0.000 V/m; Power Drift = 0.106 dB

Peak SAR (extrapolated) = 0.036 W/kg

SAR(1 g) = 0.011 mW/g; SAR(10 g) = 0.00509 mW/g

Maximum value of SAR (measured) = 0.013 mW/g

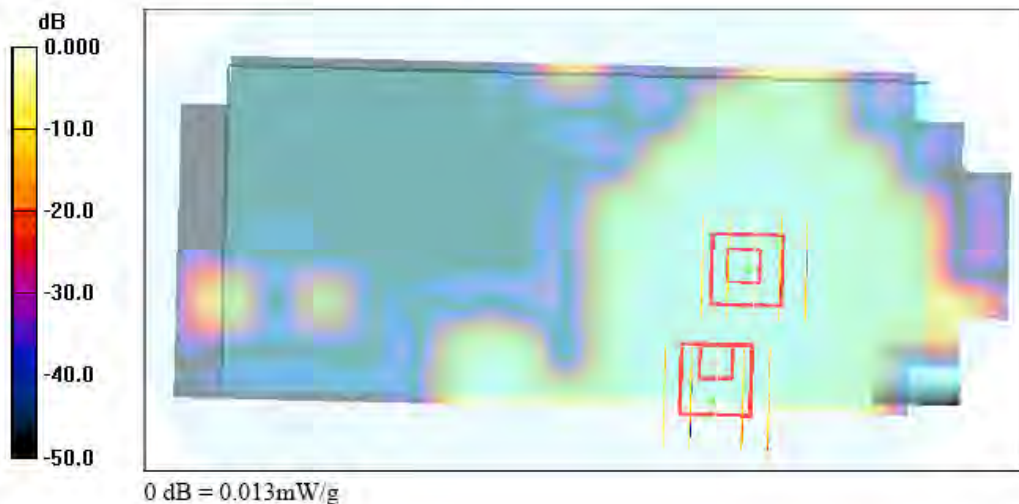



Test Laboratory: Sporton International Inc. SAR Testing Lab

Date: 2007/5/7

Body_802.11b Ch6_Holster Left Side Touch_7527C_Endcap 1_B2

Communication System: 802.11b ; Frequency: 2437 MHz;Duty Cycle: 1:1

Medium: MSL_2450 Medium parameters used: $f = 2437$ MHz; $\sigma = 1.95$ mho/m; $\epsilon_r = 53$; $\rho = 1000$ kg/m³

Ambient Temperature : 22.5 °C ; Liquid Temperature : 21.0 °C

DASY4 Configuration:

- Probe: ET3DV6 - SN1787; ConvF(4.13, 4.13, 4.13); Calibrated: 2006/5/31
- Sensor-Surface: 4mm (Mechanical Surface Detection)
- Electronics: DAE3 Sn577; Calibrated: 2006/11/21
- Phantom: SAM-B; Type: QD 000 P40 C; Serial: TP-1383
- Measurement SW: DASY4, V4.7 Build 53; Postprocessing SW: SEMCAD, V1.8 Build 172

Ch6/Area Scan (61x171x1): Measurement grid: dx=15mm, dy=15mm

Maximum value of SAR (interpolated) = 0.162 mW/g

Ch6/Zoom Scan (5x5x7)/Cube 0: Measurement grid: dx=8mm, dy=8mm, dz=5mm

Reference Value = 6.86 V/m; Power Drift = -0.168 dB

Peak SAR (extrapolated) = 0.309 W/kg

SAR(1 g) = 0.154 mW/g; SAR(10 g) = 0.087 mW/g

Maximum value of SAR (measured) = 0.164 mW/g

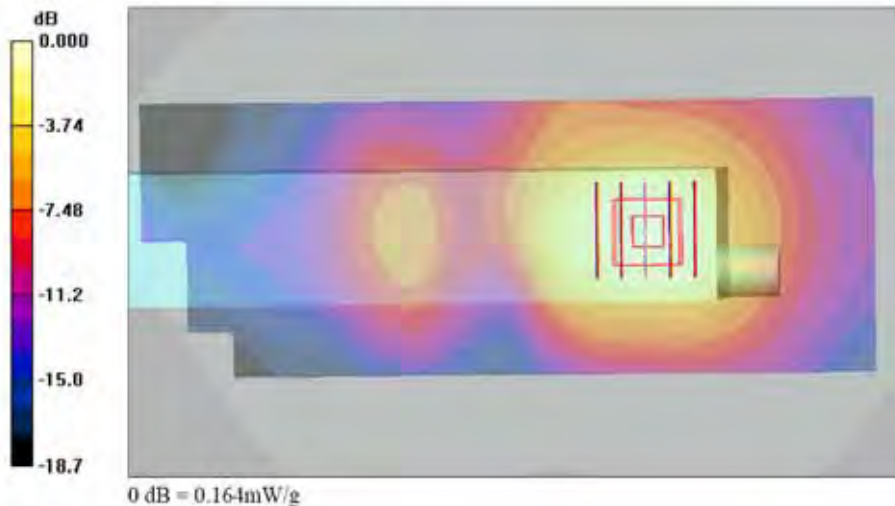



Test Laboratory: Sporton International Inc. SAR Testing Lab

Date: 2007/5/7

Body_802.11g_Ch6_Holster Left Side Touch_7527C_Endcap 1_B2

Communication System: 802.11g; Frequency: 2437 MHz; Duty Cycle: 1:1

Medium: MSL_2450 Medium parameters used: $f = 2437$ MHz; $\sigma = 1.95$ mho/m; $\epsilon_r = 53$; $\rho = 1000$ kg/m³

Ambient Temperature : 22.5 °C ; Liquid Temperature : 21.0 °C

DASY4 Configuration:

- Probe: ET3DV6 - SN1787; ConvF(4.13, 4.13, 4.13); Calibrated: 2006/5/31
- Sensor-Surface: 4mm (Mechanical Surface Detection)
- Electronics: DAE3 Sn577; Calibrated: 2006/11/21
- Phantom: SAM-B; Type: QD 000 P40 C; Serial: TP-1383
- Measurement SW: DASY4, V4.7 Build 53; Postprocessing SW: SEMCAD, V1.8 Build 172

Ch6/Area Scan (61x171x1): Measurement grid: dx=15mm, dy=15mm

Maximum value of SAR (interpolated) = 0.027 mW/g

Ch6/Zoom Scan (5x5x7)/Cube 0: Measurement grid: dx=8mm, dy=8mm, dz=5mm

Reference Value = 2.48 V/m; Power Drift = -0.125 dB

Peak SAR (extrapolated) = 0.046 W/kg

SAR(1 g) = 0.024 mW/g; SAR(10 g) = 0.013 mW/g

Maximum value of SAR (measured) = 0.026 mW/g

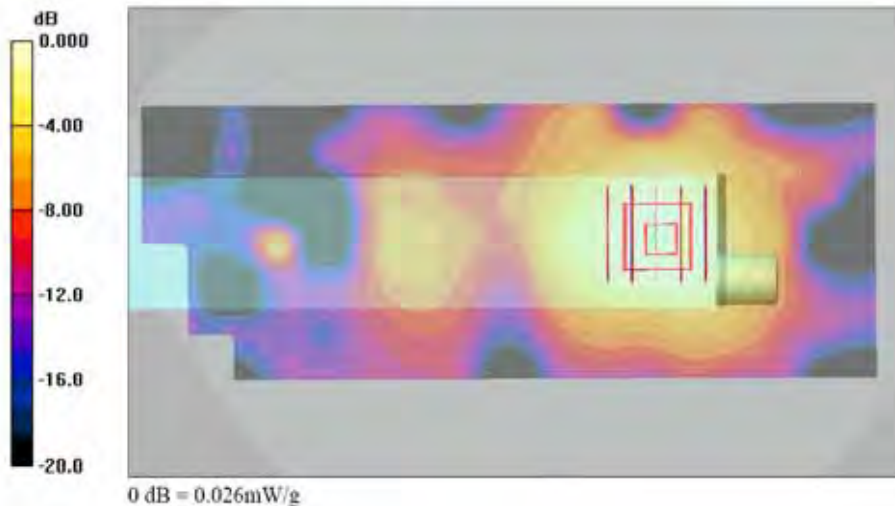



Test Laboratory: Sporton International Inc. SAR Testing Lab

Date: 2007/5/7

Body_802.11b Ch6_Holster Right Side Touch_7527C_Endcap 1_B2

Communication System: 802.11b ; Frequency: 2437 MHz;Duty Cycle: 1:1

Medium: MSL_2450 Medium parameters used: $f = 2437$ MHz; $\sigma = 1.95$ mho/m; $\epsilon_r = 53$; $\rho = 1000$ kg/m³

Ambient Temperature : 22.5 °C ; Liquid Temperature : 21.0 °C

DASY4 Configuration:

- Probe: ET3DV6 - SN1787; ConvF(4.13, 4.13, 4.13); Calibrated: 2006/5/31

- Sensor-Surface: 4mm (Mechanical Surface Detection)

- Electronics: DAE3 Sn577; Calibrated: 2006/11/21

- Phantom: SAM-B; Type: QD 000 P40 C; Serial: TP-1383

- Measurement SW: DASY4, V4.7 Build 53; Postprocessing SW: SEMCAD, V1.8 Build 172

Ch6/Area Scan (61x171x1): Measurement grid: dx=15mm, dy=15mm

Maximum value of SAR (interpolated) = 0.014 mW/g

Ch6/Zoom Scan (5x5x7)/Cube 0: Measurement grid: dx=8mm, dy=8mm, dz=5mm

Reference Value = 2.08 V/m; Power Drift = 0.107 dB

Peak SAR (extrapolated) = 0.020 W/kg

SAR(1 g) = 0.012 mW/g; SAR(10 g) = 0.00646 mW/g

Maximum value of SAR (measured) = 0.013 mW/g

Ch6/Zoom Scan (5x5x7)/Cube 1: Measurement grid: dx=8mm, dy=8mm, dz=5mm

Reference Value = 2.08 V/m; Power Drift = 0.107 dB

Peak SAR (extrapolated) = 0.019 W/kg

SAR(1 g) = 0.00959 mW/g; SAR(10 g) = 0.00574 mW/g

Maximum value of SAR (measured) = 0.012 mW/g

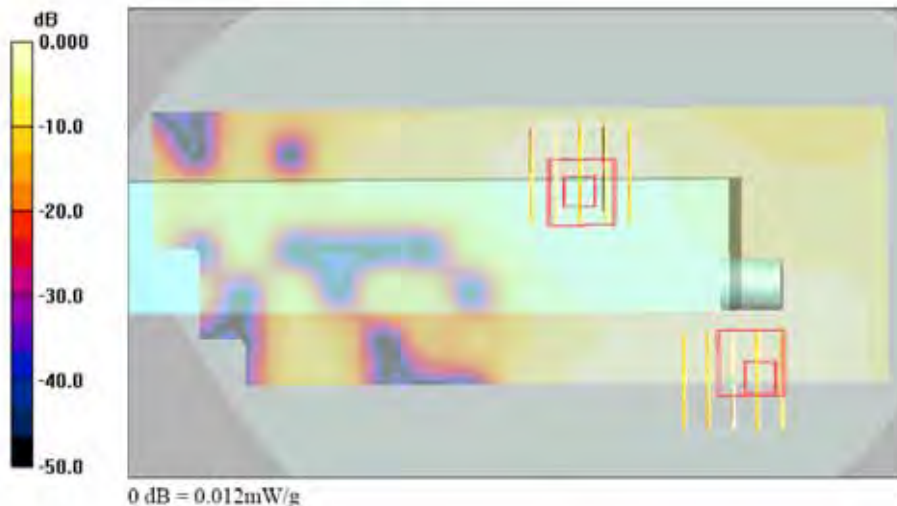



Test Laboratory: Sporton International Inc. SAR Testing Lab

Date: 2007/5/7

Body_802.11b Ch6_Holster Left Side Touch_7527C_POD 4_B2_BT On

Communication System: 802.11b : Frequency: 2437 MHz;Duty Cycle: 1:1

Medium: MSL_2450 Medium parameters used: $f = 2437$ MHz; $\sigma = 1.95$ mho/m; $\epsilon_r = 53$; $\rho = 1000$ kg/m³

Ambient Temperature : 22.3 °C; Liquid Temperature : 21.0 °C

DASY4 Configuration:

- Probe: ET3DV6 - SN1787; ConvF(4.13, 4.13, 4.13); Calibrated: 2006/5/31

- Sensor-Surface: 4mm (Mechanical Surface Detection)

- Electronics: DAE3 Sn577; Calibrated: 2006/11/21

- Phantom: SAM-B; Type: QD 000 P40 C; Serial: TP-1383

- Measurement SW: DASY4, V4.7 Build 53; Postprocessing SW: SEMCAD, V1.8 Build 172

Ch6/Area Scan (61x171x1): Measurement grid: dx=15mm, dy=15mm

Maximum value of SAR (interpolated) = 0.151 mW/g

Ch6/Zoom Scan (5x5x7)/Cube 0: Measurement grid: dx=8mm, dy=8mm, dz=5mm

Reference Value = 7.92 V/m; Power Drift = 0.116 dB

Peak SAR (extrapolated) = 0.278 W/kg

SAR(1 g) = 0.138 mW/g; SAR(10 g) = 0.079 mW/g

Maximum value of SAR (measured) = 0.145 mW/g

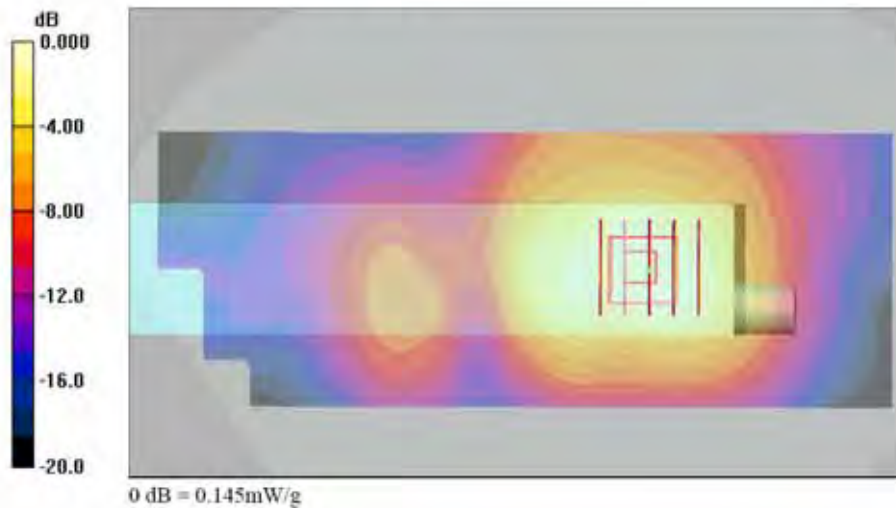



Test Laboratory: Sporton International Inc. SAR Testing Lab

Date: 2007/5/7

Body_802.11b Ch1_Holster Left Side Touch_7527C_Endcap 6_B2_BT On

Communication System: 802.11b : Frequency: 2412 MHz:Duty Cycle: 1:1

Medium: MSL_2450 Medium parameters used: $f = 2412$ MHz; $\sigma = 1.91$ mho/m; $\epsilon_r = 53$; $\rho = 1000$ kg/m³

Ambient Temperature : 22.2 °C; Liquid Temperature : 21.0 °C

DASY4 Configuration:

- Probe: ET3DV6 - SN1787; ConvF(4.13, 4.13, 4.13); Calibrated: 2006/5/31

- Sensor-Surface: 4mm (Mechanical Surface Detection)

- Electronics: DAE3 Sn577; Calibrated: 2006/11/21

- Phantom: SAM-B; Type: QD 000 P40 C; Serial: TP-1383

- Measurement SW: DASY4, V4.7 Build 53; Postprocessing SW: SEMCAD, V1.8 Build 172

Ch1/Area Scan (61x171x1): Measurement grid: dx=15mm, dy=15mm

Maximum value of SAR (interpolated) = 0.255 mW/g

Ch1/Zoom Scan (5x5x7)/Cube 0: Measurement grid: dx=8mm, dy=8mm, dz=5mm

Reference Value = 10.5 V/m; Power Drift = -0.192 dB

Peak SAR (extrapolated) = 0.439 W/kg

SAR(1 g) = 0.230 mW/g; SAR(10 g) = 0.128 mW/g

Maximum value of SAR (measured) = 0.249 mW/g

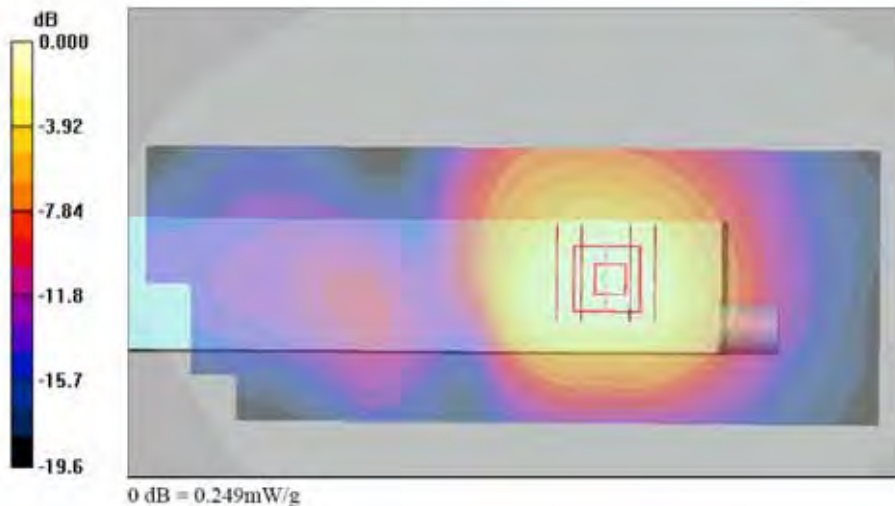



Test Laboratory: Sporton International Inc. SAR Testing Lab

Date: 2007/5/7

Body_802.11b Ch1_Holster Left Side Touch_7527S_Endcap 6_B2_BT On

Communication System: 802.11b : Frequency: 2412 MHz:Duty Cycle: 1:1

Medium: MSL_2450 Medium parameters used: $f = 2412$ MHz; $\sigma = 1.91$ mho/m; $\epsilon_r = 53$; $\rho = 1000$ kg/m³

Ambient Temperature : 22.4 °C; Liquid Temperature : 21.5 °C

DASY4 Configuration:

- Probe: ET3DV6 - SN1787; ConvF(4.13, 4.13, 4.13); Calibrated: 2006/5/31

- Sensor-Surface: 4mm (Mechanical Surface Detection)

- Electronics: DAE3 Sn577; Calibrated: 2006/11/21

- Phantom: SAM-B; Type: QD 000 P40 C; Serial: TP-1383

- Measurement SW: DASY4, V4.7 Build 53; Postprocessing SW: SEMCAD, V1.8 Build 172

Ch1/Area Scan (61x171x1): Measurement grid: dx=15mm, dy=15mm

Maximum value of SAR (interpolated) = 0.257 mW/g

Ch1/Zoom Scan (5x5x7)/Cube 0: Measurement grid: dx=8mm, dy=8mm, dz=5mm

Reference Value = 10.5 V/m; Power Drift = -0.147 dB

Peak SAR (extrapolated) = 0.463 W/kg

SAR(1 g) = 0.234 mW/g; SAR(10 g) = 0.134 mW/g

Maximum value of SAR (measured) = 0.244 mW/g

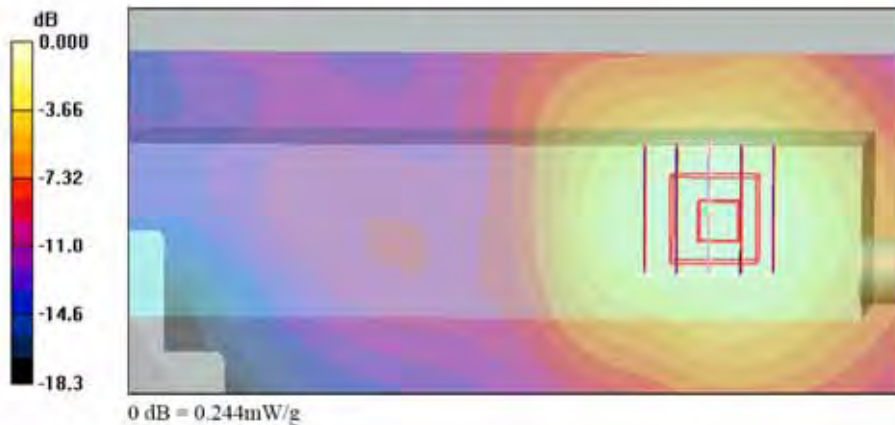



Test Laboratory: Sporton International Inc. SAR Testing Lab

Date: 2007/5/7

Body_802.11b Ch6_Holster Left Side Touch_7527C_POD 6_B2_BT On

Communication System: 802.11b : Frequency: 2437 MHz;Duty Cycle: 1:1

Medium: MSL_2450 Medium parameters used: $f = 2437$ MHz; $\sigma = 1.95$ mho/m; $\epsilon_r = 53$; $\rho = 1000$ kg/m³

Ambient Temperature : 22.1 °C; Liquid Temperature : 21.0 °C

DASY4 Configuration:

- Probe: ET3DV6 - SN1787; ConvF(4.13, 4.13, 4.13); Calibrated: 2006/5/31

- Sensor-Surface: 4mm (Mechanical Surface Detection)

- Electronics: DAE3 Sn577; Calibrated: 2006/11/21

- Phantom: SAM-B; Type: QD 000 P40 C; Serial: TP-1383

- Measurement SW: DASY4, V4.7 Build 53; Postprocessing SW: SEMCAD, V1.8 Build 172

Ch6/Area Scan (61x171x1): Measurement grid: dx=15mm, dy=15mm

Maximum value of SAR (interpolated) = 0.183 mW/g

Ch6/Zoom Scan (5x5x7)/Cube 0: Measurement grid: dx=8mm, dy=8mm, dz=5mm

Reference Value = 8.71 V/m; Power Drift = 0.022 dB

Peak SAR (extrapolated) = 0.324 W/kg

SAR(1 g) = 0.172 mW/g; SAR(10 g) = 0.097 mW/g

Maximum value of SAR (measured) = 0.185 mW/g

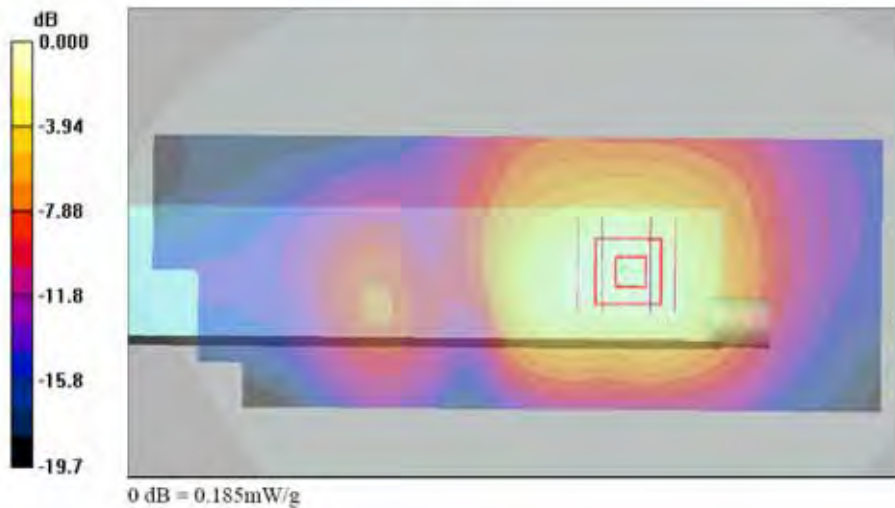



Test Laboratory: Sporton International Inc. SAR Testing Lab

Date: 2007/5/7

Body_802.11b Ch6_Holster Left Side Touch_7527C_POD 6_B2_BT On

Communication System: 802.11b : Frequency: 2437 MHz;Duty Cycle: 1:1

Medium: MSL_2450 Medium parameters used: $f = 2437$ MHz; $\sigma = 1.95$ mho/m; $\epsilon_r = 53$; $\rho = 1000$ kg/m³

Ambient Temperature : 22.1 °C; Liquid Temperature : 21.0 °C

DASY4 Configuration:

- Probe: ET3DV6 - SN1787; ConvF(4.13, 4.13, 4.13); Calibrated: 2006/5/31

- Sensor-Surface: 4mm (Mechanical Surface Detection)

- Electronics: DAE3 Sn577; Calibrated: 2006/11/21

- Phantom: SAM-B; Type: QD 000 P40 C; Serial: TP-1383

- Measurement SW: DASY4, V4.7 Build 53; Postprocessing SW: SEMCAD, V1.8 Build 172

Ch6/Area Scan (61x171x1): Measurement grid: dx=15mm, dy=15mm

Maximum value of SAR (interpolated) = 0.183 mW/g

Ch6/Zoom Scan (5x5x7)/Cube 0: Measurement grid: dx=8mm, dy=8mm, dz=5mm

Reference Value = 8.71 V/m; Power Drift = 0.022 dB

Peak SAR (extrapolated) = 0.324 W/kg

SAR(1 g) = 0.172 mW/g; SAR(10 g) = 0.097 mW/g

Maximum value of SAR (measured) = 0.185 mW/g

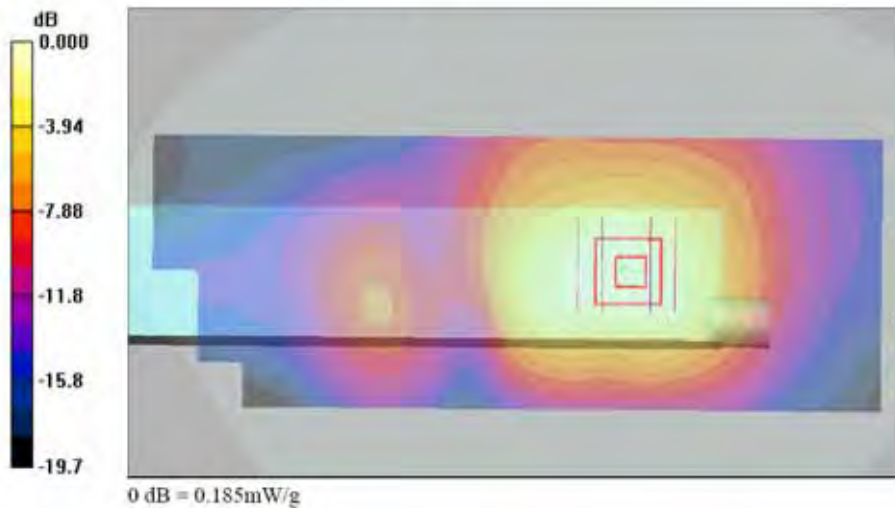



Test Laboratory: Sporton International Inc. SAR Testing Lab

Date: 2007/5/7

Body_802.11b Ch6_Holster Left Side Touch_7527C_Endcap 6_B2_BT On

Communication System: 802.11b : Frequency: 2437 MHz;Duty Cycle: 1:1

Medium: MSL_2450 Medium parameters used: $f = 2437$ MHz; $\sigma = 1.95$ mho/m; $\epsilon_r = 53$; $\rho = 1000$ kg/m³

Ambient Temperature : 22.1 °C; Liquid Temperature : 21.0 °C

DASY4 Configuration:

- Probe: ET3DV6 - SN1787; ConvF(4.13, 4.13, 4.13); Calibrated: 2006/5/31

- Sensor-Surface: 4mm (Mechanical Surface Detection)

- Electronics: DAE3 Sn577; Calibrated: 2006/11/21

- Phantom: SAM-B; Type: QD 000 P40 C; Serial: TP-1383

- Measurement SW: DASY4, V4.7 Build 53; Postprocessing SW: SEMCAD, V1.8 Build 172

Ch6/Area Scan (61x171x1): Measurement grid: dx=15mm, dy=15mm

Maximum value of SAR (interpolated) = 0.210 mW/g

Ch6/Zoom Scan (5x5x7)/Cube 0: Measurement grid: dx=8mm, dy=8mm, dz=5mm

Reference Value = 9.57 V/m; Power Drift = -0.120 dB

Peak SAR (extrapolated) = 0.453 W/kg

SAR(1 g) = 0.216 mW/g; SAR(10 g) = 0.117 mW/g

Maximum value of SAR (measured) = 0.236 mW/g

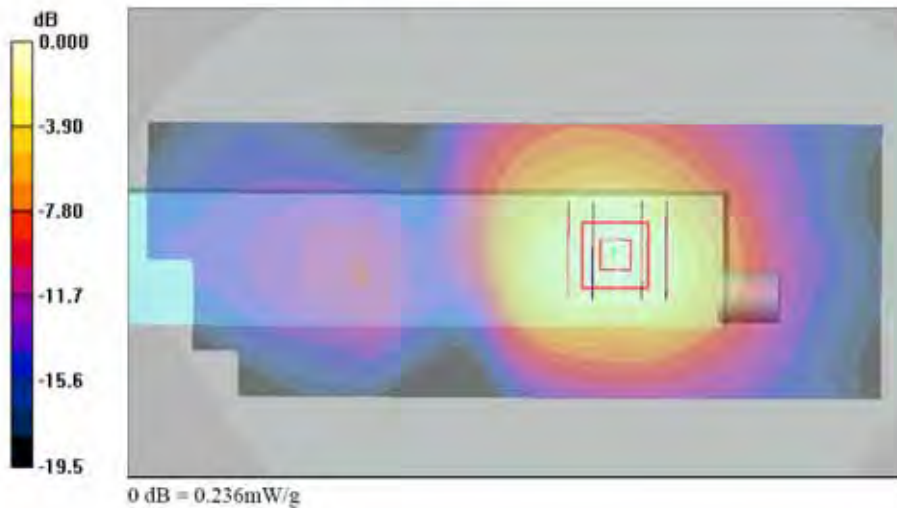



Test Laboratory: Sporton International Inc. SAR Testing Lab

Date: 2007/5/7

Body_802.11b Ch6_Holster Left Side Touch_7527C_Endcap 3_B2_BT On

Communication System: 802.11b : Frequency: 2437 MHz;Duty Cycle: 1:1

Medium: MSL_2450 Medium parameters used: $f = 2437$ MHz; $\sigma = 1.95$ mho/m; $\epsilon_r = 53$; $\rho = 1000$ kg/m³

Ambient Temperature : 22.0 °C; Liquid Temperature : 21.0 °C

DASY4 Configuration:

- Probe: ET3DV6 - SN1787; ConvF(4.13, 4.13, 4.13); Calibrated: 2006/5/31

- Sensor-Surface: 4mm (Mechanical Surface Detection)

- Electronics: DAE3 Sn577; Calibrated: 2006/11/21

- Phantom: SAM-B; Type: QD 000 P40 C; Serial: TP-1383

- Measurement SW: DASY4, V4.7 Build 53; Postprocessing SW: SEMCAD, V1.8 Build 172

Ch6/Area Scan (61x171x1): Measurement grid: dx=15mm, dy=15mm

Maximum value of SAR (interpolated) = 0.213 mW/g

Ch6/Zoom Scan (5x5x7)/Cube 0: Measurement grid: dx=8mm, dy=8mm, dz=5mm

Reference Value = 8.79 V/m; Power Drift = -0.165 dB

Peak SAR (extrapolated) = 0.418 W/kg

SAR(1 g) = 0.198 mW/g; SAR(10 g) = 0.108 mW/g

Maximum value of SAR (measured) = 0.211 mW/g

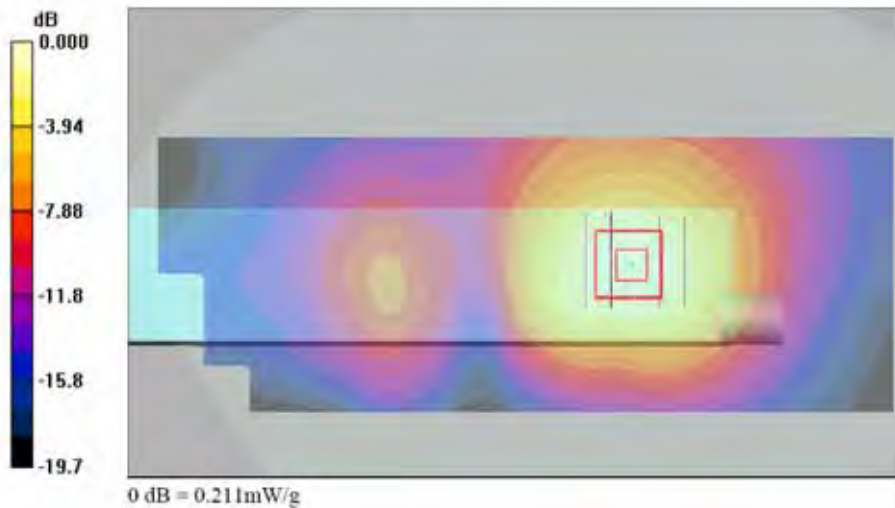



Test Laboratory: Sporton International Inc. SAR Testing Lab

Date: 2007/5/7

Body_802.11b Ch6_Holster Left Side Touch_7527C_Endcap 2_B2_BT On

Communication System: 802.11b : Frequency: 2437 MHz;Duty Cycle: 1:1

Medium: MSL_2450 Medium parameters used: $f = 2437$ MHz; $\sigma = 1.95$ mho/m; $\epsilon_r = 53$; $\rho = 1000$ kg/m³

Ambient Temperature : 22.5 °C; Liquid Temperature : 21.0 °C

DASY4 Configuration:

- Probe: ET3DV6 - SN1787; ConvF(4.13, 4.13, 4.13); Calibrated: 2006/5/31

- Sensor-Surface: 4mm (Mechanical Surface Detection)

- Electronics: DAE3 Sn577; Calibrated: 2006/11/21

- Phantom: SAM-B; Type: QD 000 P40 C; Serial: TP-1383

- Measurement SW: DASY4, V4.7 Build 53; Postprocessing SW: SEMCAD, V1.8 Build 172

Ch6/Area Scan (61x171x1): Measurement grid: dx=15mm, dy=15mm

Maximum value of SAR (interpolated) = 0.177 mW/g

Ch6/Zoom Scan (5x5x7)/Cube 0: Measurement grid: dx=8mm, dy=8mm, dz=5mm

Reference Value = 7.04 V/m; Power Drift = -0.079 dB

Peak SAR (extrapolated) = 0.347 W/kg

SAR(1 g) = 0.169 mW/g; SAR(10 g) = 0.094 mW/g

Maximum value of SAR (measured) = 0.178 mW/g

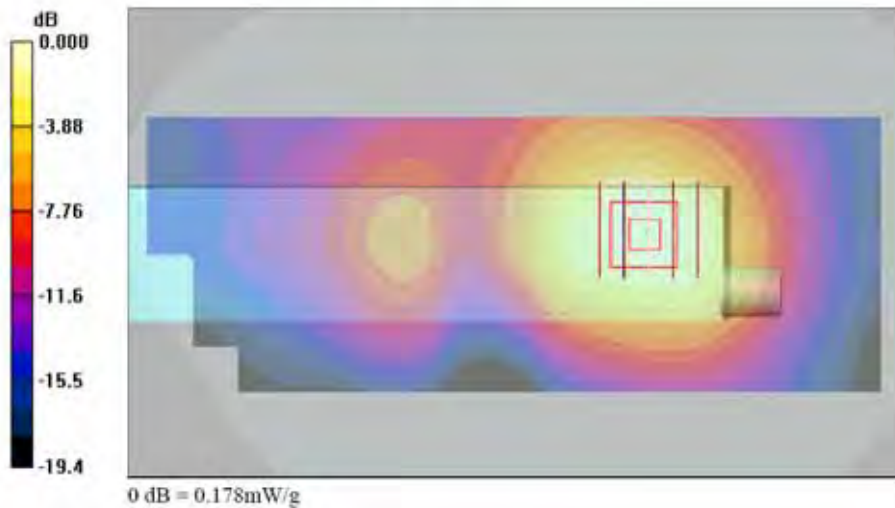



Test Laboratory: Sporton International Inc. SAR Testing Lab

Date: 2007/5/7

Body_802.11b Ch6_Holster Left Side Touch_7527C_Endcap 6_B3_BT On

Communication System: 802.11b : Frequency: 2437 MHz;Duty Cycle: 1:1

Medium: MSL_2450 Medium parameters used: $f = 2437$ MHz; $\sigma = 1.95$ mho/m; $\epsilon_r = 53$; $\rho = 1000$ kg/m³

Ambient Temperature : 22.4 °C; Liquid Temperature : 21.0 °C

DASY4 Configuration:

- Probe: ET3DV6 - SN1787; ConvF(4.13, 4.13, 4.13); Calibrated: 2006/5/31

- Sensor-Surface: 4mm (Mechanical Surface Detection)

- Electronics: DAE3 Sn577; Calibrated: 2006/11/21

- Phantom: SAM-B; Type: QD 000 P40 C; Serial: TP-1383

- Measurement SW: DASY4, V4.7 Build 53; Postprocessing SW: SEMCAD, V1.8 Build 172

Ch6/Area Scan (61x171x1): Measurement grid: dx=15mm, dy=15mm

Maximum value of SAR (interpolated) = 0.207 mW/g

Ch6/Zoom Scan (5x5x7)/Cube 0: Measurement grid: dx=8mm, dy=8mm, dz=5mm

Reference Value = 9.33 V/m; Power Drift = 0.114 dB

Peak SAR (extrapolated) = 0.381 W/kg

SAR(1 g) = 0.197 mW/g; SAR(10 g) = 0.110 mW/g

Maximum value of SAR (measured) = 0.212 mW/g

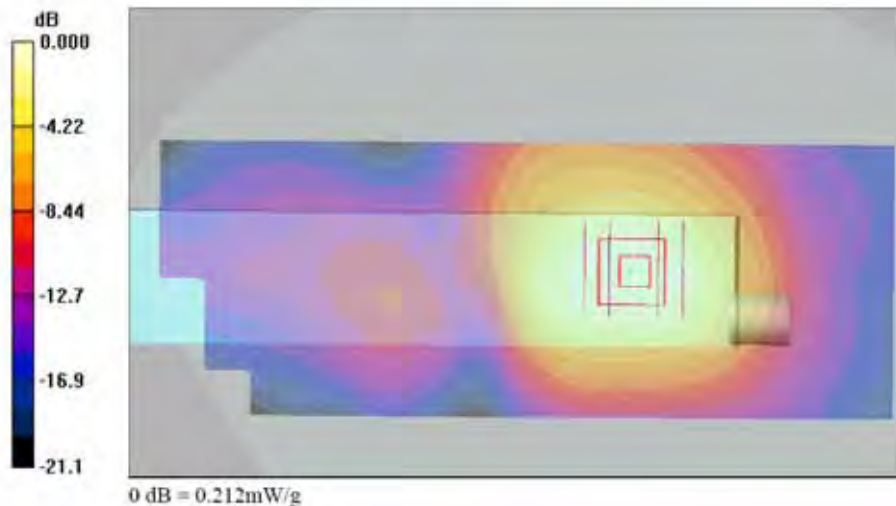



Test Laboratory: Sporton International Inc. SAR Testing Lab

Date: 2007/5/7

Body_802.11b Ch6_Holster Left Side Touch_7527C_POD 3_B2_BT On

Communication System: 802.11b : Frequency: 2437 MHz;Duty Cycle: 1:1
Medium: MSL_2450 Medium parameters used: f = 2437 MHz; sigma = 1.95 mho/m; epsilon_r = 53; rho = 1000 kg/m^3
Ambient Temperature : 22.2 C; Liquid Temperature : 21.0 C

DASY4 Configuration:

- Probe: ET3DV6 - SN1787; ConvF(4.13, 4.13, 4.13); Calibrated: 2006/5/31
- Sensor-Surface: 4mm (Mechanical Surface Detection)
- Electronics: DAE3 Sn577; Calibrated: 2006/11/21
- Phantom: SAM-B; Type: QD 000 P40 C; Serial: TP-1383
- Measurement SW: DASY4, V4.7 Build 53; Postprocessing SW: SEMCAD, V1.8 Build 172

Ch6/Area Scan (61x171x1): Measurement grid: dx=15mm, dy=15mm
Maximum value of SAR (interpolated) = 0.161 mW/g

Ch6/Zoom Scan (5x5x7)/Cube 0: Measurement grid: dx=8mm, dy=8mm, dz=5mm
Reference Value = 8.52 V/m; Power Drift = -0.149 dB
Peak SAR (extrapolated) = 0.304 W/kg
SAR(1 g) = 0.152 mW/g; SAR(10 g) = 0.085 mW/g
Maximum value of SAR (measured) = 0.162 mW/g

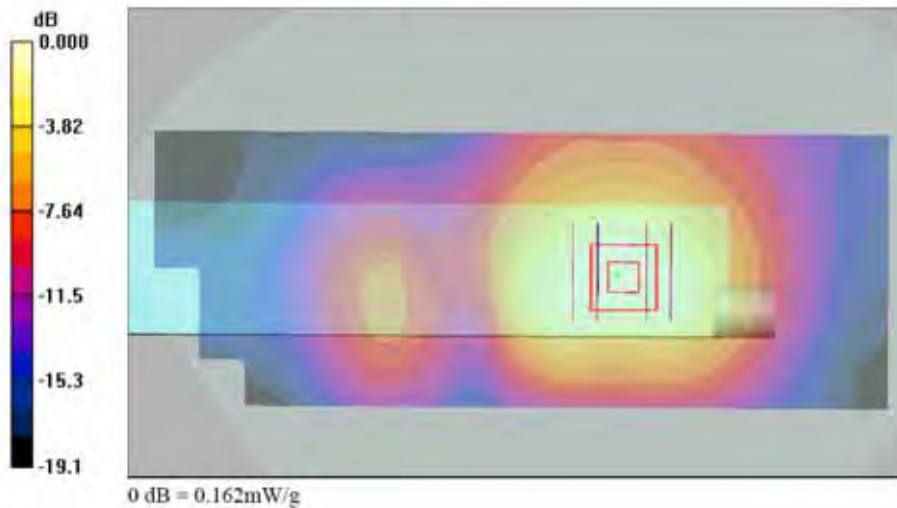



Test Laboratory: Sporton International Inc. SAR Testing Lab

Date: 2007/5/7

Body_802.11b Ch6_Holster Left Side Touch_7527C_POD 1_B2_BT On

Communication System: 802.11b : Frequency: 2437 MHz;Duty Cycle: 1:1

Medium: MSL_2450 Medium parameters used: $f = 2437$ MHz; $\sigma = 1.95$ mho/m; $\epsilon_r = 53$; $\rho = 1000$ kg/m³

Ambient Temperature : 22.6 °C; Liquid Temperature : 21.0 °C

DASY4 Configuration:

- Probe: ET3DV6 - SN1787; ConvF(4.13, 4.13, 4.13); Calibrated: 2006/5/31

- Sensor-Surface: 4mm (Mechanical Surface Detection)

- Electronics: DAE3 Sn577; Calibrated: 2006/11/21

- Phantom: SAM-B; Type: QD 000 P40 C; Serial: TP-1383

- Measurement SW: DASY4, V4.7 Build 53; Postprocessing SW: SEMCAD, V1.8 Build 172

Ch6/Area Scan (61x171x1): Measurement grid: dx=15mm, dy=15mm

Maximum value of SAR (interpolated) = 0.145 mW/g

Ch6/Zoom Scan (5x5x7)/Cube 0: Measurement grid: dx=8mm, dy=8mm, dz=5mm

Reference Value = 7.59 V/m; Power Drift = -0.106 dB

Peak SAR (extrapolated) = 0.254 W/kg

SAR(1 g) = 0.132 mW/g; SAR(10 g) = 0.074 mW/g

Maximum value of SAR (measured) = 0.138 mW/g

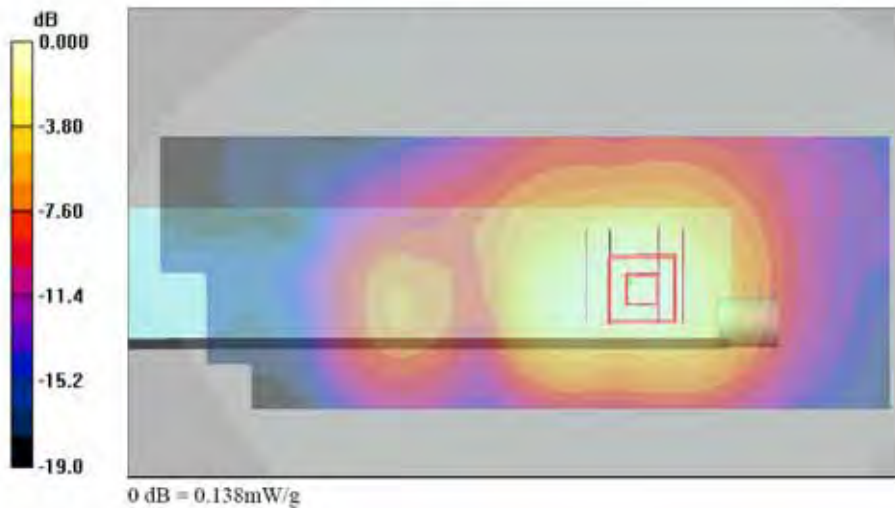



Test Laboratory: Sporton International Inc. SAR Testing Lab

Date: 2007/5/7

Body_802.11b Ch6_Holster Left Side Touch_7527C_Endcap 4_B2_BT On

Communication System: 802.11b : Frequency: 2437 MHz;Duty Cycle: 1:1

Medium: MSL_2450 Medium parameters used: $f = 2437$ MHz; $\sigma = 1.95$ mho/m; $\epsilon_r = 53$; $\rho = 1000$ kg/m³

Ambient Temperature : 22.2 °C; Liquid Temperature : 21.0 °C

DASY4 Configuration:

- Probe: ET3DV6 - SN1787; ConvF(4.13, 4.13, 4.13); Calibrated: 2006/5/31

- Sensor-Surface: 4mm (Mechanical Surface Detection)

- Electronics: DAE3 Sn577; Calibrated: 2006/11/21

- Phantom: SAM-B; Type: QD 000 P40 C; Serial: TP-1383

- Measurement SW: DASY4, V4.7 Build 53; Postprocessing SW: SEMCAD, V1.8 Build 172

Ch6/Area Scan (61x171x1): Measurement grid: dx=15mm, dy=15mm

Maximum value of SAR (interpolated) = 0.169 mW/g

Ch6/Zoom Scan (5x5x7)/Cube 0: Measurement grid: dx=8mm, dy=8mm, dz=5mm

Reference Value = 8.77 V/m; Power Drift = 0.127 dB

Peak SAR (extrapolated) = 0.317 W/kg

SAR(1 g) = 0.162 mW/g; SAR(10 g) = 0.090 mW/g

Maximum value of SAR (measured) = 0.176 mW/g

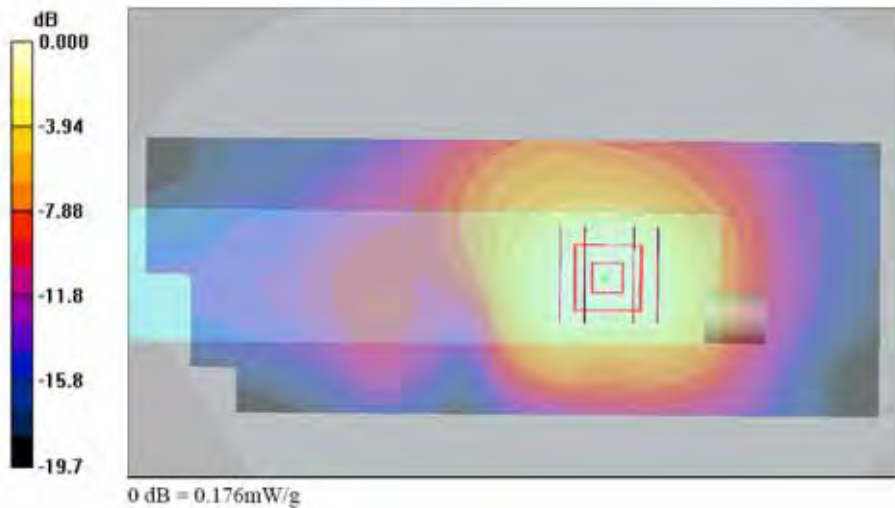



Test Laboratory: Sporton International Inc. SAR Testing Lab

Date: 2007/5/7

Body_802.11b Ch6_Holster Left Side Touch_7527C_POD 3_B2_BT On

Communication System: 802.11b : Frequency: 2437 MHz;Duty Cycle: 1:1

Medium: MSL_2450 Medium parameters used: $f = 2437$ MHz; $\sigma = 1.95$ mho/m; $\epsilon_r = 53$; $\rho = 1000$ kg/m³

Ambient Temperature : 22.2 °C; Liquid Temperature : 21.0 °C

DASY4 Configuration:

- Probe: ET3DV6 - SN1787; ConvF(4.13, 4.13, 4.13); Calibrated: 2006/5/31

- Sensor-Surface: 4mm (Mechanical Surface Detection)

- Electronics: DAE3 Sn577; Calibrated: 2006/11/21

- Phantom: SAM-B; Type: QD 000 P40 C; Serial: TP-1383

- Measurement SW: DASY4, V4.7 Build 53; Postprocessing SW: SEMCAD, V1.8 Build 172

Ch6/Area Scan (61x171x1): Measurement grid: dx=15mm, dy=15mm

Maximum value of SAR (interpolated) = 0.161 mW/g

Ch6/Zoom Scan (5x5x7)/Cube 0: Measurement grid: dx=8mm, dy=8mm, dz=5mm

Reference Value = 8.52 V/m; Power Drift = -0.149 dB

Peak SAR (extrapolated) = 0.304 W/kg

SAR(1 g) = 0.152 mW/g; SAR(10 g) = 0.085 mW/g

Maximum value of SAR (measured) = 0.162 mW/g

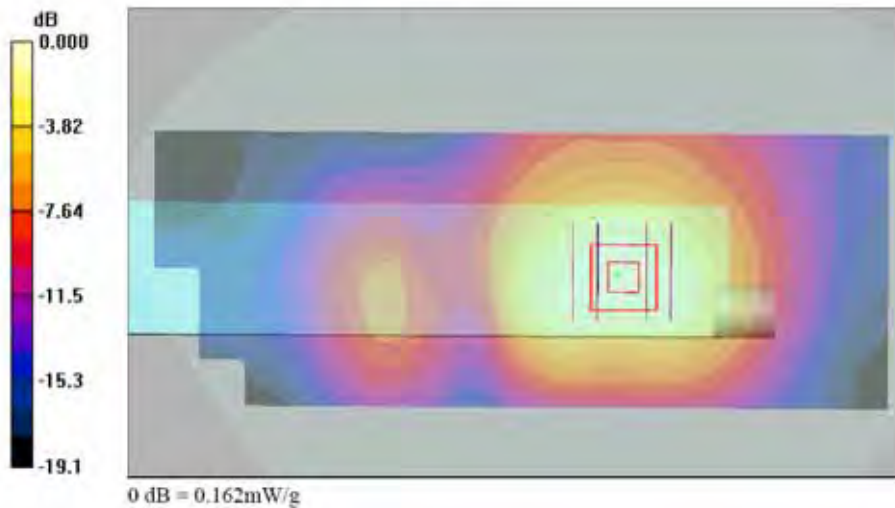



Test Laboratory: Sporton International Inc. SAR Testing Lab

Date/Time: 2/13/2007 12:10:44 PM

Right Cheek_802.11b Ch11_20070212_PC529_Bluetooth On_2D

DUT: 710211-01

Communication System: 802.11b ; Frequency: 2462 MHz;Duty Cycle: 1:1

Medium: HSL_2450 Medium parameters used: $f = 2462$ MHz; $\sigma = 1.78$ mho/m; $\epsilon_r = 38$; $\rho = 1000$ kg/m³

Ambient Temperature : 21.7 °C; Liquid Temperature : 20.8 °C

DASY4 Configuration:

- Probe: ET3DV6 - SN1788; ConvF(4.66, 4.66, 4.66); Calibrated: 9/19/2006

- Sensor-Surface: 4mm (Mechanical And Optical Surface Detection)

- Electronics: DAE3 Sn577; Calibrated: 11/21/2006

- Phantom: SAM-B; Type: QD 000 P40 C; Serial: TP-1383

- Measurement SW: DASY4, V4.7 Build 44; Postprocessing SW: SEMCAD, V1.8 Build 171

Ch11/Area Scan (71x171x1): Measurement grid: dx=15mm, dy=15mm

Maximum value of SAR (interpolated) = 0.099 mW/g

Ch11/Zoom Scan (5x5x7)/Cube 0: Measurement grid: dx=8mm, dy=8mm, dz=5mm

Reference Value = 4.63 V/m; Power Drift = -0.068 dB

Peak SAR (extrapolated) = 0.178 W/kg

SAR(1 g) = 0.084 mW/g; SAR(10 g) = 0.040 mW/g

Maximum value of SAR (measured) = 0.095 mW/g

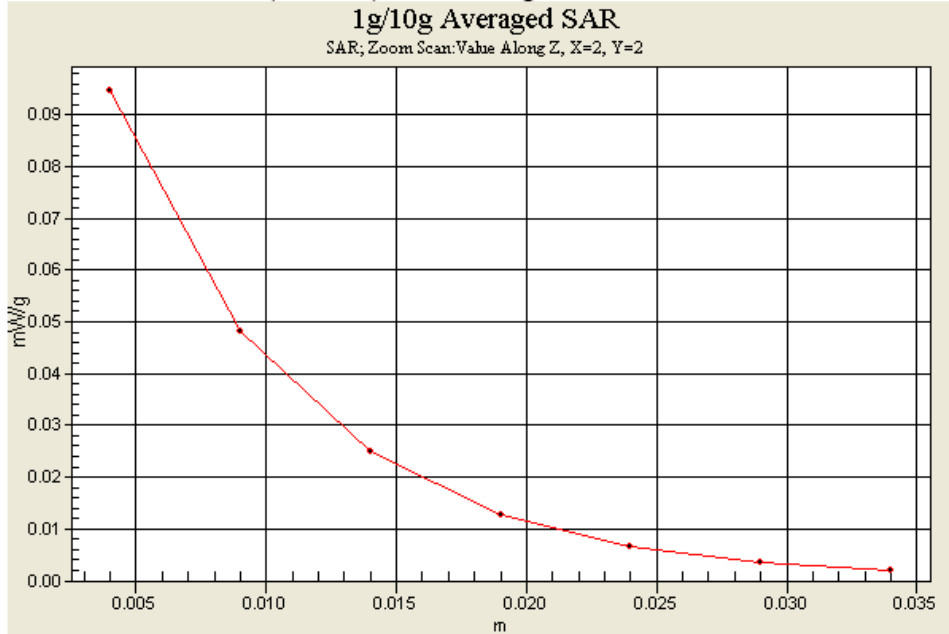



Test Laboratory: Sporton International Inc. SAR Testing Lab

Date: 2007/5/7

Body_802.11b Ch1_Holster Left Side Touch_7527C_Endcap 6_B2_BT On_2D

Communication System: 802.11b ; Frequency: 2412 MHz; Duty Cycle: 1:1

Medium: MSL_2450 Medium parameters used: $f = 2412$ MHz; $\sigma = 1.91$ mho/m; $\epsilon_r = 53$; $\rho = 1000$ kg/m³

Ambient Temperature : 22.2 °C; Liquid Temperature : 21.0 °C

DASY4 Configuration:

- Probe: ET3DV6 - SN1787; ConvF(4.13, 4.13, 4.13); Calibrated: 2006/5/31
- Sensor-Surface: 4mm (Mechanical Surface Detection)
- Electronics: DAE3 Sn577; Calibrated: 2006/11/21
- Phantom: SAM-B; Type: QD 000 P40 C; Serial: TP-1383
- Measurement SW: DASY4, V4.7 Build 53; Postprocessing SW: SEMCAD, V1.8 Build 172

Ch1/Area Scan (61x171x1): Measurement grid: dx=15mm, dy=15mm

Maximum value of SAR (interpolated) = 0.255 mW/g

Ch1/Zoom Scan (5x5x7)/Cube 0: Measurement grid: dx=8mm, dy=8mm, dz=5mm

Reference Value = 10.5 V/m; Power Drift = -0.192 dB

Peak SAR (extrapolated) = 0.439 W/kg

SAR(1 g) = 0.230 mW/g; SAR(10 g) = 0.128 mW/g

Maximum value of SAR (measured) = 0.249 mW/g

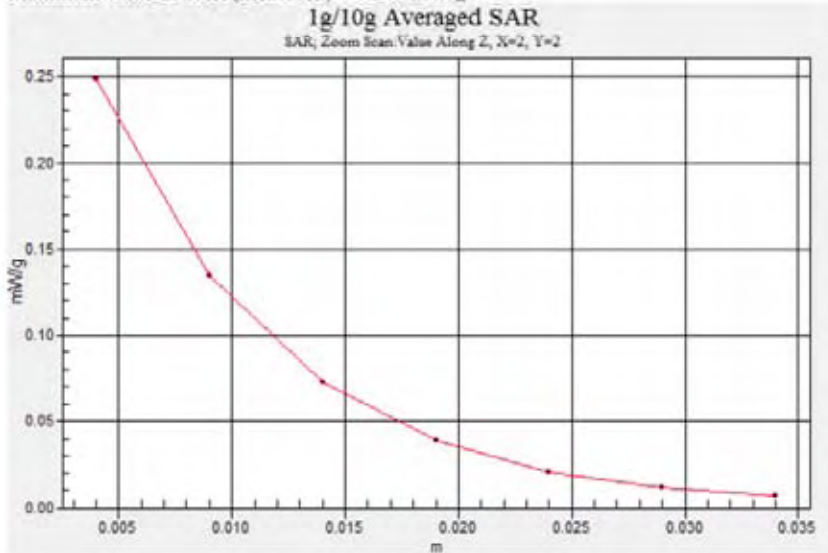



Test Laboratory: Sporton International Inc. SAR Testing Lab

Date: 2007/5/7

Body_802.11b Ch1_Holster Left Side Touch_7527S_Endcap 6_B2_BT On_2D

Communication System: 802.11b ; Frequency: 2412 MHz;Duty Cycle: 1:1

Medium: MSL_2450 Medium parameters used: f = 2412 MHz; $\sigma = 1.91$ mho/m; $\epsilon_r = 53$; $\rho = 1000$ kg/m³

Ambient Temperature : 22.4 °C; Liquid Temperature : 21.5 °C

DASY4 Configuration:

- Probe: ET3DV6 - SN1787; ConvF(4.13, 4.13, 4.13); Calibrated: 2006/5/31
- Sensor-Surface: 4mm (Mechanical Surface Detection)
- Electronics: DAE3 Sn577; Calibrated: 2006/11/21
- Phantom: SAM-B; Type: QD 000 P40 C; Serial: TP-1383
- Measurement SW: DASY4, V4.7 Build 53; Postprocessing SW: SEMCAD, V1.8 Build 172

Ch1/Area Scan (61x171x1): Measurement grid: dx=15mm, dy=15mm

Maximum value of SAR (interpolated) = 0.257 mW/g

Ch1/Zoom Scan (5x5x7)/Cube 0: Measurement grid: dx=8mm, dy=8mm, dz=5mm

Reference Value = 10.5 V/m; Power Drift = -0.147 dB

Peak SAR (extrapolated) = 0.463 W/kg

SAR(1 g) = 0.234 mW/g; SAR(10 g) = 0.134 mW/g

Maximum value of SAR (measured) = 0.244 mW/g

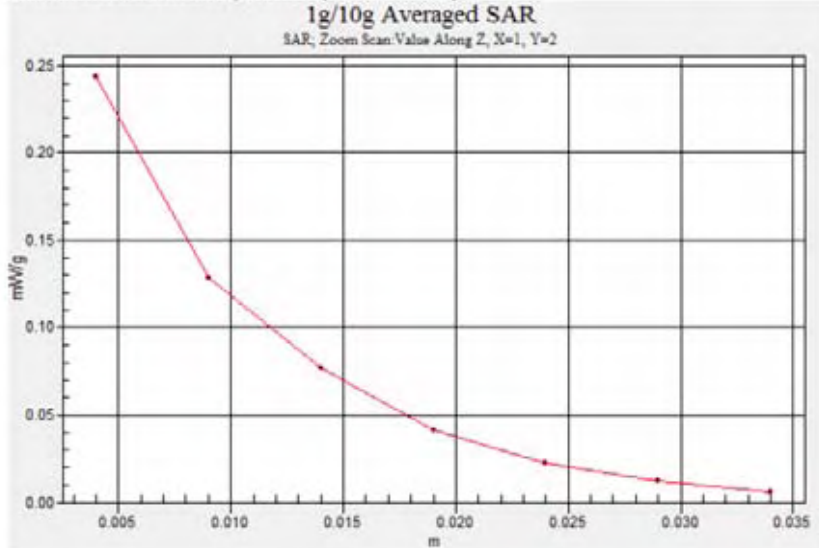



Appendix C – Calibration Data

Calibration Laboratory of Schmid & Partner Engineering AG Zeughausstrasse 43, 8004 Zurich, Switzerland



S Schweizerischer Kalibrierdienst
C Service suisse d'etalonnage
S Servizio svizzero di taratura
S Swiss Calibration Service

Accredited by the Swiss Federal Office of Metrology and Accreditation The Swiss Accreditation Service is one of the signatories to the EA Multilateral Agreement for the recognition of calibration certificates

Accreditation No.: SCS 108

Client Sporton (Auden)

Certificate No: D2450V2-736_Jul05

CALIBRATION CERTIFICATE

Object: D2450V2 - SN: 736
Calibration procedure(s): QA CAL-05.v8 Calibration procedure for dipole validation kits
Calibration date: July 12, 2005
Condition of the calibrated item: In Tolerance

This calibration certificate documents the traceability to national standards, which realize the physical units of measurements (SI). The measurements and the uncertainties with confidence probability are given on the following pages and are part of the certificate.

All calibrations have been conducted in the closed laboratory facility: environment temperature (22 ± 3)°C and humidity < 70%.

Calibration Equipment used (M&TE critical for calibration)

Table with 4 columns: Primary Standards, ID #, Cal Date (Calibrated by, Certificate No.), Scheduled Calibration. Lists equipment like Power meter EPM E442, Power sensor HP 8481A, etc.

Calibrated by: Mke Mell, Laboratory Technician
Approved by: Katja Pokovic, Technical Manager

Issued: July 12, 2005

This calibration certificate shall not be reproduced except in full without written approval of the laboratory.



Calibration Laboratory of
Schmid & Partner
Engineering AG
Zaughausstrasse 43, 8004 Zurich, Switzerland



S Schweizerischer Kalibrierdienst
S Service suisse d'étalonnage
C Servizio svizzero di taratura
S Swiss Calibration Service

Accredited by the Swiss Federal Office of Metrology and Accreditation
The Swiss Accreditation Service is one of the signatories to the EA
Multilateral Agreement for the recognition of calibration certificates

Accreditation No.: **SCS 108**

Glossary:

TSL tissue simulating liquid
ConvF sensitivity in TSL / NORM x,y,z
N/A not applicable or not measured

Calibration is Performed According to the Following Standards:

- a) IEEE Std 1528-2003, "IEEE Recommended Practice for Determining the Peak Spatial-Averaged Specific Absorption Rate (SAR) in the Human Head from Wireless Communications Devices: Measurement Techniques", December 2003
- b) CENELEC EN 50361, "Basic standard for the measurement of Specific Absorption Rate related to human exposure to electromagnetic fields from mobile phones (300 MHz - 3 GHz), July 2001
- c) Federal Communications Commission Office of Engineering & Technology (FCC OET), "Evaluating Compliance with FCC Guidelines for Human Exposure to Radiofrequency Electromagnetic Fields; Additional Information for Evaluating Compliance of Mobile and Portable Devices with FCC Limits for Human Exposure to Radiofrequency Emissions", Supplement C (Edition 01-01) to Bulletin 65

Additional Documentation:

- d) DASY4 System Handbook

Methods Applied and Interpretation of Parameters:

- *Measurement Conditions:* Further details are available from the Validation Report at the end of the certificate. All figures stated in the certificate are valid at the frequency indicated.
- *Antenna Parameters with TSL:* The dipole is mounted with the spacer to position its feed point exactly below the center marking of the flat phantom section, with the arms oriented parallel to the body axis.
- *Feed Point Impedance and Return Loss:* These parameters are measured with the dipole positioned under the liquid filled phantom. The impedance stated is transformed from the measurement at the SMA connector to the feed point. The Return Loss ensures low reflected power. No uncertainty required.
- *Electrical Delay:* One-way delay between the SMA connector and the antenna feed point. No uncertainty required.
- *SAR measured:* SAR measured at the stated antenna input power.
- *SAR normalized:* SAR as measured, normalized to an input power of 1 W at the antenna connector.
- *SAR for nominal TSL parameters:* The measured TSL parameters are used to calculate the nominal SAR result.



Measurement Conditions

DASY system configuration, as far as not given on page 1.

DASY Version	DASY4	V4.6
Extrapolation	Advanced Extrapolation	
Phantom	Modular Flat Phantom V5.0	
Distance Dipole Center - TSL	10 mm	with Spacer
Area Scan resolution	dx, dy = 15 mm	
Zoom Scan Resolution	dx, dy, dz = 5 mm	
Frequency	2450 MHz ± 1 MHz	

Head TSL parameters

The following parameters and calculations were applied.

	Temperature	Permittivity	Conductivity
Nominal Head TSL parameters	22.0 °C	39.2	1.80 mho/m
Measured Head TSL parameters	(22.0 ± 0.2) °C	38.5 ± 6 %	1.73 mho/m ± 6 %
Head TSL temperature during test	(22.0 ± 0.2) °C	----	----

SAR result with Head TSL

SAR averaged over 1 cm ³ (1 g) of Head TSL	condition	
SAR measured	250 mW input power	13.1 mW / g
SAR normalized	normalized to 1W	52.4 mW / g
SAR for nominal Head TSL parameters ¹	normalized to 1W	52.8 mW / g ± 17.0 % (k=2)

SAR averaged over 10 cm ³ (10 g) of Head TSL	condition	
SAR measured	250 mW input power	6.13 mW / g
SAR normalized	normalized to 1W	24.5 mW / g
SAR for nominal Head TSL parameters ¹	normalized to 1W	24.7 mW / g ± 16.5 % (k=2)

¹ Correction to nominal TSL parameters according to d), chapter "SAR Sensitivities"



Body TSL parameters

The following parameters and calculations were applied.

	Temperature	Permittivity	Conductivity
Nominal Body TSL parameters	22.0 °C	52.7	1.95 mho/m
Measured Body TSL parameters	(22.2 ± 0.2) °C	52.5 ± 6 %	2.02 mho/m ± 6 %
Body TSL temperature during test	(22.2 ± 0.2) °C	---	---

SAR result with Body TSL

SAR averaged over 1 cm ³ (1 g) of Body TSL	condition	
SAR measured	250 mW input power	13.5 mW / g
SAR normalized	normalized to 1W	54.0 mW / g
SAR for nominal Body TSL parameters ²	normalized to 1W	52.8 mW / g ± 17.0 % (k=2)

SAR averaged over 10 cm ³ (10 g) of Body TSL	condition	
SAR measured	250 mW input power	6.26 mW / g
SAR normalized	normalized to 1W	25.0 mW / g
SAR for nominal Body TSL parameters ²	normalized to 1W	24.5 mW / g ± 16.5 % (k=2)

² Correction to nominal TSL parameters according to d), chapter "SAR Sensitivities"



Appendix

Antenna Parameters with Head TSL

Impedance, transformed to feed point	53.6 Ω + 3.7 j Ω
Return Loss	-26.0 dB

Antenna Parameters with Body TSL

Impedance, transformed to feed point	49.9 Ω + 5.3 j Ω
Return Loss	- 25.5 dB

General Antenna Parameters and Design

Electrical Delay (one direction)	1.157 ns
----------------------------------	----------

After long term use with 100W radiated power, only a slight warming of the dipole near the feedpoint can be measured.

The dipole is made of standard semirigid coaxial cable. The center conductor of the feeding line is directly connected to the second arm of the dipole. The antenna is therefore short-circuited for DC-signals.

No excessive force must be applied to the dipole arms, because they might bend or the soldered connections near the feedpoint may be damaged.

Additional EUT Data

Manufactured by	SPEAG
Manufactured on	August 26, 2003



DASY4 Validation Report for Head TSL

Date/Time: 12.07.2005 12:53:00

Test Laboratory: SPEAG, Zurich, Switzerland

DUT: Dipole 2450 MHz; Type: D2450V2; Serial: D2450V2 - SN736

Communication System: CW-2450; Frequency: 2450 MHz; Duty Cycle: 1:1

Medium: HSL U10 BB

Medium parameters used: $f = 2450$ MHz; $\sigma = 1.73$ mho/m; $\epsilon_r = 38.5$; $\rho = 1000$ kg/m³

Phantom section: Flat Section

Measurement Standard: DASY4 (High Precision Assessment)

DASY4 Configuration:

- Probe: ES3DV2 - SN3025; ConvF(4.4, 4.4, 4.4); Calibrated: 29.10.2004
- Sensor-Surface: 4mm (Mechanical Surface Detection)
- Electronics: DA14 Sn601; Calibrated: 22.07.2004
- Phantom: Flat Phantom 5.0 (front); Type: QD000P50AA
- Measurement SW: DASY4, V4.5 Build 30; Postprocessing SW: SEMCAD, V1.8 Build 149

Pin = 250 mW; d = 10 mm 2/Area Scan (41x61x1):

Measurement grid: dx=15mm, dy=15mm

Maximum value of SAR (interpolated) = 16.6 mW/g

Pin = 250 mW; d = 10 mm 2/Zoom Scan (7x7x7)/Cube 0:

Measurement grid: dx=5mm, dy=5mm, dz=5mm

Reference Value = 91.6 V/m; Power Drift = 0.077 dB

Peak SAR (extrapolated) = 27.0 W/kg

SAR(1 g) = 13.1 mW/g; SAR(10 g) = 6.13 mW/g

Maximum value of SAR (measured) = 15.0 mW/g

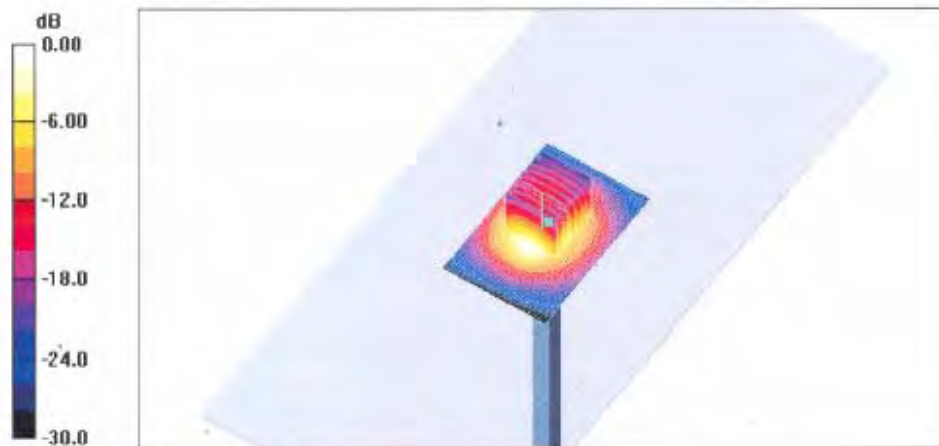



Impedance Measurement Plot for Head TSL

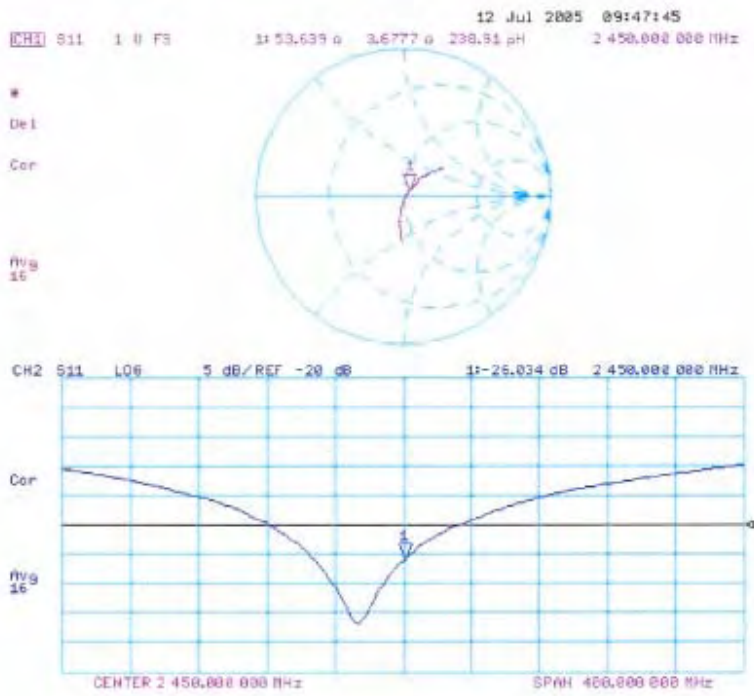



DASY4 Validation Report for Body TSL

Date/Time: 11.07.2005 17:33:35

Test Laboratory: SPEAG, Zurich, Switzerland

DUT: Dipole 2450 MHz; Type: D2450V2; Serial: D2450V2 - SN736

Communication System: CW-2450; Frequency: 2450 MHz; Duty Cycle: 1:1

Medium: MSL 2450

Medium parameters used: $f = 2450$ MHz; $\sigma = 2.02$ mho/m; $\epsilon_r = 52.5$; $\rho = 1000$ kg/m³

Phantom section: Flat Section

Measurement Standard: DASY4 (High Precision Assessment)

DASY4 Configuration:

- Probe: ES3DV2 - SN3025; ConvF(4.13, 4.13, 4.13); Calibrated: 29.10.2004
- Sensor-Surface: 4mm (Mechanical Surface Detection)
- Electronics: DAE4 Sn601; Calibrated: 22.07.2004
- Phantom: Flat Phantom 5.0 (front); Type: QD000P50AA
- Measurement SW: DASY4, V4.6 Build 4; Postprocessing SW: SEMCAD, V1.8 Build 149

Pin = 250 mW; d = 10 mm/Area Scan (81x81x1):

Measurement grid: dx=15mm, dy=15mm

Maximum value of SAR (interpolated) = 15.8 mW/g

Pin = 250 mW; d = 10 mm/Zoom Scan (7x7x7)/Cube 0:

Measurement grid: dx=5mm, dy=5mm, dz=5mm

Reference Value = 85.9 V/m; Power Drift = 0.160 dB

Peak SAR (extrapolated) = 27.6 W/kg

SAR(1 g) = 13.5 mW/g; SAR(10 g) = 6.26 mW/g

Maximum value of SAR (measured) = 15.5 mW/g

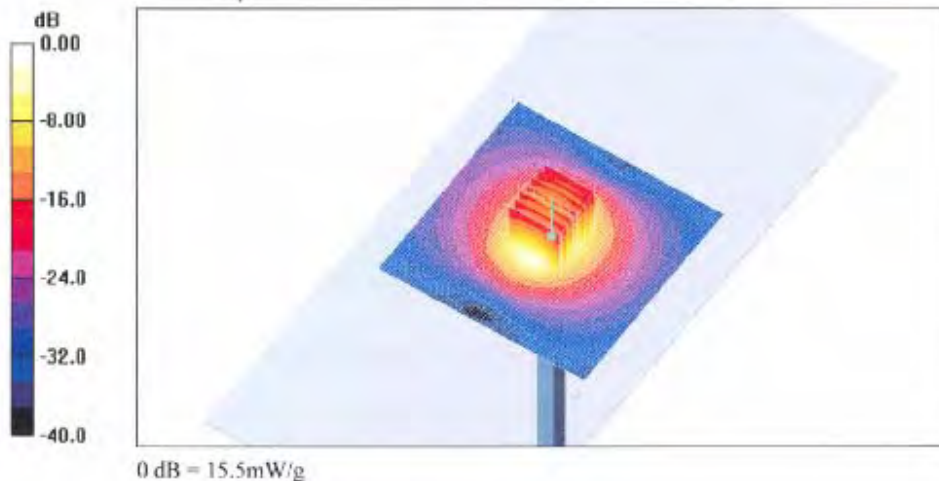



Impedance Measurement Plot for Body TSL

