



**Specific Absorption Rate (SAR) Test Report**  
for  
**Psion Teklogix Inc.**  
on the  
**Hand-held Micro-computer**

Report No. : FA710211-01-1-2-03  
Trade Name : WORKABOUT PRO  
Model Name : RA3030-G2  
FCC ID : GM375273RADA  
IC ID : 2739D-7527RADA  
Date of Testing : Feb. 04~05, May 01, and 04~06, 2007  
Date of Report : May 11, 2007  
Date of Review : May 11, 2007

- The test results refer exclusively to the presented test model/sample only.
- Without written approval of SPORTON International Inc., the test report shall not be reproduced except in full.
- Report Version: Rev.04.

**SPORTON International Inc.**

6F, No.106, Sec. 1, Hsin Tai Wu Rd., Hsi Chih, Taipei Hsien, Taiwan, R.O.C.



# Table of Contents

- 1. **Statement of Compliance**----- 3
- 2. **Administration Data**----- 4
  - 2.1 Testing Laboratory----- 4
  - 2.2 Detail of Applicant----- 4
  - 2.3 Detail of Manufacturer----- 4
  - 2.4 Application Detail----- 4
- 3. **General Information**----- 5
  - 3.1 Description of Device Under Test (DUT)----- 5
  - 3.2 Details of the modules----- 6
  - 3.3 Details of the Hosts----- 6
  - 3.4 Details of the Accessory----- 7
  - 3.5 Product Photo----- 8
  - 3.6 Applied Standards:----- 10
  - 3.7 Device Category and SAR Limits----- 11
  - 3.8 Test Conditions:----- 11
    - 3.8.1 Ambient Condition----- 11
    - 3.8.2 Test Configuration----- 11
- 4. **Specific Absorption Rate (SAR)**----- 12
  - 4.1 Introduction----- 12
  - 4.2 SAR Definition----- 12
- 5. **SAR Measurement Setup**----- 13
  - 5.1 DASY4 E-Field Probe System----- 14
    - 5.1.1 ET3DV6 E-Field Probe Specification----- 15
    - 5.1.2 ET3DV6 E-Field Probe Calibration----- 15
  - 5.2 DATA Acquisition Electronics (DAE)----- 17
  - 5.3 Robot----- 18
  - 5.4 Measurement Server----- 18
  - 5.5 SAM Twin Phantom----- 18
  - 5.6 Device Holder for SAM Twin Phantom----- 20
  - 5.7 Data Storage and Evaluation----- 21
    - 5.7.1 Data Storage----- 21
    - 5.7.2 Data Evaluation----- 21
  - 5.8 Test Equipment List----- 24
- 6. **Tissue Simulating Liquids**----- 25
- 7. **Uncertainty Assessment**----- 27
- 8. **SAR Measurement Evaluation**----- 29
  - 8.1 Purpose of System Performance check----- 29
  - 8.2 System Setup----- 29
  - 8.3 Validation Results----- 31
- 9. **Description for DUT Testing Position**----- 32
- 10. **Measurement Procedures**----- 40
  - 10.1 Spatial Peak SAR Evaluation----- 40
  - 10.2 Scan Procedures----- 41
  - 10.3 SAR Averaged Methods----- 41
- 11. **SAR Test Results**----- 42
  - 11.1 Right Cheek----- 42
  - 11.2 Right Tilted----- 42
  - 11.3 Left Cheek----- 42
  - 11.4 Left Tilted----- 43
  - 11.5 Keypad Up with 1.5cm Gap----- 44
  - 11.6 Keypad Down with 1.5cm Gap----- 45
  - 11.7 Holster Left Side Touch----- 46
  - 11.8 Holster Right Side Touch----- 46
- 12. **References**----- 48

**Appendix A - System Performance Check Data**



---

**Appendix B - SAR Measurement Data**  
**Appendix C - Calibration Data**  
**Appendix D - WLAN SAR Data**



**1. Statement of Compliance**

The Specific Absorption Rate (SAR) maximum results found during testing for the **Psion Teklogix Inc. Hand-held Micro-computer WORKABOUT PRO RA3030-G2** on the PDA hosts 7527C / 7527S Series are as follows (with expanded uncertainty 20.6%) :

	<b>GSM850 head (W/Kg)</b>	<b>GSM850 body (W/Kg)</b>	<b>PCS1900 head (W/Kg)</b>	<b>PCS1900 body (W/Kg)</b>
<b>7527C Series</b>	<b>1.3</b>	<b>0.456</b>	<b>0.551</b>	<b>0.236</b>
<b>7527S Series</b>	<b>1.01</b>	<b>0.489</b>	<b>0.632</b>	<b>0.171</b>

The co-location of GSM/GPRS, WLAN and Bluetooth on the hosts 7527C / 7527S Series were also checked. They are in compliance with Specific Absorption Rate (SAR) for general population/uncontrolled exposure limits specified in FCC 47 CFR part 2 (2.1093) and ANSI/IEEE C95.1-1999 and RSS-102 Issued 2 and had been tested in accordance with the measurement methods and procedures specified in OET Bulletin 65 Supplement C (Edition 01-01) and IEEE 1528-2003.

Approved by

Roy Wu  
Deputy Manager



## **2. Administration Data**

### **2.1 Testing Laboratory**

**Company Name :** Sporton International Inc.  
**Department :** Antenna Design/SAR  
**Address :** No.52, Hwa-Ya 1<sup>st</sup> RD., Hwa Ya Technology Park, Kwei-Shan Hsiang, TaoYuan Hsien, Taiwan, R.O.C.  
**Telephone Number :** 886-3-327-3456  
**Fax Number :** 886-3-327-0973

### **2.2 Detail of Applicant**

**Company Name :** Psion Teklogix Inc.  
**Address :** 2100 Meadowvale Boulevard, Mississauga, Ontario L5N 7J9 Canada

### **2.3 Detail of Manufacturer**

**Company Name :** ASKEY COMPUTER CORP.  
**Address :** 10F, NO. 119, CHIENKANG RD., CHUNG-HO, TAIPEI, TAIWAN, 235, R.O.C.

### **2.4 Application Detail**

**Date of reception of application:** Jan. 02, 2007  
**Start of test :** Feb. 04, 2007  
**End of test :** May 06, 2007



### 3. General Information

#### 3.1 Description of Device Under Test (DUT)

<b>DUT Type :</b>	Hand-held Micro-computer
<b>Trade Name :</b>	WORKABOUT PRO
<b>Model Name :</b>	RA3030-G2
<b>FCC ID :</b>	GM375273RADA
<b>IC ID :</b>	2739D-7527RADA
<b>Tx Frequency :</b>	GSM850 : 824 ~ 849 MHz PCS1900 : 1850 ~ 1910 MHz
<b>Rx Frequency :</b>	GSM850 : 869 ~ 894 MHz PCS1900 : 1930 ~ 1990 MHz
<b>Antenna Type :</b>	GSM850 : PCB Antenna PCS1900 : PCB Antenna
<b>Antenna Connector :</b>	N/A
<b>Maximum Output Power to Antenna :</b>	See the table below for the details
<b>Type of Modulation :</b>	GSM/GPRS : GMSK EGPRS : 8PSK
<b>Power Rating :</b>	3.8V / 810mA
<b>Application Type :</b>	PC II Change

#### Test Hosts and the Embedded Modules

Maximum Output Power to Antenna				
Hosts	GSM850	PCS1900	Bluetooth	WLAN
<b>7527C Series</b>	GSM: 31.54 dBm GPRS8: 31.50 dBm GPRS10: 29.95 dBm GPRS12: 27.60 dBm EDGE8: 29.60 dBm EDGE10: 27.40 dBm EDGE12: 23.10 dBm	GSM: 29.03 dBm GPRS8: 29.06 dBm GPRS10: 27.28 dBm GPRS12: 28 dBm EDGE8: 28.20 dBm EDGE10: 26.00 dBm EDGE12: 22.00 dBm	0.59 dBm	802.11b: 20.65 dBm; 802.11g: 22.98 dBm
<b>7527S Series</b>	GSM: 31.53 dBm GPRS8: 31.57 dBm GPRS10: 29.98 dBm GPRS12: 27.60 dBm EDGE8: 29.50 dBm EDGE10: 27.40 dBm EDGE12: 23.30 dBm	GSM: 28.94 dBm GPRS8: 28.97 dBm GPRS10: 27.16 dBm GPRS12: 24.00 dBm EDGE8: 28.30 dBm EDGE10: 26.10 dBm EDGE12: 22.10 dBm	0.59 dBm	802.11b: 20.65 dBm; 802.11g: 22.98 dBm



3.2 Details of the modules

Maximum Output Power to Antenna			
	Model Name	FCC ID	IC ID
GSM Radio	RA3030-G2	GM375273RADA	2739D-7527RADA
WLAN Radio	RA2041	GM37527RA2041	2739D-BGRADA
Bluetooth Radio	BTL040	GM37525BTB	2739D-7525BTB

3.3 Details of the Hosts

Product Feature & Specification	
DUT Type	Hand-held Micro-computer
Trade Name	WORKABOUT PRO
Model Name	7527C / 7527S Series
HW Version	7527C : ES3 7527S : ES2
SW Version	A
DUT Stage	Identical Prototype
Battery	WA3006

Remark: 7527S is the shorter version of model 7527C. They have the same RF modules and antenna. The only difference between the two models is the keypad.



3.4 Details of the Accessory

Terminal Options				
		Model Number	Part Number	Remark
GSM	Quad-band MC75 GSM Radio with Stubby antenna	RA3030-G2	N/A	
Kit	Blackroc Endcap Kit 3-Port (RS232,TTL,IRDA); kit	BR1000-G1	1050812	Endcap 7
802.11g	802.11g CF Radio	RA2041	N/A	
Endcap with GSM	Imager, 2D HHP 5180 Endcap with GSM antenna	WA8110-G1	1050830	Endcap 5
	Imager, 1D EV15 Endcap, with GSM antenna	WA9113-G1	1050778	Endcap 1
	Scanner, 1D SE955 Endcap, with GSM antenna	WA9112-G1	1050491	Endcap 2
Endcap	Imager, 2D HHP 5180 Endcap	WA8010-G1	1050890	Endcap 6
	Imager, 1D Intermec EV15 Endcap	WA9103-G1	1050777	Endcap 3
	Scanner, 1D SE955 Endcap	WA9102-G1	1050492	Endcap 4
POD	Imager, 1D Intermec EV15 Pod	WA9003-G1	1050462	POD 1
	Scanner, 1D SE955 Pod	WA9002-G1	1050230	POD 2
	Scanner, 1D SE1223HP Pod	WA9000-G1	1050229	POD 3
	Scanner, 1D SE1223LR Pod	WA9005-G1	1051025	POD 4
	Imager, 2D HHP 5180 Pod	WA9012-G1	1050865	POD 6

Docks and Connectivity Options				
Docking	Desktop Docking Station	WA4003-G2	1050955	Docking 1
	USB Cable	N/A	N/A	USB 1
	Vehicle Cradle - Powered 12V with Port Replicator	WA4005-G1 (port replicator)	1080224 (port replicator)	
	Cigarette light adaptor	WA3113-G2	1050463-001	
	Standalone Power Supply	PS1050-G1	1050465	
USB	USB to Ethernet adaptor module	WA4010-G1	1050236	USB 2
	USB to RS232 adaptor module	WA4015-G1	1050067-300	USB 3
Tether	Tether to Ethernet adaptor module	WA4025	1050255	USB 5
	Tether adaptor cable (for connecting keyboards)	WA1001	1050551	USB 4

Others				
Battery	3000mAh	WA3006		B2
	4000mAh	WA3010	1050192	B3
Holster	Soft Shell Holster	WA6050	1030227	C1
Pistol Grips	Pistol Grip Symbol SE1223 Scanner	WA6001-G1	1050460	C2

Remark: USB Cable comes in the box as part of the Docking Station WA4003-G2.





**3.5 Product Photo**  
**7527C Series**



**7527S Series**





GSM module

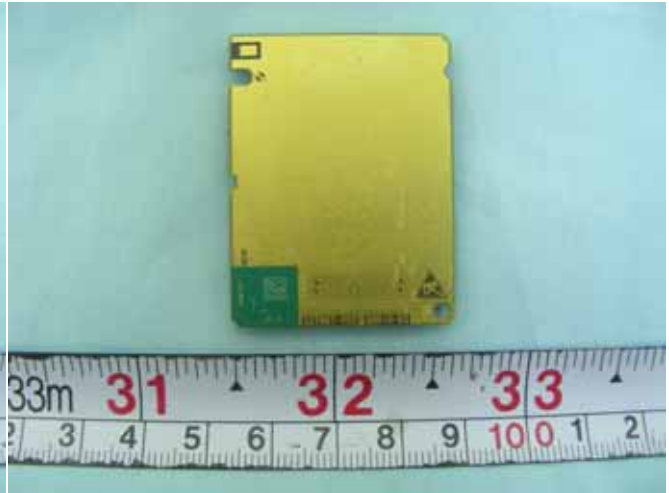
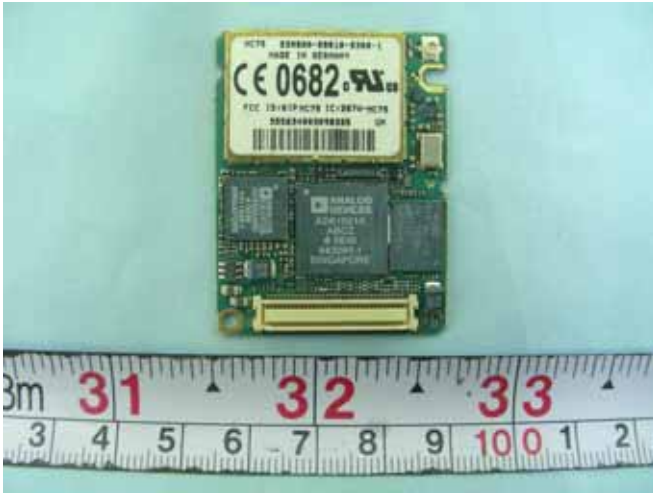

Holster





**3.6 Applied Standards:**

The Specific Absorption Rate (SAR) testing specification, method and procedure for this Hand-held Micro-computer is in accordance with the following standards:

RSS-102 Issued 2 (2005),  
47 CFR Part 2 ( 2.1093),  
IEEE C95.1-1999,  
IEEE C95.3-2002,  
IEEE P1528-2003, and  
OET Bulletin 65 Supplement C (Edition 01-01)



**3.7 Device Category and SAR Limits**

This device belongs to portable device category because its radiating structure is allowed to be used within 20 centimeters of the body of the user.

Limit for General Population/Uncontrolled exposure should be applied for this device, it is 1.6 W/kg as averaged over any 1 gram of tissue.

**3.8 Test Conditions:**

**3.8.1 Ambient Condition**

Item	HSL_850 2/4	HSL_850 5/1	MSL_850 2/4	MSL_850 5/5	HSL_1900 2/4	HSL_1900 5/4	MSL_1900 2/5	MSL_1900 5/6
Ambient Temperature (°C)	20-24							
Tissue simulating liquid temperature (°C)	20.9	21.6	21.4	21.3	20.3	21.0	20.9	21.4
Humidity (%)	<60							

**3.8.2 Test Configuration**

The device was controlled by using a base station emulator R&S CMU200. Communication between the device and the emulator was established by air link. The distance between the DUT and the antenna of the emulator is larger than 50 cm and the output power radiated from the emulator antenna is at least 30 dB smaller than the output power of DUT.

Measurements were performed on the lowest, middle, and highest channel for each testing position for head SAR testing. Measurements were performed only on the middle channel if the SAR is below 3 dB of limit for body SAR testing.

The DUT was set from the emulator to radiate maximum output power during all testings.

For head SAR testing, EUT is in GSM link mode, and its crest factor is 8.3. For body SAR testing, EUT is in GPRS/EGPRS link mode, and its crest factor is 2 because EUT is GPRS/EGPRS class 12 device.



#### 4. Specific Absorption Rate (SAR)

##### 4.1 Introduction

SAR is related to the rate at which energy is absorbed per unit mass in an object exposed to a radio field. The SAR distribution in a biological body is complicated and is usually carried out by experimental techniques or numerical modeling. The standard recommends limits for two tiers of groups, occupational/controlled and general population/uncontrolled, based on a person’s awareness and ability to exercise control over his or her exposure. In general, occupational/controlled exposure limits are higher than the limits for general population/uncontrolled.

##### 4.2 SAR Definition

The SAR definition is the time derivative (rate) of the incremental energy (dW) absorbed by (dissipated in) an incremental mass (dm) contained in a volume element (dv) of a given density.

). The equation description is as below:

$$\mathbf{SAR} = \frac{d}{dt} \left( \frac{dW}{dm} \right) = \frac{d}{dt} \left( \frac{dW}{\rho dv} \right)$$

*SAR is expressed in units of Watts per kilogram (W/kg)*

SAR measurement can be either related to the temperature elevation in tissue by

$$\mathbf{SAR} = C \frac{\delta T}{\delta t}$$

, where C is the specific heat capacity,  $\delta T$  is the temperature rise and  $\delta t$  the exposure duration,

or related to the electrical field in the tissue by

$$\mathbf{SAR} = \frac{\sigma |E|^2}{\rho}$$

, where  $\sigma$  is the conductivity of the tissue,  $\rho$  is the mass density of the tissue and  $E$  is the rms electrical field strength.

However for evaluating SAR of low power transmitter, electrical field measurement is typically applied.

### 5. SAR Measurement Setup

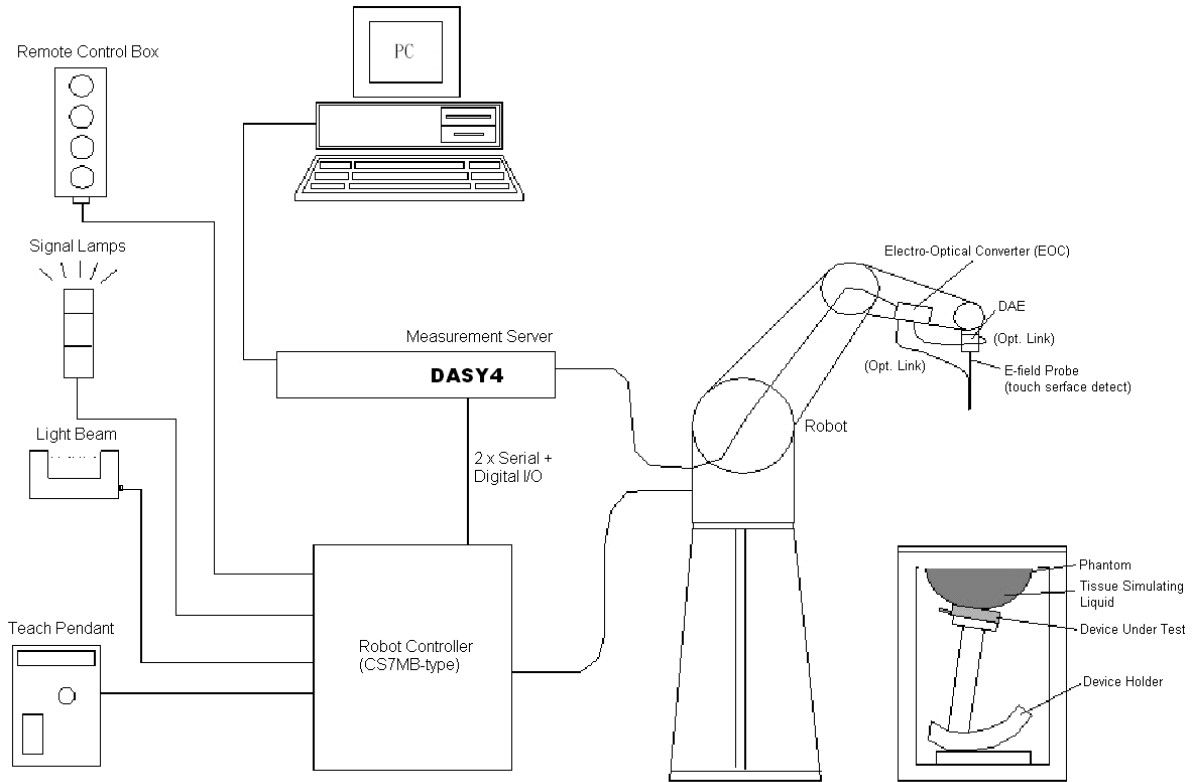

**Fig. 5.1 DASY4 system**



The DASY4 system for performance compliance tests is illustrated above graphically. This system consists of the following items:

- A standard high precision 6-axis robot with controller, a teach pendant and software
- A data acquisition electronic (DAE) attached to the robot arm extension
- A dosimetric probe equipped with an optical surface detector system
- The electro-optical converter (ECO) performs the conversion between optical and electrical signals
- A measurement server performs the time critical tasks such as signal filtering, control of the robot operation and fast movement interrupts.
- A probe alignment unit which improves the accuracy of the probe positioning
- A computer operating Windows XP
- DASY4 software
- Remove control with teach pendant and additional circuitry for robot safety such as warning lamps, etc.
- The SAM twin phantom
- A device holder
- Tissue simulating liquid
- Dipole for evaluating the proper functioning of the system

Some of the components are described in details in the following sub-sections.

### **5.1 DASY4 E-Field Probe System**

The SAR measurement is conducted with the dosimetric probe ET3DV6 (manufactured by SPEAG). The probe is specially designed and calibrated for use in liquid with high permittivity. The dosimetric probe has special calibration in liquid at different frequency. This probe has a built in optical surface detection system to prevent from collision with phantom.

5.1.1 ET3DV6 E-Field Probe Specification

<b>Construction</b>	Symmetrical design with triangular core Built-in optical fiber for surface detection system Built-in shielding against static charges PEEK enclosure material (resistant to organic solvents)
<b>Calibration</b>	Simulating tissue at frequencies of 900MHz, 1.8GHz and 2.45GHz for brain and muscle (accuracy $\pm 8\%$ )
<b>Frequency</b>	10 MHz to > 3 GHz
<b>Directivity</b>	$\pm 0.2$ dB in brain tissue (rotation around probe axis) $\pm 0.4$ dB in brain tissue (rotation perpendicular to probe axis)
<b>Dynamic Range</b>	5 $\mu$ W/g to > 100mW/g; Linearity: $\pm 0.2$ dB
<b>Surface Detection</b>	$\pm 0.2$ mm repeatability in air and clear liquids on reflecting surface
<b>Dimensions</b>	Overall length: 330mm Tip length: 16mm Body diameter: 12mm  Tip diameter: 6.8mm Distance from probe tip to dipole centers: 2.7mm
<b>Application</b>	General dosimetry up to 3GHz Compliance tests for mobile phones and Wireless LAN Fast automatic scanning in arbitrary phantoms



**Fig. 5.2 Probe setup on robot**

5.1.2 ET3DV6 E-Field Probe Calibration

Each probe needs to be calibrated according to a dosimetric assessment procedure with accuracy better than  $\pm 10\%$ . The spherical isotropy shall be evaluated and within  $\pm 0.25$ dB. The sensitivity parameters (NormX, NormY, and NormZ), the diode compression parameter (DCP) and the conversion factor (ConvF) of the probe are tested. The calibration data are as below:





**ET3DV6 sn1787**

<b>Sensitivity</b>	X axis : 1.57 $\mu$ V		Y axis : 1.71 $\mu$ V		Z axis : 2.09 $\mu$ V	
<b>Diode compression point</b>	X axis : 94 mV		Y axis : 94 mV		Z axis : 94 mV	
<b>Conversion factor (Head / Body)</b>	<b>Frequency (MHz)</b>	<b>X axis</b>		<b>Y axis</b>		<b>Z axis</b>
	800~1000	6.38 / 6.18		6.38 / 6.18		6.38 / 6.18
	1710~1910	5.26 / 4.66		5.26 / 4.66		5.26 / 4.66
<b>Boundary effect (Head / Body)</b>	<b>Frequency (MHz)</b>	<b>Alpha</b>		<b>Depth</b>		
	800~1000	0.50 / 0.44		1.85 / 2.10		
	1710~1910	0.59 / 0.62		2.46 / 2.44		

**ET3DV6 sn1788**

<b>Sensitivity</b>	X axis : 1.73 $\mu$ V		Y axis : 1.67 $\mu$ V		Z axis : 1.70 $\mu$ V	
<b>Diode compression point</b>	X axis : 95 mV		Y axis : 101 mV		Z axis : 93 mV	
<b>Conversion factor (Head / Body)</b>	<b>Frequency (MHz)</b>	<b>X axis</b>		<b>Y axis</b>		<b>Z axis</b>
	800~1000	6.60 / 6.33		6.60 / 6.33		6.60 / 6.33
	1710~1910	5.30 / 4.67		5.30 / 4.67		5.30 / 4.67
<b>Boundary effect (Head / Body)</b>	<b>Frequency (MHz)</b>	<b>Alpha</b>		<b>Depth</b>		
	800~1000	0.49 / 0.45		1.94 / 2.12		
	1710~1910	0.48 / 0.59		2.74 / 2.89		

NOTE:

- The probe parameters have been calibrated by the SPEAG.



### **5.2 DATA Acquisition Electronics (DAE)**

The data acquisition electronics (DAE) consists of a highly sensitive electrometer-grade preamplifier with auto-zeroing, a channel and gain-switching multiplexer, a fast 16 bit AD-converter and a command decoder and control logic unit. Transmission to the measurement server is accomplished through an optical downlink for data and status information as well as an optical uplink for commands and the clock.

The mechanical probe mounting device includes two different sensor systems for frontal and sideways probe contacts. They are used for mechanical surface detection and probe collision detection.

The input impedance of the DAE is 200M Ohm; the inputs are symmetrical and floating. Common mode rejection is above 80dB.



---

### **5.3 Robot**

The DASY4 system uses the high precision robots RX90BL type out of the newer series from Stäubli SA (France). For the 6-axis controller DASY5 system, the CS7MB robot controller version from Stäubli is used. The RX robot series have many features that are important for our application:

- High precision (repeatability 0.02 mm)
- High reliability (industrial design)
- Jerk-free straight movements
- Low ELF interference (the closed metallic construction shields against motor control fields)
- 6-axis controller

### **5.4 Measurement Server**

The DASY4 measurement server is based on a PC/104 CPU board with  
166 MHz CPU  
32 MB chipset and  
64 MB RAM.

Communication with  
the DAE4 electronic box  
the 16-bit AD-converter system for optical detection and digital I/O interface.

The measurement server performs all the real-time data evaluation for field measurements and surface detection, controls robot movements and handles safety operations.

### **5.5 SAM Twin Phantom**

The SAM twin phantom is a fiberglass shell phantom with 2mm shell thickness (except the ear region where shell thickness increases to 6mm). It has three measurement areas:

- Left head
- Right head
- Flat phantom

The bottom plate contains three pair of bolts for locking the device holder. The device holder positions are adjusted to the standard measurement positions in the three sections.

A white cover is provided to tap the phantom during off-periods to prevent water evaporation and changes in the liquid parameters.

On the phantom top, three reference markers are provided to identify the phantom position with respect to the robot.

The phantom can be used with the following tissue simulating liquids:

- \*Water-sugar based liquid
- \*Glycol based liquids



**Fig. 5.3 Top view of twin phantom**



**Fig. 5.4 Bottom view of twin phantom**

### **5.6 Device Holder for SAM Twin Phantom**

The SAR in the Phantom is approximately inversely proportional to the square of the distance between the source and the liquid surface. For a source in 5 mm distance, a positioning uncertainty of  $\pm 0.5\text{mm}$  would produce a SAR uncertainty of  $\pm 20\%$ . An accurate device position is therefore crucial for accurate and repeatable measurement. The position in which the devices must be measured, are defined by the standards.

The DASY device holder is designed to cope with different positions given in the standard. It has two scales for the device rotation (with respect to the body axis) and the device inclination (with respect to the line between the ear reference points). The rotation centers for both scales is the ear reference point (EPR). Thus the device needs no repositioning when changing the angles.

The DASY device holder has been made out of low-loss POM material having the following dielectric parameters: relative permittivity  $\epsilon_r=3$  and loss tangent  $\delta=0.02$ . The amount of dielectric material has been reduced in the closest vicinity of the device, since measurements have suggested that the influence of the clamp on the test results could thus be lowered.



**Fig. 5.5 Device Holder**



5.7 Data Storage and Evaluation

5.7.1 Data Storage

The DASY4 software stores the assessed data from the data acquisition electronics as raw data (in microvolt readings from the probe sensors), together with all the necessary software parameters for the data evaluation (probe calibration data, liquid parameters and device frequency and modulation data) in measurement files with the extension .DA4. The postprocessing software evaluates the desired unit and format for output each time the data is visualized or exported. This allows verification of the complete software setup even after the measurement and allows correction of erroneous parameter settings. For example, if a measurement has been performed with an incorrect crest factor parameter in the device setup, the parameter can be corrected afterwards and the data can be reevaluated.

The measured data can be visualized or exported in different units or formats, depending on the selected probe type (e.g., [V/m], [A/m], [mW/g]). Some of these units are not available in certain situations or give meaningless results, e.g., a SAR-output in a loseless media, will always be zero. Raw data can also be exported to perform the evaluation with other software packages.

5.7.2 Data Evaluation

The DASY4 postprocessing software (SEMCAD) automatically executes the following procedures to calculate the field units from the microvolt readings at the probe connector. The parameters used in the evaluation are stored in the configuration modules of the software :

- Probe parameters :**
  - Sensitivity Norm<sub>i</sub>, a<sub>i0</sub>, a<sub>i1</sub>, a<sub>i2</sub>
  - Conversion factor ConvF<sub>i</sub>
  - Diode compression point dcp<sub>i</sub>
- Device parameters :**
  - Frequency f
  - Crest factor cf
- Media parameters :**
  - Conductivity
  - Density

These parameters must be set correctly in the software. They can be found in the component documents or they can be imported into the software from the configuration files issued for the DASY components. In the direct measuring mode of the multimeter option, the parameters of the actual system setup are used. In the scan visualization and export modes, the parameters stored in the corresponding document files are used.

The first step of the evaluation is a linearization of the filtered input signal to account for the compression characteristics of the detector diode. The compensation depends on the input signal, the diode type and the DC-transmission factor from the diode to the evaluation electronics. If the exciting field is pulsed, the crest factor of the signal must be known to correctly compensate for peak power. The formula for each channel



can be given as :

$$V_i = U_i + U_i^2 \cdot \frac{cf}{dcp_i}$$

with  $V_i$  = compensated signal of channel  $i$  ( $i = x, y, z$ )  
 $U_i$  = input signal of channel  $i$  ( $i = x, y, z$ )  
 $cf$  = crest factor of exciting field (DASY parameter)  
 $dcp_i$  = diode compression point (DASY parameter)

From the compensated input signals, the primary field data for each channel can be evaluated :

$$\text{E-field probes : } E_i = \sqrt{\frac{V_i}{Norm_i ConvF}}$$

$$\text{H-field probes : } H_i = \sqrt{V_i \frac{a_{i0} + a_{i1}f + a_{i2}f^2}{f}}$$

with  $V_i$  = compensated signal of channel  $i$  ( $i = x, y, z$ )  
 $Norm_i$  = sensor sensitivity of channel  $i$  ( $i = x, y, z$ )  
 $\mu V/(V/m)^2$  for E-field Probes  
 $ConvF$  = sensitivity enhancement in solution  
 $a_{ij}$  = sensor sensitivity factors for H-field probes  
 $f$  = carrier frequency [GHz]  
 $E_i$  = electric field strength of channel  $i$  in V/m  
 $H_i$  = magnetic field strength of channel  $i$  in A/m

The RSS value of the field components gives the total field strength (Hermitian magnitude) :

$$E_{tot} = \sqrt{E_x^2 + E_y^2 + E_z^2}$$

The primary field data are used to calculate the derived field units.

$$SAR = E_{tot}^2 \cdot \frac{\sigma}{\rho \cdot 1000}$$

with  $SAR$  = local specific absorption rate in mW/g  
 $E_{tot}$  = total field strength in V/m  
 $\sigma$  = conductivity in [mho/m] or [Siemens/m]  
 $\rho$  = equivalent tissue density in g/cm<sup>3</sup>



\* Note that the density is set to 1, to account for actual head tissue density rather than the density of the tissue simulating liquid.

The power flow density is calculated assuming the excitation field to be a free space field.

$$P_{pwe} = \frac{E_{tot}^2}{3770} \quad \text{or} \quad P_{pwe} = H_{tot}^2 \cdot 37.7$$

with  $P_{pwe}$  = equivalent power density of a plane wave in mW/cm<sup>2</sup>  
 $E_{tot}$  = total electric field strength in V/m  
 $H_{tot}$  = total magnetic field strength in A/m





**5.8 Test Equipment List**

Manufacture	Name of Equipment	Type/Model	Serial Number	Calibration	
				Last Cal.	Due Date
SPEAG	Dosimetric E-Filed Probe	ET3DV6	1787	May 31, 2006	May 31, 2007
SPEAG	Dosimetric E-Filed Probe	ET3DV6	1788	Sep. 19, 2006	Sep. 19, 2007
SPEAG	835MHz System Validation Kit	D835V2	499	Mar. 15, 2006	Mar. 15, 2008
SPEAG	1900MHz System Validation Kit	D1900V2	5d041	Mar. 21, 2006	Mar. 21, 2008
SPEAG	Data Acquisition Electronics	DAE3	577	Nov. 21, 2006	Nov. 21, 2007
SPEAG	Device Holder	N/A	N/A	NCR	NCR
SPEAG	Phantom	QD 000 P40 C	TP-1150	NCR	NCR
SPEAG	Robot	Staubli RX90BL	F03/5W15A1/A/01	NCR	NCR
SPEAG	Software	DASY4 V4.7 Build 53	N/A	NCR	NCR
SPEAG	Software	SEMCAD V1.8 Build 172	N/A	NCR	NCR
SPEAG	Measurement Server	SE UMS 001 BA	1021	NCR	NCR
Agilent	ENA series Network Analyzer	E5071C	MY42403579	Feb. 21, 2007	Feb. 21, 2008
Agilent	Dielectric Probe Kit	85070D	US01440205	NCR	NCR
Agilent	Dual Directional Coupler	778D	50422	NCR	NCR
Agilent	Power Amplifier	8449B	3008A01917	NCR	NCR
R&S	Radio Communication Tester	CMU200	105513	Jul. 25, 2006	Jul. 25, 2007
Agilent	Power Meter	E4416A	GB41292344	Feb. 08, 2007	Feb. 08, 2008
Agilent	Power Sensor	E9327A	US40441548	Feb. 08, 2007	Feb. 08, 2008
Agilent	Signal Generator	E8247C	MY43320596	Mar. 01, 2006	Mar. 01, 2008

**Table 5.1 Test Equipment List**

## 6. Tissue Simulating Liquids

For the measurement of the field distribution inside the SAM phantom with DASY4, the phantom must be filled with around 25 liters of homogeneous tissue simulating liquid. The liquid height from the ear reference point (ERP) of the phantom to the liquid top surface is (head SAR) or from the flat phantom to the liquid top surface (body SAR) is 15.2cm.

The following ingredients for tissue simulating liquid are used:

- **Water:** deionized water (pure H<sub>2</sub>O), resistivity 16M $\Omega$  - as basis for the liquid
- **Sugar:** refined sugar in crystals, as available in food shops – to reduce relative permittivity
- **Salt:** pure NaCl – to increase conductivity
- **Cellulose:** Hydroxyethyl-cellulose, medium viscosity (75-125 mPa.s, 2% in water, 20°C), CAS#54290-to increase viscosity and to keep sugar in solution.
- **Preservative:** Preventol D-7 Bayer AG, D-51368 Leverkusen, CAS#55965-84-9- to prevent the spread of bacteria and molds.
- **DGMBE:** Deithlenglycol-monobuthyl ether (DGMBE), Fluka Chemie GmbH, CAS#112-34-5 – to reduce relative permittivity.

Table 6.1 gives the recipes for one liter of head and body tissue simulating liquid for frequency band 1900 MHz.

Ingredient	HSL-850	MSL-850	HSL-1900	MSL-1900
Water	532.98 g	631.68 g	552.42 g	716.56 g
Cellulose	0 g	0 g	0 g	0 g
Salt	18.3 g	11.72 g	3.06 g	4.0 g
Preventol D-7	2.4 g	1.2 g	0 g	0 g
Sugar	766.0 g	600.0 g	0 g	0 g
DGMBE	0 g	0 g	444.52 g	300.67 g
Total amount	1 liter (1.3 kg)	1 liter	1 liter (1.0 kg)	1 liter (1.0 kg)
Dielectric Parameters at 22°	f = 835 MHz r = 41.5±5%, = 0.90±5% S/m	f = 835 MHz r = 55.2±5%, = 0.97±5% S/m	f = 1900 MHz r = 40.0±5%, = 1.4±5% S/m	f = 1900 MHz r = 53.3±5 %, = 1.52±5% S/m

**Table 6.1**

The dielectric parameters of the liquids were verified prior to the SAR evaluation using an Agilent 85070D Dielectric Probe Kit and an Agilent Network Analyzer.



Table 6.2 shows the measuring results for head and muscle simulating liquid.

	Bands	Frequency(MHz)	Permittivity ( $\epsilon_r$ )	Conductivity ( $\sigma$ )	Measurement Date
Head	GSM850 band (824 ~ 849 MHz)	824.2	43.2	0.886	Feb. 04, 2007
		836.4	43.1	0.900	
		848.8	42.9	0.912	
Body	GSM850 band (824 ~ 849 MHz)	824.2	56.2	0.959	Feb. 04, 2007
		836.6	56.2	0.972	
		848.8	56.1	0.984	
Head	PCS band (1850 ~ 1910 MHz)	1850.2	41.6	1.43	Feb. 04, 2007
		1880.0	41.5	1.45	
		1909.8	41.1	1.47	
Body	PCS band (1850 ~ 1910 MHz)	1850.2	53.2	1.48	May 06, 2007
		1880.0	53.0	1.52	
		1909.8	52.8	1.57	
Head	GSM850 band (824 ~ 849 MHz)	824.2	43.3	0.879	May 01, 2007
		836.4	43.1	0.890	
		848.8	42.8	0.902	
Body	GSM850 band (824 ~ 849 MHz)	824.2	54.3	0.956	May 05, 2007
		836.6	54.1	0.969	
		848.8	54.0	0.982	
Head	PCS band (1850 ~ 1910 MHz)	1850.2	38.9	1.37	May 04, 2007
		1880.0	38.9	1.40	
		1909.8	38.8	1.42	
Body	PCS band (1850 ~ 1910 MHz)	1850.2	53.3	1.49	May 06, 2007
		1880.0	53.1	1.52	
		1909.8	52.9	1.57	

**Table 6.2**

The measuring data are consistent with  $\epsilon_r = 41.5 \pm 5\%$  and  $\sigma = 0.9 \pm 5\%$  for head GSM 850 band and  $\epsilon_r = 55.2 \pm 5\%$  and  $\sigma = 0.97 \pm 5\%$  for body GSM 850 band and  $\epsilon_r = 40.0 \pm 5\%$  and  $\sigma = 1.4 \pm 5\%$  for head PCS 1900 band and  $\epsilon_r = 53.3 \pm 5\%$  and  $\sigma = 1.52 \pm 5\%$  for body PCS 1900 band.



### 7. Uncertainty Assessment

The component of uncertainty may generally be categorized according to the methods used to evaluate them. The evaluation of uncertainty by the statistical analysis of a series of observations is termed a Type A evaluation of uncertainty. The evaluation of uncertainty by means other than the statistical analysis of a series of observation is termed a Type B evaluation of uncertainty. Each component of uncertainty, however evaluated, is represented by an estimated standard deviation, termed standard uncertainty, which is determined by the positive square root of the estimated variance.

A Type A evaluation of standard uncertainty may be based on any valid statistical method for treating data. This includes calculating the standard deviation of the mean of a series of independent observations; using the method of least squares to fit a curve to the data in order to estimate the parameter of the curve and their standard deviations; or carrying out an analysis of variance in order to identify and quantify random effects in certain kinds of measurement.

A type B evaluation of standard uncertainty is typically based on scientific judgment using all of the relevant information available. These may include previous measurement data, experience and knowledge of the behavior and properties of relevant materials and instruments, manufacture’s specification, data provided in calibration reports and uncertainties assigned to reference data taken from handbooks. Broadly speaking, the uncertainty is either obtained from an outdoor source or obtained from an assumed distribution, such as the normal distribution, rectangular or triangular distributions indicated in Table 7.1

Uncertainty Distributions	Normal	Rectangular	Triangular	U-shape
Multiplying factor <sup>(a)</sup>	1/k <sup>(b)</sup>	1/ 3	1/ 6	1/ 2

(a) standard uncertainty is determined as the product of the multiplying factor and the estimated range of variations in the measured quantity

(b) is the coverage factor

**Table 7.1**

The combined standard uncertainty of the measurement result represents the estimated standard deviation of the result. It is obtained by combining the individual standard uncertainties of both Type A and Type B evaluation using the usual “root-sum-squares” (RSS) methods of combining standard deviations by taking the positive square root of the estimated variances.

Expanded uncertainty is a measure of uncertainty that defines an interval about the measurement result within which the measured value is confidently believed to lie. It is obtained by multiplying the combined standard uncertainty by a coverage factor. Typically, the coverage factor ranges from 2 to 3. Using a coverage factor allows the true value of a measured quantity to be specified with a defined probability within the specified uncertainty range. For purpose of this document, a coverage factor two is used, which corresponds to confidence interval of about 95 %. The DASY4 uncertainty Budget is showed in Table 7.2.



Error Description	Uncertainty Value $\pm$ %	Probability Distribution	Divisor	$C_i$ $1g$	Standard Unc. (1-g)	$v_i$ or $V_{eff}$
<b>Measurement System</b>						
Probe Calibration	$\pm 4.8$	Normal	1	1	$\pm 4.8$	
Axial Isotropy	$\pm 4.7$	Rectangular	$\sqrt{3}$	$(1-C_p)^{1/2}$	$\pm 1.9$	
Hemispherical Isotropy	$\pm 9.6$	Rectangular	$\sqrt{3}$	$(C_p)^{1/2}$	$\pm 3.9$	
Boundary Effect	$\pm 1.0$	Rectangular	$\sqrt{3}$	1	$\pm 0.6$	
Linearity	$\pm 4.7$	Rectangular	$\sqrt{3}$	1	$\pm 2.7$	
System Detection Limit	$\pm 1.0$	Rectangular	$\sqrt{3}$	1	$\pm 0.6$	
Readout Electronics	$\pm 1.0$	Rectangular	1	1	$\pm 1.0$	
Response Time	$\pm 0.8$	Normal	$\sqrt{3}$	1	$\pm 0.5$	
Integration time	$\pm 2.6$	Rectangular	$\sqrt{3}$	1	$\pm 1.5$	
RF Ambient Conditions	$\pm 3.0$	Rectangular	$\sqrt{3}$	1	$\pm 1.7$	
Probe Positioner Mech. Tolerance	$\pm 0.4$	Rectangular	$\sqrt{3}$	1	$\pm 0.2$	
Probe Positioning with respect to Phantom Shell	$\pm 2.9$	Rectangular	$\sqrt{3}$	1	$\pm 1.7$	
Extrapolation and Interpolation Algorithms for Max. SAR Evaluation	$\pm 1.0$	Rectangular	$\sqrt{3}$	1	$\pm 0.6$	
<b>Test sample Related</b>						
Test sample Positioning	$\pm 2.9$	Normal	1	1	$\pm 2.9$	145
Device Holder Uncertainty	$\pm 3.6$	Normal	1	1	$\pm 3.6$	5
Output Power Variation-SAR drift measurement	$\pm 2.5$	Rectangular	$\sqrt{3}$	1	$\pm 1.4$	
<b>Phantom and Tissue parameters</b>						
Phantom uncertainty(Including shape and thickness tolerances)	$\pm 4.0$	Rectangular	$\sqrt{3}$	1	$\pm 2.3$	
Liquid Conductivity Target tolerance	$\pm 5.0$	Rectangular	$\sqrt{3}$	0.64	$\pm 1.8$	
Liquid Conductivity measurement uncertainty	$\pm 2.5$	Normal	1	0.64	$\pm 1.6$	
Liquid Permittivity Target tolerance	$\pm 5.0$	Rectangular	$\sqrt{3}$	0.6	$\pm 1.7$	
Liquid Permittivity measurement uncertainty	$\pm 2.0$	Normal	1	0.6	$\pm 1.2$	
Combined standard uncertainty					$\pm 10.3$	330
<b>Coverage Factor for 95 %</b>		<b>K=2</b>				
<b>Expanded uncertainty (Coverage factor = 2)</b>					<b><math>\pm 20.6</math></b>	

Table 7.2 Uncertainty Budget of DASY

## 8. SAR Measurement Evaluation

Each DASY system is equipped with one or more system validation kits. These units, together with the predefined measurement procedures within the DASY software, enable the user to conduct the system performance check and system validation. System validation kit includes a dipole, tripod holder to fix it underneath the flat phantom and a corresponding distance holder.

### 8.1 Purpose of System Performance check

The system performance check verifies that the system operates within its specifications. System and operator errors can be detected and corrected. It is recommended that the system performance check be performed prior to any usage of the system in order to guarantee reproducible results. The system performance check uses normal SAR measurements in a simplified setup with a well characterized source. This setup was selected to give a high sensitivity to all parameters that might fail or vary over time. The system check does not intend to replace the calibration of the components, but indicates situations where the system uncertainty is exceeded due to drift or failure.

### 8.2 System Setup

In the simplified setup for system evaluation, the DUT is replaced by a calibrated dipole and the power source is replaced by a continuous wave which comes from a signal generator at frequency 835 and 1900 MHz. The calibrated dipole must be placed beneath the flat phantom section of the SAM twin phantom with the correct distance holder. The distance holder should touch the phantom surface with a light pressure at the reference marking and be oriented parallel to the long side of the phantom. The equipment setup is shown below:

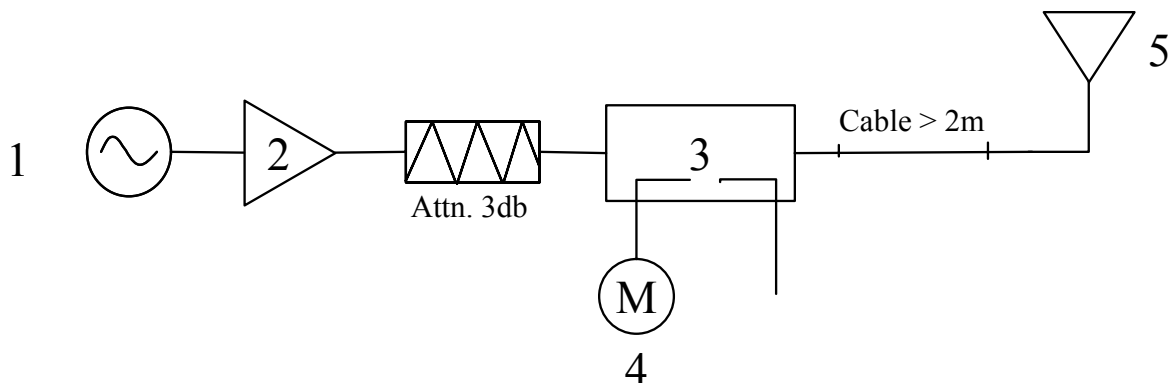

**Fig. 8.1**

1. Signal Generator
2. Amplifier
3. Directional Coupler
4. Power Meter
5. 835 or 1900 MHz Dipole

The output power on dipole port must be calibrated to 20dBm (100mW) before dipole is connected.



**Fig 8.2 Dipole Setup**



8.3 Validation Results

Comparing to the original SAR value provided by Speag, the validation data should be within its specification of 10 %. Table 8.1 shows the target SAR and measured SAR after normalized to 1W input power.

		Target (W/kg)	Measurement data (W/kg)	Variation	Measurement Date
GSM850 band (835MHz) for head	SAR (1g)	9.24	9.51	2.9 %	Feb. 04, 2007
	SAR (10g)	6.07	6.24	2.8 %	
GSM850 band (835MHz) for body	SAR (1g)	9.91	9.37	-5.4 %	Feb. 04, 2007
	SAR (10g)	6.55	6.17	-5.8 %	
PCS band (1900MHz) for head	SAR (1g)	38.4	39.2	2.1 %	Feb. 04, 2007
	SAR (10g)	20.5	21.1	2.9 %	
PCS band (1900MHz) for body	SAR (1g)	41.1	38.8	-5.6 %	May 06, 2007
	SAR (10g)	21.8	20.9	-4.1 %	
GSM850 band (835MHz) for head	SAR (1g)	9.24	9.37	1.4 %	May 01, 2007
	SAR (10g)	6.07	6.2	2.1 %	
GSM850 band (835MHz) for body	SAR (1g)	9.91	10	0.9 %	May 05, 2007
	SAR (10g)	6.55	6.59	0.6 %	
PCS band (1900MHz) for head	SAR (1g)	38.4	38.2	-0.5 %	May 04, 2007
	SAR (10g)	20.5	20.5	0.0 %	
PCS band (1900MHz) for body	SAR (1g)	41.1	41.3	0.5 %	May 06, 2007
	SAR (10g)	21.8	21.8	0.0 %	

Table 8.1

The table above indicates the system performance check can meet the variation criterion.





## **9. Description for DUT Testing Position**

This DUT was tested in 6 different positions. They are left cheek, left tilted, right cheek, right tilted, body worn with keypad up and body worn with keypad down as illustrated below:

- 1) “Cheek Position”
  - i) To position the device with the vertical center line of the body of the device and the horizontal line crossing the center piece in a plane parallel to the sagittal plane of the phantom. While maintaining the device in this plane, align the vertical center line with the reference plane containing the three ear and mouth reference point (M, RE and LE) and align the center of the ear piece with the line RE-LE.
  - ii) To move the device towards the phantom with the ear piece aligned with the line LE-RE until the phone touched the ear. While maintaining the device in the reference plane and maintaining the phone contact with the ear, move the bottom of the phone until any point on the front side is in contact with the cheek of the phantom or until contact with the ear is lost (see Fig. 9.1).
- 2) “Tilted Position”
  - i) To position the device in the “cheek” position described above.
  - ii) While maintaining the device the reference plane described above and pivoting against the ear, move it outward away from the mouth by an angle of 15 degrees or until contact with the ear is lost (see Fig. 9.2).
- 3) “Body Worn”
  - i) To position the device parallel to the phantom surface.
  - ii) To adjust the phone parallel to the flat phantom.
  - iii) To adjust the distance between the DUT surface and the flat phantom to 1.5 cm or the Holster surface and the flat phantom to 0 cm

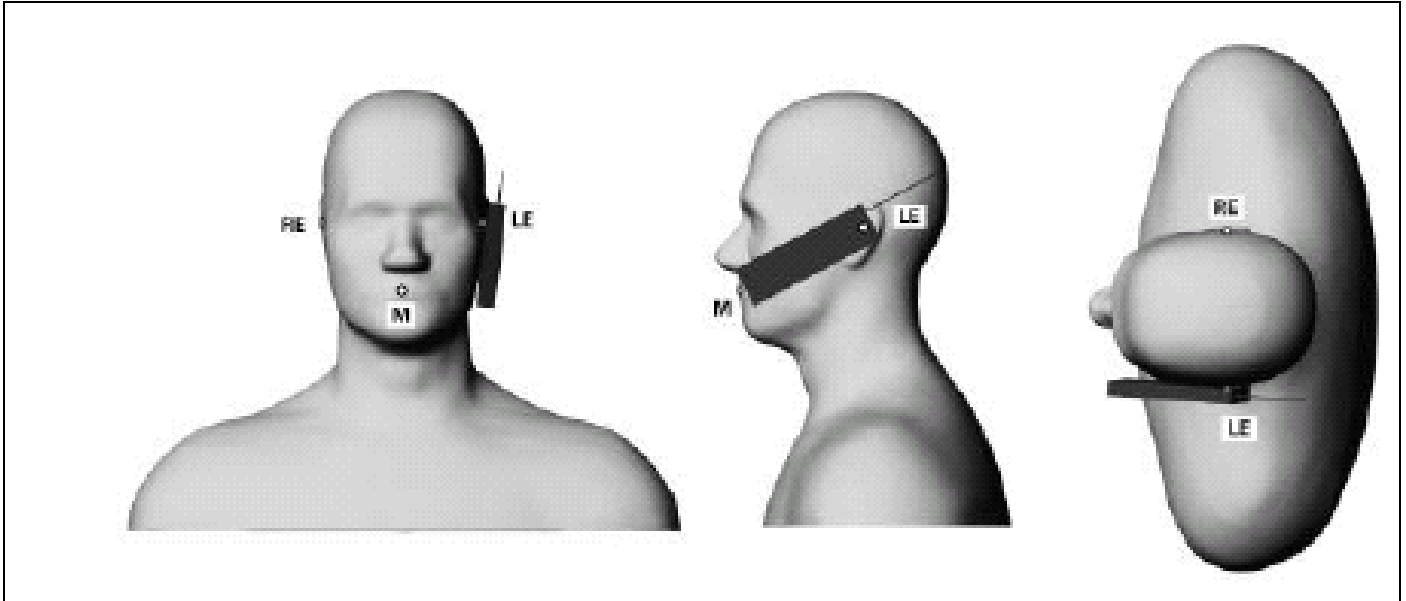

**Fig. 9.1** Phone Position 1, “Cheek” or “Touch” Position. The reference points for the right ear (RE), left ear (LE) and mouth (M), which define the plane for phone positioning, are indicated.

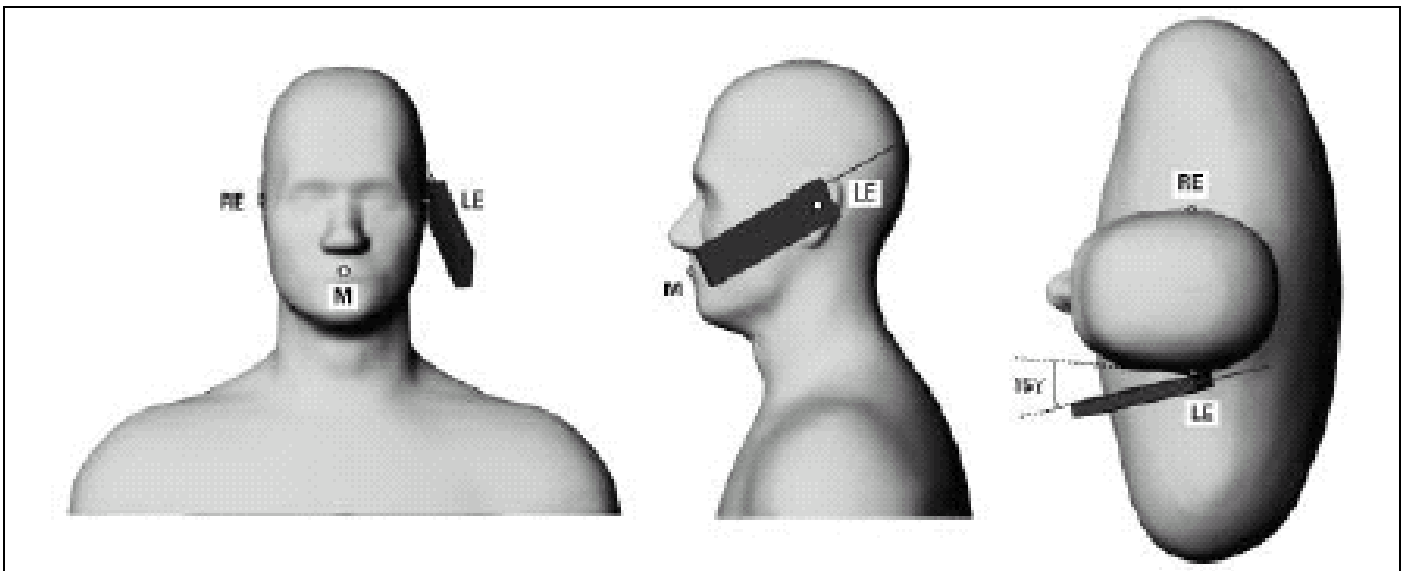

**Fig. 9.2** Phone Position 2, “Tilted Position”. The reference point for the right ear (RE), left ear (LE) and mouth (M), which define the plane for phone positioning, are indicated.



**Fig. 9.3 Right Cheek for 7527C**



**Fig. 9.4 Right Tilted for 7527C**



**Fig. 9.5 Left Cheek for 7527C**



**Fig. 9.6 Left Tilted for 7527C**



**Fig. 9.7 Left Tilted for 7527S**

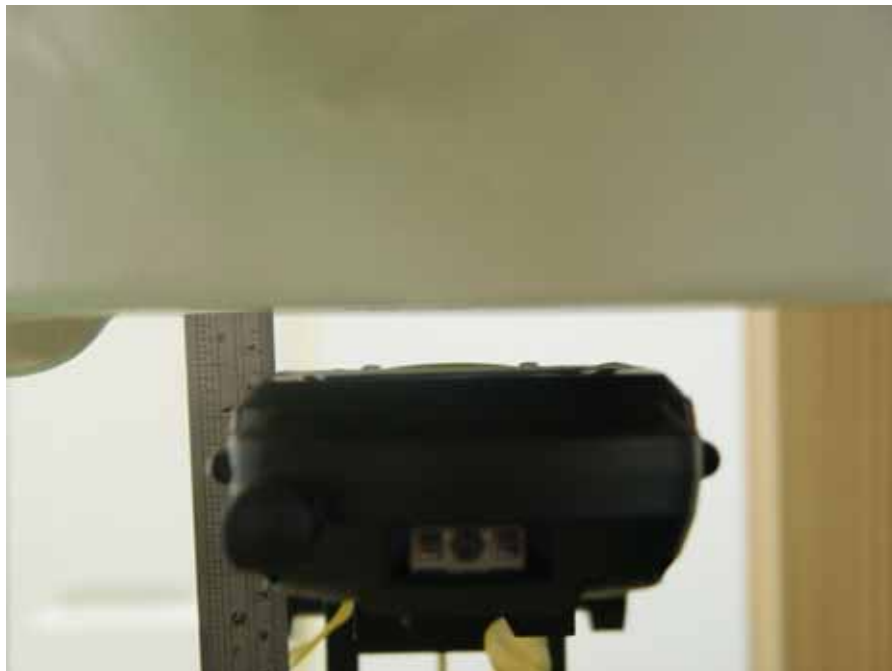

**Fig. 9.8 Keypad Up with 1.5cm Gap for 7527C**



**Fig. 9.9 Keypad Down with 1.5cm Gap for 7527C**

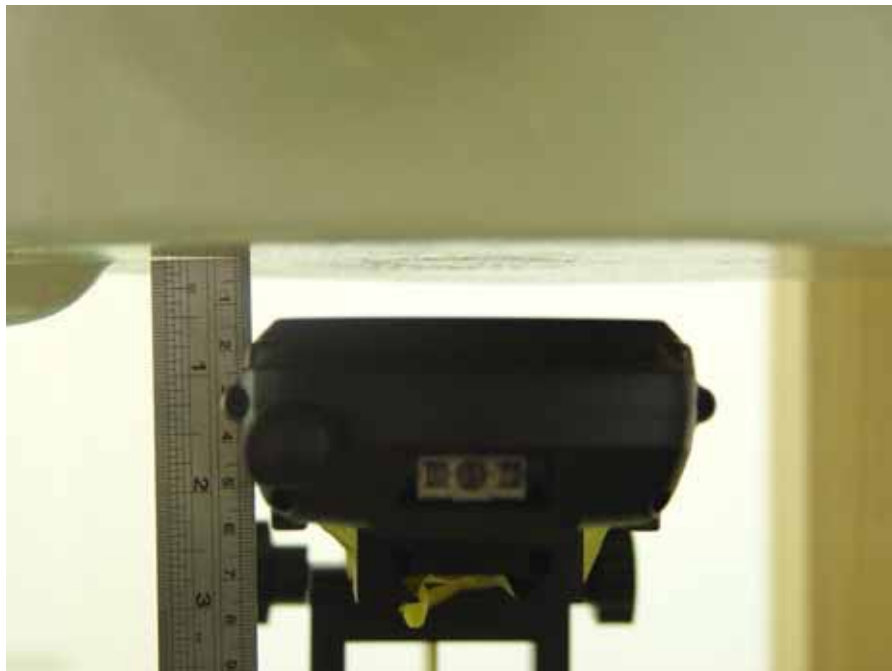

**Fig. 9.10 Keypad Up with 1.5cm Gap for 7527S**



**Fig. 9.11 Holster Left Side Touch for 7527C**



**Fig. 9.12 Holster Right Side Touch for 7527C**



**Fig. 9.13 Holster Left Side Touch for 7527S**



**Fig. 9.14 Holster Right Side Touch for 7527S**





## **10. Measurement Procedures**

The measurement procedures are as follows:

- Linking DUT with base station emulator CMU200 in middle channel for PCS1900 band
- Setting PCL=5 for GSM850 or PCL=0 for PCS1900 on CMU200 to allow DUT to radiate maximum output power
- Measuring output power through RF cable and power meter
- Placing the DUT in the positions described in the last section
- Setting scan area, grid size and other setting on the DASY4 software
- Taking data for the lowest, middle, and highest channel on each testing position

According to the IEEE P1528 draft standard, the recommended procedure for assessing the peak spatial-average SAR value consists of the following steps:

- Power reference measurement
- Area scan
- Zoom scan
- Power reference measurement

### **10.1 Spatial Peak SAR Evaluation**

The procedure for spatial peak SAR evaluation has been implemented according to the IEEE1528-2003 standard. It can be conducted for 1g and 10g, as well as for user-specific masses. The DASY4 software includes all numerical procedures necessary to evaluate the spatial peak SAR value.

Base on the Draft: SCC-34, SC-2, WG-2-Computational Dosimetry, IEEE P1528/D1.2 (Recommended Practice for Determining the Peak Spatial-Average Specific Absorption Rate (SAR) in the Human Head from Wireless Communications Devices: Measurement Techniques), a new algorithm has been implemented. The spatial-peak SAR can be computed over any required mass.

The base for the evaluation is a "cube" measurement. The measured volume must include the 1g and 10g cubes with the highest averaged SAR values. For that purpose , the center of the measured volume is aligned to the interpolated peak SAR value of a previously performed area scan.

The entire evaluation of the spatial peak values is performed within the postprocessing engine (SEMCAD). The system always gives the maximum values for the 1g and 10g cubes. The algorithm to find the cube with highest averaged SAR is divided into the following stages:



- 
- extraction of the measured data (grid and values) from the Zoom Scan
  - calculation of the SAR value at every measurement point based on all stored data (A/D values and measurement parameters)
  - generation of a high-resolution mesh within the measured volume
  
  - interpolation of all measured values from the measurement grid to the high-resolution grid
  - extrapolation of the entire 3-D field distribution to the phantom surface over the distance from sensor to surface
  - calculation of the averaged SAR within masses of 1g and 10g

### **10.2 Scan Procedures**

First **Area Scan** is used to locate the approximate location(s) of the local peak SAR value(s). The measurement grid within an **Area Scan** is defined by the grid extent, grid step size and grid offset. Next, in order to determine the EM field distribution in a three-dimensional spatial extension, **Zoom Scan** is required. The **Zoom Scan** measures 5x5x7 points with step size 8, 8 and 5 mm. The **Zoom Scan** is performed around the highest E-field value to determine the averaged SAR-distribution over 1 g.

### **10.3 SAR Averaged Methods**

In DASY4, the interpolation and extrapolation are both based on the modified Quadratic Shepard's method. The interpolation scheme combines a least-square fitted function method and a weighted average method which are the two basic types of computational interpolation and approximation.

Extrapolation routines are used to obtain SAR values between the lowest measurement points and the inner phantom surface. The extrapolation distance is determined by the surface detection distance and the probe sensor offset. The uncertainty increases with the extrapolation distance. To keep the uncertainty within 1% for the 1 g and 10 g cubes, the extrapolation distance should not be larger than 5 mm.



## 11. SAR Test Results

### 11.1 Right Cheek

Model	Mode	Accessory	Chan.	Freq (MHz)	Modulation Type	Conducted Power (dBm)	Power Drift (dB)	Measured 1g SAR (W/kg)	Limit (W/kg)	Results
7527C	GSM850	Endcap 1+B2	128	824.2 (Low)	GMSK	31.54	-	-	-	-
			189	836.4 (Mid)	GMSK	31.49	-0.036	0.491	1.6	Pass
			251	848.8 (High)	GMSK	31.44	-	-	-	-
	PCS1900	Endcap 1+B2	512	1850.2 (Low)	GMSK	29.03	-	-	-	-
			661	1880.0 (Mid)	GMSK	28.76	0.028	0.338	1.6	Pass
			810	1909.8 (High)	GMSK	28.41	-	-	-	-

### 11.2 Right Tilted

Model	Mode	Accessory	Chan.	Freq (MHz)	Modulation Type	Conducted Power (dBm)	Power Drift (dB)	Measured 1g SAR (W/kg)	Limit (W/kg)	Results
7527C	GSM850	Endcap 1+B2	128	824.2 (Low)	GMSK	31.54	-	-	-	-
			189	836.4 (Mid)	GMSK	31.49	-0.02	0.606	1.6	Pass
			251	848.8 (High)	GMSK	31.44	-	-	-	-
	PCS1900	Endcap 1+B2	512	1850.2 (Low)	GMSK	29.03	-	-	-	-
			661	1880.0 (Mid)	GMSK	28.76	-0.02	0.393	1.6	Pass
			810	1909.8 (High)	GMSK	28.41	-	-	-	-

### 11.3 Left Cheek

Model	Mode	Accessory	Chan.	Freq (MHz)	Modulation Type	Conducted Power (dBm)	Power Drift (dB)	Measured 1g SAR (W/kg)	Limit (W/kg)	Results
7527C	GSM850	Endcap 1+B2	128	824.2 (Low)	GMSK	31.54	-	-	-	-
			189	836.4 (Mid)	GMSK	31.49	-0.121	0.653	1.6	Pass
			251	848.8 (High)	GMSK	31.44	-	-	-	-
	PCS1900	Endcap 1+B2	512	1850.2 (Low)	GMSK	29.03	-	-	-	-
			661	1880.0 (Mid)	GMSK	28.76	0.001	0.447	1.6	Pass
			810	1909.8 (High)	GMSK	28.41	-	-	-	-



11.4 Left Tilted

Model	Mode	Accessory	Chan.	Freq (MHz)	Modulation Type	Conducted Power (dBm)	Power Drift (dB)	Measured 1g SAR (W/kg)	Limit (W/kg)	Results			
75257C	GSM850	Endcap 1+B2	128	824.2 (Low)	GMSK	31.54	-0.023	0.697	1.6	Pass			
			189	836.4 (Mid)	GMSK	31.49	-0.061	0.864	1.6	Pass			
			251	848.8 (High)	GMSK	31.44	-0.019	1.11	1.6	Pass			
	GSM850 With BT On	Endcap 1+B2	251	848.8 (High)	GMSK	31.44	-0.007	1.12	1.6	Pass			
			251	848.8 (High)	GMSK	31.44	-0.127	1.09	1.6	Pass			
			251	848.8 (High)	GMSK	31.44	0.004	1.22	1.6	Pass			
			251	848.8 (High)	GMSK	31.44	-0.107	1.15	1.6	Pass			
			251	848.8 (High)	GMSK	31.44	-0.018	1.25	1.6	Pass			
			128	824.2 (Low)	GMSK	31.54	-0.027	0.907	1.6	Pass			
											189	836.4 (Mid)	GMSK
						<b>251</b>	<b>848.8 (High)</b>	<b>GMSK</b>	<b>31.44</b>	<b>-0.176</b>	<b>1.3</b>	<b>1.6</b>	<b>Pass</b>
				251	848.8 (High)	GMSK	31.44	0.029	1.24	1.6	Pass		
				251	848.8 (High)	GMSK	31.44	-0.094	1.21	1.6	Pass		
		251	848.8 (High)	GMSK	31.44	-0.089	1.14	1.6	Pass				
	PCS1900	Endcap 1+B2	512	1850.2 (Low)	GMSK	29.03	-0.009	0.544	1.6	Pass			
			661	1880.0 (Mid)	GMSK	28.76	-0.017	0.492	1.6	Pass			
			810	1909.8 (High)	GMSK	28.41	0.063	0.357	1.6	Pass			
	PCS1900 with BT On	Endcap 1+B2	<b>512</b>	<b>1850.2 (Low)</b>	<b>GMSK</b>	<b>29.03</b>	<b>-0.089</b>	<b>0.551</b>	<b>1.6</b>	<b>Pass</b>			
			512	1850.2 (Low)	GMSK	29.03	0.157	0.396	1.6	Pass			
			512	1850.2 (Low)	GMSK	29.03	-0.167	0.36	1.6	Pass			
512			1850.2 (Low)	GMSK	29.03	0.123	0.441	1.6	Pass				
512			1850.2 (Low)	GMSK	29.03	-0.048	0.447	1.6	Pass				
512			1850.2 (Low)	GMSK	29.03	-0.138	0.46	1.6	Pass				
512			1850.2 (Low)	GMSK	29.03	-0.106	0.451	1.6	Pass				
512			1850.2 (Low)	GMSK	29.03	-0.101	0.435	1.6	Pass				
	512	1850.2 (Low)	GMSK	29.03	-0.106	0.438	1.6	Pass					
7527S	GSM850 With BT On	POD 3+B2	<b>251</b>	<b>848.8 (High)</b>	<b>GMSK</b>	<b>31.44</b>	<b>-0.132</b>	<b>1.01</b>	<b>1.6</b>	<b>Pass</b>			
	PCS1900 with BT On	Endcap 1+B2	<b>512</b>	<b>1850.2 (Low)</b>	<b>GMSK</b>	<b>29.03</b>	<b>-0.148</b>	<b>0.632</b>	<b>1.6</b>	<b>Pass</b>			



**11.5 Keypad Up with 1.5cm Gap**

Model	Mode	Accessory	Chan.	Freq (MHz)	Modulation Type	Conducted Power (dBm)	Power Drift (dB)	Measured 1g SAR (W/kg)	Limit (W/kg)	Results
7527C	GSM850 (GPRS8)	Endcap 1+B2	128	824.2 (Low)	GMSK	31.50	-	-	-	-
			189	836.4 (Mid)	GMSK	31.45	-0.099	0.267	1.6	Pass
			251	848.8 (High)	GMSK	31.41	-	-	-	-
	GSM850 (GPRS10)	Endcap 1+B2	128	824.2 (Low)	GMSK	29.95	-0.004	0.237	1.6	Pass
			189	836.4 (Mid)	GMSK	29.92	-0.054	0.32	1.6	Pass
			<b>251</b>	<b>848.8 (High)</b>	<b>GMSK</b>	<b>29.85</b>	<b>-0.044</b>	<b>0.422</b>	<b>1.6</b>	<b>Pass</b>
	GSM850 (GPRS10) with BT On	Endcap 1+B2	251	848.8 (High)	GMSK	29.85	-0.027	0.409	1.6	Pass
	GSM850 (GPRS12)	Endcap 1+B2	128	824.2 (Low)	GMSK	27.50	-	-	-	-
			189	836.4 (Mid)	GMSK	27.60	-0.033	0.296	1.6	Pass
			251	848.8 (High)	GMSK	27.60	-	-	-	-
	GSM850 (EGPRS8)	Endcap 1+B2	128	824.2 (Low)	8PSK	29.60	-	-	-	-
			189	836.4 (Mid)	8PSK	27.30	-0.132	0.081	1.6	Pass
			251	848.8 (High)	8PSK	27.30	-	-	-	-
	GSM850 (EGPRS10)	Endcap 1+B2	128	824.2 (Low)	8PSK	27.40	-	-	-	-
			189	836.4 (Mid)	8PSK	27.30	-0.172	0.093	1.6	Pass
			251	848.8 (High)	8PSK	27.30	-	-	-	-
	GSM850 (EGPRS12)	Endcap 1+B2	128	824.2 (Low)	8PSK	23.10	-	-	-	-
			189	836.4 (Mid)	8PSK	23.10	-0.132	0.068	1.6	Pass
			251	848.8 (High)	8PSK	23.00	-	-	-	-
	PCS1900 (GPRS8)	Endcap 1+B2	512	1850.2 (Low)	GMSK	29.06	-	-	-	-
			661	1880.0 (Mid)	GMSK	28.78	-0.069	0.121	1.6	Pass
			810	1909.8 (High)	GMSK	28.41	-	-	-	-
	PCS1900 (GPRS10)	Endcap 1+B2	<b>512</b>	<b>1850.2 (Low)</b>	<b>GMSK</b>	<b>27.28</b>	<b>-0.046</b>	<b>0.161</b>	<b>1.6</b>	<b>Pass</b>
			661	1880.0 (Mid)	GMSK	27.02	-0.002	0.151	1.6	Pass
810			1909.8 (High)	GMSK	26.66	-0.038	0.125	1.6	Pass	
PCS1900 (GPRS10) with BT On	Endcap 1+B2	512	1850.2 (Low)	GMSK	27.28	-0.019	0.151	1.6	Pass	
PCS1900 (GPRS12)	Endcap 1+B2	512	1850.2 (Low)	GMSK	24.10	-	-	-	-	
		661	1880.0 (Mid)	GMSK	23.90	-0.042	0.12	1.6	Pass	
		810	1909.8 (High)	GMSK	28.00	-	-	-	-	
PCS1900 (EGPRS8)	Endcap 1+B2	512	1850.2 (Low)	8PSK	28.20	-	-	-	-	
		661	1880.0 (Mid)	8PSK	26.00	-0.152	0.036	1.6	Pass	
		810	1909.8 (High)	8PSK	25.90	-	-	-	-	
PCS1900 (EGPRS10)	Endcap 1+B2	512	1850.2 (Low)	8PSK	26.00	-	-	-	-	
		661	1880.0 (Mid)	8PSK	26.00	-0.15	0.043	1.6	Pass	
		810	1909.8 (High)	8PSK	25.90	-	-	-	-	
PCS1900 (EGPRS12)	Endcap 1+B2	512	1850.2 (Low)	8PSK	22.00	-	-	-	-	
		661	1880.0 (Mid)	8PSK	21.90	-0.11	0.033	1.6	Pass	
		810	1909.8 (High)	8PSK	21.70	-	-	-	-	
7527S	GSM850 (GPRS10)	Endcap 1+B2	<b>251</b>	<b>848.8 (High)</b>	<b>GMSK</b>	<b>29.85</b>	<b>-0.098</b>	<b>0.489</b>	<b>1.6</b>	<b>Pass</b>
	PCS1900 (GPRS10)	Endcap 1+B2	<b>512</b>	<b>1850.2 (Low)</b>	<b>GMSK</b>	<b>27.28</b>	<b>-0.119</b>	<b>0.171</b>	<b>1.6</b>	<b>Pass</b>



**11.6 Keypad Down with 1.5cm Gap**

Model	Mode	Accessory	Chan.	Freq (MHz)	Modulation Type	Conducted Power (dBm)	Power Drift (dB)	Measured 1g SAR (W/kg)	Limit (W/kg)	Results
7527C	GSM850 (GPRS8)	Endcap 1+B2	128	824.2 (Low)	GMSK	31.50	-	-	-	-
			189	836.4 (Mid)	GMSK	31.45	-0.156	0.246	1.6	Pass
			251	848.8 (High)	GMSK	31.41	-	-	-	-
	GSM850 (GPRS10)	Endcap 1+B2	128	824.2 (Low)	GMSK	29.95	-	-	-	-
			189	836.4 (Mid)	GMSK	29.92	-	-	-	-
			251	848.8 (High)	GMSK	29.85	-	-	-	-
	GSM850 (GPRS12)	Endcap 1+B2	128	824.2 (Low)	GMSK	27.50	-	-	-	-
			189	836.4 (Mid)	GMSK	27.60	-	-	-	-
			251	848.8 (High)	GMSK	27.60	-	-	-	-
	GSM850 (EGPRS8)	Endcap 1+B2	128	824.2 (Low)	8PSK	29.60	-	-	-	-
			189	836.4 (Mid)	8PSK	27.30	-	-	-	-
			251	848.8 (High)	8PSK	27.30	-	-	-	-
	GSM850 (EGPRS10)	Endcap 1+B2	128	824.2 (Low)	8PSK	27.40	-	-	-	-
			189	836.4 (Mid)	8PSK	27.30	-	-	-	-
			251	848.8 (High)	8PSK	27.30	-	-	-	-
	GSM850 (EGPRS12)	Endcap 1+B2	128	824.2 (Low)	8PSK	23.10	-	-	-	-
			189	836.4 (Mid)	8PSK	23.10	-	-	-	-
			251	848.8 (High)	8PSK	23.00	-	-	-	-
	PCS1900 (GPRS8)	Endcap 1+B2	512	1850.2 (Low)	GMSK	29.06	-	-	-	-
			661	1880.0 (Mid)	GMSK	28.78	-0.062	0.072	1.6	Pass
			810	1909.8 (High)	GMSK	28.41	-	-	-	-
	PCS1900 (GPRS10)	Endcap 1+B2	512	1850.2 (Low)	GMSK	27.28	-	-	-	-
			661	1880.0 (Mid)	GMSK	27.02	-	-	-	-
			810	1909.8 (High)	GMSK	26.66	-	-	-	-
	PCS1900 (GPRS12)	Endcap 1+B2	512	1850.2 (Low)	GMSK	24.10	-	-	-	-
			661	1880.0 (Mid)	GMSK	23.90	-	-	-	-
			810	1909.8 (High)	GMSK	28.00	-	-	-	-
	PCS1900 (EGPRS8)	Endcap 1+B2	512	1850.2 (Low)	8PSK	28.20	-	-	-	-
			661	1880.0 (Mid)	8PSK	26.00	-	-	-	-
			810	1909.8 (High)	8PSK	25.90	-	-	-	-
PCS1900 (EGPRS10)	Endcap 1+B2	512	1850.2 (Low)	8PSK	26.00	-	-	-	-	
		661	1880.0 (Mid)	8PSK	26.00	-	-	-	-	
		810	1909.8 (High)	8PSK	25.90	-	-	-	-	
PCS1900 (EGPRS12)	Endcap 1+B2	512	1850.2 (Low)	8PSK	22.00	-	-	-	-	
		661	1880.0 (Mid)	8PSK	21.90	-	-	-	-	
		810	1909.8 (High)	8PSK	21.70	-	-	-	-	



**11.7 Holster Left Side Touch**

Model	Mode	Accessory	Chan.	Freq (MHz)	Modulation Type	Conducted Power (dBm)	Power Drift (dB)	Measured 1g SAR (W/kg)	Limit (W/kg)	Results
7527C	GSM850 (GPRS8)	Endcap 1+B2	189	836.4 (Mid)	GMSK	31.45	-0.119	0.065	1.6	Pass
	PCS1900 (GPRS8)	Endcap 1+B2	661	1880.0 (Mid)	GMSK	28.78	-0.147	0.032	1.6	Pass

**11.8 Holster Right Side Touch**

Model	Mode	Accessory	Chan.	Freq (MHz)	Modulation Type	Conducted Power (dBm)	Power Drift (dB)	Measured 1g SAR (W/kg)	Limit (W/kg)	Results	
7527C	GSM850 (GPRS8)	Endcap 1+B2	189	836.4 (Mid)	GMSK	31.45	-0.03	0.359	1.6	Pass	
			128	824.2 (Low)	GMSK	29.95	0.123	0.31	1.6	Pass	
	GSM850 (GPRS10)	Endcap 1+B2	<b>189</b>	<b>836.4 (Mid)</b>	<b>GMSK</b>	<b>29.92</b>	<b>-0.151</b>	<b>0.456</b>	<b>1.6</b>	<b>Pass</b>	
			251	848.8 (High)	GMSK	29.85	-0.127	0.412	1.6	Pass	
			Endcap 1+B3	189	836.4 (Mid)	GMSK	31.45	-0.163	0.415	1.6	Pass
			Endcap 2+B2	189	836.4 (Mid)	GMSK	31.45	-0.129	0.35	1.6	Pass
		Endcap 5+B2	189	836.4 (Mid)	GMSK	31.45	-0.084	0.274	1.6	Pass	
		POD 1+B2	189	836.4 (Mid)	GMSK	31.45	-0.143	0.281	1.6	Pass	
		POD 2+B2	189	836.4 (Mid)	GMSK	31.45	-0.164	0.33	1.6	Pass	
		POD 3+B2	189	836.4 (Mid)	GMSK	31.45	-0.1	0.368	1.6	Pass	
		POD 4+B2	189	836.4 (Mid)	GMSK	31.45	-0.114	0.35	1.6	Pass	
		POD 6+B2	189	836.4 (Mid)	GMSK	31.45	-0.096	0.271	1.6	Pass	
	GSM850 (GPRS10) With BT On	Endcap 1+B2	189	836.4 (Mid)	GMSK	31.45	-0.161	0.374	1.6	Pass	
	GSM850 (GPRS12)	Endcap 1+B2	189	836.4 (Mid)	GMSK	27.60	-0.107	0.396	1.6	Pass	
	GSM850 (EGPRS8)	Endcap 1+B2	189	836.4 (Mid)	8PSK	27.30	-0.016	0.069	1.6	Pass	
	GSM850 (EGPRS10)	Endcap 1+B2	189	836.4 (Mid)	8PSK	27.30	-0.141	0.087	1.6	Pass	
	GSM850 (EGPRS12)	Endcap 1+B2	189	836.4 (Mid)	8PSK	23.10	-0.131	0.063	1.6	Pass	
	PCS1900 (GPRS8)	Endcap 1+B2	661	1880.0 (Mid)	GMSK	28.78	-0.142	0.103	1.6	Pass	
	PCS1900 (GPRS10)	Endcap 1+B2	512	1850.2 (Low)	GMSK	27.28	-0.167	0.197	1.6	Pass	
			661	1880.0 (Mid)	GMSK	27.02	-0.136	0.161	1.6	Pass	
			810	1909.8 (High)	GMSK	26.66	-0.112	0.093	1.6	Pass	
	PCS1900 (GPRS10) With BT On	Endcap 1+B2	512	1850.2 (Low)	GMSK	27.28	-0.118	0.215	1.6	Pass	
			Endcap 2+B2	512	1850.2 (Low)	GMSK	27.28	-0.124	0.168	1.6	Pass
		Endcap 5+B2	512	1850.2 (Low)	GMSK	27.28	-0.135	0.232	1.6	Pass	
			<b>661</b>	<b>1880.0 (Mid)</b>	<b>GMSK</b>	<b>27.02</b>	<b>-0.033</b>	<b>0.236</b>	<b>1.6</b>	<b>Pass</b>	
		810	1909.8 (High)	GMSK	26.66	-0.104	0.17	1.6	Pass		
		Endcap 5+B3	512	1850.2 (Low)	GMSK	27.28	-0.067	0.189	1.6	Pass	
		POD 1+B2	512	1850.2 (Low)	GMSK	27.28	-0.008	0.099	1.6	Pass	
		POD 2+B2	512	1850.2 (Low)	GMSK	27.28	-0.089	0.176	1.6	Pass	
		POD 3+B2	512	1850.2 (Low)	GMSK	27.28	-0.122	0.142	1.6	Pass	
		POD 4+B2	512	1850.2 (Low)	GMSK	27.28	-0.175	0.128	1.6	Pass	
	POD 6+B2	512	1850.2 (Low)	GMSK	27.28	-0.127	0.149	1.6	Pass		



	PCS1900 (GPRS12)	Endcap 1+B2	661	1880.0 (Mid)	GMSK	23.90	-0.122	0.128	1.6	Pass
	PCS1900 (EGPRS8)	Endcap 1+B2	661	1880.0 (Mid)	8PSK	26.00	-0.12	0.039	1.6	Pass
	PCS1900 (EGPRS10)	Endcap 1+B2	661	1880.0 (Mid)	8PSK	26.00	-0.148	0.05	1.6	Pass
	PCS1900 (EGPRS12)	Endcap 1+B2	661	1880.0 (Mid)	8PSK	21.90	-0.146	0.038	1.6	Pass
7527S	GSM850 (GPRS10)	Endcap 1+B2	<b>189</b>	<b>836.4 (Mid)</b>	<b>GMSK</b>	<b>29.92</b>	<b>-0.225</b>	<b>0.212</b>	<b>1.6</b>	<b>Pass</b>
	PCS1900 (GPRS10) With BT On	Endcap 5+B2	<b>661</b>	<b>1880.0 (Mid)</b>	<b>GMSK</b>	<b>27.02</b>	<b>-0.121</b>	<b>0.078</b>	<b>1.6</b>	<b>Pass</b>

Remark:

1. Only the worst case of 7527C will be re-tested on 7527S for verification.
2. The largest summation of GSM and WLAN for head SAR on 7527C is 1.362 W/Kg and on 7527S is 1.0635 W/Kg, and its position is left tilted.
3. The largest summation of GSM/GPRS and WLAN for body SAR on 7527C is 0.434 W/Kg and on 7527S is 0.503 W/Kg, and its position is keypad up with 1.5cm Gap.
4. The test data for WLAN can be referred to Appendix D.

Test Engineer : John Tsai and Neil Chen





## **12. References**

- [1] FCC 47 CFR Part 2 “Frequency Allocations and Radio Treaty Matters; General Rules and Regulations”
- [2] IEEE Std. P1528-2003, “Recommended Practice for Determining the Peak Spatial-Average Specific Absorption Rate (SAR) in the Human Head from Wireless Communications Devices: Measurement Techniques”, April 21, 2003
- [3] Supplement C (Edition 01-01) to OET Bulletin 65 (Edition 97-01), “Additional Information for Evaluating Compliance of Mobile and Portable Devices with FCC Limits for Human Exposure to RF Emissions”, June 2001
- [4] IEEE Std. C95.3-2002, “IEEE Recommended Practice for the Measurement of Potentially Hazardous Electromagnetic Fields-RF and Microwave”, 2002
- [5] IEEE Std. C95.1-1999, “IEEE Standard for Safety Levels with Respect to Human Exposure to Radio Frequency Electromagnetic Fields, 3 kHz to 300 GHz”, 1999
- [6] Robert J. Renka, “Multivariate Interpolation Of Large Sets Of Scattered Data”, University of North Texas ACM Transactions on Mathematical Software, vol. 14, no. 2, June 1988, pp. 139-148
- [7] DAYS4 System Handbook
- [8] RSS-102 Issued 2, “Radio Frequency Exposure Compliance of Radiocommunication Apparatus (All Frequency Bands)”, November 2005



### Appendix A - System Performance Check Data

Test Laboratory: Sporton International Inc. SAR Testing Lab

Date/Time: 2/4/2007 2:33:42 AM

System Check\_Head\_835MHz\_20070204

DUT: Dipole 835 MHz

Communication System: CW; Frequency: 835 MHz; Duty Cycle: 1:1

Medium: HSL\_850 Medium parameters used:  $f = 835 \text{ MHz}$ ;  $\sigma = 0.899 \text{ mho/m}$ ;  $\epsilon_r = 43.1$ ;  $\rho = 1000 \text{ kg/m}^3$

Ambient Temperature : 22.8 °C; Liquid Temperature : 20.9 °C

DASY4 Configuration:

- Probe: ET3DV6 - SN1788; ConvF(6.6, 6.6, 6.6); Calibrated: 9/19/2006

- Sensor-Surface: 4mm (Mechanical And Optical Surface Detection) Sensor-Surface: 4mm (Mechanical Surface Detection)

- Electronics: DAE3 Sn577; Calibrated: 11/21/2006

- Phantom: SAM-B; Type: QD 000 P40 C; Serial: TP-1383

- Measurement SW: DASY4, V4.7 Build 44; Postprocessing SW: SEMCAD, V1.8 Build 171

Pin=100mW/Area Scan (61x61x1): Measurement grid: dx=15mm, dy=15mm

Maximum value of SAR (interpolated) = 1.03 mW/g

Pin=100mW/Zoom Scan (7x7x7)/Cube 0: Measurement grid: dx=5mm, dy=5mm, dz=5mm

Reference Value = 35.1 V/m; Power Drift = -0.039 dB

Peak SAR (extrapolated) = 1.41 W/kg

SAR(1 g) = 0.951 mW/g; SAR(10 g) = 0.624 mW/g

Maximum value of SAR (measured) = 1.04 mW/g

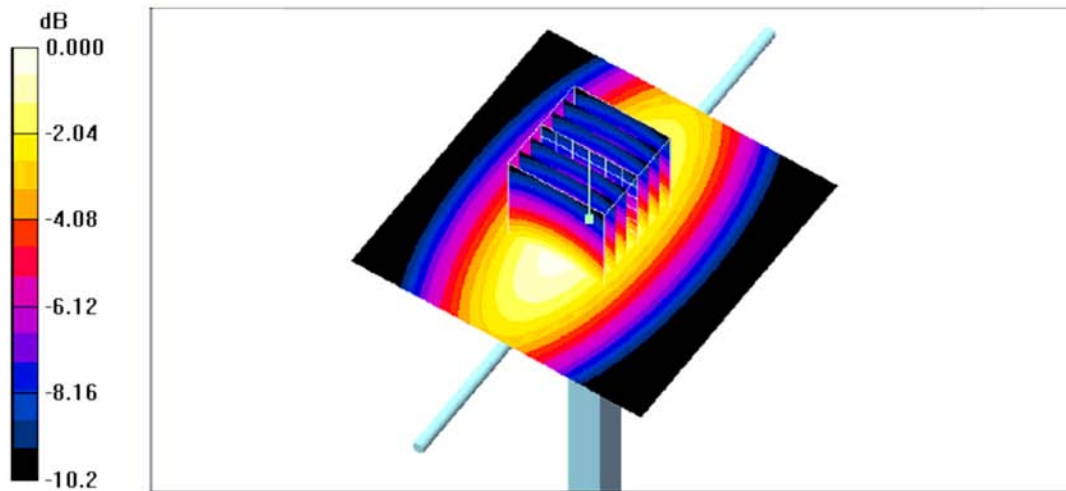

0 dB = 1.04mW/g



Test Laboratory: Sporton International Inc. SAR Testing Lab

Date/Time: 2/4/2007 3:14:24 AM

**System Check\_Head\_1900MHz\_20070204**

**DUT: Dipole 1900 MHz**

Communication System: CW; Frequency: 1900 MHz; Duty Cycle: 1:1

Medium: HSL\_1900 Medium parameters used:  $f = 1900$  MHz;  $\sigma = 1.46$  mho/m;  $\epsilon_r = 41.2$ ;  $\rho = 1000$  kg/m<sup>3</sup>

Ambient Temperature : 22.5 °C; Liquid Temperature : 20.3 °C

**DASY4 Configuration:**

- Probe: ET3DV6 - SN1788; ConvF(5.3, 5.3, 5.3); Calibrated: 9/19/2006

- Sensor-Surface: 4mm (Mechanical And Optical Surface Detection) Sensor-Surface: 4mm (Mechanical Surface Detection)

- Electronics: DAE3 Sn577; Calibrated: 11/21/2006

- Phantom: SAM-A; Type: QD 000 P40 C; Serial: TP-1303

- Measurement SW: DASY4, V4.7 Build 44; Postprocessing SW: SEMCAD, V1.8 Build 171

**Pin=100mW/Area Scan (91x91x1):** Measurement grid: dx=10mm, dy=10mm

Maximum value of SAR (interpolated) = 4.53 mW/g

**Pin=100mW/Zoom Scan (7x7x7)/Cube 0:** Measurement grid: dx=5mm, dy=5mm, dz=5mm

Reference Value = 58.7 V/m; Power Drift = 0.019 dB

Peak SAR (extrapolated) = 6.55 W/kg

SAR(1 g) = 3.92 mW/g; SAR(10 g) = 2.11 mW/g

Maximum value of SAR (measured) = 4.46 mW/g

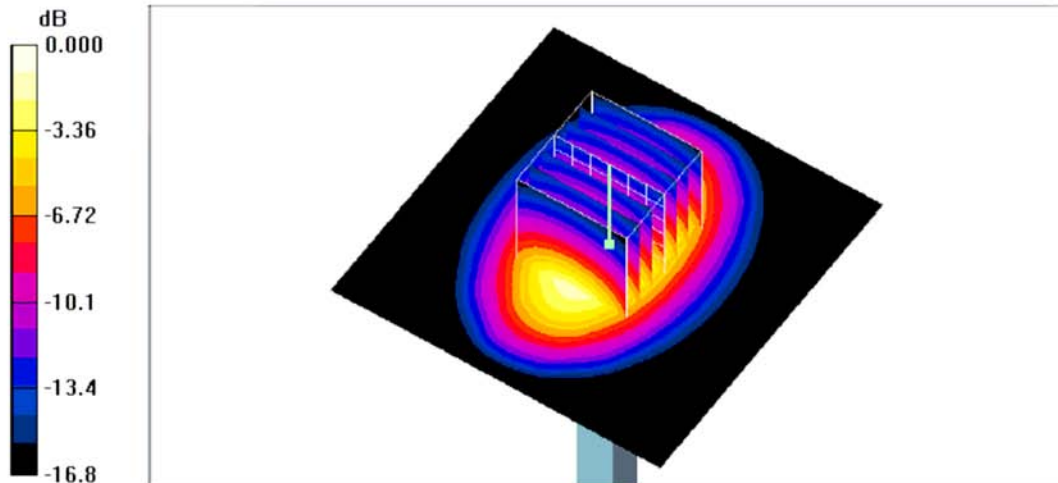

0 dB = 4.46mW/g



Test Laboratory: Sporton International Inc. SAR Testing Lab

Date/Time: 2/4/2007 4:00:39 AM

**System Check\_Body\_835MHz\_20070204**

**DUT: Dipole 835 MHz**

Communication System: CW; Frequency: 835 MHz; Duty Cycle: 1:1

Medium: MSL\_850 Medium parameters used:  $f = 835 \text{ MHz}$ ;  $\sigma = 0.97 \text{ mho/m}$ ;  $\epsilon_r = 56.2$ ;  $\rho = 1000 \text{ kg/m}^3$

Ambient Temperature : 21.1 °C; Liquid Temperature : 21.4 °C

DASY4 Configuration:

- Probe: ET3DV6 - SN1788; ConvF(6.33, 6.33, 6.33); Calibrated: 9/19/2006

- Sensor-Surface: 4mm (Mechanical And Optical Surface Detection) Sensor-Surface: 4mm (Mechanical Surface Detection)

- Electronics: DAE3 Sn577; Calibrated: 11/21/2006

- Phantom: SAM-B; Type: QD 000 P40 C; Serial: TP-1383

- Measurement SW: DASY4, V4.7 Build 44; Postprocessing SW: SEMCAD, V1.8 Build 171

**Pin=100mW/Area Scan (61x61x1):** Measurement grid: dx=15mm, dy=15mm

Maximum value of SAR (interpolated) = 1.03 mW/g

**Pin=100mW/Zoom Scan (7x7x7)/Cube 0:** Measurement grid: dx=5mm, dy=5mm, dz=5mm

Reference Value = 33.5 V/m; Power Drift = -0.025 dB

Peak SAR (extrapolated) = 1.36 W/kg

SAR(1 g) = 0.937 mW/g; SAR(10 g) = 0.617 mW/g

Maximum value of SAR (measured) = 1.02 mW/g

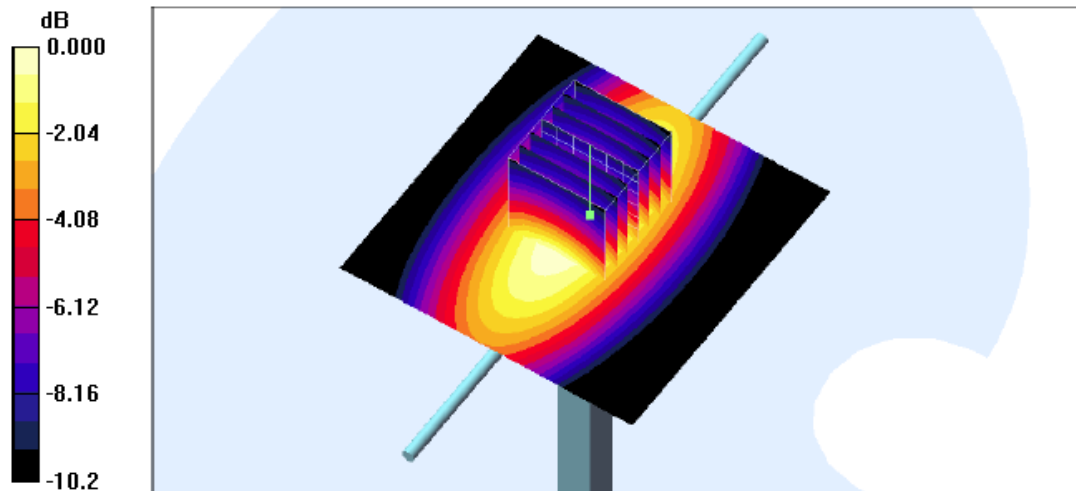

0 dB = 1.02mW/g



Test Laboratory: Sporton International Inc. SAR Testing Lab

Date/Time: 2/5/2007 8:08:24 AM

**System Check\_Body\_1900MHz\_20070205**

**DUT: Dipole 1900 MHz**

Communication System: CW; Frequency: 1900 MHz; Duty Cycle: 1:1

Medium: MSL\_1900 Medium parameters used:  $f = 1900$  MHz;  $\sigma = 1.55$  mho/m;  $\epsilon_r = 52.9$ ;  $\rho = 1000$  kg/m<sup>3</sup>

Ambient Temperature : 21.4 °C; Liquid Temperature : 20.9 °C

DASY4 Configuration:

- Probe: ET3DV6 - SN1788; ConvF(4.67, 4.67, 4.67); Calibrated: 9/19/2006

- Sensor-Surface: 4mm (Mechanical And Optical Surface Detection) Sensor-Surface: 4mm (Mechanical Surface Detection)

- Electronics: DAE3 Sn577; Calibrated: 11/21/2006

- Phantom: SAM-A; Type: QD 000 P40 C; Serial: TP-1303

- Measurement SW: DASY4, V4.7 Build 44; Postprocessing SW: SEMCAD, V1.8 Build 171

**Pin=100mW/Area Scan (91x91x1):** Measurement grid: dx=10mm, dy=10mm

Maximum value of SAR (interpolated) = 4.45 mW/g

**Pin=100mW/Zoom Scan (7x7x7)/Cube 0:** Measurement grid: dx=5mm, dy=5mm, dz=5mm

Reference Value = 57.8 V/m; Power Drift = -0.006 dB

Peak SAR (extrapolated) = 6.28 W/kg

SAR(1 g) = 3.88 mW/g; SAR(10 g) = 2.09 mW/g

Maximum value of SAR (measured) = 4.45 mW/g

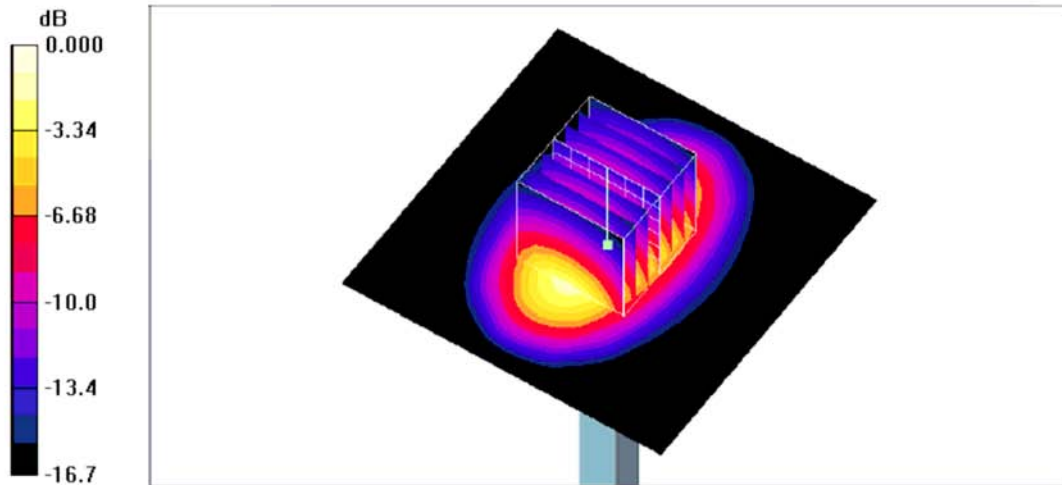

0 dB = 4.45mW/g



Test Laboratory: Sporton International Inc. SAR Testing Lab

Date: 5/1/2007

**System Check\_Head\_850MHz\_20070501**

**DUT: Dipole 835 MHz**

Communication System: CW; Frequency: 835 MHz; Duty Cycle: 1:1

Medium: HSL\_850 Medium parameters used:  $f = 835 \text{ MHz}$ ;  $\sigma = 0.889 \text{ mho/m}$ ;  $\epsilon_r = 43.1$ ;  $\rho = 1000 \text{ kg/m}^3$

Ambient Temperature : 22.6 °C ; Liquid Temperature : 21.6 °C

**DASY4 Configuration:**

- Probe: ET3DV6 - SN1788; ConvF(6.6, 6.6, 6.6); Calibrated: 9/19/2006
- Sensor-Surface: 4mm (Mechanical And Optical Surface Detection)Sensor-Surface: 4mm (Mechanical Surface Detection)
- Electronics: DAE3 Sn577; Calibrated: 11/21/2006
- Phantom: SAM-B; Type: QD 000 P40 C; Serial: TP-1383
- Measurement SW: DASY4, V4.7 Build 53; Postprocessing SW: SEMCAD, V1.8 Build 172

**Pin=100mW/Area Scan (61x61x1):** Measurement grid: dx=15mm, dy=15mm

Maximum value of SAR (interpolated) = 1.03 mW/g

**Pin=100mW/Zoom Scan (7x7x7)/Cube 0:** Measurement grid: dx=5mm, dy=5mm, dz=5mm

Reference Value = 35.6 V/m; Power Drift = -0.056 dB

Peak SAR (extrapolated) = 1.38 W/kg

SAR(1 g) = 0.937 mW/g; SAR(10 g) = 0.620 mW/g

Maximum value of SAR (measured) = 1.01 mW/g

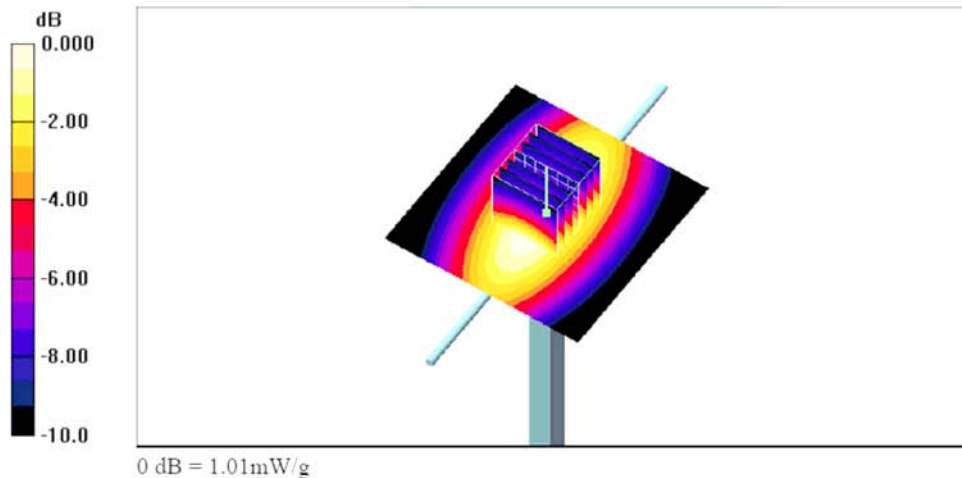



Test Laboratory: Sporton International Inc. SAR Testing Lab

Date: 2007/5/4

**System Check\_Head\_1900MHz\_20070504**

**DUT: Dipole 1900 MHz**

Communication System: CW; Frequency: 1900 MHz; Duty Cycle: 1:1

Medium: HSL\_1900 Medium parameters used:  $f = 1900$  MHz;  $\sigma = 1.41$  mho/m;  $\epsilon_r = 38.8$ ;  $\rho = 1000$  kg/m<sup>3</sup>

Ambient Temperature : 22.9 °C : Liquid Temperature : 21.0 °C

DASY4 Configuration:

- Probe: ET3DV6 - SN1787; ConvF(5.26, 5.26, 5.26); Calibrated: 2006/5/31
- Sensor-Surface: 4mm (Mechanical And Optical Surface Detection) Sensor-Surface: 4mm (Mechanical Surface Detection)
- Electronics: DAE3 Sn577; Calibrated: 2006/11/21
- Phantom: SAM-B; Type: QD 000 P40 C; Serial: TP-1383
- Measurement SW: DASY4, V4.7 Build 53; Postprocessing SW: SEMCAD, V1.8 Build 172

**Pin=100mW/Area Scan (91x91x1):** Measurement grid: dx=10mm, dy=10mm

Maximum value of SAR (interpolated) = 4.41 mW/g

**Pin=100mW/Zoom Scan (7x7x7)/Cube 0:** Measurement grid: dx=5mm, dy=5mm, dz=5mm

Reference Value = 59.0 V/m; Power Drift = 0.018 dB

Peak SAR (extrapolated) = 6.36 W/kg

SAR(1 g) = 3.82 mW/g; SAR(10 g) = 2.05 mW/g

Maximum value of SAR (measured) = 4.34 mW/g

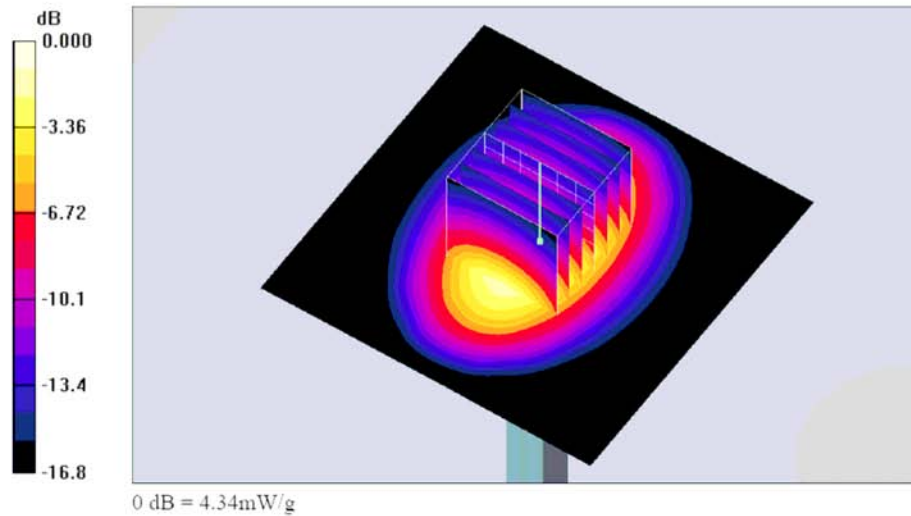



Test Laboratory: Sporton International Inc. SAR Testing Lab

Date: 5/5/2007

**System Check\_Body\_850MHz\_20070505**

**DUT: Dipole 835 MHz**

Communication System: CW; Frequency: 835 MHz; Duty Cycle: 1:1

Medium: MSL\_850 Medium parameters used:  $f = 835 \text{ MHz}$ ;  $\sigma = 0.967 \text{ mho/m}$ ;  $\epsilon_r = 54.2$ ;  $\rho = 1000 \text{ kg/m}^3$

Ambient Temperature :  $22.7 \text{ }^\circ\text{C}$ ; Liquid Temperature :  $21.3 \text{ }^\circ\text{C}$

**DASY4 Configuration:**

- Probe: ET3DV6 - SN1787; ConvF(6.18, 6.18, 6.18); Calibrated: 5/31/2006
- Sensor-Surface: 4mm (Mechanical And Optical Surface Detection) Sensor-Surface: 4mm (Mechanical Surface Detection)
- Electronics: DAE3 Sn577; Calibrated: 11/21/2006
- Phantom: SAM-A; Type: QD 000 P40 C; Serial: TP-1303
- Measurement SW: DASY4, V4.7 Build 53; Postprocessing SW: SEMCAD, V1.8 Build 172

**Pin=100mW/Area Scan (61x61x1):** Measurement grid:  $dx=15\text{mm}$ ,  $dy=15\text{mm}$

Maximum value of SAR (interpolated) =  $1.09 \text{ mW/g}$

**Pin=100mW/Zoom Scan (7x7x7)/Cube 0:** Measurement grid:  $dx=5\text{mm}$ ,  $dy=5\text{mm}$ ,  $dz=5\text{mm}$

Reference Value =  $34.6 \text{ V/m}$ ; Power Drift =  $-0.024 \text{ dB}$

Peak SAR (extrapolated) =  $1.46 \text{ W/kg}$

SAR(1 g) =  $1 \text{ mW/g}$ ; SAR(10 g) =  $0.659 \text{ mW/g}$

Maximum value of SAR (measured) =  $1.08 \text{ mW/g}$

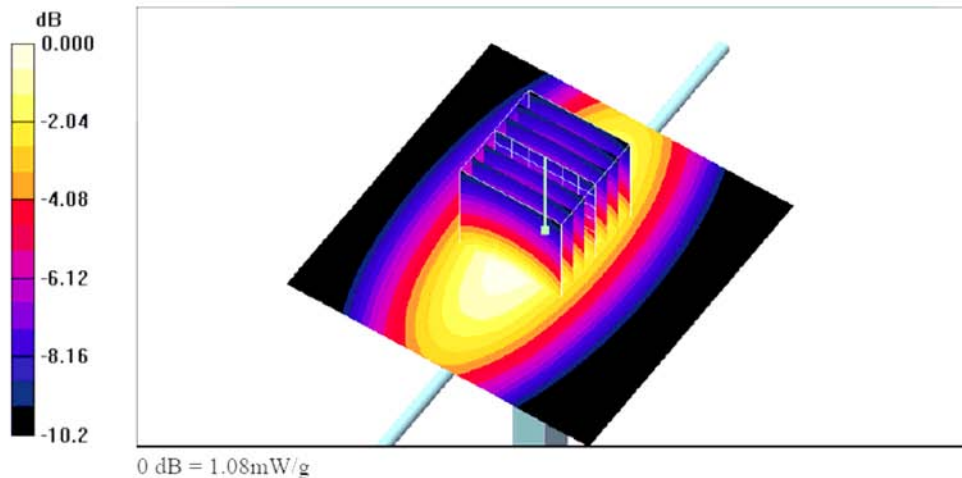





Test Laboratory: Sporton International Inc. SAR Testing Lab

Date: 5/6/2007

**System Check\_Body\_1900MHz\_20070506**

**DUT: Dipole 1900 MHz**

Communication System: CW; Frequency: 1900 MHz; Duty Cycle: 1:1

Medium: MSL\_1900 Medium parameters used:  $f = 1900$  MHz;  $\sigma = 1.55$  mho/m;  $\epsilon_r = 53$ ;  $\rho = 1000$  kg/m<sup>3</sup>

Ambient Temperature : 22.6 °C ; Liquid Temperature : 21.4 °C

DASY4 Configuration:

- Probe: ET3DV6 - SN1787; ConvF(4.66, 4.66, 4.66); Calibrated: 5/31/2006
- Sensor-Surface: 4mm (Mechanical And Optical Surface Detection) Sensor-Surface: 4mm (Mechanical Surface Detection)
- Electronics: DAE3 Sn577; Calibrated: 11/21/2006
- Phantom: SAM-B; Type: QD 000 P40 C; Serial: TP-1383
- Measurement SW: DASY4, V4.7 Build 53; Postprocessing SW: SEMCAD, V1.8 Build 172

**Pin=100mW/Area Scan (91x91x1):** Measurement grid: dx=10mm, dy=10mm

Maximum value of SAR (interpolated) = 4.84 mW/g

**Pin=100mW/Zoom Scan (7x7x7)/Cube 0:** Measurement grid: dx=5mm, dy=5mm, dz=5mm

Reference Value = 57.6 V/m; Power Drift = 0.018 dB

Peak SAR (extrapolated) = 7.06 W/kg

SAR(1 g) = 4.13 mW/g; SAR(10 g) = 2.18 mW/g

Maximum value of SAR (measured) = 4.73 mW/g

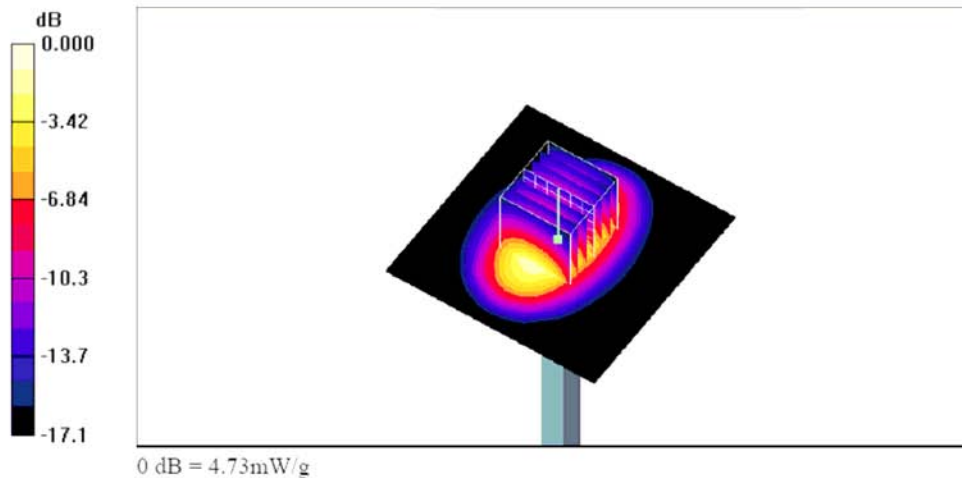



### Appendix B - SAR Measurement Data

Test Laboratory: Sporton International Inc. SAR Testing Lab

Date/Time: 2/4/2007 8:36:25 AM

Right Cheek\_GSM850 Ch189\_20070204\_PC528

DUT: 710211

Communication System: GSM850; Frequency: 836.4 MHz; Duty Cycle: 1:8.3

Medium: HSL\_850 Medium parameters used :  $f = 836.4$  MHz;  $\sigma = 0.9$  mho/m;  $\epsilon_r = 43.1$ ;  $\rho = 1000$  kg/m<sup>3</sup>

Ambient Temperature : 22.6 °C; Liquid Temperature : 20.9 °C

DASY4 Configuration:

- Probe: ET3DV6 - SN1788; ConvF(6.6, 6.6, 6.6); Calibrated: 9/19/2006

- Sensor-Surface: 4mm (Mechanical And Optical Surface Detection)

- Electronics: DAE3 Sn577; Calibrated: 11/21/2006

- Phantom: SAM-B; Type: QD 000 P40 C; Serial: TP-1383

- Measurement SW: DASY4, V4.7 Build 44; Postprocessing SW: SEMCAD, V1.8 Build 171

Ch189/Area Scan (71x181x1): Measurement grid: dx=15mm, dy=15mm

Maximum value of SAR (interpolated) = 0.516 mW/g

Ch189/Zoom Scan (5x5x7)/Cube 0: Measurement grid: dx=8mm, dy=8mm, dz=5mm

Reference Value = 24.3 V/m; Power Drift = -0.036 dB

Peak SAR (extrapolated) = 0.640 W/kg

SAR(1 g) = 0.491 mW/g; SAR(10 g) = 0.358 mW/g

Maximum value of SAR (measured) = 0.523 mW/g

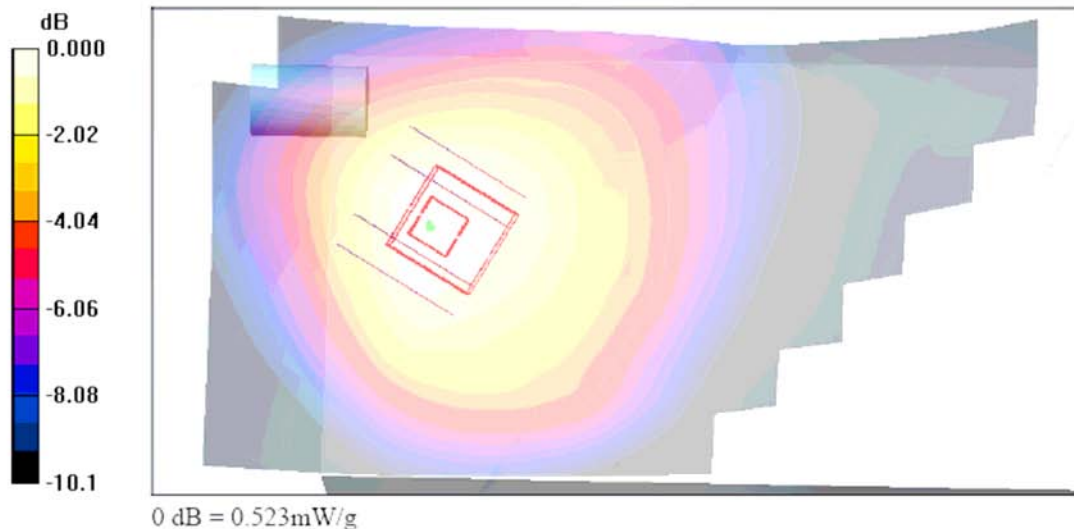



Test Laboratory: Sporton International Inc. SAR Testing Lab

Date/Time: 2/4/2007 8:56:03 AM

**Right Tilted\_GSM850 Ch189\_20070204\_PC528**

**DUT: 710211**

Communication System: GSM850; Frequency: 836.4 MHz; Duty Cycle: 1:8.3

Medium: HSL\_850 Medium parameters used :  $f = 836.4$  MHz;  $\sigma = 0.9$  mho/m;  $\epsilon_r = 43.1$ ;  $\rho = 1000$  kg/m<sup>3</sup>

Ambient Temperature : 22.8 °C; Liquid Temperature : 20.9 °C

DASY4 Configuration:

- Probe: ET3DV6 - SN1788; ConvF(6.6, 6.6, 6.6); Calibrated: 9/19/2006

- Sensor-Surface: 4mm (Mechanical And Optical Surface Detection)

- Electronics: DAE3 Sn577; Calibrated: 11/21/2006

- Phantom: SAM-B; Type: QD 000 P40 C; Serial: TP-1383

- Measurement SW: DASY4, V4.7 Build 44; Postprocessing SW: SEMCAD, V1.8 Build 171

**Ch189/Area Scan (71x181x1):** Measurement grid: dx=15mm, dy=15mm

Maximum value of SAR (interpolated) = 0.645 mW/g

**Ch189/Zoom Scan (5x5x7)/Cube 0:** Measurement grid: dx=8mm, dy=8mm, dz=5mm

Reference Value = 26.1 V/m; Power Drift = -0.020 dB

Peak SAR (extrapolated) = 0.810 W/kg

SAR(1 g) = 0.606 mW/g; SAR(10 g) = 0.425 mW/g

Maximum value of SAR (measured) = 0.653 mW/g

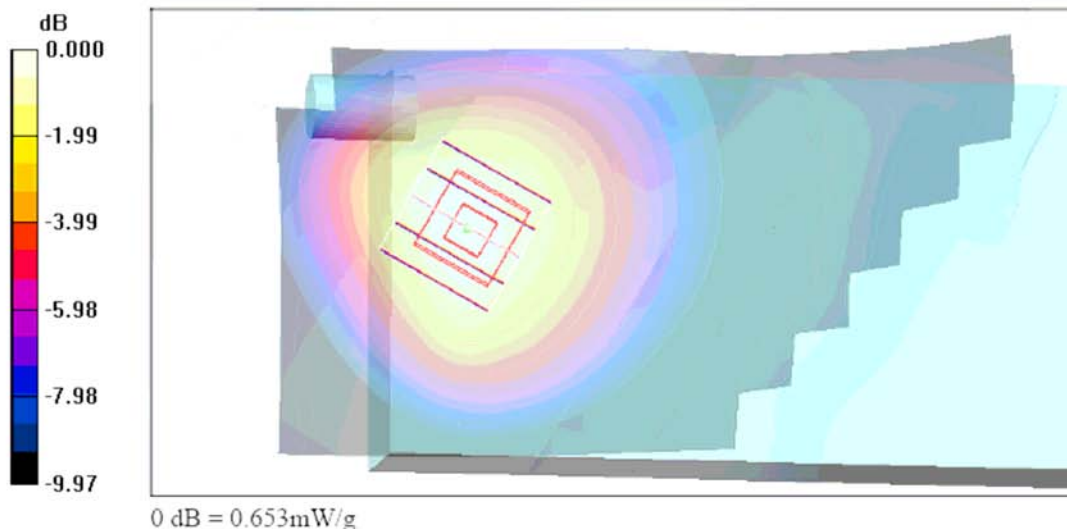



Test Laboratory: Sporton International Inc. SAR Testing Lab

Date/Time: 2/4/2007 9:16:35 AM

**Left Cheek\_GSM850 Ch189\_20070204\_PC528**

**DUT: 710211**

Communication System: GSM850; Frequency: 836.4 MHz; Duty Cycle: 1:8.3

Medium: HSL\_850 Medium parameters used :  $f = 836.4$  MHz;  $\sigma = 0.9$  mho/m;  $\epsilon_r = 43.1$ ;  $\rho = 1000$  kg/m<sup>3</sup>

Ambient Temperature : 22.4 °C; Liquid Temperature : 20.9 °C

DASY4 Configuration:

- Probe: ET3DV6 - SN1788; ConvF(6.6, 6.6, 6.6); Calibrated: 9/19/2006

- Sensor-Surface: 4mm (Mechanical And Optical Surface Detection)

- Electronics: DAE3 Sn577; Calibrated: 11/21/2006

- Phantom: SAM-B; Type: QD 000 P40 C; Serial: TP-1383

- Measurement SW: DASY4, V4.7 Build 44; Postprocessing SW: SEMCAD, V1.8 Build 171

**Ch189/Area Scan (71x181x1):** Measurement grid: dx=15mm, dy=15mm

Maximum value of SAR (interpolated) = 0.705 mW/g

**Ch189/Zoom Scan (5x5x7)/Cube 0:** Measurement grid: dx=8mm, dy=8mm, dz=5mm

Reference Value = 23.4 V/m; Power Drift = -0.121 dB

Peak SAR (extrapolated) = 0.929 W/kg

SAR(1 g) = 0.653 mW/g; SAR(10 g) = 0.448 mW/g

Maximum value of SAR (measured) = 0.706 mW/g

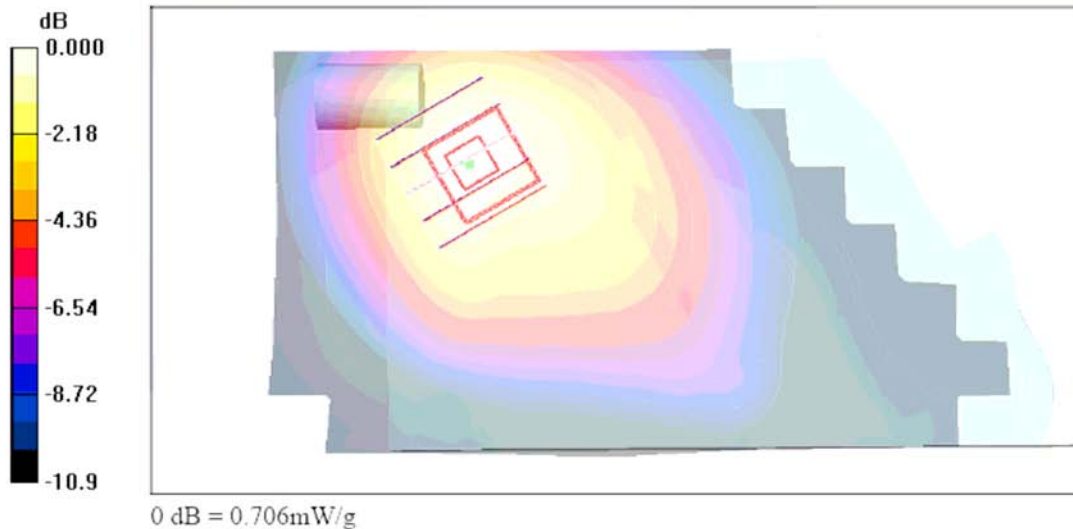



Test Laboratory: Sporton International Inc. SAR Testing Lab

Date/Time: 2/4/2007 10:19:06 AM

**Left Tilted\_GSM850 Ch251\_20070204\_PC528**

**DUT: 710211**

Communication System: GSM850; Frequency: 848.8 MHz; Duty Cycle: 1:8.3

Medium: HSL\_850 Medium parameters used:  $f = 849$  MHz;  $\sigma = 0.912$  mho/m;  $\epsilon_r = 42.9$ ;  $\rho = 1000$  kg/m<sup>3</sup>

Ambient Temperature : 22.1 °C; Liquid Temperature : 20.9 °C

DASY4 Configuration:

- Probe: ET3DV6 - SN1788; ConvF(6.6, 6.6, 6.6); Calibrated: 9/19/2006
- Sensor-Surface: 4mm (Mechanical And Optical Surface Detection)
- Electronics: DAE3 Sn577; Calibrated: 11/21/2006
- Phantom: SAM-B; Type: QD 000 P40 C; Serial: TP-1383
- Measurement SW: DASY4, V4.7 Build 44; Postprocessing SW: SEMCAD, V1.8 Build 171

**Ch251/Area Scan (71x181x1):** Measurement grid: dx=15mm, dy=15mm

Maximum value of SAR (interpolated) = 1.20 mW/g

**Ch251/Zoom Scan (5x5x7)/Cube 0:** Measurement grid: dx=8mm, dy=8mm, dz=5mm

Reference Value = 29.5 V/m; Power Drift = -0.019 dB

Peak SAR (extrapolated) = 1.56 W/kg

SAR(1 g) = 1.11 mW/g; SAR(10 g) = 0.748 mW/g

Maximum value of SAR (measured) = 1.19 mW/g

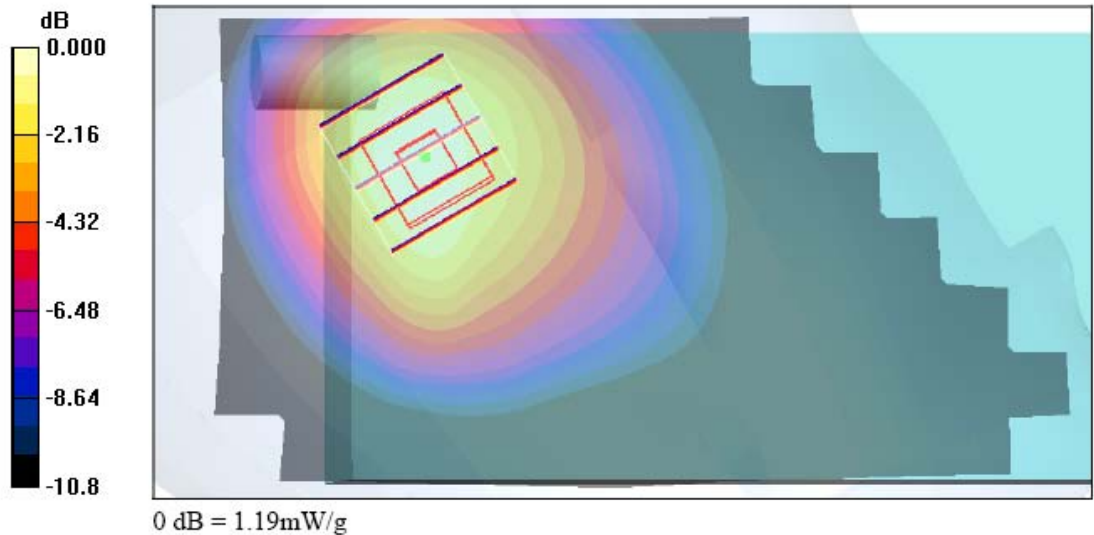



Test Laboratory: Sporton International Inc. SAR Testing Lab

Date: 2007/5/1

**Left Tilted\_GSM850 Ch251\_7527C\_Endcap 5\_B2**

Communication System: GSM850; Frequency: 848.8 MHz; Duty Cycle: 1:8.3

Medium: HSL\_850 Medium parameters used:  $f = 849$  MHz;  $\sigma = 0.902$  mho/m;  $\epsilon_r = 42.8$ ;  $\rho = 1000$  kg/m<sup>3</sup>

Ambient Temperature : 22.5 °C ; Liquid Temperature : 21.5 °C

DASY4 Configuration:

- Probe: ET3DV6 - SN1788; ConvF(6.6, 6.6, 6.6); Calibrated: 2006/9/19
- Sensor-Surface: 4mm (Mechanical Surface Detection)
- Electronics: DAE3 Sn577; Calibrated: 2006/11/21
- Phantom: SAM-A; Type: QD 000 P40 C; Serial: TP-1303
- Measurement SW: DASY4, V4.7 Build 53; Postprocessing SW: SEMCAD, V1.8 Build 172

**Ch251/Area Scan (81x161x1):** Measurement grid: dx=15mm, dy=15mm

Maximum value of SAR (interpolated) = 1.30 mW/g

**Ch251/Zoom Scan (5x5x7)/Cube 0:** Measurement grid: dx=8mm, dy=8mm, dz=5mm

Reference Value = 28.1 V/m; Power Drift = 0.004 dB

Peak SAR (extrapolated) = 1.68 W/kg

**SAR(1 g) = 1.22 mW/g; SAR(10 g) = 0.829 mW/g**

Maximum value of SAR (measured) = 1.30 mW/g

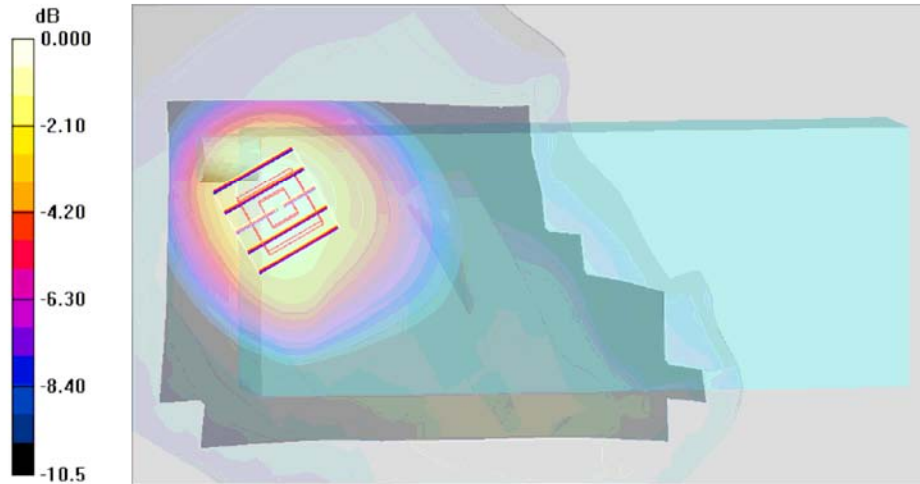

0 dB = 1.30mW/g



Test Laboratory: Sporton International Inc. SAR Testing Lab

Date: 2007/5/1

**Left Tilted\_GSM850 Ch251\_7527C\_POD 1\_B2**

Communication System: GSM850; Frequency: 848.8 MHz; Duty Cycle: 1:8.3

Medium: HSL\_850 Medium parameters used:  $f = 849$  MHz;  $\sigma = 0.902$  mho/m;  $\epsilon_r = 42.8$ ;  $\rho = 1000$  kg/m<sup>3</sup>

Ambient Temperature : 22.8 °C ; Liquid Temperature : 21.6 °C

DASY4 Configuration:

- Probe: ET3DV6 - SN1788; ConvF(6.6, 6.6, 6.6); Calibrated: 2006/9/19
- Sensor-Surface: 4mm (Mechanical Surface Detection)
- Electronics: DAE3 Sn577; Calibrated: 2006/11/21
- Phantom: SAM-B; Type: QD 000 P40 C; Serial: TP-1383
- Measurement SW: DASY4, V4.7 Build 53; Postprocessing SW: SEMCAD, V1.8 Build 172

**Ch251/Area Scan (81x181x1):** Measurement grid: dx=15mm, dy=15mm

Maximum value of SAR (interpolated) = 1.25 mW/g

**Ch251/Zoom Scan (5x5x7)/Cube 0:** Measurement grid: dx=8mm, dy=8mm, dz=5mm

Reference Value = 30.5 V/m; Power Drift = -0.107 dB

Peak SAR (extrapolated) = 1.61 W/kg

**SAR(1 g) = 1.15 mW/g; SAR(10 g) = 0.781 mW/g**

Maximum value of SAR (measured) = 1.22 mW/g

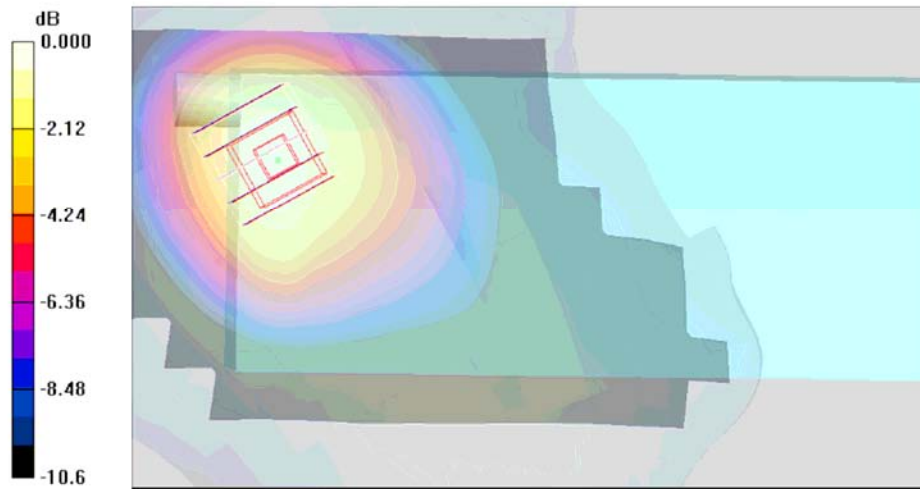

0 dB = 1.22mW/g



Test Laboratory: Sporton International Inc. SAR Testing Lab

Date: 2007/5/1

**Left Tilted\_GSM850 Ch251\_7527C\_POD 2\_B2**

Communication System: GSM850; Frequency: 848.8 MHz; Duty Cycle: 1:8.3

Medium: HSL\_850 Medium parameters used:  $f = 849$  MHz;  $\sigma = 0.902$  mho/m;  $\epsilon_r = 42.8$ ;  $\rho = 1000$  kg/m<sup>3</sup>

Ambient Temperature : 22.8 °C; Liquid Temperature : 21.6 °C

DASY4 Configuration:

- Probe: ET3DV6 - SN1788; ConvF(6.6, 6.6, 6.6); Calibrated: 2006/9/19
- Sensor-Surface: 4mm (Mechanical Surface Detection)
- Electronics: DAE3 Sn577; Calibrated: 2006/11/21
- Phantom: SAM-B; Type: QD 000 P40 C; Serial: TP-1383
- Measurement SW: DASY4, V4.7 Build 53; Postprocessing SW: SEMCAD, V1.8 Build 172

**Ch251/Area Scan (81x181x1):** Measurement grid: dx=15mm, dy=15mm

Maximum value of SAR (interpolated) = 1.36 mW/g

**Ch251/Zoom Scan (5x5x7)/Cube 0:** Measurement grid: dx=8mm, dy=8mm, dz=5mm

Reference Value = 30.3 V/m; Power Drift = -0.018 dB

Peak SAR (extrapolated) = 1.78 W/kg

**SAR(1 g) = 1.25 mW/g; SAR(10 g) = 0.853 mW/g**

Maximum value of SAR (measured) = 1.36 mW/g

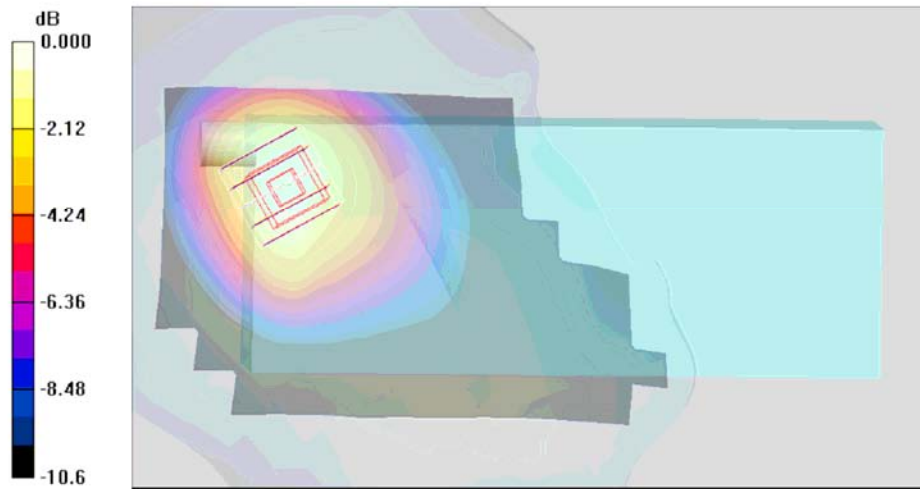

0 dB = 1.36mW/g





Test Laboratory: Sporton International Inc. SAR Testing Lab

Date: 2007/5/1

**Left Tilted\_GSM850 Ch251\_7527C\_POD 3\_B2**

Communication System: GSM850; Frequency: 848.8 MHz; Duty Cycle: 1:8.3

Medium: HSL\_850 Medium parameters used:  $f = 849$  MHz;  $\sigma = 0.902$  mho/m;  $\epsilon_r = 42.8$ ;  $\rho = 1000$  kg/m<sup>3</sup>

Ambient Temperature : 23.1 °C ; Liquid Temperature : 21.6 °C

DASY4 Configuration:

- Probe: ET3DV6 - SN1788; ConvF(6.6, 6.6, 6.6); Calibrated: 2006/9/19
- Sensor-Surface: 4mm (Mechanical Surface Detection)
- Electronics: DAE3 Sn577; Calibrated: 2006/11/21
- Phantom: SAM-B; Type: QD 000 P40 C; Serial: TP-1383
- Measurement SW: DASY4, V4.7 Build 53; Postprocessing SW: SEMCAD, V1.8 Build 172

**Ch251/Area Scan (81x181x1):** Measurement grid: dx=15mm, dy=15mm

Maximum value of SAR (interpolated) = 1.38 mW/g

**Ch251/Zoom Scan (5x5x7)/Cube 0:** Measurement grid: dx=8mm, dy=8mm, dz=5mm

Reference Value = 30.9 V/m; Power Drift = -0.176 dB

Peak SAR (extrapolated) = 1.81 W/kg

**SAR(1 g) = 1.3 mW/g; SAR(10 g) = 0.890 mW/g**

Maximum value of SAR (measured) = 1.39 mW/g

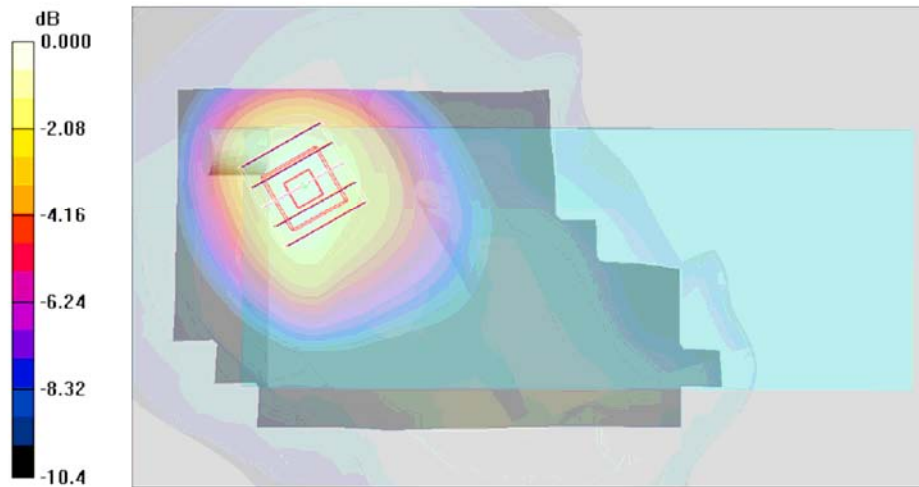

0 dB = 1.39mW/g



Test Laboratory: Sporton International Inc. SAR Testing Lab

Date: 2007/5/1

**Left Tilted\_GSM850 Ch251\_7527C\_POD 3\_B3**

Communication System: GSM850; Frequency: 848.8 MHz; Duty Cycle: 1:8.3

Medium: HSL\_850 Medium parameters used:  $f = 849$  MHz;  $\sigma = 0.902$  mho/m;  $\epsilon_r = 42.8$ ;  $\rho = 1000$  kg/m<sup>3</sup>

Ambient Temperature : 22.4 °C ; Liquid Temperature : 21.5 °C

DASY4 Configuration:

- Probe: ET3DV6 - SN1788; ConvF(6.6, 6.6, 6.6); Calibrated: 2006/9/19
- Sensor-Surface: 4mm (Mechanical Surface Detection)
- Electronics: DAE3 Sn577; Calibrated: 2006/11/21
- Phantom: SAM-A; Type: QD 000 P40 C; Serial: TP-1303
- Measurement SW: DASY4, V4.7 Build 53; Postprocessing SW: SEMCAD, V1.8 Build 172

**Ch251/Area Scan (81x161x1):** Measurement grid: dx=15mm, dy=15mm

Maximum value of SAR (interpolated) = 1.36 mW/g

**Ch251/Zoom Scan (5x5x7)/Cube 0:** Measurement grid: dx=8mm, dy=8mm, dz=5mm

Reference Value = 30.2 V/m; Power Drift = 0.029 dB

Peak SAR (extrapolated) = 1.69 W/kg

**SAR(1 g) = 1.24 mW/g; SAR(10 g) = 0.846 mW/g**

Maximum value of SAR (measured) = 1.33 mW/g

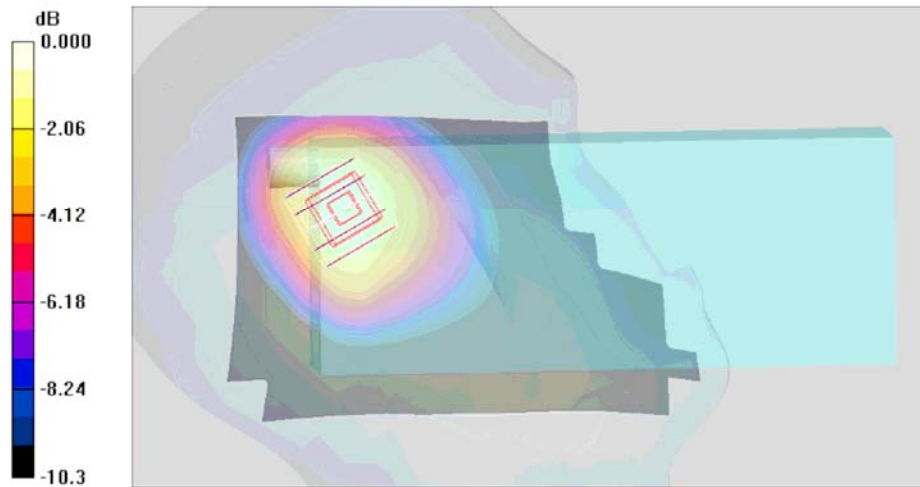

0 dB = 1.33mW/g



Test Laboratory: Sporton International Inc. SAR Testing Lab

Date: 2007/5/1

**Left Tilted\_GSM850 Ch251\_7527C\_POD 4\_B2**

Communication System: GSM850; Frequency: 848.8 MHz; Duty Cycle: 1:8.3

Medium: HSL\_850 Medium parameters used:  $f = 849$  MHz;  $\sigma = 0.902$  mho/m;  $\epsilon_r = 42.8$ ;  $\rho = 1000$  kg/m<sup>3</sup>

Ambient Temperature : 23.0 °C ; Liquid Temperature : 21.6 °C

DASY4 Configuration:

- Probe: ET3DV6 - SN1788; ConvF(6.6, 6.6, 6.6); Calibrated: 2006/9/19
- Sensor-Surface: 4mm (Mechanical Surface Detection)
- Electronics: DAE3 Sn577; Calibrated: 2006/11/21
- Phantom: SAM-B; Type: QD 000 P40 C; Serial: TP-1383
- Measurement SW: DASY4, V4.7 Build 53; Postprocessing SW: SEMCAD, V1.8 Build 172

**Ch251/Area Scan (81x181x1):** Measurement grid: dx=15mm, dy=15mm

Maximum value of SAR (interpolated) = 1.31 mW/g

**Ch251/Zoom Scan (5x5x7)/Cube 0:** Measurement grid: dx=8mm, dy=8mm, dz=5mm

Reference Value = 29.8 V/m; Power Drift = -0.094 dB

Peak SAR (extrapolated) = 1.72 W/kg

**SAR(1 g) = 1.21 mW/g; SAR(10 g) = 0.820 mW/g**

Maximum value of SAR (measured) = 1.31 mW/g

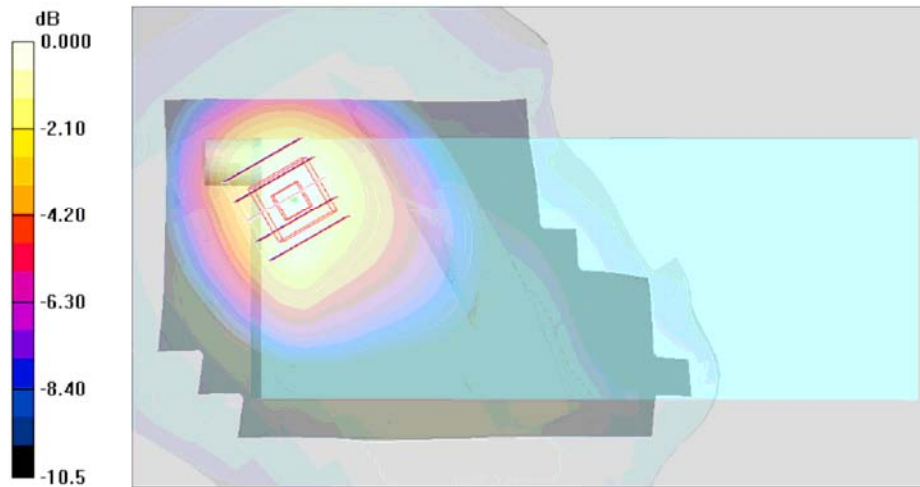



Test Laboratory: Sporton International Inc. SAR Testing Lab

Date: 2007/5/1

**Left Tilted\_GSM850 Ch251\_7527C\_POD 6\_B2**

Communication System: GSM850; Frequency: 848.8 MHz; Duty Cycle: 1:8.3

Medium: HSL\_850 Medium parameters used:  $f = 849$  MHz;  $\sigma = 0.902$  mho/m;  $\epsilon_r = 42.8$ ;  $\rho = 1000$  kg/m<sup>3</sup>

Ambient Temperature : 22.4 °C ; Liquid Temperature : 21.6 °C

DASY4 Configuration:

- Probe: ET3DV6 - SN1788; ConvF(6.6, 6.6, 6.6); Calibrated: 2006/9/19
- Sensor-Surface: 4mm (Mechanical Surface Detection)
- Electronics: DAE3 Sn577; Calibrated: 2006/11/21
- Phantom: SAM-B; Type: QD 000 P40 C; Serial: TP-1383
- Measurement SW: DASY4, V4.7 Build 53; Postprocessing SW: SEMCAD, V1.8 Build 172

**Ch251/Area Scan (81x181x1):** Measurement grid: dx=15mm, dy=15mm

Maximum value of SAR (interpolated) = 1.18 mW/g

**Ch251/Zoom Scan (5x5x7)/Cube 0:** Measurement grid: dx=8mm, dy=8mm, dz=5mm

Reference Value = 29.1 V/m; Power Drift = -0.089 dB

Peak SAR (extrapolated) = 1.62 W/kg

**SAR(1 g) = 1.14 mW/g; SAR(10 g) = 0.770 mW/g**

Maximum value of SAR (measured) = 1.23 mW/g

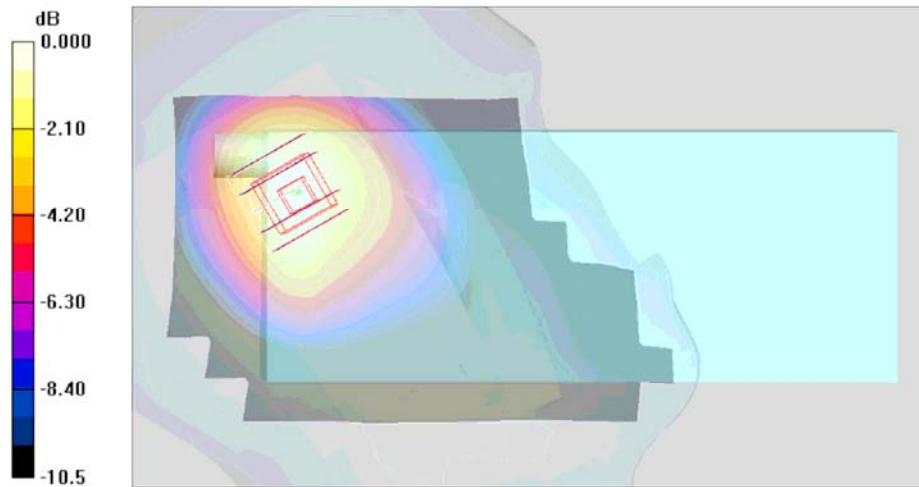



Test Laboratory: Sporton International Inc. SAR Testing Lab

Date: 2007/5/1

**Left Tilted\_GSM850 Ch251\_7527S\_POD 3\_B2**

Communication System: GSM850; Frequency: 848.8 MHz; Duty Cycle: 1:8.3

Medium: HSL\_850 Medium parameters used:  $f = 849$  MHz;  $\sigma = 0.902$  mho/m;  $\epsilon_r = 42.8$ ;  $\rho = 1000$  kg/m<sup>3</sup>

Ambient Temperature : 22.4 °C ; Liquid Temperature : 21.5 °C

DASY4 Configuration:

- Probe: ET3DV6 - SN1787; ConvF(6.38, 6.38, 6.38); Calibrated: 2006/5/31
- Sensor-Surface: 4mm (Mechanical Surface Detection)
- Electronics: DAE3 Sn577; Calibrated: 2006/11/21
- Phantom: SAM-B; Type: QD 000 P40 C; Serial: TP-1383
- Measurement SW: DASY4, V4.7 Build 53; Postprocessing SW: SEMCAD, V1.8 Build 172

**Ch251/Area Scan (81x161x1):** Measurement grid: dx=15mm, dy=15mm

Maximum value of SAR (interpolated) = 1.08 mW/g

**Ch251/Zoom Scan (5x5x7)/Cube 0:** Measurement grid: dx=8mm, dy=8mm, dz=5mm

Reference Value = 27.4 V/m; Power Drift = -0.132 dB

Peak SAR (extrapolated) = 1.43 W/kg

**SAR(1 g) = 1.01 mW/g; SAR(10 g) = 0.682 mW/g**

Maximum value of SAR (measured) = 1.09 mW/g

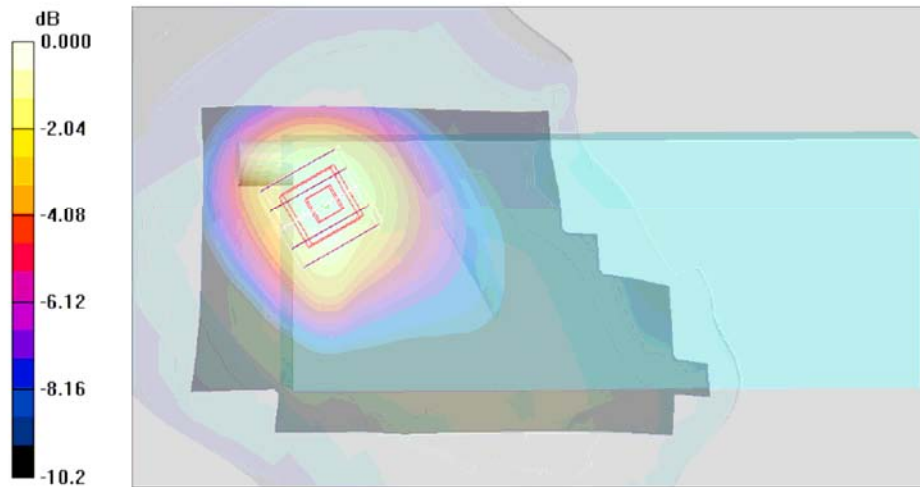



Test Laboratory: Sporton International Inc. SAR Testing Lab

Date/Time: 2/4/2007 11:55:05 AM

**Right Cheek\_PCS Ch661\_20070204\_PC528**

**DUT: 710211**

Communication System: PCS; Frequency: 1880 MHz; Duty Cycle: 1:8.3

Medium: HSL\_1900 Medium parameters used:  $f = 1880$  MHz;  $\sigma = 1.45$  mho/m;  $\epsilon_r = 41.5$ ;  $\rho = 1000$  kg/m<sup>3</sup>

Ambient Temperature : 22.6 °C; Liquid Temperature : 20.3 °C

DASY4 Configuration:

- Probe: ET3DV6 - SN1788; ConvF(5.3, 5.3, 5.3); Calibrated: 9/19/2006
- Sensor-Surface: 4mm (Mechanical And Optical Surface Detection)
- Electronics: DAE3 Sn577; Calibrated: 11/21/2006
- Phantom: SAM-A; Type: QD 000 P40 C; Serial: TP-1303
- Measurement SW: DASY4, V4.7 Build 44; Postprocessing SW: SEMCAD, V1.8 Build 171

**Ch661/Area Scan (71x181x1):** Measurement grid: dx=15mm, dy=15mm

Maximum value of SAR (interpolated) = 0.356 mW/g

**Ch661/Zoom Scan (5x5x7)/Cube 0:** Measurement grid: dx=8mm, dy=8mm, dz=5mm

Reference Value = 16.7 V/m; Power Drift = 0.028 dB

Peak SAR (extrapolated) = 0.517 W/kg

SAR(1 g) = 0.338 mW/g; SAR(10 g) = 0.210 mW/g

Maximum value of SAR (measured) = 0.367 mW/g

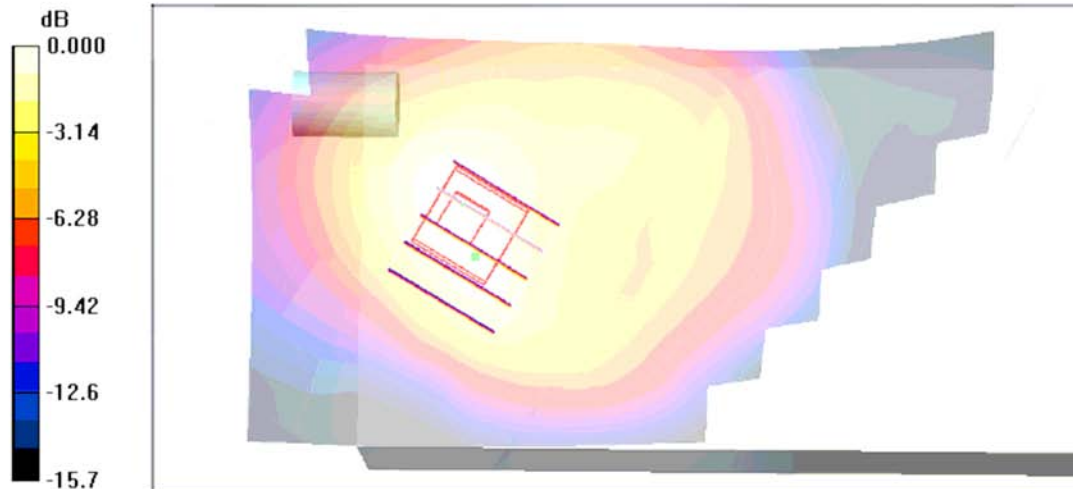



Test Laboratory: Sporton International Inc. SAR Testing Lab

Date/Time: 2/4/2007 12:16:10 PM

**Right Tilted\_PCS Ch661\_20070204\_PC528**

**DUT: 710211**

Communication System: PCS; Frequency: 1880 MHz; Duty Cycle: 1:8.3

Medium: HSL\_1900 Medium parameters used:  $f = 1880$  MHz;  $\sigma = 1.45$  mho/m;  $\epsilon_r = 41.5$ ;  $\rho = 1000$  kg/m<sup>3</sup>

Ambient Temperature : 22.6 °C ; Liquid Temperature : 20.3 °C

DASY4 Configuration:

- Probe: ET3DV6 - SN1788; ConvF(5.3, 5.3, 5.3); Calibrated: 9/19/2006
- Sensor-Surface: 4mm (Mechanical And Optical Surface Detection)
- Electronics: DAE3 Sn577; Calibrated: 11/21/2006
- Phantom: SAM-A; Type: QD 000 P40 C; Serial: TP-1303
- Measurement SW: DASY4, V4.7 Build 44; Postprocessing SW: SEMCAD, V1.8 Build 171

**Ch661/Area Scan (71x181x1):** Measurement grid: dx=15mm, dy=15mm

Maximum value of SAR (interpolated) = 0.422 mW/g

**Ch661/Zoom Scan (5x5x7)/Cube 0:** Measurement grid: dx=8mm, dy=8mm, dz=5mm

Reference Value = 17.7 V/m; Power Drift = -0.020 dB

Peak SAR (extrapolated) = 0.622 W/kg

SAR(1 g) = 0.393 mW/g; SAR(10 g) = 0.238 mW/g

Maximum value of SAR (measured) = 0.434 mW/g

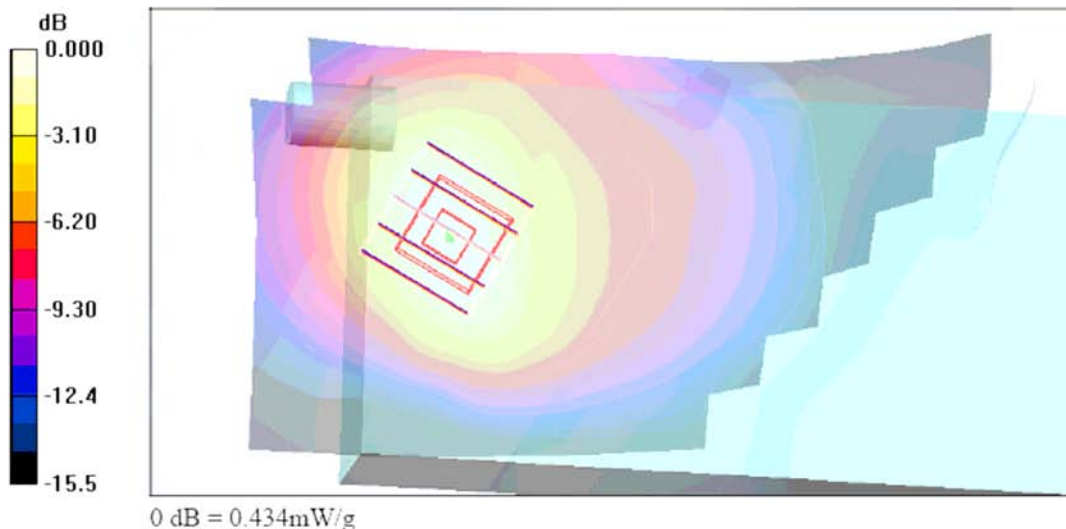



Test Laboratory: Sporton International Inc. SAR Testing Lab

Date/Time: 2/4/2007 12:46:24 PM

**Left Cheek\_PCS Ch661\_20070204\_PC528**

**DUT: 710211**

Communication System: PCS; Frequency: 1880 MHz; Duty Cycle: 1:8.3

Medium: HSL\_1900 Medium parameters used:  $f = 1880$  MHz;  $\sigma = 1.45$  mho/m;  $\epsilon_r = 41.5$ ;  $\rho = 1000$  kg/m<sup>3</sup>

Ambient Temperature : 22.6 °C; Liquid Temperature : 20.3 °C

DASY4 Configuration:

- Probe: ET3DV6 - SN1788; ConvF(5.3, 5.3, 5.3); Calibrated: 9/19/2006

- Sensor-Surface: 4mm (Mechanical And Optical Surface Detection)

- Electronics: DAE3 Sn577; Calibrated: 11/21/2006

- Phantom: SAM-A; Type: QD 000 P40 C; Serial: TP-1303

- Measurement SW: DASY4, V4.7 Build 44; Postprocessing SW: SEMCAD, V1.8 Build 171

**Ch661/Area Scan (71x181x1):** Measurement grid: dx=15mm, dy=15mm

Maximum value of SAR (interpolated) = 0.478 mW/g

**Ch661/Zoom Scan (5x5x7)/Cube 0:** Measurement grid: dx=8mm, dy=8mm, dz=5mm

Reference Value = 14.5 V/m; Power Drift = 0.001 dB

Peak SAR (extrapolated) = 0.747 W/kg

SAR(1 g) = 0.447 mW/g; SAR(10 g) = 0.264 mW/g

Maximum value of SAR (measured) = 0.489 mW/g

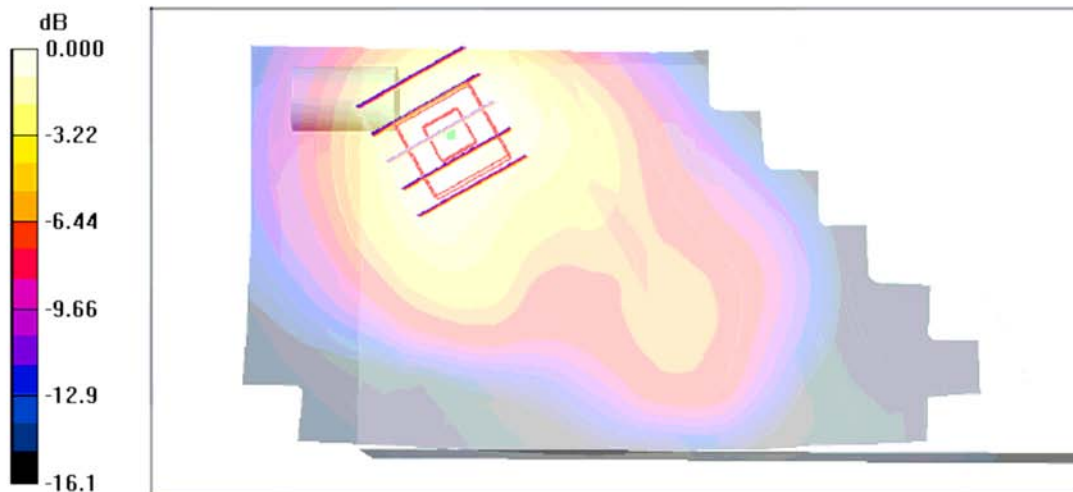





Test Laboratory: Sporton International Inc. SAR Testing Lab

Date/Time: 2/4/2007 1:28:38 PM

**Left Tilted\_PCS Ch512\_20070204\_PC528**

**DUT: 710211**

Communication System: PCS; Frequency: 1850.2 MHz; Duty Cycle: 1:8.3

Medium: HSL\_1900 Medium parameters used :  $f = 1850.2$  MHz;  $\sigma = 1.43$  mho/m;  $\epsilon_r = 41.6$ ;  $\rho = 1000$  kg/m<sup>3</sup>

Ambient Temperature : 20.5 °C; Liquid Temperature : 20.3 °C

DASY4 Configuration:

- Probe: ET3DV6 - SN1788; ConvF(5.3, 5.3, 5.3); Calibrated: 9/19/2006

- Sensor-Surface: 4mm (Mechanical And Optical Surface Detection)

- Electronics: DAE3 Sn577; Calibrated: 11/21/2006

- Phantom: SAM-A; Type: QD 000 P40 C; Serial: TP-1303

- Measurement SW: DASY4, V4.7 Build 44; Postprocessing SW: SEMCAD, V1.8 Build 171

**Ch512/Area Scan (71x181x1):** Measurement grid: dx=15mm, dy=15mm

Maximum value of SAR (interpolated) = 0.607 mW/g

**Ch512/Zoom Scan (5x5x7)/Cube 0:** Measurement grid: dx=8mm, dy=8mm, dz=5mm

Reference Value = 18.1 V/m; Power Drift = -0.009 dB

Peak SAR (extrapolated) = 0.898 W/kg

SAR(1 g) = 0.544 mW/g; SAR(10 g) = 0.318 mW/g

Maximum value of SAR (measured) = 0.598 mW/g

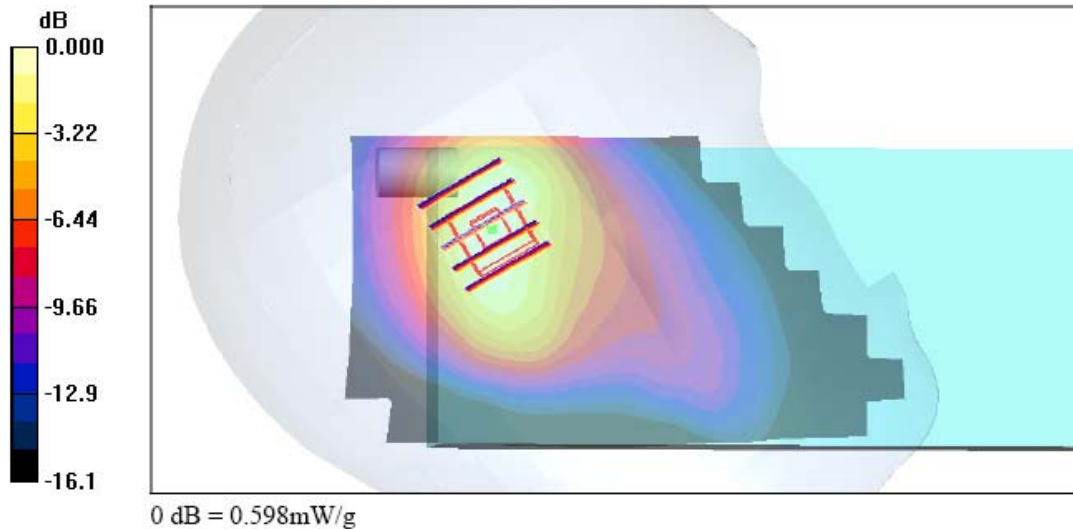



Test Laboratory: Sporton International Inc. SAR Testing Lab

Date: 2007/5/4

**Left Tilted\_PCS Ch512\_7527C\_Endcap 2\_B2**

Communication System: PCS; Frequency: 1850.2 MHz; Duty Cycle: 1:8.3

Medium: HSL\_1900 Medium parameters used :  $f = 1850.2$  MHz;  $\sigma = 1.37$  mho/m;  $\epsilon_r = 38.9$ ;  $\rho = 1000$  kg/m<sup>3</sup>

Ambient Temperature : 22.6 °C; Liquid Temperature : 21.0 °C

DASY4 Configuration:

- Probe: ET3DV6 - SN1787; ConvF(5.26, 5.26, 5.26); Calibrated: 2006/5/31
- Sensor-Surface: 4mm (Mechanical Surface Detection)
- Electronics: DAE3 Sn577; Calibrated: 2006/11/21
- Phantom: SAM-B; Type: QD 000 P40 C; Serial: TP-1383
- Measurement SW: DASY4, V4.7 Build 53; Postprocessing SW: SEMCAD, V1.8 Build 172

**Ch512/Area Scan (81x181x1):** Measurement grid: dx=15mm, dy=15mm

Maximum value of SAR (interpolated) = 0.441 mW/g

**Ch512/Zoom Scan (5x5x7)/Cube 0:** Measurement grid: dx=8mm, dy=8mm, dz=5mm

Reference Value = 16.8 V/m; Power Drift = 0.157 dB

Peak SAR (extrapolated) = 0.620 W/kg

**SAR(1 g) = 0.396 mW/g; SAR(10 g) = 0.243 mW/g**

Maximum value of SAR (measured) = 0.431 mW/g

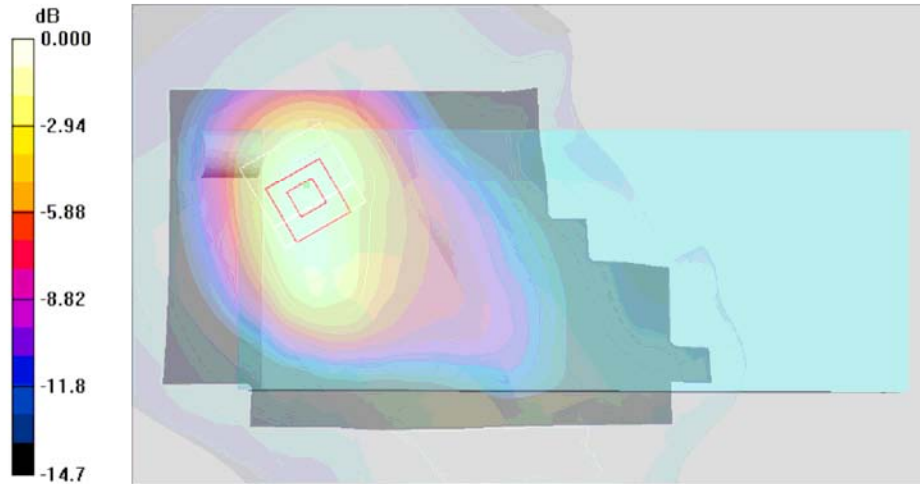

0 dB = 0.431mW/g



Test Laboratory: Sporton International Inc. SAR Testing Lab

Date: 2007/5/4

**Left Tilted\_PCS Ch512\_7527C\_Endcap 5\_B2**

Communication System: PCS; Frequency: 1850.2 MHz; Duty Cycle: 1:8.3

Medium: HSL\_1900 Medium parameters used:  $f = 1850.2 \text{ MHz}$ ;  $\sigma = 1.37 \text{ mho/m}$ ;  $\epsilon_r = 38.9$ ;  $\rho = 1000 \text{ kg/m}^3$

Ambient Temperature : 22.6 °C ; Liquid Temperature : 21.1 °C

DASY4 Configuration:

- Probe: ET3DV6 - SN1788; ConvF(5.3, 5.3, 5.3); Calibrated: 2006/9/19
- Sensor-Surface: 4mm (Mechanical Surface Detection)
- Electronics: DAE3 Sn577; Calibrated: 2006/11/21
- Phantom: SAM-B; Type: QD 000 P40 C; Serial: TP-1383
- Measurement SW: DASY4, V4.7 Build 53; Postprocessing SW: SEMCAD, V1.8 Build 172

**Ch512/Area Scan (81x181x1):** Measurement grid: dx=15mm, dy=15mm  
Maximum value of SAR (interpolated) = 0.401 mW/g

**Ch512/Zoom Scan (5x5x7)/Cube 0:** Measurement grid: dx=8mm, dy=8mm, dz=5mm  
Reference Value = 14.5 V/m; Power Drift = -0.167 dB  
Peak SAR (extrapolated) = 0.544 W/kg  
**SAR(1 g) = 0.360 mW/g; SAR(10 g) = 0.222 mW/g**  
Maximum value of SAR (measured) = 0.392 mW/g

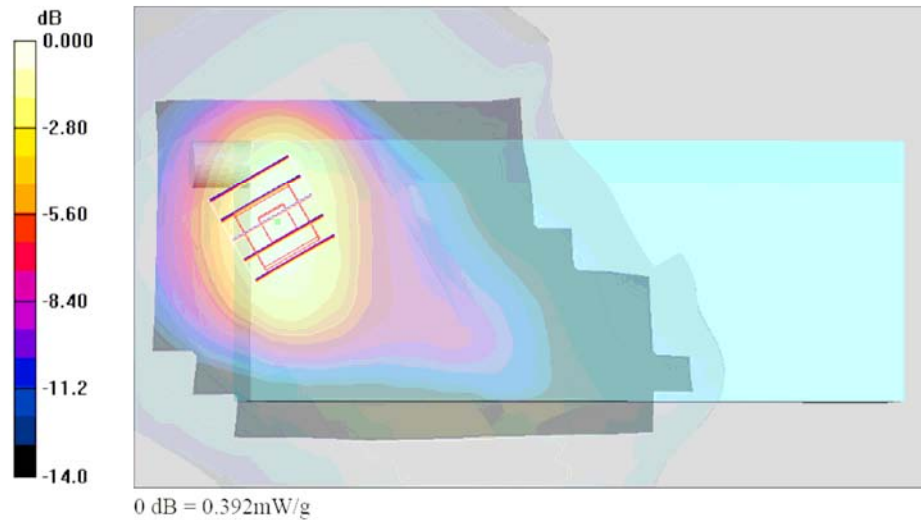



Test Laboratory: Sporton International Inc. SAR Testing Lab

Date: 2007/5/4

**Left Tilted\_PCS Ch512\_7527C\_POD 1\_B2**

Communication System: PCS; Frequency: 1850.2 MHz; Duty Cycle: 1:8.3

Medium: HSL\_1900 Medium parameters used:  $f = 1850.2 \text{ MHz}$ ;  $\sigma = 1.37 \text{ mho/m}$ ;  $\epsilon_r = 38.9$ ;  $\rho = 1000 \text{ kg/m}^3$

Ambient Temperature : 22.9 °C ; Liquid Temperature : 21.0 °C

DASY4 Configuration:

- Probe: ET3DV6 - SN1787; ConvF(5.26, 5.26, 5.26); Calibrated: 2006/5/31
- Sensor-Surface: 4mm (Mechanical Surface Detection)
- Electronics: DAE3 Sn577; Calibrated: 2006/11/21
- Phantom: SAM-B; Type: QD 000 P40 C; Serial: TP-1383
- Measurement SW: DASY4, V4.7 Build 53; Postprocessing SW: SEMCAD, V1.8 Build 172

**Ch512/Area Scan (81x181x1):** Measurement grid: dx=15mm, dy=15mm

Maximum value of SAR (interpolated) = 0.505 mW/g

**Ch512/Zoom Scan (5x5x7)/Cube 0:** Measurement grid: dx=8mm, dy=8mm, dz=5mm

Reference Value = 17.3 V/m; Power Drift = 0.123 dB

Peak SAR (extrapolated) = 0.677 W/kg

**SAR(1 g) = 0.441 mW/g; SAR(10 g) = 0.274 mW/g**

Maximum value of SAR (measured) = 0.482 mW/g

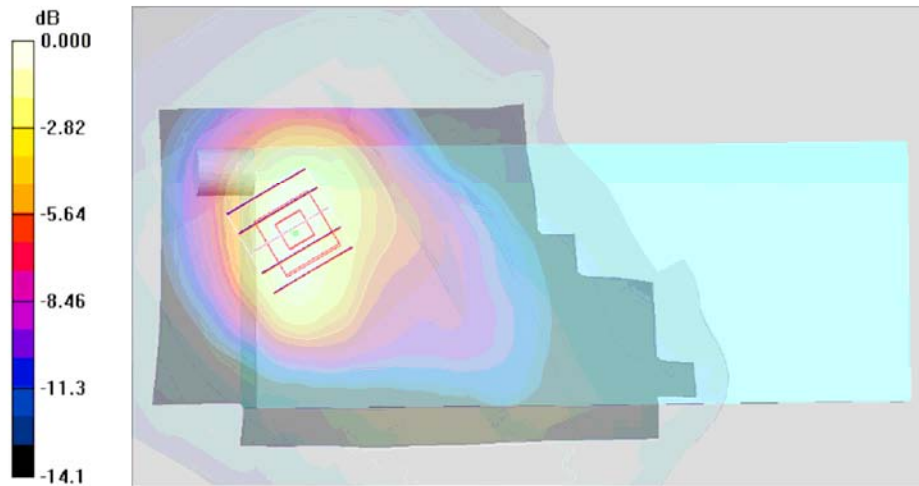

0 dB = 0.482mW/g



Test Laboratory: Sporton International Inc. SAR Testing Lab

Date: 2007/5/4

**Left Tilted\_PCS Ch512\_7527C\_POD 2\_B2**

Communication System: PCS; Frequency: 1850.2 MHz; Duty Cycle: 1:8.3

Medium: HSL\_1900 Medium parameters used:  $f = 1850.2$  MHz;  $\sigma = 1.37$  mho/m;  $\epsilon_r = 38.9$ ;  $\rho = 1000$  kg/m<sup>3</sup>

Ambient Temperature : 22.9 °C; Liquid Temperature : 21.0 °C

DASY4 Configuration:

- Probe: ET3DV6 - SN1787; ConvF(5.26, 5.26, 5.26); Calibrated: 2006/5/31
- Sensor-Surface: 4mm (Mechanical Surface Detection)
- Electronics: DAE3 Sn577; Calibrated: 2006/11/21
- Phantom: SAM-B; Type: QD 000 P40 C; Serial: TP-1383
- Measurement SW: DASY4, V4.7 Build 53; Postprocessing SW: SEMCAD, V1.8 Build 172

**Ch512/Area Scan (81x181x1):** Measurement grid: dx=15mm, dy=15mm

Maximum value of SAR (interpolated) = 0.498 mW/g

**Ch512/Zoom Scan (5x5x7)/Cube 0:** Measurement grid: dx=8mm, dy=8mm, dz=5mm

Reference Value = 17.8 V/m; Power Drift = -0.048 dB

Peak SAR (extrapolated) = 0.685 W/kg

**SAR(1 g) = 0.447 mW/g; SAR(10 g) = 0.275 mW/g**

Maximum value of SAR (measured) = 0.496 mW/g

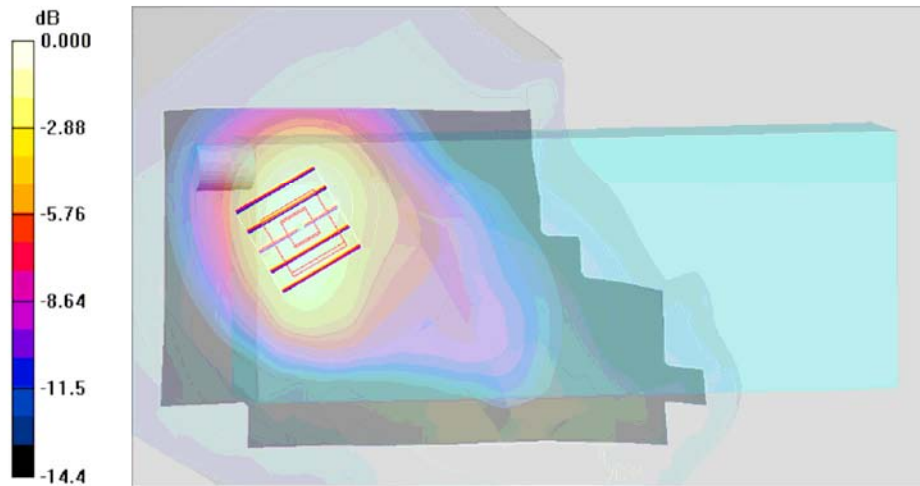

0 dB = 0.496mW/g



Test Laboratory: Sporton International Inc. SAR Testing Lab

Date: 2007/5/4

**Left Tilted\_PCS Ch512\_7527C\_POD 3\_B2**

Communication System: PCS; Frequency: 1850.2 MHz; Duty Cycle: 1:8.3  
Medium: HSL\_1900 Medium parameters used:  $f = 1850.2 \text{ MHz}$ ;  $\sigma = 1.37 \text{ mho/m}$ ;  $\epsilon_r = 38.9$ ;  $\rho = 1000 \text{ kg/m}^3$   
Ambient Temperature : 22.9 °C; Liquid Temperature : 21.0 °C

DASY4 Configuration:

- Probe: ET3DV6 - SN1787; ConvF(5.26, 5.26, 5.26); Calibrated: 2006/5/31
- Sensor-Surface: 4mm (Mechanical Surface Detection)
- Electronics: DAE3 Sn577; Calibrated: 2006/11/21
- Phantom: SAM-B; Type: QD 000 P40 C; Serial: TP-1383
- Measurement SW: DASY4, V4.7 Build 53; Postprocessing SW: SEMCAD, V1.8 Build 172

**Ch512/Area Scan (81x181x1):** Measurement grid: dx=15mm, dy=15mm  
Maximum value of SAR (interpolated) = 0.503 mW/g

**Ch512/Zoom Scan (5x5x7)/Cube 0:** Measurement grid: dx=8mm, dy=8mm, dz=5mm  
Reference Value = 18.1 V/m; Power Drift = -0.138 dB  
Peak SAR (extrapolated) = 0.700 W/kg  
**SAR(1 g) = 0.460 mW/g; SAR(10 g) = 0.284 mW/g**  
Maximum value of SAR (measured) = 0.499 mW/g

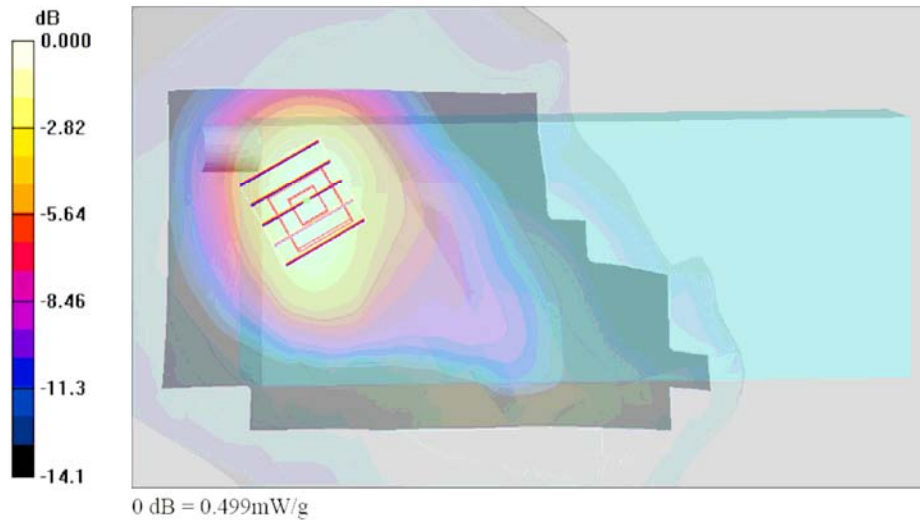



Test Laboratory: Sporton International Inc. SAR Testing Lab

Date: 2007/5/4

**Left Tilted\_PCS Ch512\_7527C\_POD 3\_B3**

Communication System: PCS; Frequency: 1850.2 MHz; Duty Cycle: 1:8.3

Medium: HSL\_1900 Medium parameters used:  $f = 1850.2 \text{ MHz}$ ;  $\sigma = 1.37 \text{ mho/m}$ ;  $\epsilon_r = 38.9$ ;  $\rho = 1000 \text{ kg/m}^3$

Ambient Temperature : 22.6 °C; Liquid Temperature : 21.1 °C

DASY4 Configuration:

- Probe: ET3DV6 - SN1788; ConvF(5.3, 5.3, 5.3); Calibrated: 2006/9/19
- Sensor-Surface: 4mm (Mechanical Surface Detection)
- Electronics: DAE3 Sn577; Calibrated: 2006/11/21
- Phantom: SAM-B; Type: QD 000 P40 C; Serial: TP-1383
- Measurement SW: DASY4, V4.7 Build 53; Postprocessing SW: SEMCAD, V1.8 Build 172

**Ch512/Area Scan (81x181x1):** Measurement grid: dx=15mm, dy=15mm

Maximum value of SAR (interpolated) = 0.503 mW/g

**Ch512/Zoom Scan (5x5x7)/Cube 0:** Measurement grid: dx=8mm, dy=8mm, dz=5mm

Reference Value = 15.2 V/m; Power Drift = -0.106 dB

Peak SAR (extrapolated) = 0.696 W/kg

**SAR(1 g) = 0.451 mW/g; SAR(10 g) = 0.273 mW/g**

Maximum value of SAR (measured) = 0.499 mW/g

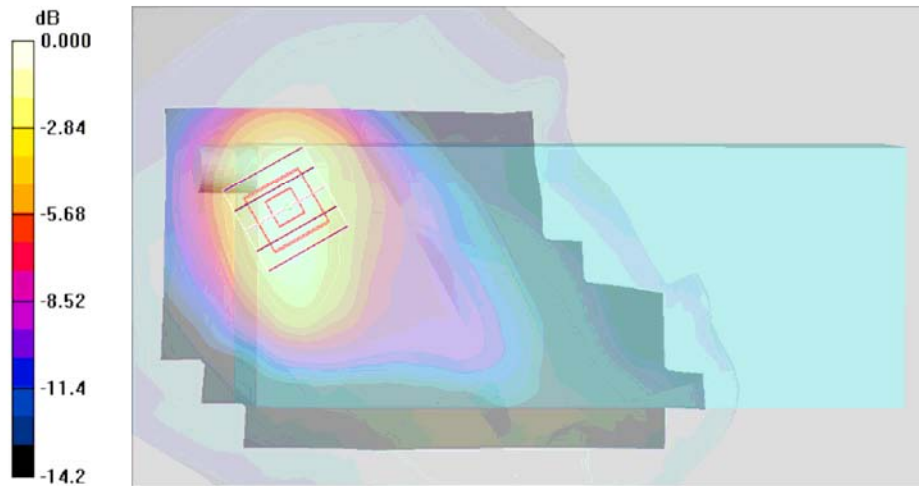

0 dB = 0.499mW/g



Test Laboratory: Sporton International Inc. SAR Testing Lab

Date: 2007/5/4

**Left Tilted\_PCS Ch512\_7527C\_POD 4\_B2**

Communication System: PCS; Frequency: 1850.2 MHz; Duty Cycle: 1:8.3  
Medium: HSL\_1900 Medium parameters used:  $f = 1850.2 \text{ MHz}$ ;  $\sigma = 1.37 \text{ mho/m}$ ;  $\epsilon_r = 38.9$ ;  $\rho = 1000 \text{ kg/m}^3$   
Ambient Temperature : 22.9 °C; Liquid Temperature : 21.0 °C

DASY4 Configuration:

- Probe: ET3DV6 - SN1787; ConvF(5.26, 5.26, 5.26); Calibrated: 2006/5/31
- Sensor-Surface: 4mm (Mechanical Surface Detection)
- Electronics: DAE3 Sn577; Calibrated: 2006/11/21
- Phantom: SAM-B; Type: QD 000 P40 C; Serial: TP-1383
- Measurement SW: DASY4, V4.7 Build 53; Postprocessing SW: SEMCAD, V1.8 Build 172

**Ch512/Area Scan (81x181x1):** Measurement grid: dx=15mm, dy=15mm  
Maximum value of SAR (interpolated) = 0.479 mW/g

**Ch512/Zoom Scan (5x5x7)/Cube 0:** Measurement grid: dx=8mm, dy=8mm, dz=5mm  
Reference Value = 17.7 V/m; Power Drift = -0.101 dB  
Peak SAR (extrapolated) = 0.668 W/kg  
**SAR(1 g) = 0.435 mW/g; SAR(10 g) = 0.269 mW/g**  
Maximum value of SAR (measured) = 0.475 mW/g

