

# ENGINEERING TEST REPORT

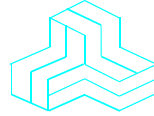

## Psion Teklogix 2.4 GHz Modular Transmitter Model No.: RA2020

**FCC ID: GM3RA2020**

*Applicant:* **Psion Teklogix Inc.**  
2100 Meadowvale Blvd.  
Mississauga, ON  
Canada, L5N 7J9

*In Accordance With*

**FEDERAL COMMUNICATIONS COMMISSION (FCC)  
PART 15, SUBPART C, SEC. 15.247  
Digital Modulation Transmitters operating in the frequency  
band 2400 - 2483.5 MHz**

**UltraTech's File No.: TEK-437FCC15C**

This Test report is Issued under the Authority of  
Tri M. Luu, Professional Engineer,  
Vice President of Engineering  
UltraTech Group of Labs



Date: Jan. 23, 2004

Report Prepared by: Tri Luu

Tested by: Hung Trinh

Issued Date: Jan. 23, 2004

Test Dates: Dec. 19-23 & Jan. 16-22, 2003

- *The results in this Test Report apply only to the sample(s) tested, and the sample tested is randomly selected.*
- *This report must not be used by the client to claim product endorsement by NVLAP or any agency of the US Government.*

## UltraTech

3000 Bristol Circle, Oakville, Ontario, Canada, L6H 6G4  
Tel.: (905) 829-1570 Fax.: (905) 829-8050

Website: [www.ultratech-labs.com](http://www.ultratech-labs.com) Email: [vic@ultratech-labs.com](mailto:vic@ultratech-labs.com), Email: [tri.luu@sympatico.ca](mailto:tri.luu@sympatico.ca)



31040/SIT



C-1376



46390-2049



200093-0

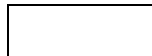

SL2-IN-E-1119R



00-034



## TABLE OF CONTENTS

<b>EXHIBIT 1.</b>	<b>SUBMITTAL CHECK LIST .....</b>	<b>4</b>
<b>EXHIBIT 2.</b>	<b>INTRODUCTION .....</b>	<b>5</b>
2.1.	SCOPE .....	5
2.2.	RELATED SUBMITAL(S)/GRANT(S).....	5
2.3.	NORMATIVE REFERENCES .....	5
<b>EXHIBIT 3.</b>	<b>PERFORMANCE ASSESSMENT .....</b>	<b>6</b>
3.1.	CLIENT INFORMATION .....	6
3.2.	EQUIPMENT UNDER TEST (EUT) INFORMATION .....	6
3.3.	EUT'S TECHNICAL SPECIFICATIONS .....	7
3.4.	LIST OF EUT'S PORTS .....	8
<b>EXHIBIT 4.</b>	<b>EUT OPERATING CONDITIONS AND CONFIGURATIONS DURING TESTS.....</b>	<b>9</b>
4.1.	CLIMATE TEST CONDITIONS .....	9
4.2.	OPERATIONAL TEST CONDITIONS & ARRANGEMENT FOR TESTS .....	9
4.3.	DRAWING OF TEST SETUP .....	10
<b>EXHIBIT 5.</b>	<b>SUMMARY OF TEST RESULTS.....</b>	<b>11</b>
5.1.	LOCATION OF TESTS.....	11
5.2.	APPLICABILITY & SUMMARY OF EMC EMISSION TEST RESULTS.....	12
5.3.	MODIFICATIONS INCORPORATED IN THE EUT FOR COMPLIANCE PURPOSES .....	12
<b>EXHIBIT 6.</b>	<b>MEASUREMENTS, EXAMINATIONS &amp; TEST DATA FOR EMC EMISSIONS .....</b>	<b>13</b>
6.1.	TEST PROCEDURES .....	13
6.2.	MEASUREMENT UNCERTAINTIES .....	13
6.3.	MEASUREMENT EQUIPMENT USED:.....	13
6.4.	ESSENTIAL/PRIMARY FUNCTIONS AS DECLARED BY THE MANUFACTURER:.....	13
6.5.	UNLICENSED MODULAR TRANSMITTER APPROVAL REQUIREMENTS @ FCC PUBLIC NOTICE DA 00-1407 (JUNE 26, 2000) .....	14
6.6.	6 dB BANDWIDTH @ FCC 15.247(A)(2) .....	17
6.6.1.	<i>Limits</i> .....	17
6.6.2.	<i>Method of Measurements</i> .....	17
6.6.3.	<i>Test Arrangement</i> .....	17
6.6.4.	<i>Test Equipment List</i> .....	17
6.6.5.	<i>Test Data</i> .....	17
6.7.	PEAK OUTPUT POWER (CONDUCTED) @ FCC 15.247(B) .....	21
6.7.1.	<i>Limits</i> .....	21
6.7.2.	<i>Method of Measurements &amp; Test Arrangement</i> .....	21
6.7.3.	<i>Test Equipment List</i> .....	21
6.7.4.	<i>Test Data</i> .....	21
6.8.	RF EXPOSURE REQUIRMENTS @ FCC 15.247(B)(4), 1.1310 & 2.1091 .....	22
6.8.1.	<i>Limits</i> .....	22
6.8.2.	<i>Method of Measurements</i> .....	22
6.8.3.	<i>Test Data</i> .....	24
6.9.	TRANSMITTER BAND-EDGE & SPURIOUS EMISSIONS (CONDUCTED), FCC CFR 47, PARA. 15.247(C) .....	25
6.9.1.	<i>Limits</i> .....	25
6.9.2.	<i>Method of Measurements</i> .....	25
6.9.3.	<i>Test Arrangement</i> .....	25
6.9.4.	<i>Test Equipment List</i> .....	25

6.9.5. Test Data ..... 26

6.10. TRANSMITTED POWER DENSITY OF A DIGITAL MODULATION SYSTEM, FCC CFR 47, PARA. 15.247(D)35

6.10.1. Limits ..... 35

6.10.2. Method of Measurements ..... 35

6.10.3. Test Arrangement ..... 35

6.10.4. Test Equipment List ..... 35

6.10.5. Test Data ..... 36

6.11. SPURIOUS EMISSIONS (RADIATED @ 3 METERS), FCC CFR 47, PARA. 15.247(C), 15.209 & 15.205 .. 40

6.11.1. Limits ..... 40

6.11.2. Method of Measurements ..... 41

6.11.3. Test Arrangement ..... 41

6.11.4. Test Equipment List ..... 41

6.11.5. Test Data ..... 41

**EXHIBIT 7. MEASUREMENT UNCERTAINTY ..... 67**

7.1. LINE CONDUCTED EMISSION MEASUREMENT UNCERTAINTY ..... 67

7.2. RADIATED EMISSION MEASUREMENT UNCERTAINTY ..... 68

**EXHIBIT 8. MEASUREMENT METHODS ..... 69**

8.1. GENERAL TEST CONDITIONS ..... 69

8.1.1. Normal temperature and humidity ..... 69

8.1.2. Normal power source ..... 69

8.1.3. Operating Condition of Equipment under Test ..... 69

8.2. METHOD OF MEASUREMENTS - AC MAINS CONDUCTED EMISSIONS ..... 70

8.3. PEAK CONDUCTED POWER & PEAK EIRP ..... 71

8.3.1. Measurements of Transmitter Parameters (Duty Cycle & Peak Power) ..... 71

8.4. SPURIOUS EMISSIONS (CONDUCTED & RADIATED) ..... 74

8.4.1. Band-edge and Spurious Emissions (Conducted) ..... 74

8.4.2. Spurious Emissions (Radiated) ..... 74

8.5. ALTERNATIVE TEST PROCEDURES ..... 76

8.5.1. Peak Power Measurements ..... 76

8.5.2. Spurious RF conducted emissions ..... 77

8.6. TRANSMITTED POWER DENSITY OF A DIGITAL MODULATION SYSTEM ..... 77

## EXHIBIT 1. SUBMITTAL CHECK LIST

Annex No.	Exhibit Type	Description of Contents	Quality Check (OK)
	Test Report	Test Report	OK
1	Test Setup Photos	Photos # 1 to 10	OK
2	External Photos of EUT	Photos # 1 to 2	OK
3	Internal Photos of EUT	Photos of 1 to 2	OK
4	Cover Letters	<ul style="list-style-type: none"><li>Letter from Ultratech for Certification Request</li></ul>	OK
5	Attestation Statements	<ul style="list-style-type: none"><li>Letter from the Applicant to appoint Ultratech to act as an agent</li><li>Letter from the Applicant to request for Confidentiality Filing</li></ul>	OK OK
6	ID Label/Location Info	<ul style="list-style-type: none"><li>ID Label</li><li>Location of ID Label</li></ul>	OK
7	Block Diagrams	<ul style="list-style-type: none"><li>Block diagrams</li></ul>	OK
8	Schematic Diagrams	<ul style="list-style-type: none"><li>Schematic diagrams</li></ul>	OK
9	Parts List/Tune Up Info	Parts List/Tune Up Info	OK
10	Operational Description	Operational Description	OK
11	RF Exposure Info	RF Exposure Info	OK
12	Users Manual	Users Manual	OK

### ULTRATECH GROUP OF LABS

3000 Bristol Circle, Oakville, Ontario, Canada L6H 6G4  
Tel. #: 905-829-1570, Fax. #: 905-829-8050, Email: [vic@ultratech-labs.com](mailto:vic@ultratech-labs.com), Website: <http://www.ultratech-labs.com>

File #: TEK-437FCC15C  
Jan. 23, 2004

- All test results contained in this engineering test report are traceable to National Institute of Standards and Technology (NIST)

## EXHIBIT 2. INTRODUCTION

### 2.1. SCOPE

<b>Reference:</b>	FCC Part 15, Subpart C, Section 15.247
<b>Title</b>	Telecommunication - Code of Federal Regulations, CFR 47, Part 15
<b>Purpose of Test:</b>	To gain FCC Certification Authorization for Digital Modulation Transmitters operating in the Frequency Band 2400 - 2483.5 MHz .
<b>Test Procedures</b>	Both conducted and radiated emissions measurements were conducted in accordance with American National Standards Institute ANSI C63.4 - American National Standard for Methods of Measurement of Radio-Noise Emissions from Low-Voltage Electrical and Electronic Equipment in the Range of 9 kHz to 40 GHz.
<b>Environmental Classification:</b>	<ul style="list-style-type: none"> <li>• Light-industry, Commercial</li> <li>• Industry</li> </ul>
<b>Limited Modular Approval</b>	This Certification application is for <b>Limited Modular Approval</b> for use only with Psion Teklogix Radio Telecommunication Mobile and Base Stations where the stations and their antennas are required to be professionally installed. This modular transmitter together with its associated optional antennas is prohibited to be sold by itself.
<b>Notes:</b>	The 2.4 GHz Modular Transceiver Module is manufactured by <b>Universal Scientific Industrial Co Ltd (USI)</b> , its <b>FCC ID: IXMCF-B-AG-01</b> . Since this radio will be professionally installed inside several Psion Teklogix Systems with different antennas which may have standard RF connectors. The new FCC certification is required so that Psion Teklogix can make these changes by themselves without going through USI.

### 2.2. RELATED SUBMITAL(S)/GRANT(S)

None

### 2.3. NORMATIVE REFERENCES

Publication	YEAR	Title
FCC CFR Parts 0-19	2002	Code of Federal Regulations – Telecommunication
ANSI C63.4	1992	American National Standard for Methods of Measurement of Radio-Noise Emissions from Low-Voltage Electrical and Electronic Equipment in the Range of 9 kHz to 40 GHz
CISPR 22 & EN 55022	2002 2003	Limits and Methods of Measurements of Radio Disturbance Characteristics of Information Technology Equipment
CISPR 16-1	1999	Specification for Radio Disturbance and Immunity measuring apparatus and methods
FCC Public Notice DA 00-705	2000	Filing and Measurement Guidelines for Frequency Hopping Spread Spectrum Systems
FCC ET Docket No. 99-231	2002	Amendment to FCC Part 15 of the Commission's Rules Regarding to Spread Spectrum Devices

## ULTRATECH GROUP OF LABS

3000 Bristol Circle, Oakville, Ontario, Canada L6H 6G4  
 Tel. #: 905-829-1570, Fax. #: 905-829-8050, Email: [vic@ultratech-labs.com](mailto:vic@ultratech-labs.com), Website: <http://www.ultratech-labs.com>

File #: **TEK-437FCC15C**

Jan. 23, 2004

- All test results contained in this engineering test report are traceable to National Institute of Standards and Technology (NIST)

## EXHIBIT 3. PERFORMANCE ASSESSMENT

### 3.1. CLIENT INFORMATION

<b>APPLICANT:</b>	
<b>Name:</b>	Psion Teklogix Inc.
<b>Address:</b>	2100 Meadowvale Blvd. Mississauga, ON Canada, L5N 7J9
<b>Contact Person:</b>	Mr. Sada Dharwarkar Phone #: 905-812-6200 (3358) Fax #: 905-812-6301 Email Address: <a href="mailto:sdharwar@teklogix.com">sdharwar@teklogix.com</a>

<b>MANUFACTURER:</b>	
<b>Name:</b>	Psion Teklogix Inc.
<b>Address:</b>	2100 Meadowvale Blvd. Mississauga, ON Canada, L5N 7J9
<b>Contact Person:</b>	Mr. Sada Dharwarkar Phone #: 905-812-6200 (3358) Fax #: 905-812-6301 Email Address: <a href="mailto:sdharwar@teklogix.com">sdharwar@teklogix.com</a>

### 3.2. EQUIPMENT UNDER TEST (EUT) INFORMATION

The following information (with the exception of the Date of Receipt) has been supplied by the applicant.

<b>Brand Name</b>	Psion Teklogix Inc.
<b>Product Name</b>	Psion Teklogix 2.4 GHz Modular Transmitter
<b>Model Name or Number</b>	RA2020
<b>Serial Number</b>	N/A
<b>Type of Equipment</b>	Digital Modulation Transmitters
<b>Input Power Supply Type</b>	<ul style="list-style-type: none"> <li>• Internal Battery</li> </ul>
<b>Primary User Functions of EUT:</b>	Provide data communication link through air

### 3.3. EUT'S TECHNICAL SPECIFICATIONS

<b>TRANSMITTER</b>	
<b>Equipment Type:</b>	▪ Modular Transceiver for Mobile and Fixed Base
<b>Intended Operating Environment:</b>	▪ Commercial, light industry & heavy industry
<b>Power Supply Requirement:</b>	7.4 Vdc
<b>RF Output Power Rating:</b>	0.0361 Watts
<b>Operating Frequency Range:</b>	2412 - 2462 MHz
<b>RF Output Impedance:</b>	50 Ohms
<b>Duty Cycle:</b>	100%
<b>6 dB Bandwidth:</b>	9.93 MHz
<b>Modulation Type:</b>	IEEE 802.11b: <ul style="list-style-type: none"> <li>• DBPSK for 1Mb/s Data Rate</li> <li>• DQPSK for 2 Mb/s Data Rate</li> <li>• CCK for 5.5 Mb/s Data Rate</li> <li>• CCK for 11 Mb/s Data Rate</li> </ul>
<b>Emission Designation:</b>	Digital Modulation
<b>Oscillator Frequencies:</b>	
<b>Spectral Density</b>	3.6 mW/MHz (Power output at the antenna / bandwidth of the RF output spectrum)
<b>Antenna Description:</b>	Please refer to the following table for optional antennas certified with Psion Teklogix Model RA2020 Modular Radio Transmitter.

#### ANTENNA LIST CERTIFIED WITH THE MODEL RA2020 MODULAR TRANSCEIVER

Antenna Number	Antenna Type	Model/Part Number	Maker	Operating Frequency Range (GHz)	Antenna Gain (dBi)	Connector Type	Installation Method
1	¼ Wave Dipole	EXE-2400-SMRP	Centurion	2.4-2.5	2.0	Reversed SMA	Professional installation is required
2	Magnet Mount Antenna	IMAG5-2400	Mobile Mark	2.4-2.5	5.0	TNC	Professional installation is required
3	Mono-omni antenna – tube end	S2403BP12NF	Cushcraft	2.4-2.5	5.2	TNC	Professional installation is required
4	Omni Base with attached to ground plane (1/4 Wave)	FB45T2400	Larsen	2.4-2.485	7.2	Standard N connector	Professional installation is required
5	Patch antenna – Wall mount	S2307AMP10SMF Or S2307MP10SMF	Cushcraft	2.3-2.5	7.5	Reversed SMA	Professional installation is required

#### ULTRATECH GROUP OF LABS

3000 Bristol Circle, Oakville, Ontario, Canada L6H 6G4  
 Tel. #: 905-829-1570, Fax. #: 905-829-8050, Email: [vic@ultratech-labs.com](mailto:vic@ultratech-labs.com), Website: <http://www.ultratech-labs.com>

File #: TEK-437FCC15C

Jan. 23, 2004

- All test results contained in this engineering test report are traceable to National Institute of Standards and Technology (NIST)

### 3.4. LIST OF EUT'S PORTS

Port Number	EUT's Port Description	Number of Identical Ports	Connector Type	Cable Type (Shielded/Non-shielded)
1	RF In/Out Port	1	CMMX	Shielded coaxial
2	I/O Port	1	Mini pin-header card	Direct plug-in with no cable

---

#### ULTRATECH GROUP OF LABS

3000 Bristol Circle, Oakville, Ontario, Canada L6H 6G4  
Tel. #: 905-829-1570, Fax. #: 905-829-8050, Email: [vic@ultratech-labs.com](mailto:vic@ultratech-labs.com), Website: <http://www.ultratech-labs.com>

File #: TEK-437FCC15C  
Jan. 23, 2004

- All test results contained in this engineering test report are traceable to National Institute of Standards and Technology (NIST)



## EXHIBIT 4. EUT OPERATING CONDITIONS AND CONFIGURATIONS DURING TESTS

### 4.1. CLIMATE TEST CONDITIONS

The climate conditions of the test environment are as follows:

Temperature:	21°C
Humidity:	51%
Pressure:	102 kPa
Power input source:	7.4 Vdc

### 4.2. OPERATIONAL TEST CONDITIONS & ARRANGEMENT FOR TESTS

<b>Operating Modes:</b>	<ul style="list-style-type: none"> <li>▪ Each of lowest, middle and highest channel frequencies transmits continuously for emissions measurements.</li> <li>▪ The EUT operates in normal Direct Sequence mode for occupancy duration, and frequency separation.</li> </ul>
<b>Special Test Software:</b>	<ul style="list-style-type: none"> <li>▪ Special software is provided by the Applicant to select and operate the EUT at each channel frequency continuously. For example, the transmitter will be operated at each of lowest, middle and highest frequencies individually continuously during testing.</li> </ul>
<b>Special Hardware Used:</b>	The RS2020 Radio Module was mounted on top of an Expansion card which is plugged in the Psion Teklogix RA2020 Terminal so that the radio module can be tested outside of the enclosure.
<b>Transmitter Test Antenna:</b>	The antenna was connected to the EUT with it worst case for RF interference measurements.

<b>Transmitter Test Signals:</b>	
<b>Frequencies:</b> <ul style="list-style-type: none"> <li>▪ 2412 - 2462 MHz band:</li> </ul>	Lowest, middle and highest channel frequencies tested: 2412, 2437 & 2462 MHz
<b>Transmitter Wanted Output Test Signals:</b> <ul style="list-style-type: none"> <li>▪ RF Power Output (measured maximum output power):</li> <li>▪ Normal Test Modulation</li> <li>▪ Modulating signal source:</li> </ul>	<ul style="list-style-type: none"> <li>▪ 0.0361 Watts</li> <li>▪ CCK @ 11 Mb/s</li> <li>▪ Internal</li> </ul>

### 4.3. DRAWING OF TEST SETUP

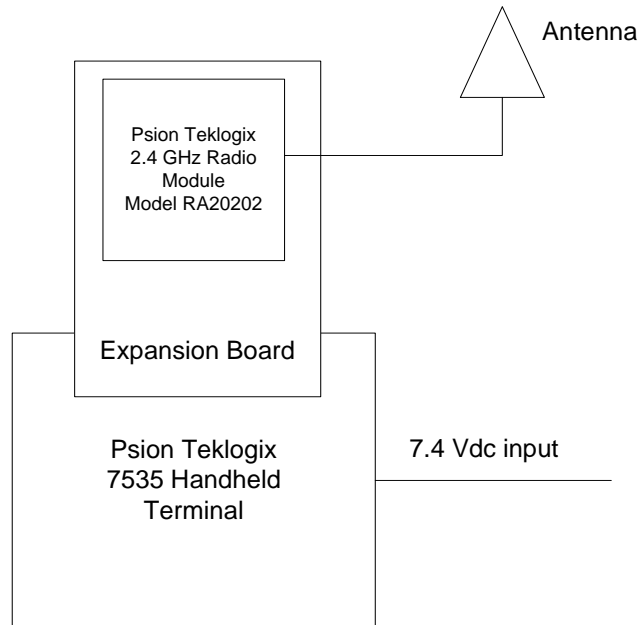

## EXHIBIT 5. SUMMARY OF TEST RESULTS

### 5.1. LOCATION OF TESTS

All of the measurements described in this report were performed at Ultratech Group of Labs located in the city of Oakville, Province of Ontario, Canada.

- AC Powerline Conducted Emissions were performed in UltraTech's shielded room, 16'(L) by 12'(W) by 12'(H).
- Radiated Emissions were performed at the Ultratech's 3 Meter Open Field Test Site (OFTS) situated in the Town of Oakville, province of Ontario.

The above sites have been calibrated in accordance with ANSI C63.4, and found to be in compliance with the requirements of Sec. 2.948 of the FCC Rules. The descriptions and site measurement data of the Oakville Open Field Test Site has been filed with FCC office (FCC File No.: 31040/SIT 1300B3) and Industry Canada office (Industry Canada File No.: IC2049). Last Date of Site Calibration: Nov. 04, 2002.

- *All test results contained in this engineering test report are traceable to National Institute of Standards and Technology (NIST)*

## 5.2. APPLICABILITY & SUMMARY OF EMC EMISSION TEST RESULTS

unlicensed modular Transmitter approval requirements @ FCC Public Notice DA 00-1407 (JUnE 26, 2000)

FCC PARAGRAPH.	TEST REQUIREMENTS	COMPLIANCE (YES/NO)
FCC DA 00-1407	Un-licensed Modular Transmitter Approval Requirements	Yes with limitation
15.107(a) & 207	AC Power Conducted Emissions	N/A See Note (2)
15.247(a)(2)	6dB Bandwidth of a Digital Modulation System	Yes
15.247(b) & 1.1310	Maximum Peak Power (Conducted)	Yes
1.1307, 1.1310, 2.1091 & 2.1093	RF Exposure Limit	Yes
15.247(c)	RF Conducted Spurious Emissions at the Transmitter Antenna Terminal	Yes
15.247(d)	Transmitted Power Density of a Digital Modulation System	Yes
15.247(c), 15.209 & 15.205	Transmitter Radiated Emissions	Yes
FCC Part 15, Sub. B, Sec. 15.109	Class B Radiated Emissions	Yes. See Note 1

**Note 1:** A separate engineering test report for compliance with FCC Part 15, Subpart B - Class B Unintentional Radiators will be provided upon request.

**Note 2:** Tests are not possible for this Radio Module with a battery operated terminal. The host system, which is powered by AC supply or AC/DC external power supply, employs RA2020 Radio Module shall comply with FCC Part 15.207 AC Powerline Conducted Emissions

## 5.3. MODIFICATIONS INCORPORATED IN THE EUT FOR COMPLIANCE PURPOSES

None

## **EXHIBIT 6. MEASUREMENTS, EXAMINATIONS & TEST DATA FOR EMC EMISSIONS**

### **6.1. TEST PROCEDURES**

This section contains test results only. Details of test methods and procedures can be found in Exhibit 8 of this report and ANSI C63-4:1992

### **6.2. MEASUREMENT UNCERTAINTIES**

The measurement uncertainties stated were calculated in accordance with requirements of UKAS Document NIS 81 with a confidence level of 95%. Please refer to Exhibit 7 for Measurement Uncertainties.

### **6.3. MEASUREMENT EQUIPMENT USED:**

The measurement equipment used complied with the requirements of the Standards referenced in the Methods & Procedures ANSI C64-3:1992, FCC 15.247 and CISPR 16-1.

### **6.4. ESSENTIAL/PRIMARY FUNCTIONS AS DECLARED BY THE MANUFACTURER:**

The essential function of the EUT is to correctly communicate data to and from radios over RF link.

## 6.5. UNLICENSED MODULAR TRANSMITTER APPROVAL REQUIREMENTS @ FCC PUBLIC NOTICE DA 00-1407 (JUNE 26, 2000)

In order to satisfy FCC requirements for equipment authorization for modular transmitters, the transmitters shall meet the following parameters:

	Requirements for Modular Transmitters	Manufacturer's Clarification	Laboratory's Comments
(a)	In order to be considered a transmitter module, the device must be complete RF transmitter, i.e., it must have its own reference oscillator (e.g., VCO), antenna, etc.... The only connectors to the module, if any, may be power supply and modulation/data inputs	<ul style="list-style-type: none"> <li>✓ The transmitter is completed with its own reference oscillator, antenna.</li> <li>✓ Only connectors provide are dc supply, data and rf ports are provided with the modular transmitter</li> </ul>	Satisfactory
(b)	Compliance with FCC RF Exposure requirements may, in some instances, limit the output power of a module and/or the final applications in which the approved module may be employed	<ul style="list-style-type: none"> <li>✓ The radio is intended for use in all applications (portable, mobile and base). It complies with SAR test with body tissue</li> <li>✓ The radio is intended for use with mobile or fixed base stations only. It complies with MPE per 2.1091 &amp; 1.1307</li> </ul>	Satisfactory
(c)	While the applicant for a device into which an authorized module is installed is not required to obtain a new authorization for the module, this does not preclude the possibility that some other form of authorization or testing may be required for the device (e.g., a WLAN into which the authorized module is installed still be authorized as PC peripheral, subject to the appropriate equipment authorization)	<ul style="list-style-type: none"> <li>✓ The equipment under complies with FCC Part15, Subpart B, Class B – Unintentional radiators</li> </ul>	Satisfactory
(d)	In the case of a modular transceiver, the modular approval policy only applies to the transmitter portion of such devices. Pursuant to section 15.101(b), the receiver portion will either be subject to Verification, or it will not be subject to any authorization requirements (unless it is a Scanning Receiver, in which case it is also subject to Certification, pursuant to Section 15.101(a))	<ul style="list-style-type: none"> <li>✓ The receiver operates in the band above 960 MHz; therefore, the FCC authorization for the receiver is exempted.</li> </ul>	Satisfactory

	Requirements for Modular Transmitters	Manufacturer's Clarification	Laboratory's Comments
(e)	The holder of the grant of equipment authorization (Grantee) of the module is responsible for the compliance of the module in its final configuration, provided that the OEM, integrator, and /or end user has complied with all of the instructions provided by the Grantee which indicate installation and/or operating conditions necessary for compliance.	End-users must comply with the following instruction sated in the users' manual: ✓ Labeling requirement for equipment using this modular transmitter. ✓ RF Exposure Warning for compliance with FCC Rules 2.1091 and 1.1307 when the radio is used in a mobile or base system	Satisfactory

In order to obtain a modular transmitter approval, a cover letter requesting modular approval must be submitted and the numbered requirements identified below must be addressed in the application for equipment authorization:

	Requirements for Modular Transmitters	Manufacturer's Clarification	Laboratory's Comments
1.	The modulator transmitter must have its own RF shielding. This is intended to ensure that the module does not have to rely upon the shielding provided by the device into which it is installed in order for all modular transmitter emissions to comply with Part 15 limits. It is also intended to prevent coupling between the RF circuitry of the module and any wires or circuits in the device into which the module is installed. Such coupling may result in non-complaint operation.	✓ The modular transmitter has its own RF shielding	Satisfactory
2.	The modular transmitter must have buffered modulation/data inputs (if such inputs are provided) to ensure that the module will comply with Part 15 requirements under conditions of excessive data rates or over-modulation.	✓ The modular transmitter has buffered modulation/data inputs	Satisfactory
3.	The modular transmitter must have its own power supply regulation. This is intended to ensure that the module will comply with Part 15 requirements regardless of the design of the power supplying circuitry in the device into which the module is installed.	✓ The modular transmitter has its own power supply regulation.	Satisfactory

**ULTRATECH GROUP OF LABS**

3000 Bristol Circle, Oakville, Ontario, Canada L6H 6G4  
 Tel. #: 905-829-1570, Fax. #: 905-829-8050, Email: [vic@ultratech-labs.com](mailto:vic@ultratech-labs.com), Website: <http://www.ultratech-labs.com>

File #: TEK-437FCC15C

Jan. 23, 2004

- All test results contained in this engineering test report are traceable to National Institute of Standards and Technology (NIST)

	Requirements for Modular Transmitters	Manufacturer's Clarification	Laboratory's Comments
4.	The modular transmitter must comply with the antenna requirements of section 15.203 and 15.204(c). The antenna must either be permanently attached or employ a "unique" antenna coupler (at all connections between the module and the antenna, including the cable). Any antenna used with the module must be approved with the module, either at the time of initial authorization or through a Class II permissive change. The "professional installation" provision of Section 15.203 may not be applied to modules.	<ul style="list-style-type: none"> <li>✓ The radio complies with Rules 15.203 and 15.204(c) with permanently attached antenna.</li> <li>✓ The radio and its associated antennas are provided with the special coupling antenna connectors (MMCX, reversed SMA.....).</li> <li>✓ The professional installation is not allowed under FCC approval.</li> </ul>	Note (1) below
5	The modular transmitter must be tested in a stand-alone configuration, i.e., the module must not be inside another device during testing. This is intended to demonstrate that the module is capable of complying with Part 15 emission limits regardless of the device into which it is eventually installed. Unless the transmitter module will be battery powered, it must comply with the AC conducted requirements found in Section 15.207. AC or DC power lines and data input/output lines connected to the module must not contain ferrites, unless they will marketed with the module (see Section 15.27(a)). The length of these lines shall be length typical of actual use or, if that length is unknown, at least 10 centimeters to insure that there is no coupling between the case of the module and supporting equipment. Any accessories, peripherals, or support equipment connected to the module during testing shall be unmodified or commercially available (See Section 15.31(I)).	<ul style="list-style-type: none"> <li>✓ The modular transmitter was tested in a stand-alone configuration</li> </ul>	Satisfactory

Note (1): This Certification application is for **Limited Modular Approval** for use only with Psion Teklogix Radio Telecommunication Mobile and Base Stations where the stations and their antennas are required to be professionally installed. This modular transmitter together with its associated optional antennas is prohibited to be sold by itself.



## 6.6. 6 DB BANDWIDTH @ FCC 15.247(A)(2)

### 6.6.1. Limits

For a Digital Modulation System, the minimum 6 dB bandwidth shall be at least 500 KHz.

### 6.6.2. Method of Measurements

Refer to ANSI C63-4:1992

The transmitter output was connected to the spectrum analyzer through an attenuator. the bandwidth of the fundamental frequency was measured with the spectrum analyzer using 30 KHz RBW, VBW = 100 KHz,. The 6 dB bandwidth was measured and recorded.

### 6.6.3. Test Arrangement

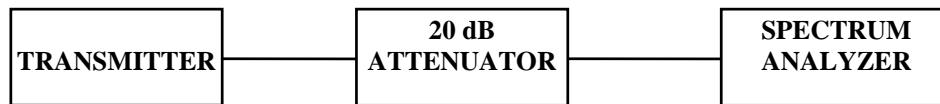

### 6.6.4. Test Equipment List

Test Instruments	Manufacturer	Model No.	Serial No.	Frequency Range
Spectrum Analyzer/ EMI Receiver	Hewlett Packard	HP 8593EM	3412A00103	9 kHz – 26.5 GHz

### 6.6.5. Test Data

CHANNEL FREQUENCY (MHz)	Modulation *	6 dB BANDWIDTH (MHz)	MINIMUM LIMIT (MHz)	PASS/FAIL
2412	CCK 11 Mb/s	9.93	0.5	PASS
2437	CCK 11 Mb/s	9.93	0.5	PASS
2462	CCK 11 Mb/s	9.93	0.5	PASS

\* Please refer to Plots # 1 to 3 for detailed measurements.

**Remarks:** The above measurements were found to be the same for all different modulations such as below:

- DBPSK for 1Mb/s Data Rate
- DQPSK for 2 Mb/s Data Rate
- CCK for 5.5 Mb/s Data Rate
- CCK for 11 Mb/s Data Rate

**Plot #1: 6 dB Bandwidth @ Frequency: 2412 MHz**

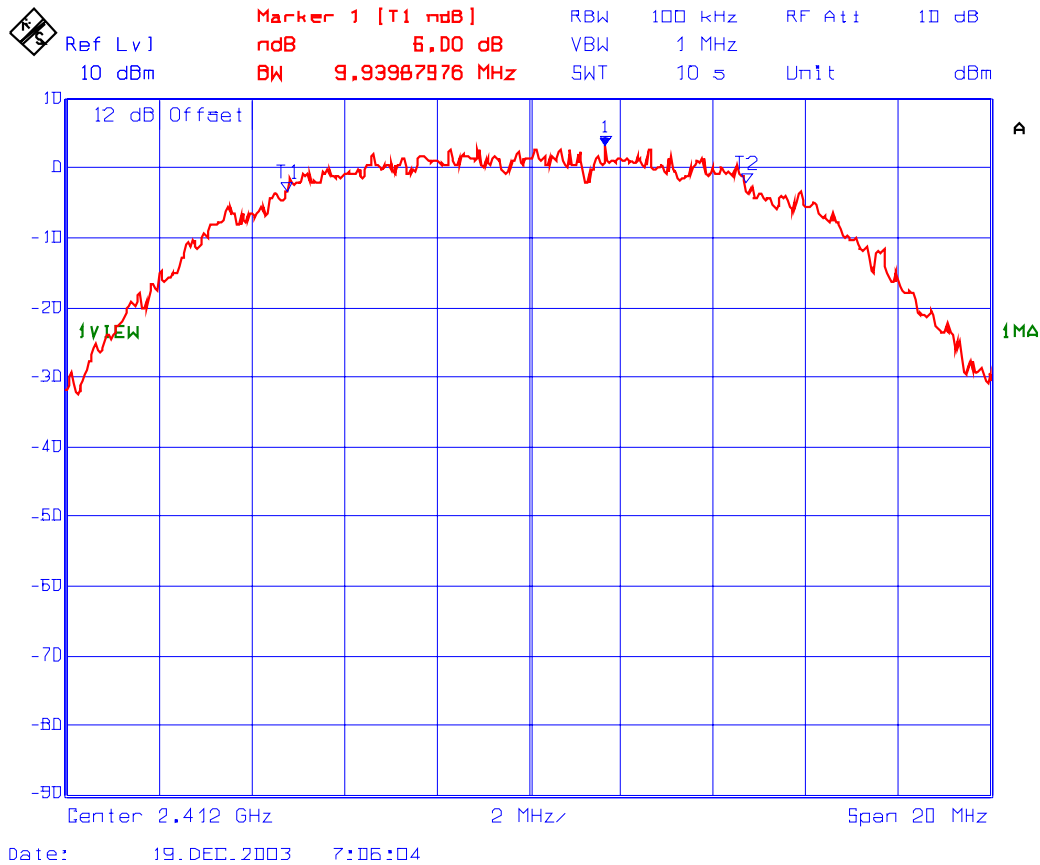

**ULTRATECH GROUP OF LABS**

3000 Bristol Circle, Oakville, Ontario, Canada L6H 6G4  
Tel. #: 905-829-1570, Fax. #: 905-829-8050, Email: [vic@ultratech-labs.com](mailto:vic@ultratech-labs.com), Website: <http://www.ultratech-labs.com>

File #: TEK-437FCC15C  
Jan. 23, 2004

- All test results contained in this engineering test report are traceable to National Institute of Standards and Technology (NIST)

Plot #2: 6 dB Bandwidth @ Frequency: 2437 MHz

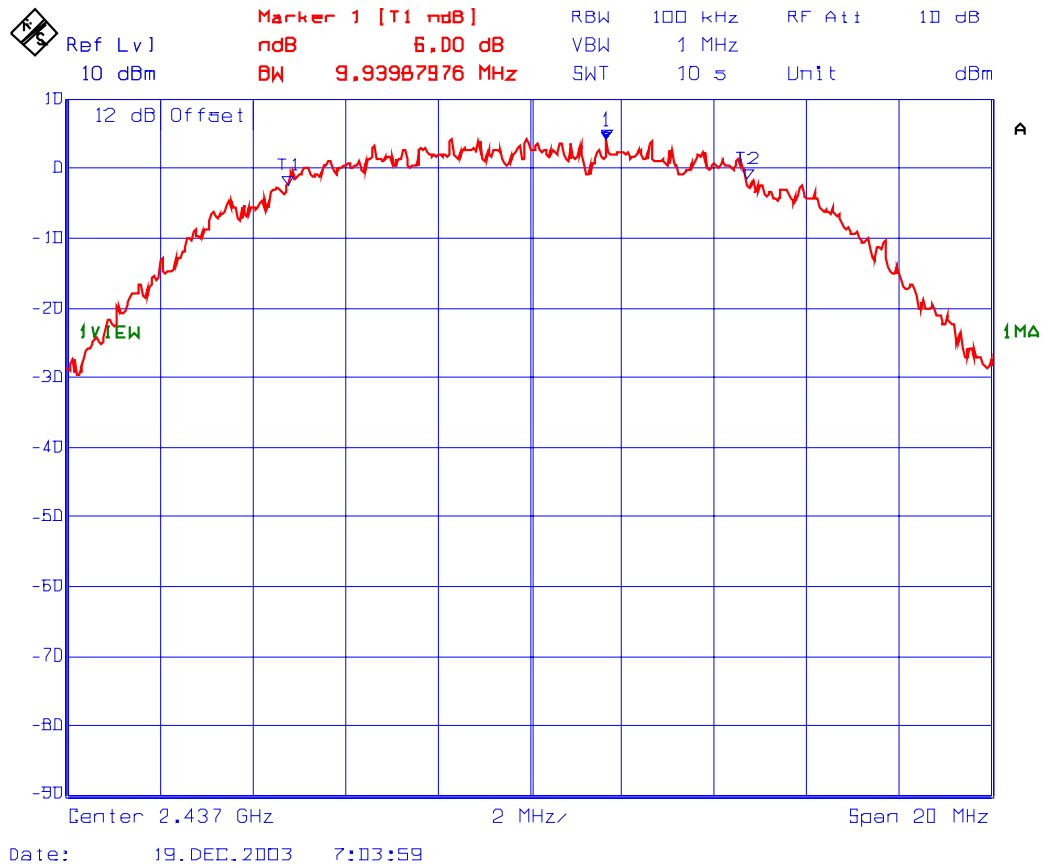

ULTRATECH GROUP OF LABS

3000 Bristol Circle, Oakville, Ontario, Canada L6H 6G4  
Tel. #: 905-829-1570, Fax. #: 905-829-8050, Email: vic@ultratech-labs.com, Website: http://www.ultratech-labs.com

File #: TEK-437FCC15C  
Jan. 23, 2004

- All test results contained in this engineering test report are traceable to National Institute of Standards and Technology (NIST)

**Plot #3: 6 dB Bandwidth @ Frequency: 2462 MHz**

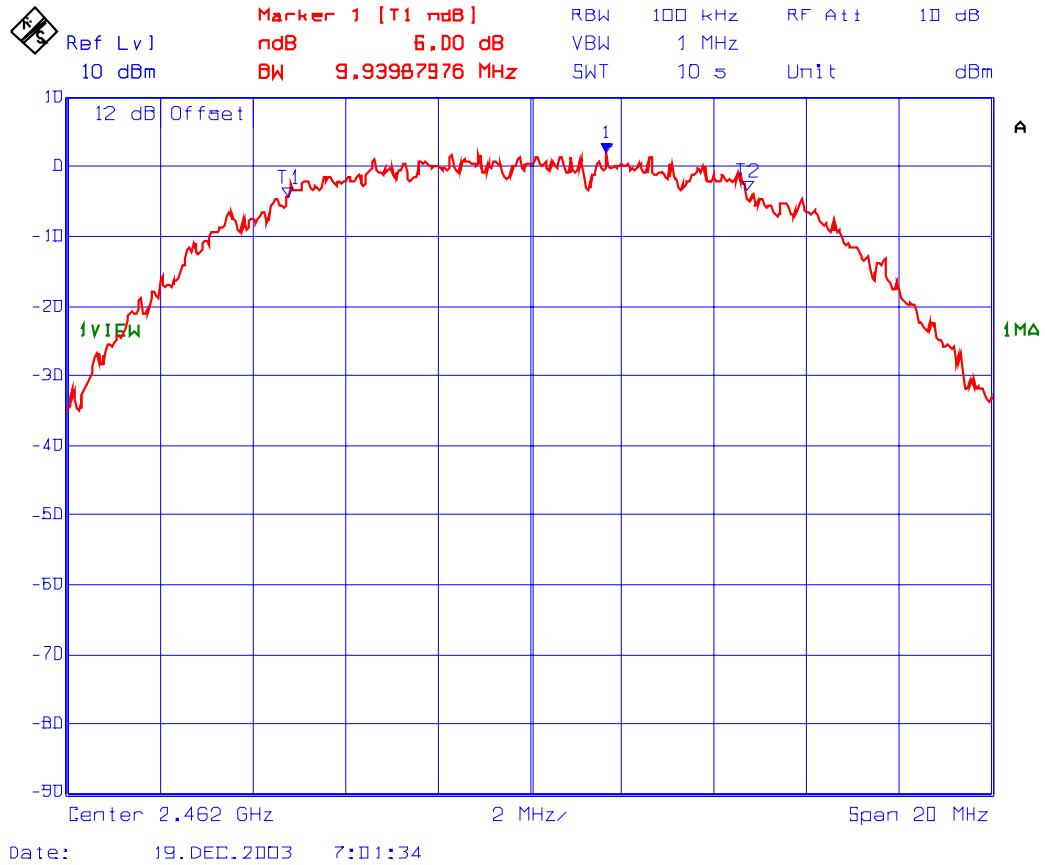

**ULTRATECH GROUP OF LABS**

3000 Bristol Circle, Oakville, Ontario, Canada L6H 6G4  
Tel. #: 905-829-1570, Fax. #: 905-829-8050, Email: [vic@ultratech-labs.com](mailto:vic@ultratech-labs.com), Website: <http://www.ultratech-labs.com>

File #: TEK-437FCC15C  
Jan. 23, 2004

- All test results contained in this engineering test report are traceable to National Institute of Standards and Technology (NIST)

## 6.7. PEAK OUTPUT POWER (CONDUCTED) @ FCC 15.247(B)

### 6.7.1. Limits

- **FCC 15.247(b)(3):** Maximum peak output power of the transmitter shall not exceed 1 Watt.
- **FCC 15.247(b)(4)(i):** If the device is not for fixed point to point radio, the antenna of directional gain greater than 6 dBi are used, the power shall be reduced by the amount in dB that the directional gain of the antenna exceeds 6 dBi.

### 6.7.2. Method of Measurements & Test Arrangement

Refer to Exhibit 8, Sec. 8.3 of this test report, FCC 15.247(b)(1)&(3), ANSI C63-4:1992 & ETSI 300 328

**Note:** The conducted peak power measurement method was performed in accordance with ETSI 300 328 since it was proven to be independent with the peak power meter characteristics.

### 6.7.3. Test Equipment List

Test Instruments	Manufacturer	Model No.	Serial No.	Frequency Range
Spectrum Analyzer/ EMI Receiver	Hewlett Packard	HP 8546A	...	9 kHz to 5.6 GHz with built-in 30 dB Gain Pre- selector, QP, Average & Peak Detectors.
67297 RF Detector (Diode Detector)	Herotex	DZ122-553	63400	..
Storage Oscilloscope	Philips	PM3320A	ST9907959	--

### 6.7.4. Test Data

Transmitter Channel	Frequency (MHz)	(full bandwidth) Peak Power at Antenna Terminals (dBm)	Maximum Antenna Gain (dBi)	(full bandwidth) Peak EIRP (dBm)	Limit for Power at Antenna Port (dBm)	Limit for EIRP (dBm)
Lowest	2412	14.6	0	14.6	30.0	36.0
Middle	2437	15.6	0	15.6	30.0	36.0
Highest	2462	13.8	0	13.8	30.0	36.0

**Remarks:** The above measurements were found to be the same for all different modulations such as below:

- DBPSK for 1Mb/s Data Rate
- DQPSK for 2 Mb/s Data Rate
- CCK for 5.5 Mb/s Data Rate
- CCK for 11 Mb/s Data Rate

## 6.8. RF EXPOSURE REQUIREMENTS @ FCC 15.247(B)(4), 1.1310 & 2.1091

### 6.8.1. Limits

- **FCC 15.247(b)(4):** Systems operating under provisions of this section shall be operated in a manner that ensures that the public is not exposed to radio frequency energy levels in excess of the Commission’s guidelines. See @ 1.1307(b)(1).
- **FCC 1.1310:-** The criteria listed in the following table shall be used to evaluate the environmental impact of human exposure to radio-frequency (RF) radiation as specified in 1.1307(b).

**LIMITS FOR MAXIMUM PERMISSIBLE EXPOSURE (MPE)**

Frequency Range (MHz)	Electric Field Strength (V/m)	Magnetic Field Strength (A/m)	Power Density (mW/cm <sup>2</sup> )	Average Time (minutes)
<b>(A) Limits for Occupational/Control Exposures</b>				
1500-100,000	...	...	5	6
<b>(B) Limits for General Population/Uncontrolled Exposure</b>				
1500-100,000	...	...	1.0	30

F = Frequency in MHz

### 6.8.2. Method of Measurements

Refer to FCC @ 1.1310, 2.1091 and Public Notice DA 00-705 (March 30, 2000)

- Spread spectrum transmitters operating under section 15.247 are categorically from routine environmental evaluation to demonstrating RF exposure compliance with respect to MPE and/or SAR limits. These devices are not exempted from compliance (As indicated in Section 15.247(b)(4), these transmitters are required to operate in a manner that ensures that exposure to public users and nearby persons) does not exceed the Commission’s RF exposure guidelines (see Section 1.1307 and 2.1093). Unless a device operates at substantially low power levels, with a low gain antenna(s), supporting information is generally needed to establish the various potential operating configurations and exposure conditions of a transmitter and its antenna(s) in order to determine compliance with the RF exposure guidelines.
- In order to demonstrate compliance with MPE requirements (see Section 2.1091), the following information is typically needed:
  - (1) Calculation that estimates the minimum separation distance (20 cm or more) between an antenna and persons required to satisfy power density limits defined for free space.
  - (2) Antenna installation and device operating instructions for installers (professional/unskilled users), and the parties responsible for ensuring compliance with the RF exposure requirement
  - (3) Any caution statements and/or warning labels that are necessary in order to comply with the exposure limits
  - (4) Any other RF exposure related issues that may affect MPE compliance

**Calculation Method of RF Safety Distance:**

$$S = PG/4\pi r^2 = EIRP/4\pi r^2$$

Where: P: power input to the antenna in mW  
EIRP: Equivalent (effective) isotropic radiated power.  
S: power density mW/cm<sup>2</sup>  
G: numeric gain of antenna relative to isotropic radiator  
r: distance to centre of radiation in cm

FCC radio frequency exposure limits may be exceeded at distances closer than r cm from the antenna of this device

$$r = \sqrt{PG/4\pi S}$$

FCC radio frequency exposure limits may not be exceeded at distances closer than r cm from the antenna of this device

- For portable transmitters (see Section 2.1093), or devices designed to operate next to a person's body, compliance is determined with respect to the SAR limit (define in the body tissues) for near-field exposure conditions. If the maximum average output power, operating condition configurations and exposure conditions are comparable to those of existing cellular and PCS phones., an SAR evaluation may be required in order to determine if such a device complies with SAR limit. When SAR evaluation data is not available, and the additional supporting information cannot assure compliance, the Commission may request that a SAR evaluation be performed, as provided for in Section 1.1307(d)

**6.8.3. Test Data**

Frequency (MHz)	Maximum Conducted Peak Power at the Antenna Terminal (dBm)	Highest Antenna Gain (dBi)	Maximum Measured Total EIRP (dBm)	Calculated Antenna Separation Distance r (cm)
2412 – 2462	15.6	7.5	23.1	4.0

**Note 1:** RF EXPOSURE DISTANCE LIMITS:  $r = (PG/4\pi S)^{1/2} = (EIRP/4\pi S)^{1/2}$   
 Limits for General Population/Uncontrolled Exposure:  $S = 1.0 \text{ mW/cm}^2$

Evaluation of RF Exposure Compliance Requirements	
RF Exposure Requirements	Compliance with FCC Rules
Minimum calculated separation distance between antenna and persons required: 4.0 cm	Manufacturer' instruction for separation distance between antenna and persons required: 20 cm.
Antenna installation and device operating instructions for installers (professional/unskilled users), and the parties responsible for ensuring compliance with the RF exposure requirement	Professional installation is required
Caution statements and/or warning labels that are necessary in order to comply with the exposure limits	N/A
Any other RF exposure related issues that may affect MPE compliance	N/A



## 6.9. TRANSMITTER BAND-EDGE & SPURIOUS EMISSIONS (CONDUCTED), FCC CFR 47, PARA. 15.247(C)

### 6.9.1. Limits

In any 100 KHz bandwidth outside the operating frequency band, the radio frequency power that is produced by modulation products of the spreading sequence, the information sequence and the carrier frequency shall be at least 20 dB below that in any 100 KHz bandwidth within the band that contains the highest level of the desired power.

### 6.9.2. Method of Measurements

Refer to Exhibit 8, Sec. 8.4 of this test report, FCC 15.247(c) & ANSI C63-4:1992

### 6.9.3. Test Arrangement

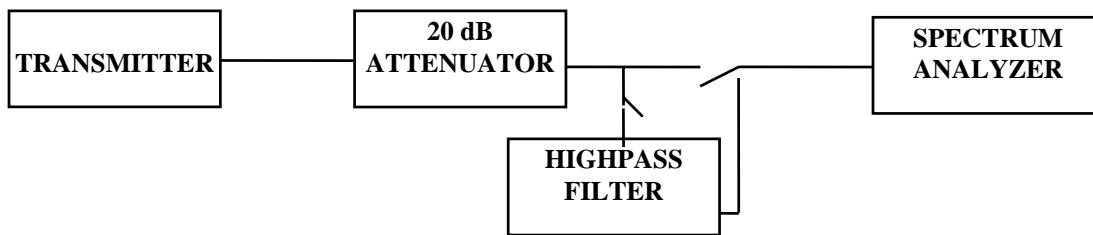

### 6.9.4. Test Equipment List

Test Instruments	Manufacturer	Model No.	Serial No.	Frequency Range
Spectrum Analyzer/ EMI Receiver	Hewlett Packard	HP 8593EM	3412A00103	9 kHz – 26.5 GHz

### 6.9.5. Test Data

**Remark:** Since the RF signal output are exactly identical with different modulations based on our prescans and IEEE 802.1 standard for DSSS, the CCK with 11 Mb/s data rate was chosen for the final tests.

#### 6.9.5.1. Emissions at the band-edges of the FCC Permitted Band

Please refer to Plots # 4 and 5 for detailed measurements of Band-edge emissions at lower and upper permitted band.

### Plot #4: Conducted RF Spurious Emissions at Lower Band-Edge Lowest Carrier Frequency: 2412 MHz

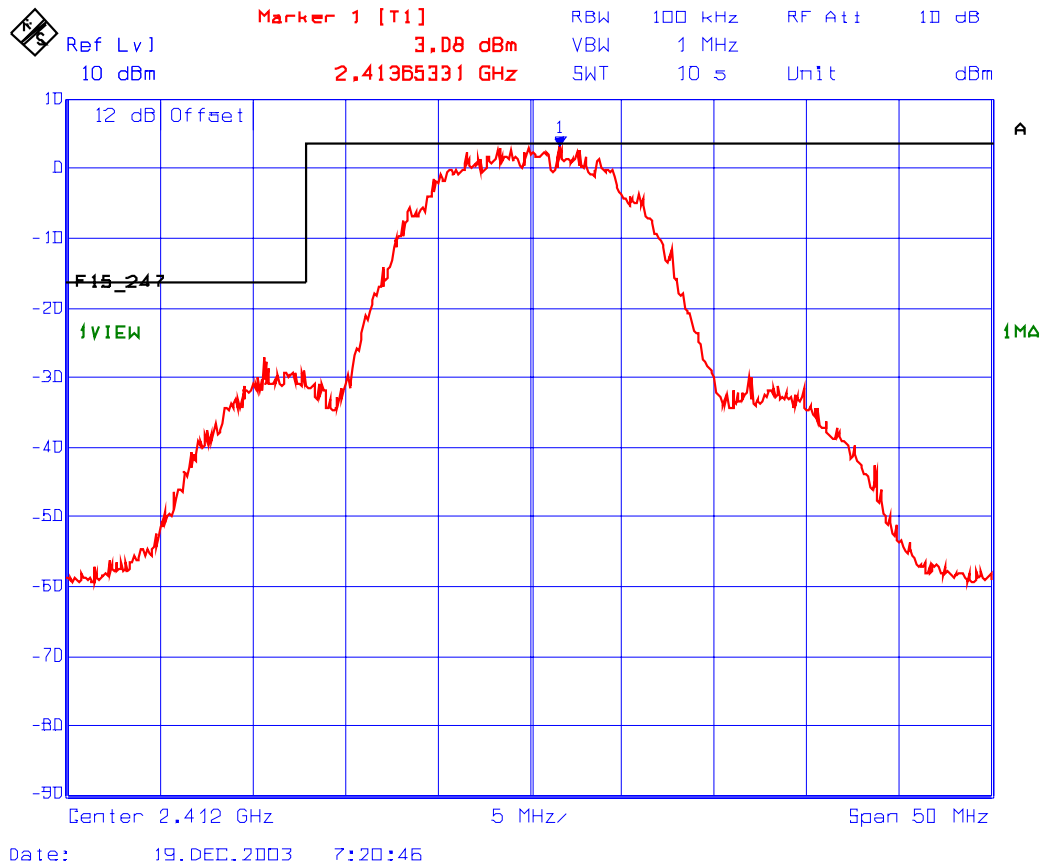

**Plot #5: Conducted RF Spurious Emissions at Lower Band-Edge  
Highest Carrier Frequency: 2462 MHz**

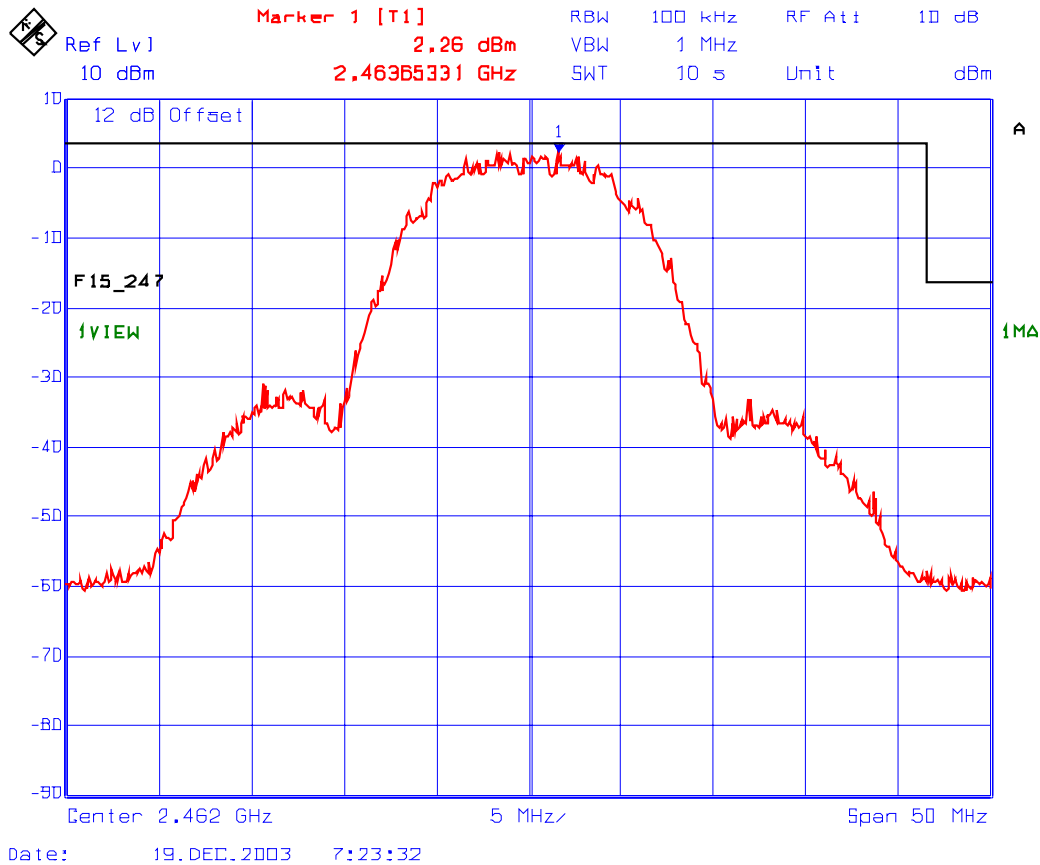

**6.9.5.2. Tx Conducted Emissions at Lowest Frequency (2412 MHz)**

- The emissions were scanned from 10 MHz to 25 GHz . All spurious emissions were found to be more than 30 dB below FCC Limit.
- Refer to Plots # 6 and 7 for detailed measurements.

**6.9.5.3. Tx Conducted Emissions at Middle Frequency (2437 MHz)**

- The emissions were scanned from 10 MHz to 25 GHz . All spurious emissions were found to be more than 30 dB below FCC Limit.
- Refer to Plots # 8 and 9 for detailed measurements.

**6.9.5.4. Tx Conducted Emissions at Highest Frequency (2462 MHz)**

- The emissions were scanned from 10 MHz to 25 GHz . All spurious emissions were found to be more than 30 dB below FCC Limit.
- Refer to Plots # 10 and 11 for detailed measurements.

**Plot #6: Conducted RF Spurious/Harmonic Emissions**  
**Lowest Carrier Frequency: 2412 MHz**

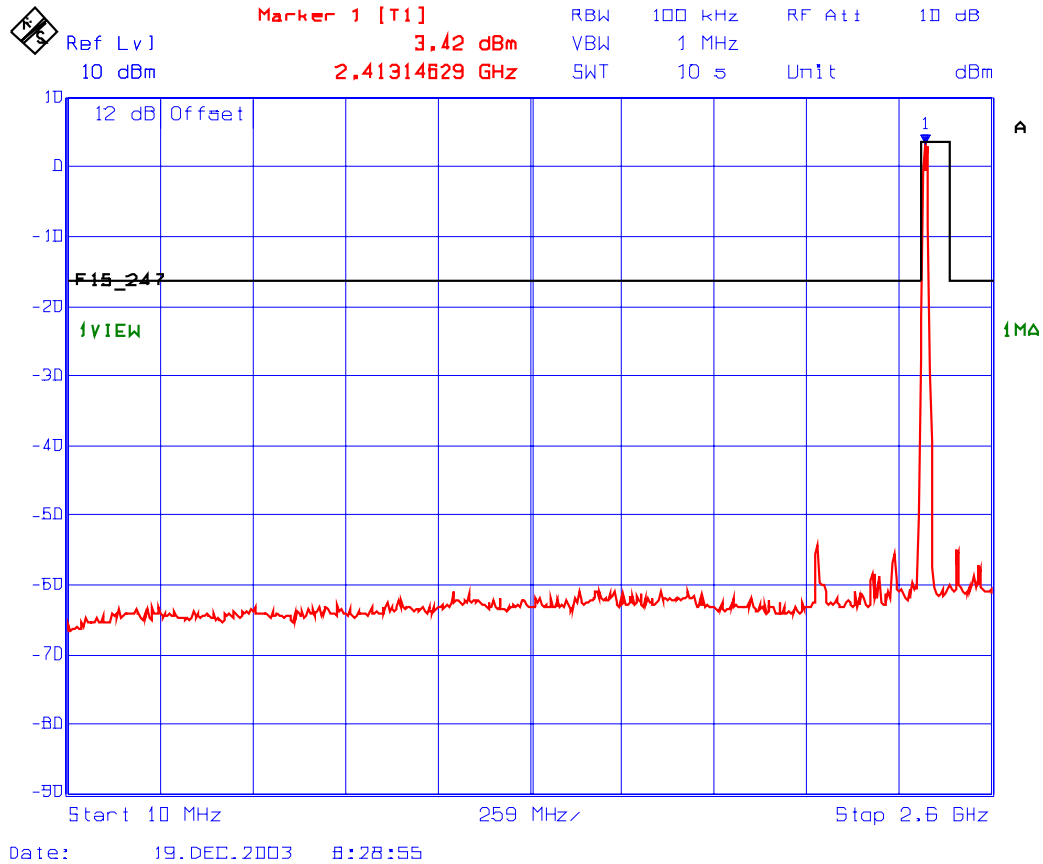

**Plot #7: Conducted RF Spurious/Harmonic Emissions**  
**Lowest Carrier Frequency: 2412 MHz**

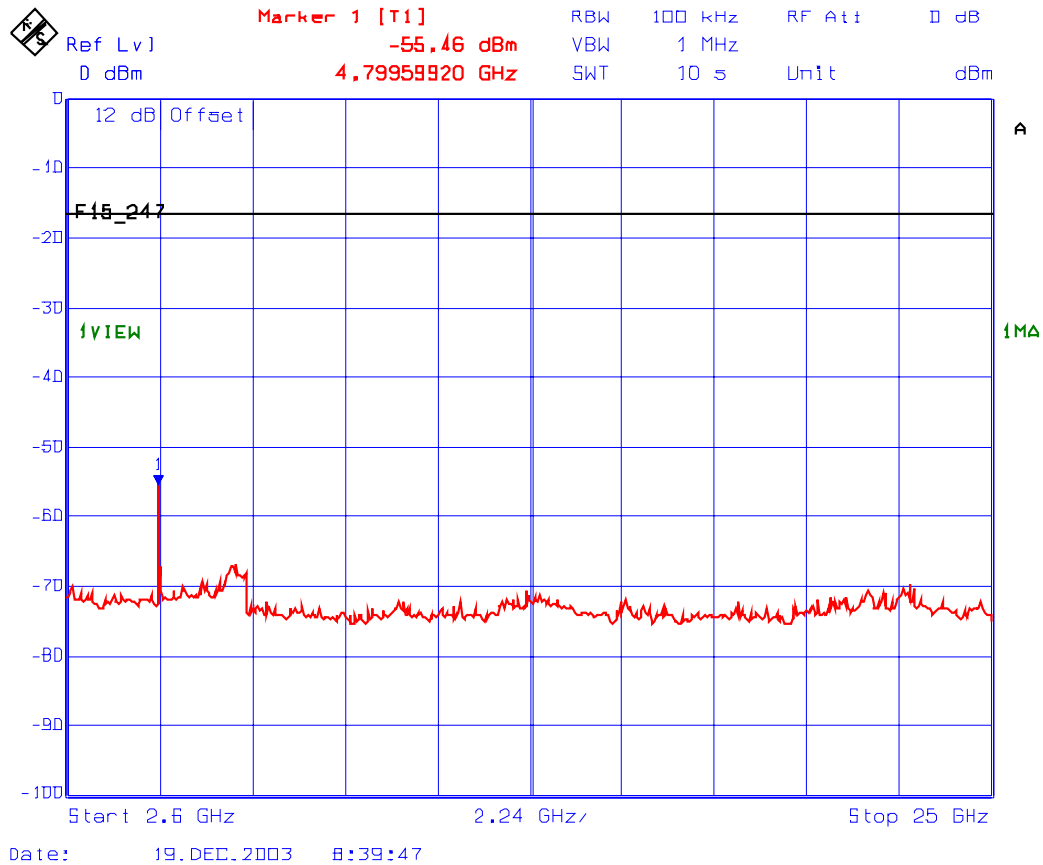

**ULTRATECH GROUP OF LABS**

3000 Bristol Circle, Oakville, Ontario, Canada L6H 6G4  
Tel. #: 905-829-1570, Fax. #: 905-829-8050, Email: [vic@ultratech-labs.com](mailto:vic@ultratech-labs.com), Website: <http://www.ultratech-labs.com>

File #: TEK-437FCC15C  
Jan. 23, 2004

- All test results contained in this engineering test report are traceable to National Institute of Standards and Technology (NIST)

**Plot #8: Conducted RF Spurious/Harmonic Emissions**  
**Middle Carrier Frequency: 2437 MHz**

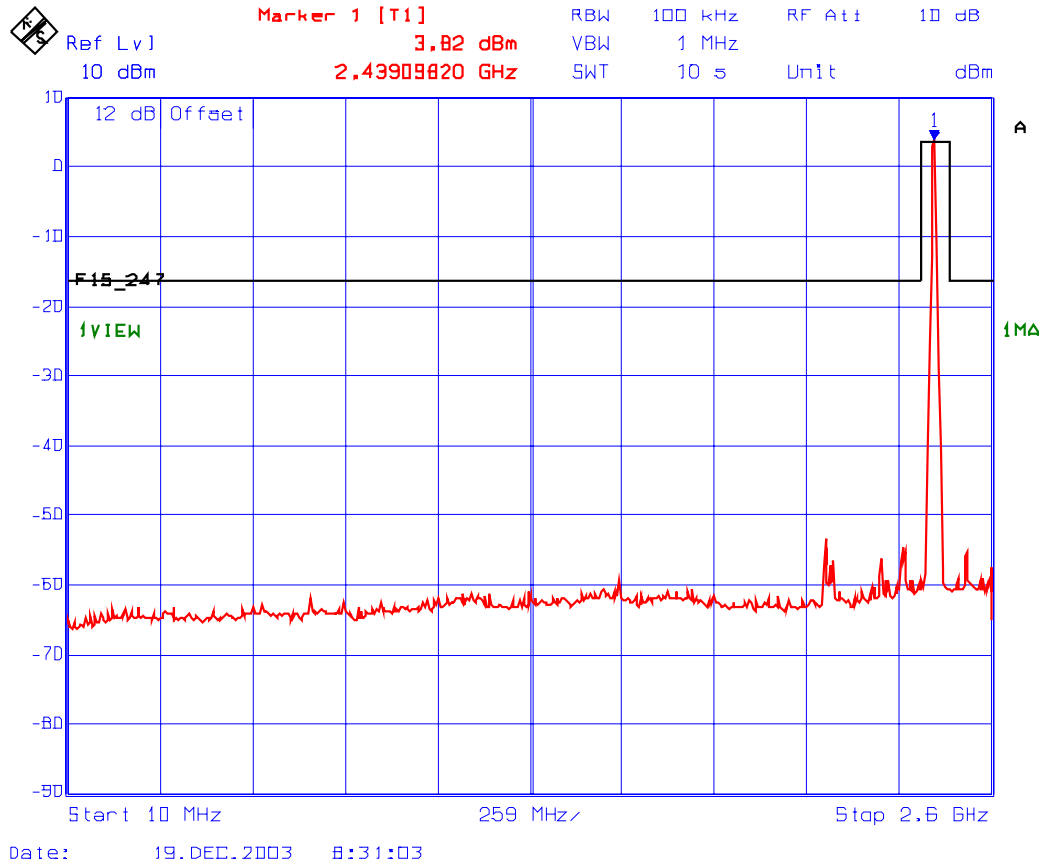

**ULTRATECH GROUP OF LABS**

3000 Bristol Circle, Oakville, Ontario, Canada L6H 6G4  
Tel. #: 905-829-1570, Fax. #: 905-829-8050, Email: [vic@ultratech-labs.com](mailto:vic@ultratech-labs.com), Website: <http://www.ultratech-labs.com>

File #: TEK-437FCC15C  
Jan. 23, 2004

- All test results contained in this engineering test report are traceable to National Institute of Standards and Technology (NIST)

**Plot #9: Conducted RF Spurious/Harmonic Emissions**  
**Middle Carrier Frequency: 2437 MHz**

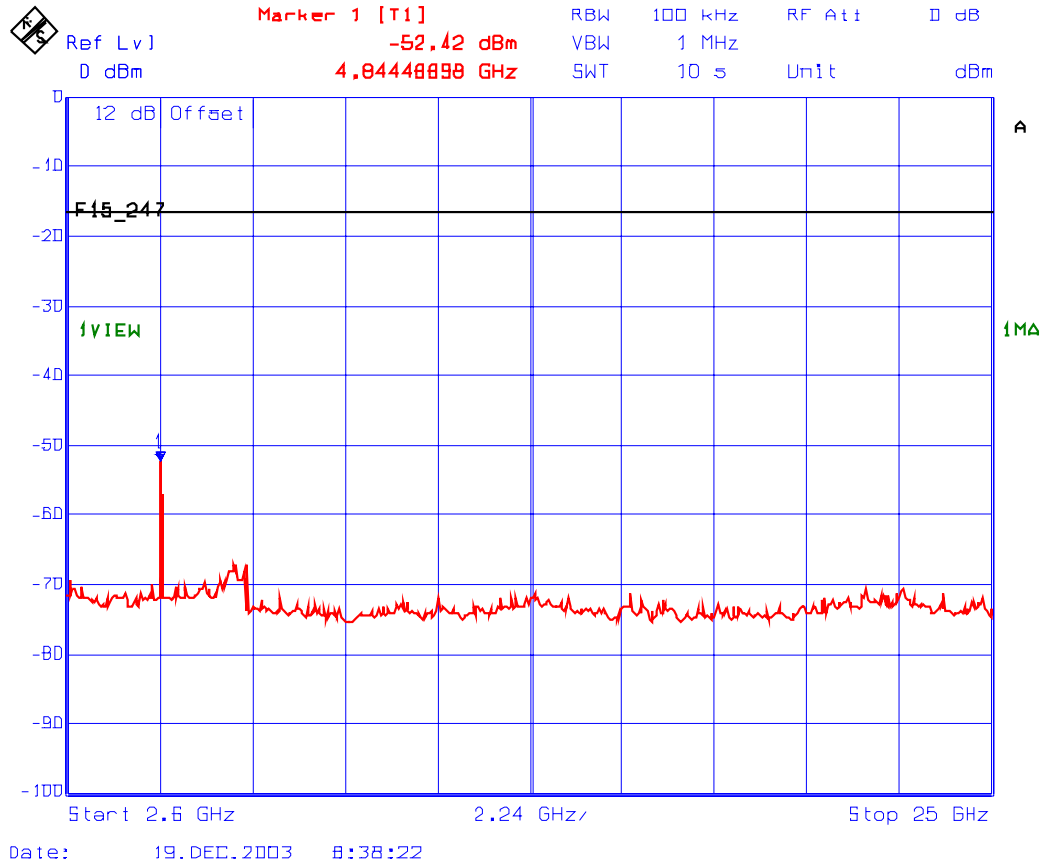



### Plot #10: Conducted RF Spurious/Harmonic Emissions Highest Carrier Frequency: 2462 MHz

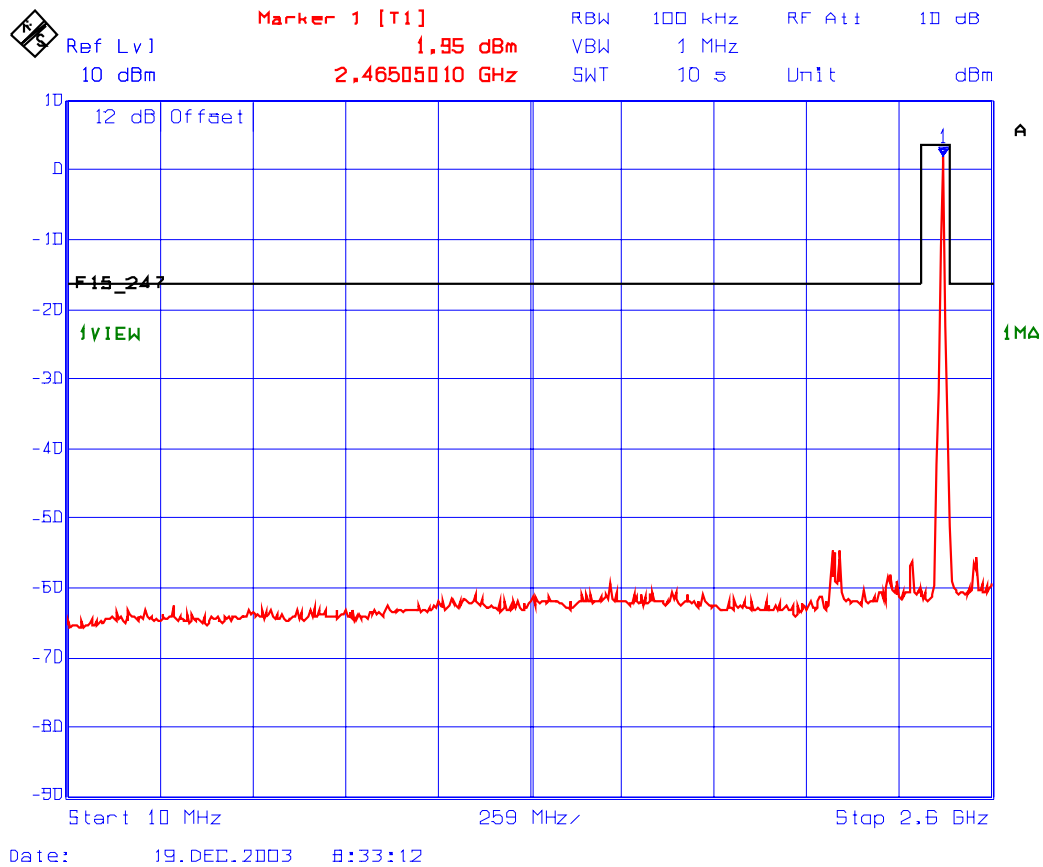

#### ULTRATECH GROUP OF LABS

3000 Bristol Circle, Oakville, Ontario, Canada L6H 6G4  
Tel. #: 905-829-1570, Fax. #: 905-829-8050, Email: [vic@ultratech-labs.com](mailto:vic@ultratech-labs.com), Website: <http://www.ultratech-labs.com>

File #: TEK-437FCC15C  
Jan. 23, 2004

- All test results contained in this engineering test report are traceable to National Institute of Standards and Technology (NIST)



## 6.10. TRANSMITTED POWER DENSITY OF A DIGITAL MODULATION SYSTEM, FCC CFR 47, PARA. 15.247(D)

### 6.10.1. Limits

For a direct sequence system, the transmitted power density average over any 1 second interval shall not be greater than 8 dBm in any 3 KHz bandwidth within this band.

### 6.10.2. Method of Measurements

Refer to Exhibit 8, Sec. 8.5 of this test report for detailed measurement procedures

### 6.10.3. Test Arrangement

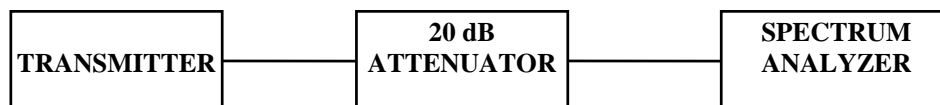

### 6.10.4. Test Equipment List

Test Instruments	Manufacturer	Model No.	Serial No.	Frequency Range
Spectrum Analyzer/ EMI Receiver	Hewlett Packard	HP 8593EM	3412A00103	9 kHz – 26.5 GHz

### 6.10.5. Test Data

CHANNEL FREQUENCY (MHz)	MODULATION DATA RATE	RF POWER LEVEL IN 3 KHz BW (dBm)	LIMIT (dBm)	MARGIN (dB)	COMMENTS (PASS/FAIL)
2412	CCK 11 Mbps	-10.1	8.0	-2.1	PASS
2437	CCK 11 Mbps	-10.4	8.0	-2.4	PASS
2462	CCK 11 Mbps	-8.8	8.0	-0.8	PASS

Refer to Plots # 12 to 14 for Measurement Details.

**Plot #12: Conducted RF Power Spectral Density**  
**Lowest Carrier Frequency: 2412 MHz**

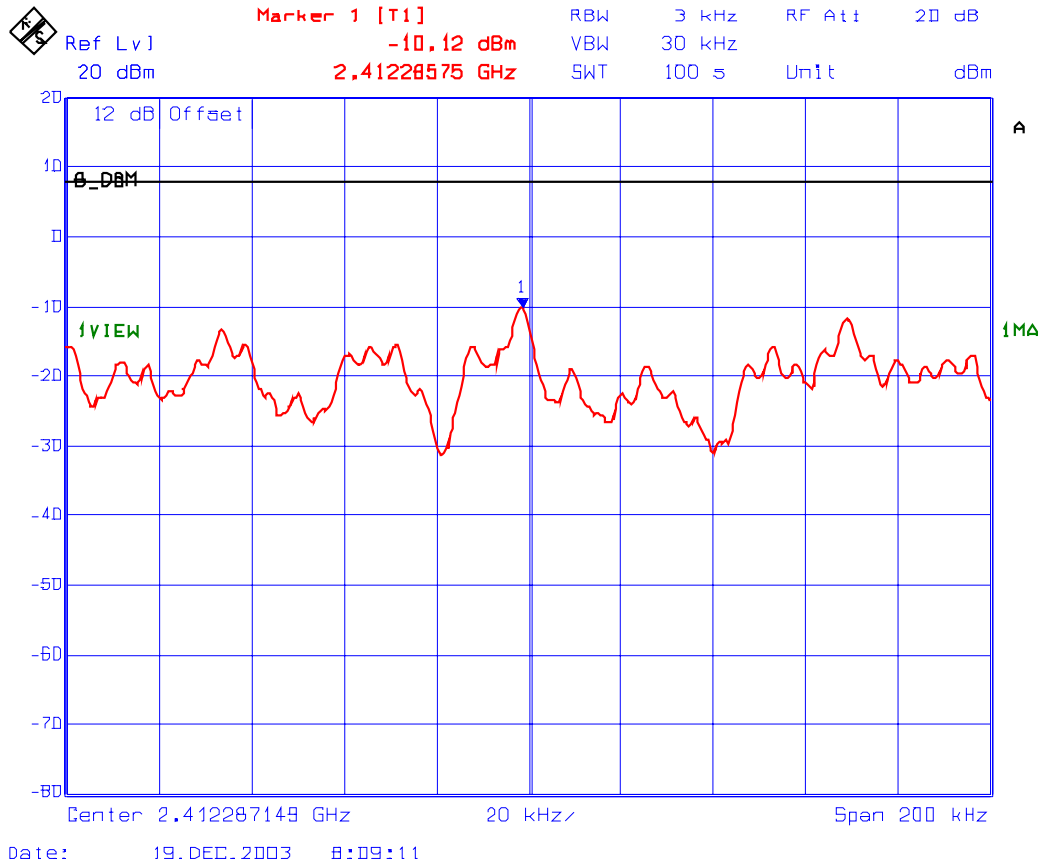

**ULTRATECH GROUP OF LABS**

3000 Bristol Circle, Oakville, Ontario, Canada L6H 6G4  
Tel. #: 905-829-1570, Fax. #: 905-829-8050, Email: [vic@ultratech-labs.com](mailto:vic@ultratech-labs.com), Website: <http://www.ultratech-labs.com>

File #: TEK-437FCC15C  
Jan. 23, 2004

- All test results contained in this engineering test report are traceable to National Institute of Standards and Technology (NIST)

**Plot #13: Conducted RF Power Spectral Density**  
**Middle Carrier Frequency: 2437 MHz**

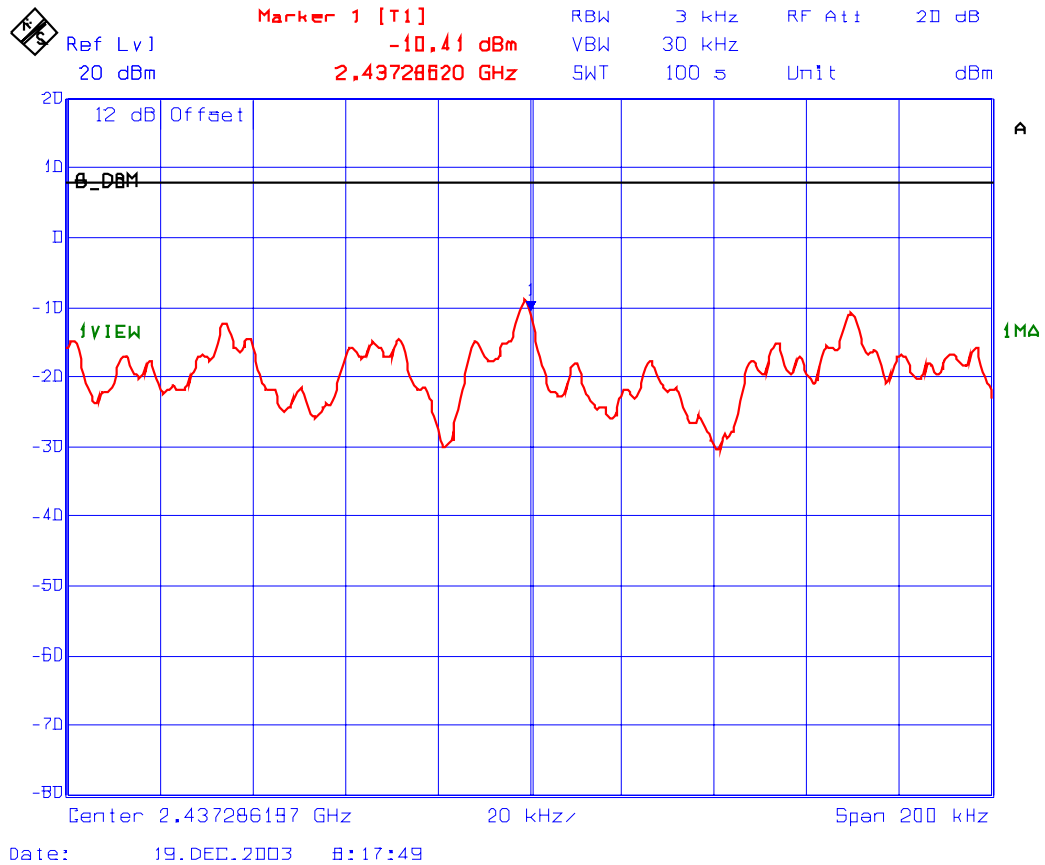

**Plot #14: Conducted RF Power Spectral Density  
Highest Carrier Frequency: 2462 MHz**

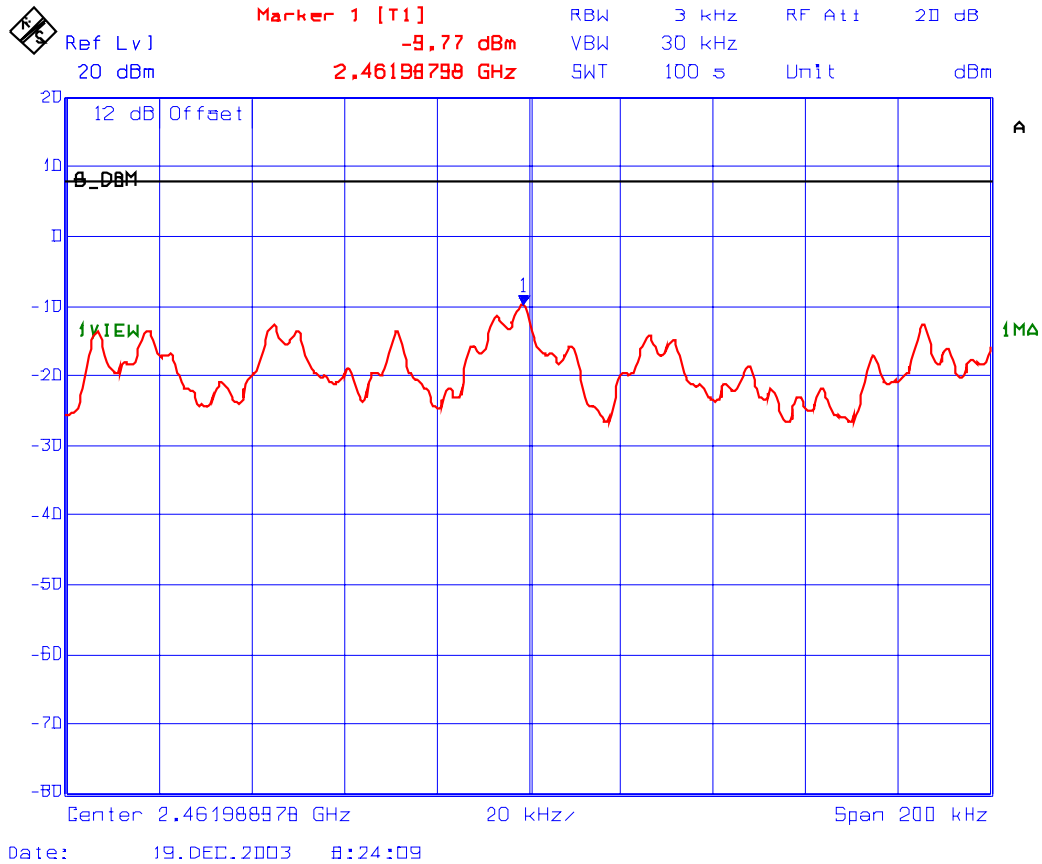

## 6.11. SPURIOUS EMISSIONS (RADIATED @ 3 METERS), FCC CFR 47, PARA. 15.247(C), 15.209 & 15.205

### 6.11.1. Limits

In any 100 KHz bandwidth outside the operating frequency band, the radio frequency power that is produced by modulation products of the spreading sequence, the information sequence and the carrier frequency shall be either at least 20 dB below that in any 100 KHz bandwidth within the band that contains the highest level of the desired power or shall not exceed the general levels specified in @ 15.209(a), which lesser attenuation.

All other emissions inside restricted bands specified in @ 15.205(a) shall not exceed the general radiated emission limits specified in @ 15.209(a)

#### Remarks:

- Applies to harmonics/spurious emissions that fall in the restricted bands listed in Section 15.205. The maximum permitted average field strength is listed in Section 15.209.
- @ FCC CFR 47, Para. 15.237(c) - The emission limits as specified above are based on measurement instrument employing an average detector. The provisions in @15.35 for limiting peak emissions apply.

**FCC CFR 47, Part 15, Subpart C, Para. 15.205(a) - Restricted Frequency Bands**

MHz	MHz	MHz	GHz
0.090 - 0.110	162.0125 - 167.17	2310 - 2390	9.3 - 9.5
0.49 - 0.51	167.72 - 173.2	2483.5 - 2500	10.6 - 12.7
2.1735 - 2.1905	240 - 285	2655 - 2900	13.25 - 13.4
8.362 - 8.366	322 - 335.4	3260 - 3267	14.47 - 14.5
13.36 - 13.41	399.9 - 410	3332 - 3339	14.35 - 16.2
25.5 - 25.67	608 - 614	3345.8 - 3358	17.7 - 21.4
37.5 - 38.25	960 - 1240	3600 - 4400	22.01 - 23.12
73 - 75.4	1300 - 1427	4500 - 5250	23.6 - 24.0
108 - 121.94	1435 - 1626.5	5350 - 5460	31.2 - 31.8
123 - 138	1660 - 1710	7250 - 7750	36.43 - 36.5
149.9 - 150.05	1718.8 - 1722.2	8025 - 8500	Above 38.6
156.7 - 156.9	2200 - 2300	9000 - 9200	

**FCC CFR 47, Part 15, Subpart C, Para. 15.209(a)  
 -- Field Strength Limits within Restricted Frequency Bands --**

FREQUENCY (MHz)	FIELD STRENGTH LIMITS (microvolts/m)	DISTANCE (Meters)
0.009 - 0.490	2,400 / F (KHz)	300
0.490 - 1.705	24,000 / F (KHz)	30
1.705 - 30.0	30	30
30 - 88	100	3
88 - 216	150	3
216 - 960	200	3
Above 960	500	3



### 6.11.2. Method of Measurements

Refer to Exhibit 8, Sec. 8.4 of this test report and ANSI 63.4-1992, Para. 8 for detailed radiated emissions measurement procedures.

The following measurement procedures were also applied:

- Applies to harmonics/spurious that fall in the restricted bands listed in Section 15.205. the maximum permitted average field strength is listed in Section 15.209. A Pre-Amp and highpass filter are used for this measurement.
- For measurement below 1 GHz, set RBW = 100 KHz, VBW  $\geq$  100 KHz, SWEEP=AUTO.
- For measurement above 1 GHz, set RBW = 1 MHz, VBW = 1 MHz (Peak) & VBW = 10 Hz (Average), SWEEP=AUTO.
- If the emission is pulsed, modified the unit for continuous operation, then use the settings above for measurements, then correct the reading by subtracting the peak-average correction factor derived from the appropriate duty cycle calculation. See Section 15.35(b) and (c).

### 6.11.3. Test Arrangement

Please refer to Test Arrangement in Sec. 5.5.3 for details of test setup for emission measurements.

### 6.11.4. Test Equipment List

Test Instruments	Manufacturer	Model No.	Serial No.	Frequency Range
Spectrum Analyzer/ EMI Receiver	Advantest	R3271	15050203	100 Hz to 32 GHz with external mixer for frequency above 32 GHz
Microwave Amplifier	Hewlett Packard	HP 83017A		1 GHz to 26.5 GHz
Biconilog Antenna	EMCO	3143	1029	20 MHz to 2 GHz
Horn Antenna	EMCO	3155	9701-5061	1 GHz – 18 GHz
Highpass Filter	K&L	11SH10-1500-T8000	--	Cut-off at 1500 MHz used for 902-928 MHz Radio
Highpass Filter	Michael Lab	XD40N	--	Cut-off at 4 GHz used for 2.4-2.4835 GHz

### 6.11.5. Test Data

**Remark:** Since the RF signal output are exactly identical with different modulations based on our prescans and IEEE 802.1 standard for DSSS, the CCK with 11 Mb/s data rate was chosen for the final tests.

**6.11.5.1. Transmitter Spurious Emissions Measurements with Centurion Antenna, Model No.: EXE-2400-SMRP, Gain: 2 dBi.**

**Photographs of Test Setup:** Please refer to Photos # 1 & 2 in Annex 1.

**6.11.5.1.1. Lowest Frequency (2412 MHz)**

Frequency (MHz)	RF Peak Level (dBµV/m)	RF Avg Level (dBµV/m)	Antenna Plane (H/V)	Limit 15.209 (dBµV/m)	Limit 15.247 (dBµV/m)	Margin (dB)	Pass/Fail
2412.00	107.4	--	V	--	--	--	PASS
2412.00	111.8	--	H	--	--	--	PASS
4824.00	46.1	40.1	V	54.0	91.8	-13.9	*PASS
4824.00	43.8	37.4	H	54.0	91.8	-16.5	*PASS
<ul style="list-style-type: none"> <li>The emissions were scanned from 10 MHz to 25 GHz and all emissions less 20 dB below the limits were recorded.</li> <li>Please refer to Plot # 15 and 16 for Band-Edge Radiated Emissions measured at 3 meters.</li> </ul>							

\* Frequency in restricted bands, therefore FCC 15.209 limit applied.

**6.11.5.1.2. Middle Frequency (2437 MHz)**

Frequency (MHz)	RF Peak Level (dBµV/m)	RF Avg Level (dBµV/m)	Antenna Plane (H/V)	Limit 15.209 (dBµV/m)	Limit 15.247 (dBµV/m)	Margin (dB)	Pass/Fail
2437.00	109.1	--	V	--	--	--	PASS
2437.00	112.6	--	H	--	--	--	PASS
4874.00	50.9	43.6	V	54.0	92.6	-10.4	*PASS
4874.00	48.6	44.7	H	54.0	92.6	-9.3	*PASS
The emissions were scanned from 10 MHz to 25 GHz and all emissions less 20 dB below the limits were recorded.							

\* Frequency in restricted bands, therefore FCC 15.209 limit applied.

**6.11.5.1.3. Highest Frequency (2462 MHz)**

Frequency (MHz)	RF Peak Level (dBµV/m)	RF Avg Level (dBµV/m)	Antenna Plane (H/V)	Limit 15.209 (dBµV/m)	Limit 15.247 (dBµV/m)	Margin (dB)	Pass/Fail
2437.00	109.0	--	V	--	--	--	PASS
2437.00	110.4	--	H	--	--	--	PASS
4874.00	48.8	44.3	V	54.0	90.4	-9.7	*PASS
4874.00	48.0	45.3	H	54.0	90.4	-8.7	*PASS
<ul style="list-style-type: none"> <li>The emissions were scanned from 10 MHz to 25 GHz and all emissions less 20 dB below the limits were recorded.</li> <li>Please refer to Plot # 17 and 18 for Band-Edge Radiated Emissions measured at 3 meters.</li> </ul>							

\* Frequency in restricted bands, therefore FCC 15.209 limit applied.

**Plot #15: Transmitter Band-Edge Radiated Emissions  
@ 3 Meters (Horizontal Polarization)**

Antenna tested: Centurion Antenna, Model No.: EXE-2400-SMRP, Gain: 2 dBi

Frequency: 2412 MHz, Delta Trace 1 & Trace 2: 7.42 dB

Trace 1: RBW= 1 MHz, VBW= 3 MHz

Trace 2: RBW= 100 kHz, VBW= 1 MHz

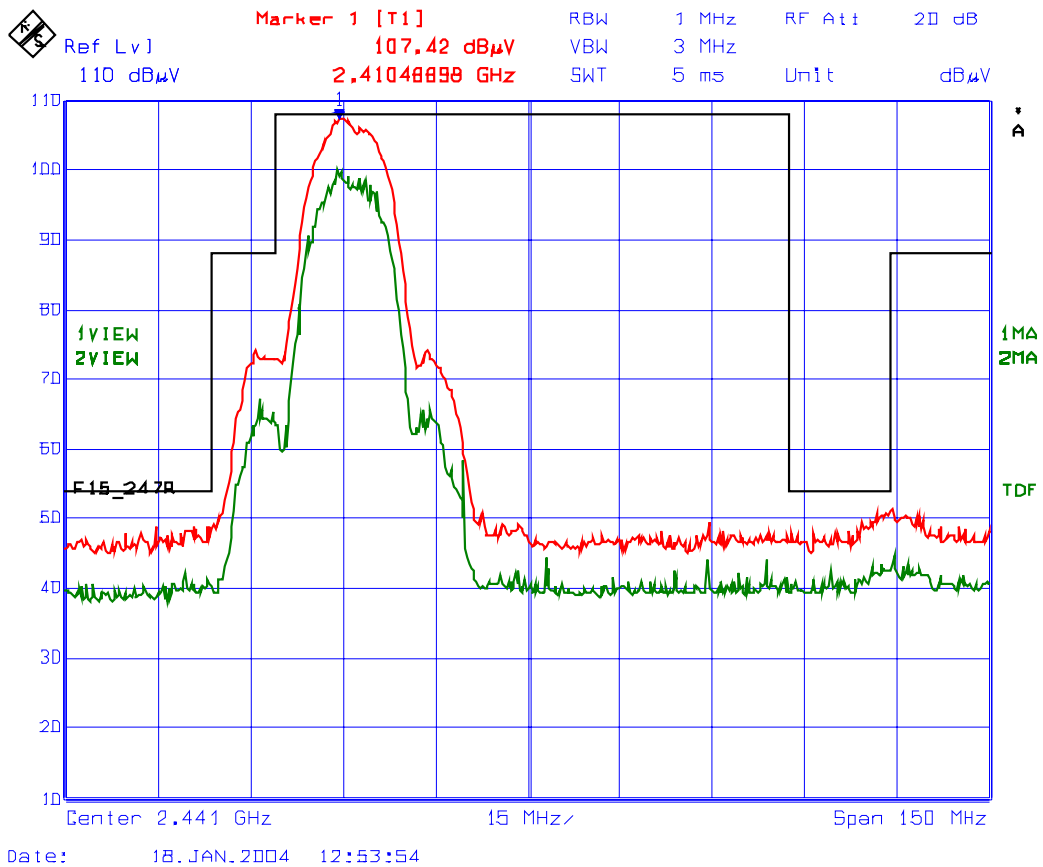

**Plot #16: Transmitter Band-Edge Radiated Emissions  
@ 3 Meters (Vertical Polarization)**  
Antenna tested: Centurion Antenna, Model No.: EXE-2400-SMRP, Gain: 2 dBi

Frequency: 2412 MHz, Delta Trace 1 & Trace 2: 7.15 dB  
Trace 1: RBW= 1 MHz, VBW= 3 MHz  
Trace 2: RBW= 100 kHz, VBW= 1 MHz

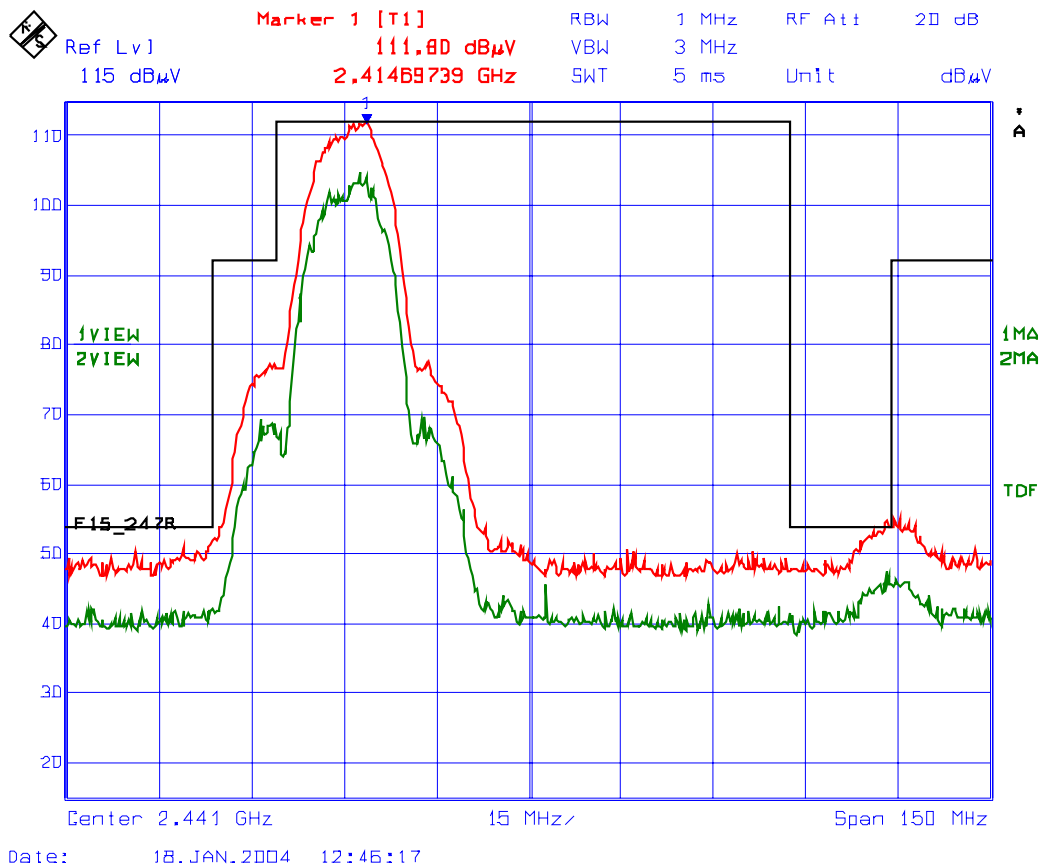

• All test results contained in this engineering test report are traceable to National Institute of Standards and Technology (NIST)

**Plot #17: Transmitter Band-Edge Radiated Emissions  
@ 3 Meters (Horizontal Polarization)**

Antenna tested: Centurion Antenna, Model No.: EXE-2400-SMRP, Gain: 2 dBi

Frequency: 2462 MHz, Delta Trace 1 & Trace 2: 8.11 dB

Trace 1: RBW= 1 MHz, VBW= 3 MHz

Trace 2: RBW= 100 kHz, VBW= 1 MHz

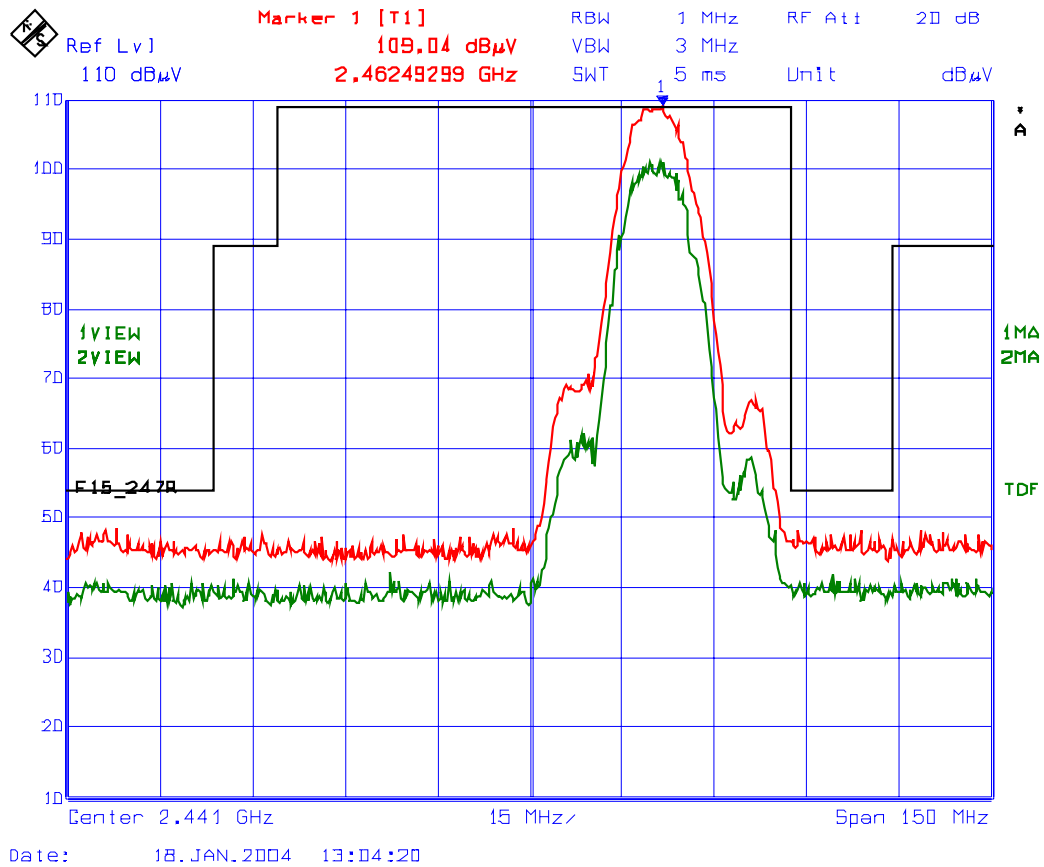

**Plot #18: Transmitter Band-Edge Radiated Emissions  
@ 3 Meters (Vertical Polarization)**  
Antenna tested: Centurion Antenna, Model No.: EXE-2400-SMRP, Gain: 2 dBi

Frequency: 2462 MHz, Delta Trace 1 & Trace 2: 7.82 dB  
Trace 1: RBW= 1 MHz, VBW= 3 MHz  
Trace 2: RBW= 100 kHz, VBW= 1 MHz

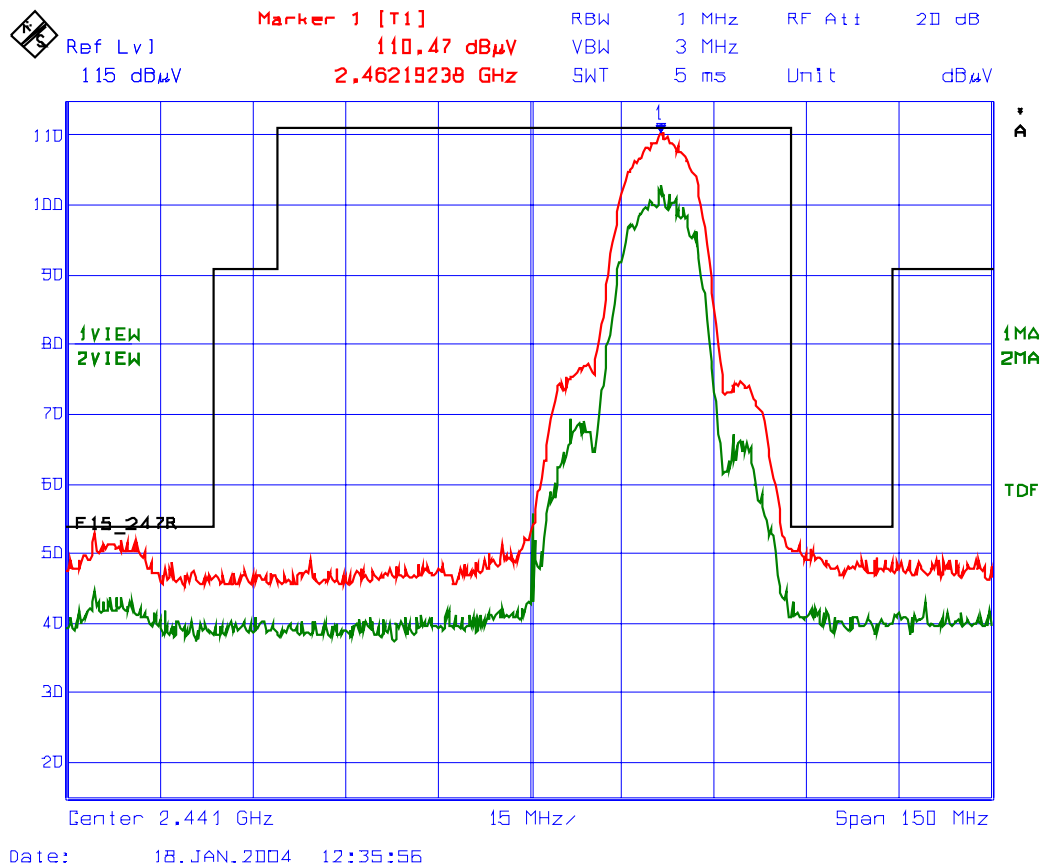

**6.11.5.2. Transmitter Spurious Emissions Measurements with Mobile Mark Antenna, Model No.: IMAG5-2400, Gain: 5.0 dBi.**

**Photographs of Test Setup:** Please refer to Photos # 3 & 4 in Annex 1.

6.11.5.2.1. Lowest Frequency (2412 MHz)

Frequency (MHz)	RF Peak Level (dBµV/m)	RF Avg Level (dBµV/m)	Antenna Plane (H/V)	Limit 15.209 (dBµV/m)	Limit 15.247 (dBµV/m)	Margin (dB)	Pass/Fail
2412.00	111.2	--	V	--	--	--	PASS
2412.00	109.7	--	H	--	--	--	PASS
4824.00	45.4	36.4	V	54.0	91.2	-17.6	*PASS
4824.00	45.2	33.8	H	54.0	91.2	-20.5	*PASS
<ul style="list-style-type: none"> <li>The emissions were scanned from 10 MHz to 25 GHz and all emissions less 20 dB below the limits were recorded.</li> <li>Please refer to Plot # 19 and 20 for Band-Edge Radiated Emissions measured at 3 meters.</li> </ul>							

\* Frequency in restricted bands, therefore FCC 15.209 limit applied.

6.11.5.2.2. Middle Frequency (2437 MHz)

Frequency (MHz)	RF Peak Level (dBµV/m)	RF Avg Level (dBµV/m)	Antenna Plane (H/V)	Limit 15.209 (dBµV/m)	Limit 15.247 (dBµV/m)	Margin (dB)	Pass/Fail
2437.00	112.5	--	V	--	--	--	PASS
2437.00	111.9	--	H	--	--	--	PASS
4874.00	48.6	40.4	V	54.0	92.5	-13.6	*PASS
4874.00	61.7	48.7	H	54.0	92.5	-5.3	*PASS
The emissions were scanned from 10 MHz to 25 GHz and all emissions less 20 dB below the limits were recorded.							

\* Frequency in restricted bands, therefore FCC 15.209 limit applied.

6.11.5.2.3. Highest Frequency (2462 MHz)

Frequency (MHz)	RF Peak Level (dBµV/m)	RF Avg Level (dBµV/m)	Antenna Plane (H/V)	Limit 15.209 (dBµV/m)	Limit 15.247 (dBµV/m)	Margin (dB)	Pass/Fail
2437.00	109.7	--	V	--	--	--	PASS
2437.00	110.6	--	H	--	--	--	PASS
4874.00	47.0	40.1	V	54.0	90.6	-13.9	*PASS
4874.00	51.6	44.2	H	54.0	90.6	-9.8	*PASS
<ul style="list-style-type: none"> <li>The emissions were scanned from 10 MHz to 25 GHz and all emissions less 20 dB below the limits were recorded.</li> <li>Please refer to Plot # 21 and 22 for Band-Edge Radiated Emissions measured at 3 meters.</li> </ul>							

\* Frequency in restricted bands, therefore FCC 15.209 limit applied.

**Plot #19: Transmitter Band-Edge Radiated Emissions  
@ 3 Meters (Horizontal Polarization)**

**Antenna tested:** Mobile Mark Antenna, Model No.: IMAG5-2400, Gain: 5.0 dBi

**Frequency: 2412 MHz, Delta Trace 1 & Trace 2: 7.48 dB**

**Trace 1: RBW= 1 MHz, VBW= 3 MHz**

**Trace 2: RBW= 100 kHz, VBW= 1 MHz**

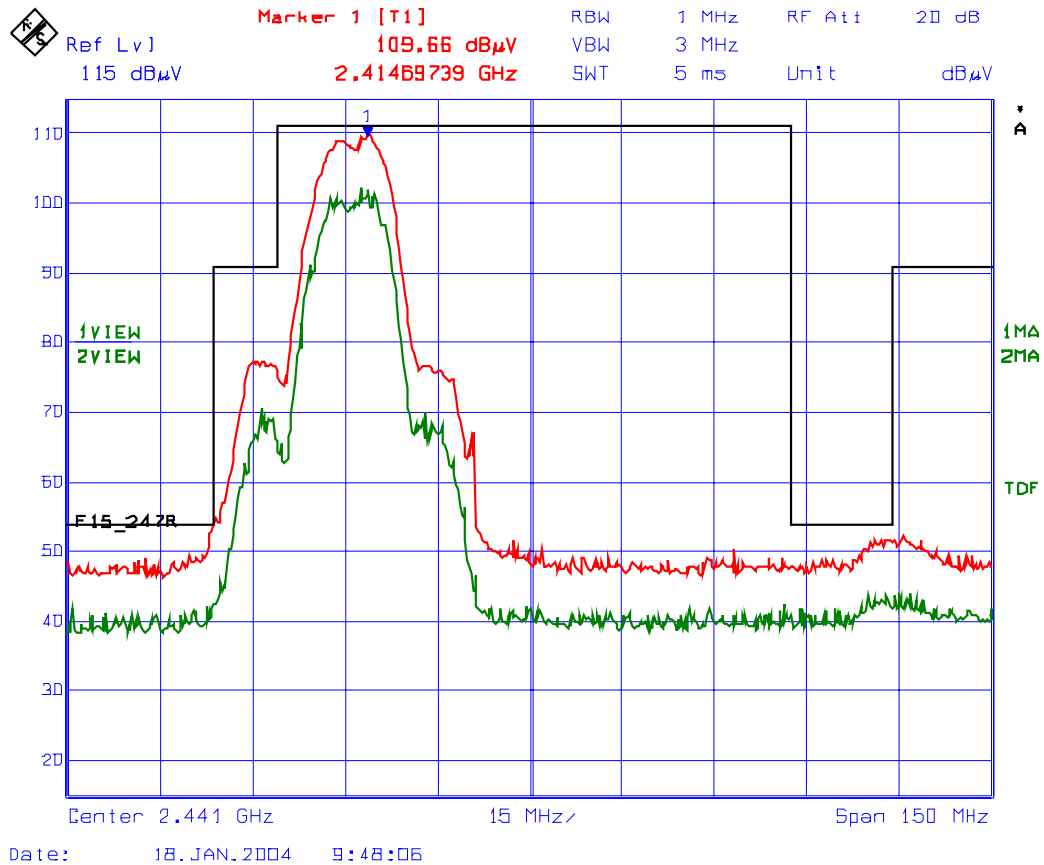



**Plot #20: Transmitter Band-Edge Radiated Emissions  
@ 3 Meters (Vertical Polarization)**

Antenna tested: Mobile Mark Antenna, Model No.: IMAG5-2400, Gain: 5.0 dBi

Frequency: 2412 MHz, Delta Trace 1 & Trace 2: 7.93 dB

Trace 1: RBW= 1 MHz, VBW= 3 MHz

Trace 2: RBW= 100 kHz, VBW= 1 MHz

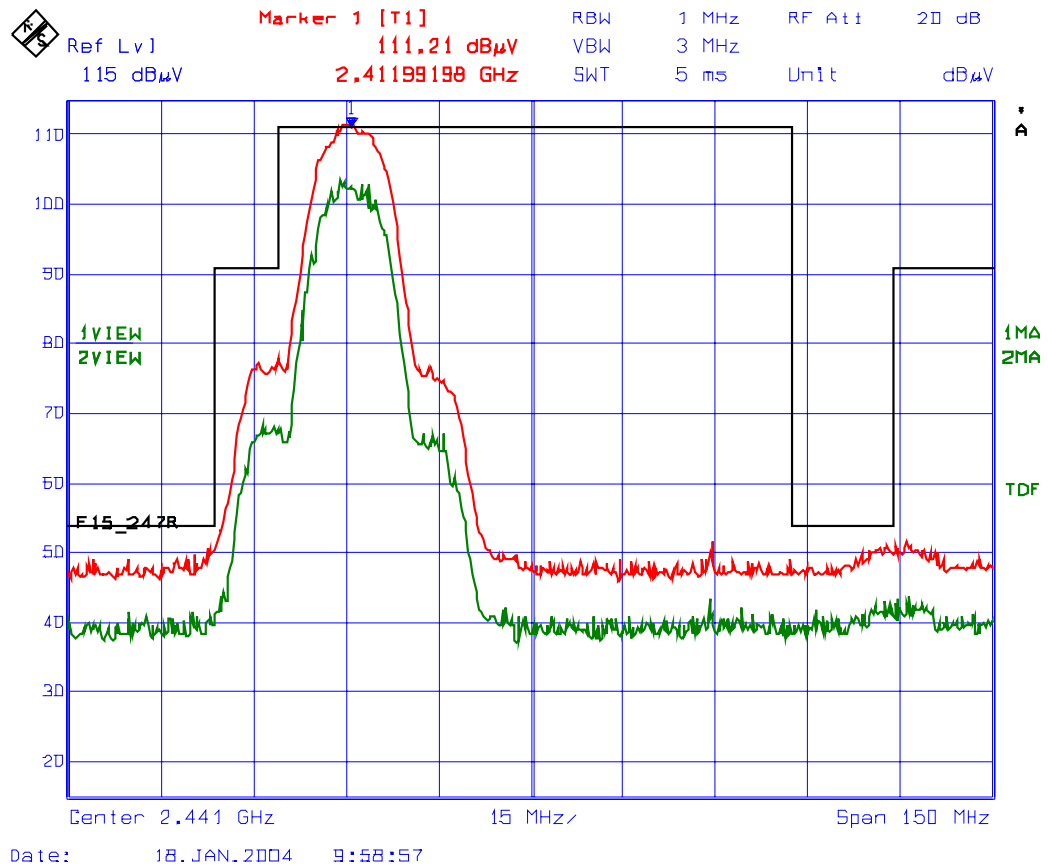

**ULTRATECH GROUP OF LABS**

3000 Bristol Circle, Oakville, Ontario, Canada L6H 6G4  
Tel. #: 905-829-1570, Fax. #: 905-829-8050, Email: [vic@ultratech-labs.com](mailto:vic@ultratech-labs.com), Website: <http://www.ultratech-labs.com>

File #: TEK-437FCC15C

Jan. 23, 2004

- All test results contained in this engineering test report are traceable to National Institute of Standards and Technology (NIST)

**Plot #21: Transmitter Band-Edge Radiated Emissions  
@ 3 Meters (Horizontal Polarization)**

**Antenna tested:** Mobile Mark Antenna, Model No.: IMAG5-2400, Gain: 5.0 dBi

**Frequency: 2462 MHz, Delta Trace 1 & Trace 2: 7.63 dB**

**Trace 1: RBW= 1 MHz, VBW= 3 MHz**

**Trace 2: RBW= 100 kHz, VBW= 1 MHz**

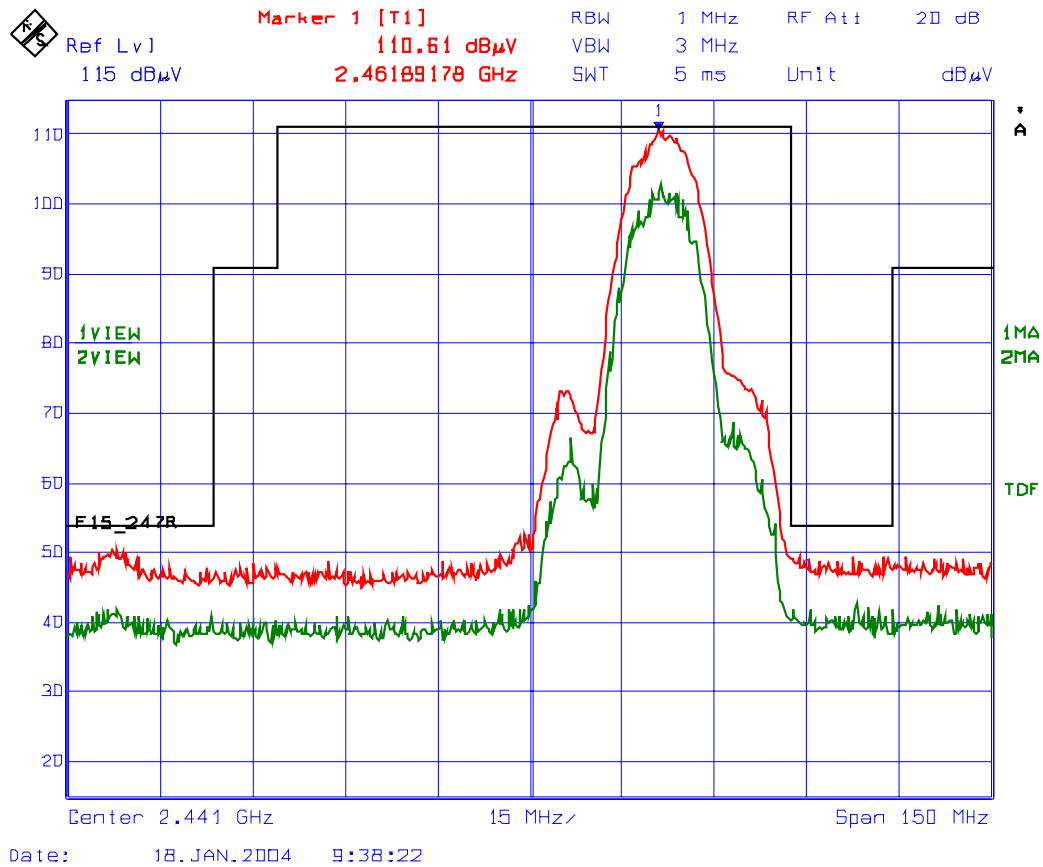

**Plot #22: Transmitter Band-Edge Radiated Emissions  
@ 3 Meters (Vertical Polarization)**

**Antenna tested:** Mobile Mark Antenna, Model No.: IMAG5-2400, Gain: 5.0 dBi

**Frequency: 2462 MHz, Delta Trace 1 & Trace 2: 7.16 dB**

**Trace 1: RBW= 1 MHz, VBW= 3 MHz**

**Trace 2: RBW= 100 kHz, VBW= 1 MHz**

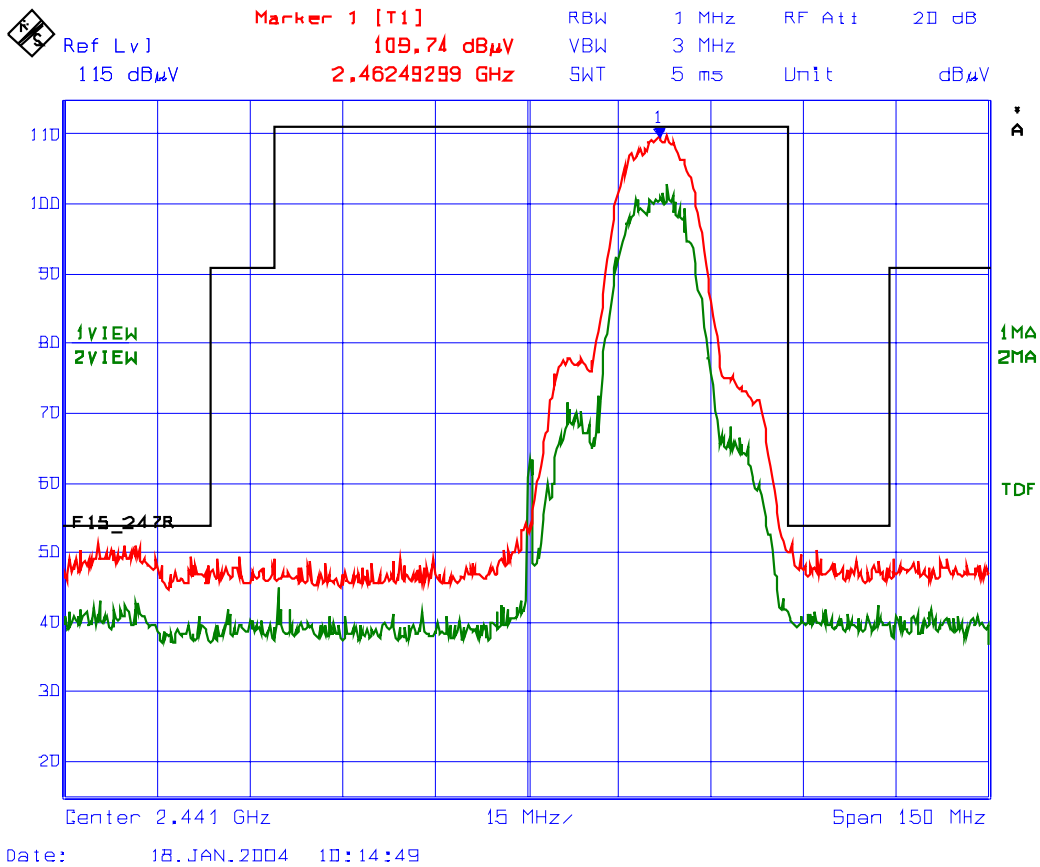

**ULTRATECH GROUP OF LABS**

3000 Bristol Circle, Oakville, Ontario, Canada L6H 6G4  
Tel. #: 905-829-1570, Fax. #: 905-829-8050, Email: [vic@ultratech-labs.com](mailto:vic@ultratech-labs.com), Website: <http://www.ultratech-labs.com>

File #: TEK-437FCC15C  
Jan. 23, 2004

- All test results contained in this engineering test report are traceable to National Institute of Standards and Technology (NIST)

**6.11.5.3. Transmitter Spurious Emissions Measurements with Cushcraft Antenna, Model No.: S2403BP12NF, Gain: 5.2 dBi.**

**Photographs of Test Setup:** Please refer to Photos # 5 & 6 in Annex 1.

6.11.5.3.1. Lowest Frequency (2412 MHz)

Frequency (MHz)	RF Peak Level (dBµV/m)	RF Avg Level (dBµV/m)	Antenna Plane (H/V)	Limit 15.209 (dBµV/m)	Limit 15.247 (dBµV/m)	Margin (dB)	Pass/Fail
2412.00	111.5	--	V	--	--	--	PASS
2412.00	112.5	--	H	--	--	--	PASS
4824.00	59.1	45.9	V	54.0	92.5	-8.1	*PASS
4824.00	56.3	42.8	H	54.0	92.5	-11.2	*PASS
<ul style="list-style-type: none"> <li>The emissions were scanned from 10 MHz to 25 GHz and all emissions less 20 dB below the limits were recorded.</li> <li>Please refer to Plot # 23 and 24 for Band-Edge Radiated Emissions measured at 3 meters.</li> </ul>							

\* Frequency in restricted bands, therefore FCC 15.209 limit applied.

6.11.5.3.2. Middle Frequency (2437 MHz)

Frequency (MHz)	RF Peak Level (dBµV/m)	RF Avg Level (dBµV/m)	Antenna Plane (H/V)	Limit 15.209 (dBµV/m)	Limit 15.247 (dBµV/m)	Margin (dB)	Pass/Fail
2437.00	112.1	--	V	--	--	--	PASS
2437.00	111.9	--	H	--	--	--	PASS
4874.00	57.1	44.0	V	54.0	92.1	-10.0	*PASS
4874.00	62.2	48.0	H	54.0	92.1	-6.0	*PASS
The emissions were scanned from 10 MHz to 25 GHz and all emissions less 20 dB below the limits were recorded.							

\* Frequency in restricted bands, therefore FCC 15.209 limit applied.

6.11.5.3.3. Highest Frequency (2462 MHz)

Frequency (MHz)	RF Peak Level (dBµV/m)	RF Avg Level (dBµV/m)	Antenna Plane (H/V)	Limit 15.209 (dBµV/m)	Limit 15.247 (dBµV/m)	Margin (dB)	Pass/Fail
2437.00	112.0	--	V	--	--	--	PASS
2437.00	111.3	--	H	--	--	--	PASS
4874.00	55.0	40.8	V	54.0	92.0	-13.2	*PASS
4874.00	54.8	41.5	H	54.0	92.0	-12.5	*PASS
<ul style="list-style-type: none"> <li>The emissions were scanned from 10 MHz to 25 GHz and all emissions less 20 dB below the limits were recorded.</li> <li>Please refer to Plot # 25 and 26 for Band-Edge Radiated Emissions measured at 3 meters.</li> </ul>							

\* Frequency in restricted bands, therefore FCC 15.209 limit applied.

**Plot #23: Transmitter Band-Edge Radiated Emissions  
@ 3 Meters (Horizontal Polarization)**

**Antenna tested:** Cushcraft Antenna, Model No.: S2403BP12NF, Gain: 5.2 dBi

**Frequency: 2412 MHz, Delta Trace 1 & Trace 2: 7.38 dB**

**Trace 1: RBW= 1 MHz, VBW= 3 MHz**

**Trace 2: RBW= 100 kHz, VBW= 1 MHz**

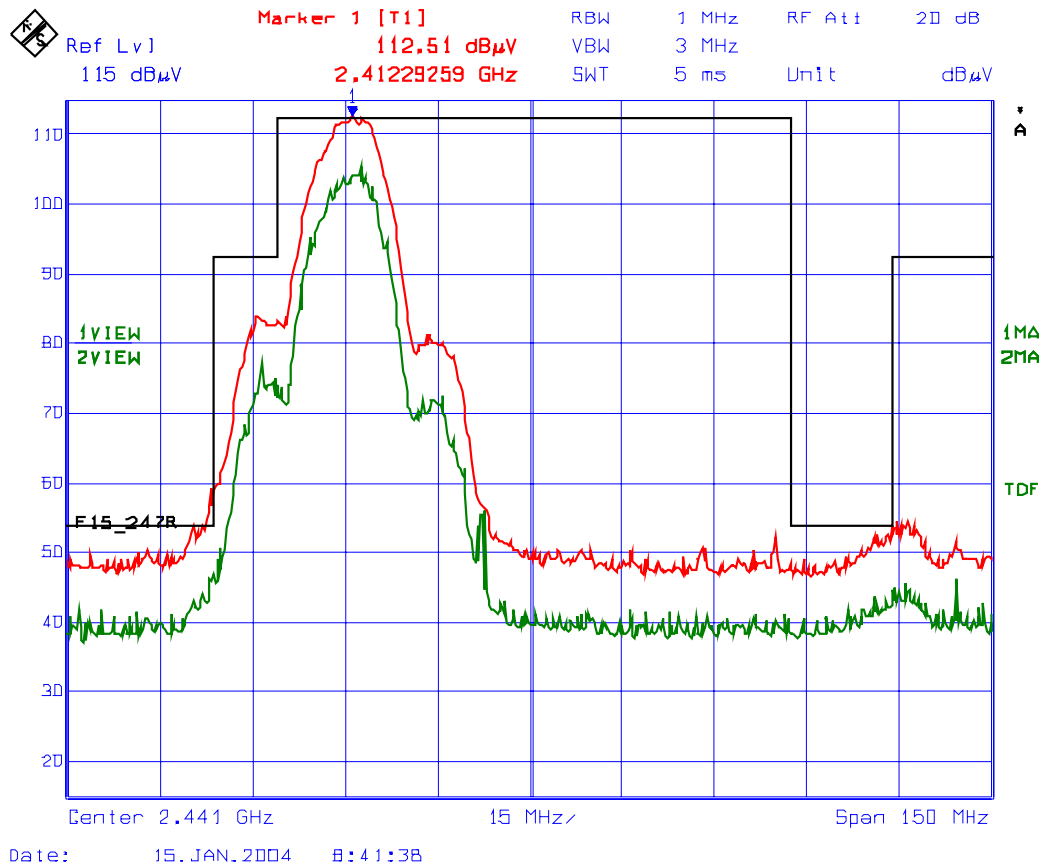

**Plot #24: Transmitter Band-Edge Radiated Emissions  
@ 3 Meters (Vertical Polarization)**

**Antenna tested:** Cushcraft Antenna, Model No.: S2403BP12NF, Gain: 5.2 dBi

**Frequency: 2412 MHz, Delta Trace 1 & Trace 2: 8.08 dB**

**Trace 1: RBW= 1 MHz, VBW= 3 MHz**

**Trace 2: RBW= 100 kHz, VBW= 1 MHz**

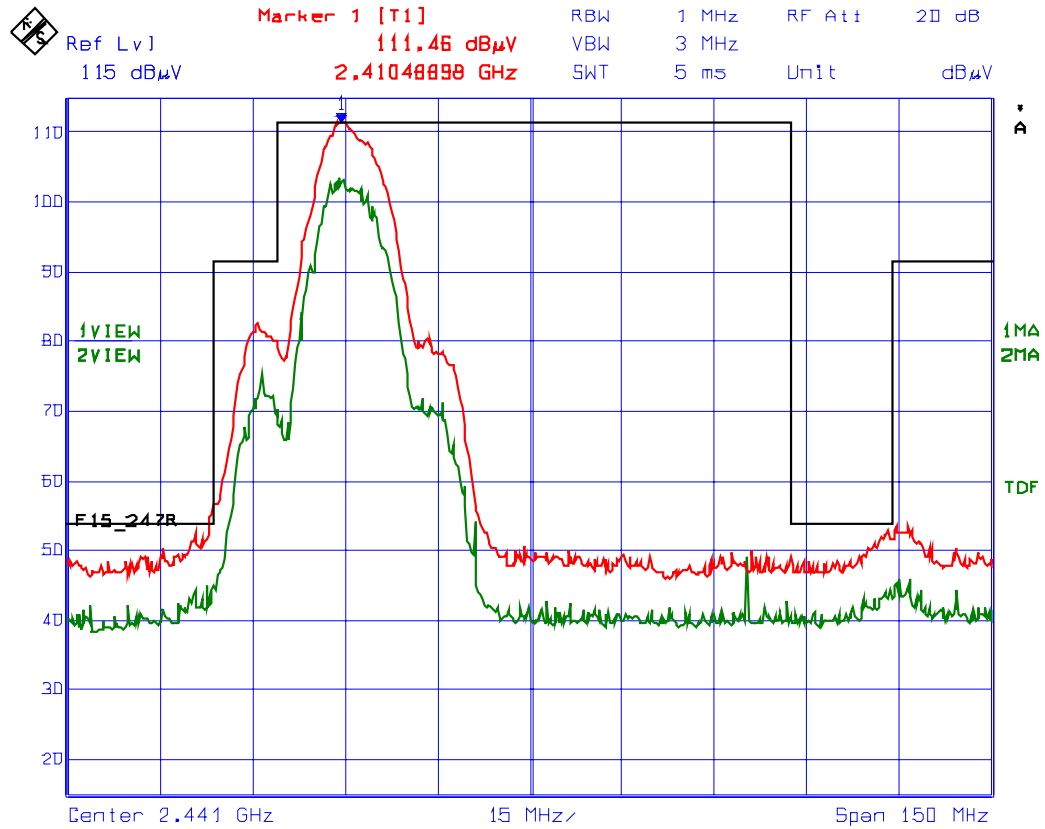

Date: 15. JAN. 2004 7:59:06

**Plot #25: Transmitter Band-Edge Radiated Emissions  
@ 3 Meters (Horizontal Polarization)**

**Antenna tested:** Cushcraft Antenna, Model No.: S2403BP12NF, Gain: 5.2 dBi

**Frequency: 2462 MHz, Delta Trace 1 & Trace 2: 8.53 dB**

**Trace 1: RBW= 1 MHz, VBW= 3 MHz**

**Trace 2: RBW= 100 kHz, VBW= 1 MHz**

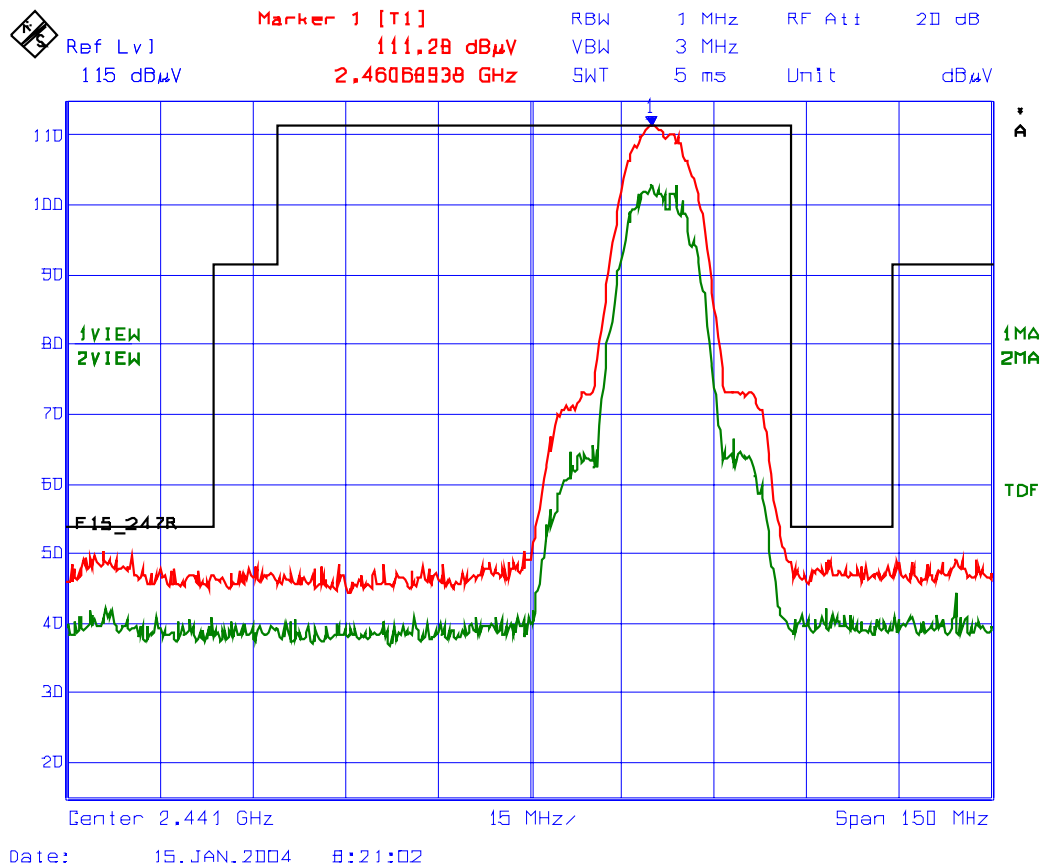

**ULTRATECH GROUP OF LABS**

3000 Bristol Circle, Oakville, Ontario, Canada L6H 6G4  
Tel. #: 905-829-1570, Fax. #: 905-829-8050, Email: [vic@ultratech-labs.com](mailto:vic@ultratech-labs.com), Website: <http://www.ultratech-labs.com>

File #: TEK-437FCC15C

Jan. 23, 2004

- All test results contained in this engineering test report are traceable to National Institute of Standards and Technology (NIST)

**Plot #26: Transmitter Band-Edge Radiated Emissions  
@ 3 Meters (Vertical Polarization)**

**Antenna tested:** Cushcraft Antenna, Model No.: S2403BP12NF, Gain: 5.2 dBi

**Frequency: 2462 MHz, Delta Trace 1 & Trace 2: 8.50 dB**

**Trace 1: RBW= 1 MHz, VBW= 3 MHz**

**Trace 2: RBW= 100 kHz, VBW= 1 MHz**

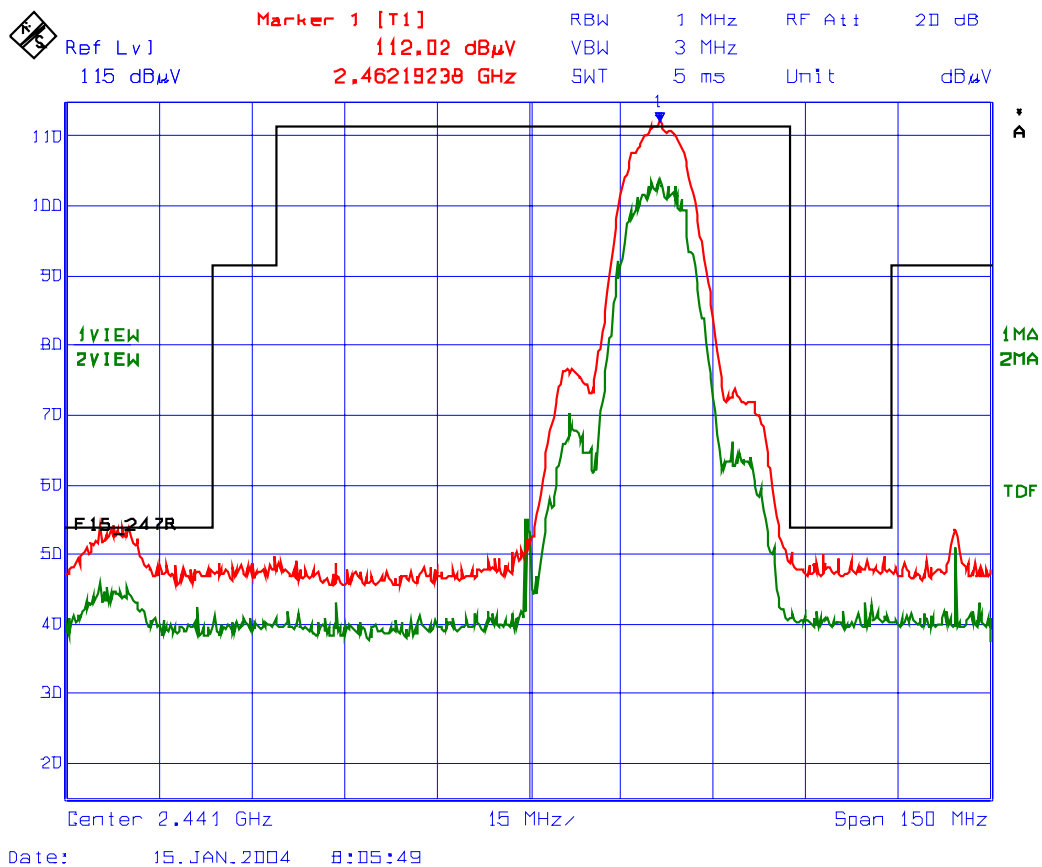

**ULTRATECH GROUP OF LABS**

3000 Bristol Circle, Oakville, Ontario, Canada L6H 6G4  
Tel. #: 905-829-1570, Fax. #: 905-829-8050, Email: [vic@ultratech-labs.com](mailto:vic@ultratech-labs.com), Website: <http://www.ultratech-labs.com>

File #: TEK-437FCC15C  
Jan. 23, 2004

- All test results contained in this engineering test report are traceable to National Institute of Standards and Technology (NIST)



**6.11.5.4. Transmitter Spurious Emissions Measurements with Larsen Antenna, Model No.: FB45T2400, Gain: 7.2 dBi.**

**Photographs of Test Setup:** Please refer to Photos # 7 & 8 in Annex 1.

6.11.5.4.1. Lowest Frequency (2412 MHz)

Frequency (MHz)	RF Peak Level (dBµV/m)	RF Avg Level (dBµV/m)	Antenna Plane (H/V)	Limit 15.209 (dBµV/m)	Limit 15.247 (dBµV/m)	Margin (dB)	Pass/Fail
2412.00	111.5	--	V	--	--	--	PASS
2412.00	111.8	--	H	--	--	--	PASS
4824.00	54.7	42.3	V	54.0	91.8	-11.7	*PASS
4824.00	57.1	43.9	H	54.0	91.8	-10.1	*PASS

- The emissions were scanned from 10 MHz to 25 GHz and all emissions less 20 dB below the limits were recorded.
- Please refer to Plot # 27 and 28 for Band-Edge Radiated Emissions measured at 3 meters.

\* Frequency in restricted bands, therefore FCC 15.209 limit applied.

6.11.5.4.2. Middle Frequency (2437 MHz)

Frequency (MHz)	RF Peak Level (dBµV/m)	RF Avg Level (dBµV/m)	Antenna Plane (H/V)	Limit 15.209 (dBµV/m)	Limit 15.247 (dBµV/m)	Margin (dB)	Pass/Fail
2437.00	110.2	--	V	--	--	--	PASS
2437.00	114.0	--	H	--	--	--	PASS
4874.00	55.8	42.8	V	54.0	94.0	-11.2	*PASS
4874.00	58.1	43.2	H	54.0	94.0	-10.8	*PASS

The emissions were scanned from 10 MHz to 25 GHz and all emissions less 20 dB below the limits were recorded.

\* Frequency in restricted bands, therefore FCC 15.209 limit applied.

6.11.5.4.3. Highest Frequency (2462 MHz)

Frequency (MHz)	RF Peak Level (dBµV/m)	RF Avg Level (dBµV/m)	Antenna Plane (H/V)	Limit 15.209 (dBµV/m)	Limit 15.247 (dBµV/m)	Margin (dB)	Pass/Fail
2437.00	110.1	--	V	--	--	--	PASS
2437.00	109.9	--	H	--	--	--	PASS
4874.00	54.1	41.0	V	54.0	90.1	-13.0	*PASS
4874.00	58.9	45.6	H	54.0	90.1	-8.4	*PASS

- The emissions were scanned from 10 MHz to 25 GHz and all emissions less 20 dB below the limits were recorded.
- Please refer to Plot # 29 and 30 for Band-Edge Radiated Emissions measured at 3 meters.

\* Frequency in restricted bands, therefore FCC 15.209 limit applied.

**Plot #27: Transmitter Band-Edge Radiated Emissions  
@ 3 Meters (Horizontal Polarization)**

**Antenna tested:** Larsen Antenna, Model No.: FB45T2400, Gain: 7.2 dBi

**Frequency: 2412 MHz, Delta Trace 1 & Trace 2: 8.38 dB**

**Trace 1: RBW= 1 MHz, VBW= 3 MHz**

**Trace 2: RBW= 100 kHz, VBW= 1 MHz**

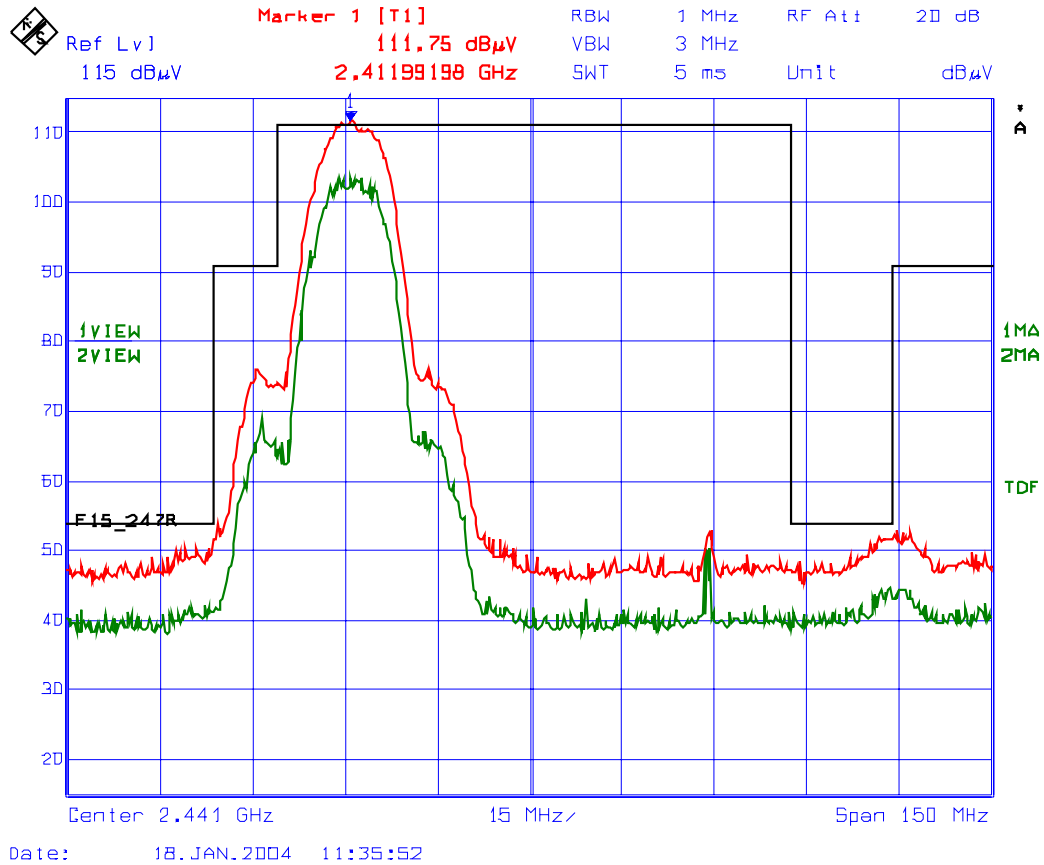

**Plot #28: Transmitter Band-Edge Radiated Emissions  
@ 3 Meters (Vertical Polarization)**

Antenna tested: Larsen Antenna, Model No.: FB45T2400, Gain: 7.2 dBi

Frequency: 2412 MHz, Delta Trace 1 & Trace 2: 7.97 dB

Trace 1: RBW= 1 MHz, VBW= 3 MHz

Trace 2: RBW= 100 kHz, VBW= 1 MHz

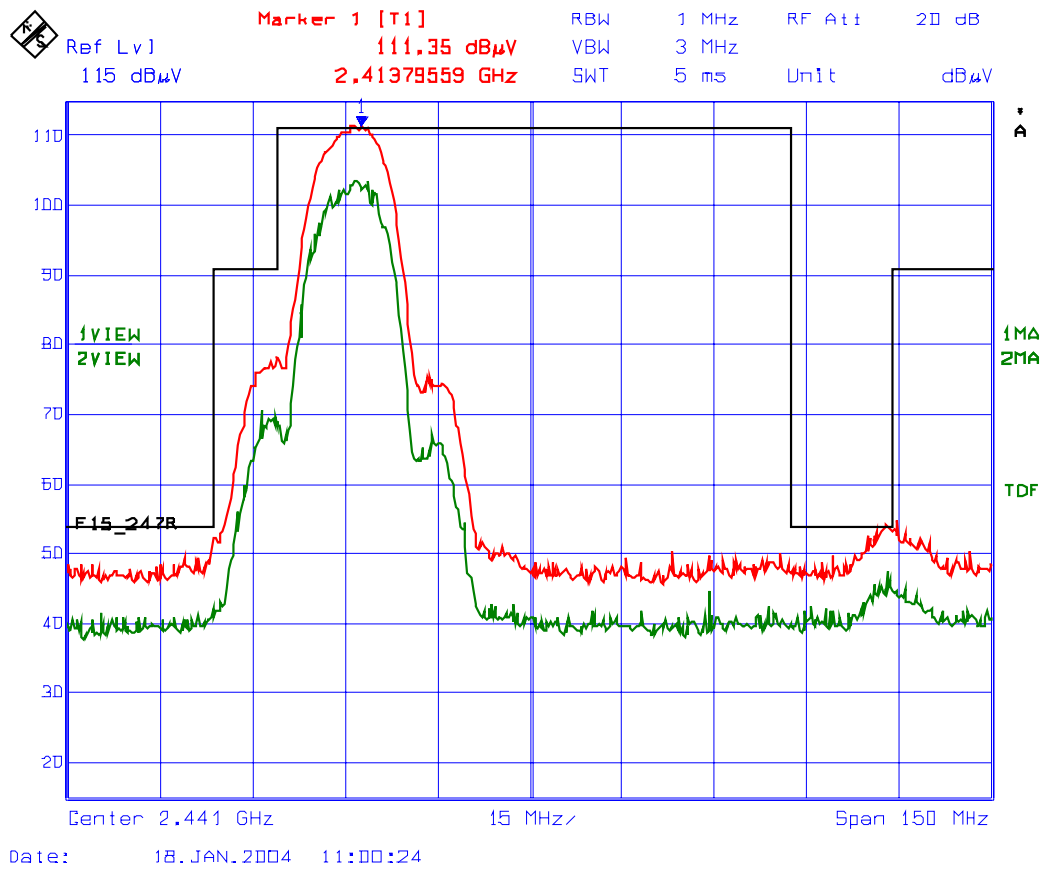

**Plot #29: Transmitter Band-Edge Radiated Emissions  
@ 3 Meters (Horizontal Polarization)**

**Antenna tested:** Larsen Antenna, Model No.: FB45T2400, Gain: 7.2 dBi

**Frequency: 2462 MHz, Delta Trace 1 & Trace 2: 7.77 dB**

**Trace 1: RBW= 1 MHz, VBW= 3 MHz**

**Trace 2: RBW= 100 kHz, VBW= 1 MHz**

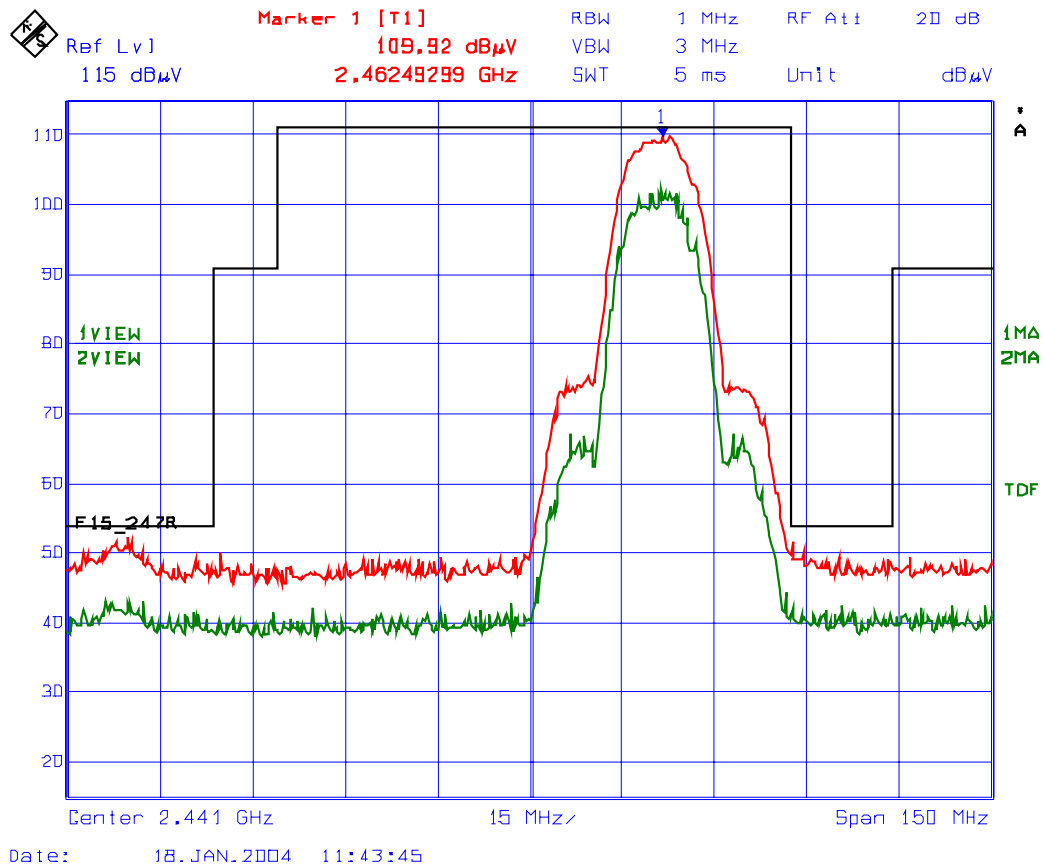

**Plot #30: Transmitter Band-Edge Radiated Emissions  
@ 3 Meters (Vertical Polarization)**

**Antenna tested:** Larsen Antenna, Model No.: FB45T2400, Gain: 7.2 dBi

**Frequency: 2462 MHz, Delta Trace 1 & Trace 2: 7.12 dB**

**Trace 1: RBW= 1 MHz, VBW= 3 MHz**

**Trace 2: RBW= 100 kHz, VBW= 1 MHz**

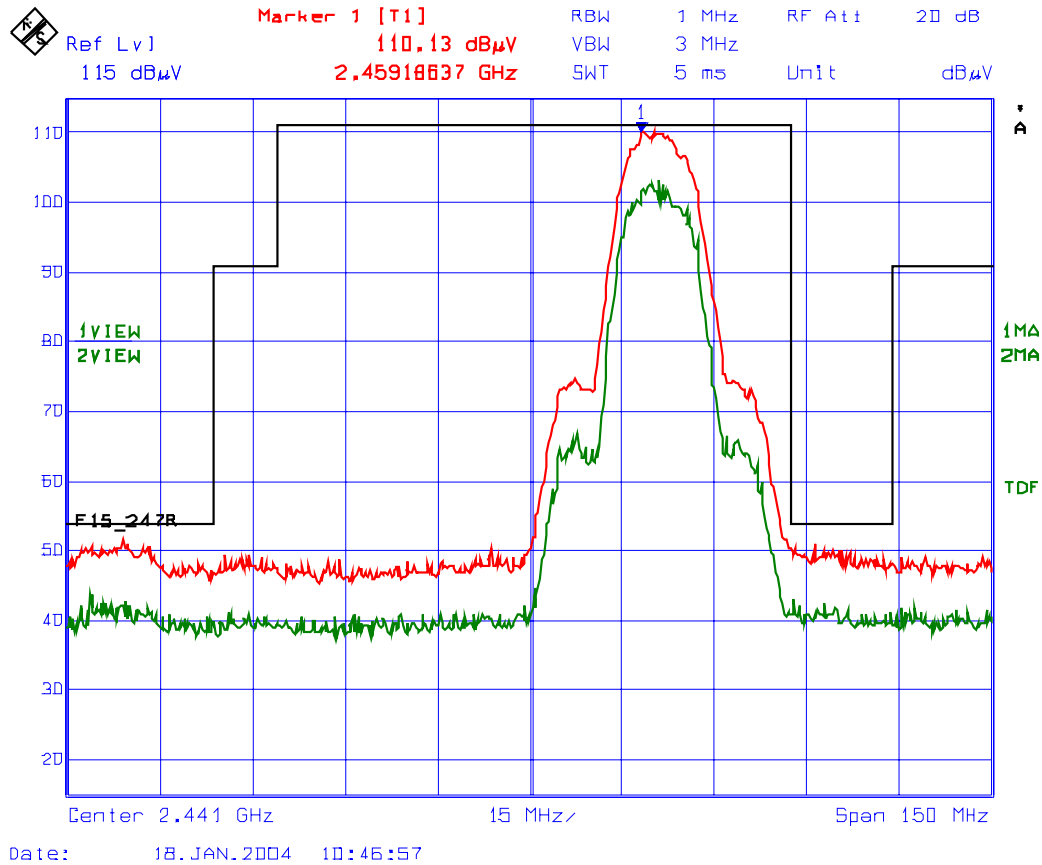

**6.11.5.5. Transmitter Spurious Emissions Measurements with Cushcraft Patch Antenna, Model No.: S2307AMP10SMF / S2307MP10SMF, Gain: 7.5 dBi.**

**Photographs of Test Setup:** Please refer to Photos # 9 & 10 in Annex 1.

6.11.5.5.1. Lowest Frequency (2412 MHz)

Frequency (MHz)	RF Peak Level (dBµV/m)	RF Avg Level (dBµV/m)	Antenna Plane (H/V)	Limit 15.209 (dBµV/m)	Limit 15.247 (dBµV/m)	Margin (dB)	Pass/Fail
2412.00	113.2	--	V	--	--	--	PASS
2412.00	115.1	--	H	--	--	--	PASS
4824.00	45.1	44.3	V	54.0	95.1	-9.9	*PASS
4824.00	46.3	45.7	H	54.0	95.1	-8.3	*PASS
<ul style="list-style-type: none"> <li>The emissions were scanned from 10 MHz to 25 GHz and all emissions less 20 dB below the limits were recorded.</li> <li>Please refer to Plot # 31 and 32 for Band-Edge Radiated Emissions measured at 3 meters.</li> </ul>							

\* Frequency in restricted bands, therefore FCC 15.209 limit applied.

6.11.5.5.2. Middle Frequency (2437 MHz)

Frequency (MHz)	RF Peak Level (dBµV/m)	RF Avg Level (dBµV/m)	Antenna Plane (H/V)	Limit 15.209 (dBµV/m)	Limit 15.247 (dBµV/m)	Margin (dB)	Pass/Fail
2437.00	115.9	--	V	--	--	--	PASS
2437.00	116.7	--	H	--	--	--	PASS
4874.00	48.3	47.1	V	54.0	96.7	-6.9	*PASS
4874.00	49.1	48.3	H	54.0	96.7	-5.7	*PASS
The emissions were scanned from 10 MHz to 25 GHz and all emissions less 20 dB below the limits were recorded.							

\* Frequency in restricted bands, therefore FCC 15.209 limit applied.

6.11.5.5.3. Highest Frequency (2462 MHz)

Frequency (MHz)	RF Peak Level (dBµV/m)	RF Avg Level (dBµV/m)	Antenna Plane (H/V)	Limit 15.209 (dBµV/m)	Limit 15.247 (dBµV/m)	Margin (dB)	Pass/Fail
2437.00	113.1	--	V	--	--	--	PASS
2437.00	114.4	--	H	--	--	--	PASS
4874.00	48.2	45.2	V	54.0	94.4	-8.8	*PASS
4874.00	45.2	47.4	H	54.0	94.4	-6.6	*PASS
<ul style="list-style-type: none"> <li>The emissions were scanned from 10 MHz to 25 GHz and all emissions less 20 dB below the limits were recorded.</li> <li>Please refer to Plot # 33 and 34 for Band-Edge Radiated Emissions measured at 3 meters.</li> </ul>							

\* Frequency in restricted bands, therefore FCC 15.209 limit applied.

**Plot #31: Transmitter Band-Edge Radiated Emissions  
@ 3 Meters (Horizontal Polarization)**

**Antenna tested:** Cushcraft Patch Antenna, Model No.: S2307AMP10SMF / S2307MP10SMF,  
Gain: 7.5 dBi

**Frequency: 2412 MHz, Delta Trace 1 & Trace 2: 7.66 dB**

**Trace 1: RBW= 1 MHz, VBW= 3 MHz**

**Trace 2: RBW= 100 kHz, VBW= 1 MHz**

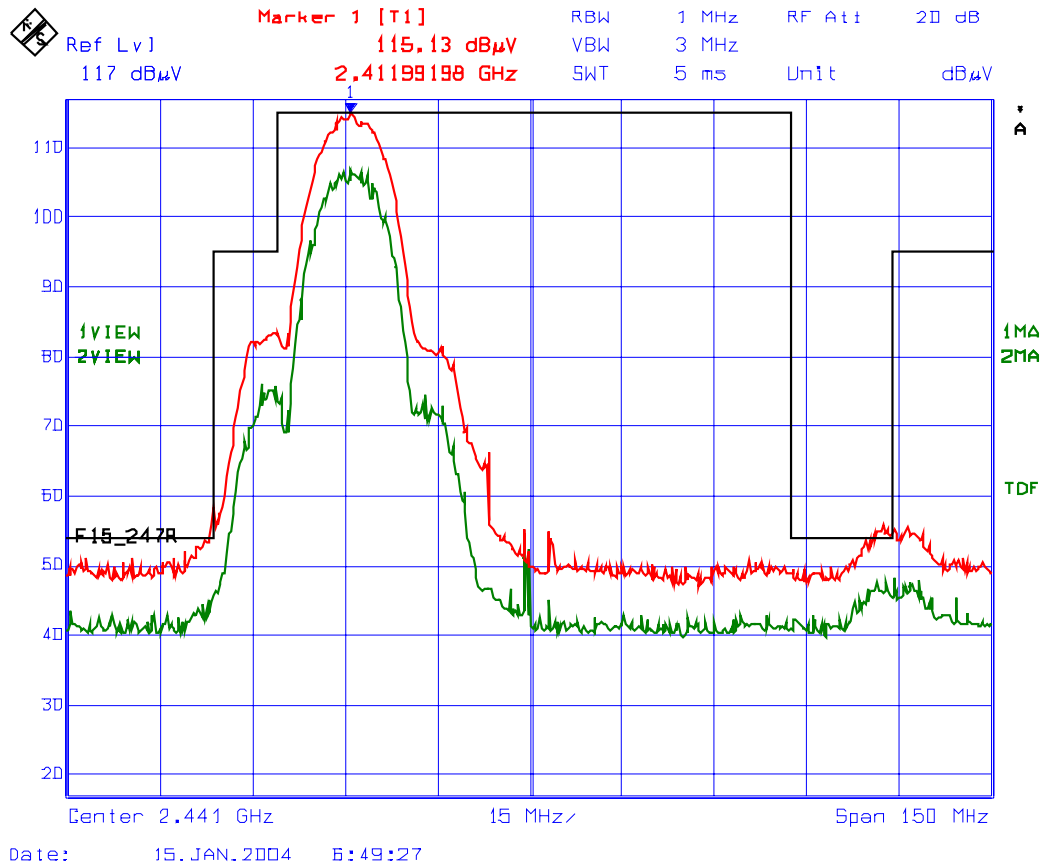

### Plot # 32: Transmitter Band-Edge Radiated Emissions @ 3 Meters (Vertical Polarization)

Antenna tested: Cushcraft Patch Antenna, Model No.: S2307AMP10SMF / S2307MP10SMF,  
Gain: 7.5 dBi

Frequency: 2412 MHz, Delta Trace 1 & Trace 2: 7.35 dB

Trace 1: RBW= 1 MHz, VBW= 3 MHz

Trace 2: RBW= 100 kHz, VBW= 1 MHz

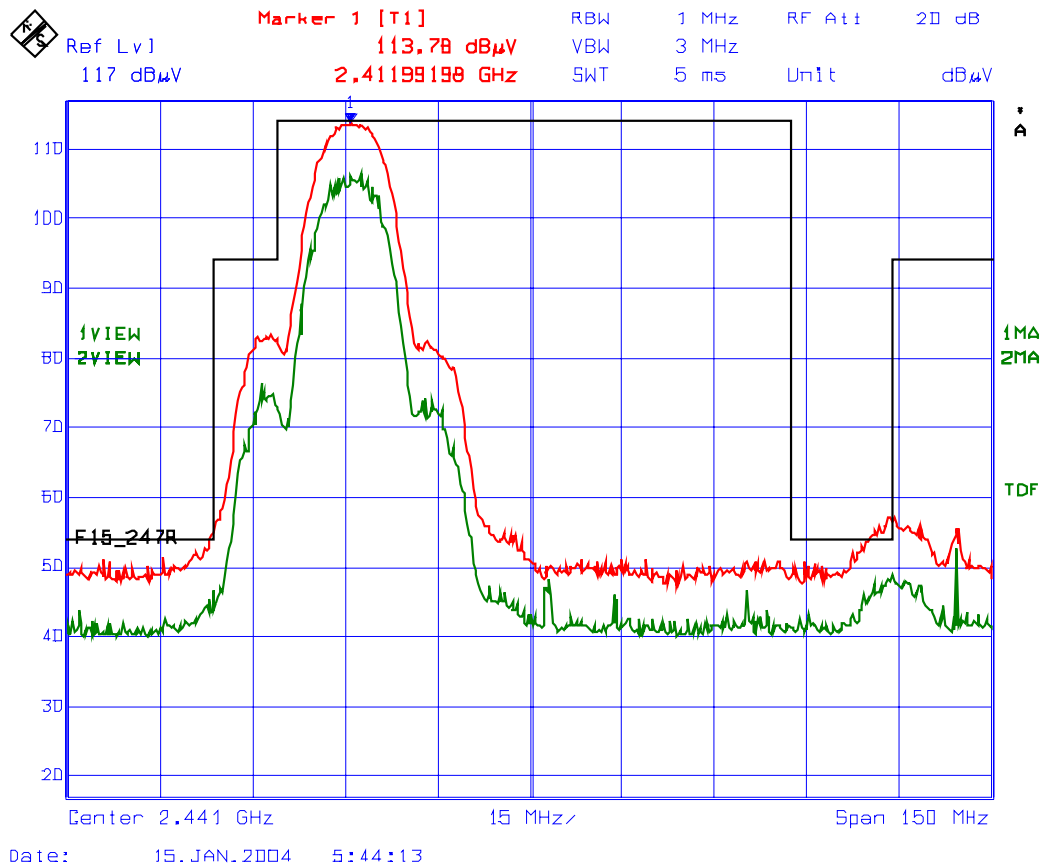

#### ULTRATECH GROUP OF LABS

3000 Bristol Circle, Oakville, Ontario, Canada L6H 6G4  
Tel. #: 905-829-1570, Fax. #: 905-829-8050, Email: [vic@ultratech-labs.com](mailto:vic@ultratech-labs.com), Website: <http://www.ultratech-labs.com>

File #: TEK-437FCC15C

Jan. 23, 2004

- All test results contained in this engineering test report are traceable to National Institute of Standards and Technology (NIST)



**Plot # 33: Transmitter Band-Edge Radiated Emissions  
@ 3 Meters (Horizontal Polarization)**

**Antenna tested:** Cushcraft Patch Antenna, Model No.: S2307AMP10SMF / S2307MP10SMF,  
Gain: 7.5 dBi

**Frequency: 2462 MHz, Delta Trace 1 & Trace 2: 7.56 dB**  
**Trace 1: RBW= 1 MHz, VBW= 3 MHz**  
**Trace 2: RBW= 100 kHz, VBW= 1 MHz**

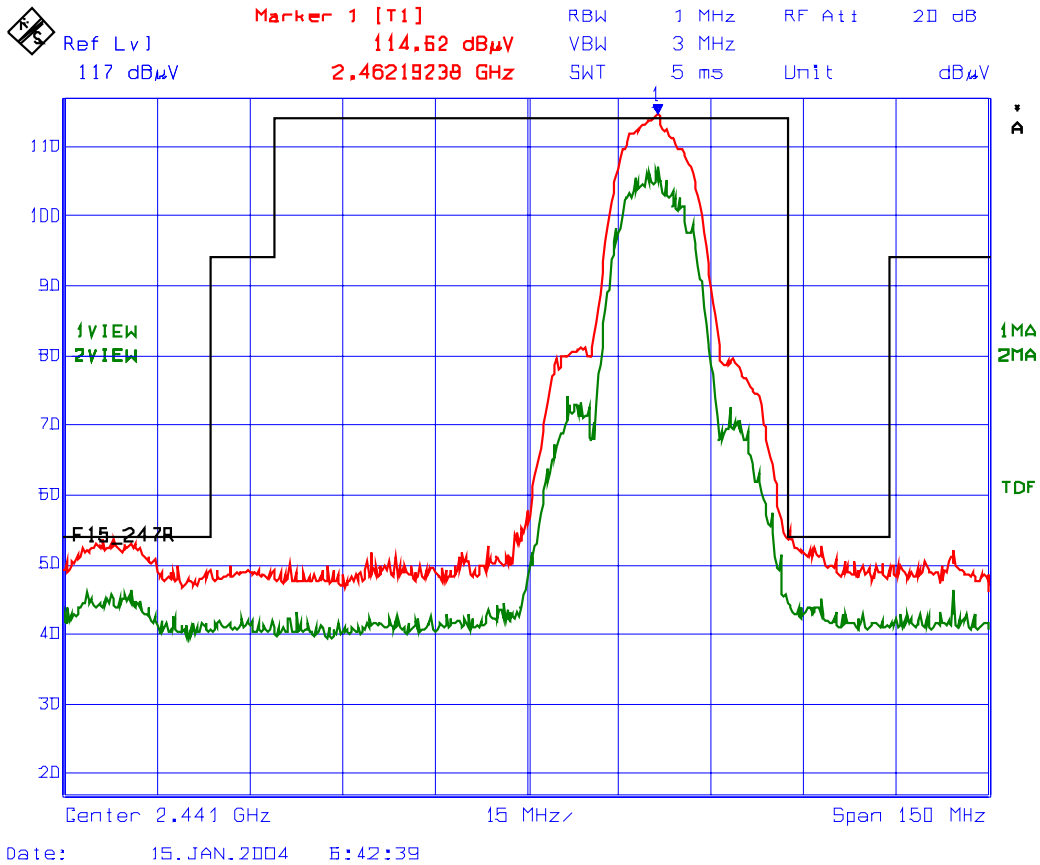

**ULTRATECH GROUP OF LABS**

3000 Bristol Circle, Oakville, Ontario, Canada L6H 6G4  
Tel. #: 905-829-1570, Fax. #: 905-829-8050, Email: vic@ultratech-labs.com, Website: http://www.ultratech-labs.com

File #: TEK-437FCC15C  
Jan. 23, 2004

- All test results contained in this engineering test report are traceable to National Institute of Standards and Technology (NIST)

**Plot #34: Transmitter Band-Edge Radiated Emissions  
@ 3 Meters (Vertical Polarization)**

**Antenna tested:** Cushcraft Patch Antenna, Model No.: S2307AMP10SMF / S2307MP10SMF,  
Gain: 7.5 dBi

**Frequency: 2462 MHz, Delta Trace 1 & Trace 2: 7.60 dB**

**Trace 1: RBW= 1 MHz, VBW= 3 MHz**

**Trace 2: RBW= 100 kHz, VBW= 1 MHz**

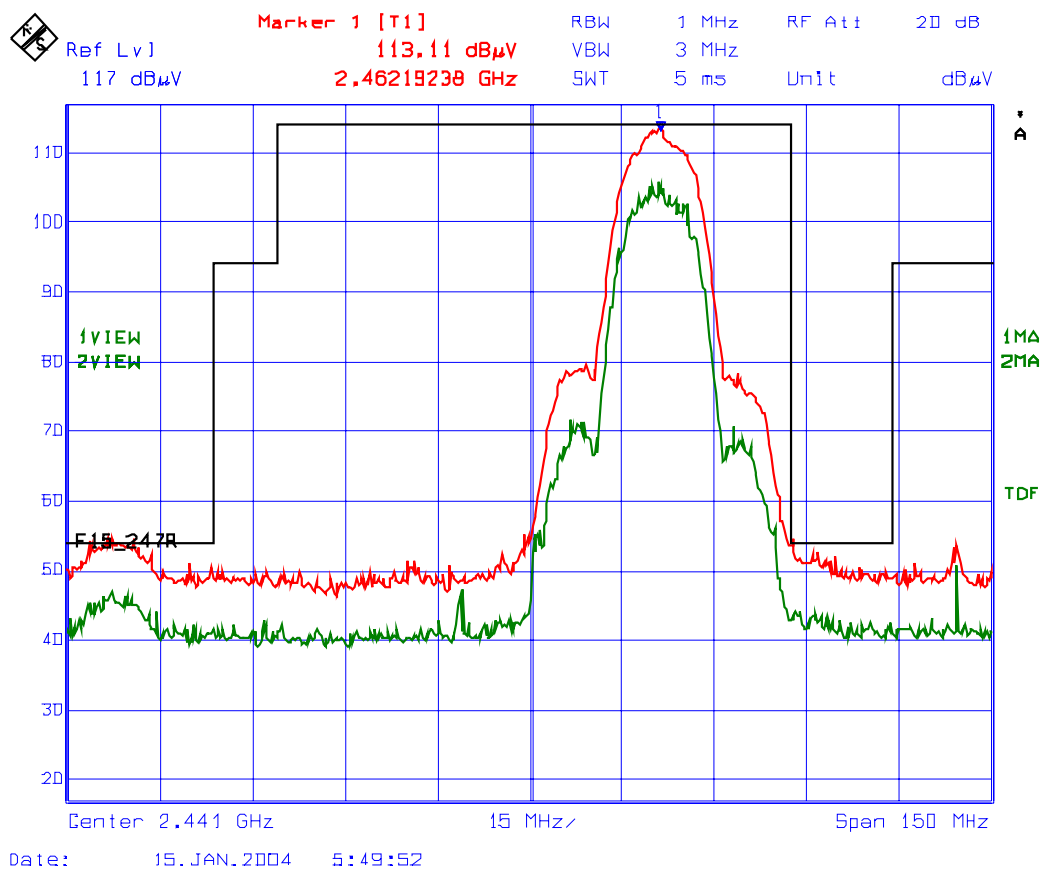

**ULTRATECH GROUP OF LABS**

3000 Bristol Circle, Oakville, Ontario, Canada L6H 6G4  
Tel. #: 905-829-1570, Fax. #: 905-829-8050, Email: [vic@ultratech-labs.com](mailto:vic@ultratech-labs.com), Website: <http://www.ultratech-labs.com>

File #: TEK-437FCC15C

Jan. 23, 2004

- All test results contained in this engineering test report are traceable to National Institute of Standards and Technology (NIST)

## EXHIBIT 7. MEASUREMENT UNCERTAINTY

The measurement uncertainties stated were calculated in accordance with the requirements of NIST Technical Note 1297 and NIS 81 (1994)

### 7.1. LINE CONDUCTED EMISSION MEASUREMENT UNCERTAINTY

CONTRIBUTION (Line Conducted)	PROBABILITY DISTRIBUTION	UNCERTAINTY (dB)	
		9-150 kHz	0.15-30 MHz
EMI Receiver specification	Rectangular	$\pm 1.5$	$\pm 1.5$
LISN coupling specification	Rectangular	$\pm 1.5$	$\pm 1.5$
Cable and Input Transient Limiter calibration	Normal (k=2)	$\pm 0.3$	$\pm 0.5$
Mismatch: Receiver VRC $\Gamma_1 = 0.03$ LISN VRC $\Gamma_R = 0.8(9 \text{ kHz}) 0.2 (30 \text{ MHz})$ Uncertainty limits $20\text{Log}(1 \pm \Gamma_1 \Gamma_R)$	U-Shaped	$\pm 0.2$	$\pm 0.3$
System repeatability	Std. deviation	$\pm 0.2$	$\pm 0.05$
Repeatability of EUT	--	--	--
Combined standard uncertainty	Normal	$\pm 1.25$	$\pm 1.30$
Expanded uncertainty U	Normal (k=2)	$\pm 2.50$	$\pm 2.60$

Sample Calculation for Measurement Accuracy in 450 kHz to 30 MHz Band:

$$u_c(y) = \sqrt{\sum_{i=1}^m u_i^2(y)} = \pm \sqrt{(1.5^2 + 1.5^2)/3 + (0.5/2)^2 + (0.05/2)^2 + 0.35^2} = \pm 1.30 \text{ dB}$$

$$U = 2u_c(y) = \pm 2.6 \text{ dB}$$

## 7.2. RADIATED EMISSION MEASUREMENT UNCERTAINTY

CONTRIBUTION (Radiated Emissions)	PROBABILITY DISTRIBUTION	UNCERTAINTY ( $\pm$ dB)	
		3 m	10 m
Antenna Factor Calibration	Normal (k=2)	$\pm 1.0$	$\pm 1.0$
Cable Loss Calibration	Normal (k=2)	$\pm 0.3$	$\pm 0.5$
EMI Receiver specification	Rectangular	$\pm 1.5$	$\pm 1.5$
Antenna Directivity	Rectangular	$\pm 0.5$	$\pm 0.5$
Antenna factor variation with height	Rectangular	$\pm 2.0$	$\pm 0.5$
Antenna phase center variation	Rectangular	0.0	$\pm 0.2$
Antenna factor frequency interpolation	Rectangular	$\pm 0.25$	$\pm 0.25$
Measurement distance variation	Rectangular	$\pm 0.6$	$\pm 0.4$
Site imperfections	Rectangular	$\pm 2.0$	$\pm 2.0$
Mismatch: Receiver VRC $\Gamma_1 = 0.2$ Antenna VRC $\Gamma_R = 0.67(\text{Bi}) 0.3 (\text{Lp})$ Uncertainty limits $20\text{Log}(1 \pm \Gamma_1 \Gamma_R)$	U-Shaped	+1.1 -1.25	$\pm 0.5$
System repeatability	Std. Deviation	$\pm 0.5$	$\pm 0.5$
Repeatability of EUT		-	-
Combined standard uncertainty	Normal	+2.19 / -2.21	+1.74 / -1.72
Expanded uncertainty U	Normal (k=2)	+4.38 / -4.42	+3.48 / -3.44

Calculation for maximum uncertainty when 3m biconical antenna including a factor of k=2 is used:

$$U = 2u_c(y) = 2x(+2.19) = +4.38 \text{ dB} \quad \text{And} \quad U = 2u_c(y) = 2x(-2.21) = -4.42 \text{ dB}$$

## EXHIBIT 8. MEASUREMENT METHODS

### 8.1. GENERAL TEST CONDITIONS

The following test conditions shall be applied throughout the tests covered in this report.

#### 8.1.1. Normal temperature and humidity

- Normal temperature: +15°C to +35°C
- Relative Humidity: +20% to 75%

The actual values during tests shall be recorded in the test report.

#### 8.1.2. Normal power source

##### 8.1.2.1. Mains Voltage

The nominal test voltage of the equipment to be connected to mains shall be the nominal mains voltage which is the declared voltage or any of the declared voltages for which the equipment was designed.

The frequency of test power source corresponding to the AC mains shall be between 59 Hz and 61 Hz.

##### 8.1.2.2. Battery Power Source.

For operation from battery power sources, the nominal test voltage shall be as declared by the equipment manufacturer. This shall be recorded in the test report.

#### 8.1.3. Operating Condition of Equipment under Test

- All tests were carried out while the equipment operated at the following frequencies:
  - The lowest operating frequency,
  - The middle operating frequency and
  - The highest operating frequency
- Modulation were applied using the Test Data sequence
- The transmitter was operated at the highest output power, or in the case the equipment able to operate at more than one power level, at the lowest and highest output powers

## 8.2. METHOD OF MEASUREMENTS - AC MAINS CONDUCTED EMISSIONS

- AC Mains conducted emissions measurements were performed in accordance with the standard against appropriate limits for each detector function.
- The test was performed in the shielded room, 16'(L) by 16'(W) by 12'(H).
- The test was performed were made over the frequency range from 450 kHz to 30 MHz to determine the line-to-ground radio noise voltage which was conducted from the EUT power-input terminals that were directly connected to a public power network.
- The EUT normally received power from another device that connects to the public utility ac power lines, measurements would be made on that device with the EUT in operation to ensure that the device continues to comply with the appropriate limits while providing the EUT with power.
- If the EUT operates only from internal or dedicated batteries, with no provisions for connection to the public utility ac power lines, AC Mains conducted measurements are not required.
- Table-top devices were placed on a platform of nominal size 1 m by 1.5m raised 80 cm above the conducting ground plane.
- The EUT current-carrying power lead, except the ground (safety) lead, was individually connected through a LISN to the power source. All unused 50-Ohm connectors of the LISN was terminated in 50-ohm when not connected to the measuring instruments.
- The line cord of the EUT connected to one LISN which was connected to the measuring instrument. Those power cords for the units of devices not under measurement were connected to a separate multiple ac outlet. Drawings and photographs of typically conducted emission test setups were shown in the Test Report. Each current-carrying conductor of the EUT shall be individually tested.
- The EUT was normally operated with a ground (safety) connection, the EUT was connected to the ground at the LISN through a conductor provided in the lead from the ac power mains to the LISN.
- The excess length of the power cord was folded back and forth in an 8-shape on a wooden strip with a vertical prong located on the top of the LISN case.
- The EUT was set-up in its typical configuration and operated in its various modes as described in 3.2 of the test report.
- A preliminary scan was made by using spectrum analyzer system with the detector function set to PEAK mode (9 KHz RBW, VBW > RBW), frequency span 450 kHz to 30 MHz.
- The maximum conducted emission for a given mode of operation was found by using the following step-by-step procedure:
  - Step1. Monitor the frequency range of interest at a fixed EUT azimuth.
  - Step2. Manipulate the system cables and peripheral devices to produce highest amplitude signal relative to the limit. Note the amplitude and frequency of the suspect signal.
  - Step3. The effects of various modes of operation is examined. This is done by varying equipment operation modes as step 2 is being performed.
  - Step4. After completing step 1 through 3, record EUT and peripheral device configuration, mode of operation, cable configuration, signal levels and frequencies for final test.
- Each highest signal level at the maximized test configuration was zoomed in a small frequency span on the spectrum analyzer's display (the manipulation of cables and peripheral devices and EUT operation modes might have to be repeated to obtain the highest signal level with the spectrum analyzer set to PEAK detector mode 10 KHz RBW and VBW > RBW). The spectrum analyzer was then set to CISPR QUASI-PEAK detector mode (9 KHz RBW, 1 MHz VBW) and AVERAGE detector mode (10 kHz RBW, 1 Hz VBW). The final highest RF signal levels and frequencies were record.
- **Broad-band ac Powerline conducted emissions:-** If the EUT exhibits ac Powerline conducted emissions that exceed the limit with the instrument set to the quasi-peak mode, then measurements should be made in the average mode. If

the amplitude measured in the quasi-peak mode is at least 6 dB higher than the amplitude measured in the average mode, the level measured in quasi peak mode may be reduced by 13 dB before comparing it to the limit.

### 8.3. PEAK CONDUCTED POWER & PEAK EIRP

#### 8.3.1. Measurements of Transmitter Parameters (Duty Cycle & Peak Power)

- The following shall be applied to the combination(s) of the radio device and its intended antenna(e).
- If the RF level is user adjustable, all measurements shall be made with the highest power level available to the user for that combination.
- The following method of measurement shall apply to both conducted and radiated measurements.
- The radiated measurements are performed at the Ultratech Calibrated Open Field Test Site.
- The measurement shall be performed using normal operation of the equipment with modulation.

Test procedure shall be as follows:

**Step 1:** Duty Cycle (x) and Peak Power (y) parameters measurements

- Connect the transmitter output to a diode detector through an attenuator
- Connect the diode detector to the vertical channel of an oscilloscope.
- The observed duty cycle of the transmitter,  $x = \text{Tx on} / (\text{Tx on} + \text{Tx off})$  with  $0 < x < 1$ , is measure and recorded in the test report. For the purpose of testing, the equipment shall be operated with a duty cycle that is equal or more than 0.1.
- Observe and record the y parameter of the DC level on the oscilloscope.

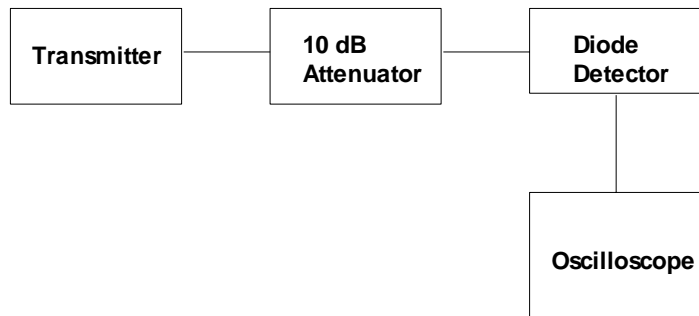

**Step 2:** Peak Power Measurements

- Replace the transmitter by a RF signal generator
- Set the signal generator frequency be the same as the transmitter frequency
- Adjust the rf output level of the RF signal generator until the DC level on the oscilloscope is same as that (y) recorded in step 1.
- Measure the RF signal generator output level using a power meter
- Calculate the total peak power ( $P_p$ ) by adding the signal generator level with the attenuator value and the cable loss.

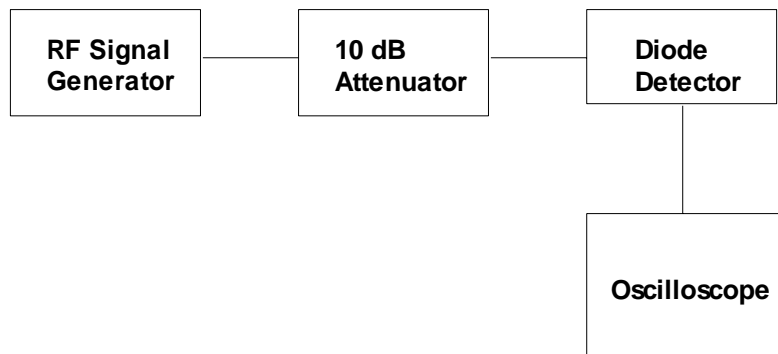

**Step 3:** Total Peak EIRP Substitution Method. See Figure 2

- (a) The setting of the spectrum analyzer shall be:

Center Frequency:	equal to the signal source
Resolution BW:	100 kHz for FSS, 1 MHz for DIGITAL MODULATION
Video BW:	same
Detector Mode:	positive
Average:	off
Span:	3 x the signal bandwidth

- (b) Connect the transmitter output to the spectrum analyzer and measure the peak power in 1 MHz bandwidth for reference.
- (c) Calculate the difference ( $K_p$ ) between the total peak power and 1 MHz BW peak power. This value will be used to add onto the 1MHz BW peak EIRP to obtain the TOTAL peak EIRP.
- (d) Test was performed at listed 3m open area test site (listed with FCC, IC, ITI, NVLAP, ACA & VCCI).
- (e) The transmitter under test was placed at the specified height on a non-conducting turntable (80 cm height)
- (f) The horn test antenna was used and tuned to the transmitter carrier frequency.
- (g) The spectrum analyzer was tuned to transmitter carrier frequency. The test antenna was lowered or raised from 1 to 4 meters until the maximum signal level was detected.
- (h) The transmitter was rotated through 360° about a vertical axis until a higher maximum signal was received.
- (i) The test antenna was lowered or raised again from 1 to 4 meters until a maximum was obtained. This level was recorded.
- (j) The substitution horn antenna and the signal generator replaced the transmitter and antenna under test in the same position, and the substitution horn antenna was placed in vertical polarization. The test horn antenna was lowered or raised as necessary to ensure that the maximum signal is still received.
- (k) The input signal to the substitution antenna was adjusted in level until an equal or a known related level to that detected from the transmitter was obtained in the test receiver. The maximum carrier radiated power is equal to the power supply by the generator.



- (l) The substitution antenna gain and cable loss were added to the signal generator level for the corrected 1MHz BW peak EIRP level. The total peak EIRP can be calculated by adding its value with the Kp
- (m) Repeat steps (c) to (j) with the substitution antenna oriented in horizontal polarization. Measured in step (c).
- (n) Actual gain of the EUT's antenna is the difference of the measured ERP and measured RF power at the RF port. Correct the antenna gain if necessary.

**Figure 2**

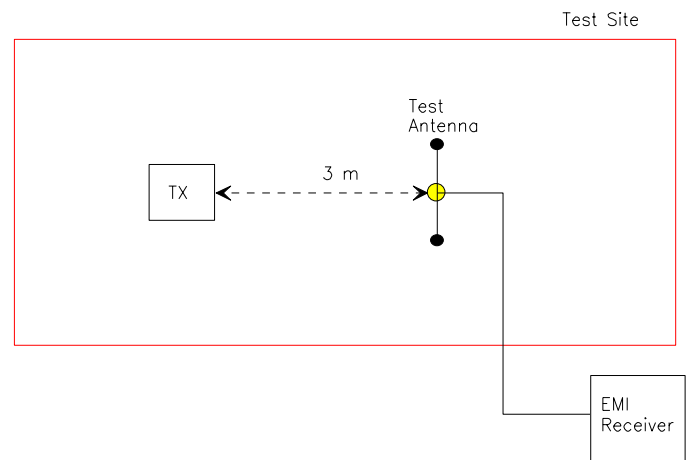

**Figure 3**

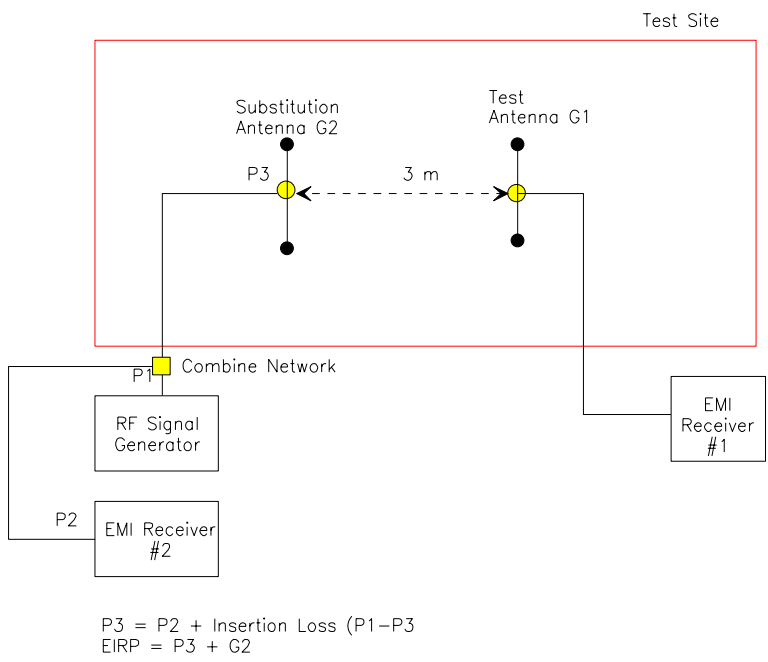

## 8.4. SPURIOUS EMISSIONS (CONDUCTED & RADIATED)

For both conducted and radiated measurements, the spurious emissions were scanned from the lowest frequency generated by the EUT or 10 MHz whichever is lower to 10<sup>th</sup> harmonic of the highest frequency generated by the EUT.

### 8.4.1. Band-edge and Spurious Emissions (Conducted)

#### Band-edge Compliance of RF Conducted Emissions:

Use the following spectrum analyzer settings:

- The radio was connected to the measuring equipment via a suitable attenuator.
- Span = wide enough to capture the peak level of the emission operating on the channel closest to the band-edge, as well as any modulation products which fall outside of the authorized band of operation.
- RBW = 1 % of the span
- VBW = RBW
- Sweep = auto
- Detector function = peak
- Trace = max hold
- Allow the trace to stabilize
- Set the marker on the emission at the band-edge, or on the highest modulation product outside of the band, if this level is greater than that at the band-edge
- Enable the marker-delta function, then use the marker-to-peak function to move the marker to the peak of the in-band emission.
- The marker-delta value now displayed must comply with the limit specified
- Submit this plot

#### Spurious RF Conducted Emissions:

Use the following spectrum analyzer settings:

- The radio was connected to the measuring equipment via a suitable attenuator.
- Span = wide enough to capture the peak level of the in-band-emission and all spurious emissions (e.g. harmonics) from the lowest frequency generated in the EUT up through the 10<sup>th</sup> harmonic. Typically, several plots are required to cover this entire span.
- RBW = 100 kHz
- VBW = RBW
- Sweep = auto
- Detector function = peak
- Trace = max hold
- Allow the trace to stabilize
- Set the marker on the any spurious emission recorded. The level displayed must comply with the limit specified in this Section.
- Submit this plot

### 8.4.2. Spurious Emissions (Radiated)

- The radiated emission measurements were performed at the UltraTech's 3 Meter Open Field Test Site (OFTS) situated in the Town of Oakville, province of Ontario. The Attenuation Characteristics of OFTS have been filed to FCC, Industry Canada, ACA/Austel, NVLap and ITI.
- Radiated emissions measurements were made using the following test instruments:
  1. Calibrated EMCO BiconiLog antenna in the frequency range from 30 MHz to 2000 MHz.
  2. Calibrated Emco Horn antennas in the frequency range above 1000 MHz (1GHz - 40 GHz).

---

#### ULTRATECH GROUP OF LABS

3000 Bristol Circle, Oakville, Ontario, Canada L6H 6G4  
Tel. #: 905-829-1570, Fax. #: 905-829-8050, Email: [vic@ultratech-labs.com](mailto:vic@ultratech-labs.com), Website: <http://www.ultratech-labs.com>

File #: TEK-437FCC15C  
Jan. 23, 2004

- All test results contained in this engineering test report are traceable to National Institute of Standards and Technology (NIST)

3. The test is required for any spurious emission or modulation product that falls in a Restricted Band, as defined in Section 15.205. It must be performed with the highest gain of each type of antenna proposed for use with the EUT. Use the following spectrum analyzer settings:
- RBW = 100 kHz for  $f < 1\text{GHz}$  and RBW = 1 MHz for  $f \geq 1\text{GHz}$
  - VBW = RBW
  - Sweep = auto
  - Detector function = peak
  - Trace = max hold
  - Follows the guidelines in ANSI C63.4-1992 with respect to maximizing the emission by rotating the EUT, measuring the emission while the EUT is situated in three orthogonal planes (if appropriate), adjusting the measurement antenna height and polarization, etc.. A pre-amp and highpass filter are required for this test, in order to provide the measuring system with sufficient sensitivity.
  - Allow the trace to stabilize.
  - The peak reading of the emission, after being corrected by the antenna correction factor, cable loss, pre-amp gain, etc.... is the peak field strength which comply with the limit specified in Section 15.35(b)

#### Calculation of Field Strength:

The field strength is calculated by adding the calibrated antenna factor and cable factor, and subtracting the Amplifier gain (if any) from the measured reading. The basic equation with a sample calculation is as follows:

$$FS = RA + AF + CF - AG$$

Where	FS	=	Field Strength
	RA	=	Receiver/Analyzer Reading
	AF	=	Antenna Factor
	CF	=	Cable Attenuation Factor
	AG	=	Amplifier Gain

Example: If a receiver reading of 60.0 dBuV is obtained, the antenna factor of 7.0 dB/m and cable factor of 1.0 dB are added, and the amplifier gain of 30 dB is subtracted. The actual field strength will be:

$$\text{Field Level} = 60 + 7.0 + 1.0 - 30 = 38.0 \text{ dBuV/m.}$$

$$\text{Field Level} = 10^{(38/20)} = 79.43 \text{ uV/m.}$$

- Submit this test data
- Now set the VBW to 10Hz, while maintaining all of the other instrument settings. This peak level, once corrected, must comply with the limit specified in Section 15.209. If the dwell time of the each channel is less than 100ms, then the reading obtained may be further adjusted by a “duty cycle correction factor”, derived from  $10\log(\text{dwell time}/100\text{mS})$  in an effort to demonstrate compliance with the 15.209.
- Submit test data

#### Maximizing The Radiated Emissions:

- The frequencies of emissions was first detected. Then the amplitude of the emissions was measured at the specified measurement distance using required antenna height, polarization, and detector characteristics.
- During this process, cables and peripheral devices were manipulated within the range of likely configuration.
- For each mode of operation required to be tested, the frequency spectrum was monitored. Variations in antenna heights (from 1 meter to 4 meters above the ground plane), antenna polarization (horizontal plane and vertical

plane), cable placement and peripheral placement were explored to produce the highest amplitude signal relative to the limit.

The maximum radiated emission for a given mode of operation was found by using the following step-by-step procedure:

- Step1: Monitor the frequency range of interest at a fixed antenna height and EUT azimuth.
- Step2: Manipulate the system cables to produce highest amplitude signal relative to the limit. Note the amplitude and frequency of the suspect signal.
- Step3: Rotate the EUT 360 degrees to maximize the suspected highest amplitude signal. If the signal or another at a different frequency is observed to exceed the previously noted highest amplitude signal by 1 dB or more, go back to the azimuth and repeat Step 2. Otherwise, orient the EUT azimuth to repeat the highest amplitude observation and proceed.
- Step4: Move the antenna over its full allowable range of travel (1 to 4 meters) to maximize the suspected highest amplitude signal. If the signal or another at a different frequency is observed to exceed the previously noted highest amplitude signal by 1 dB or more, return to Step 2 with the highest amplitude observation and proceed.
- Step5: Change the polarization of the antenna and repeat Step 2 through 4. Compare the resulting suspected highest amplitude signal with that found for the other polarization. Select and note the higher of the two signals. This signal is termed the highest observed signal with respect to the limit for this EUT operational mode.
- Step6: The effects of various modes of operation is examined. This is done by varying the equipment modes as steps 2 through 5 are being performed.
- Step7: After completing steps 1 through 6, record the final highest emission level, frequency, antenna polarization and detector mode of the measuring instrument.

## 8.5. ALTERNATIVE TEST PROCEDURES

If the antenna conducted tests cannot be performed on this device, radiated tests show compliance with the peak output power limit specified in Section 15.247(b) and the spurious RF conducted emission limit specified in Section 15.247(c) are acceptable. As stated previously, a pre-amp, and, in the later case, a high pass filter, are required for the following measurements:

### 8.5.1. Peak Power Measurements

Calculate the transmitter's peak power using the following equation:

$$E = 30PG/d$$
$$P = (Ed)^2/30G$$

Where:

- E: measured maximum fundamental field strength in V/m. Utilizing a RBW, the 20 dB bandwidth of the emission VBW >RBW, peak detector function. Follow the procedures in C63.4-1992 with respect to maximizing the emission
- G is numeric gain of the transmitting antenna with reference to an isotropic radiator
- D is the distance in meters from which the field strength was measured

- P is the distance in meters from which the field strength was measured

### 8.5.2. Spurious RF conducted emissions

The demonstrate compliance with the spurious RF conducted emission requirement of Section 15.247©, use the following spectrum analyzer settings:

- Span = wide enough to fully capture the emission being measured
- RBW = 100 kHz
- Sweep = auto
- Detector function = peak
- Trace = max hold
- Measure the field strength of both the fundamental and all spurious emissions with these settings.
- Follow the procedures C62-4:1994 with respect to maximizing the emissions. The measured field strength of all spurious emissions must be below the measured field strength of the fundamental emission by the amount specified in Section 15.247©. Note that if the emission falls in a Restricted Band, as defined in Section 15.205, the procedure for measuring spurious radiated emissions listed above must be followed

### 8.6. TRANSMITTED POWER DENSITY OF A DIGITAL MODULATION SYSTEM

- The radio was connected to the measuring equipment via a suitable attenuator.
- Locate and zoom in on emission peak(s) within the passband
- The spectrum analyzer were used and set as follows:
  - Resolution BW: 3 kHz
  - Video BW: same or greater
  - Detector Mode: Normal
  - Averaging: Off
  - Span: 3 MHz
  - Amplitude: Adjust for middle of the instrument's range
  - Sweep Time: 1000 seconds
- Locate and zoom in on emission peak(s) within the passband. Set RBW = 3 KHz, VBW  $\geq$  RBW, Sweep = SPAN/3 KHz. For example, a span of 1.5 MHz, the sweep should be  $1.6 \times 10^6 / 3.0 \times 10^3 = 500$  seconds. The measured peak level must be no greater than +8 dBm.
- For devices with spectrum line spacing greater than 3 KHz no change is required.
- For devices with spectrum line spacing equal to or less than 3 KHz, the resolution bandwidth must be reduced below 3 KHz until the individual lines in the spectrum are resolved. The measurement data must then be normalized to 3 KHz by summing the power of all the individual spectral lines within 3 KHz band (in linear power units) to determine compliance.
- If the spectrum line spacing cannot be resolved on the available spectrum analyzer, the noise density function on most modern conventional spectrum analyzer will directly measure the noise power density normalized to 1 Hz noise power bandwidth. Add 30 dB for correction to 3 KHz.
- Should all the above fail or any controversy develop regarding accuracy of measurement, the Laboratory will use HP 89440A Vector Signal Analyzer for final measurement unless a clear showing can be made for a further alternate.