



FCC TEST REPORT

for

47 CFR Part 15 Subpart C and IC RSS-210

Equipment : Bluetooth Module
Model No. : BTL040
FCC ID : GM37525BTB
IC ID : 2739D-7525BTB
Filing Type : PC II Change
Applicant : Psion Teklogix Inc.
2100 Meadowvale Boulevard., Mississauga,
Ontario, L5N 7J9, Canada

- The test result refers exclusively to the test presented test model / sample.
- Without written approval of SPORTON International Inc., the test report shall not be reproduced except in full.
- **Certificate or Test Report must not be used by the applicant to claim the product in this test report endorsement by NVLAP or any agency of U.S. government.**
- The data shown in this test report were carried out on Jan. 06, 2007 at **Sporton International Inc. LAB.**
- Report No.: FR710208, Report Version: Rev. 02.

Roy Wu
Deputy Manager

SPORTON International Inc.

6F, No.106, Sec. 1, Hsin Tai Wu Rd., Hsi Chih, Taipei Hsien, Taiwan, R.O.C.

SPORTON International Inc.

TEL : 886-2-2696-2468

FAX : 886-2-2696-2255

Rev. 02



Table of Contents

History of this test report.....ii

1. General Description of Equipment under Test.....1

 1.1.Applicant.....1

 1.2.Manufacturer1

 1.3.Basic Description of Equipment under Test.....1

 1.4.Feature of Equipment under Test2

2. Test Configuration of Equipment under Test4

 2.1.Test Manner4

 2.2.Test Mode4

 2.3.Connection Diagram of Test System5

 2.4.Ancillary Equipment List.....5

3. RF Utility6

4. General Information of Test.....7

 4.1.Test Voltage7

 4.2.Standard for Methods of Measurement.....7

 4.3.Test in Compliance with7

 4.4.Frequency Range Investigated7

 4.5.Test Distance7

5. Report of Measurements and Examinations8

 5.1.List of Measurements and Examinations8

 5.2.Hopping Channel Separation9

 5.3.Number of Hopping Frequency13

 5.5 Dwell Time of Each Frequency within a 30 Seconds Period19

 5.6 Output Power39

 5.7 100kHz Bandwidth of Frequency Band Edges43

 5.8 Conducted Emission47

 5.9 Radiated Emission Measurement52

 5.10 Antenna Requirements.....79

6. List of Measuring Equipments Used80

7. Uncertainty Evaluation.....81

Appendix A. Setup Photograph

Appendix B. Part 15C RSE Data for BT+WLAN Co-location

Appendix C. Part 22/24 RSE Data for BT+GSM Co-location



1. General Description of Equipment under Test

1.1. Applicant

Psion Teklogix Inc.

2100 Meadowvale Boulevard., Mississauga, Ontario, L5N 7J9, Canada

1.2. Manufacturer

ASKEY COMPUTER CORP.

10F, No. 119, Chienkang Rd., Chung-Ho, Taipei, Taiwan, R.O.C.

1.3. Basic Description of Equipment under Test

Equipment : Bluetooth Module
Model No. : BTL040
FCC ID : GM37525BTB
IC ID : 2739D-7525BTB
AC Power Cord : AC120V, Wall-mount, 1.8 meter, 2 pin

Remark:

1. The CSR Bluetooth module, BTL040, is embedded in the specific Host 7527C / 7527S Series. It can be co-transmitted with WLAN (FCC ID: GM37527RA2041) and GSM (FCC ID: GM375273RADA) on the Host.
2. 7527S is the shorter version of model 7527C. They have the same RF modules and antenna. The only difference between the two models is the keypad.



1.4. Feature of Equipment under Test

BT Module

Product Feature & Specification	
1. Model Name	BTL040
2. FCC ID	GM37525BTB
3. IC ID	2739D-7525BTB
4. Modulation Type/Data Rate	GFSK
5. Frequency Range.	2400 MHz ~ 2483.5 MHz
6. Number of Channels	79
7. Carrier Frequency of each channel	2402+ n*1 MHz, n= 0~78
8. Channel Spacing	1 MHz
9. Maximum Output Power to Antenna (Normal condition)	0.59 dBm
10. Type of Antenna Connector	N/A
11. Antenna Type	Chip Antenna
12. Antenna Gain	4.1 dBi
13. Function Type	Transmitter <input type="checkbox"/> Transceiver <input checked="" type="checkbox"/>
14. Power Rating (DC/AC , Voltage)	AC100~240V

Co-transmission WLAN Module

Product Feature & Specification	
1. Model Name	RA2041
2. FCC ID	GM37527RA2041
3. IC ID	2739D-BGRADA
4. Modulation Type/Data Rate	DSSS / OFDM
5. Frequency Range.	2400 MHz ~ 2483.5 MHz
6. Number of Channels	11
7. Carrier Frequency of each channel	2412+(n-1)*5 MHz; n=1~11
8. Maximum Output Power to Antenna (Normal condition)	802.11b : 20.65 dBm 802.11g : 22.98 dBm
9. Type of Antenna Connector	N/A
10. Antenna Type	PCB Antenna
11. Antenna Gain	-2.66 dBi (7527C) -2.48 dBi (7527S)
12. Function Type	Transmitter <input type="checkbox"/> Transceiver <input checked="" type="checkbox"/>
13. Power Rating (DC/AC , Voltage)	AC100~240V

**Co-transmission GSM Module**

Product Feature & Specification	
1. Model Name	RA3030-G2
2. FCC ID	GM375273RADA
3. IC ID	2739D-7527RADA
4. Modulation Type/Data Rate	GSM : GMSK EDGE : 8PSK
5. Frequency Range.	GSM850 : 824 ~ 849 MHz (Tx) / 869 ~ 894 MHz (Rx) PCS1900 : 1850 ~ 1910 MHz (Tx) / 1930 ~ 1990 MHz (Rx)
6. Maximum Output Power to Antenna (Normal condition)	GSM : 32.7 dBm (GSM) ; 21.7 dBm (EDGE) PCS : 29.6 dBm (GSM) ; 21.2 dBm (EDGE)
7. Type of Antenna Connector	N/A
8. Antenna Type	PCB Antenna
9. Antenna Gain	5 dBi

Host

Product Feature & Specification	
1. Equipment	Hand-held Micro-computer
2. Trade Name	WORKABOUT PRO
3. Model Name	7527C / 7527S Series
4. HW Version	7527C : ES3 7527S : ES2
5. SW Version	A
6. GSM Board	ES2
7. Battery	WA3006
8. DUT Stage	Identical Prototype



2. Test Configuration of Equipment under Test

2.1. Test Manner

- a. The EUT has been associated with peripherals pursuant to ANSI C63.4-2003 and configuration operated in a manner tended to maximize its emission characteristics in a typical application.
- b. For spurious emission below 1GHz, only one channel of each application was tested because it is not related to channel selection.
- c. The EUT is programmed to transmit signal continuously for all testings.
- d. Frequency range investigated: conduction 150 kHz to 30 MHz, radiation 30 MHz to 25000MHz.
- e. The BT module can be co-transmitted with WLAN and GSM on the Host.

2.2. Test Mode

Application	Bluetooth
Radiated Emission	Mode 1: Tx_CH00_2402 MHz for 7527C Mode 2: Tx_CH39_2441 MHz for 7527C Mode 3: Tx_CH78_2480 MHz for 7527C Mode 4: Tx_CH00_2402 MHz for 7527S
Conducted Emission	Mode 1: BT Link Mode + Docking 1 + POD 4 + USB 1 + USB 2 + Adapter for 7527C Mode 2: BT Link Mode + Docking 1 + POD 4 + USB 1 + USB 2 + Adapter for 7527S

Remark:

- 1. The radiated emission testing for BT and WLAN co-transmission on the Host can be referred in Appendix D.
- 2. The radiated emission testing for BT and GSM co-transmission on the Host can be referred in Appendix E.

2.3. Connection Diagram of Test System

<Radiated Emission>

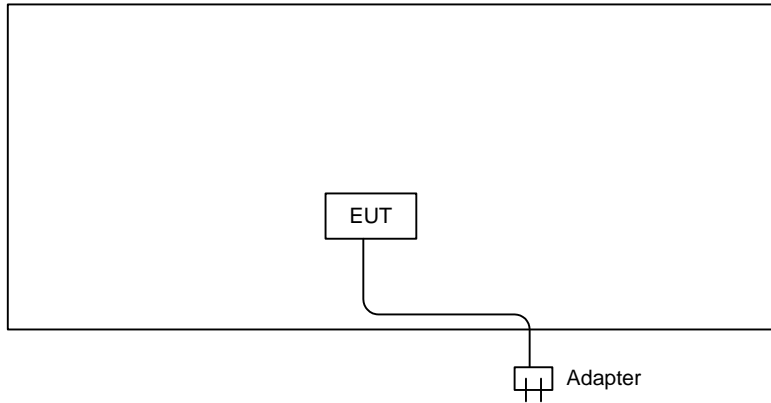

<Conducted Emission>

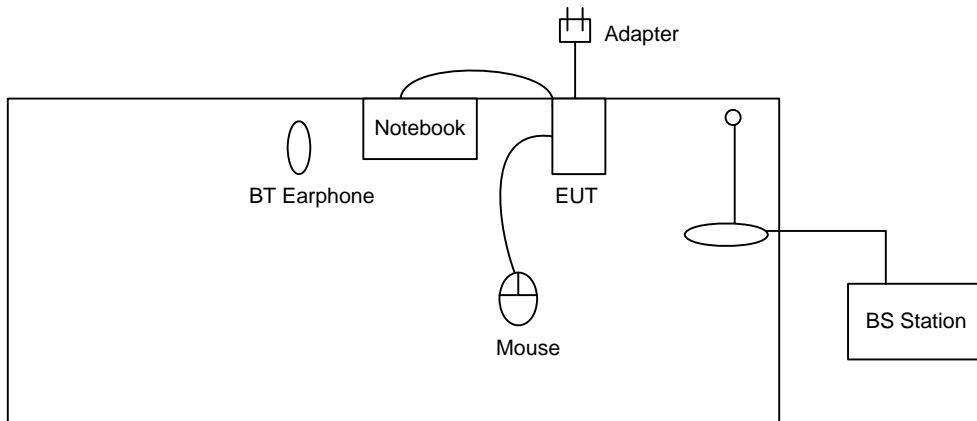

2.4. Ancillary Equipment List

Item	Equipment	Model No.	Serial No.
1.	BT Base Station (Anritus)	8852A	N/A
2.	Notebook (DELL)	D400	N/A
3.	(USB)Mouse (Microsoft)	B75-00093	Non-shielded, 1.8 m
4.	Bluetooth Earphone (Free Style)	JD-100	N/A



3. RF Utility

The executive programs, "EMCTest.exe" under WINXP installed in notebook which generates a complete line continuously repeating "H" pattern were used as the test software.

The EUT is in BT Link mode for conducted emission or in BT continuous Tx Mode controlled by base station simulator for radiation emission or other conducted tests.



4. General Information of Test

Test Site Location : No. 52, Hwa Ya 1st Rd., Hwa Ya Technology Park,
Kwei-Shan Hsiang, Tao Yuan Hsien, Taiwan, R.O.C.
TEL : 886-3-327-3456
FAX : 886-3-318-0055
Test Site No : CO01-HY, 03CH06-HY

4.1. Test Voltage

AC 120V and DC 24V

4.2. Standard for Methods of Measurement

ANSI C63.4-2003

4.3. Test in Compliance with

47 CFR Part 15 Subpart C and IC RSS-210 Issued 6

4.4. Frequency Range Investigated

Conduction: from 150 kHz to 30 MHz
Radiation: from 30 MHz to 25000MHz

4.5. Test Distance

The test distance of radiated emission from antenna to EUT is 3 m.



5. Report of Measurements and Examinations

5.1. List of Measurements and Examinations

FCC Rule	IC Rule	Description of Test	Result	Section
15.247(a)(1)	A8.1 (2)	Hopping Channel Separation	Pass	5.2
15.247(a)(1)(iii)	A8.1 (4)	Number of Hopping Frequency Used	Pass	5.3
15.247(a)(1)	A8.1 (1)	Hopping Channel Bandwidth	Pass	5.4
15.247(a)(1)(iii)	A8.1 (4)	Dwell Time of Each Frequency	Pass	5.5
15.247(b)(1)	A8.4 (2)	Output Power	Pass	5.6
15.247(c)	A8.5	100kHz Bandwidth of Frequency Band Edges	Pass	5.7
15.207	RSS-Gen 7.2.2	Conducted Emission	Pass	5.8
15.209	2.6	Radiated Emission	Pass	5.9
15.203	A8.4 (6)	Antenna Requirement	Pass	5.10

5.2. Hopping Channel Separation

5.2.1. Measuring Instruments :

As described in chapter 6 of this test report.

5.2.2. Test Procedure :

1. The transmitter output was connected to the spectrum analyzer directly.
2. Set RBW of spectrum analyzer to 30kHz and VBW to 100kHz.
3. The Hopping Channel Separation is defined as the channel is separated with the next channel.

5.2.3. Test Setup Layout :

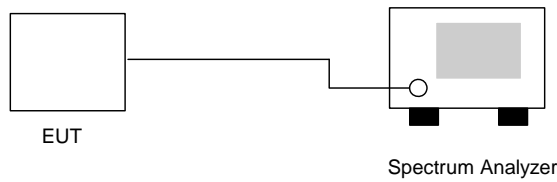

5.2.4. Test Result : The spectrum analyzer plots are attached as below

- Temperature: 24°C
- Relative Humidity: 52%
- Test Engineer : James

Channel	Frequency (MHz)	Hopping Channel Separation (MHz)	Limits (MHz)	Plot Ref. No.
00	2402	0.996	0.824	Mode 1
39	2441	1.004	0.832	Mode 2
78	2480	0.996	0.834	Mode 3

Remark: Limit is the greater one of 25kHz or the 20dB bandwidth of the hopping channel.



5.2.5 Hopping Channel Separation

Mode 1: CH00 (2402MHz)



Ref 10 dBm *Att 20 dB *RBW 30 kHz Delta 2 [T1]
 *VBW 100 kHz -0.01 dB
 *SWT 500 ms 996.000000000 kHz

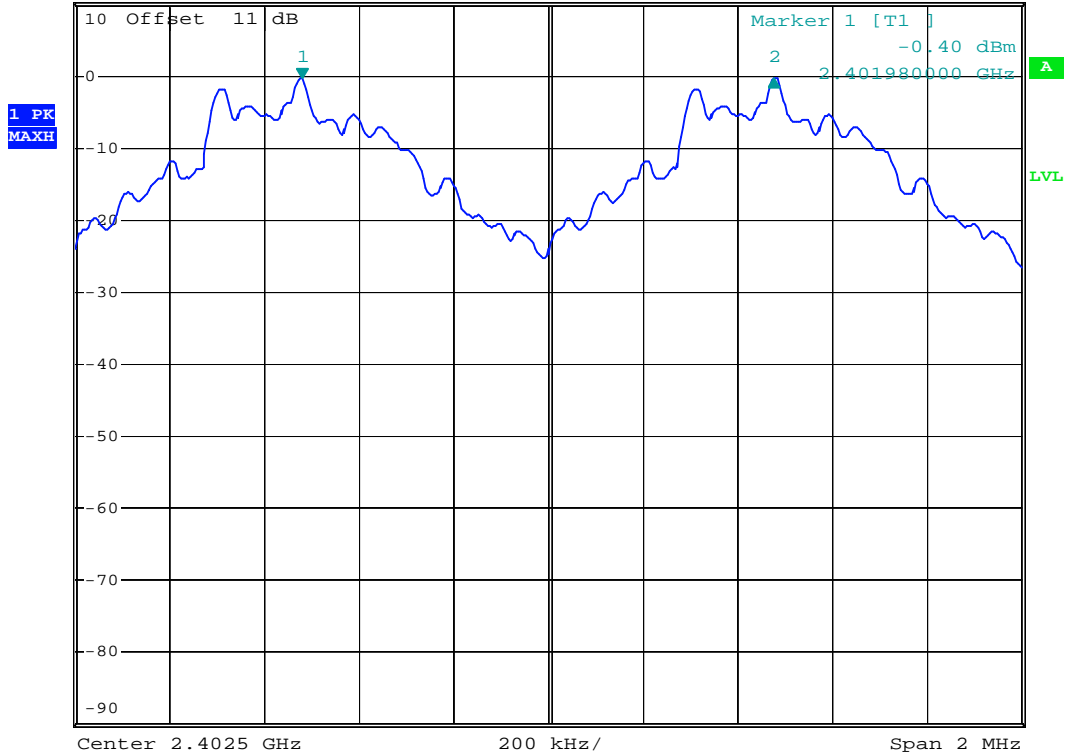

Date: 30.NOV.2006 11:33:36



Mode 2: CH39 (2441MHz)



*RBW 30 kHz Delta 2 [T1]
*VBW 100 kHz 0.03 dB
*SWT 500 ms 1.004000000 MHz

Ref 10 dBm

*Att 20 dB

1 PK
MAXH

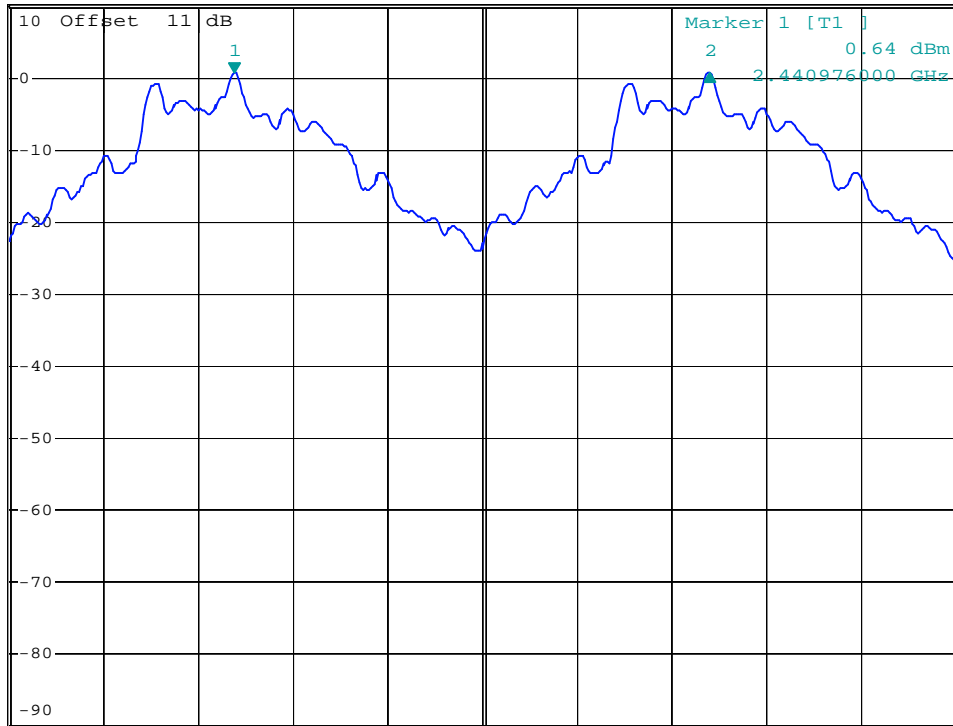

Center 2.4415 GHz

200 kHz/

Span 2 MHz

Date: 30.NOV.2006 11:34:07



Mode 3: CH78 (2480MHz)



*RBW 30 kHz Delta 2 [T1]
*VBW 100 kHz -0.13 dB
*SWT 500 ms 996.000000000 kHz

Ref 10 dBm

*Att 20 dB

1 PK
MAXH

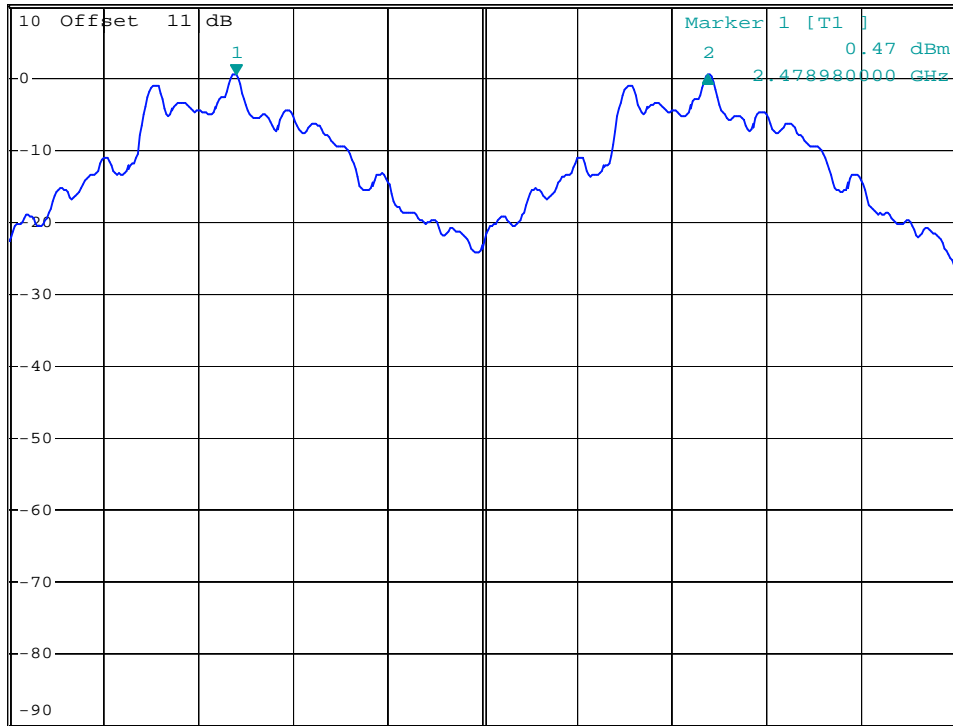

Center 2.4795 GHz

200 kHz/

Span 2 MHz

Date: 30.NOV.2006 11:34:49

5.3. Number of Hopping Frequency

5.3.1. Measuring Instruments :

As described in chapter 6 of this test report.

5.3.2. Test Procedure :

1. The transmitter output was connected to the spectrum analyzer directly.
2. Set RBW of spectrum analyzer to 100kHz and VBW to 100kHz.
3. The number of hopping frequency used is defined as the device has the numbers of total channel.

5.3.3. Test Setup Layout :

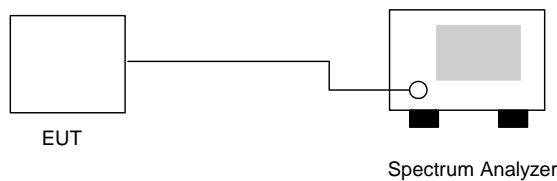

5.3.4. Test Result : See spectrum analyzer plots below

- Temperature: 24°C
- Relative Humidity: 52%
- Test Engineer : James

Number of Hopping Frequency (Channel)	Limits (Channel)
79	15



5.3.5 Number of Hopping Frequency

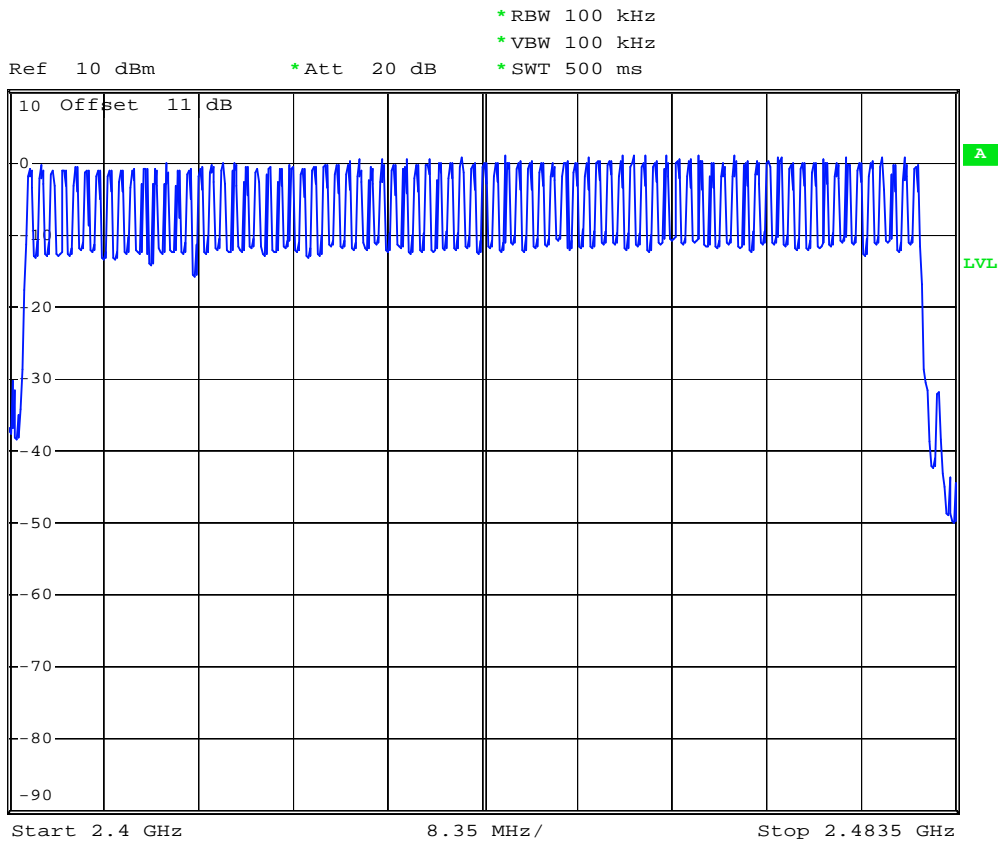

Date: 30.NOV.2006 13:28:49

5.4 Hopping Channel Bandwidth

5.4.1 Measuring Instruments :

As described in chapter 6 of this test report.

5.4.2 Test Procedure :

1. The transmitter output was connected to the spectrum analyzer directly.
2. Set RBW of spectrum analyzer to 30kHz and VBW to 300kHz.
3. The Hopping Channel bandwidth is defined as the frequency range where the power is higher than peak power minus 20dB.

5.4.3 Test Setup Layout :

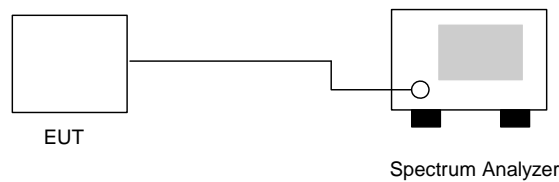

5.4.4 Test Result : See spectrum analyzer plots below

- Temperature: 24°C
- Relative Humidity: 52%
- Test Engineer : James

Channel	Frequency (MHz)	Hopping Channel Bandwidth (MHz)	Limits (MHz)	Plot Ref. No.
00	2402	0.824	1.0	Mode 1
39	2441	0.832	1.0	Mode 2
78	2480	0.834	1.0	Mode 3



5.4.5 Hopping Channel Bandwidth

Mode 1: CH00 (2402MHz)

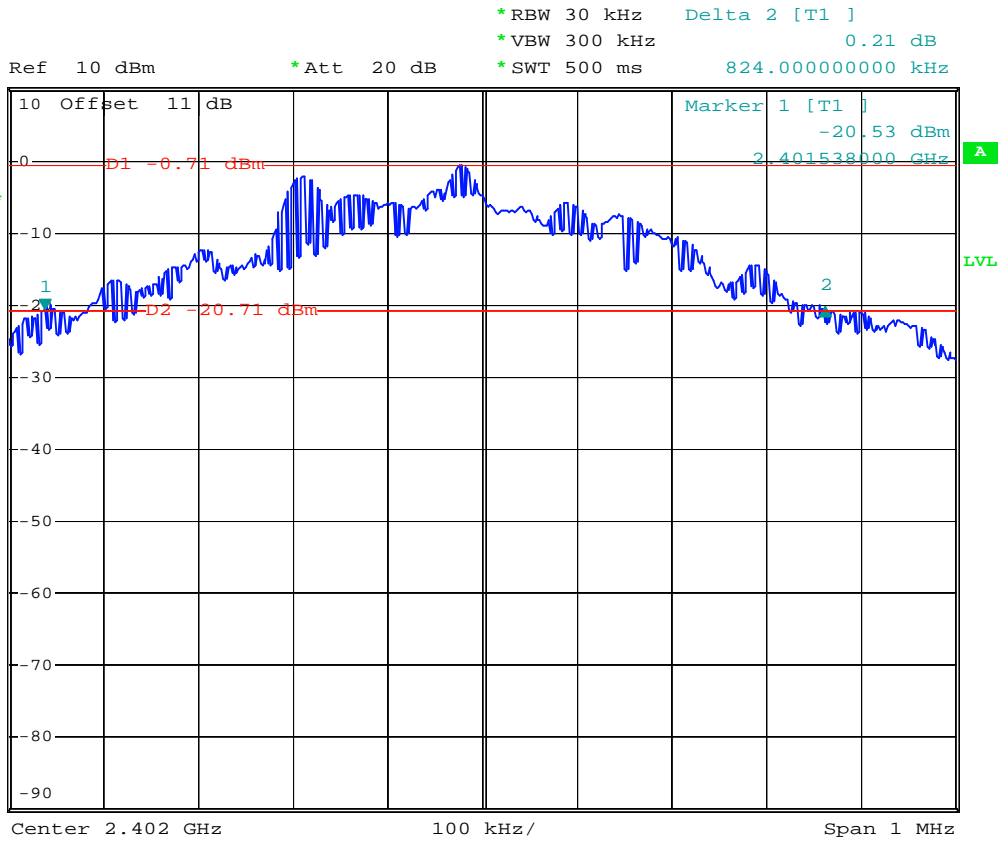

Date: 30.NOV.2006 11:30:18



Mode 2: CH39 (2441MHz)



*RBW 30 kHz Delta 2 [T1]
*VBW 300 kHz 0.02 dB
*SWT 500 ms 832.000000000 kHz

Ref 10 dBm

*Att 20 dB

1 PK*
VIEW

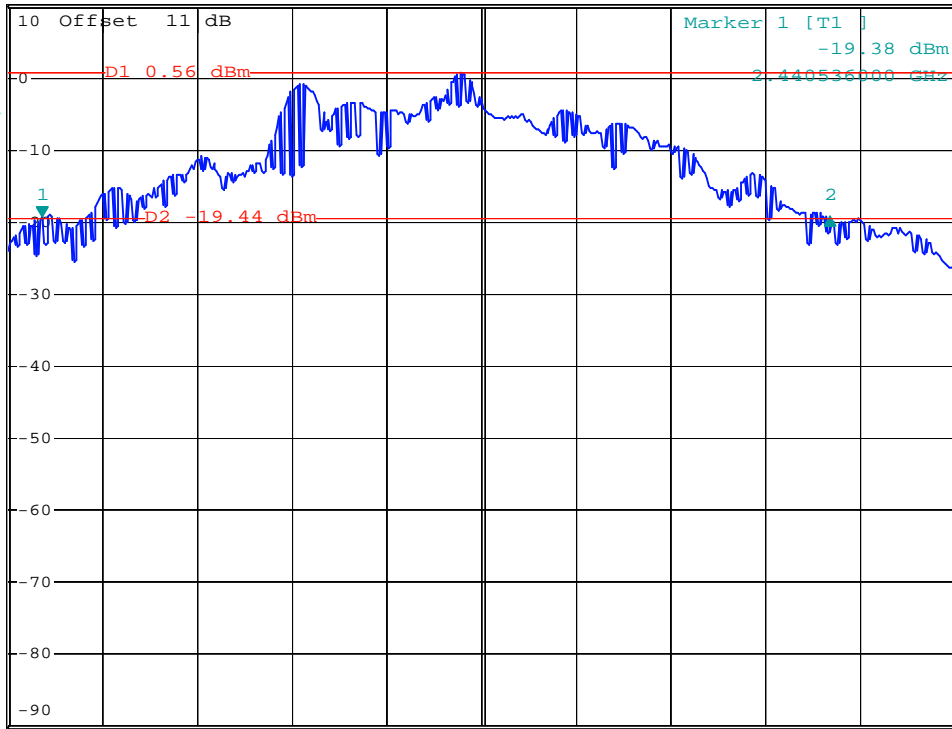

Center 2.441 GHz 100 kHz/ Span 1 MHz

Date: 30.NOV.2006 11:28:39



Mode 3: CH78 (2480MHz)



*RBW 30 kHz Delta 2 [T1]
*VBW 300 kHz -0.10 dB
*SWT 500 ms 834.000000000 kHz

Ref 10 dBm

*Att 20 dB

1 PK*
VIEW

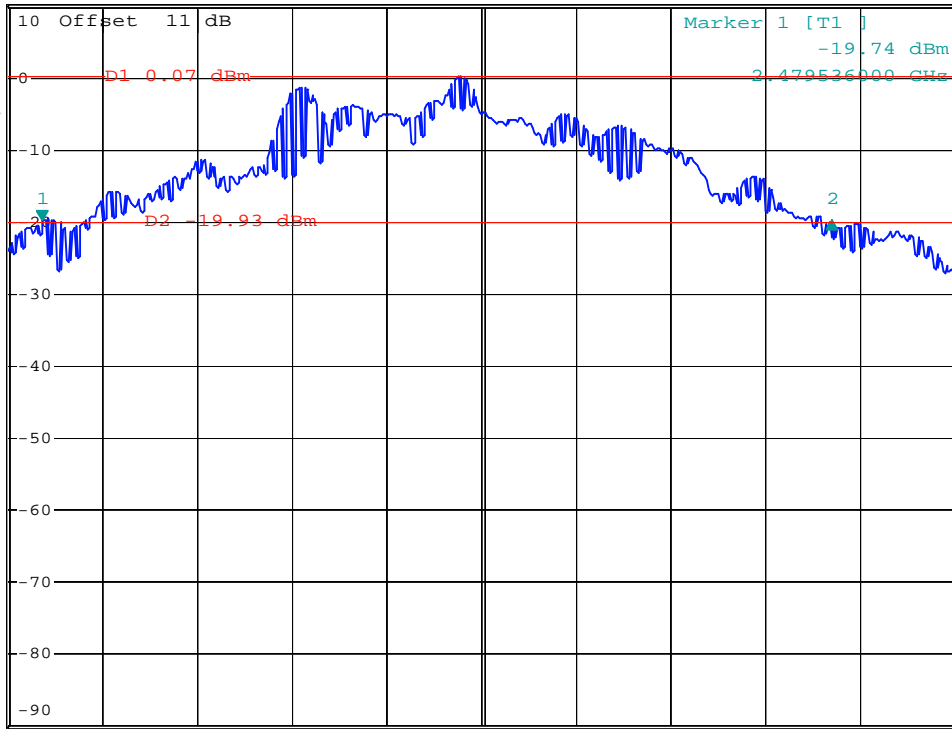

Center 2.48 GHz

100 kHz/

Span 1 MHz

Date: 30.NOV.2006 11:27:24

5.5 Dwell Time of Each Frequency within a 30 Seconds Period

5.5.1 Measuring Instruments :

As described in chapter 6 of this test report.

5.5.2 Test Procedure :

1. The transmitter output was connected to the spectrum analyzer directly.
2. Set RBW of spectrum analyzer to 1MHz and VBW to 1MHz.
3. Set the center frequency on any frequency would be measured and set the frequency span to zero span.
4. The equation = $30 \times (1600/79) \times t$ (t = the time duration of one single pulse)

5.5.3 Test Setup Layout :

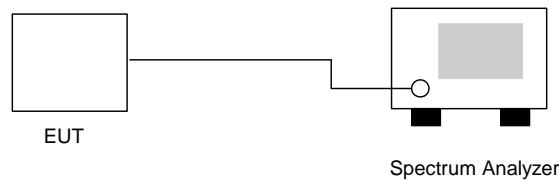

5.5.4 Test Result : See spectrum analyzer plots below

- Temperature: 24°C
- Relative Humidity: 52%
- Test Engineer : James

Ch00

Package Mode	Average Hopping Channel	Package Transfer Time (us)	Dwell Time (s)	Limit (s)
DH1	10	556	0.176	0.4
DH3	5	1820	0.288	0.4
DH5	3.4	3100	0.333	0.4



CH39

Package Mode	Average Hopping Channel	Package Transfer Time (us)	Dwell Time (s)	Limit (s)
DH1	10.1	552	0.176	0.4
DH3	5.1	1820	0.293	0.4
DH5	3.4	3100	0.333	0.4

CH78

Package Mode	Average Hopping Channel	Package Transfer Time (us)	Dwell Time (s)	Limit (s)
DH1	10.1	556	0.177	0.4
DH3	5.1	1820	0.293	0.4
DH5	3.4	3080	0.331	0.4

Remark:

- 3. Dwell Time=79(channels) x 0.4(s) x average hopping channel x package transfer time
- 4. 79channels come from the Hopping Channel number.
- 5. Average Hopping Channel = hops/sweep time
- 6. t: Package Transfer Time(us)



5.5.5 Dwell Time

DH1 (CH00)



RBW 1 MHz Delta 3 [T1]
 *VBW 1 MHz 1.69 dB
 Ref 10 dBm *Att 20 dB SWT 2 ms 1.260000 ms

1 PK*
CLRWR

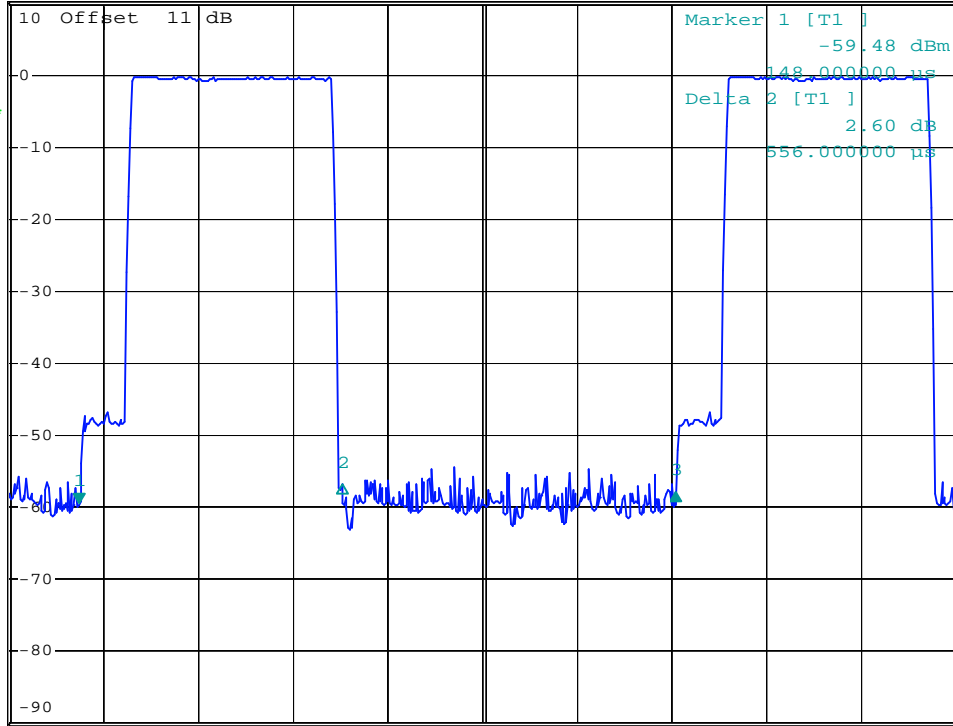

Center 2.402 GHz 200 μs/

Date: 30.NOV.2006 11:37:00



Ref 10 dBm *Att 20 dB RBW 1 MHz
*VBW 1 MHz SWT 10 s

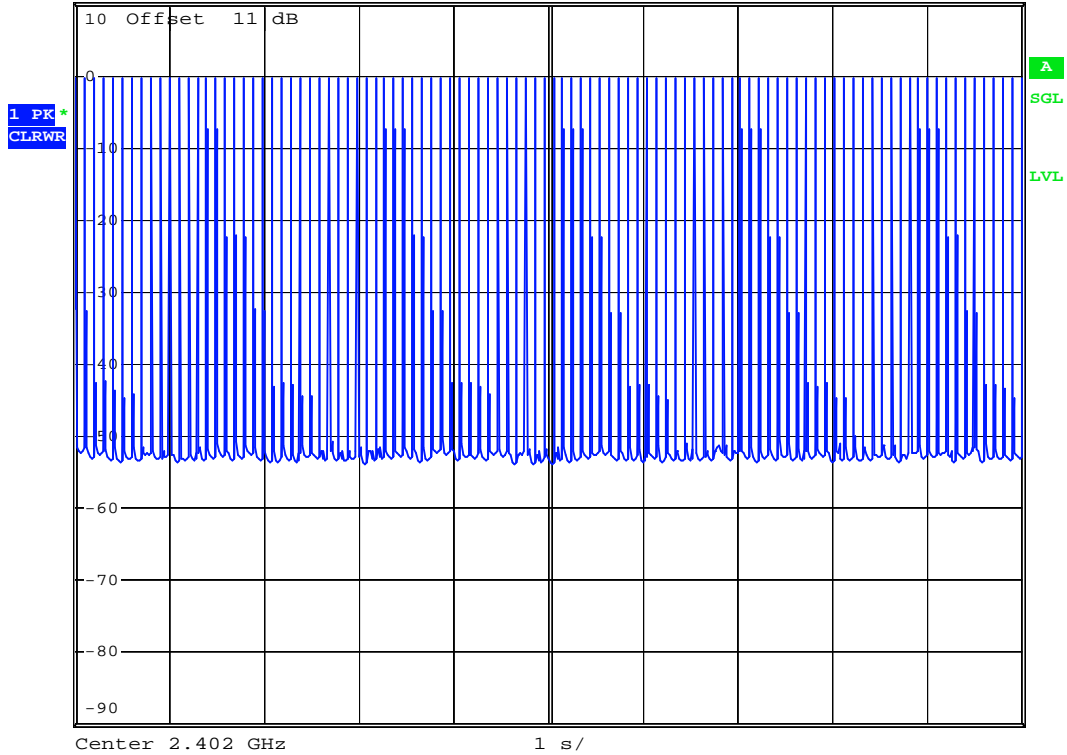

Date: 30.NOV.2006 13:22:24



DH1 (CH39)



RBW 1 MHz Delta 3 [T1]
 *VBW 1 MHz 13.30 dB
 Ref 10 dBm *Att 20 dB SWT 2 ms 1.268000 ms

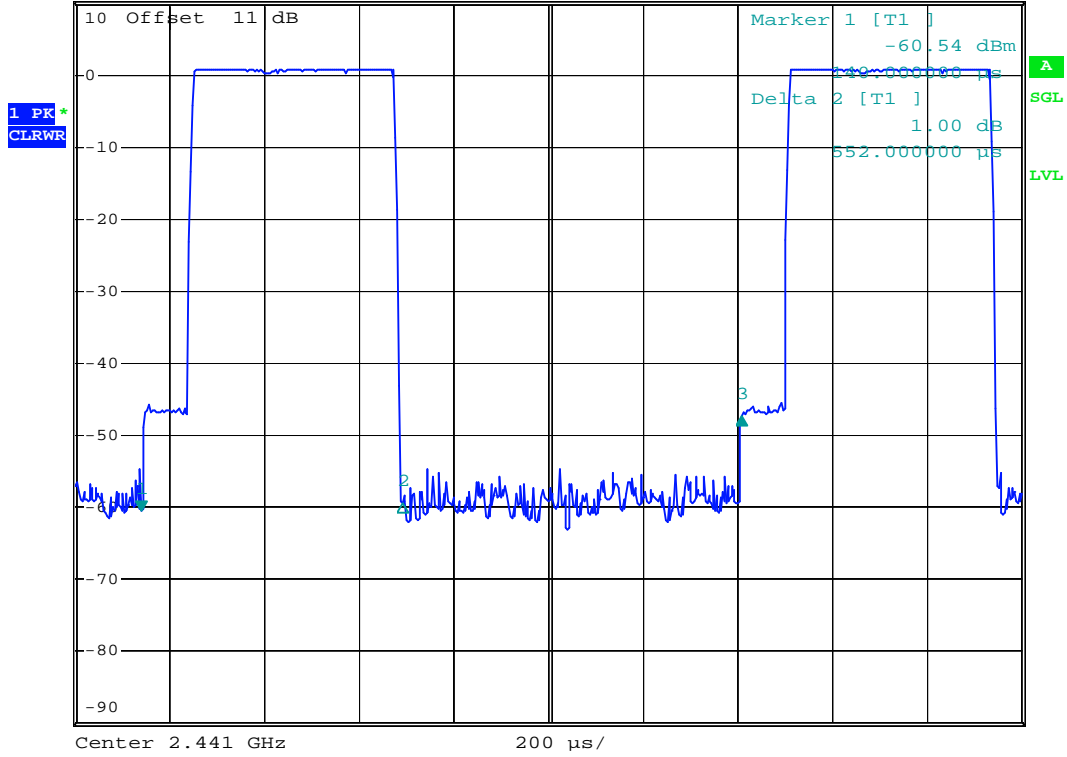

Date: 30.NOV.2006 13:10:46

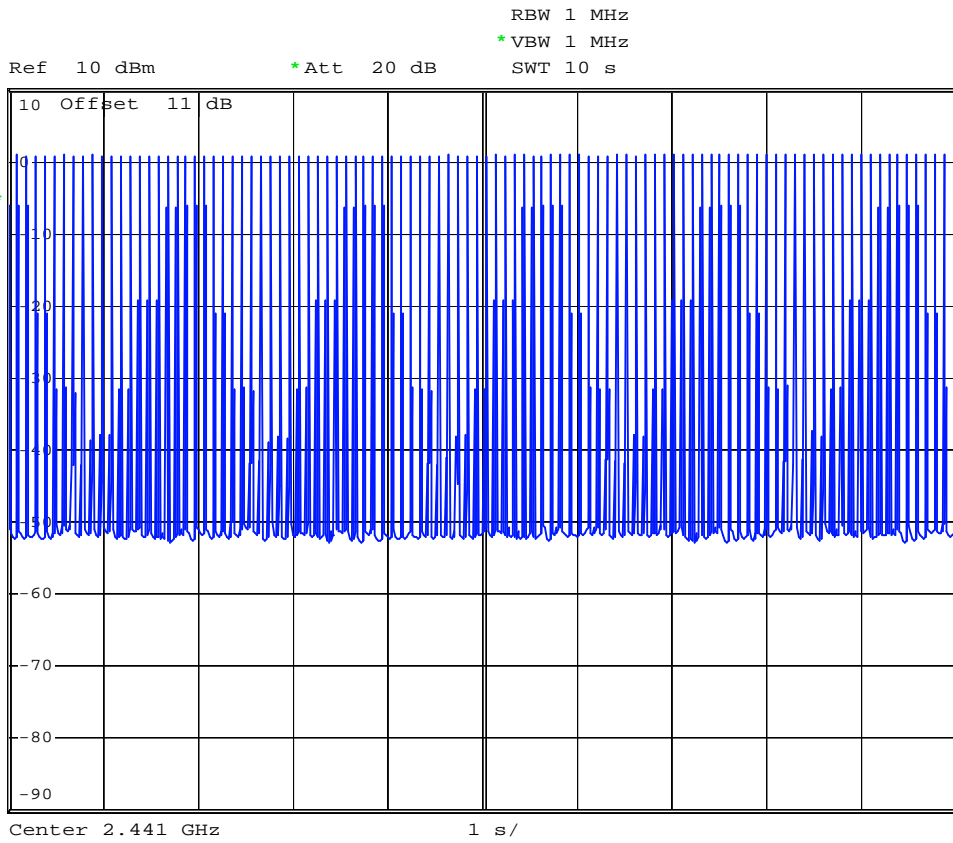

Date: 30.NOV.2006 13:22:45



DH1 (CH78)



Ref 10 dBm *Att 20 dB RBW 1 MHz Delta 3 [T1] 1.84 dB
*VBW 1 MHz SWT 2 ms 1.268000 ms

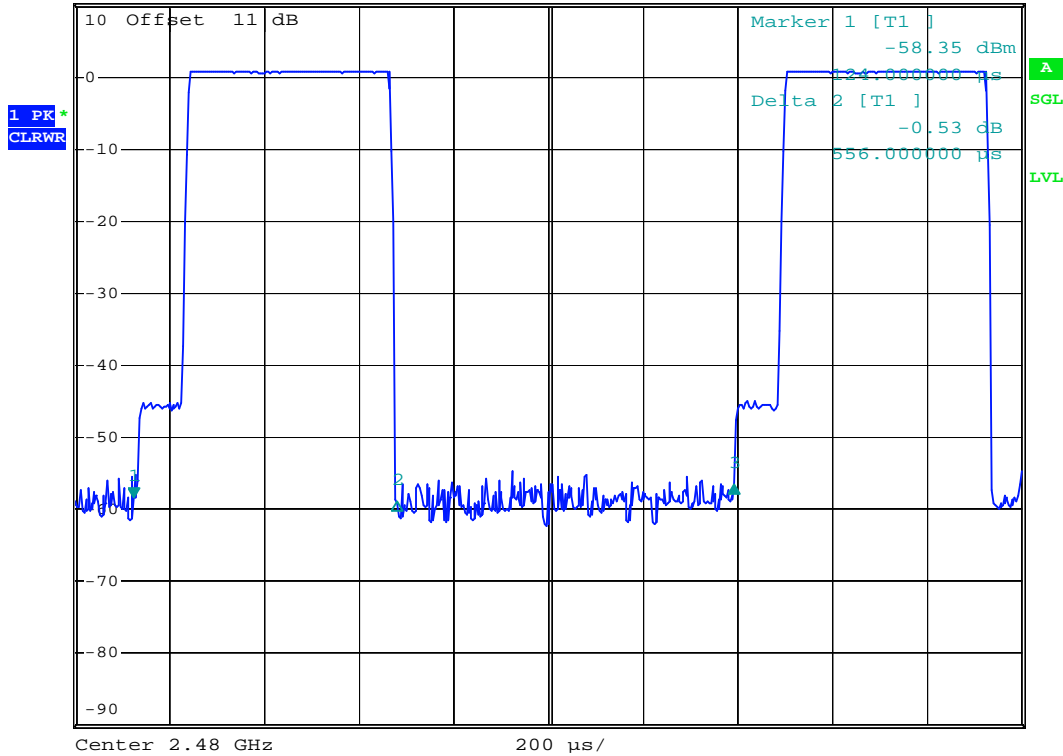

Date: 30.NOV.2006 13:12:37

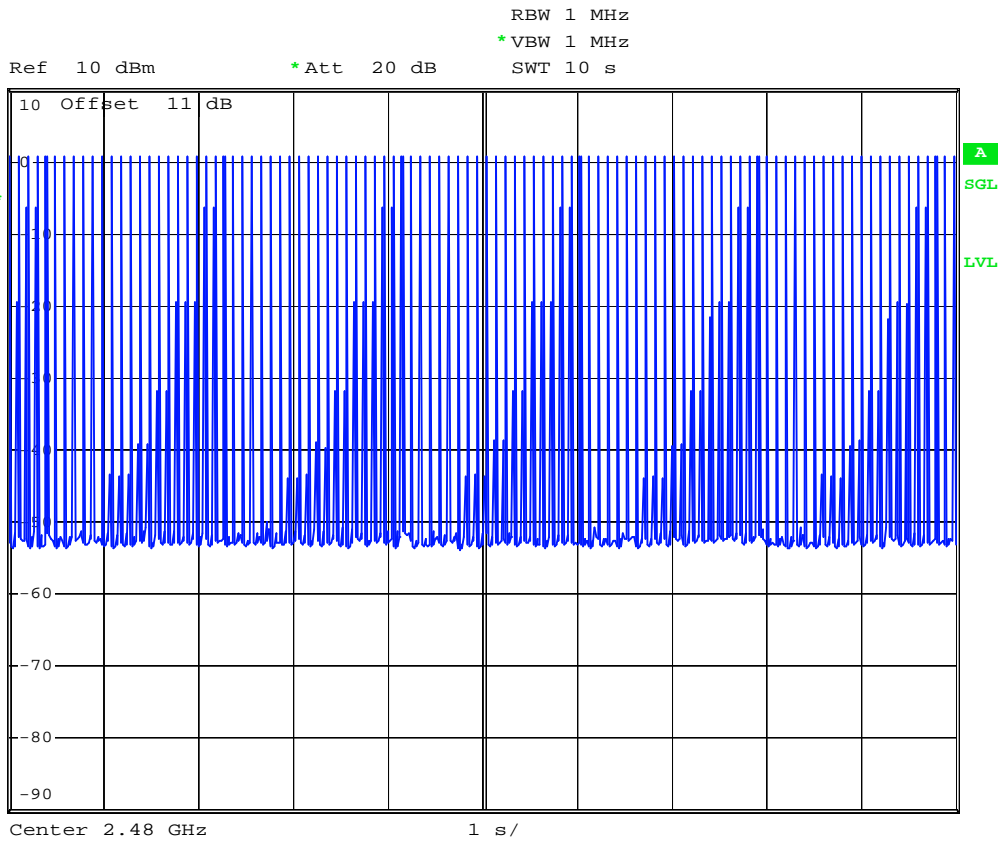

Date: 30.NOV.2006 13:23:07



DH3 (CH00)



Ref 10 dBm *Att 20 dB RBW 1 MHz Delta 3 [T1] -0.16 dB
*VBW 1 MHz SWT 5 ms 2.510000 ms

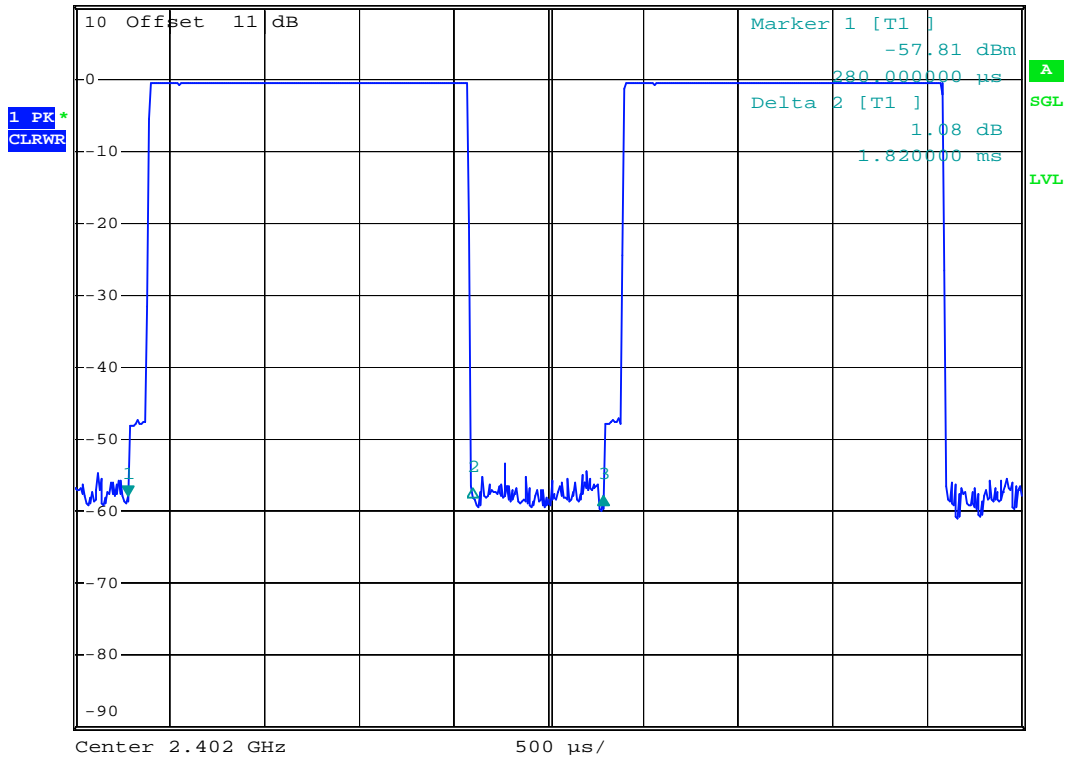

Date: 30.NOV.2006 13:16:04



Ref 10 dBm *Att 20 dB RBW 1 MHz
*VBW 1 MHz SWT 10 s

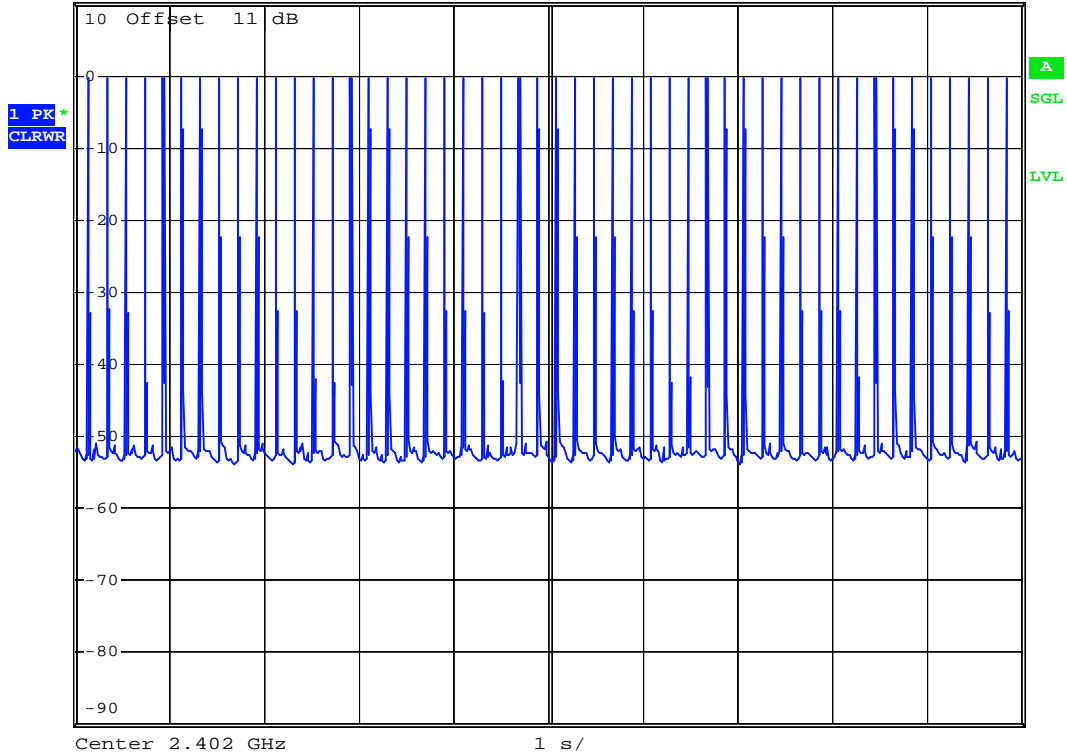

Date: 30.NOV.2006 13:24:18



DH3 (CH39)



Ref 10 dBm *Att 20 dB RBW 1 MHz Delta 3 [T1] 2.33 dB
*VBW 1 MHz 2.510000 ms
SWT 5 ms

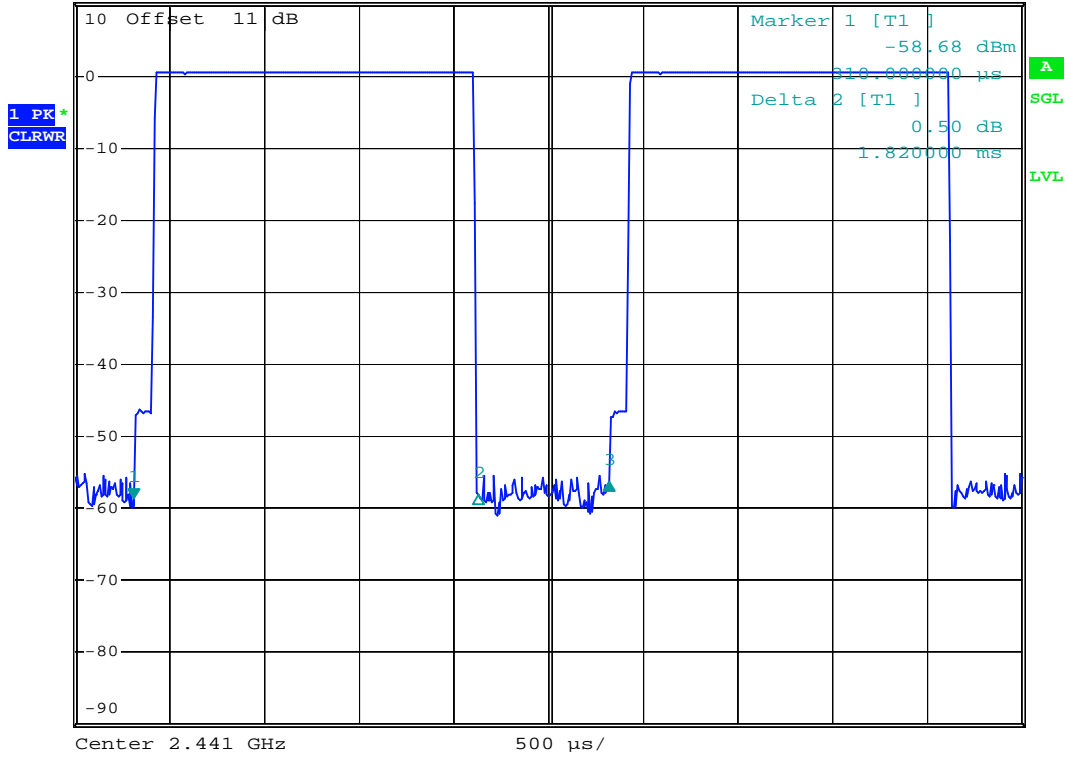

Date: 30.NOV.2006 13:16:34

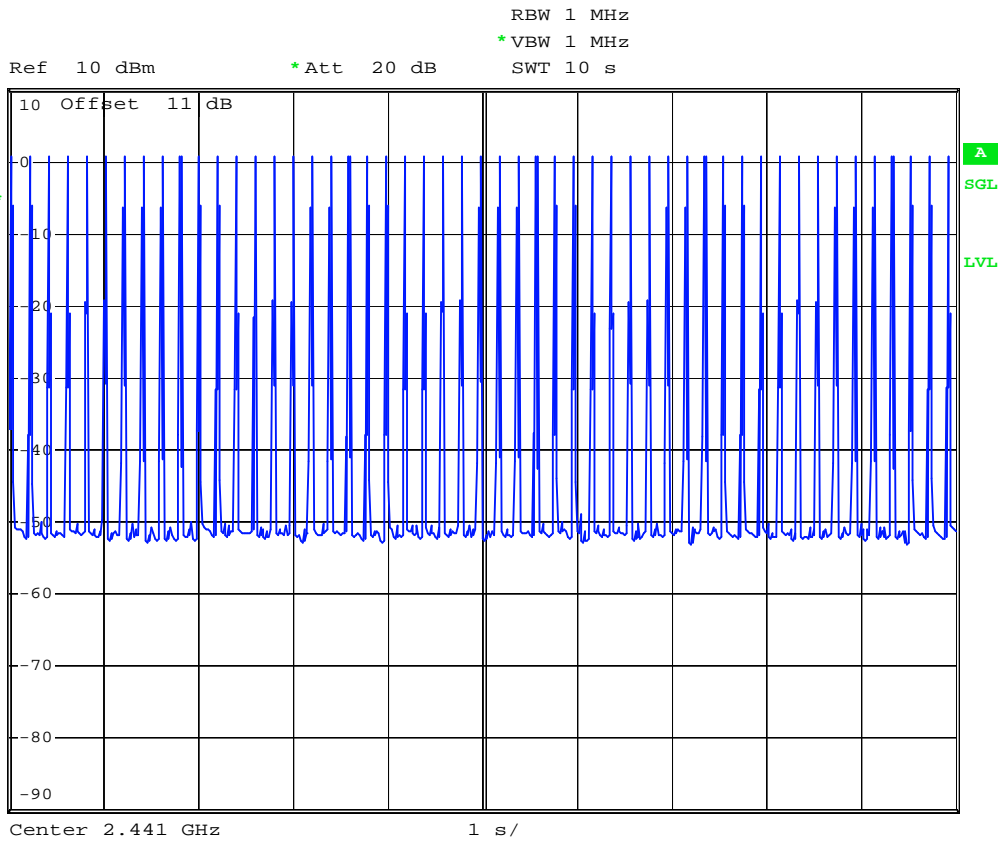

Date: 30.NOV.2006 13:24:38



DH3 (CH78)



Ref 10 dBm *Att 20 dB RBW 1 MHz Delta 3 [T1] -1.72 dB
 *VBW 1 MHz SWT 5 ms 2.500000 ms

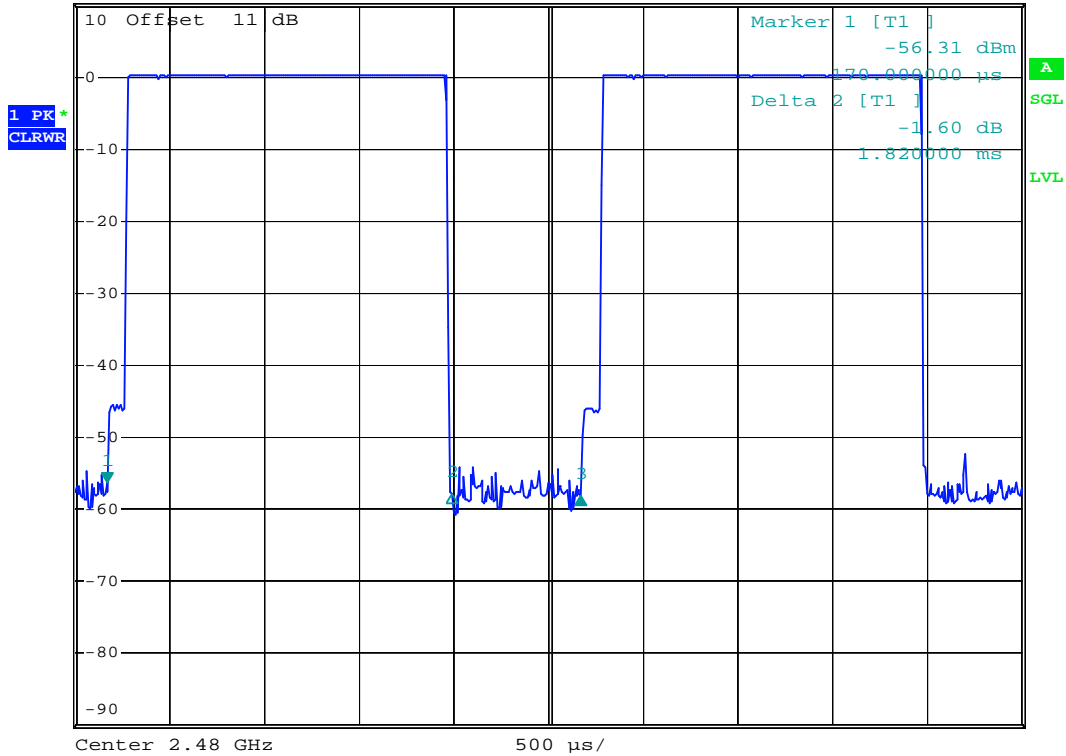

Date: 30.NOV.2006 13:17:17

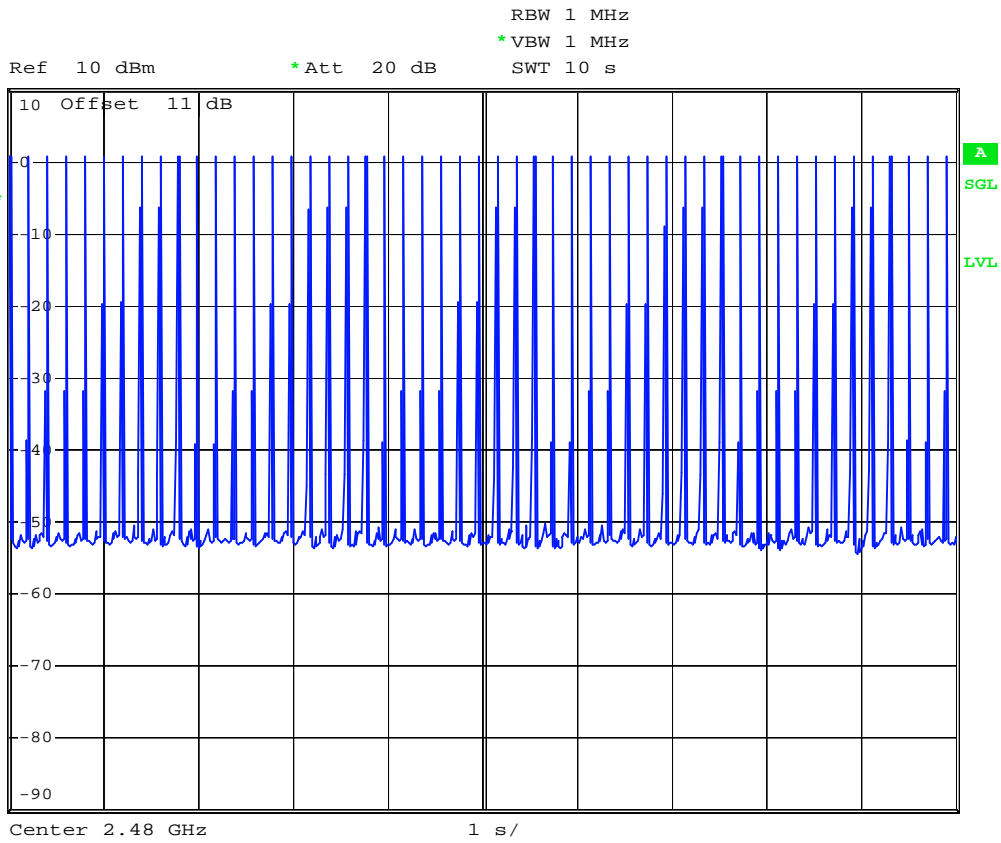

Date: 30.NOV.2006 13:24:58



DH5 (CH00)



Ref 10 dBm *Att 20 dB RBW 1 MHz Delta 3 [T1] 0.95 dB
*VBW 1 MHz SWT 10 ms 3.760000 ms

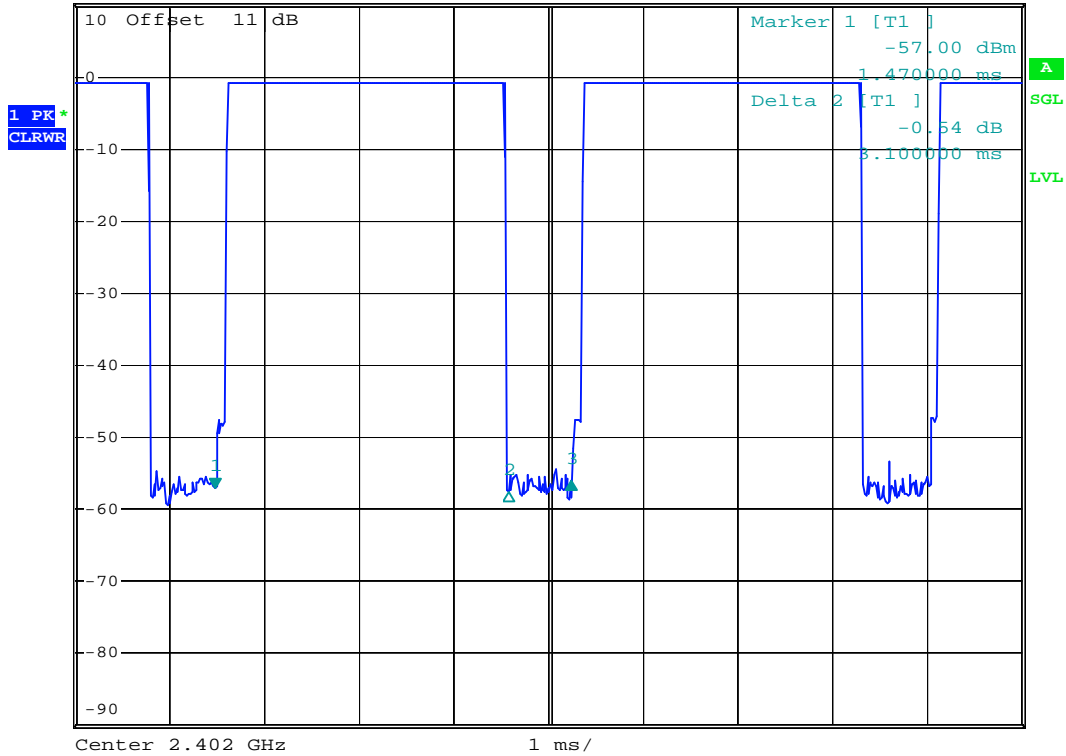

Date: 30.NOV.2006 13:18:34



Ref 10 dBm *Att 20 dB RBW 1 MHz
*VBW 1 MHz SWT 10 s

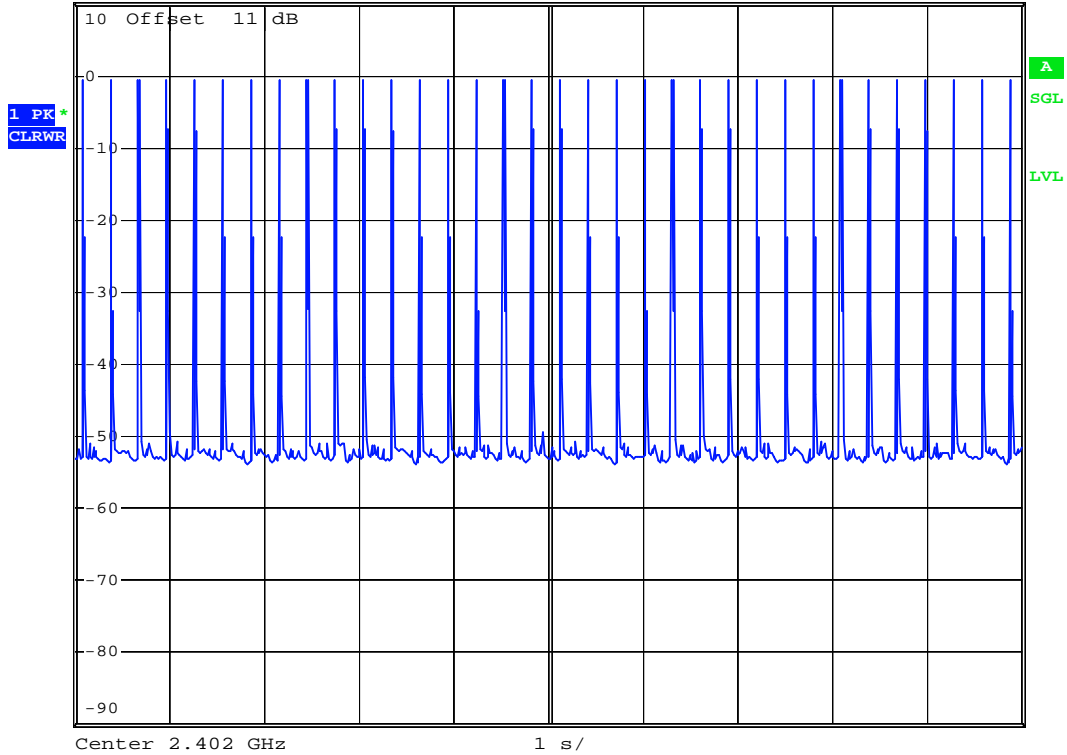

Date: 30.NOV.2006 13:25:48



DH5 (CH39)



RBW 1 MHz Delta 3 [T1]
 *VBW 1 MHz 2.31 dB
 Ref 10 dBm *Att 20 dB SWT 10 ms 3.780000 ms

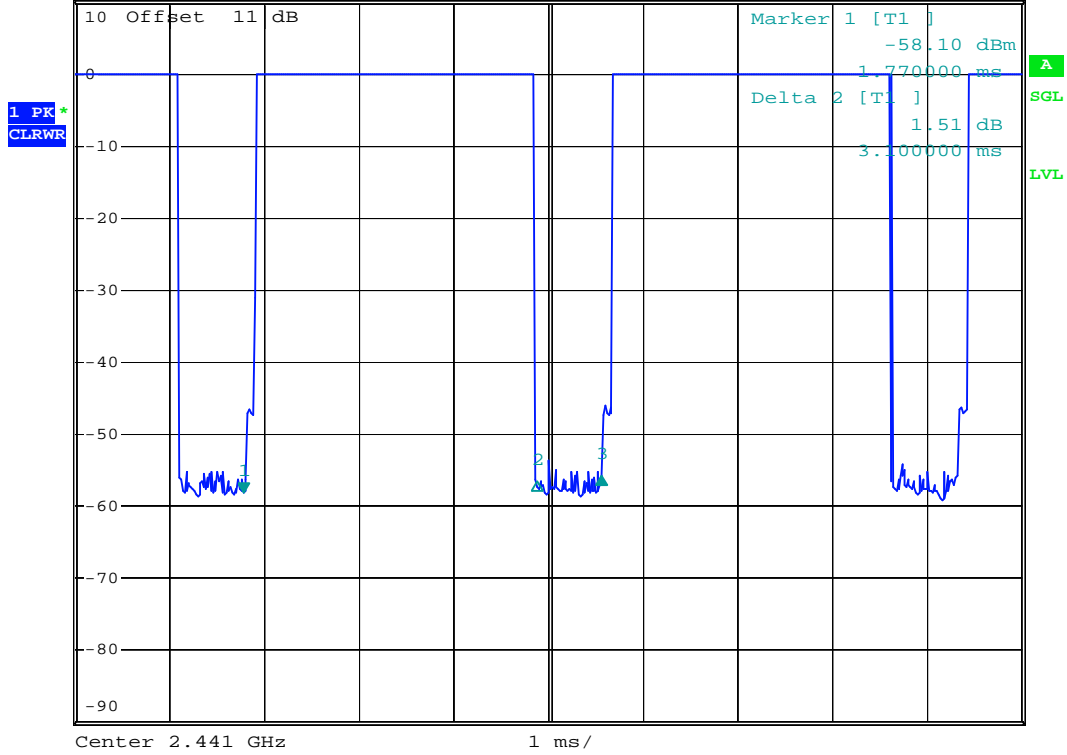

Date: 30.NOV.2006 13:19:17



Ref 10 dBm *Att 20 dB RBW 1 MHz
*VBW 1 MHz SWT 10 s

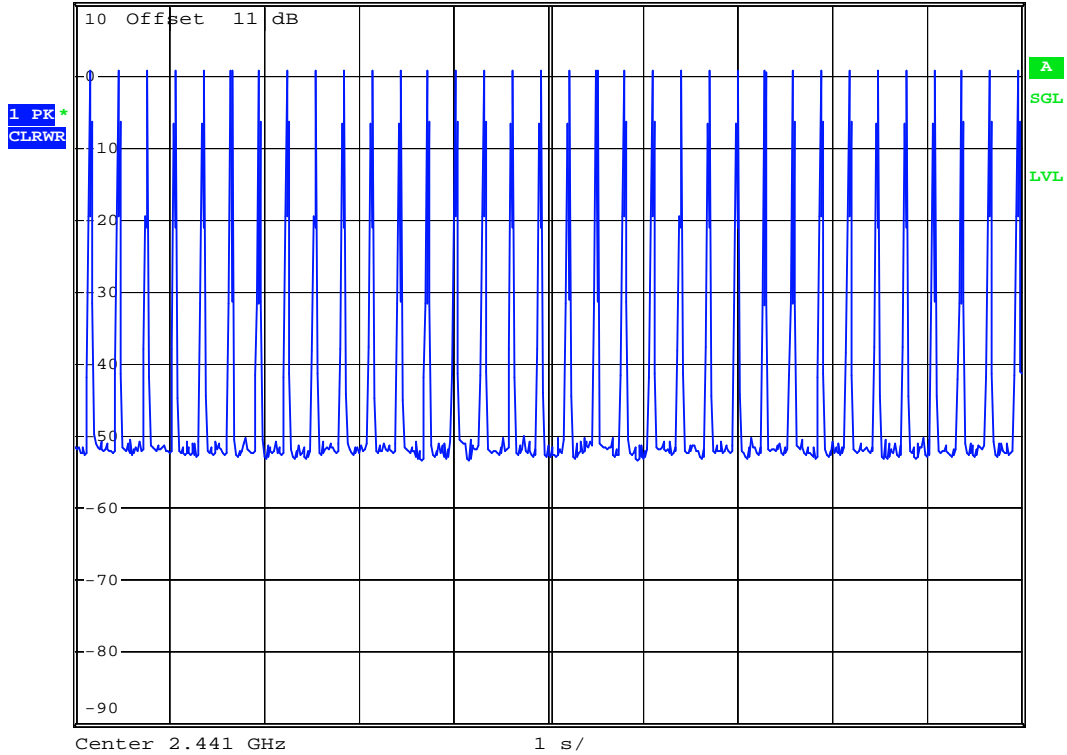

Date: 30.NOV.2006 13:26:22



DH5 (CH78)



RBW 1 MHz Delta 3 [T1]
 *VBW 1 MHz -2.19 dB
 Ref 10 dBm *Att 20 dB SWT 10 ms 3.760000 ms

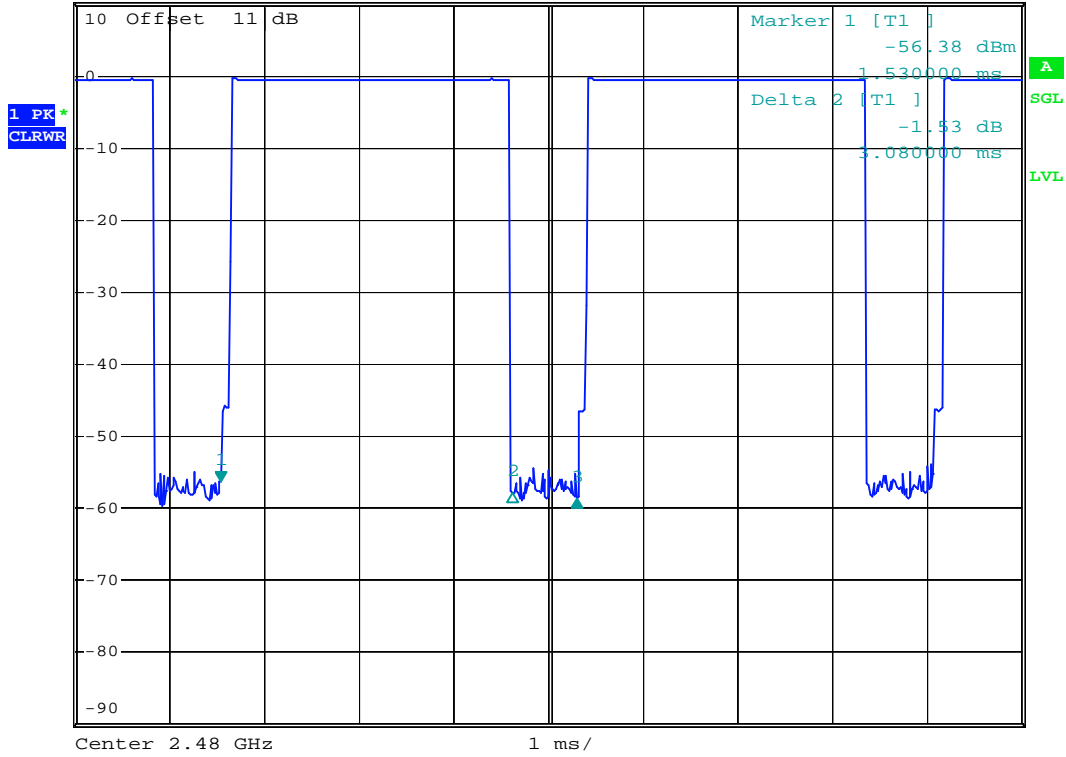

Date: 30.NOV.2006 13:20:10



Ref 10 dBm *Att 20 dB RBW 1 MHz
*VBW 1 MHz SWT 10 s

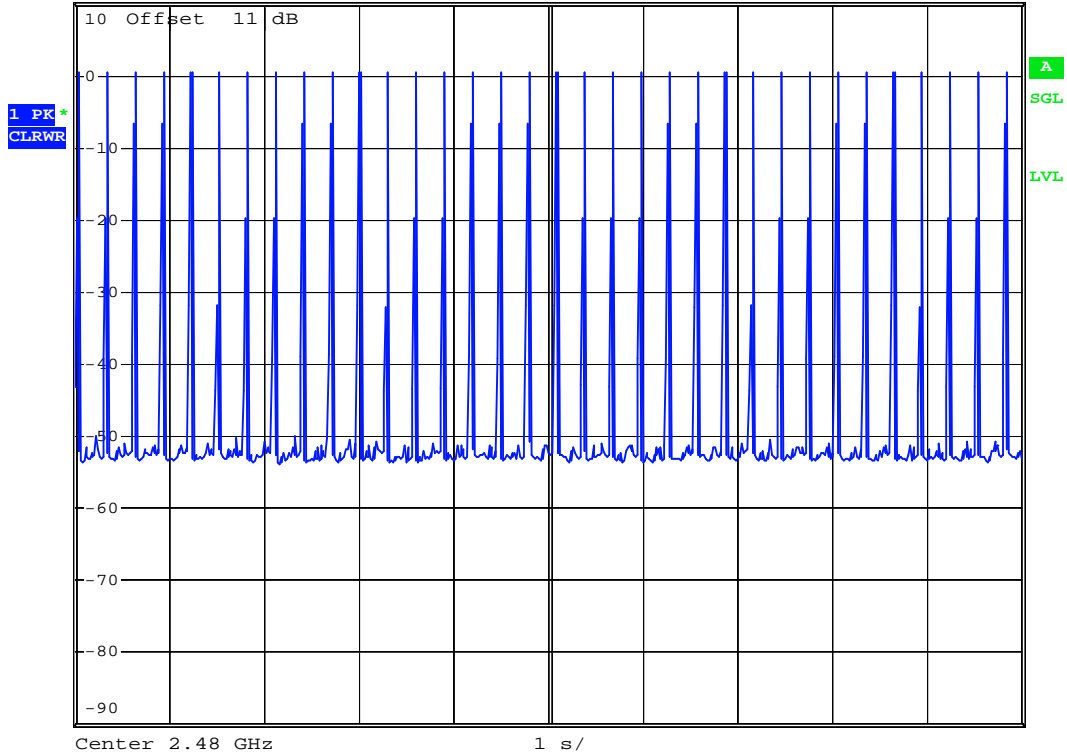

Date: 30.NOV.2006 13:27:03

5.6 Output Power

5.6.1 Measuring Instruments :

As described in chapter 6 of this test report.

5.6.2 Test Procedure :

1. The transmitter output was connected to the spectrum analyzer directly.
2. The center frequency of the spectrum analyzer was set to the fundamental frequency and set RBW to 3MHz and VBW to 3MHz.

5.6.3 Test Setup Layout :

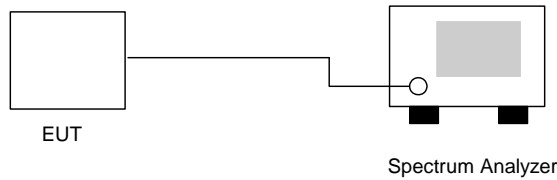

5.6.4 Test Result : See spectrum analyzer plots below

- Temperature: 24°C
- Relative Humidity: 52%
- Test Engineer : James

Channel	Frequency (MHz)	Measured Output Power (dBm)	Limits (Watt/dBm)	Plot Ref. No.
00	2402	-0.52	1W/30 dBm	Mode 1
39	2441	0.59	1W/30 dBm	Mode 2
78	2480	-0.19	1W/30 dBm	Mode 3



Mode 2: CH39 (2441MHz)



*RBW 3 MHz Marker 1 [T1]
*VBW 3 MHz 0.59 dBm
*SWT 500 ms 2.440910000 GHz

Ref 10 dBm

*Att 20 dB

1 PK
MAXH

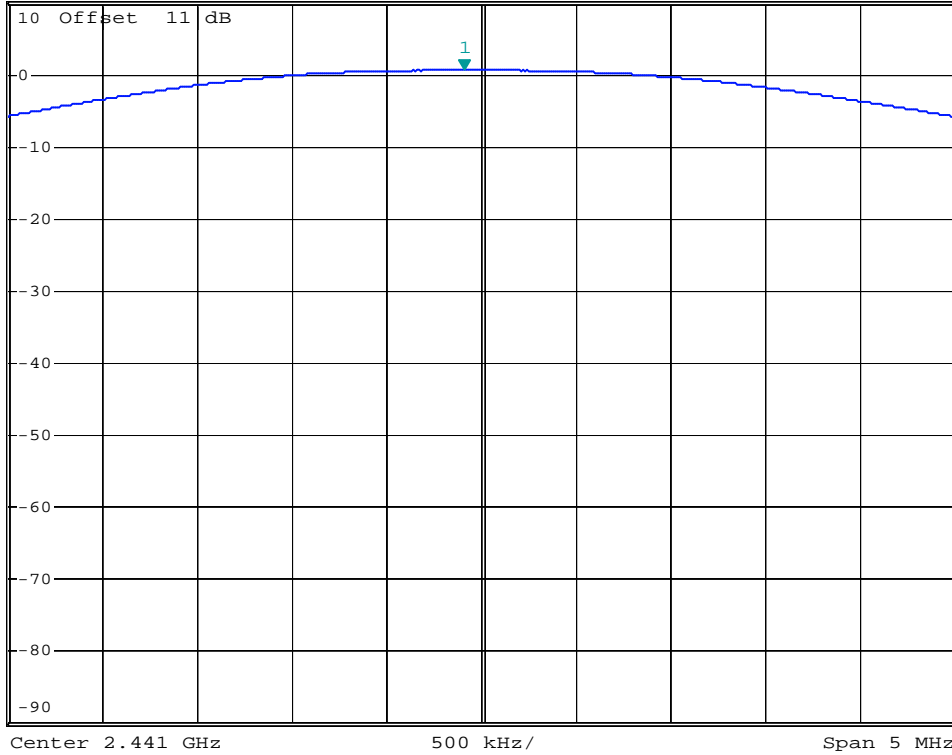

Date: 30.NOV.2006 11:25:48



Mode 3: CH78 (2480MHz)



*RBW 3 MHz Marker 1 [T1]
*VBW 3 MHz -0.19 dBm
*SWT 500 ms 2.479910000 GHz

Ref 10 dBm

*Att 20 dB

1 PK
MAXH

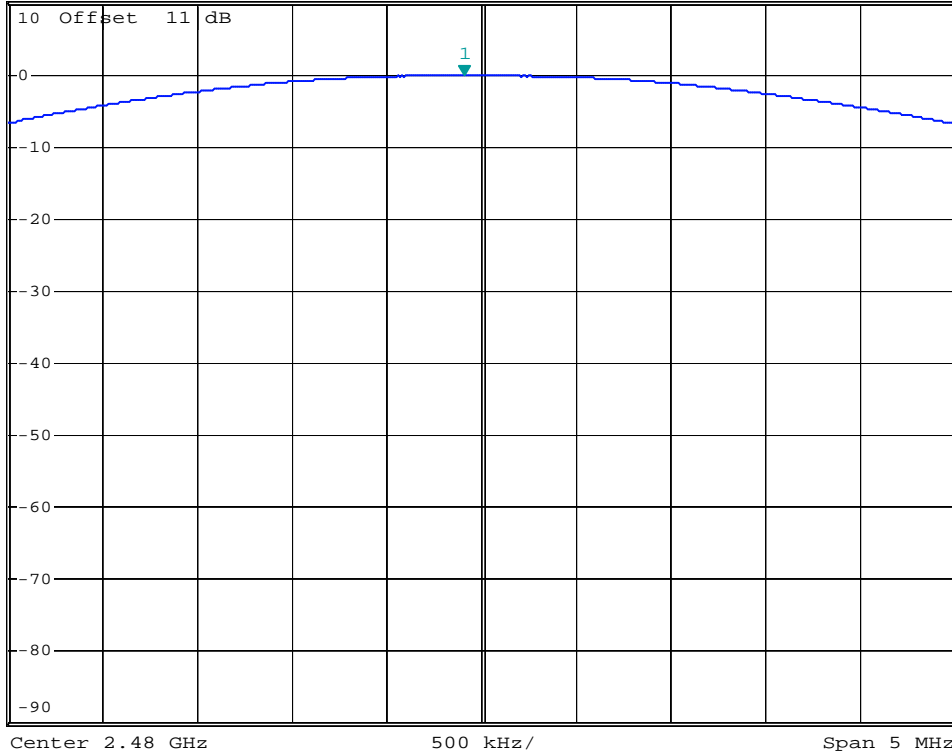

Date: 30.NOV.2006 11:26:16



5.7 100kHz Bandwidth of Frequency Band Edges

5.7.1 Measuring Instruments :

As described in chapter 6 of this test report.

5.7.2 Test Procedure :

- 1. The transmitter output was connected to the spectrum analyzer via a low lose cable.
2. Set both RBW and VBW of spectrum analyzer to 100kHz with suitable frequency span for the conducted measurement, and RBW/VBW=1MHz/1MHz for peak measurement and RBW/VBW=1MHz/300Hz for average measurement in the radiated measurement.
3. The band edges was measured and recorded.

5.7.3 Test Result :

- Temperature: 24°C
Relative Humidity: 52%
Test Engineer : James

Test Result in lower band (Channel 00) : PASS

Test Result in higher band(Channel 78) : PASS

5.7.4 Note on Band edge Emission

CH00 (Horizontal)

Table with 12 columns: Frequency, Level, Over Limit, Limit Line, Read Level, Antenna Factor, Cable Loss, Preamp Factor, Ant Pos, Table Pos, Detect Mode. Rows for frequencies 2375.8 MHz (Peak and Average).

CH00 (Vertical)

Table with 12 columns: Frequency, Level, Over Limit, Limit Line, Read Level, Antenna Factor, Cable Loss, Preamp Factor, Ant Pos, Table Pos, Detect Mode. Rows for frequencies 2356.6 MHz (Peak and Average).



CH78 (Horizontal)

Frequency (MHz)	Level (dBuV/m)	Over Limit (dB)	Limit Line (dBuV/m)	Read Level (dBuV)	Antenna Factor (dB)	Cable Loss (dB)	Preamp Factor (dB)	Ant Pos (cm)	Table Pos (deg)	Detect Mode
2483.5	55.84	-18.16	74.00	57.20	30.29	3.86	35.51	100	0	Peak
2483.5	50.33	-3.67	54.00	51.69	30.29	3.86	35.51	100	8	Average

CH78 (Vertical)

Frequency (MHz)	Level (dBuV/m)	Over Limit (dB)	Limit Line (dBuV/m)	Read Level (dBuV)	Antenna Factor (dB)	Cable Loss (dB)	Preamp Factor (dB)	Ant Pos (cm)	Table Pos (deg)	Detect Mode
2483.5	59.54	-14.46	74.00	60.90	30.29	3.86	35.51	100	0	Peak
2483.5	53.64	-0.36	54.00	55.00	30.29	3.86	35.51	100	145	Average



5.7.5 Frequency Band Edge

CH00 (2402 MHz)



Ref 10 dBm * Att 20 dB * RBW 100 kHz Marker 1 [T1]
* VBW 100 kHz -33.17 dBm
* SWT 500 ms 2.399600000 GHz

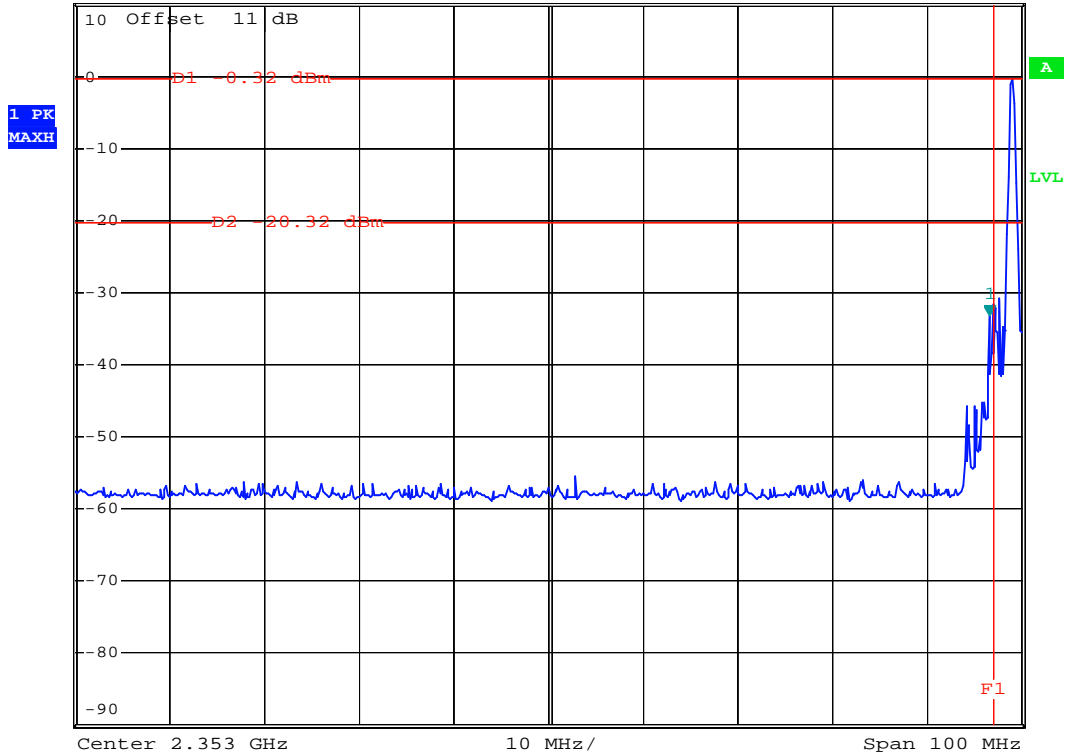

Date: 30.NOV.2006 11:31:34



CH78 (2480 MHz)



*RBW 100 kHz Marker 1 [T1]
*VBW 100 kHz -43.09 dBm
*SWT 500 ms 2.484400000 GHz

Ref 10 dBm

*Att 20 dB

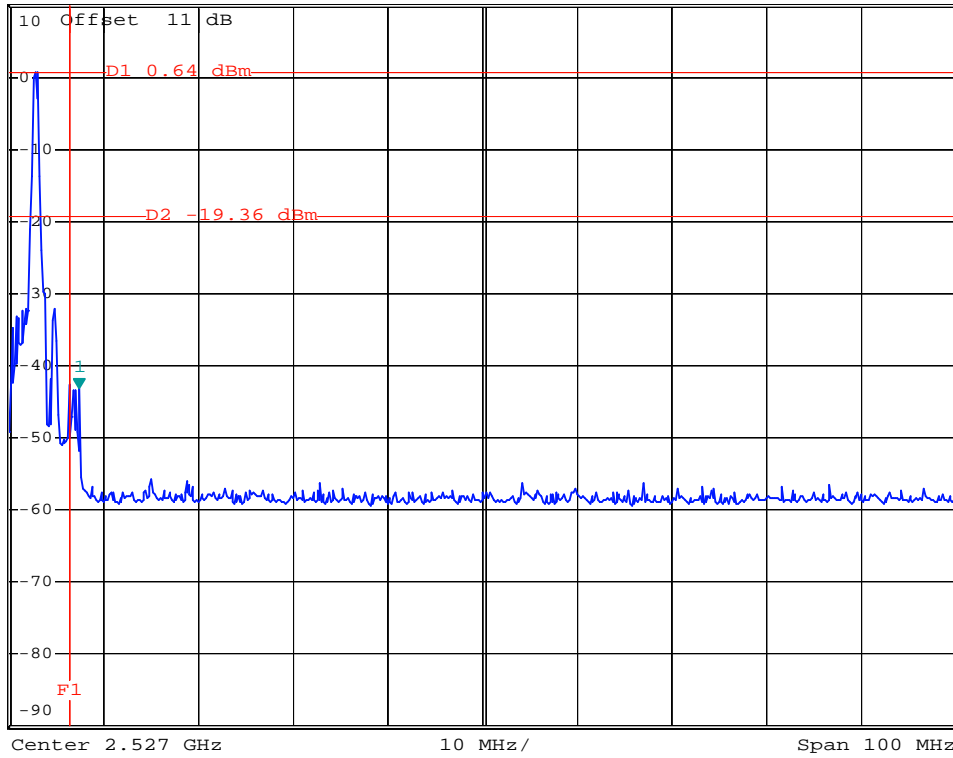

Date: 30.NOV.2006 11:32:24



5.8 Conducted Emission

5.8.1 Measuring Instruments

As described in chapter 6 of this test Report.

5.8.2 Test Procedures :

- a. The EUT was placed 0.4 meter from the conducting wall of the shielding room was kept at least 80 centimeters from any other grounded conducting surface.
- b. Connect EUT to the power port of a line impedance stabilization network (LISN).
- c. All the support units are connected to the other LISN.
- d. The LISN provides 50 ohm coupling impedance for the measuring instrument.
- e. The FCC states that a 50 ohm, 50 microhenry LISN should be used.
- f. Both sides of AC line were checked for maximum conducted interference.
- g. The frequency range from 150 kHz to 30 MHz was searched.
- h. Set the test-receiver system to Peak Detect Function and specified bandwidth with Maximum Hold Mode.



5.8.3 Test Data Test Mode 1

- Temperature: 24°C
- Relative Humidity: 52%
- Test Engineer : James

The test that passed at minimum margin was marked by the frame in the following table.

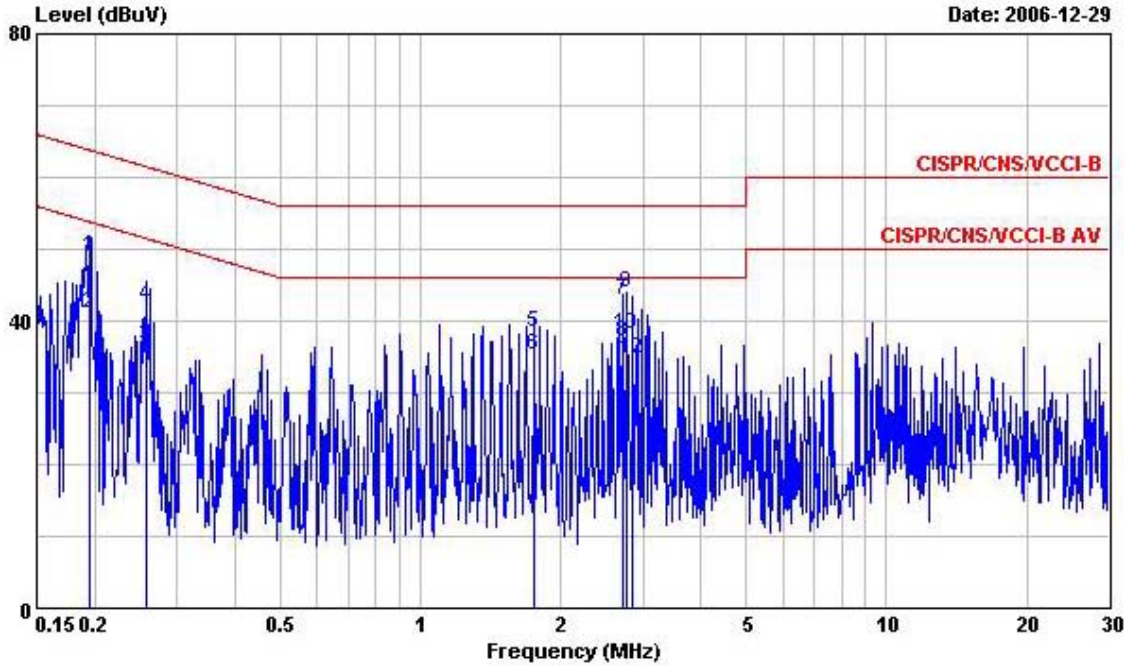

Site : CO04-HY
 Condition : CISPR/CNS/VCCI-B LISN 200604 99041 LINE
 EUT : PDA
 POWER: 120V/60Hz
 MODEL : 528
 MEMO : BT LINK
 MEMO : +ADAPTER+POD4+USB 1+USB 2+Docking 1
 MEMO :

	Freq	Level	Over Limit	Limit Line	Read Level	LISN Factor	Cable Loss	Remark
	MHz	dBuV	dB	dBuV	dBuV	dB	dB	
1	0.1944650	49.05	-14.79	63.84	48.73	0.10	0.22	QP
2	0.1944650	41.03	-12.81	53.84	40.71	0.10	0.22	Average
3	0.2575110	36.66	-14.85	51.51	36.38	0.10	0.18	Average
4	0.2575110	42.02	-19.49	61.51	41.74	0.10	0.18	QP
5	1.746	38.42	-17.58	56.00	38.12	0.10	0.20	QP
6	1.746	35.33	-10.67	46.00	35.03	0.10	0.20	Average
7	2.714	42.89	-13.11	56.00	42.52	0.10	0.27	QP
8	2.714	37.22	-8.78	46.00	36.85	0.10	0.27	Average
9	2.780	43.96	-12.04	56.00	43.58	0.10	0.28	QP
10	2.780	38.03	-7.97	46.00	37.65	0.10	0.28	Average
11	2.850	25.61	-20.39	46.00	25.22	0.10	0.29	Average
12	2.850	34.61	-21.39	56.00	34.22	0.10	0.29	QP

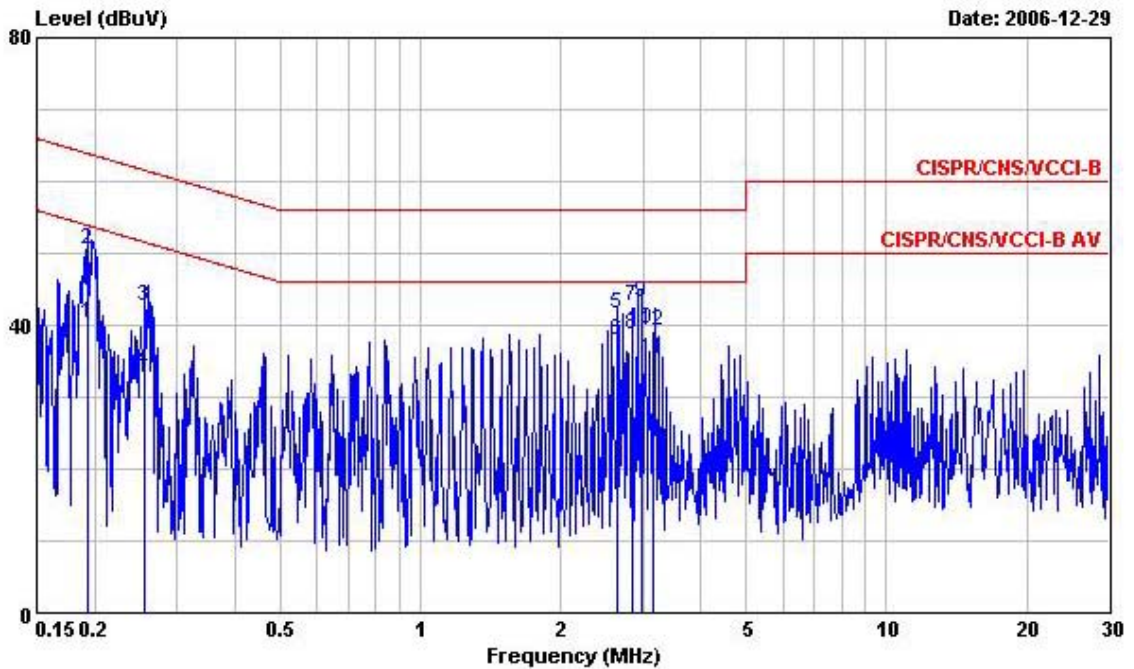

Site : CO04-HY
 Condition : CISPR/CNS/VCCI-B LISN 200604 99041 NEUTRAL
 EUT : PDA
 POWER: 120V/60Hz
 MODEL : 528
 MEMO : BT LINK
 MEMO : +ADAPTER+POD4+USB 1+USB 2+Docking 1
 MEMO :

	Freq	Level	Over Limit	Limit Line	Read Level	LISN Factor	Cable Loss	Remark
	MHz	dBuV	dB	dBuV	dBuV	dB	dB	
1			-13.60	53.89	39.97	0.10	0.22	Average
2	0.1934380	50.45	-13.44	63.89	50.13	0.10	0.22	QP
3	0.2561610	42.73	-18.82	61.55	42.44	0.10	0.19	QP
4	0.2561610	33.76	-17.79	51.55	33.47	0.10	0.19	Average
5	2.650	41.46	-14.54	56.00	41.05	0.14	0.27	QP
6	2.650	37.97	-8.03	46.00	37.56	0.14	0.27	Average
7	2.845	42.60	-13.40	56.00	42.16	0.15	0.29	QP
8	2.845	38.68	-7.32	46.00	38.24	0.15	0.29	Average
9	2.974	43.27	-12.73	56.00	42.81	0.16	0.30	QP
10	2.974	39.41	-6.59	46.00	38.95	0.16	0.30	Average
11	3.170	35.16	-10.84	46.00	34.69	0.17	0.30	Average
12	3.170	39.20	-16.80	56.00	38.73	0.17	0.30	QP



5.8.4 Test Data Test Mode 2

- Temperature: 24°C
- Relative Humidity: 52%
- Test Engineer : James

The test that passed at minimum margin was marked by the frame in the following table.

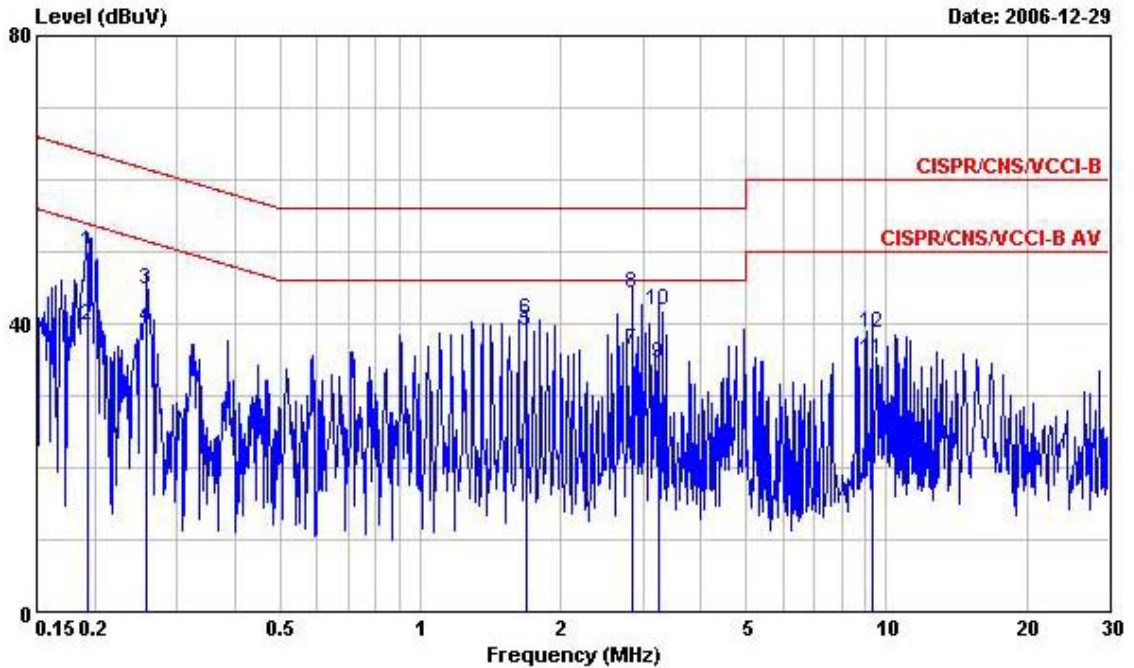

Site : CO04-HY
 Condition : CISPR/CNS/VCCI-B LISN 200604 99041 LINE
 EUT : PDA
 POWER: 120V/60Hz
 MODEL : 529
 MEMO : BT LINK
 MEMO : +ADAPTER+POD4+USB 1+USB 2+Docking 1
 MEMO :

	Freq	Level	Over Limit	Limit Line	Read Level	LISN Factor	Cable Loss	Remark
	MHz	dBuV	dB	dBuV	dBuV	dB	dB	
1	0.1934380	50.09	-13.80	63.89	49.77	0.10	0.22	QP
2	0.1934380	39.77	-14.12	53.89	39.45	0.10	0.22	Average
3	0.2588790	44.62	-16.85	61.47	44.34	0.10	0.18	QP
4	0.2588790	39.40	-12.07	51.47	39.12	0.10	0.18	Average
5	1.680	39.04	-6.96	46.00	38.74	0.10	0.20	Average
6	1.680	40.59	-15.41	56.00	40.29	0.10	0.20	QP
7	2.844	36.29	-9.71	46.00	35.90	0.10	0.29	Average
8	2.844	44.10	-11.90	56.00	43.71	0.10	0.29	QP
9	3.232	34.52	-11.48	46.00	34.12	0.10	0.30	Average
10	3.232	41.83	-14.17	56.00	41.43	0.10	0.30	QP
11	9.369	34.94	-15.06	50.00	34.36	0.19	0.39	Average
12	9.369	38.72	-21.28	60.00	38.14	0.19	0.39	QP

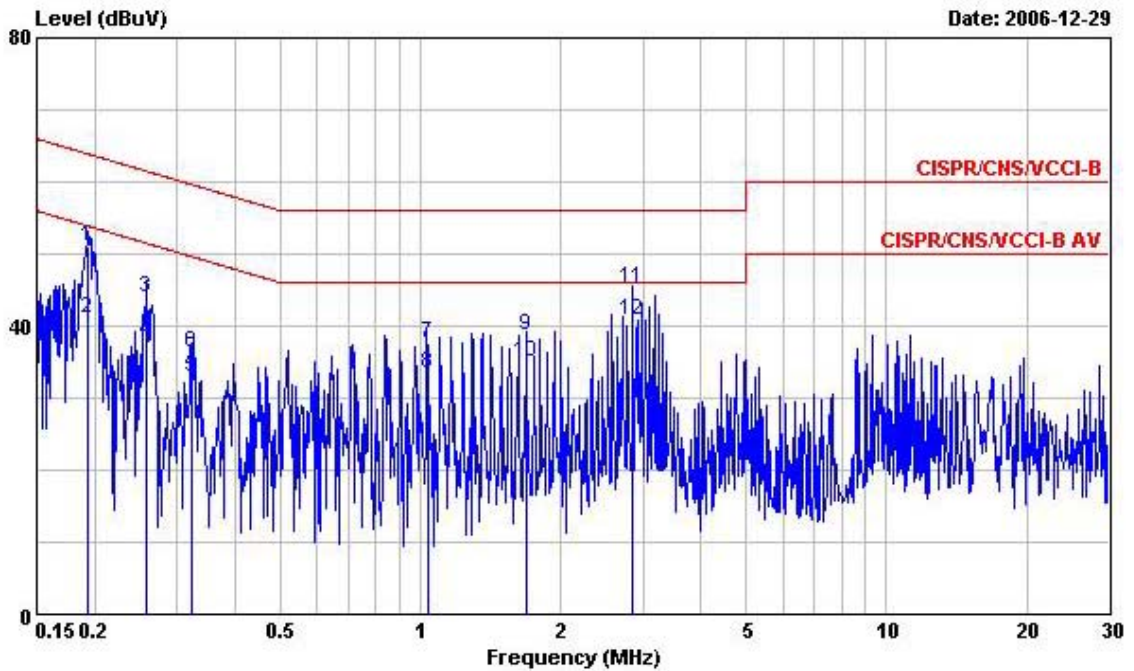

Site : CO04-HY
 Condition : CISPR/CNS/VCCI-B LISN 200604 99041 NEUTRAL
 EUT : PDA
 POWER: 120V/60Hz
 MODEL : 529
 MEMO : BT LINK
 MEMO : +ADAPTER+POD4+USB 1+USB 2+Docking 1
 MEMO :

	Freq	Level	Over Limit	Limit Line	Read Level	LISN Factor	Cable Loss	Remark
	MHz	dBuV	dB	dBuV	dBuV	dB	dB	
1	0.1934480	50.93	-12.96	63.89	50.61	0.10	0.22	QP
2	0.1934480	41.03	-12.86	53.89	40.71	0.10	0.22	Average
3	0.2588790	44.05	-17.42	61.47	43.77	0.10	0.18	QP
4	0.2588790	37.79	-13.68	51.47	37.51	0.10	0.18	Average
5	0.3236790	32.79	-16.82	49.61	32.59	0.10	0.10	Average
6	0.3236790	36.24	-23.37	59.61	36.04	0.10	0.10	QP
7	1.035	37.51	-18.49	56.00	37.21	0.10	0.20	QP
8	1.035	33.52	-12.48	46.00	33.22	0.10	0.20	Average
9	1.680	38.67	-17.33	56.00	38.37	0.10	0.20	QP
10	1.680	35.09	-10.91	46.00	34.79	0.10	0.20	Average
11	2.844	45.18	-10.82	56.00	44.74	0.15	0.29	QP
12	2.844	40.77	-5.23	46.00	40.33	0.15	0.29	Average



5.9 Radiated Emission Measurement

5.9.1 Measuring Instruments

As described in chapter 6 of this Report.

5.9.2 Test Procedures

1. The EUT was placed on a rotatable table top 0.8 meter above ground.
2. The EUT was set 3 meters from the interference receiving antenna which was mounted on the top of a variable height antenna tower.
3. The table was rotated 360 degrees to determine the position of the highest radiation.
4. The antenna is a broadband antenna and its height is varied between one meter and four meters above ground to find the maximum value of the field strength for both horizontal polarization and vertical polarization of the antenna.
5. For each suspected emission, the EUT was arranged to its worst case and then tune the antenna tower (from 1 m to 4 m) and turntable (from 0 degree to 360 degrees) to find the maximum reading.
6. Set the test-receiver system to Peak or CISPR quasi-peak Detect Function and specified bandwidth with Maximum Hold Mode.
7. For testing below 1GHz, If the emission level of the EUT in peak mode was 3 dB lower than the limit specified, then testing will be stopped and peak values of EUT will be reported, otherwise, the emissions will be repeated one by one using the quasi-peak method and reported.
8. For testing above 1GHz, the emission level of the EUT in peak mode was 20dB lower than average limit (that means the emission level in average mode also complies with the limit in average mode), then testing will be stopped and peak values of EUT will be reported, otherwise, the emissions will be measured in average mode again and reported.

5.9.3 Typical Test Setup Layout of Radiated Emission

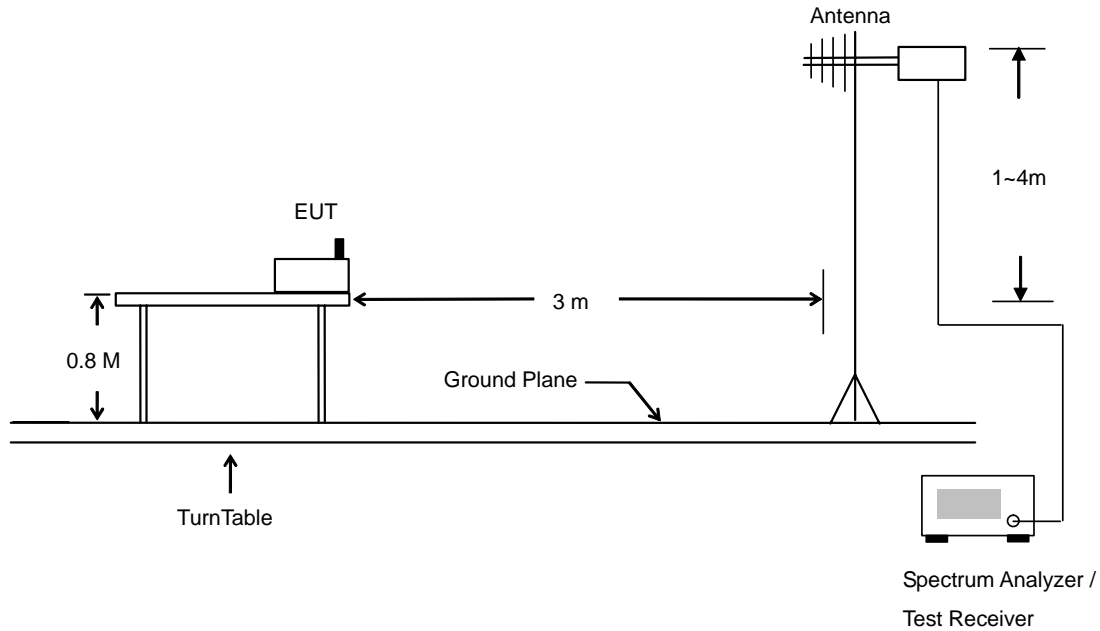



5.9.4 Test Data

- Temperature : 22°C
- Relating Humidity : 46 %
- Test Enginner : Sam
- Test Mode : Mode 1
- Polarization : Horizontal

The test that passed at the minimum margin was marked by the frame in the following test record

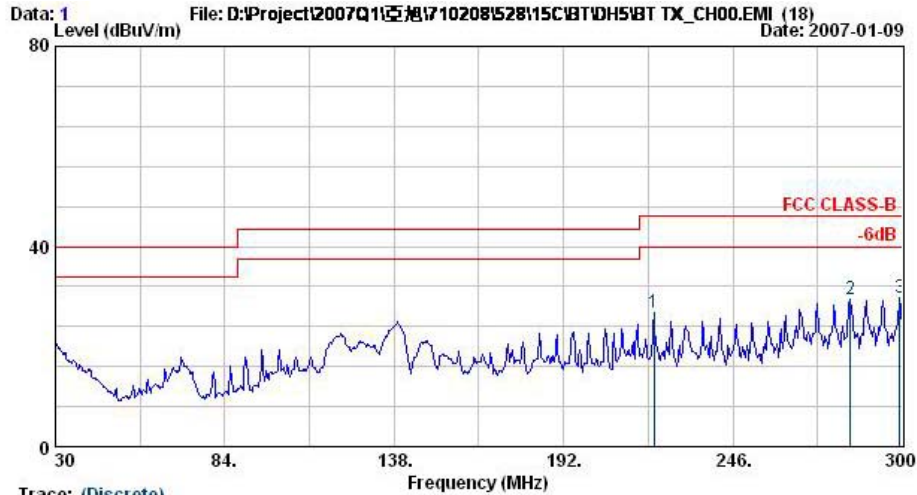

Trace: (Discrete)
 Site : 08CH06-HY
 Condition : LP-ANT(951121) HORIZONTAL
 EUT : PDA with GPRS/EDGE+WLAN 11g+BT
 Power : 120V_{ac}/60Hz
 Model : FR 710208
 Memo : Bluetooth TX_CH00;2402MHz
 Data Rate : DH5
 Plane : E1

	Freq	Level	Over	Limit	ReadAntenna	Cable	Preamp	Ant	Table	Remark	
	MHz	dBuV/m	dB	dBuV/m	dBuV	dB/m	dB	dB	cm	deg	
1	220.9	26.81	-19.19	46.00	45.11	10.56	2.16	31.02	---	---	Peak
2	283.5	29.34	-16.66	46.00	44.84	12.90	2.58	30.97	---	---	Peak
3	299.2	29.87	-16.13	46.00	44.97	13.21	2.63	30.93	---	---	Peak



Data: 2 File: D:\Project\2007Q1\528152815C\BT\DH5\BT_TX_CH00.EMI (18) Date: 2007-01-09

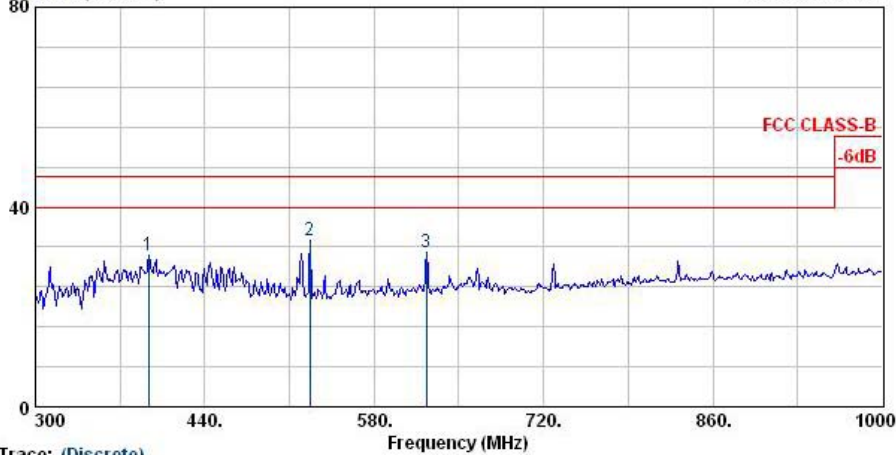

Trace: (Discrete)
 Site : 08CH06-HY
 Condition : LP-ANT(951121) HORIZONTAL
 EUT : PDA with GPRS/EDGE+WLAN 11g+BT
 Power : 120Vac/60Hz
 Model : FR 710208
 Memo : Bluetooth TX_CH00;2402MHz
 Data Rate : DHS
 Plane : E1

	Freq	Level	Over	Limit	Read	Antenna	Cable	Preamp	Ant	Table	Remark
	MHz	dBuV/m	dB	dBuV/m	dBuV	dB/m	dB	dB	cm	deg	
1	393.8	30.30	-15.70	46.00	42.48	15.61	3.07	30.87	---	---	Peak
2 @	526.8	33.42	-12.58	46.00	42.84	17.70	3.63	30.76	100	169	Peak
3 @	623.4	31.05	-14.95	46.00	39.15	18.57	3.99	30.66	---	---	Peak

Data: 3 File: D:\Project\2007Q1\528152815C\BT\DH5\BT_TX_CH00.EMI (18) Date: 2006-11-30

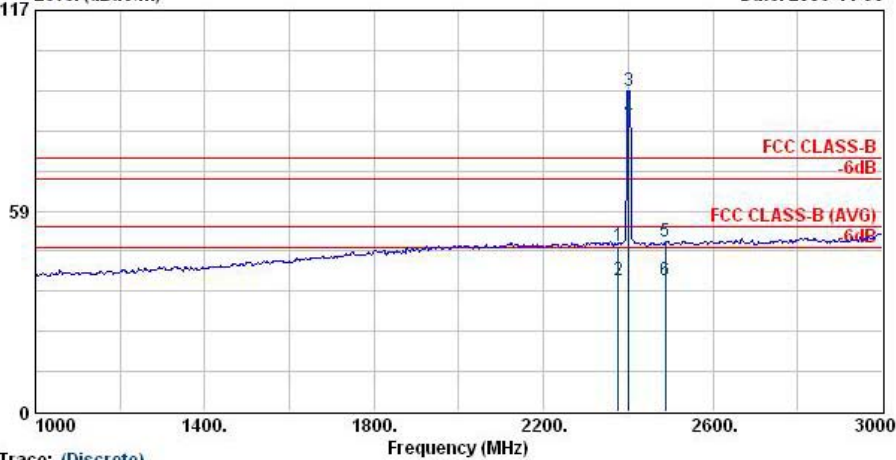

Trace: (Discrete)
 Site : 08CH06-HY
 Condition : HF-ANT-060410 HORIZONTAL
 EUT : PDA with GPRS/EDGE+WLAN 11g+BT
 Power : 120Vac/60Hz
 Model : FR 710208
 Memo : Bluetooth TX_CH00;2402MHz
 Data Rate : DHS
 Plane : E1

	Freq	Level	Over	Limit	Read	Antenna	Cable	Preamp	Ant	Table	Remark
	MHz	dBuV/m	dB	dBuV/m	dBuV	dB/m	dB	dB	cm	deg	
1	2375.8	48.36	-25.64	74.00	49.82	30.25	3.73	35.44	100	0	Peak
2 @	2375.8	38.43	-15.57	54.00	39.89	30.25	3.73	35.44	100	220	Average
3 @	2402.0	93.48			94.90	30.26	3.77	35.46	100	0	Peak
4 @	2402.0	85.70			87.13	30.26	3.77	35.46	100	220	Average
5	2488.0	49.63	-24.37	74.00	50.98	30.30	3.86	35.51	100	0	Peak
6 @	2488.0	38.47	-15.53	54.00	39.82	30.30	3.86	35.51	100	220	Average

Remark: #3 and #4 Fundamental Signal



Data: 4 File: D:\Project2007Q1\200710208\528115C\BT\DH5BT_TX_CH00.EMI (18) Date: 2006-11-30

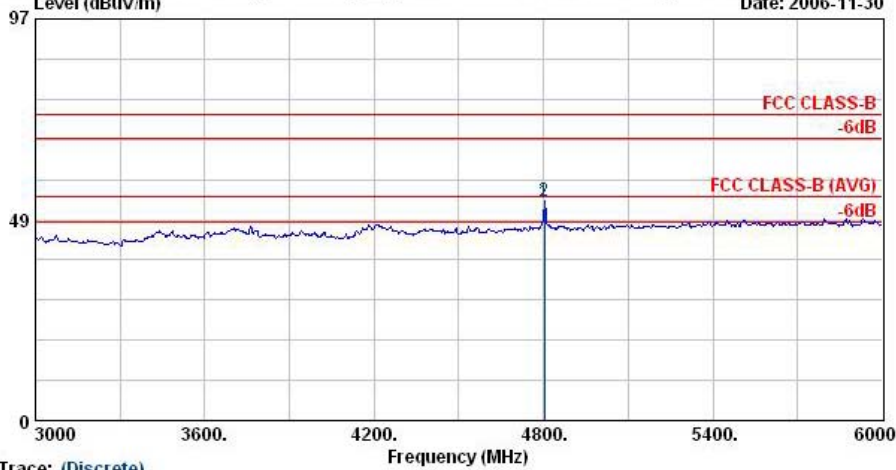

Trace: (Discrete)
 Site : 08CH06-HY
 Condition : HF-ANT-060410 HORIZONTAL
 EUT : PDA with GPRS/EDGE+WLAN 11g+BT
 Power : 120Vac/60Hz
 Model : FR 710208
 Memo : Bluetooth TX_CH00;2402MHz
 Data Rate : DHS
 Plane : E1

	Freq	Level	Over	Limit	Read	Antenna	Cable	Preamp	Ant	Table	
	MHz	dBuV/m	dB	dBuV/m	dBuV	dB/m	dB	dB	cm	deg	Remark
1 @	4804.0	52.61	-1.39	54.00	50.00	32.88	5.83	36.10	100	315	Average
2	4804.0	52.91	-21.09	74.00	50.30	32.88	5.83	36.10	100	0	Peak

Data: 5 File: D:\Project2007Q1\200710208\528115C\BT\DH5BT_TX_CH00.EMI (18) Date: 2006-11-30

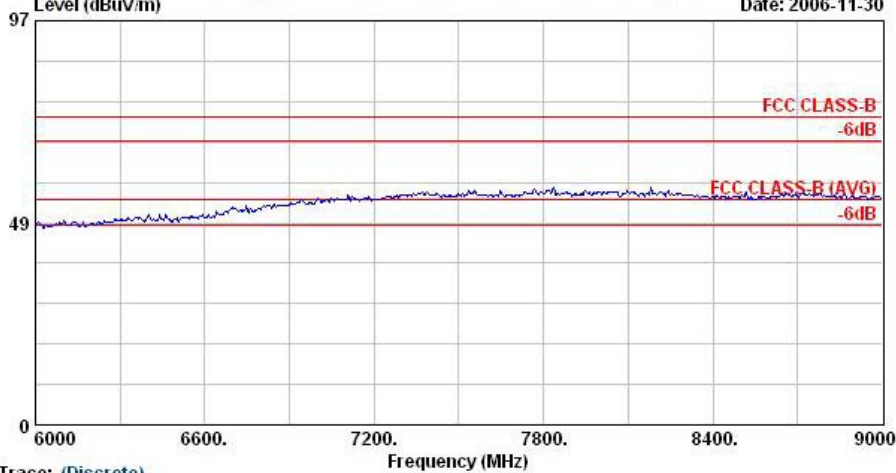

Trace: (Discrete)
 Site : 08CH06-HY
 Condition : HF-ANT-060410 HORIZONTAL
 EUT : PDA with GPRS/EDGE+WLAN 11g+BT
 Power : 120Vac/60Hz
 Model : FR 710208
 Memo : Bluetooth TX_CH00;2402MHz
 Data Rate : DHS
 Plane : E1



Data: 17 File: D:\Project\2007Q1\亞旭\710208\528\15C\BT\DH5\BT_TX_CH00.EMI (18) Date: 2006-11-30

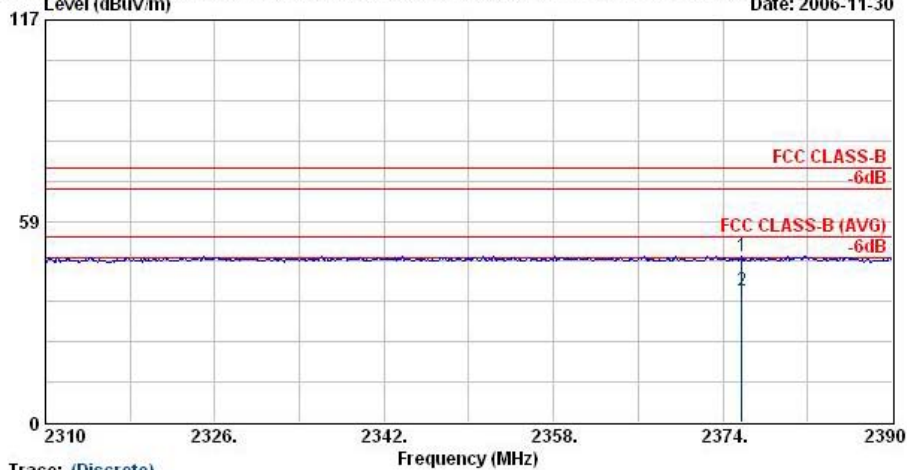

Trace: (Discrete)

Site : 08CH06-HY
 Condition : HF-ANT-060410 HORIZONTAL
 EUT : PDA with GPRS/EDGE+WLAN 11g+BT
 Power : 120Vac/60Hz
 Model : FR 710208
 Memo : Bluetooth TX_CH00;2402MHz
 Data Rate : DHS
 Plane : E1

	Freq	Level	Over	Limit	ReadAntenna	Cable	Preamp	Ant	Table	Remark
	MHz	dBuV/m	dB	dBuV/m	dBuV	dB/m	dB	dB	cm	deg
1	2375.8	48.36	-25.64	74.00	49.82	30.25	3.73	35.44	100	0 Peak
2 @	2375.8	38.43	-15.57	54.00	39.89	30.25	3.73	35.44	100	250 Average

Remark: There's no more obvious spurious emission except the listings above.



- Test Mode : Mode 1
- Polarization : Vertical

The test that passed at minimum margin was marked by the frame in the following table.

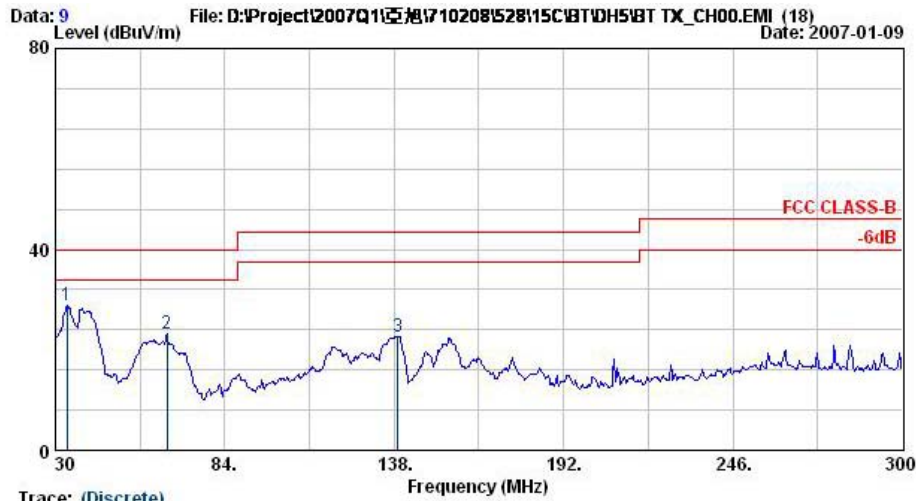

Trace: (Discrete)

Site : 08CH06-HY
 Condition : LP-ANT(951121) VERTICAL
 EUT : PDA with GPRS/EDGE+WLAN 11g+BT
 Power : 120Vac/60Hz
 Model : FR 710208
 Memo : Bluetooth_TX_CH00;2402MHz
 Data Rate : DH5
 Plane : E1

	Freq	Level	Over	Limit	Read	Antenna	Cable	Preamp	Ant	Table	Remark
	MHz	dBuV/m	dB	dBuV/m	dBuV	dB/m	dB	dB	cm	deg	
1 @	33.8	28.90	-11.10	40.00	42.52	16.84	0.87	31.32	---	---	Peak
2	65.6	23.11	-16.89	40.00	46.22	6.78	1.24	31.13	---	---	Peak
3	139.1	22.68	-20.82	43.50	41.59	10.41	1.73	31.05	---	---	Peak

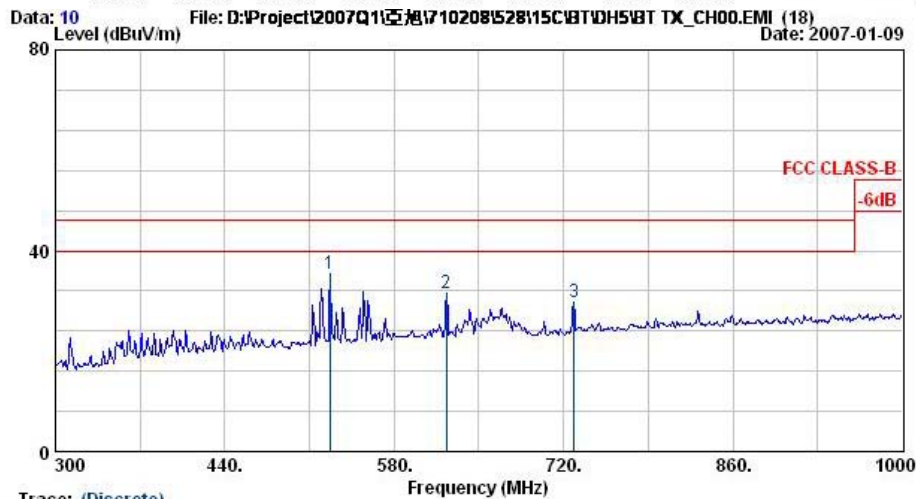

Trace: (Discrete)

Site : 08CH06-HY
 Condition : LP-ANT(951121) VERTICAL
 EUT : PDA with GPRS/EDGE+WLAN 11g+BT
 Power : 120Vac/60Hz
 Model : FR 710208
 Memo : Bluetooth_TX_CH00;2402MHz
 Data Rate : DH5
 Plane : E1

	Freq	Level	Over	Limit	Read	Antenna	Cable	Preamp	Ant	Table	Remark
	MHz	dBuV/m	dB	dBuV/m	dBuV	dB/m	dB	dB	cm	deg	
1 @	526.8	35.54	-10.46	46.00	44.96	17.70	3.63	30.76	100	188	Peak
2 @	623.4	31.52	-14.48	46.00	39.62	18.57	3.99	30.66	---	---	Peak
3	728.4	29.87	-16.13	46.00	36.96	19.15	4.32	30.56	---	---	Peak



Data: 11 File: D:\Project\2007Q1\亞旭\710208\528\15C\BT\DH5\BT_TX_CH00.EMI (18) Date: 2006-11-30

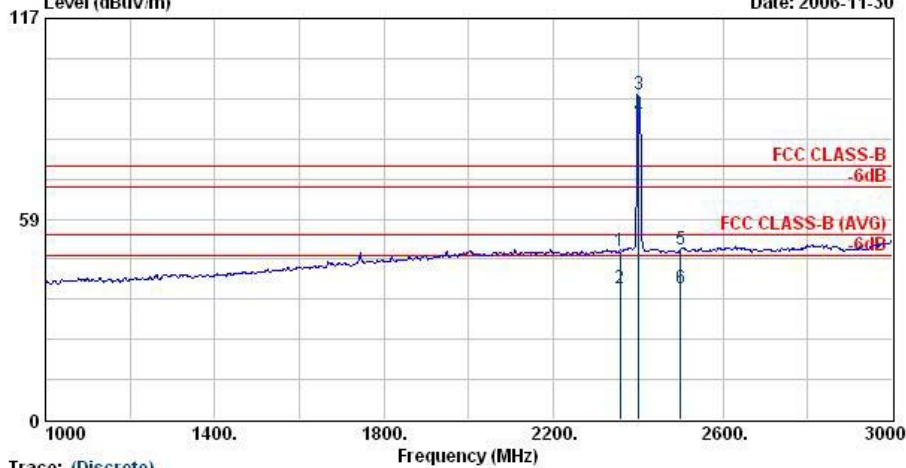

Trace: (Discrete)
 Site : 08CH06-HY
 Condition : HF-ANT-060410 VERTICAL
 EUT : PDA with GPRS/EDGE+WLAN 11g+BT
 Power : 120Vac/80Hz
 Model : FR 710208
 Memo : Bluetooth TX_CH00;2402MHz
 Data Rate : DH5
 Plane : E1

	Freq	Level	Over	Limit	Read	Antenna	Cable	Preamp	Ant	Table	Remark
	MHz	dBuV/m	dB	dBuV/m	dBuV	dB/m	dB	dB	cm	deg	
1	2356.6	49.22	-24.78	74.00	50.69	30.24	3.71	35.42	100	0	Peak
2 @	2356.6	38.42	-15.58	54.00	39.89	30.24	3.71	35.42	100	150	Average
3 @	2402.0	94.67			96.10	30.26	3.77	35.46	100	0	Peak
4 @	2402.0	88.33			89.76	30.26	3.77	35.46	100	150	Average
5	2500.0	49.71	-24.29	74.00	51.06	30.30	3.88	35.53	100	0	Peak
6	2500.0	38.32	-15.68	54.00	39.67	30.30	3.88	35.53	100	150	Average

Remark: #3 and #4 Fundamental Signal

Data: 12 File: D:\Project\2007Q1\亞旭\710208\528\15C\BT\DH5\BT_TX_CH00.EMI (18) Date: 2007-01-06

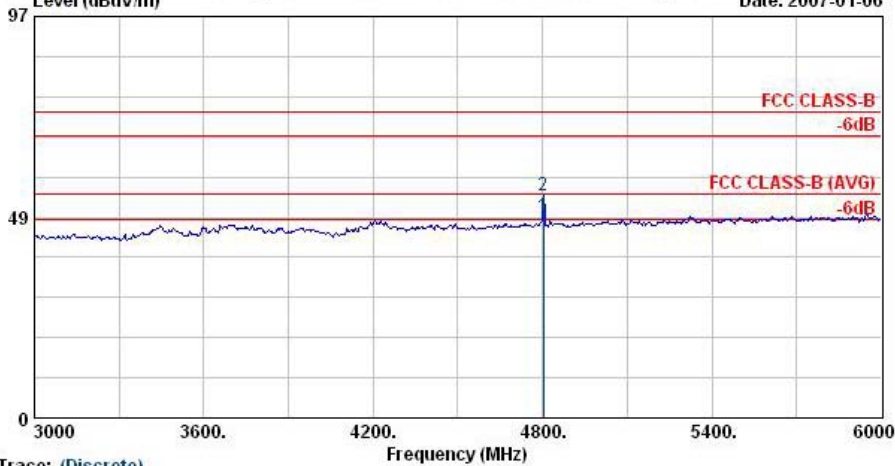

Trace: (Discrete)
 Site : 08CH06-HY
 Condition : HF-ANT-060410 VERTICAL
 EUT : PDA with GPRS/EDGE+WLAN 11g+BT
 Power : 120Vac/80Hz
 Model : FR 710208
 Memo : Bluetooth TX_CH00;2402MHz
 Data Rate : DH5
 Plane : E1

	Freq	Level	Over	Limit	Read	Antenna	Cable	Preamp	Ant	Table	Remark
	MHz	dBuV/m	dB	dBuV/m	dBuV	dB/m	dB	dB	cm	deg	
1 @	4804.0	48.65	-5.35	54.00	46.04	32.88	5.83	36.10	180	183	Average
2	4804.0	53.57	-20.43	74.00	50.96	32.88	5.83	36.10	100	0	Peak



Data: 13 File: D:\Project\2007Q1\亞旭\710208\52815C\BT\DH5\BT_TX_CH00.EMI (18) Date: 2006-11-30

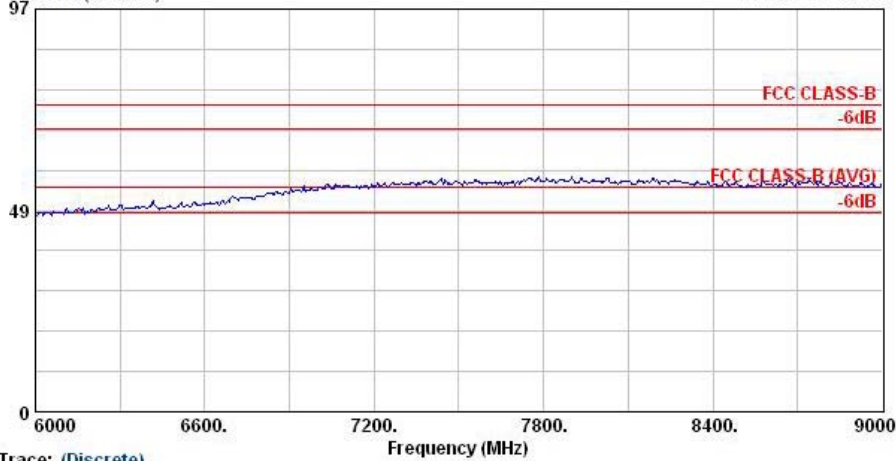

Trace: (Discrete)

Site : 08CH06-HY
Condition : HF-ANT-060410 VERTICAL
EUT : PDA with GPRS/EDGE+WLAN 11g+BT
Power : 120Vac/60Hz
Model : FR 710208
Memo : Bluetooth TX_CH00;2402MHz
Data Rate : DH5
Plane : E1

Data: 18 File: D:\Project\2007Q1\亞旭\710208\52815C\BT\DH5\BT_TX_CH00.EMI (18) Date: 2006-11-30

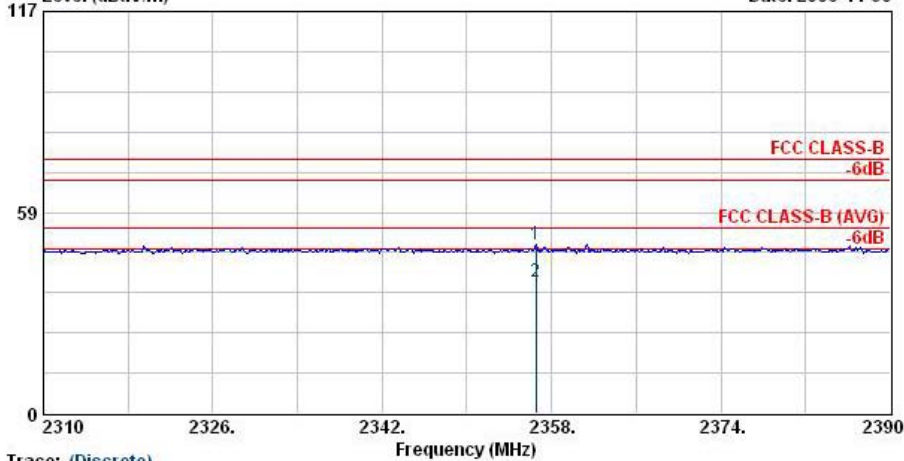

Trace: (Discrete)

Site : 08CH06-HY
Condition : HF-ANT-060410 VERTICAL
EUT : PDA with GPRS/EDGE+WLAN 11g+BT
Power : 120Vac/60Hz
Model : FR 710208
Memo : Bluetooth TX_CH00;2402MHz
Data Rate : DH5
Plane : E1

Table with 12 columns: Freq, Level, Over Limit, Limit Line, ReadAntenna Level, Antenna Factor, Cable Loss, Preamp Factor, Ant Pos, Table Pos, Remark. It lists two entries: 1 (Peak) at 2356.6 MHz and 2 (Average) at 2356.6 MHz.

Remark: There's no more obvious spurious emission except the listings above.



- Test Mode : Mode 2
- Polarization : Horizontal

The test that passed at minimum margin was marked by the frame in the following table.

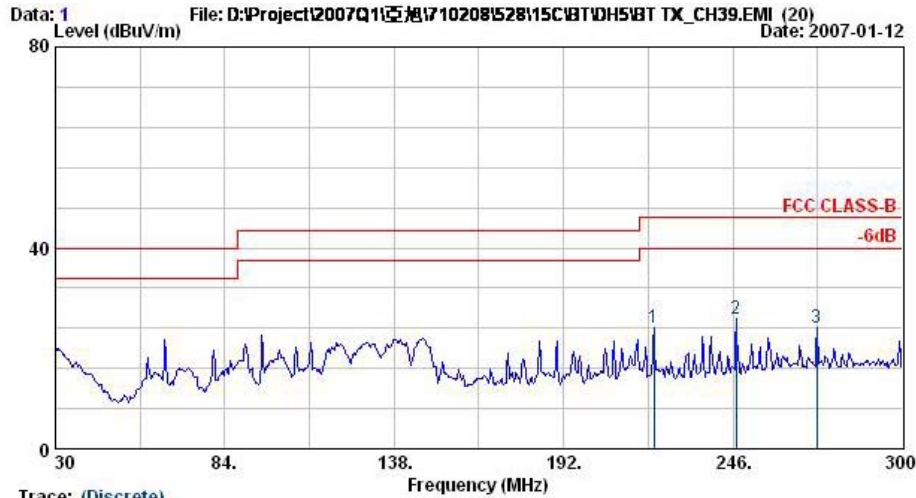

Trace: (Discrete)

Site : 08CH06-HY
 Condition : LP-ANT(951121) HORIZONTAL
 EUT : PDA with GPRS/EDGE+WLAN 11g+BT
 Power : 120Vac/80Hz
 Model : FR 710208
 Memo : Bluetooth TX_CH39;2441MHz
 Data Rate : DH5
 Plane : E1

	Freq	Level	Over	Limit	ReadAntenna	Cable	Preamp	Ant	Table	Remark
	MHz	dBuV/m	dB	dBuV/m	dBuV	dB	dB	cm	deg	
1	220.9	23.96	-22.04	46.00	42.26	10.56	2.16	31.02	---	Peak
2 @	247.1	25.80	-20.20	46.00	42.22	12.10	2.40	30.92	---	Peak
3	272.7	23.97	-22.03	46.00	39.70	12.69	2.54	30.96	---	Peak

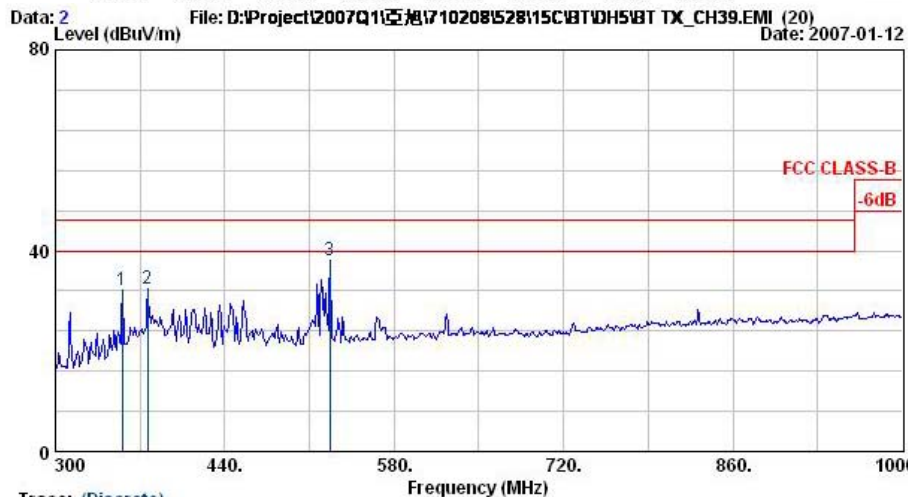

Trace: (Discrete)

Site : 08CH06-HY
 Condition : LP-ANT(951121) HORIZONTAL
 EUT : PDA with GPRS/EDGE+WLAN 11g+BT
 Power : 120Vac/80Hz
 Model : FR 710208
 Memo : Bluetooth TX_CH39;2441MHz
 Data Rate : DH5
 Plane : E1

	Freq	Level	Over	Limit	ReadAntenna	Cable	Preamp	Ant	Table	Remark
	MHz	dBuV/m	dB	dBuV/m	dBuV	dB	dB	cm	deg	
1 @	355.3	32.08	-13.92	46.00	45.48	14.62	2.87	30.89	---	Peak
2 @	376.3	32.47	-13.53	46.00	45.18	15.17	3.01	30.88	---	Peak
3 @	526.8	37.94	-8.06	46.00	47.37	17.70	3.63	30.76	100	153 Peak



Data: 3 File: D:\Project\2007Q1\200710208\528115C\BT\DH5\BT_TX_CH39.EMI (20) Date: 2006-11-30

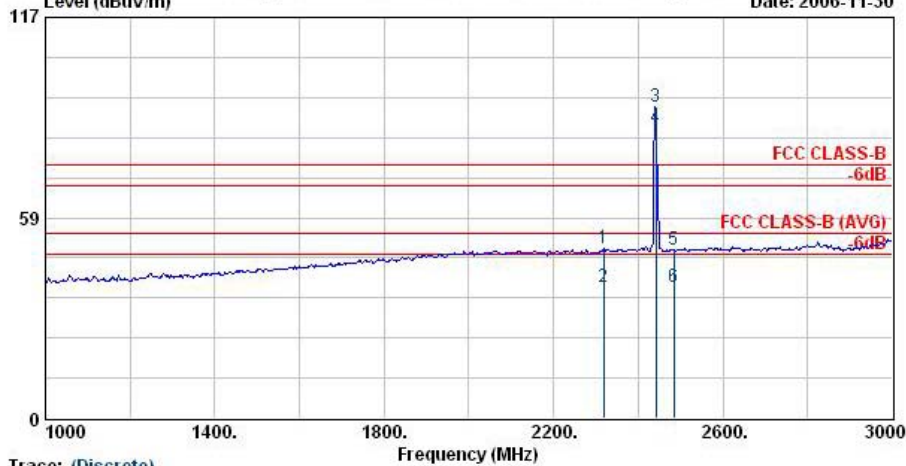

Trace: (Discrete)

Site : 08CH06-HY
 Condition : HF-ANT-060410 HORIZONTAL
 EUT : PDA with GPRS/EDGE+WLAN 11g+BT
 Power : 120Vac/80Hz
 Model : FR 710208
 Memo : Bluetooth_TX_CH39;2441MHz
 Data Rate : DH5
 Plane : E1

	Freq	Level	Over	Limit	Read	Antenna	Cable	Preamp	Ant	Table	Remark
	MHz	dBuV/m	dB	dBuV/m	dBuV	dB/m	dB	dB	cm	deg	
1	2318.0	49.63	-24.37	74.00	51.14	30.23	3.66	35.40	100	0	Peak
2 @	2318.0	38.21	-15.79	54.00	39.72	30.23	3.66	35.40	100	208	Average
3 @	2441.0	90.73			92.11	30.28	3.82	35.47	100	0	Peak
4 @	2441.0	84.83			86.23	30.28	3.82	35.49	100	208	Average
5	2484.0	49.16	-24.84	74.00	50.51	30.29	3.86	35.51	100	0	Peak
6 @	2484.0	38.34	-15.66	54.00	39.70	30.29	3.86	35.51	100	208	Average

Remark: #3 and #4 Fundamental Signal

Data: 4 File: D:\Project\2007Q1\200710208\528115C\BT\DH5\BT_TX_CH39.EMI (20) Date: 2006-11-30

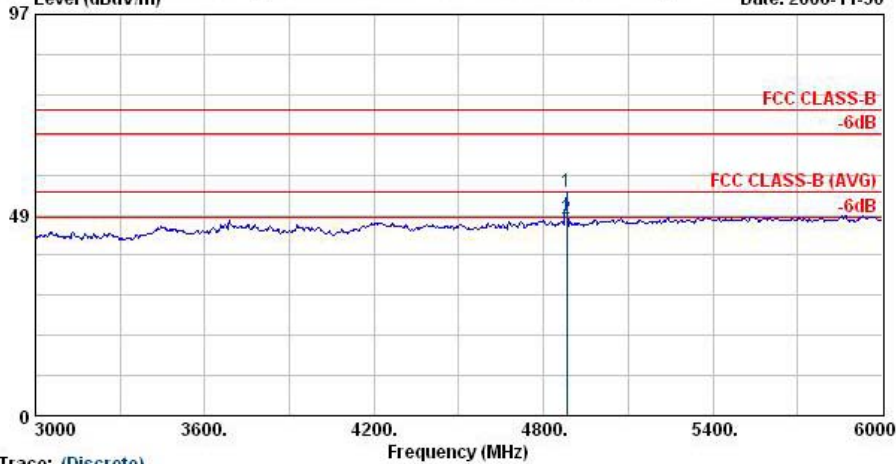

Trace: (Discrete)

Site : 08CH06-HY
 Condition : HF-ANT-060410 HORIZONTAL
 EUT : PDA with GPRS/EDGE+WLAN 11g+BT
 Power : 120Vac/80Hz
 Model : FR 710208
 Memo : Bluetooth_TX_CH39;2441MHz
 Data Rate : DH5
 Plane : E1

	Freq	Level	Over	Limit	Read	Antenna	Cable	Preamp	Ant	Table	Remark
	MHz	dBuV/m	dB	dBuV/m	dBuV	dB/m	dB	dB	cm	deg	
1 @	4882.0	53.92	-20.08	74.00	51.07	33.14	5.88	36.16	100	0	Peak
2 @	4882.0	47.76	-6.24	54.00	44.90	33.14	5.88	36.16	100	207	Average

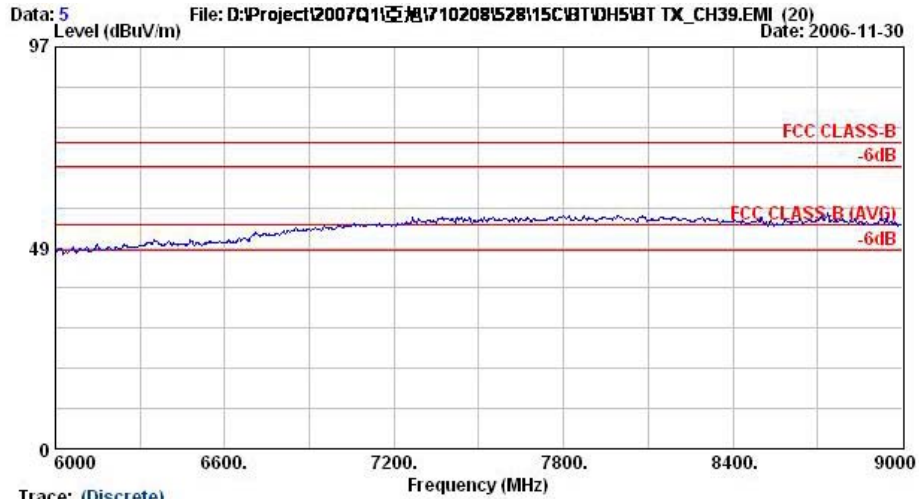

Trace: (Discrete)

Site : 08CH06-HY
Condition : HF-ANT-060410 HORIZONTAL
EUT : PDA with GPRS/EDGE+WLAN 11g+BT
Power : 120Vac/60Hz
Model : FR 710208
Memo : Bluetooth TX_CH39_2441MHz
Data Rate : DH5
Plane : E1

Remark: There's no more obvious spurious emission except the listings above.



- Test Mode : Mode 2
- Polarization : Vertical

The test that passed at minimum margin was marked by the frame in the following table.

Data: 11 File: D:\Project\2007Q1\5281710208\52815C\BT\DH5\BT_TX_CH39.EMI (20) Date: 2007-01-12

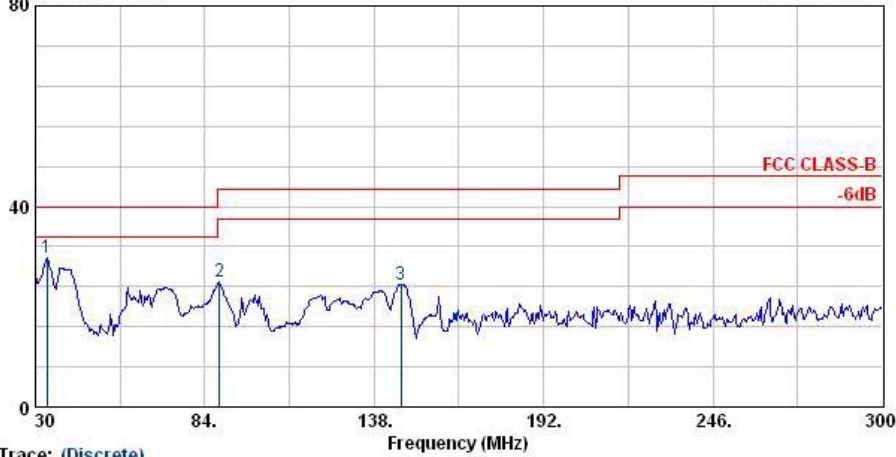

Trace: (Discrete)

Site : 08CH06-HY
 Condition : LP-ANT(951121) VERTICAL
 EUT : FDA with GPRS/EDGE+WLAN 11g+BT
 Power : 120Vac/80Hz
 Model : FR 710208
 Memo : Bluetooth TX_CH39;2441MHz
 Data Rate : DHS
 Plane : E1

	Freq	Level	Over	Limit	ReadAntenna	Cable	Preamp	Ant	Table	Remark
	MHz	dBuV/m	dB	dBuV/m	dBuV	dB/m	dB	cm	deg	
1 @	33.8	29.68	-10.32	40.00	43.30	16.84	0.87	31.32	100	75 Peak
2 @	88.6	25.08	-18.42	43.50	46.15	8.73	1.32	31.12	---	Peak
3 @	146.6	24.50	-19.00	43.50	43.42	10.35	1.80	31.06	---	Peak

Data: 12 File: D:\Project\2007Q1\5281710208\52815C\BT\DH5\BT_TX_CH39.EMI (20) Date: 2007-01-12

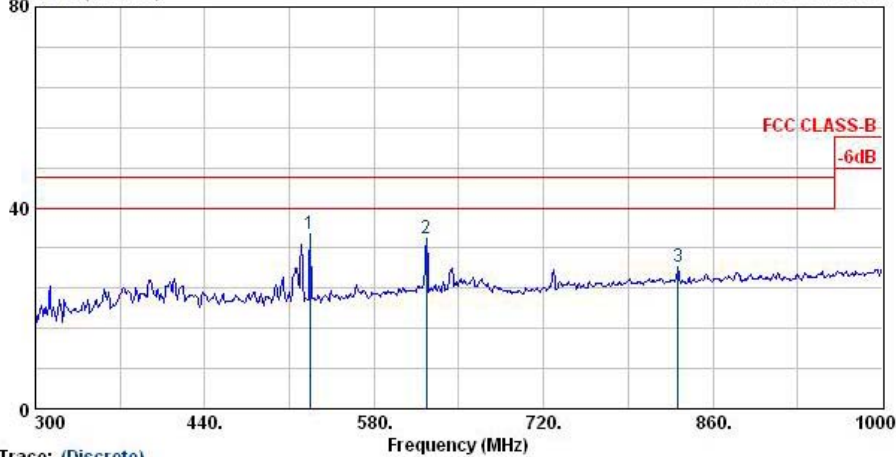

Trace: (Discrete)

Site : 08CH06-HY
 Condition : LP-ANT(951121) VERTICAL
 EUT : FDA with GPRS/EDGE+WLAN 11g+BT
 Power : 120Vac/80Hz
 Model : FR 710208
 Memo : Bluetooth TX_CH39;2441MHz
 Data Rate : DHS
 Plane : E1

	Freq	Level	Over	Limit	ReadAntenna	Cable	Preamp	Ant	Table	Remark
	MHz	dBuV/m	dB	dBuV/m	dBuV	dB/m	dB	cm	deg	
1 @	526.8	34.91	-11.09	46.00	44.34	17.70	3.63	30.76	---	Peak
2 @	623.4	33.81	-12.19	46.00	41.91	18.57	3.99	30.66	---	Peak
3 @	831.3	28.32	-17.68	46.00	34.09	20.04	4.64	30.45	---	Peak



Data: 13 File: D:\Project\2007Q1\亞旭\710208\5281\5C\BT\DH5\BT_TX_CH39.EMI (20) Date: 2006-11-30

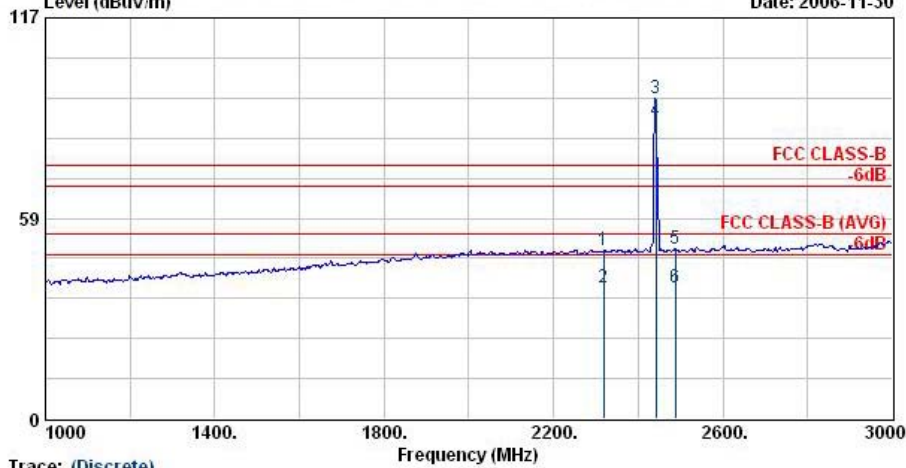

Trace: (Discrete)

Site : 08CH06-HY
 Condition : HF-ANT-060410 VERTICAL
 EUT : FDA with GPRS/EDGE+WLAN 11g+BT
 Power : 120Vac/80Hz
 Model : FR 710208
 Memo : Bluetooth TX_CH39;2441MHz
 Data Rate : DH5
 Plane : E1

	Freq	Level	Over	Limit	Read	Antenna	Cable	Preamp	Ant	Table	Remark
	MHz	dBuV/m	dB	dBuV/m	dBuV	dB/m	dB	dB	cm	deg	
1	2318.0	49.26	-24.74	74.00	50.77	30.23	3.66	35.40	100	0	Peak
2 @	2318.0	38.17	-15.83	54.00	39.68	30.23	3.66	35.40	100	278	Average
3 @	2441.0	93.37			94.75	30.28	3.82	35.47	100	0	Peak
4 @	2441.0	87.03			88.43	30.28	3.82	35.49	100	278	Average
5	2488.0	49.79	-24.21	74.00	51.14	30.30	3.86	35.51	100	0	Peak
6 @	2488.0	38.47	-15.53	54.00	39.82	30.30	3.86	35.51	100	278	Average

Remark: #3 and #4 Fundamental Signal

Data: 14 File: D:\Project\2007Q1\亞旭\710208\5281\5C\BT\DH5\BT_TX_CH39.EMI (20) Date: 2006-11-30

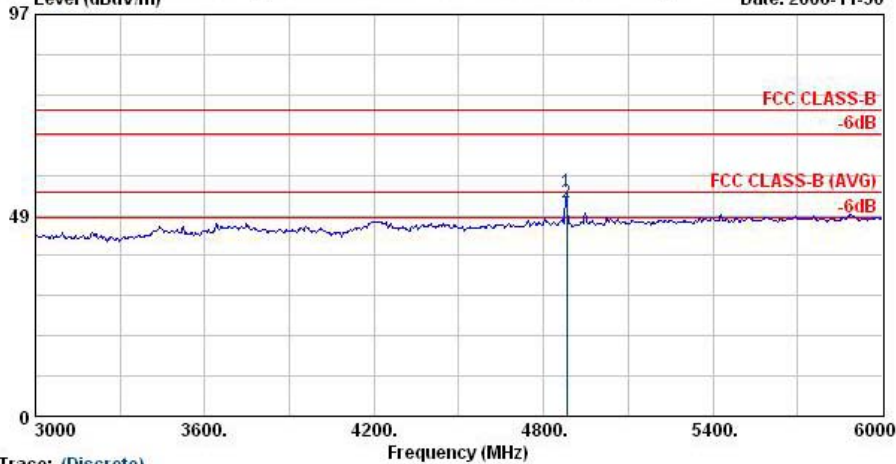

Trace: (Discrete)

Site : 08CH06-HY
 Condition : HF-ANT-060410 VERTICAL
 EUT : FDA with GPRS/EDGE+WLAN 11g+BT
 Power : 120Vac/80Hz
 Model : FR 710208
 Memo : Bluetooth TX_CH39;2441MHz
 Data Rate : DH5
 Plane : E1

	Freq	Level	Over	Limit	Read	Antenna	Cable	Preamp	Ant	Table	Remark
	MHz	dBuV/m	dB	dBuV/m	dBuV	dB/m	dB	dB	cm	deg	
1 @	4882.0	54.18	-19.82	74.00	51.32	33.14	5.88	36.16	100	0	Peak
2 @	4882.0	51.67	-2.33	54.00	48.81	33.14	5.88	36.16	126	87	Average

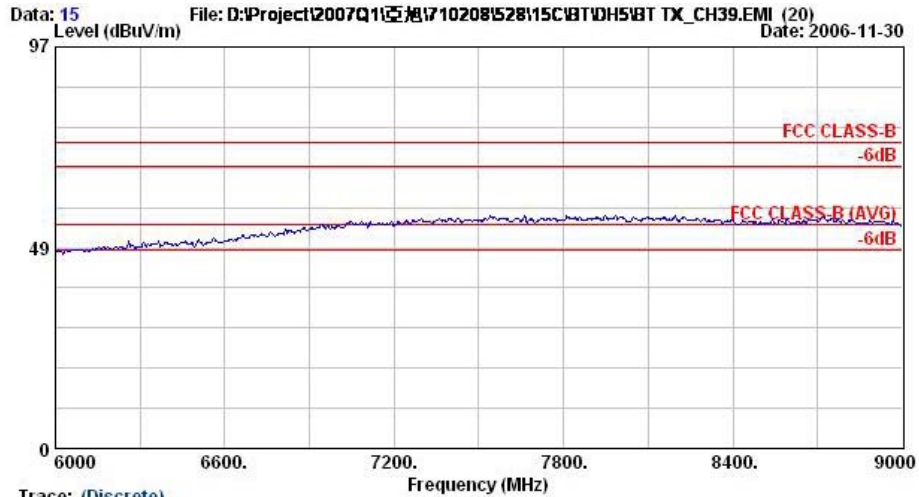

Trace: (Discrete)

Site : 08CH06-HY
Condition : HF-ANT-060410 VERTICAL
EUT : PDA with GPRS/EDGE+WLAN 11g+BT
Power : 120Vac/80Hz
Model : FR 710208
Memo : Bluetooth TX_CH39;2441MHz
Data Rate : DH5
Plane : E1

Remark: There's no more obvious spurious emission except the listings above.



- Test Mode : Mode 3
- Polarization : Horizontal

The test that passed at minimum margin was marked by the frame in the following table.

Data: 1 File: D:\Project\2007Q1\200710208\52815C\BT\DH5BT_TX_CH78.EMI (18) Date: 2007-01-12

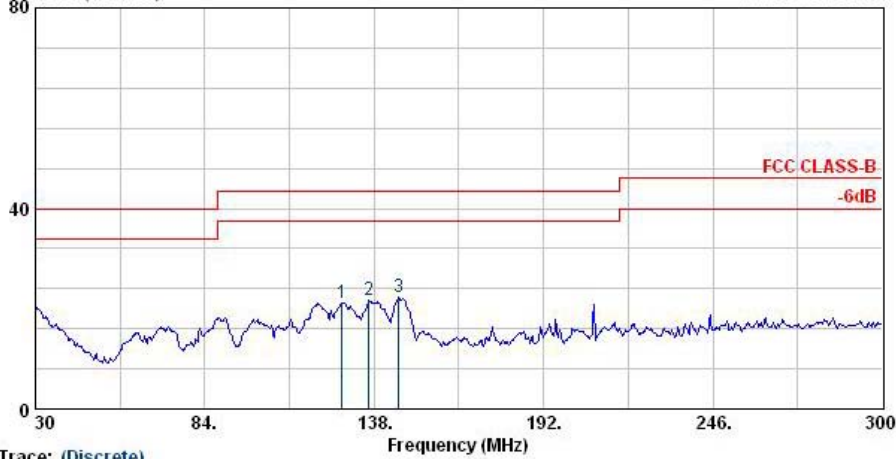

Trace: (Discrete)

Site : 08CH06-HY
 Condition : LP-ANT(951121) HORIZONTAL
 EUT : FDA with GPRS/EDGE+WLAN 11g+BT
 Power : 120Vac/80Hz
 Model : FR 710208
 Memo : Bluetooth TX_CH78;2480MHz
 Data Rate : DHS
 Plane : E1

	Freq	Level	Over	Limit	ReadAntenna	Cable	Preamp	Ant	Table	Remark	
	MHz	dBuV/m	dB	dBuV/m	dBuV	dB/m	dB	dB	cm	deg	
1	127.7	21.11	-22.39	43.50	38.38	12.18	1.64	31.09	---	---	Peak
2	136.4	21.72	-21.78	43.50	40.34	10.73	1.71	31.06	---	---	Peak
3	145.8	22.24	-21.26	43.50	41.18	10.33	1.79	31.06	---	---	Peak

Data: 2 File: D:\Project\2007Q1\200710208\52815C\BT\DH5BT_TX_CH78.EMI (18) Date: 2007-01-12

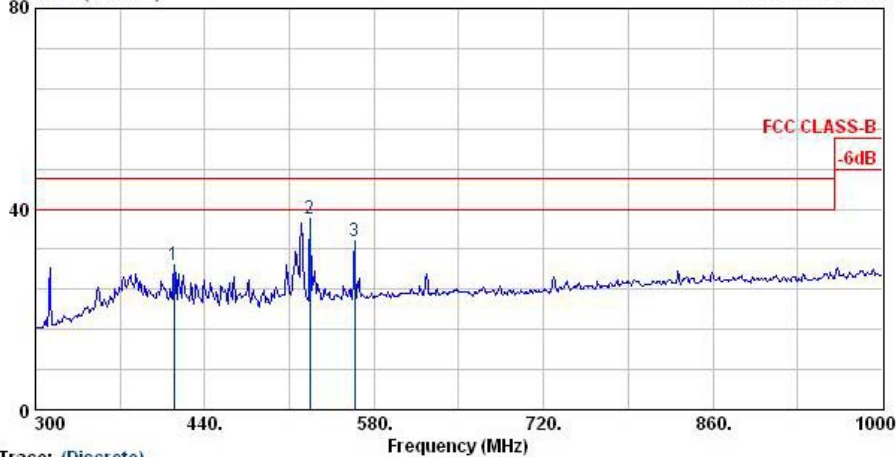

Trace: (Discrete)

Site : 08CH06-HY
 Condition : LP-ANT(951121) HORIZONTAL
 EUT : FDA with GPRS/EDGE+WLAN 11g+BT
 Power : 120Vac/80Hz
 Model : FR 710208
 Memo : Bluetooth TX_CH78;2480MHz
 Data Rate : DHS
 Plane : E1

	Freq	Level	Over	Limit	ReadAntenna	Cable	Preamp	Ant	Table	Remark	
	MHz	dBuV/m	dB	dBuV/m	dBuV	dB/m	dB	dB	cm	deg	
1	414.8	28.76	-17.24	46.00	40.39	16.02	3.19	30.85	---	---	Peak
2	526.8	37.95	-8.05	46.00	47.38	17.70	3.63	30.76	100	23	Peak
3	563.9	33.61	-12.39	46.00	42.47	18.09	3.77	30.71	---	---	Peak



Data: 3 File: D:\Project\2007Q1\200710208\52815C\BT\DH5\BT_TX_CH78.EMI (18) Date: 2006-11-30

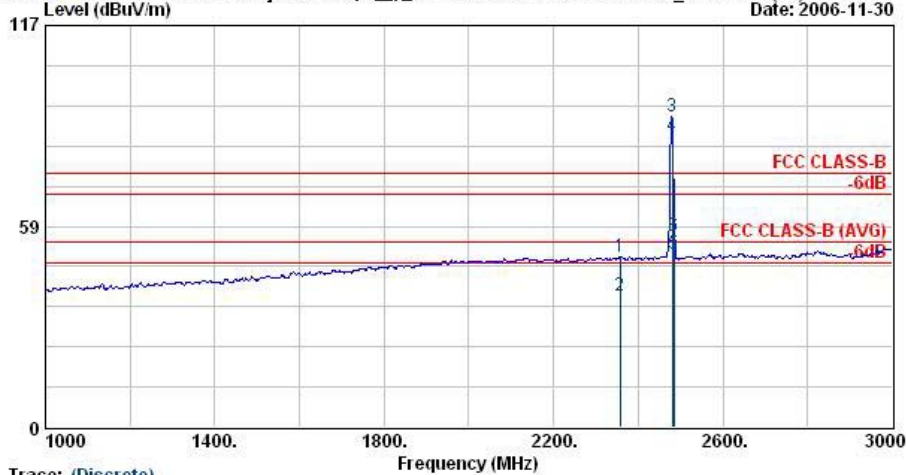

Trace: (Discrete)

Site : 08CH06-HY
 Condition : HP-ANT-060410 HORIZONTAL
 EUT : FDA with GPRS/EDGE+WLAN 11g+BT
 Power : 120Vac/80Hz
 Model : FR 710208
 Memo : Bluetooth TX_CH78;2480MHz
 Data Rate : DH5
 Plane : E1

	Freq	Level	Over	Limit	Read	Antenna	Cable	Preamp	Ant	Table	Remark
	MHz	dBuV/m	dB	dBuV/m	dBuV	dB/m	dB	dB	cm	deg	
1	2358.0	49.79	-24.21	74.00	51.26	30.24	3.71	35.42	100	0	Peak
2	2358.0	38.42	-15.58	54.00	39.89	30.24	3.71	35.42	100	8	Average
3 X	2480.0	90.54			91.89	30.29	3.86	35.51	100	0	Peak
4 @	2480.0	84.75			86.11	30.29	3.86	35.51	100	8	Average
5 !	2483.5	50.33	-3.67	54.00	51.69	30.29	3.86	35.51	100	8	Average
6	2483.5	55.84	-18.16	74.00	57.20	30.29	3.86	35.51	100	0	Peak

Remark: #3 and #4 Fundamental Signal

Data: 4 File: D:\Project\2007Q1\200710208\52815C\BT\DH5\BT_TX_CH78.EMI (18) Date: 2006-11-30

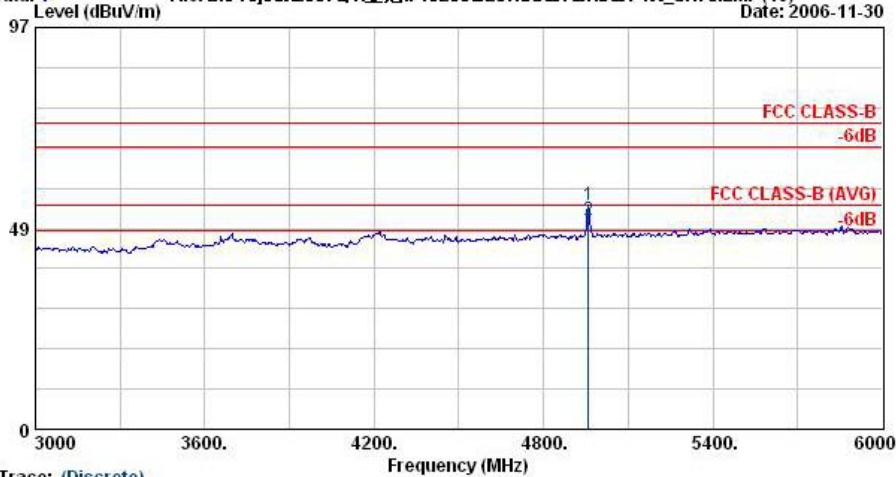

Trace: (Discrete)

Site : 08CH06-HY
 Condition : HP-ANT-060410 HORIZONTAL
 EUT : FDA with GPRS/EDGE+WLAN 11g+BT
 Power : 120Vac/80Hz
 Model : FR 710208
 Memo : Bluetooth TX_CH78;2480MHz
 Data Rate : DH5
 Plane : E1

	Freq	Level	Over	Limit	Read	Antenna	Cable	Preamp	Ant	Table	Remark
	MHz	dBuV/m	dB	dBuV/m	dBuV	dB/m	dB	dB	cm	deg	
1	4960.0	54.15	-19.85	74.00	50.98	33.47	5.93	36.23	100	0	Peak
2 !	4960.0	50.51	-3.49	54.00	47.34	33.47	5.93	36.23	100	208	Average



Data: 5 File: D:\Project\2007Q1\200710208\52815C\BT\DH5\BT_TX_CH78.EMI (18) Date: 2006-11-30

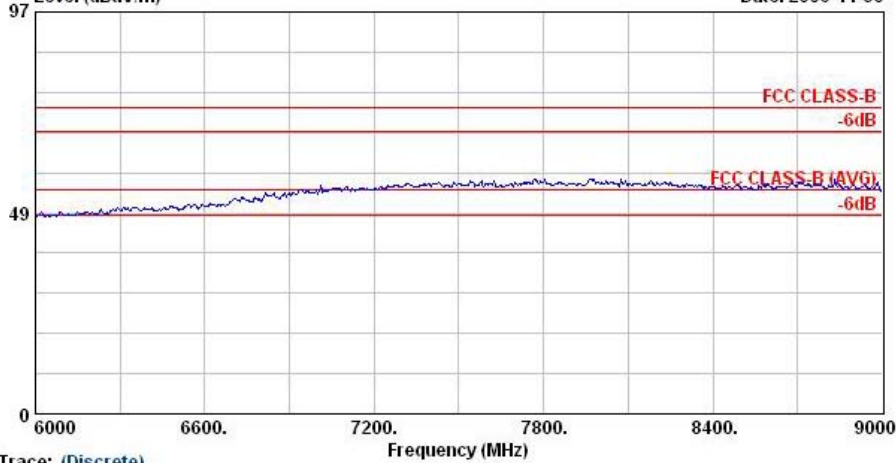

Trace: (Discrete)

Site : 08CH06-HY
 Condition : HF-ANT-060410 HORIZONTAL
 EUT : PDA with GPRS/EDGE+WLAN 11g+BT
 Power : 120Vac/60Hz
 Model : FR 710208
 Memo : Bluetooth TX_CH78,2480MHz
 Data Rate : DHS
 Plane : E1

Data: 17 File: D:\Project\2007Q1\200710208\52815C\BT\DH5\BT_TX_CH78.EMI (18) Date: 2006-11-30

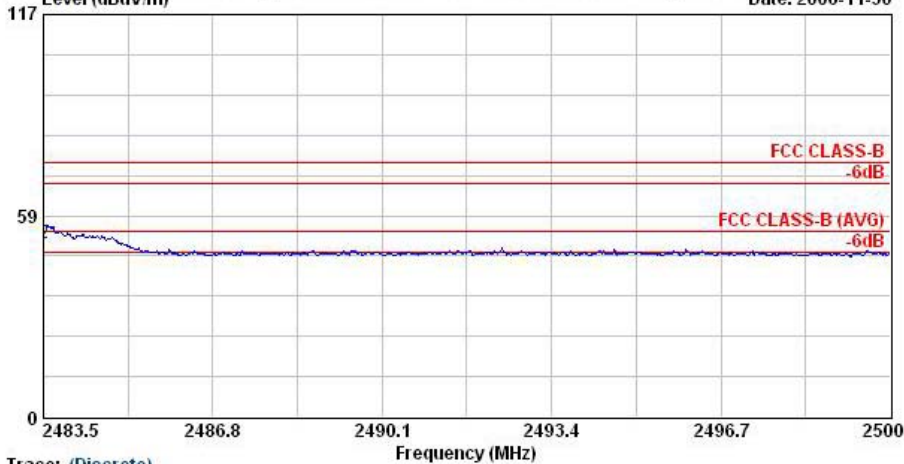

Trace: (Discrete)

Site : 08CH06-HY
 Condition : HF-ANT-060410 HORIZONTAL
 EUT : PDA with GPRS/EDGE+WLAN 11g+BT
 Power : 120Vac/60Hz
 Model : FR 710208
 Memo : Bluetooth TX_CH78,2480MHz
 Data Rate : DHS
 Plane : E1

	Freq	Level	Over Limit	Limit Line	ReadAntenna	Cable	Preampl	Ant	Table	Remark
	MHz	dBuV/m	dB	dBuV/m	dBuV	dB/m	dB	dB	cm	deg
1	2483.5	55.84	-18.16	74.00	57.20	30.29	3.86	35.51	100	0 Peak
2 !	2483.5	50.33	-3.67	54.00	51.69	30.29	3.86	35.51	100	8 Average

Remark: There's no more obvious spurious emission except the listings above.



- Test Mode : Mode 3
- Polarization : Vertical

The test that passed at minimum margin was marked by the frame in the following table.

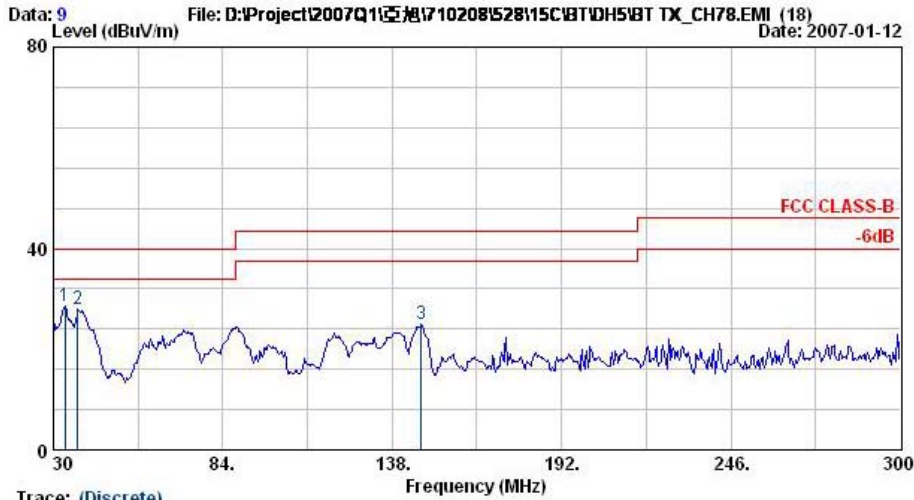

Trace: (Discrete)
 Site : 08CH06-HY
 Condition : LP-ANT(951121) VERTICAL
 EUT : PDA with GPRS/EDGE+WLAN 11g+BT
 Power : 120Vac/60Hz
 Model : FR 710208
 Memo : Bluetooth_TX_CH78;2480MHz
 Data Rate : DH5
 Plane : E1

	Freq	Level	Over	Limit	ReadAntenna	Cable	Preamp	Ant	Table	Remark	
	MHz	dBuV/m	dB	dBuV/m	dBuV	dB/m	dB	dB	cm	deg	
1	33.8	28.66	-11.34	40.00	42.28	16.84	0.87	31.32	100	245	Peak
2	37.8	27.82	-12.18	40.00	43.60	14.56	0.90	31.24	---	---	Peak
3	147.2	25.12	-18.38	43.50	44.02	10.36	1.81	31.06	---	---	Peak

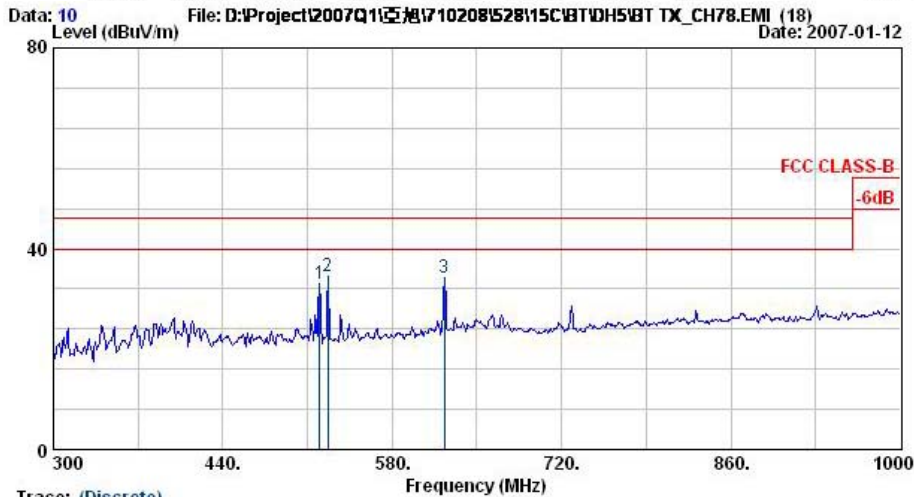

Trace: (Discrete)
 Site : 08CH06-HY
 Condition : LP-ANT(951121) VERTICAL
 EUT : PDA with GPRS/EDGE+WLAN 11g+BT
 Power : 120Vac/60Hz
 Model : FR 710208
 Memo : Bluetooth_TX_CH78;2480MHz
 Data Rate : DH5
 Plane : E1

	Freq	Level	Over	Limit	ReadAntenna	Cable	Preamp	Ant	Table	Remark	
	MHz	dBuV/m	dB	dBuV/m	dBuV	dB/m	dB	dB	cm	deg	
1	519.8	33.16	-12.84	46.00	42.70	17.63	3.60	30.77	---	---	Peak
2	526.8	34.56	-11.44	46.00	43.98	17.70	3.63	30.76	---	---	Peak
3	623.4	34.06	-11.94	46.00	42.16	18.57	3.99	30.66	---	---	Peak



Data: 11 File: D:\Project\2007Q1\528\710208\528\15C\BT\DH5\BT_TX_CH78.EMI (18) Date: 2006-11-30

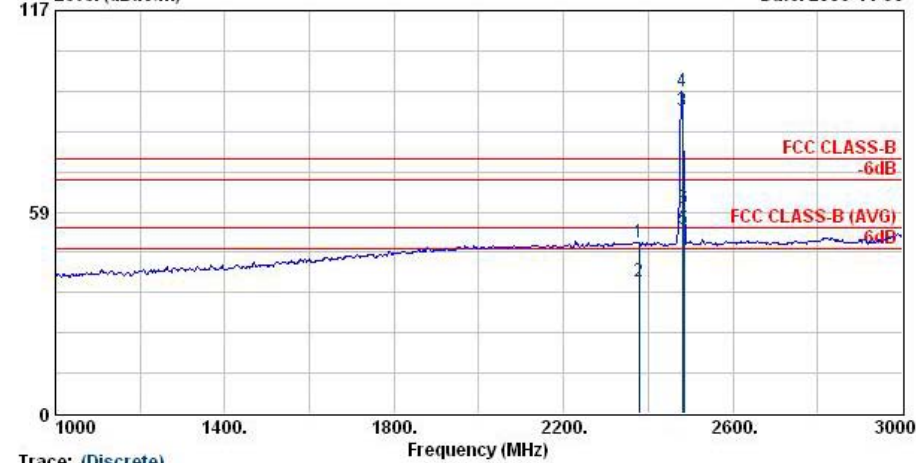

Trace: (Discrete)

Site : 08CH06-HY
 Condition : HF-ANT-060410 VERTICAL
 EUT : PDA with GPRS/EDGE+WLAN 11g+BT
 Power : 120Vac/60Hz
 Model : FR 710208
 Memo : Bluetooth TX_CH78;2480MHz
 Data Rate : DHS
 Plane : E1

	Freq	Level	Over	Limit	Read	Antenna	Cable	Preamp	Ant	Table	Remark
	MHz	dBuV/m	dB	dBuV/m	dBuV	dB/m	dB	dB	cm	deg	
1	2378.0	49.75	-24.25	74.00	51.18	30.25	3.75	35.44	100	0	Peak
2	2378.0	38.45	-15.55	54.00	39.89	30.25	3.75	35.44	100	145	Average
3 @	2480.0	87.75			89.11	30.29	3.86	35.51	100	145	Average
4 X	2480.0	93.42			94.78	30.29	3.86	35.51	100	0	Peak
5 !	2483.5	53.64	-0.36	54.00	55.00	30.29	3.86	35.51	100	145	Average
6	2483.5	59.54	-14.46	74.00	60.90	30.29	3.86	35.51	100	0	Peak

Remark: #3 and #4 Fundamental Signal

Data: 12 File: D:\Project\2007Q1\528\710208\528\15C\BT\DH5\BT_TX_CH78.EMI (18) Date: 2006-11-30

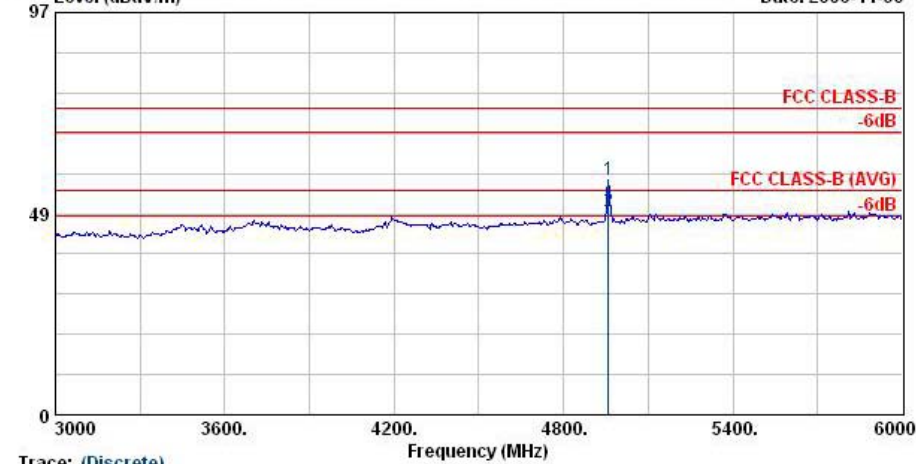

Trace: (Discrete)

Site : 08CH06-HY
 Condition : HF-ANT-060410 VERTICAL
 EUT : PDA with GPRS/EDGE+WLAN 11g+BT
 Power : 120Vac/60Hz
 Model : FR 710208
 Memo : Bluetooth TX_CH78;2480MHz
 Data Rate : DHS
 Plane : E1

	Freq	Level	Over	Limit	Read	Antenna	Cable	Preamp	Ant	Table	Remark
	MHz	dBuV/m	dB	dBuV/m	dBuV	dB/m	dB	dB	cm	deg	
1	4960.0	56.44	-17.56	74.00	53.27	33.47	5.93	36.23	100	0	Peak
2 !	4960.0	49.19	-4.81	54.00	46.02	33.47	5.93	36.23	100	156	Average



Data: 13 File: D:\Project\2007Q1\200811\528115C\BT\DH5\BT_TX_CH78.EMI (18) Date: 2006-11-30
 Level (dBuV/m)

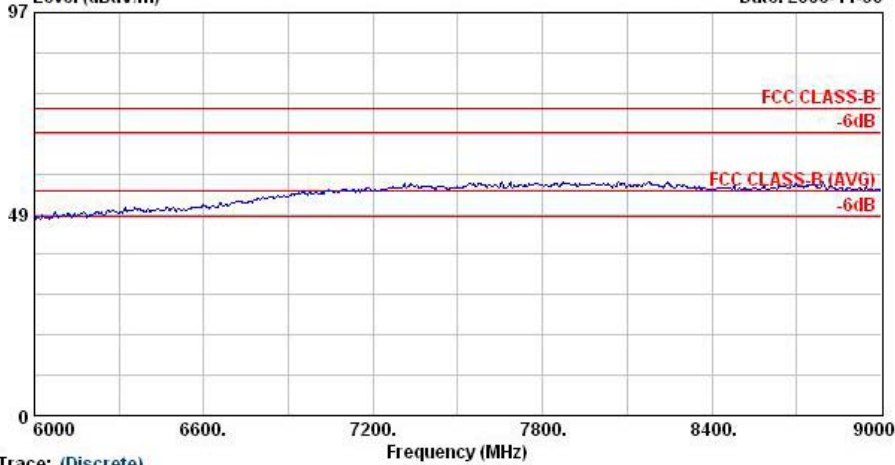

Trace: (Discrete)

Site : 08CH06-HY
 Condition : HF-ANT-060410 VERTICAL
 EUT : PDA with GPRS/EDGE+WLAN 11g+BT
 Power : 120Vac/60Hz
 Model : FR 710208
 Memo : Bluetooth_TX_CH78;2480MHz
 Data Rate : DHS
 Plane : E1

Data: 18 File: D:\Project\2007Q1\200811\528115C\BT\DH5\BT_TX_CH78.EMI (18) Date: 2006-11-30
 Level (dBuV/m)

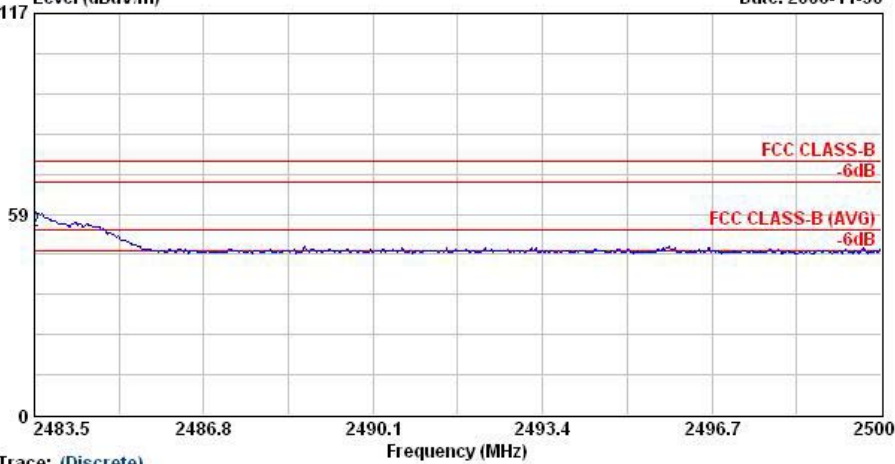

Trace: (Discrete)

Site : 08CH06-HY
 Condition : HF-ANT-060410 VERTICAL
 EUT : PDA with GPRS/EDGE+WLAN 11g+BT
 Power : 120Vac/60Hz
 Model : FR 710208
 Memo : Bluetooth_TX_CH78;2480MHz
 Data Rate : DHS
 Plane : E1

	Freq	Level	Over Limit	Limit Line	ReadAntenna Level	Cable Factor	Preamp Loss	Ant Factor	Ant Pos	Table Pos	Remark
	MHz	dBuV/m	dB	dBuV/m	dBuV	dB/m	dB	dB	cm	deg	
1	2483.5	59.54	-14.46	74.00	60.90	30.29	3.86	35.51	100	0	Peak
2 @	2483.5	53.64	-0.36	54.00	55.00	30.29	3.86	35.51	100	145	Average

Remark: There's no more obvious spurious emission except the listings above.



- Test Mode : Mode 3
- Polarization : Horizontal

The test that passed at minimum margin was marked by the frame in the following table.

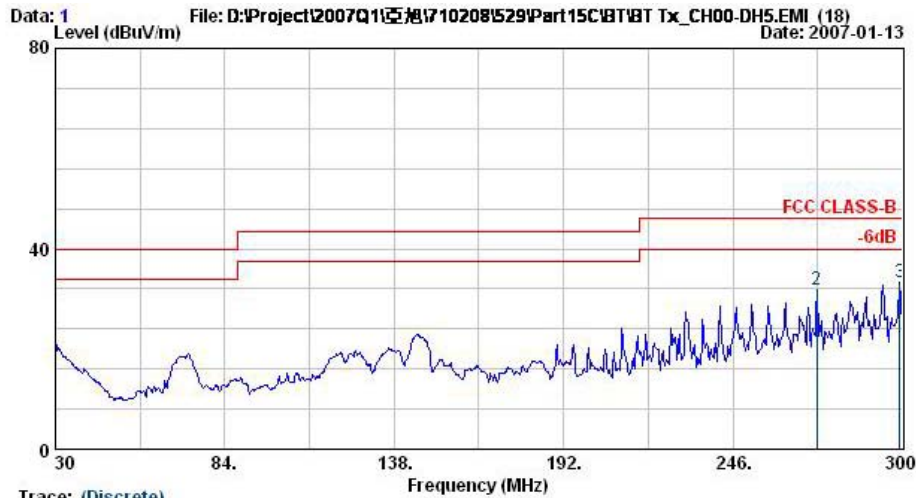

Trace: (Discrete)

Site : 08CH06-HY
 Condition : LP-ANT(951121) HORIZONTAL
 EUT : PDA with GPRS/EDGE+WLAN 11g+BT
 Power : 120Vac/60Hz
 Model : FR 710208
 Memo : Bluetooth TX_CH00;2402MHz
 Data Rate : DH5
 Plane : E1

	Freq	Level	Over	Limit	ReadAntenna	Cable	Preamp	Ant	Table	Remark	
	MHz	dBuV/m	dB	dBuV/m	dBuV	dB/m	dB	dB	cm	deg	
1	30.0	21.54	-18.46	40.00	32.50	19.66	0.84	31.46	---	---	Peak
2	272.7	31.95	-14.05	46.00	47.68	12.69	2.54	30.96	---	---	Peak
3	299.2	33.37	-12.63	46.00	48.46	13.21	2.63	30.93	100	176	Peak

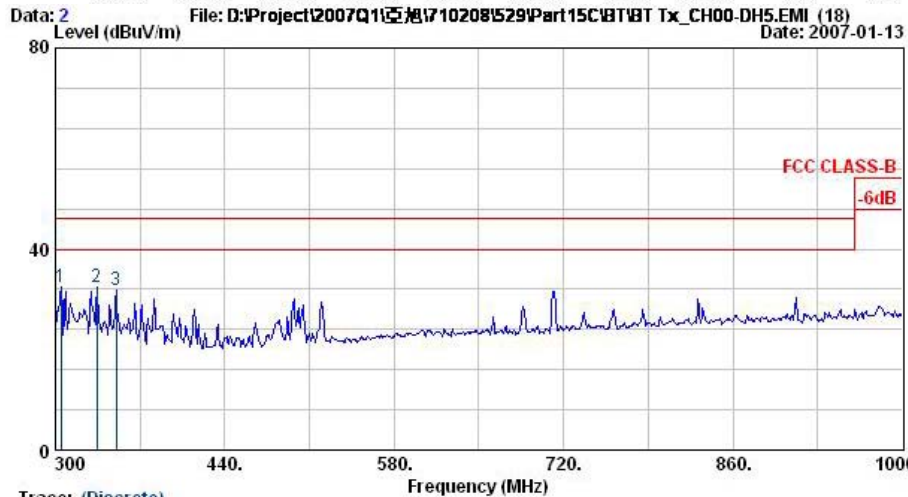

Trace: (Discrete)

Site : 08CH06-HY
 Condition : LP-ANT(951121) HORIZONTAL
 EUT : PDA with GPRS/EDGE+WLAN 11g+BT
 Power : 120Vac/60Hz
 Model : FR 710208
 Memo : Bluetooth TX_CH00;2402MHz
 Data Rate : DH5
 Plane : E1

	Freq	Level	Over	Limit	ReadAntenna	Cable	Preamp	Ant	Table	Remark	
	MHz	dBuV/m	dB	dBuV/m	dBuV	dB/m	dB	dB	cm	deg	
1	304.9	32.41	-13.59	46.00	47.34	13.33	2.66	30.93	---	---	Peak
2	334.3	32.43	-13.57	46.00	46.42	14.10	2.81	30.91	---	---	Peak
3	350.4	31.82	-14.18	46.00	45.38	14.50	2.84	30.89	---	---	Peak



Data: 3 File: D:\Project\2007Q1\亞旭\710208\529\Part15C\BT\BT Tx_CH00-DH5.EMI (18) Date: 2007-01-13

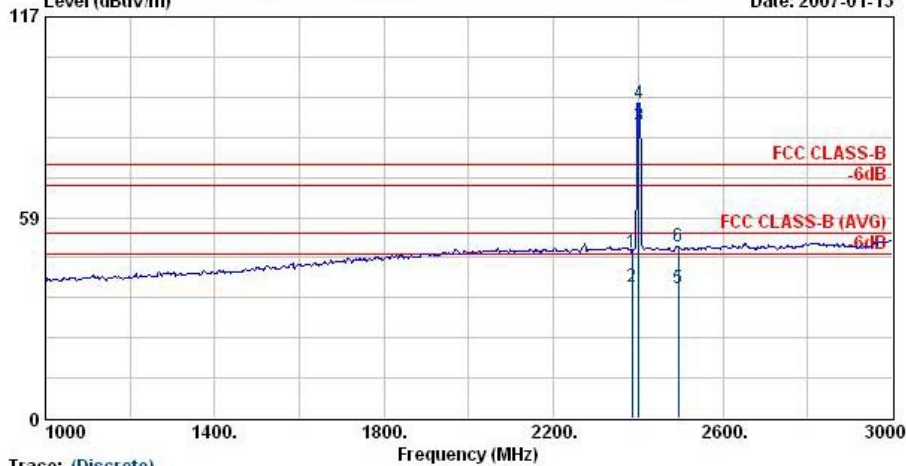

Trace: (Discrete)

Site : 08CH06-HY
 Condition : HF-ANT-060410 HORIZONTAL
 EUT : PDA with GPRS/EDGE+WLAN 11g+BT
 Power : 120Vac/60Hz
 Model : FR 710208
 Memo : Bluetooth TX_CH00;2402MHz
 Data Rate : DH5
 Plane : E1

	Freq	Level	Over	Limit	Read	Antenna	Cable	Preamp	Ant	Table	Remark
	MHz	dBuV/m	dB	dBuV/m	dBuV	dB/m	dB	dB	cm	deg	
1	2386.2	48.35	-25.65	74.00	49.78	30.26	3.75	35.44	100	0	Peak
2	2386.2	38.22	-15.78	54.00	39.65	30.26	3.75	35.44	100	155	Average
3 @	2402.0	85.45			86.88	30.26	3.77	35.46	100	155	Average
4 X	2402.0	91.93			93.35	30.26	3.77	35.46	100	0	Peak
5	2494.0	38.02	-15.98	54.00	39.37	30.30	3.88	35.53	100	155	Average
6	2494.0	50.09	-23.91	74.00	51.44	30.30	3.88	35.53	100	0	Peak

Remark: #3 and #4 Fundamental Signal

Data: 4 File: D:\Project\2007Q1\亞旭\710208\529\Part15C\BT\BT Tx_CH00-DH5.EMI (18) Date: 2007-01-13

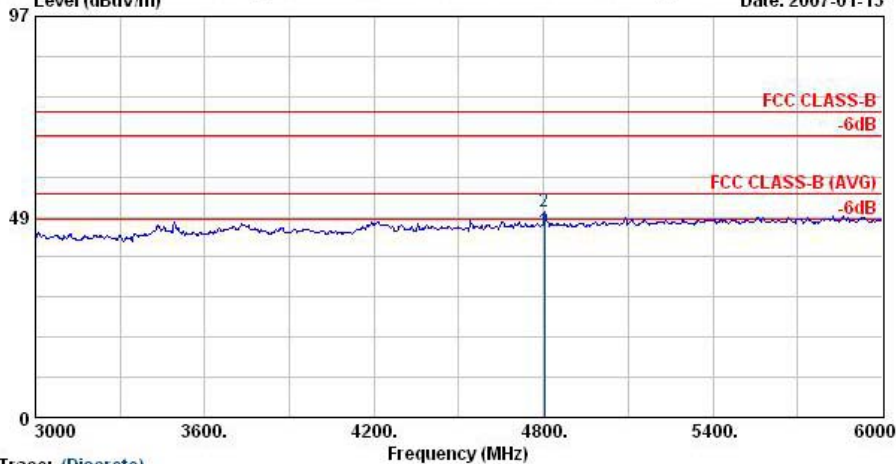

Trace: (Discrete)

Site : 08CH06-HY
 Condition : HF-ANT-060410 HORIZONTAL
 EUT : PDA with GPRS/EDGE+WLAN 11g+BT
 Power : 120Vac/60Hz
 Model : FR 710208
 Memo : Bluetooth TX_CH00;2402MHz
 Data Rate : DH5
 Plane : E1

	Freq	Level	Over	Limit	Read	Antenna	Cable	Preamp	Ant	Table	Remark
	MHz	dBuV/m	dB	dBuV/m	dBuV	dB/m	dB	dB	cm	deg	
1	4804.0	44.90	-9.10	54.00	42.29	32.88	5.83	36.10	100	31	Average
2	4804.0	49.73	-24.27	74.00	47.12	32.88	5.83	36.10	100	0	Peak



Data: 5 File: D:\Project\2007Q1\200710208\529\Part15C\BT\BT Tx_CH00-DH5.EMI (18) Date: 2007-01-13

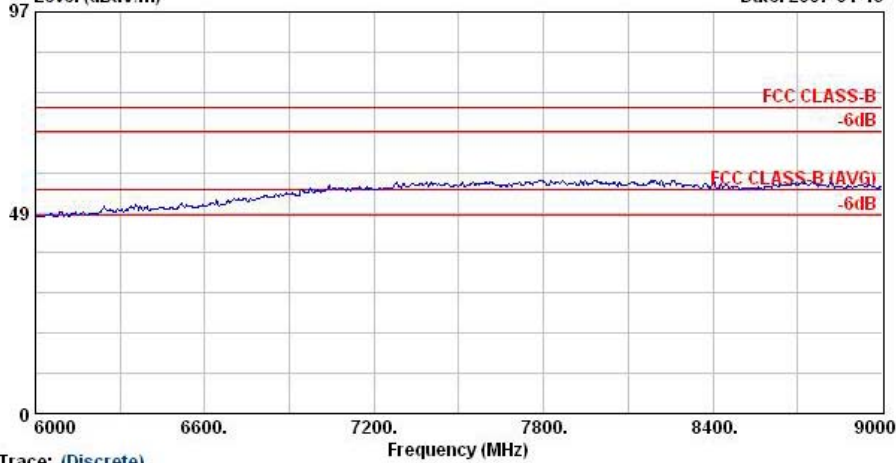

Trace: (Discrete)

Site : 08CH06-HY
 Condition : HF-ANT-060410 HORIZONTAL
 EUT : PDA with GPRS/EDGE+WLAN 11g+BT
 Power : 120Vac/60Hz
 Model : FR 710208
 Memo : Bluetooth TX_CH00;2402MHz
 Data Rate : DH5
 Plane : E1

Data: 17 File: D:\Project\2007Q1\200710208\529\Part15C\BT\BT Tx_CH00-DH5.EMI (18) Date: 2007-01-13

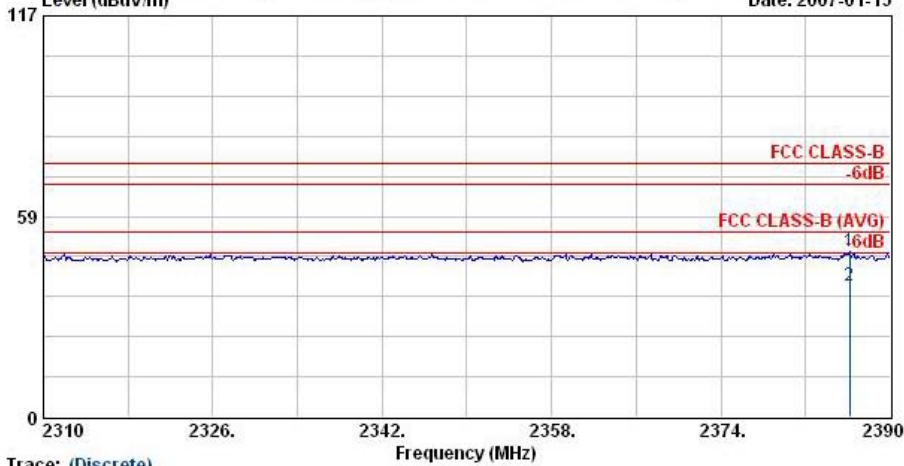

Trace: (Discrete)

Site : 08CH06-HY
 Condition : HF-ANT-060410 HORIZONTAL
 EUT : PDA with GPRS/EDGE+WLAN 11g+BT
 Power : 120Vac/60Hz
 Model : FR 710208
 Memo : Bluetooth TX_CH00;2402MHz
 Data Rate : DH5
 Plane : E1

	Freq	Level	Over	Limit	Read	Antenna	Cable	Preamp	Ant	Table	Remark
	MHz	dBuV/m	dB	dBuV/m	dBuV	dB/m	dB	dB	cm	deg	
1	2386.2	48.35	-25.65	74.00	49.78	30.26	3.75	35.44	100	0	Peak
2	2386.2	38.22	-15.78	54.00	39.65	30.26	3.75	35.44	100	155	Average

Remark: There's no more obvious spurious emission except the listings above.



- Test Mode : Mode 4
- Polarization : Vertical

The test that passed at minimum margin was marked by the frame in the following table.

Data: 9 File: D:\Project\2007Q1\200710208\529\Part15C\BT\BT Tx_CH00-DH5.EMI (19) Date: 2007-01-13

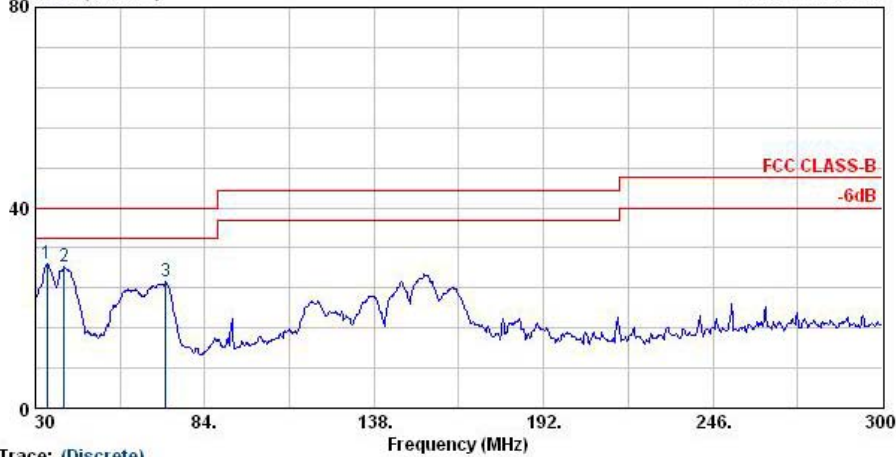

Trace: (Discrete)

Site : 08CH06-HY
 Condition : LP-ANT(951121) VERTICAL
 EUT : PDA with GPRS/EDGE+WLAN 11g+BT
 Power : 120Vac/80Hz
 Model : FR 710208
 Memo : Bluetooth TX_CH00;2402MHz
 Data Rate : DH5
 Plane : E1

	Freq	Level	Over	Limit	ReadAntenna	Cable	Preamp	Ant	Table	Remark
	MHz	dBuV/m	dB	dBuV/m	dBuV	dB/m	dB	dB	cm	deg
1	33.8	28.91	-11.09	40.00	42.53	16.84	0.87	31.32	100	58 Peak
2	39.2	28.22	-11.78	40.00	44.48	14.03	0.91	31.21	---	--- Peak
3	71.6	25.32	-14.68	40.00	48.17	7.00	1.32	31.17	---	--- Peak

Data: 10 File: D:\Project\2007Q1\200710208\529\Part15C\BT\BT Tx_CH00-DH5.EMI (19) Date: 2007-01-13

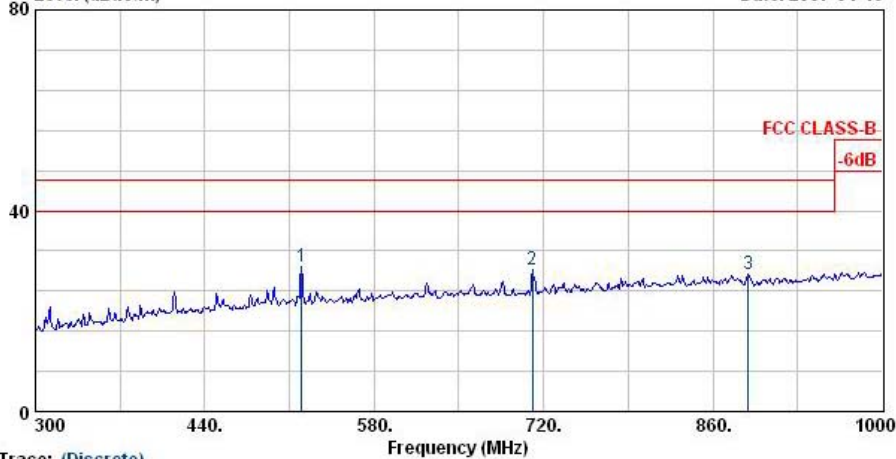

Trace: (Discrete)

Site : 08CH06-HY
 Condition : LP-ANT(951121) VERTICAL
 EUT : PDA with GPRS/EDGE+WLAN 11g+BT
 Power : 120Vac/80Hz
 Model : FR 710208
 Memo : Bluetooth TX_CH00;2402MHz
 Data Rate : DH5
 Plane : E1

	Freq	Level	Over	Limit	ReadAntenna	Cable	Preamp	Ant	Table	Remark
	MHz	dBuV/m	dB	dBuV/m	dBuV	dB/m	dB	dB	cm	deg
1	519.8	28.87	-17.13	46.00	38.41	17.63	3.60	30.77	---	--- Peak
2	710.9	28.15	-17.85	46.00	35.46	18.99	4.28	30.58	---	--- Peak
3	889.4	27.50	-18.50	46.00	32.64	20.45	4.78	30.38	---	--- Peak



Data: 11 File: D:\Project\2007Q1\亞旭\710208\529\Part15C\BT\BT Tx_CH00-DH5.EMI (18) Date: 2007-01-13

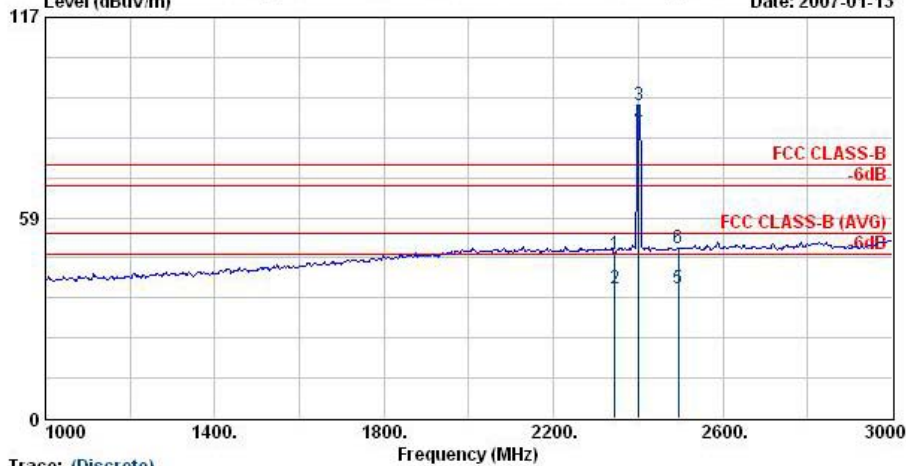

Trace: (Discrete)

Site : 08CH06-HY
 Condition : HF-ANT-060410 VERTICAL
 EUT : PDA with GPRS/EDGE+WLAN 11g+BT
 Power : 120Vac/60Hz
 Model : FR 710208
 Memo : Bluetooth TX_CH00;2402MHz
 Data Rate : DH5
 Plane : E1

	Freq	Level	Over	Limit	Read	Antenna	Cable	Preamp	Ant	Table	Remark
	MHz	dBuV/m	dB	dBuV/m	dBuV	dB/m	dB	dB	cm	deg	
1	2345.0	47.78	-26.22	74.00	49.26	30.24	3.71	35.42	100	0	Peak
2	2345.0	37.98	-16.02	54.00	39.46	30.24	3.71	35.42	100	329	Average
3 X	2402.0	91.44			92.87	30.26	3.77	35.46	100	0	Peak
4 @	2402.0	85.71			87.14	30.26	3.77	35.46	100	329	Average
5	2494.0	38.03	-15.97	54.00	39.38	30.30	3.88	35.53	100	329	Average
6	2494.0	49.75	-24.25	74.00	51.09	30.30	3.88	35.53	100	0	Peak

Remark: #3 and #4 Fundamental Signal

Data: 12 File: D:\Project\2007Q1\亞旭\710208\529\Part15C\BT\BT Tx_CH00-DH5.EMI (18) Date: 2007-01-13

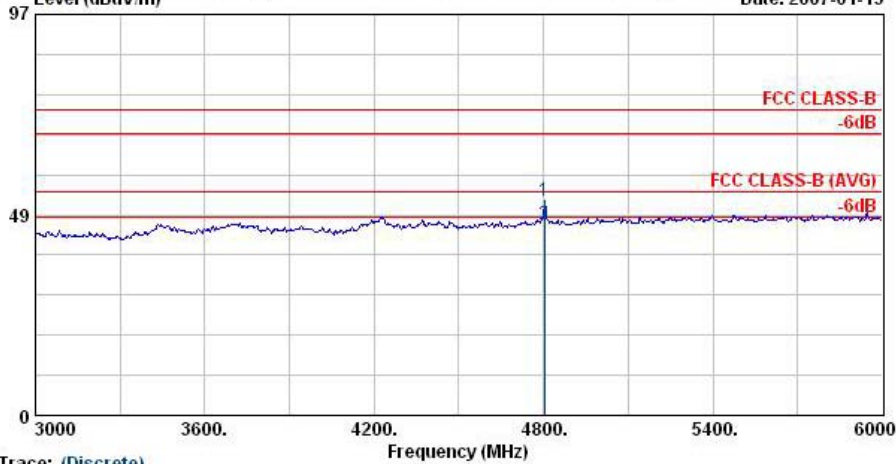

Trace: (Discrete)

Site : 08CH06-HY
 Condition : HF-ANT-060410 VERTICAL
 EUT : PDA with GPRS/EDGE+WLAN 11g+BT
 Power : 120Vac/60Hz
 Model : FR 710208
 Memo : Bluetooth TX_CH00;2402MHz
 Data Rate : DH5
 Plane : E1

	Freq	Level	Over	Limit	Read	Antenna	Cable	Preamp	Ant	Table	Remark
	MHz	dBuV/m	dB	dBuV/m	dBuV	dB/m	dB	dB	cm	deg	
1	4804.0	51.97	-22.03	74.00	49.36	32.88	5.83	36.10	100	0	Peak
2	4804.0	46.06	-7.94	54.00	43.45	32.88	5.83	36.10	100	251	Average



Data: 13 File: D:\Project\2007Q1\200710208\529\Part15C\BT\BT Tx_CH00-DH5.EMI (18) Date: 2007-01-13
 Level (dBuV/m)

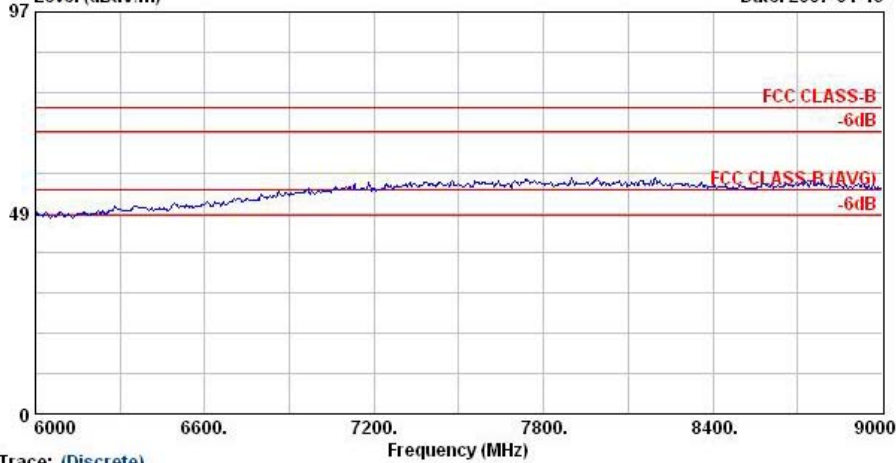

Trace: (Discrete)

Site : 08CH06-HY
 Condition : HF-ANT-060410 VERTICAL
 EUT : PDA with GPRS/EDGE+WLAN 11g+BT
 Power : 120Vac/60Hz
 Model : FR 710208
 Memo : Bluetooth TX_CH00;2402MHz
 Data Rate : DH5
 Plane : E1

Data: 18 File: D:\Project\2007Q1\200710208\529\Part15C\BT\BT Tx_CH00-DH5.EMI (18) Date: 2007-01-13
 Level (dBuV/m)

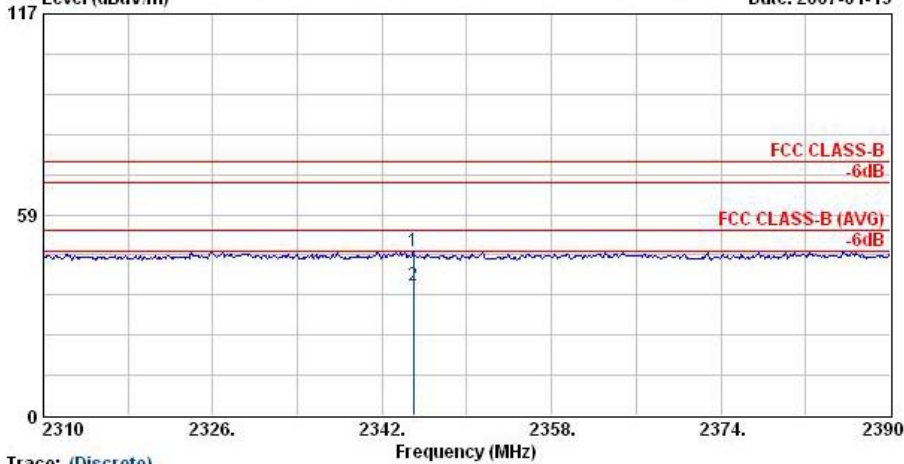

Trace: (Discrete)

Site : 08CH06-HY
 Condition : HF-ANT-060410 VERTICAL
 EUT : PDA with GPRS/EDGE+WLAN 11g+BT
 Power : 120Vac/60Hz
 Model : FR 710208
 Memo : Bluetooth TX_CH00;2402MHz
 Data Rate : DH5
 Plane : E1

	Freq	Level	Over	Limit	Read	Antenna	Cable	Preamp	Ant	Table	
	MHz	dBuV/m	dB	dBuV/m	dBuV	dB/m	dB	dB	cm	deg	Remark
1	2345.0	47.79	-26.21	74.00	49.26	30.24	3.71	35.42	100	0	Peak
2	2345.0	37.98	-16.02	54.00	39.46	30.24	3.71	35.42	100	329	Average

Remark: There's no more obvious spurious emission except the listings above.



5.10 Antenna Requirements

5.10.1 Standard Applicable

For intentional device, according to FCC 47 CFR Section 15.203, an intentional radiator shall be designed to ensure that no other antenna except assembled by the responsible party shall be used with the device.

And according to FCC 47 CFR Section 15.247 (b), if directional gain of transmitting antennas is greater than 6dBi, the power shall be reduced by the same level in dB comparing to gain minus 6dBi.

5.10.2 Antenna Connected Construction

The antenna used in this product is a fixed internal antenna without connector and it is considered to meet antenna requirement of FCC.

5.10.3 Antenna Gain

The antenna gain of EUT is less than 6dBi. Therefore, it is not necessary to reduce maximum peak output power limit.



6. List of Measuring Equipments Used

Instrument	Manufacturer	Model No.	Serial No.	Characteristics	Calibration Date	Due Date	Remark
EMC Receiver	R&S	ESCS 30	100132	9kHz – 2.75GHz	Jun. 28, 2006	Jun. 28, 2007	Conduction (CO01-HY)
LISN	MessTec	NNB-2/16Z	2001/008	9kHz – 30MHz	Mar. 29, 2006	Mar. 29, 2007	Conduction (CO01-HY)
LISN (Support Unit)	MessTec	NNB-2/16Z	2001/009	9kHz – 30MHz	Apr. 19, 2006	Apr. 19, 2007	Conduction (CO01-HY)
EMI Filter	LINDGREN	LRE-2060	1004	< 450Hz	N/A	N/A	Conduction (CO01-HY)
EMI Filter	LINDGREN	N6006	201052	0 – 60Hz	N/A	N/A	Conduction (CO01-HY)
RF Cable-CON	Suhner Switzerland	RG223/U	CB029	9kHz – 30MHz	Dec. 04, 2006	Dec. 04, 2007	Conduction (CO01-HY)
Spectrum analyzer	Agilent	E4408B	MY44211030	9KHz-26.5GHz	Jul. 25, 2006	Jul. 24, 2007	Radiation (03CH06-HY)
Receiver	R&S	ESCS30	100356	9KHz-2.75GHz	Jul. 25, 2006	Jul. 24, 2007	Radiation (03CH06-HY)
Controller	CT	SC100	N/A	N/A	Jun. 28, 2006	Jun. 27, 2007	Radiation (03CH06-HY)
Bilog Antenna	SCHAFFNER	CBL6112B	2885	30MHz -2GHz	N/A	N/A	Radiation (03CH06-HY)
Horn Antenna	Com-Power	AH118	071025	1G-18G	Feb. 1, 2005	Feb. 1, 2007	Radiation (03CH06-HY)
SHF-EHF Horn	SCHWARZBEC K	BBHA 9170	9170-249	14G - 40G	Feb. 1, 2005	Feb. 1, 2007	Radiation (03CH06-HY)
HF Amplifier	MITEQ	AFS44	973248	0.1G - 26.5G	Jul. 21, 2006	Jul. 20, 2007	Radiation (03CH06-HY)
Amplifier	MITEQ	AMF-6F	997165	26G - 40G	Jul. 21, 2006	Jul. 20, 2007	Radiation (03CH06-HY)
Turn Table	HD	DS 420	420/650/00	0 ~ 360 degree	N/A	N/A	Radiation (03CH06-HY)
Antenna Mast	HD	MA 240	240/560/00	1 m - 4 m	N/A	N/A	Radiation (03CH06-HY)



7. Uncertainty Evaluation

Uncertainty of Conducted Emission Measurement (150kHz ~ 30MHz)

Contribution	Uncertainty of x_i		$u(x_i)$
	dB	Probability Distribution	
Receiver reading	0.10	Normal(k=2)	0.05
Cable loss	0.10	Normal(k=2)	0.05
AMN insertion loss	2.50	Rectangular	0.63
Receiver Spec	1.50	Rectangular	0.43
Site imperfection	1.39	Rectangular	0.80
Mismatch	+0.34/-0.35	U-shape	0.24
combined standard uncertainty Uc(y)	1.13		
Measuring uncertainty for a level of confidence of 95% U=2Uc(y)	2.26		

Uncertainty of Radiated Emission Evaluation (30MHz ~ 1000MHz)

Contribution	Uncertainty of x_i		$u(x_i)$
	dB	Probability Distribution	
Receiver reading	0.15	Normal(k=2)	0.08
Antenna factor calibration	1.12	Normal(k=2)	0.56
Cable loss calibration	0.12	Normal(k=2)	0.06
Pre Amplifier Gain calibration	0.13	Normal(k=2)	0.07
RCV/SPA specification	2.5	Rectangular	0.72
Antenna Factor Interpolation for Frequency	1	Rectangular	0.29
Site imperfection	2.1	Rectangular	1.21
Mismatch	+0.39/-0.41	U-shaped	0.28
combined standard uncertainty Uc(y)	1.58		
Measuring uncertainty for a level of confidence of 95% U=2Uc(y)	3.16		



Uncertainty of Radiated Emission Measurement (1GHz ~ 40GHz)

Contribution	Uncertainty of x_i		$u(x_i)$	C_i	$C_i * u(x_i)$
	dB	Probability Distribution			
Receiver reading	±0.10	Normal(k=1)	0.10	1	0.10
Antenna factor calibration	±1.70	Normal(k=2)	0.85	1	0.85
Cable loss calibration	±0.50	Normal(k=2)	0.25	1	0.25
Receiver Correction	±2.00	Rectangular	1.15	1	1.15
Antenna Factor Directional	±1.50	Rectangular	0.87	1	0.87
Site imperfection	±2.80	Triangular	1.14	1	1.14
Mismatch Receiver VSWR $\Gamma_1 = 0.197$ Antenna VSWR $\Gamma_2 = 0.194$ Uncertainty = $20 \log(1 - \Gamma_1 \Gamma_2 \Gamma_3)$	+0.34/-0.35	U-shaped	0.244	1	0.244
Combined standard uncertainty $U_c(y)$	2.36				
Measuring uncertainty for a level of confidence of 95% $U = 2U_c(y)$	4.72				