



FCC Test Report

FCC Part 15.247 for FHSS systems/
CANADA RSS-210

For

Psion Teklogix Inc.

Handheld Computer

Model Number: 7505-BTSDCMMC75

FCC ID: GM37505BTSDCMMC75

IC ID: 2739D-7505BSMC

TEST REPORT #: EMC_PSION_001_07502_15.247BT_GM37505BTSDCMMC75

DATE: 2007-12-3



Certificate # 2135.01



Bluetooth[™]
Bluetooth Qualification
Test Facility
(BQTF)



LAB CODE 20020328-00

FCC listed#
A2LA Accredited

IC recognized #
3462B

CETECOM Inc.

411 Dixon Landing Road • Milpitas, CA 95035 • U.S.A.

Phone: + 1 (408) 586 6200 • Fax: + 1 (408) 586 6299 • E-mail: info@cetecomusa.com • <http://www.cetecom.com>

CETECOM Inc. is a Delaware Corporation with Corporation number: 2113686

Board of Directors: Dr. Harald Ansorge, Dr. Klaus Matkey, Hans Peter May



TABLE OF CONTENTS

1 Assessment _____ **4**

Technical responsibility for area of testing: _____ **4**

EMC & Radio _____ 4

This report is prepared by: _____ **4**

EMC & Radio _____ 4

2 Administrative Data _____ **5**

2.1 Identification of the Testing Laboratory Issuing the EMC Test Report _____ 5

2.2 Identification of the Client _____ 5

2.3 Identification of the Manufacturer _____ 5

3 Equipment under Test (EUT) _____ **6**

3.1 Specification of the Equipment under Test _____ 6

3.2 Identification of the Equipment Under Test (EUT) _____ 6

3.3 Identification of Accessory equipment _____ 6

4 Subject Of Investigation _____ **7**

5 Measurements (Radiated) _____ **8**

5.1 **MAXIMUM PEAK OUTPUT POWER** _____ **8**

EIRP: GFSK _____ 8

EIRP LOW CHANNEL-GFSK _____ 9

EIRP MIDDLE CHANNEL-GFSK _____ 10

EIRP HIGH CHANNEL-GFSK _____ 11

5.2 **RESTRICTED BAND EDGE COMPLIANCE RADIATED §15.247/15.205** _____ **12**

5.2.1 LIMITS _____ 12

5.2.2 RESULTS: GFSK _____ 13

5.3 **TRANSMITTER SPURIOUS EMISSIONS RADIATED § 15.247/15.205/15.209** _____ **17**

5.3.1 LIMITS _____ 17

5.3.2 RESULTS _____ 18

5.4 **RECEIVER RADIATED EMISSIONS § 2.1053 / RSS-132 & 133** _____ **27**

6 Measurements (CONDUCTED) _____ **32**

6.1 **MAXIMUM PEAK OUTPUT POWER § 15.247 (CONDUCTED)** _____ **32**

6.1.1 LIMIT SUB CLAUSE § 15.247 (b) (1) _____ 32

6.1.2 RESULTS: GFSK _____ 32

6.2 **20dB BANDWIDTH** _____ **36**

6.2.1 LIMIT SUB CLAUSE § 15.247 (a) (1) (i) (ii) (iii) _____ 36

6.2.2 RESULTS: GFSK _____ 36

6.3 **CARRIER FREQUENCY SEPARATION** _____ **40**

6.3.1 LIMIT SUB CLAUSE § 15.247 (a) (1) (i) (ii) (iii) _____ 40

6.3.2 RESULTS: _____ 40



6.4	NUMBER OF HOPPING CHANNELS	42
6.4.1	LIMIT SUB CLAUSE § 15.247 (a) (1) (iii)	42
6.4.2	RESULTS:	42
6.5	TIME OF OCCUPANCY (DWELL TIME)	47
6.5.1	LIMIT SUB CLAUSE § 15.247 (a) (1) (i) (ii) (iii)	47
6.5.2	RESULTS:	47
6.6	CONDUCTED SPURIOUS EMISSION	48
6.6.1	LIMIT SUB CLAUSE § 15.247 (d)	48
6.6.2	RESULTS: Tnom(23)°C VnomVDC	48
6.7	AC POWER LINE CONDUCTED EMISSIONS § 15.107/207	51
6.7.1	Limits	51
6.7.2	Results, TX Transmit Line:	52
6.7.3	TX Transmit Neutral:	54
6.7.4	Results, Idle Line:	56
6.7.5	TX Idle Neutral:	58
7	TEST EQUIPMENT AND ANCILLARIES USED FOR TESTS	60
8	BLOCK DIAGRAMS	61



1 Assessment

The following is in compliance with the applicable criteria specified in FCC rules Part 15.247 of the Code of Federal Regulations and in compliance with the applicable criteria specified in Industry Canada rules RSS210.

Company	Description	Model #
Psion Teklogix Inc	Handheld Computer	7505- BTSDCMMC75

Technical responsibility for area of testing:

Lothar Schmidt
(Director Regulatory and
Antenna Services)

2007-12-3 EMC & Radio

Date	Section	Name	Signature
------	---------	------	-----------

This report is prepared by:

Peter Mu
(EMC Project Engineer)

2007-12-3 EMC & Radio

Date	Section	Name	Signature
------	---------	------	-----------

The test results of this test report relate exclusively to the test item specified in Identification of the Equipment under Test. The CETECOM Inc. USA does not assume responsibility for any conclusions and generalizations drawn from the test results with regard to other specimens or samples of the type of the equipment represented by the test item. The test report may only be reproduced or published in full. Reproduction or publication of extracts from the report requires the prior written approval of the CETECOM Inc USA.

2 Administrative Data

2.1 Identification of the Testing Laboratory Issuing the EMC Test Report

Company Name:	CETECOM Inc.
Department:	EMC
Address:	411 Dixon Landing Road Milpitas, CA 95035 U.S.A.
Telephone:	+1 (408) 586 6200
Fax:	+1 (408) 586 6299
Responsible Test Lab Manager:	Lothar Schmidt
Responsible Project Leader:	Peter Mu
Date of test:	2007-11-13 to 2007-11-21

2.2 Identification of the Client

APPLICANT	
Applicant (Company Name)	Psion Teklogix Inc
Street Address	2100 Meadowvale Boulevard
City/Zip Code	Mississauga, Ontario, L5N 7J9
Country	USA
Contact Person	Sada Dharwarkar
Telephone	905-812-6200 ex 3358
Fax	905-812-6301
e-mail	Sada.dharwarkar@psionteklogix.com

2.3 Identification of the Manufacturer

Same as above applicant

3 Equipment under Test (EUT)

3.1 Specification of the Equipment under Test

Marketing Name:	Handheld Computer
Description:	Handheld Computer
Model No:	7505-BTSDCMMC75
Antenna Type:	1.1dBi MAX PIFA
Type(s) of Modulation:	GFSK
Frequency Band(s) of Operation:	2400~2483.5MHz
Numbers of Channels:	79
Equipment Classification: (CLASS)	<input type="checkbox"/> FIXED <input type="checkbox"/> VEHICULAR <input checked="" type="checkbox"/> PORTABLE <input type="checkbox"/> MODULE
Equipment Classification: (POWER(AC MAINS))	<input type="checkbox"/> 230VAC (<i>GROUND</i>) <input type="checkbox"/> 230VAC (<i>NO GROUND</i>) <input checked="" type="checkbox"/> 3.7VDC <input type="checkbox"/> 24VDC

3.2 Identification of the Equipment Under Test (EUT)

EUT #	TYPE	MANF.	MODEL	SERIAL #
1	EUT	Psion Teklogix Inc	7505-BTSDCMMC75	N/A

3.3 Identification of Accessory equipment

AE #	TYPE	MANF.	MODEL	SERIAL #
1	AC/DC ADAPTER	Phihong	PSA15R-050P	N/A



4 Subject Of Investigation

All testing was performed on the product referred to in Section 3 as EUT. This test report contains full radiated and conducted testing as per FCC15.247 on the EUT with the Bluetooth module.

The Bluetooth module is tested with host device handheld computer 7505. A control software provided by Psion is used to operate the module on desired channel and power level while the measurement took place.

During the testing process the EUT was tested on a single channel using PRBS9 payload using DH5, 2DH5 or 3DH5 packets, all data in this report shows the worst case between horizontal and vertical polarization for above 1GHz.

The objective of the measurements done by Cetecom Inc. was to measure the performance of the EUT as specified by requirements listed in FCC rules Part 15.247 of Title 47 of the Code of Federal Regulations and Industry Canada rules RSS210. The maximization of portable equipment is conducted in accordance with ANSI C63.4.



5 Measurements (Radiated)

5.1 MAXIMUM PEAK OUTPUT POWER

EIRP: GFSK

TEST CONDITIONS		MAXIMUM PEAK OUTPUT POWER (dBm)		
Frequency (MHz)		2402	2441	2480
T _{nom} (23)°C	V _{nom} VDC	-5.56	-4.03	-3.30
Measurement uncertainty		±0.5dBm		

EIRP LOW CHANNEL-GFSK

EUT: HC25
Customer:: Pscion
Test Mode: BT GFSK
ANT Orientation: H
EUT Orientation: V
Test Engineer: Sam
Voltage: AC adaptor
Comments: TT@57°

SWEEP TABLE: "EIRP BT low channel"

Start Frequency	Stop Frequency	Detector	Meas. Time	IF Bandw.	Transducer
2.4 GHz	2.4 GHz	MaxPeak	Coupled	3 MHz	DUMMY-DBM
Short Description:		EIRP Bluetooth channel-2402MHz			
MaxPeak					

Marker: 2.402170341 GHz -5.76 dBm

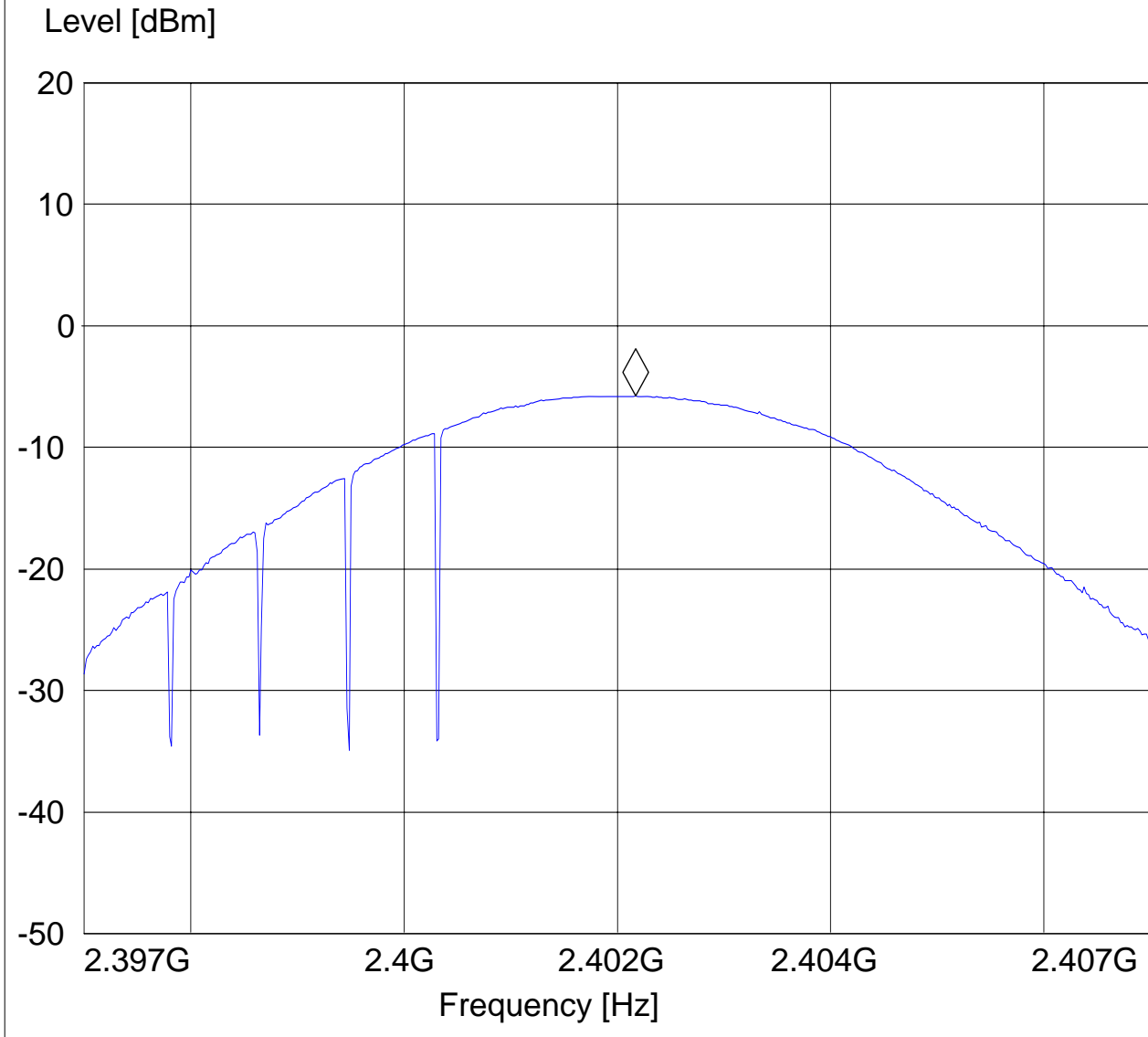

EIRP MIDDLE CHANNEL-GFSK

EUT: HC25
Customer:: Pscion
Test Mode: BT GFSK CH39
ANT Orientation: H
EUT Orientation: V
Test Engineer: Sam
Voltage: AC adaptor
Comments: TT@57°

SWEEP TABLE: "EIRP BT mid channel"

Start	Stop	Detector	Meas. Time	IF Bandw.	Transducer
2.4 GHz	2.4 GHz	MaxPeak	Coupled	3 MHz	DUMMY-DBM

Marker: 2.441304609 GHz -4.03 dBm

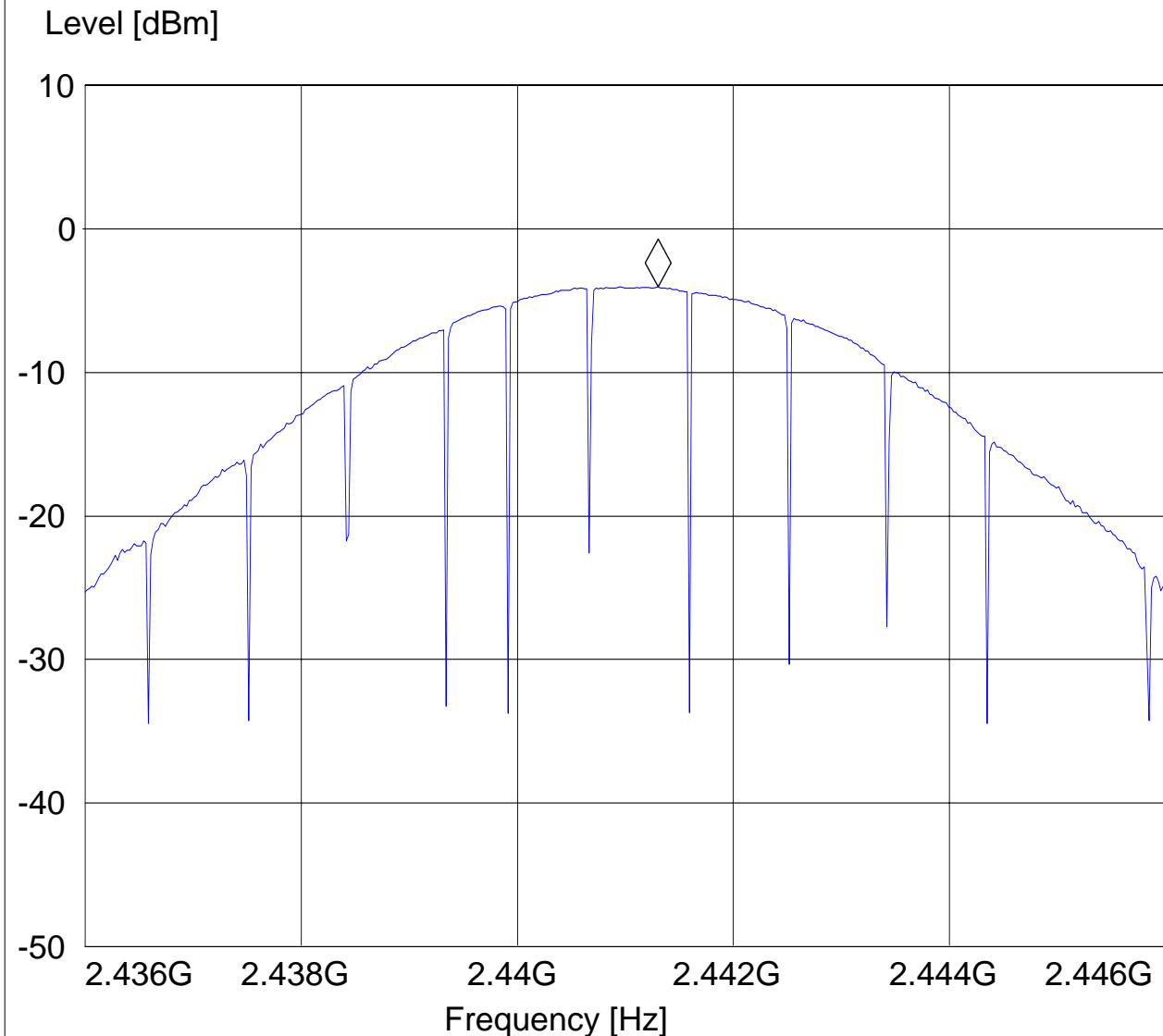

EIRP HIGH CHANNEL-GFSK

EUT: HC25
Customer:: Psion
Test Mode: BT GFSK CH78
ANT Orientation: H
EUT Orientation: V
Test Engineer: Sam
Voltage: AC adaptor
Comments: TT@57°

SWEEP TABLE: "EIRP BT high channel"

Start	Stop	Detector	Meas. Time	IF Bandw.	Transducer
2.5 GHz	2.5 GHz	MaxPeak	Coupled	3 MHz	DUMMY-DBM
Short Description:		EIRP Bluetooth channel-2480MHz			
MaxPeak					

Marker: 2.479749499 GHz -3.3 dBm

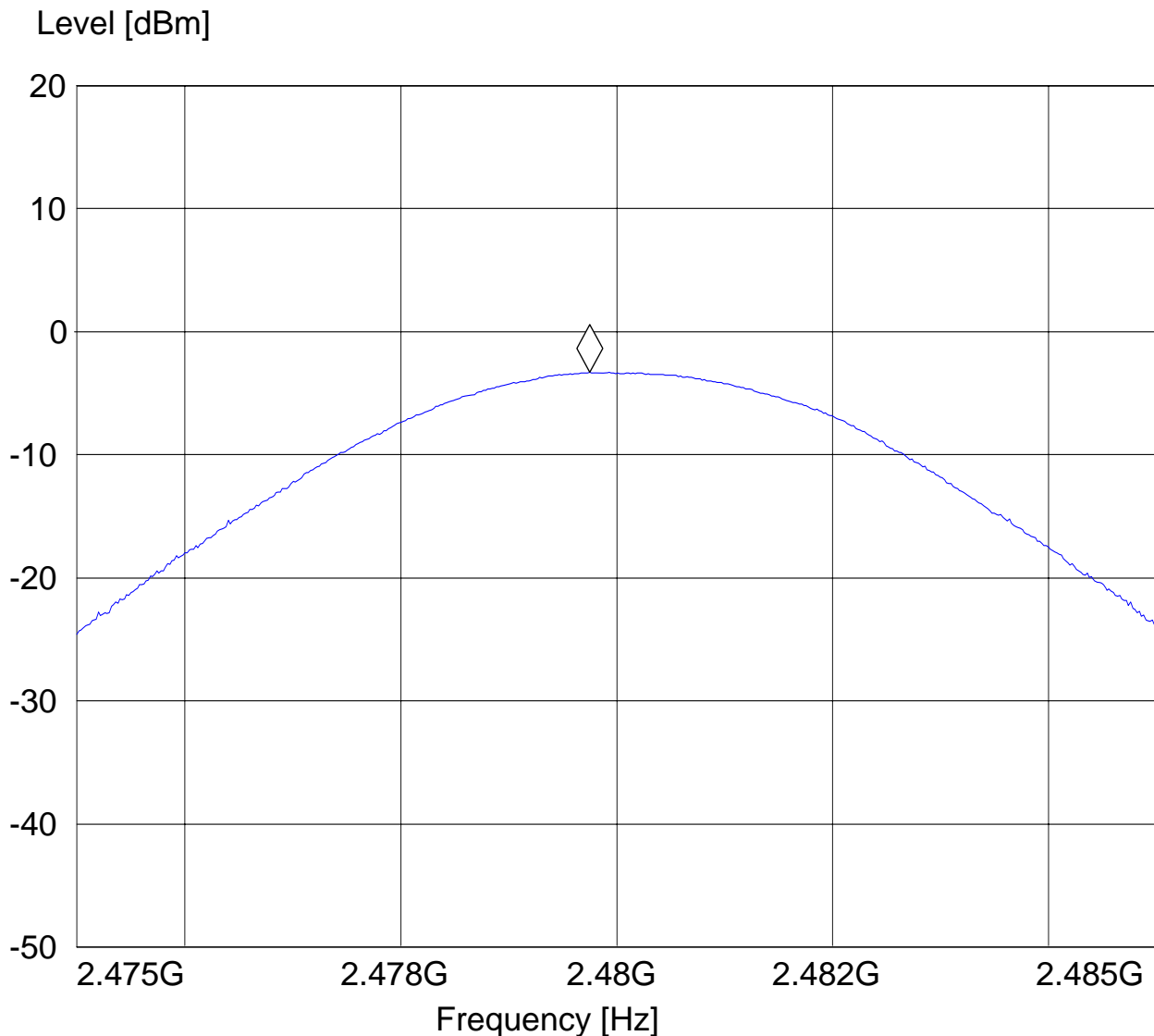

5.2 RESTRICTED BAND EDGE COMPLIANCE RADIATED §15.247/15.205

5.2.1 LIMITS

(a) Except as shown in paragraph (d) of this section, only spurious emissions are permitted in any of the frequency bands listed below:

MHz	MHz	MHz	GHz
0.090 - 0.110	16.42 - 16.423	399.9 - 410	4.5 - 5.15
¹ 0.495 - 0.505	16.69475 - 16.69525	608 - 614	5.35 - 5.46
2.1735 - 2.1905	16.80425 - 16.80475	960 - 1240	7.25 - 7.75
4.125 - 4.128	25.5 - 25.67	1300 - 1427	8.025 - 8.5
4.17725 - 4.17775	37.5 - 38.25	1435 - 1626.5	9.0 - 9.2
4.20725 - 4.20775	73 - 74.6	1645.5 - 1646.5	9.3 - 9.5
6.215 - 6.218	74.8 - 75.2	1660 - 1710	10.6 - 12.7
6.26775 - 6.26825	108 - 121.94	1718.8 - 1722.2	13.25 - 13.4
6.31175 - 6.31225	123 - 138	2200 - 2300	14.47 - 14.5
8.291 - 8.294	149.9 - 150.05	2310 - 2390	15.35 - 16.2
8.362 - 8.366	156.52475 - 156.52525	2483.5 - 2500	17.7 - 21.4
8.37625 - 8.38675	156.7 - 156.9	2690 - 2900	22.01 - 23.12
8.41425 - 8.41475	162.0125 - 167.17	3260 - 3267	23.6 - 24.0
12.29 - 12.293	167.72 - 173.2	3332 - 3339	31.2 - 31.8
12.51975 - 12.52025	240 - 285	3345.8 - 3358	36.43 - 36.5
12.57675 - 12.57725	322 - 335.4	3600 - 4400	(²)
13.36 - 13.41			

***PEAK LIMIT= 74dBuV/m**

***AVG. LIMIT= 54dBuV/m**

5.2.2 RESULTS: GFSK
(2402MHz) LOWER BAND EDGE PEAK -GFSK MODULATION

EUT: HC25
Customer:: Psion
Test Mode: BT CH 0
ANT Orientation: H
EUT Orientation: V
Test Engineer: peter
Voltage: AC ADAPTER
Comments:

SWEEP TABLE: "FCC15.247 LBE_PK"

Start Frequency	Stop Frequency	Detector	Meas. Time	IF Bandw.	Transducer
2.3 GHz	2.4 GHz	MaxPeak	Coupled	1 MHz	#326horn_AF_vert

Marker: 2.402056112 GHz 87.79 dBμV/m

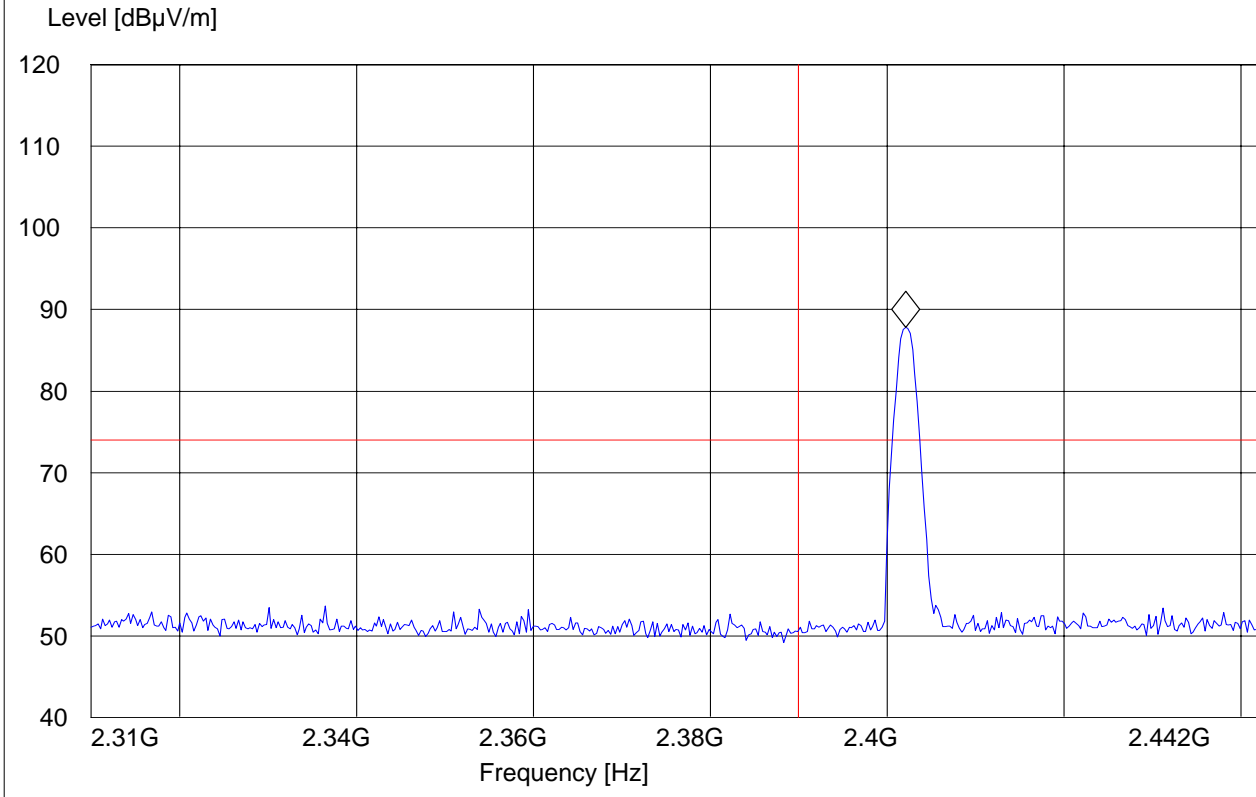



(2402MHz) LOWER BAND EDGE AVERAGE -GFSK MODULATION

EUT: HC25
Customer:: Psion
Test Mode: BT CH 0
ANT Orientation: H
EUT Orientation: V
Test Engineer: peter
Voltage: AC ADAPTER
Comments:

SWEEP TABLE: "FCC15.247 LBE_AVG"

Start Frequency	Stop Frequency	Detector	Meas. Time	IF Bandw.	Transducer
2.3 GHz	2.4 GHz	MaxPeak	Coupled	1 MHz	#326horn_AF_vert

Marker: 2.402144289 GHz 56.18 dB μ V/m

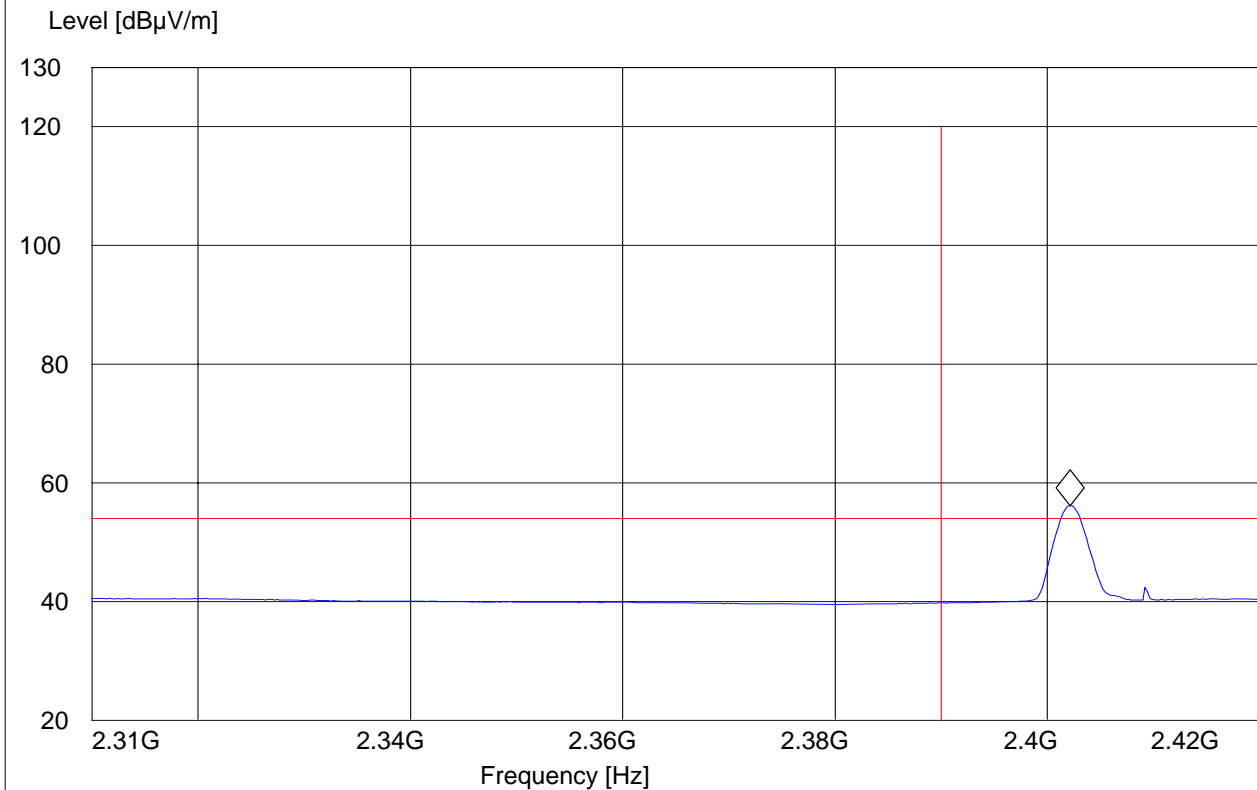

(2480MHz) HIGHER BAND EDGE PEAK -GFSK MODULATION

EUT: HC25
Customer:: Psion
Test Mode: BT CH 0
ANT Orientation: H
EUT Orientation: V
Test Engineer: peter
Voltage: AC ADAPTER
Comments:

SWEEP TABLE: "FCC15.247 HBE_PK"

Start Frequency	Stop Frequency	Detector	Meas. Time	IF Bandw.	Transducer
2.5 GHz	2.5 GHz	MaxPeak	Coupled	1 MHz	#326horn_AF_vert

Marker: 2.480200401 GHz 92.94 dB μ V/m

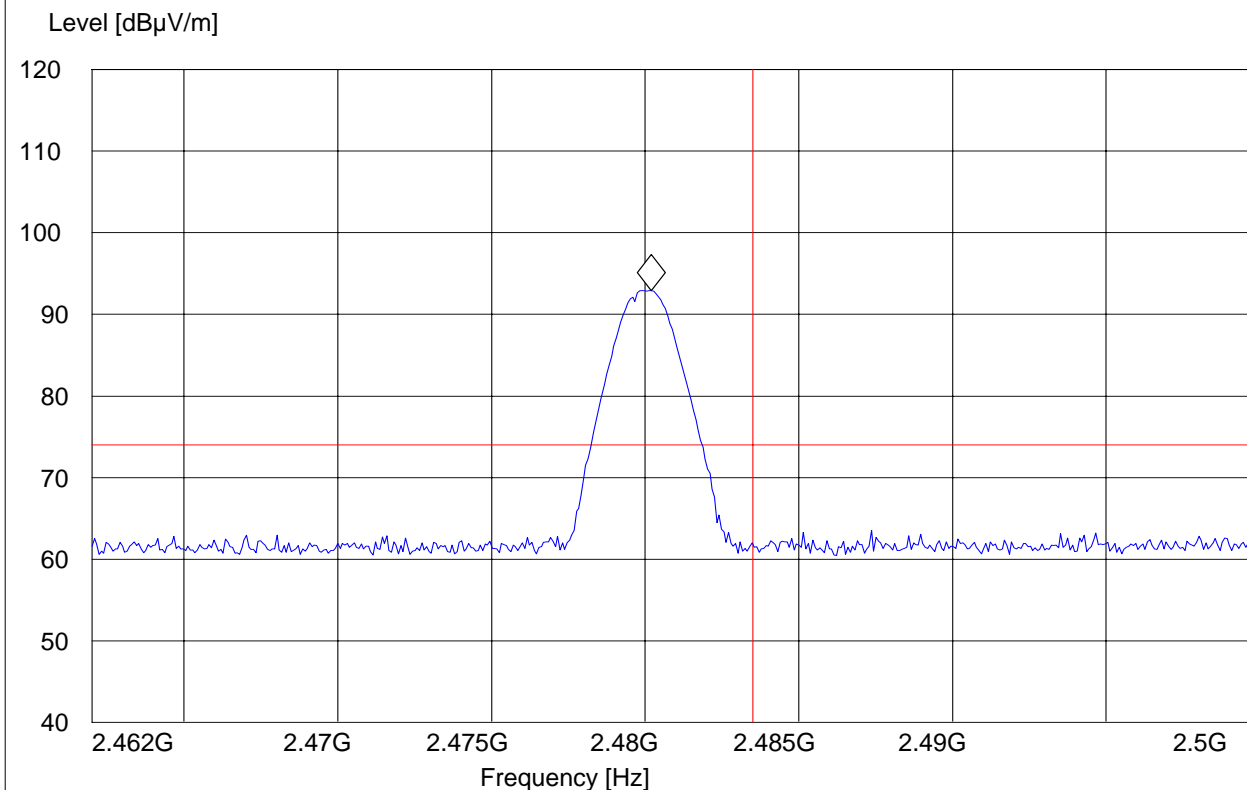



HIGHER BAND EDGE AVERAGE-GFSK MODULATION

EUT: HC25
Customer:: Psion
Test Mode: BT CH 0
ANT Orientation: H
EUT Orientation: V
Test Engineer: peter
Voltage: AC ADAPTER
Comments:

SWEEP TABLE: "FCC15.247 HBE_AVG"

Start Frequency	Stop Frequency	Detector	Meas. Time	IF Bandw.	Transducer
2.5 GHz	2.5 GHz	MaxPeak	Coupled	1 MHz	#326horn_AF_horz

Marker: 2.480084168 GHz 64.35 dB μ V/m

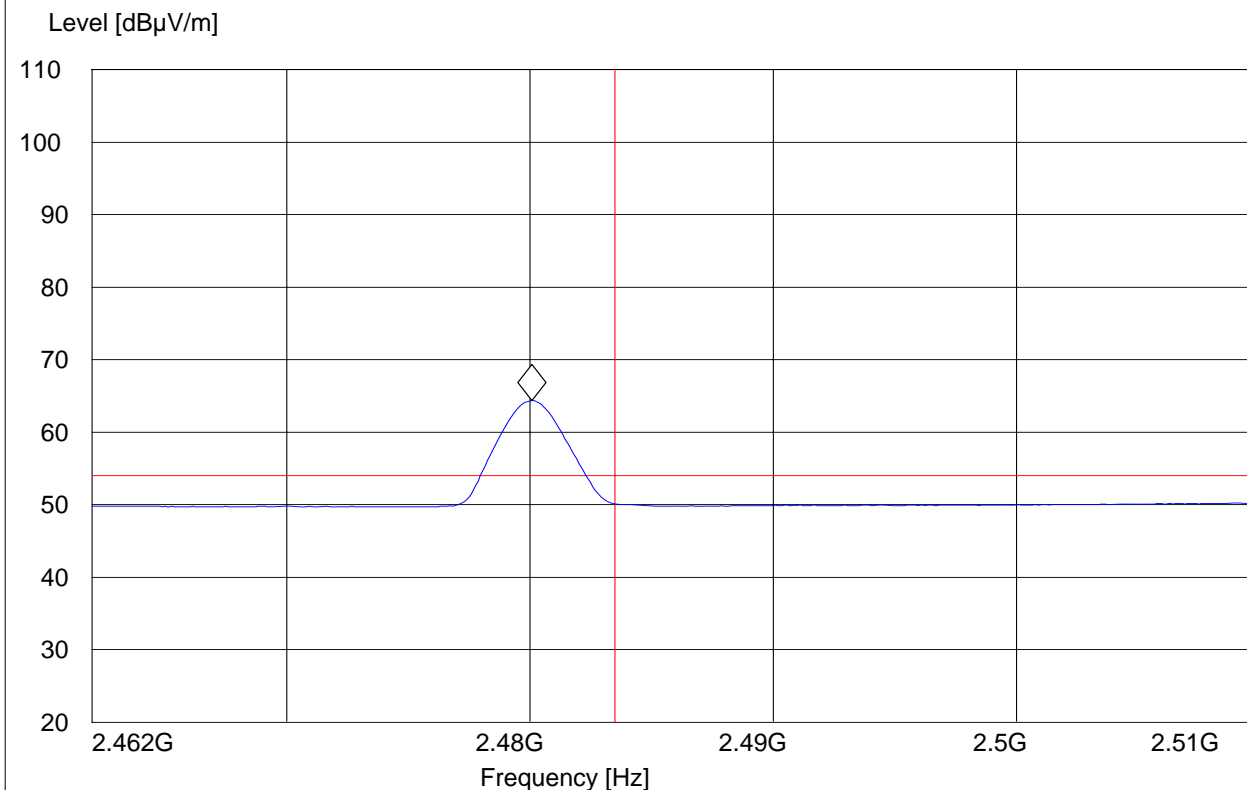

5.3 TRANSMITTER SPURIOUS EMISSIONS RADIATED § 15.247/15.205/15.209

5.3.1 LIMITS

(a) Except as shown in paragraph (d) of this section, only spurious emissions are permitted in any of the frequency bands listed below:

MHz	MHz	MHz	GHz
0.090 - 0.110	16.42 - 16.423	399.9 - 410	4.5 - 5.15
0.495 - 0.505	16.69475 - 16.69525	608 - 614	5.35 - 5.46
2.1735 - 2.1905	16.80425 - 16.80475	960 - 1240	7.25 - 7.75
4.125 - 4.128	25.5 - 25.67	1300 - 1427	8.025 - 8.5
4.17725 - 4.17775	37.5 - 38.25	1435 - 1626.5	9.0 - 9.2
4.20725 - 4.20775	73 - 74.6	1645.5 - 1646.5	9.3 - 9.5
6.215 - 6.218	74.8 - 75.2	1660 - 1710	10.6 - 12.7
6.26775 - 6.26825	108 - 121.94	1718.8 - 1722.2	13.25 - 13.4
6.31175 - 6.31225	123 - 138	2200 - 2300	14.47 - 14.5
8.291 - 8.294	149.9 - 150.05	2310 - 2390	15.35 - 16.2
8.362 - 8.366	156.52475 - 156.52525	2483.5 - 2500	17.7 - 21.4
8.37625 - 8.38675	156.7 - 156.9	2690 - 2900	22.01 - 23.12
8.41425 - 8.41475	162.0125 - 167.17	3260 - 3267	23.6 - 24.0
12.29 - 12.293	167.72 - 173.2	3332 - 3339	31.2 - 31.8
12.51975 - 12.52025	240 - 285	3345.8 - 3358	36.43 - 36.5
12.57675 - 12.57725	322 - 335.4	3600 - 4400	(²)
13.36 - 13.41			

*PEAK LIMIT= 74dBuV/m

*AVG. LIMIT= 54dBuV/m

NOTE:

1. The radiated emissions were done with different settings, using the relevant pre-amplifiers for the relevant frequency ranges. This is the reason that the graphs show different noise levels. In the range between 3 and 25 GHz very short cable connections to the antenna was used to minimize the noise level.

2. All measurements are done in peak mode using an average limit , unless specified with the plots.

Results for the radiated measurements below 30MHz according § 15.33

Frequency	Measured values	Remarks
9KHz – 30MHz	No emissions found, caused by the EUT	This is valid for all the tested channels

5.3.2 RESULTS

30MHz – 1GHz

Antenna: vertical

Note: This plot is valid for low, mid, high channels (worst-case plot)

EUT: HC25
Customer:: Psion
Test Mode: BT CH 39
ANT Orientation: V
EUT Orientation: V
Test Engineer: Sam
Voltage: AC ADAPTER
Comments:

SWEEP TABLE: "FCC15.247_30M-1G_Ver"

Start Frequency	Stop Frequency	Detector	Meas. Time	IF Bandw.	Transducer
30.0 MHz	1.0 GHz	MaxPeak	Coupled	100 kHz	3141-#1186_Vert

Marker: 941.683367 MHz 37.8 dBµV/m

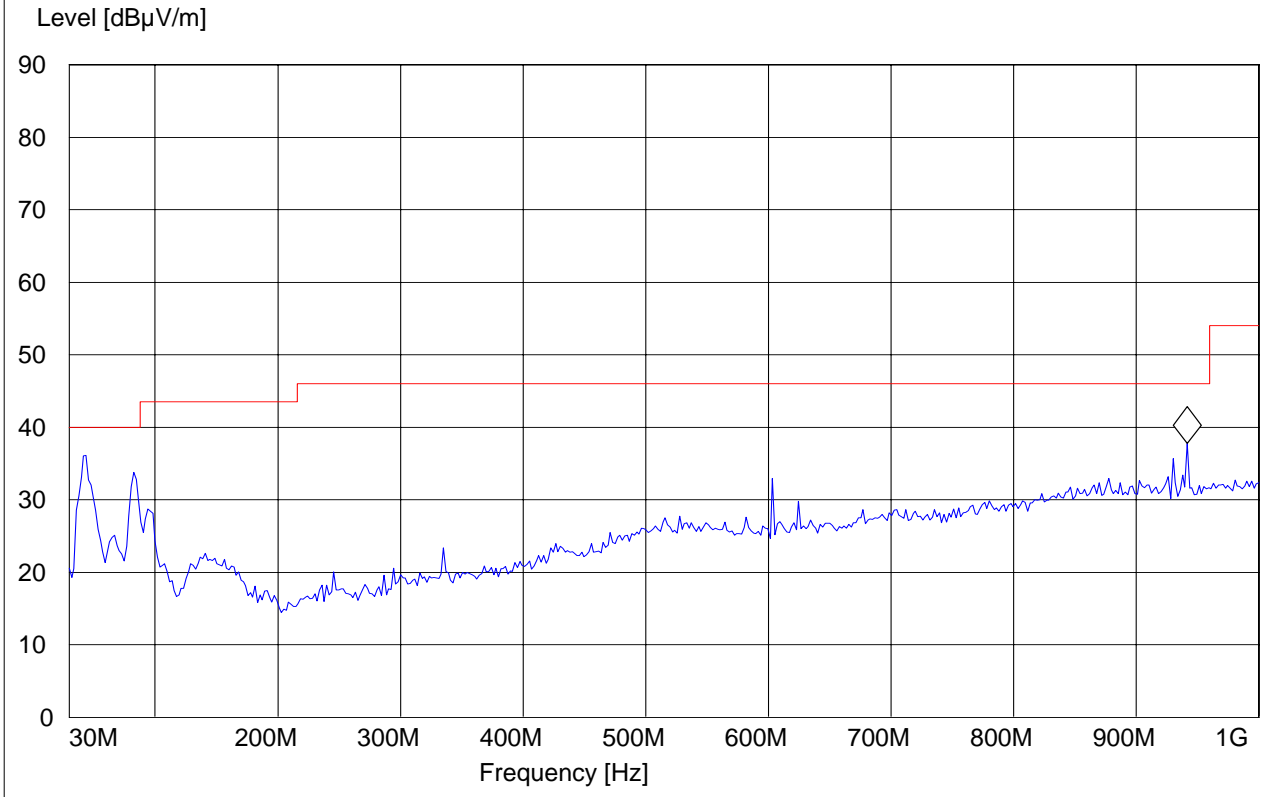

30MHz – 1GHz

Antenna: horizontal

Note: This plot is valid for low, mid, high channels (worst-case plot)

EUT: HC25
Customer:: Psion
Test Mode: BT CH 39
ANT Orientation: H
EUT Orientation: V
Test Engineer: Sam
Voltage: AC ADAPTER
Comments:

SWEEP TABLE: "FCC15.247_30M-1G_Hor"

Start Frequency	Stop Frequency	Detector	Meas. Time	IF Bandw.	Transducer
30.0 MHz	1.0 GHz	MaxPeak	Coupled	100 kHz	3141-#1186_Horz

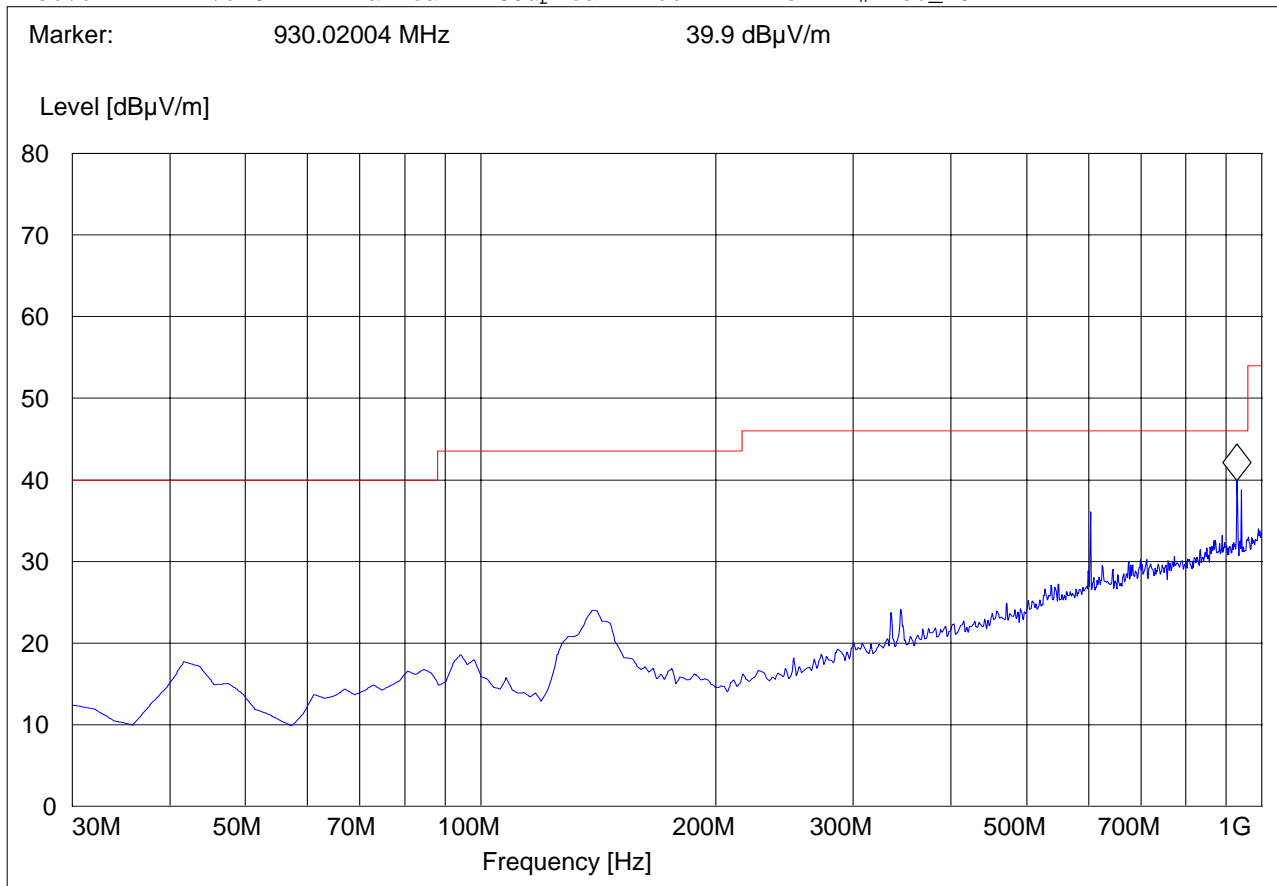

1-3GHz (2402MHz)

Note: The peak above the limit line is the carrier freq.

Note: Peak Reading vs. Average limit

EUT: HC25
Customer:: Psion
Test Mode: BT CH 0
ANT Orientation: H
EUT Orientation: V
Test Engineer: Sam
Voltage: AC ADAPTER
Comments:

SWEEP TABLE: "FCC15.247_1-3G"

Start Frequency	Stop Frequency	Detector	Meas. Time	IF Bandw.	Transducer
1.0 GHz	3.0 GHz	MaxPeak	Coupled	1 MHz	#326horn_AF_vert

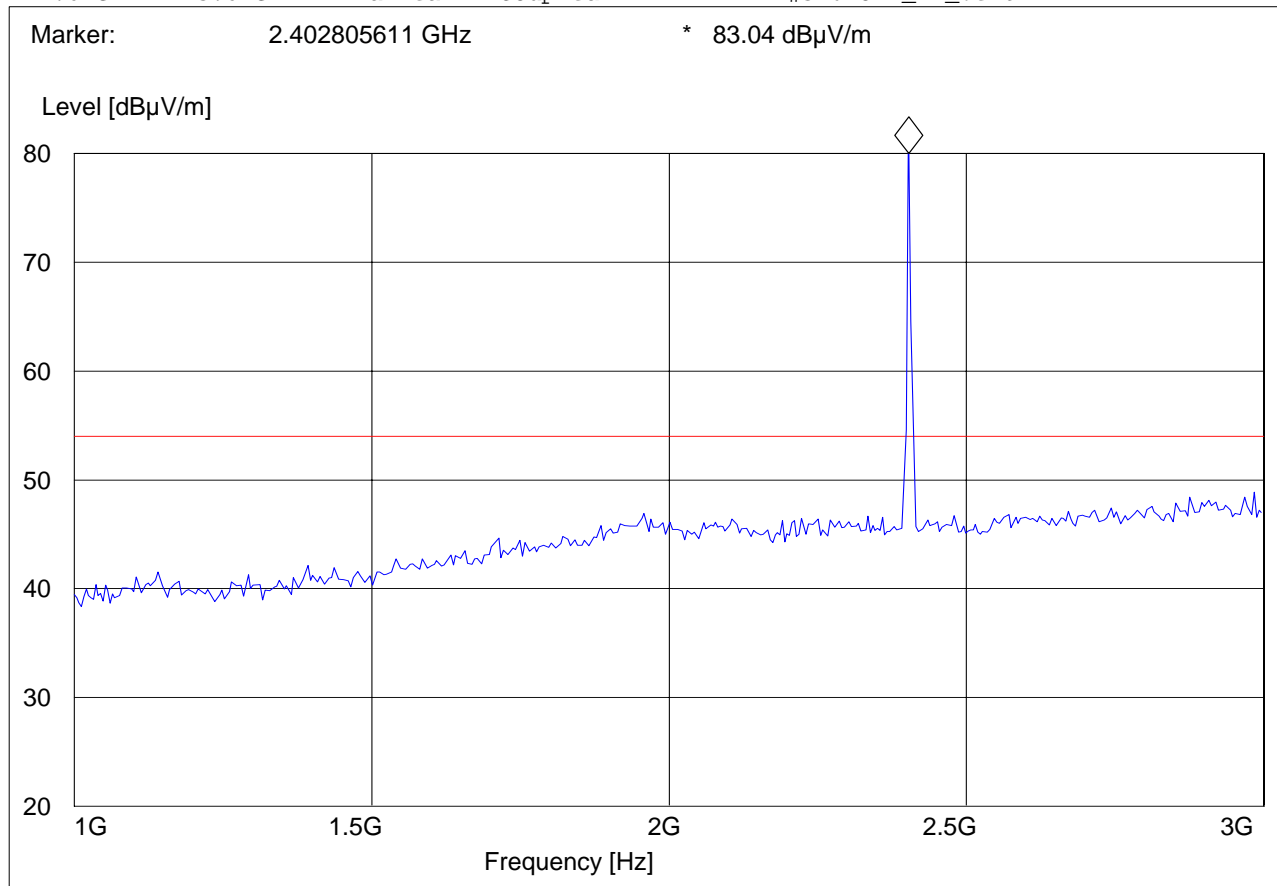

1-3GHz (2441MHz)

Note: The peaks above the limit line is the carrier freq.

Note: Peak Reading vs. Average limit

EUT: HC25
Customer:: Psion
Test Mode: BT CH 39
ANT Orientation: H
EUT Orientation: V
Test Engineer: Sam
Voltage: AC ADAPTER
Comments:

SWEEP TABLE: "FCC15.247_1-3G"

Start Frequency	Stop Frequency	Detector	Meas. Time	IF Bandw.	Transducer
1.0 GHz	3.0 GHz	MaxPeak	Coupled	1 MHz	#326horn_AF_vert

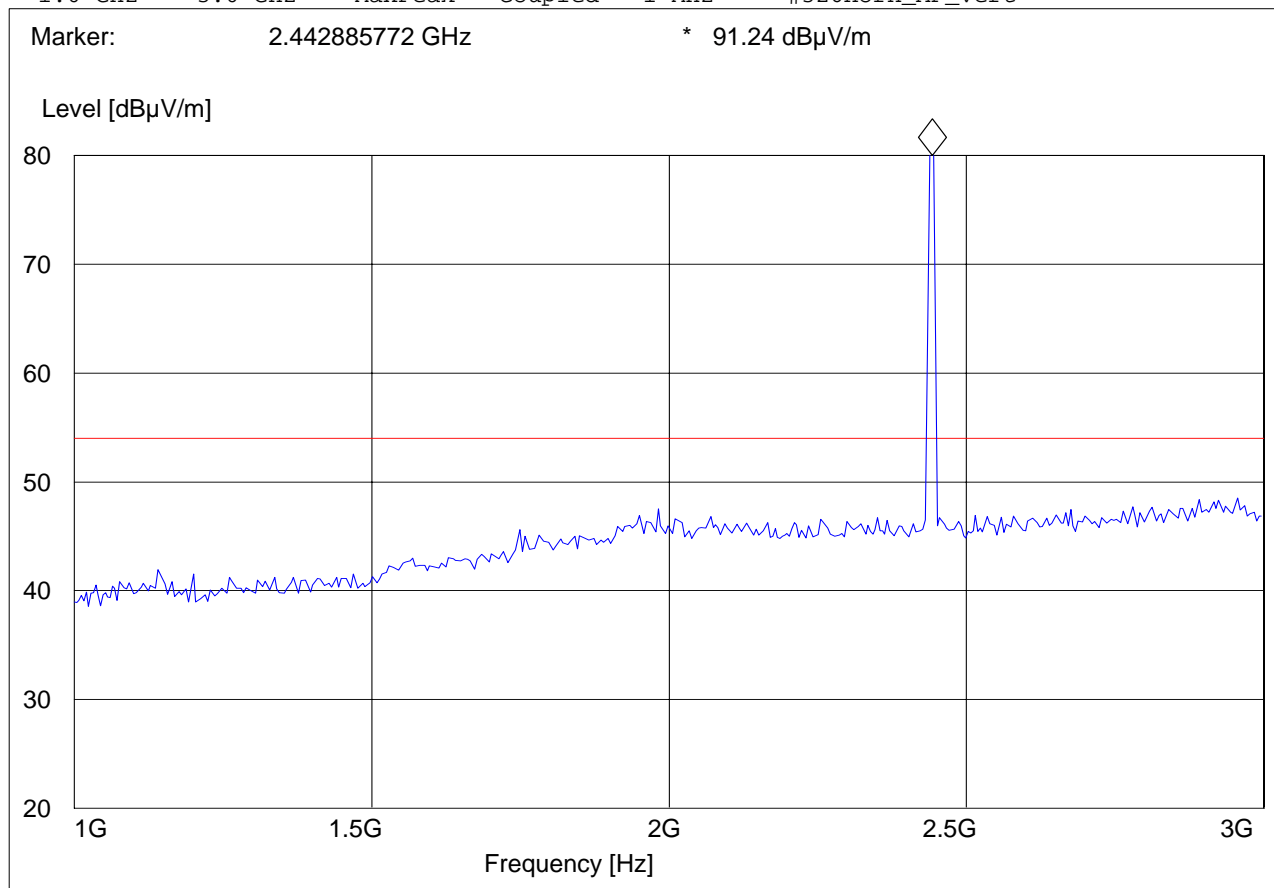

1-3GHz (2480MHz)

Note: The peaks above the limit line is the carrier freq.

Note: Peak Reading vs. Average limit

EUT: HC25
Customer:: Psion
Test Mode: BT CH 78
ANT Orientation: H
EUT Orientation: V
Test Engineer: Sam
Voltage: AC ADAPTER
Comments:

SWEEP TABLE: "FCC15.247_1-3G"

Start Frequency	Stop Frequency	Detector	Meas. Time	IF Bandw.	Transducer
1.0 GHz	3.0 GHz	MaxPeak	Coupled	1 MHz	#326horn_AF_vert

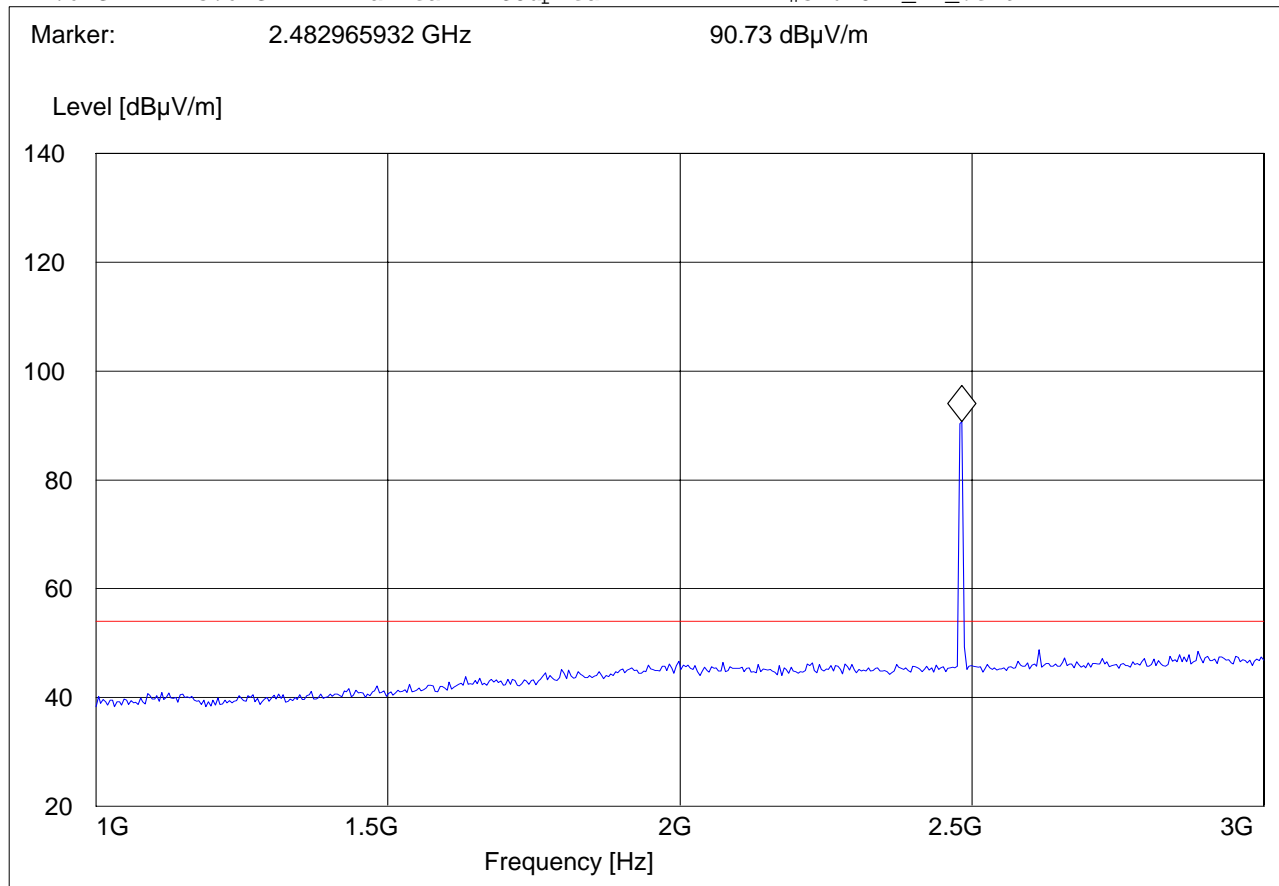

3-18GHz (2402MHz)

Note: Peak Reading vs. Average limit

EUT: HC25
Customer:: Psion
Test Mode: BT CH 0
ANT Orientation: H
EUT Orientation: V
Test Engineer: Sam
Voltage: AC ADAPTER
Comments:

SWEEP TABLE: "FCC15.247_3-18G"

Start Frequency	Stop Frequency	Detector	Meas. Time	IF Bandw.	Transducer
1.0 GHz	18.0 GHz	MaxPeak	Coupled	1 MHz	#326horn_AF_vert

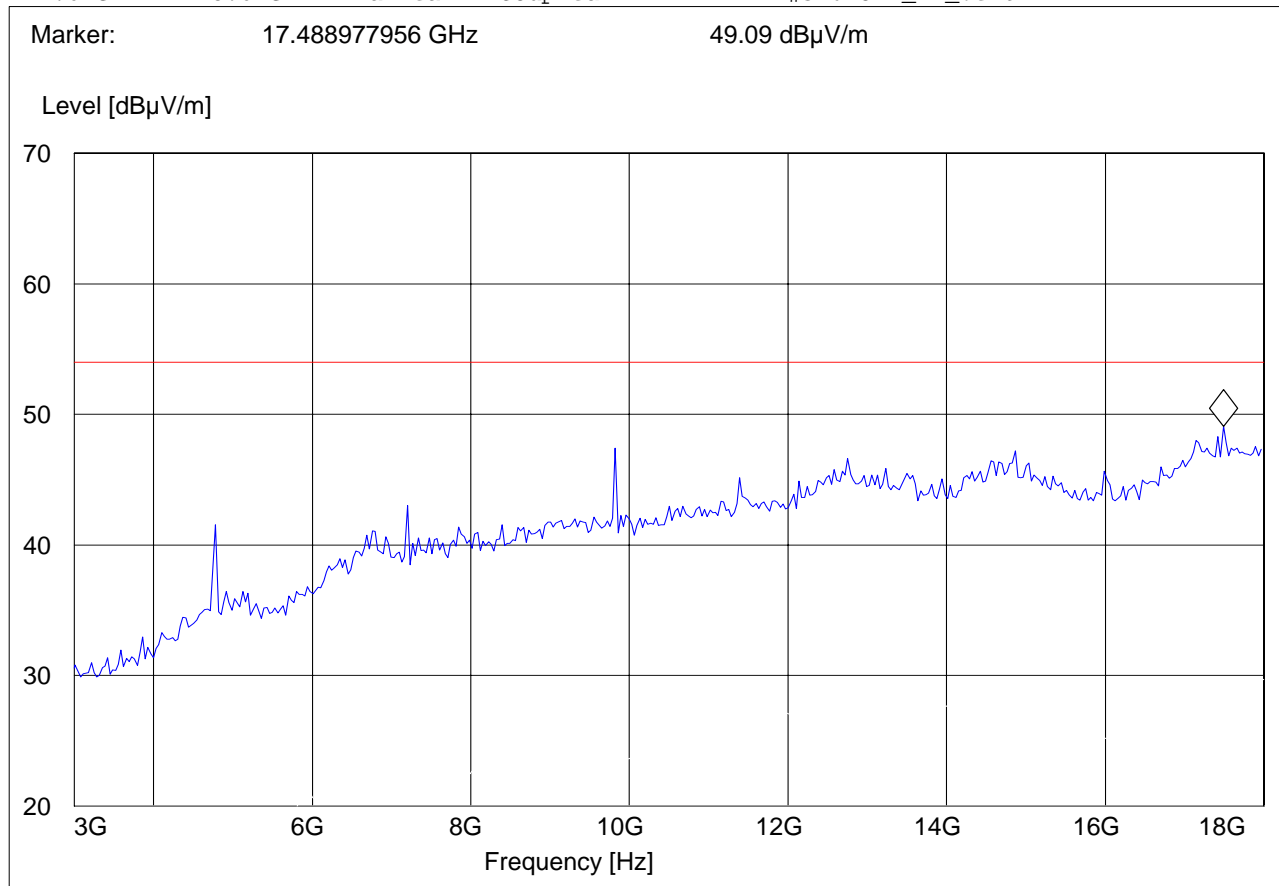

3-18GHz (2441MHz)

Note: Peak Reading vs. Average limit

EUT: HC25
Customer:: Psion
Test Mode: BT CH 0
ANT Orientation: H
EUT Orientation: V
Test Engineer: Sam
Voltage: AC ADAPTER
Comments:

SWEEP TABLE: "FCC15.247_3-18G"

Start Frequency	Stop Frequency	Detector	Meas. Time	IF Bandw.	Transducer
3.0 GHz	18.0 GHz	MaxPeak	Coupled	1 MHz	#326horn_AF_vert

Marker: 3 GHz 29.28 dB μ V/m

Level [dB μ V/m]

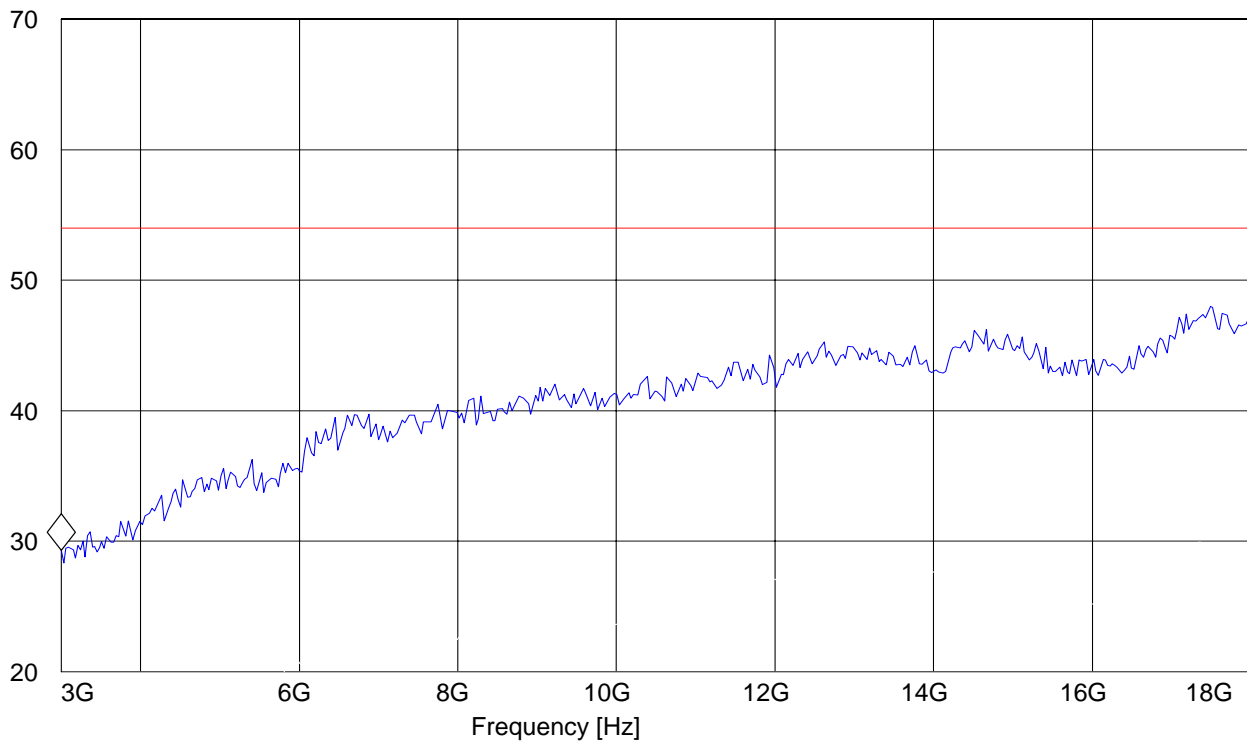

3-18GHz (2480MHz)

Note: Peak Reading vs. Average limit

EUT: HC25
Customer:: Psion
Test Mode: BT CH 0
ANT Orientation: H
EUT Orientation: V
Test Engineer: Sam
Voltage: AC ADAPTER
Comments:

SWEEP TABLE: "FCC15.247_3-18G"

Start Frequency	Stop Frequency	Detector	Meas. Time	IF Bandw.	Transducer
3.0 GHz	18.0 GHz	MaxPeak	Coupled	1 MHz	#326horn_AF_vert

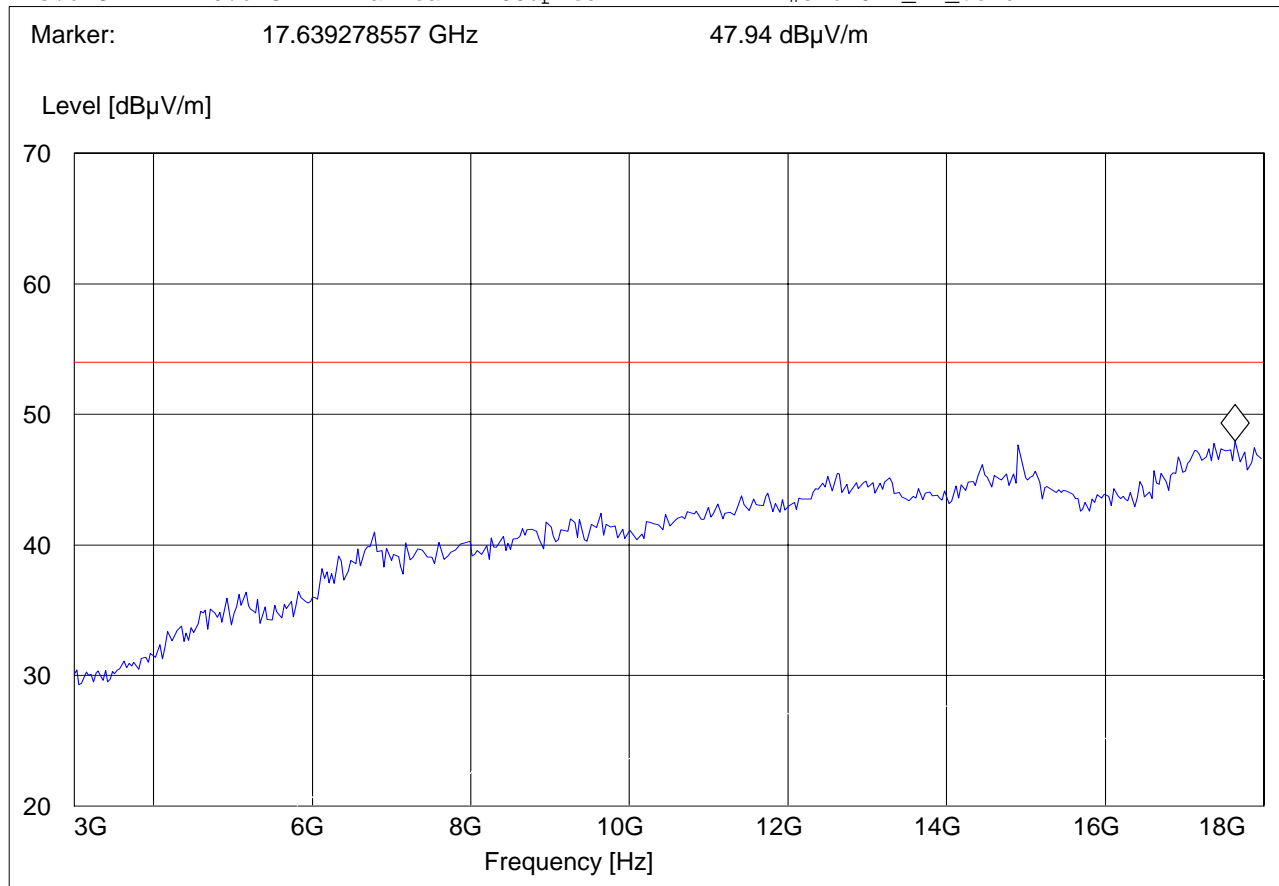



18-25GHz

Note: This plot is valid for low, mid, high channels (worst-case plot)

Note: Peak Reading vs. Average limit

EUT: HC25
Customer:: Psion
Test Mode: BT CH 39
ANT Orientation: H
EUT Orientation: V
Test Engineer: Sam
Voltage: AC ADAPTER
Comments:

SWEEP TABLE: "FCC15.247_18-26.5G"

Start Frequency	Stop Frequency	Detector	Meas. Time	IF Bandw.	Transducer
18.0 GHz	26.5 GHz	MaxPeak	Coupled	1 MHz	#572 horn AF

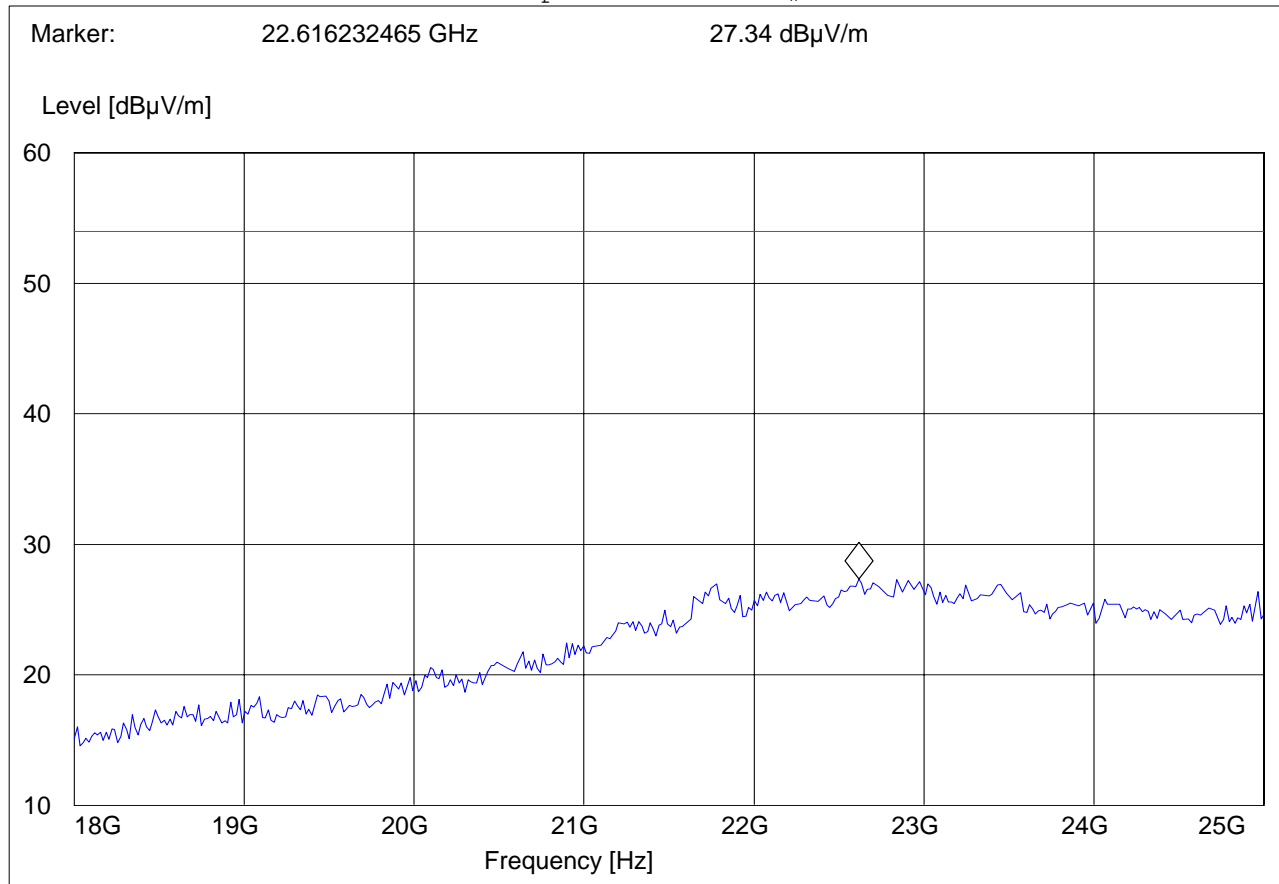



**5.4 RECEIVER RADIATED EMISSIONS
& 133**

§ 2.1053 / RSS-132

NOTE:

1. The radiated emissions were done with different settings, using the relevant pre-amplifiers for the relevant frequency ranges. This is the reason that the graphs show different noise levels. In the range between 3GHz and 26.5GHz very short cable connections to the antenna was used to minimize the noise level.

Limits

SUBCLAUSE § RSS-133

Frequency (MHz)	Field strength (μ V/m)	Measurement distance (m)
0.009 - 0.490	2400/F (kHz)	300
0.490 - 1.705	24000/F (kHz)	30
1.705 - 30.0	30	30
30 - 88	100	3
88 - 216	150	3
216 - 960	200	3
Above 960	500	3

30MHz – 1GHz

Antenna: vertical

Note: This plot is valid for low, mid, high channels (worst-case plot)

EUT: 7505
Customer:: Psion
Test Mode: BT CH 39
ANT Orientation: H
EUT Orientation: V
Test Engineer: Sam
Voltage: AC ADAPTER
Comments:

SWEEP TABLE: "FCC15.247_30M-1G_Ver"

Start Frequency	Stop Frequency	Detector	Meas. Time	IF Bandw.	Transducer
30.0 MHz	1.0 GHz	MaxPeak	Coupled	100 kHz	3141-#1186_Vert

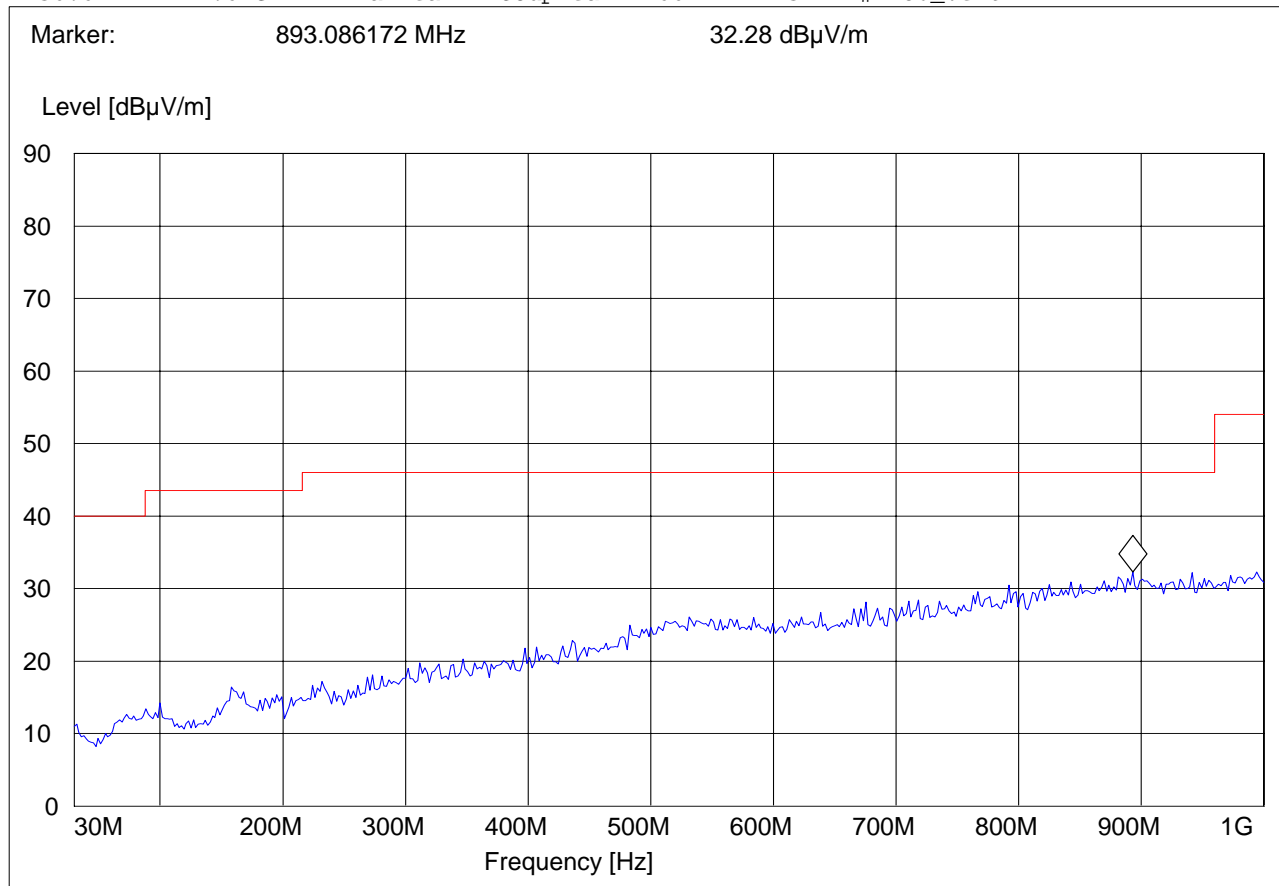

30MHz – 1GHz

Antenna: horizontal

Note: This plot is valid for low, mid, high channels (worst-case plot)

EUT: HC25
Customer:: Psion
Test Mode: BT CH 39
ANT Orientation: H
EUT Orientation: V
Test Engineer: Sam
Voltage: AC ADAPTER
Comments:

SWEEP TABLE: "FCC15.247_30M-1G_Hor"

Start Frequency	Stop Frequency	Detector	Meas. Time	IF Bandw.	Transducer
30.0 MHz	1.0 GHz	MaxPeak	Coupled	100 kHz	3141-#1186_Horz

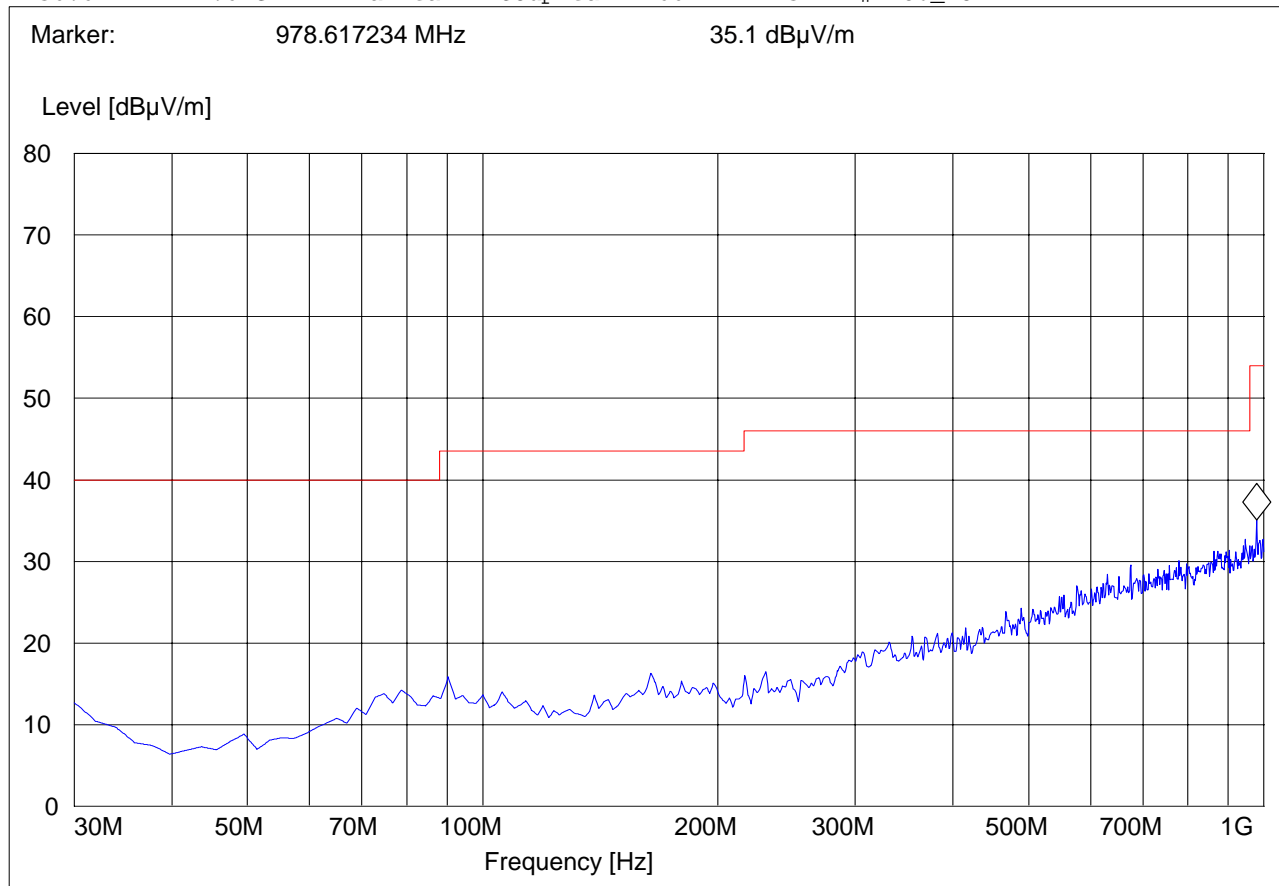

1-3GHz

Note: Peak Reading vs. Average limit

EUT: 7505
Customer:: Psion
Test Mode: BT CH 39
ANT Orientation: H
EUT Orientation: V
Test Engineer: Sam
Voltage: AC ADAPTER
Comments:

SWEEP TABLE: "FCC15.247_1-3G"

Start Frequency	Stop Frequency	Detector	Meas. Time	IF Bandw.	Transducer
1.0 GHz	3.0 GHz	MaxPeak	Coupled	1 MHz	#326horn_AF_vert

Marker: 2.903807615 GHz 47.35 dB μ V/m

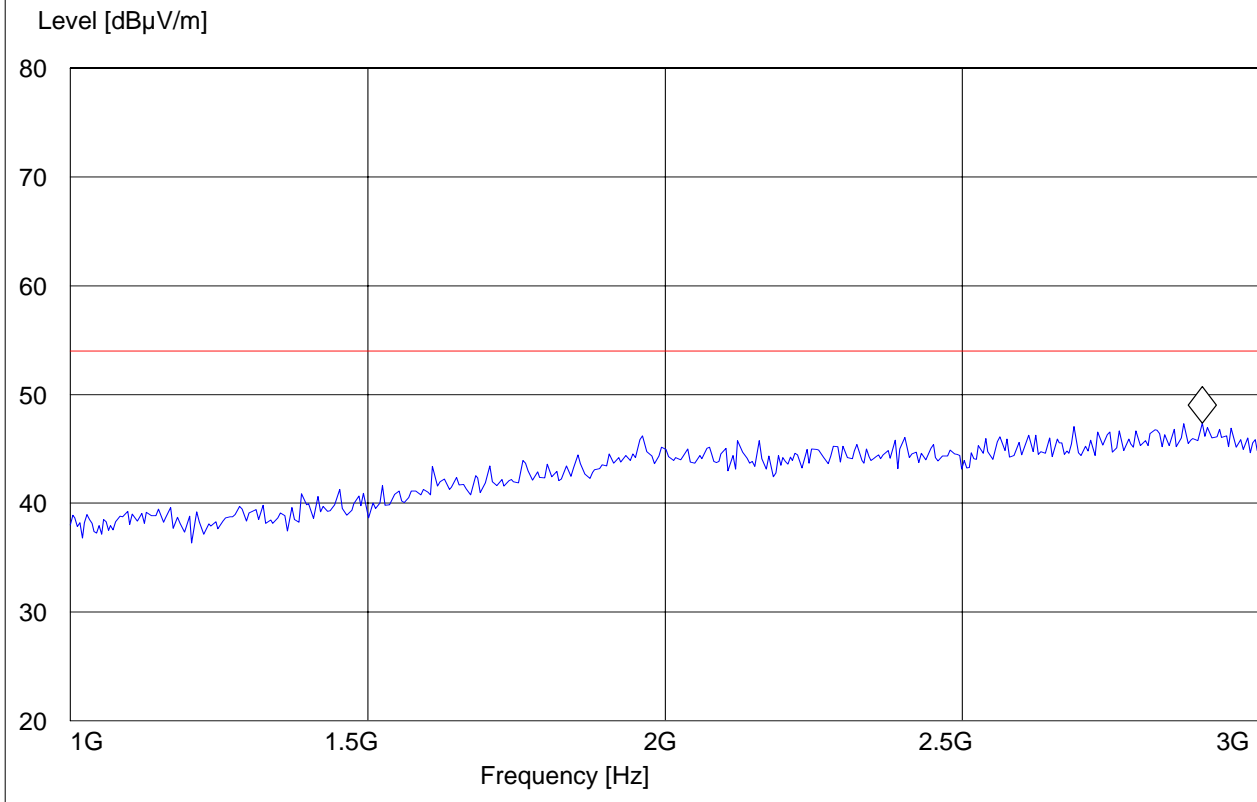



3-18GHz

Note: Peak Reading vs. Average limit

EUT: 7505
Customer:: Psion
Test Mode: BT CH 39
ANT Orientation: H
EUT Orientation: V
Test Engineer: Sam
Voltage: AC ADAPTER
Comments:

SWEEP TABLE: "FCC15.247_3-18G"

Start Frequency	Stop Frequency	Detector	Meas. Time	IF Bandw.	Transducer
3.0 GHz	18.0 GHz	MaxPeak	Coupled	1 MHz	#326horn_AF_vert

Marker: 17.368737475 GHz 47.45 dB μ V/m

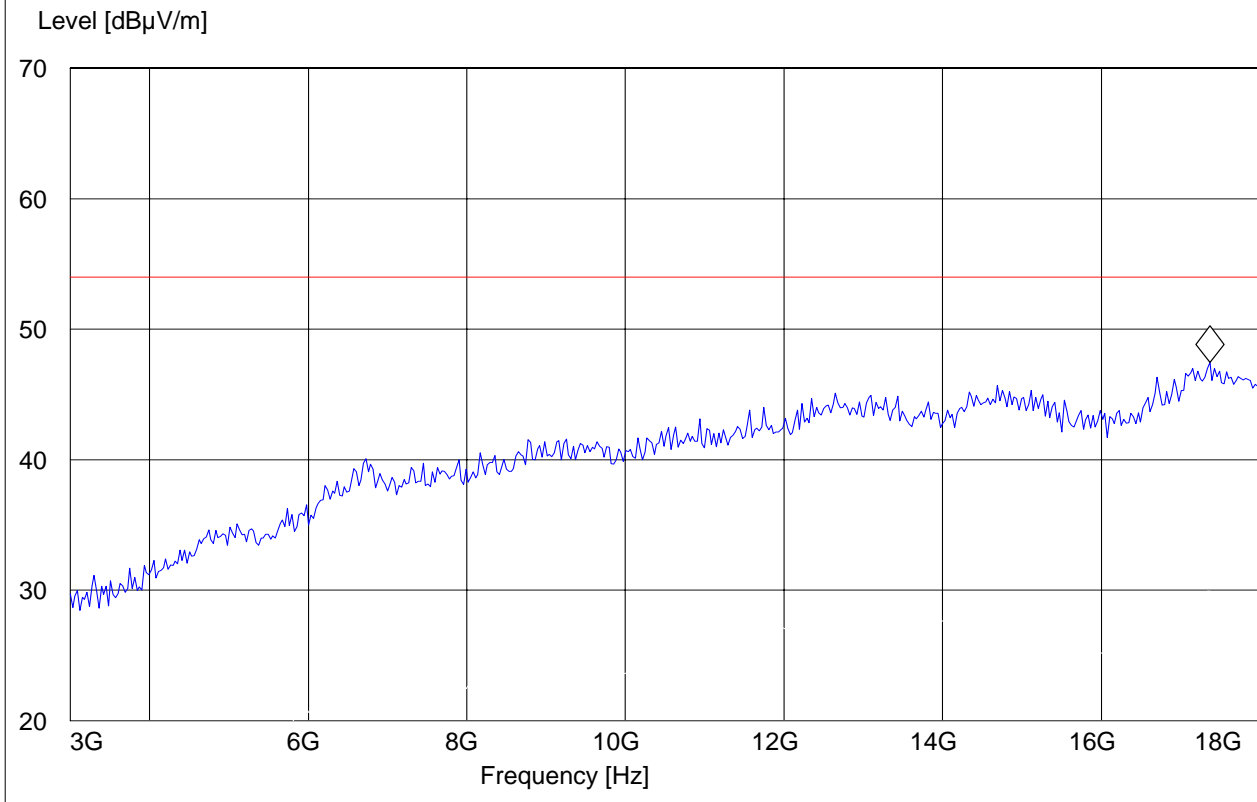



6 Measurements (CONDUCTED)

6.1 MAXIMUM PEAK OUTPUT POWER § 15.247 (CONDUCTED)

6.1.1 LIMIT SUB CLAUSE § 15.247 (b) (1)

Frequency range	RF power output
2400-2483.5 MHz	30dBm

*limit is based upon antenna gain of less than or equal to 6dBi.

6.1.2 RESULTS: GFSK

TEST CONDITIONS		MAXIMUM PEAK OUTPUT POWER (dBm)		
Frequency (MHz)		2402 MHz	2441 MHz	2480 MHz
T _{nom} (23)°C	V _{nom} VDC	3.56	3.97	3.93

(2402 MHz) GFSK

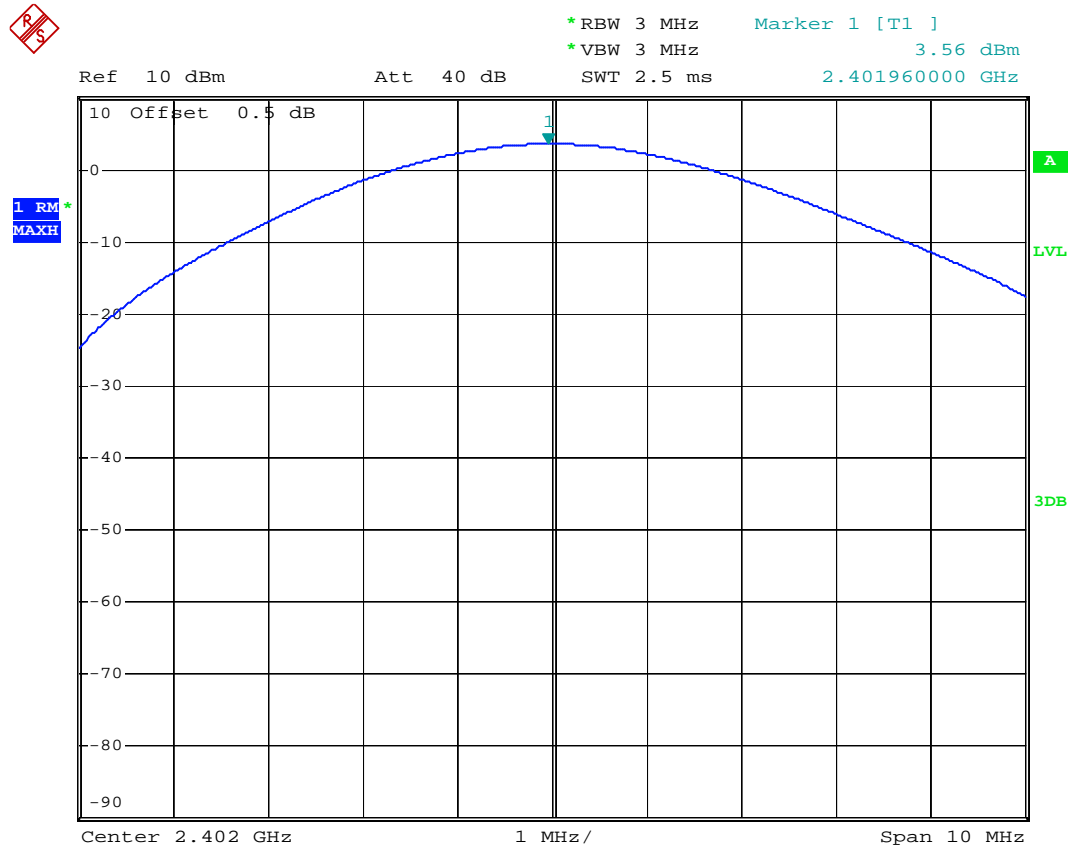

Date: 14.NOV.2007 19:45:19



(2441 MHz) GFSK

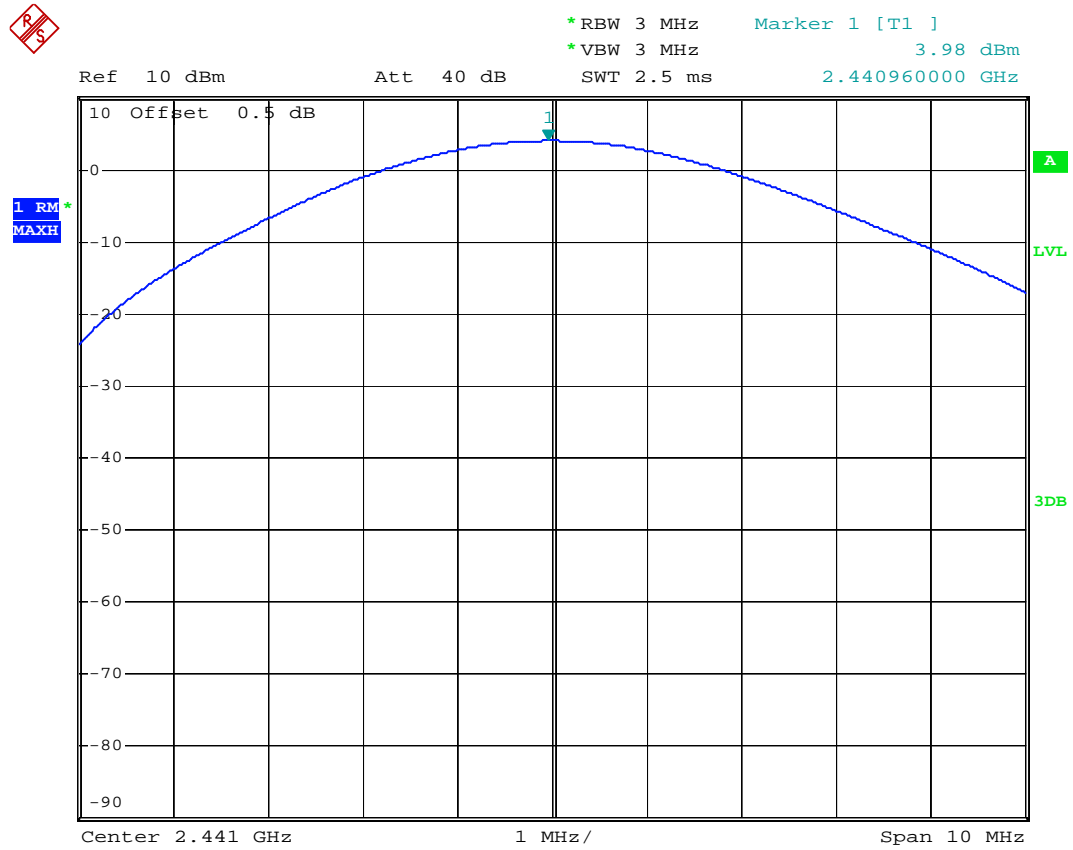

Date: 14.NOV.2007 19:44:37



(2480 MHz) GFSK



*RBW 3 MHz Marker 1 [T1]
*VBW 3 MHz 3.93 dBm
SWT 2.5 ms 2.479960000 GHz

Ref 10 dBm

Att 40 dB

1. RM
MAXH

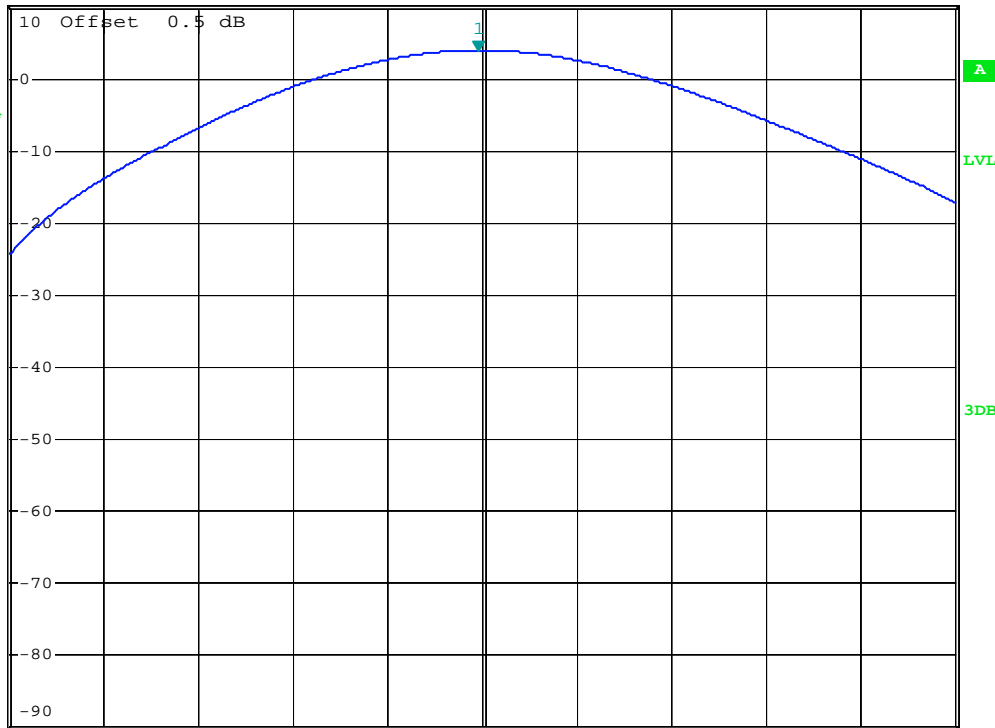

Center 2.48 GHz

1 MHz/

Span 10 MHz

Date: 14.NOV.2007 19:46:01

6.2 20dB BANDWIDTH

6.2.1 LIMIT SUB CLAUSE § 15.247 (a) (1) (i) (ii) (iii)

Alternatively, frequency hopping systems operating in the 2400–2483.5 MHz band may have hopping channel carrier frequencies that are separated by 25 kHz or two-thirds of the 20 dB bandwidth of the hopping channel, whichever is greater, provided the systems operate with an output power no greater than 125 mW.

6.2.2 RESULTS: GFSK

TEST CONDITIONS		BANDWIDTH (KHz)		
		2402 MHz	2441 MHz	2480 MHz
Frequency (MHz)				
T _{nom} (23)°C	V _{nom} VDC	872	872	876

(2402 MHz) GFSK

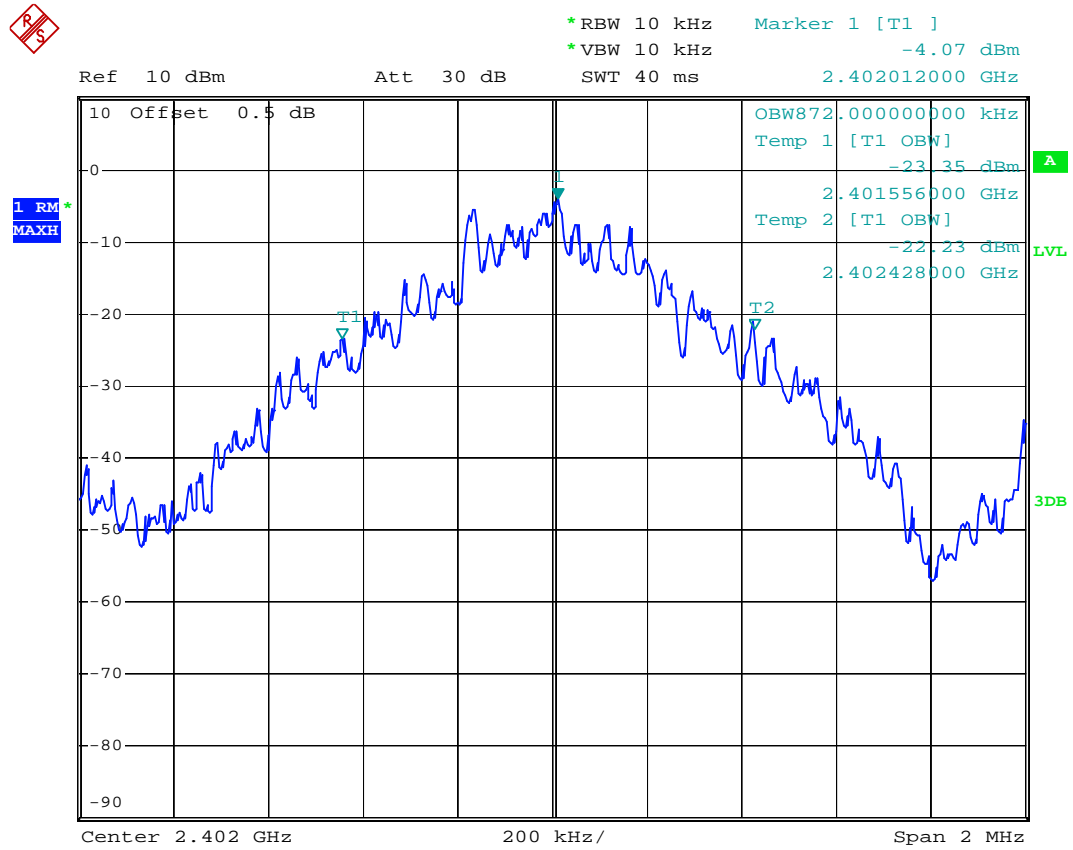

Date: 14.NOV.2007 19:51:56

(2441 MHz) GFSK

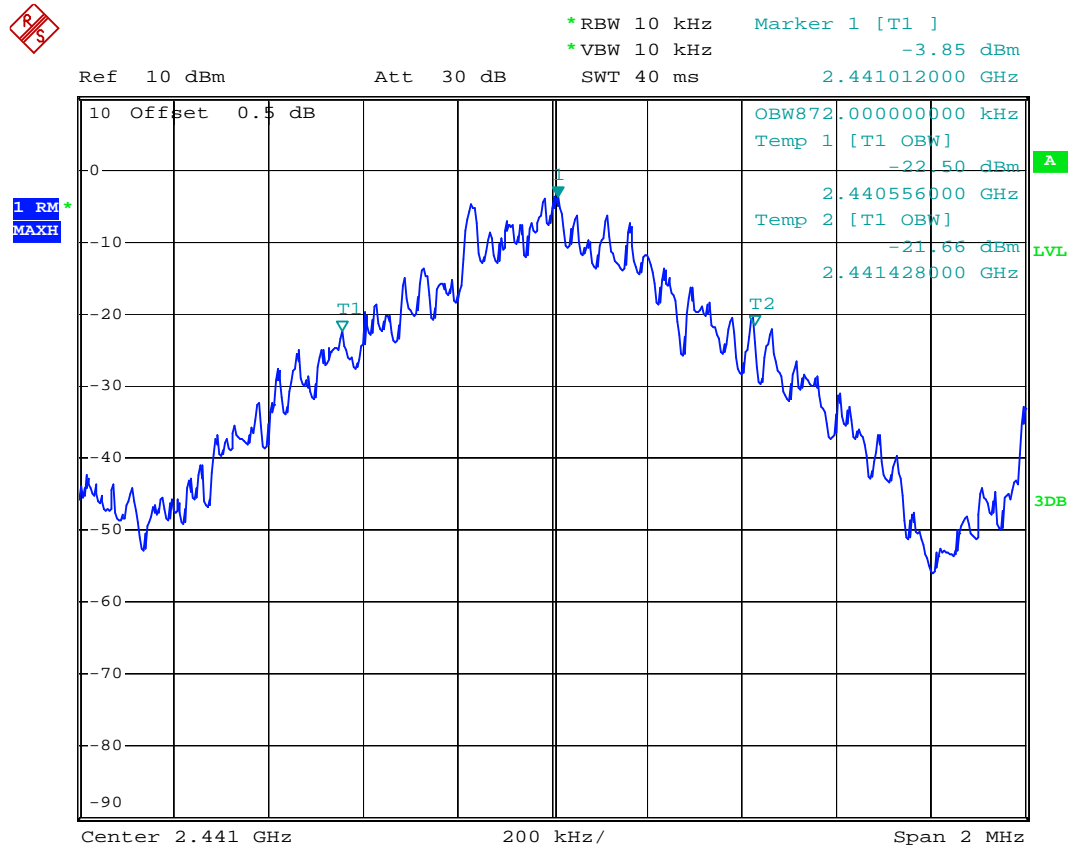

Date: 14.NOV.2007 19:51:14

(2480 MHz) GFSK

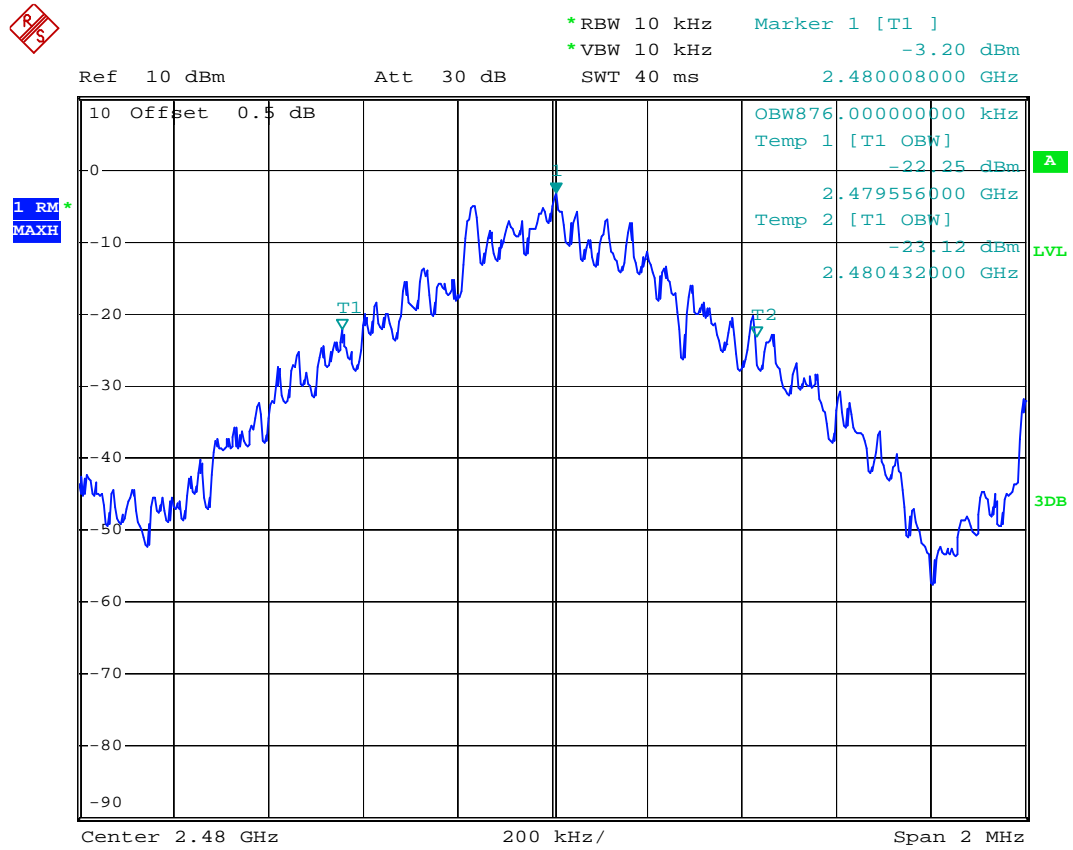

Date: 14.NOV.2007 19:50:19



6.3 CARRIER FREQUENCY SEPARATION

6.3.1 LIMIT SUB CLAUSE § 15.247 (a) (1) (i) (ii) (iii)

SEPARATION
> 25 KHz or > 20 dB BANDWIDTH

6.3.2 RESULTS:

TEST CONDITIONS		SEPARATION (MHz)
T_{nom}(23)°C	V_{nom}VDC	1.008



*RBW 30 kHz Delta 2 [T1]
*VBW 30 kHz -0.51 dB
SWT 10 ms 1.008000000 MHz

Ref 10 dBm

Att 40 dB

SWT 10 ms

1.008000000 MHz

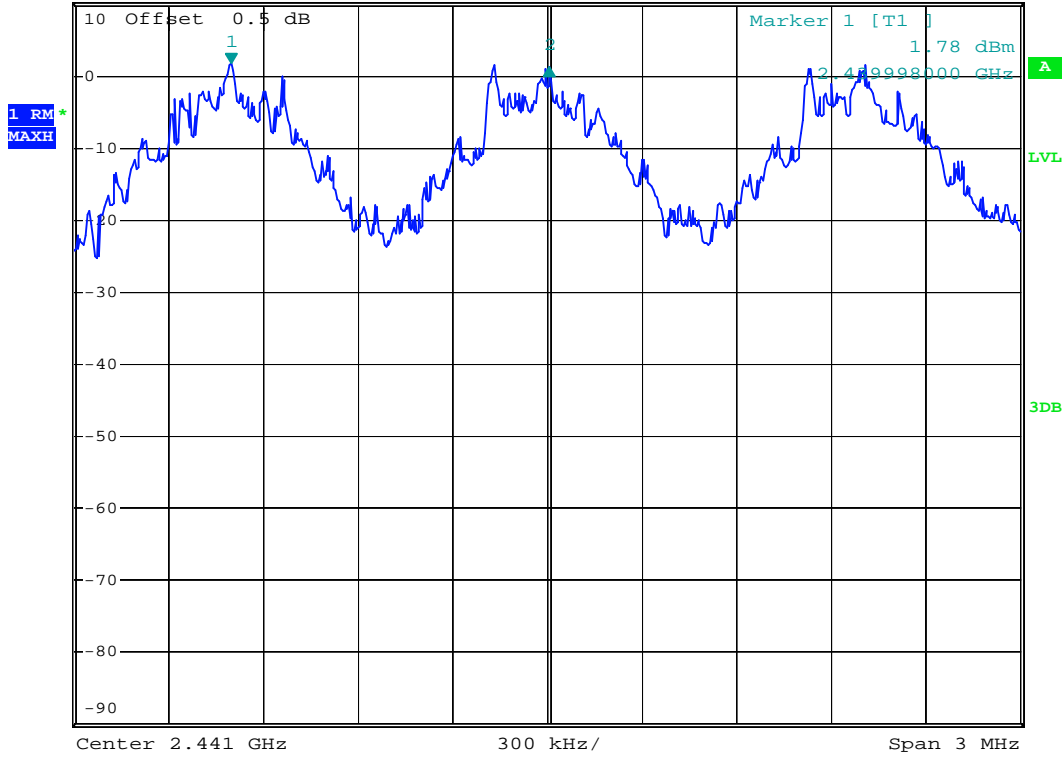



6.4 NUMBER OF HOPPING CHANNELS

6.4.1 LIMIT SUB CLAUSE § 15.247 (a) (1) (iii)

NUMBER OF CHANNELS
> 15

6.4.2 RESULTS:

TEST CONDITIONS		NUMBER OF CHANNELS
T_{nom}(23)°C	V_{nom}VDC	79

PLOT 1



*RBW 300 kHz Marker 1 [T1]
*VBW 300 kHz -46.57 dBm
SWT 2.5 ms 2.400000000 GHz

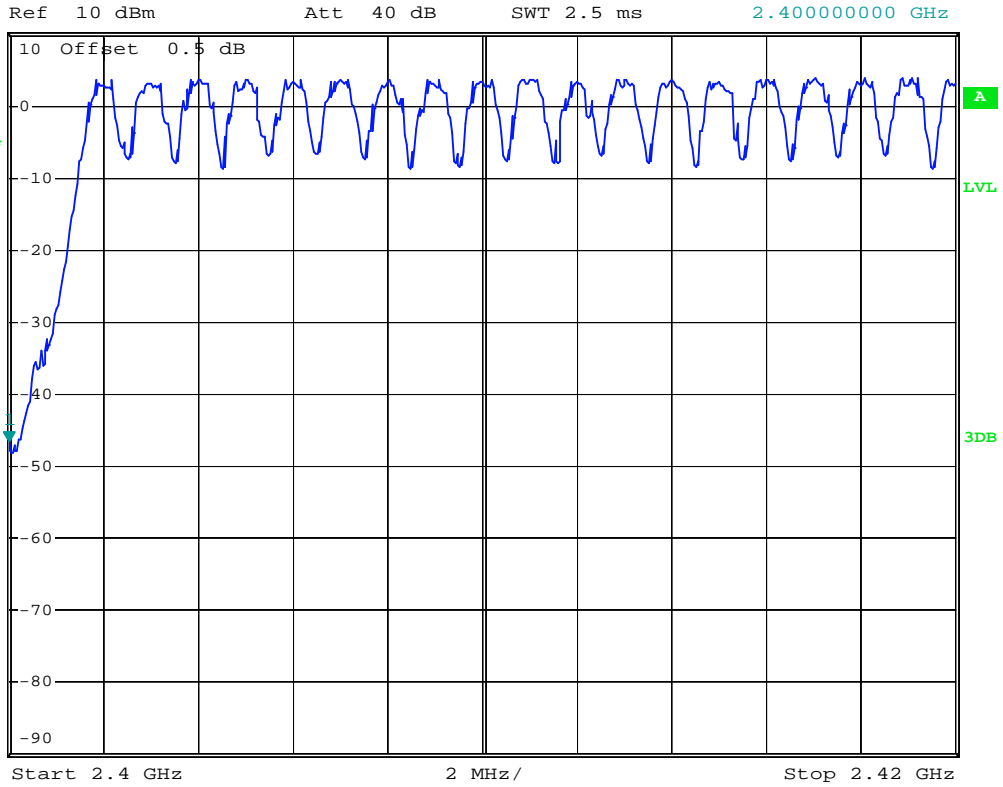

PLOT 2

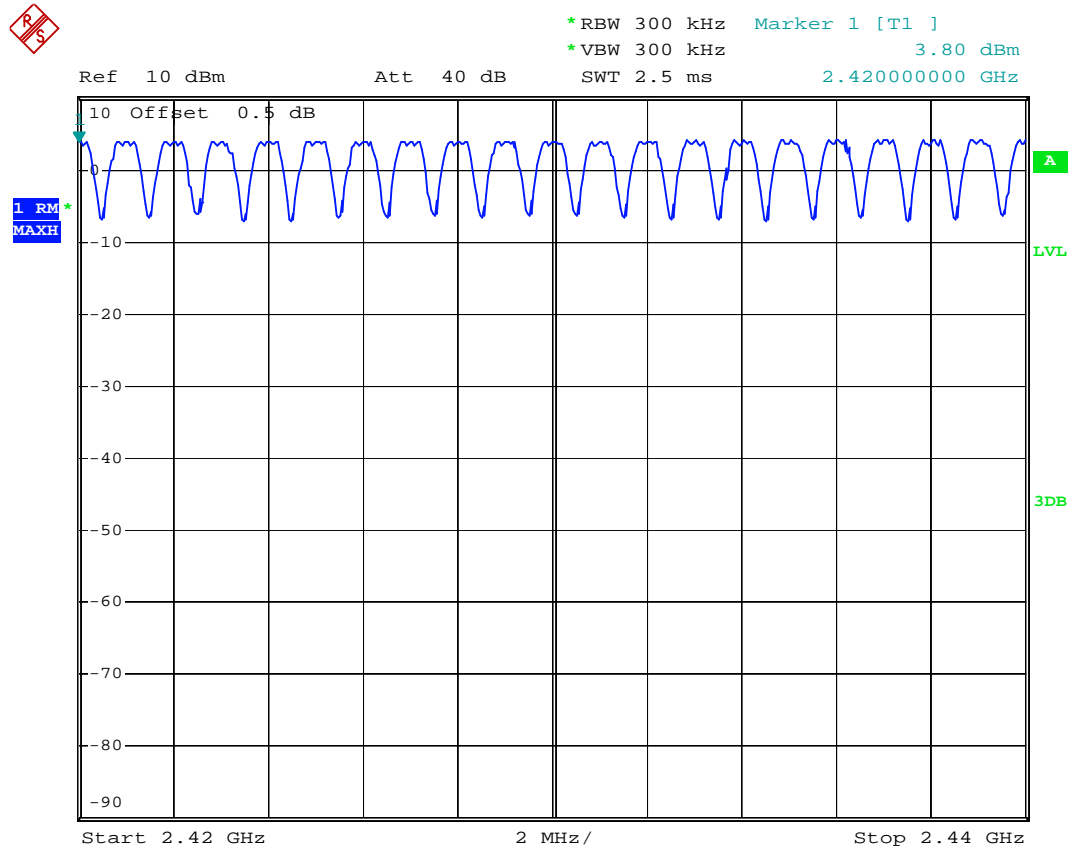

Date: 14.NOV.2007 20:04:50



PLOT 3



*RBW 300 kHz
*VBW 300 kHz
SWT 2.5 ms

Ref 10 dBm

Att 40 dB

1. RM
MAXH

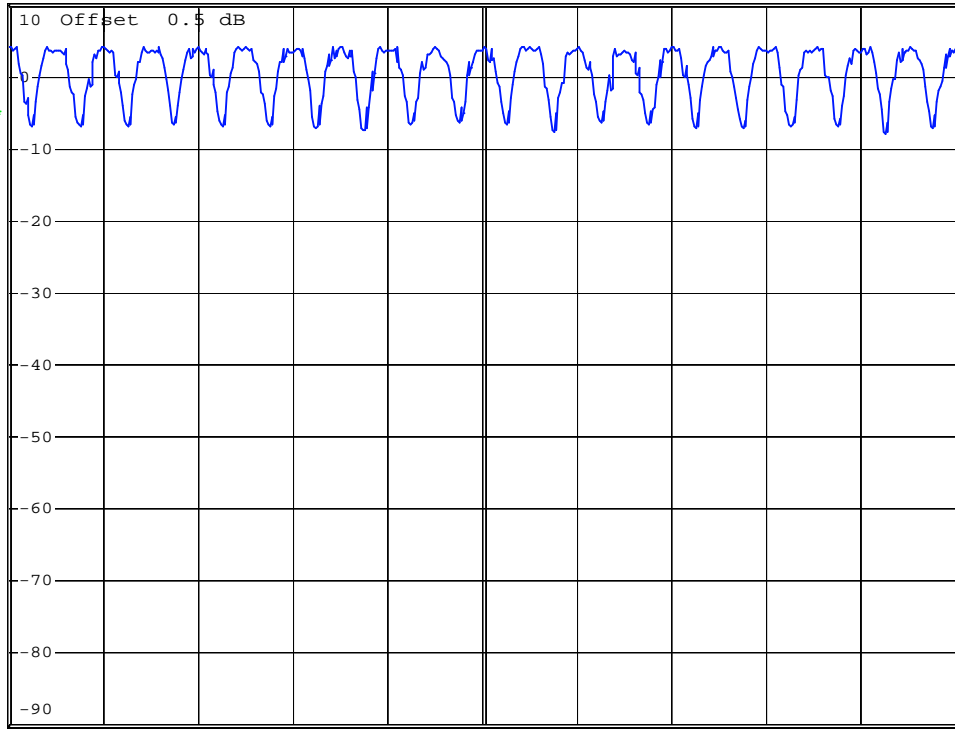

Start 2.44 GHz

2 MHz/

Stop 2.46 GHz

Date: 14.NOV.2007 20:07:08

PLOT 4



*RBW 300 kHz
*VBW 300 kHz
SWT 2.5 ms

Ref 10 dBm

Att 40 dB

1. RM
MAXH

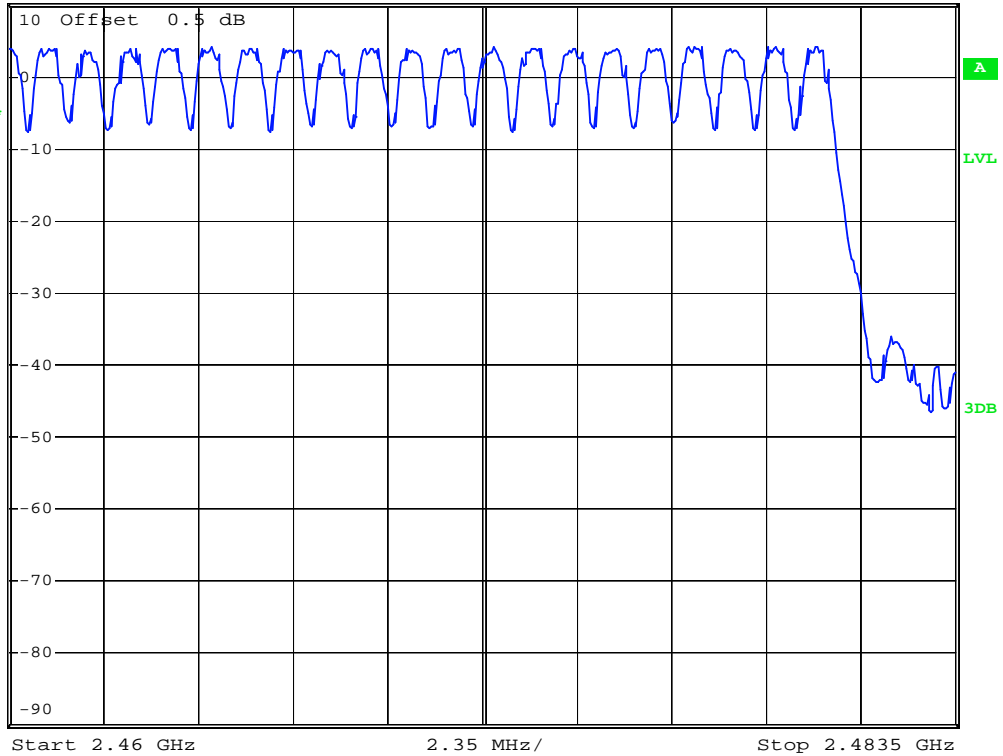

Date: 14.NOV.2007 20:08:52

6.5 TIME OF OCCUPANCY (DWELL TIME)

6.5.1 LIMIT SUB CLAUSE § 15.247 (a) (1) (i) (ii) (iii)

FREQUENCY RANGE	AVERAGE TIME OF OCCUPANCY PER 31.6 SECONDS (LIMIT)
2400-2483.5	< 0.4 Seconds

6.5.2 RESULTS:

$T_{nom}(23)^{\circ}C$	$V_{nom}VDC$
------------------------	--------------

For Bluetooth devices:

The dwell time of 0.4 s within a 31.6 second period in data mode is independent from the packet type (packet length). The calculation for a 31.6 second period is as follows:

Dwell time = time slot length * hop rate / number of hopping channels * 31.6 s

Example for a DH1 packet (with a maximum length of one time slot)

Dwell time = $625 \mu s * 1600 \text{ 1/s} / 79 * 31.6 \text{ s} = 0.4 \text{ s}$ (in a 31.6 s period)

For multi-slot packet the hopping is reduced according to the length of the packet.

Example for a DH5 packet (with a maximum length of five time slots)

Dwell time = $5 * 625 \mu s * 1600 * 1/5 * 1/s / 79 * 31.6 \text{ s} = 0.4 \text{ s}$ (in a 31.6 s period)

This is the same for all BT devices and therefore all BT devices satisfy FCC requirement on time of occupancy (dwell time).

6.6 CONDUCTED SPURIOUS EMISSION

6.6.1 LIMIT SUB CLAUSE § 15.247 (d)

FREQUENCY RANGE	limit
30M-25GHz	-20dBc

6.6.2 RESULTS: Tnom(23)°C VnomVDC

(2402MHz)



Marker 1 [T1]
RBW 100 kHz
RF Att 10 dB
Ref Lvl -52.75 dBm
VBW 300 kHz
-19.5 dBm
2.38188377 GHz
SWT 6.4 s
Unit dBm



Date: 20.NOV.2007 08:24:24

(2441MHz)

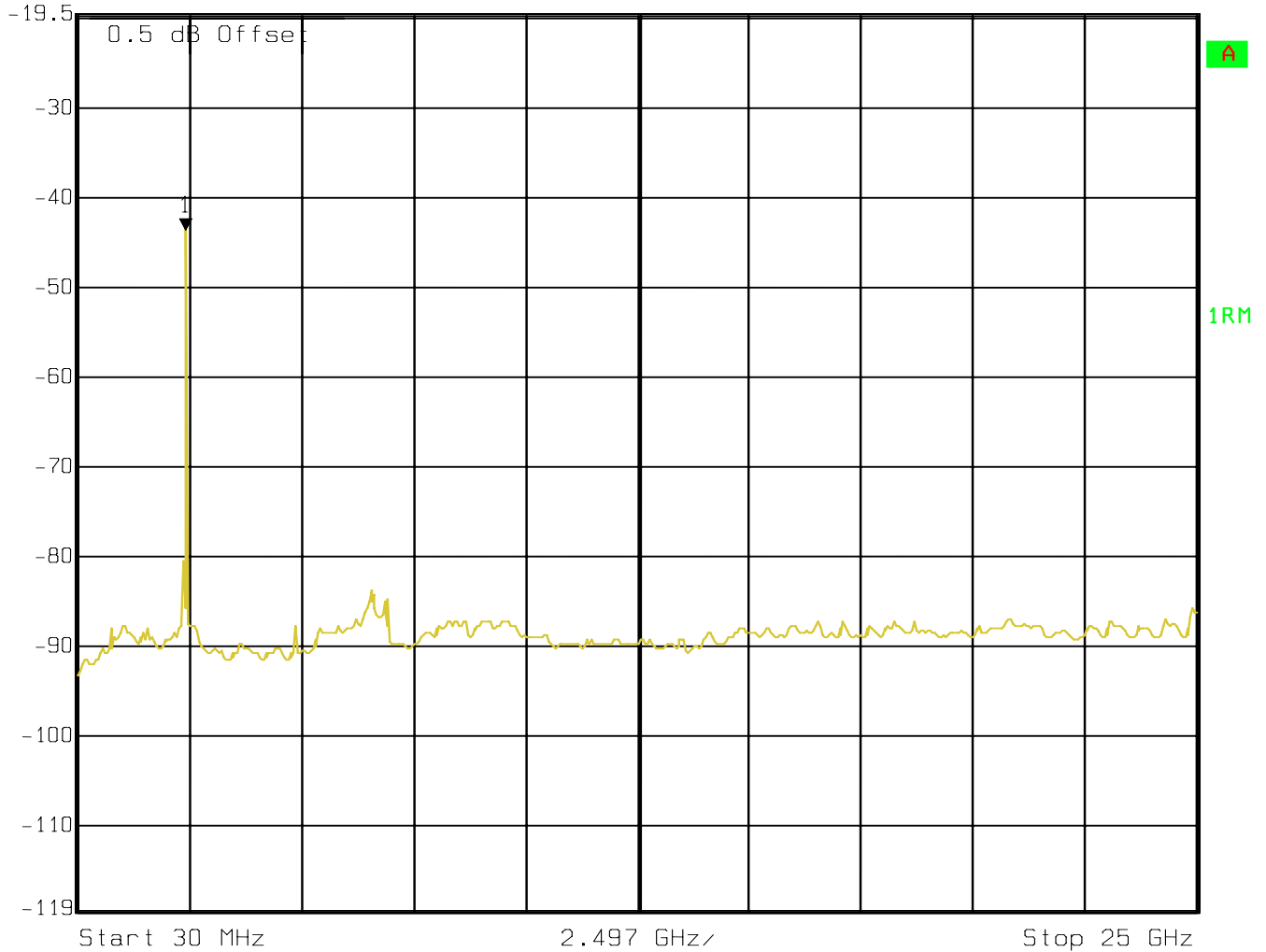
 Marker 1 [T1] RBW 100 kHz RF Att 10 dB
Ref Lvl -43.56 dBm VBW 300 kHz
-19.5 dBm 2.43192385 GHz SWT 6.4 s Unit dBm



Date: 20.NOV.2007 08:24:58

(2480MHz)

 Marker 1 [T1] RBW 100 kHz RF Att 10 dB
Ref Lvl -37.09 dBm VBW 300 kHz
-19.5 dBm 2.48196393 GHz SWT 6.4 s Unit dBm

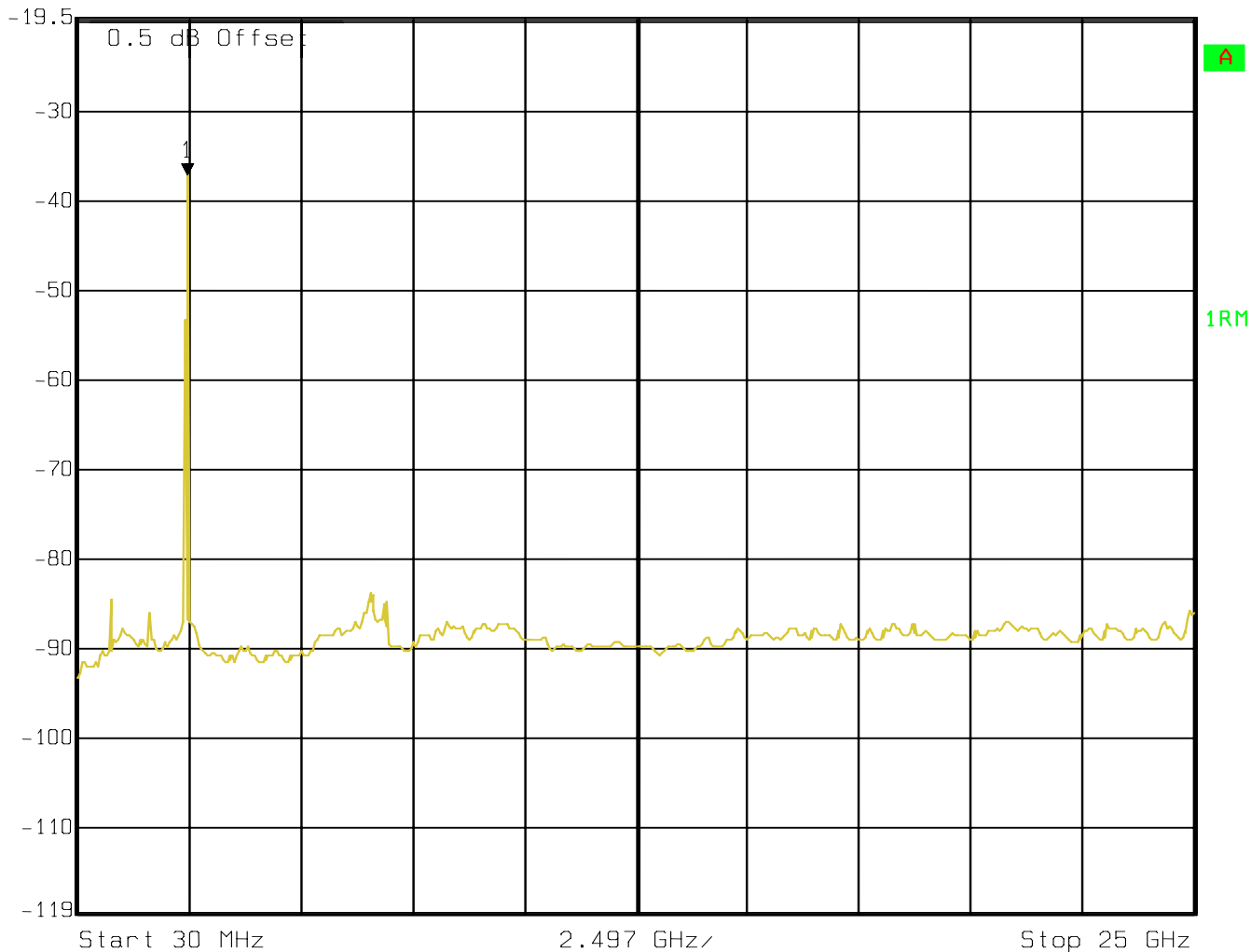

Date: 20.NOV.2007 08:25:34

6.7 AC POWER LINE CONDUCTED EMISSIONS § 15.107/207

6.7.1 Limits

Technical specification: 15.107 / 15.207 (Revised as of August 20, 2002)

§15.107 (a) Except for Class A digital devices, for equipment that is designed to be connected to the public utility (AC) power line, the radio frequency voltage that is conducted back onto the AC power line on any frequency or frequencies within the band 150 kHz to 30 MHz shall not exceed the limits in the following table, as measured using a 50 µH/50 ohms line impedance stabilization network (LISN). Compliance with the provisions of this paragraph shall be based on the measurement of the radio frequency voltage between each power line and ground at the power terminal. The lower limit applies at the boundary between the frequency ranges.

Limit

Frequency of Emission (MHz)	Conducted Limit (dBµV)	
	Quasi-Peak	Average
0.15 – 0.5	66 to 56*	56 to 46*
0.5 – 5	56	46
5 – 30	60	50

* Decreases with logarithm of the frequency

ANALYZER SETTINGS: RBW = 10KHz

VBW = 10KHz

6.7.2 Results, TX Transmit Line:

EUT: HC25
 Manufacturer: PSION
 Operating Condition: GSM 850 Ch 190; WLAN CH 11; BT 2480MHz
 ANT Orientation:: Conducted
 EUT Orientation:: H
 Test Engineer:: Marc
 Power Supply: : AC Adapter
 Comments: : Line

Marker: 150 kHz 66 dBμV

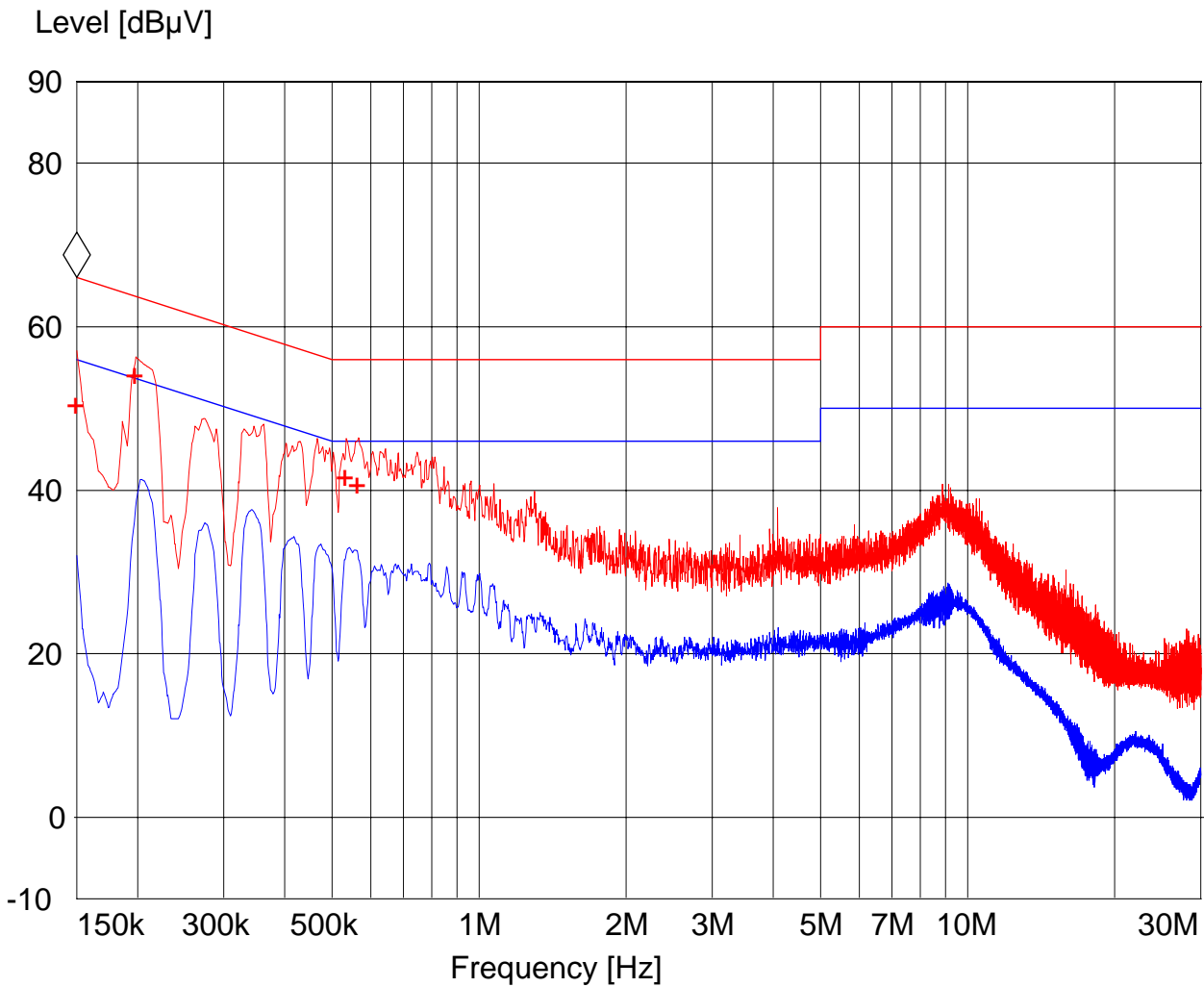

- + MES 55022 V AV QPk
- MES 55022 cond MaxPk
- MES 55022 cond Avg
- LIM EN 55022 V QP Voltage QP Limit
- LIM EN 55022 V AV Voltage AV Limit



MEASUREMENT RESULT: "55022 V AV QPk"

11/26/2007 10:57AM

Frequency MHz	Level dBµV	Transd dB	Limit dBµV	Margin dB	Line	PE
0.150000	50.60	0.0	66	15.4	---	---
0.198000	54.30	0.0	64	9.4	---	---
0.534000	41.70	0.0	56	14.3	---	---
0.566000	40.90	0.0	56	15.1	---	---

LIMIT LINE: "EN 55022 V AV"

Short Description: Voltage AV Limit
4/27/1998 2:24PM

Frequency MHz	Level dBµV
0.150000	56.00
0.500000	46.00
5.000000	46.00
5.000000	50.00
30.000000	50.00

LIMIT LINE: "EN 55022 V QP"

Short Description: Voltage QP Limit
4/27/1998 2:24PM

Frequency MHz	Level dBµV
0.150000	66.00
0.500000	56.00
5.000000	56.00
5.000000	60.00
30.000000	60.00

6.7.3 TX Transmit Neutral:

EUT: HC25
 Manufacturer: PSION
 Operating Condition: GSM 850 Ch 190; WLAN CH 11; BT 2480MHz
 ANT Orientation: Conducted
 EUT Orientation: H
 Test Engineer: Marc
 Power Supply: AC Adapter
 Comments: N

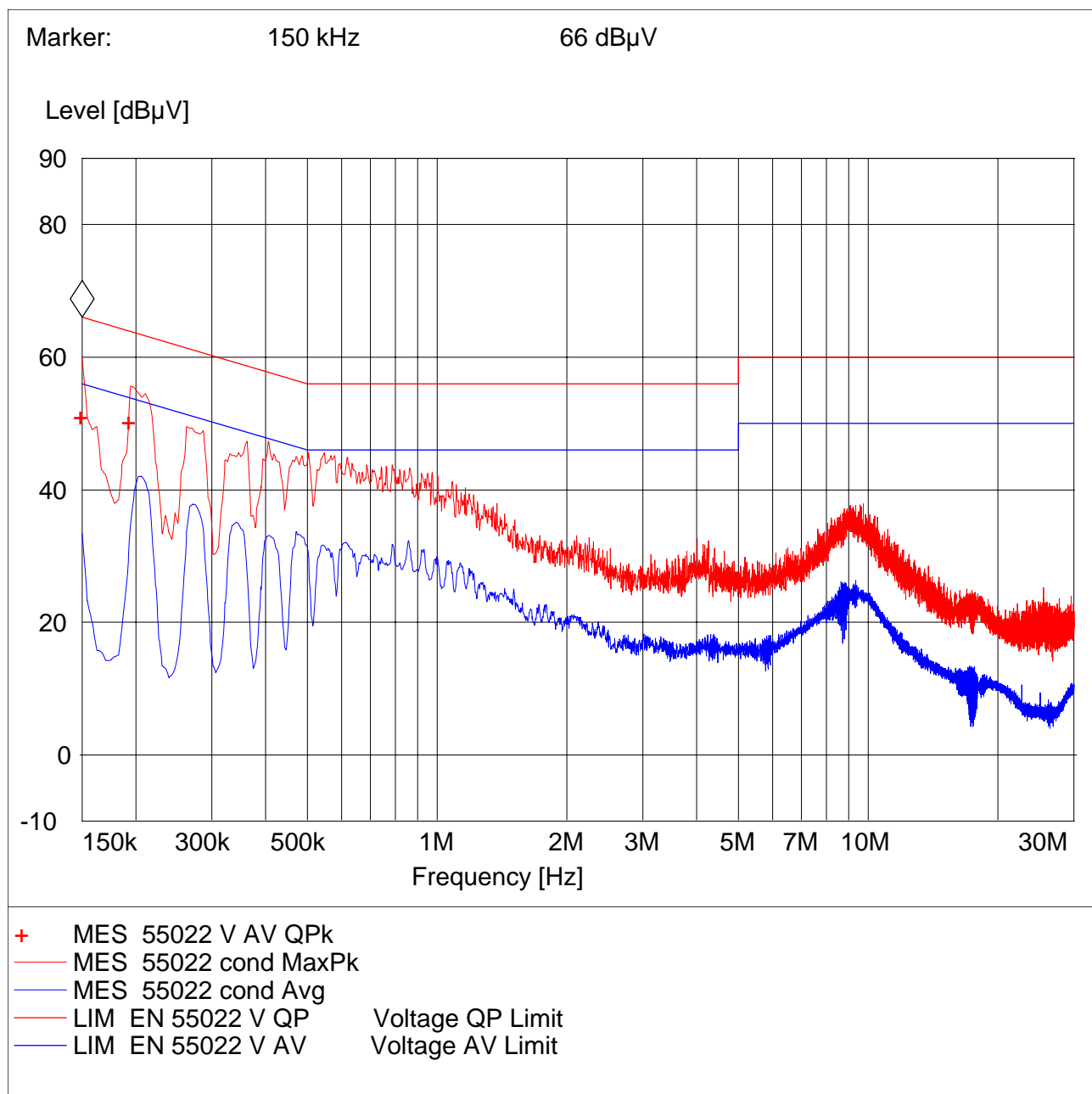



MEASUREMENT RESULT: "55022 V AV QPk"

11/26/2007 10:50AM

Frequency MHz	Level dBµV	Transd dB	Limit dBµV	Margin dB	Line	PE
0.150000	51.10	0.0	66	14.9	---	---
0.194000	50.30	0.0	64	13.5	---	---

LIMIT LINE: "EN 55022 V AV"

Short Description: Voltage AV Limit
4/27/1998 2:24PM

Frequency MHz	Level dBµV
0.150000	56.00
0.500000	46.00
5.000000	46.00
5.000000	50.00
30.000000	50.00

LIMIT LINE: "EN 55022 V QP"

Short Description: Voltage QP Limit
4/27/1998 2:24PM

Frequency MHz	Level dBµV
0.150000	66.00
0.500000	56.00
5.000000	56.00
5.000000	60.00
30.000000	60.00

6.7.4 Results, Idle Line:

EUT: 7505
Manufacturer: PSION
Operating Condition: IDLE
ANT Orientation:: Conducted
EUT Orientation:: H
Test Engineer:: Marc
Power Supply: : AC Adapter
Comments: : line; idle

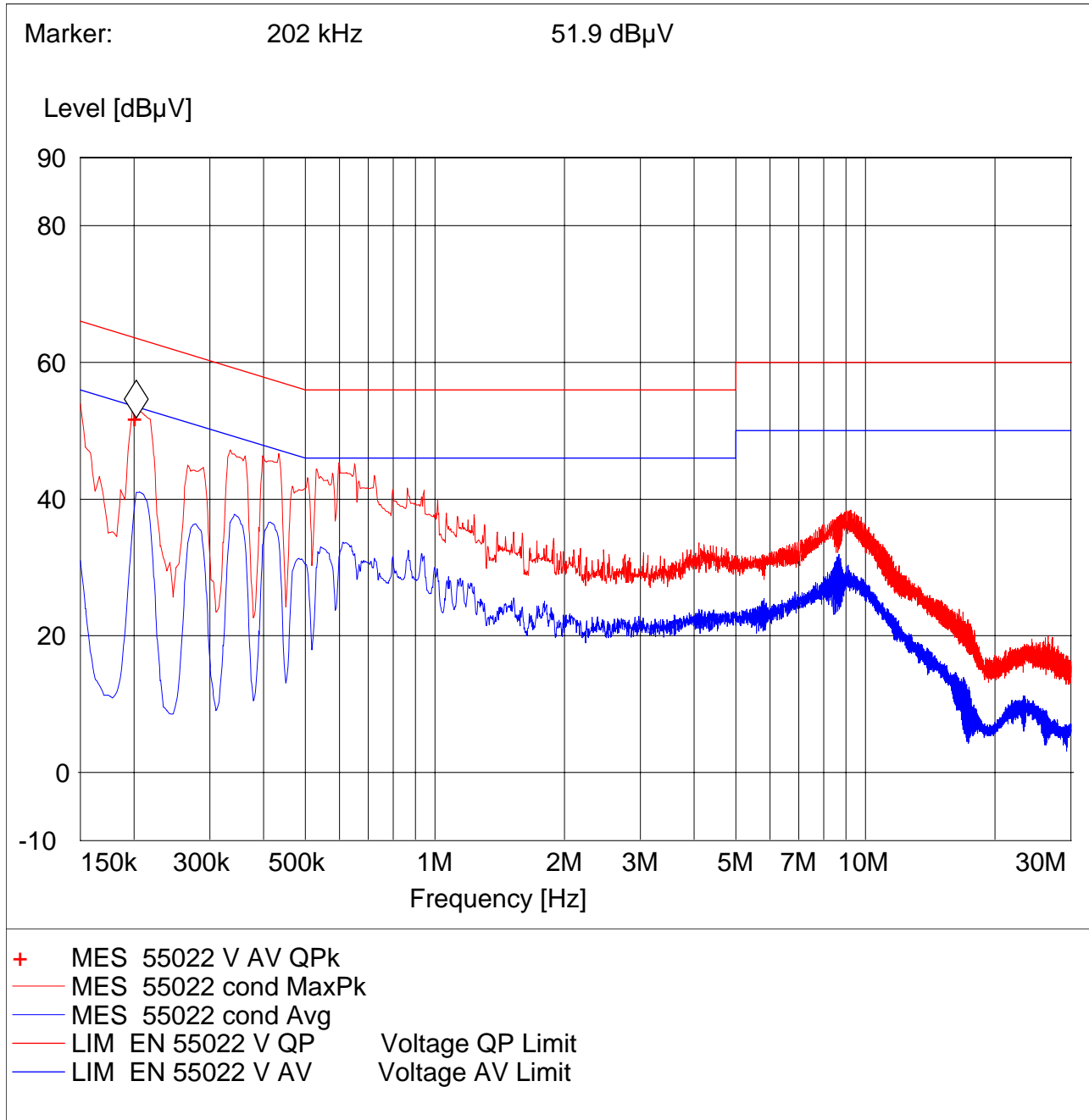



MEASUREMENT RESULT: "55022 V AV QPk"

11/26/2007 12:32PM

Frequency MHz	Level dBµV	Transd dB	Limit dBµV	Margin dB	Line	PE
0.202000	51.90	0.0	64	11.6	---	---

LIMIT LINE: "EN 55022 V AV"

Short Description: Voltage AV Limit
4/27/1998 2:24PM

Frequency MHz	Level dBµV
0.150000	56.00
0.500000	46.00
5.000000	46.00
5.000000	50.00
30.000000	50.00

LIMIT LINE: "EN 55022 V QP"

Short Description: Voltage QP Limit
4/27/1998 2:24PM

Frequency MHz	Level dBµV
0.150000	66.00
0.500000	56.00
5.000000	56.00
5.000000	60.00
30.000000	60.00

6.7.5 TX Idle Neutral:

EUT: 7505
Manufacturer: PSION
Operating Condition: IDLE
ANT Orientation:: Conducted
EUT Orientation:: H
Test Engineer:: Marc
Power Supply: : AC Adapter
Comments: : neutral; idle

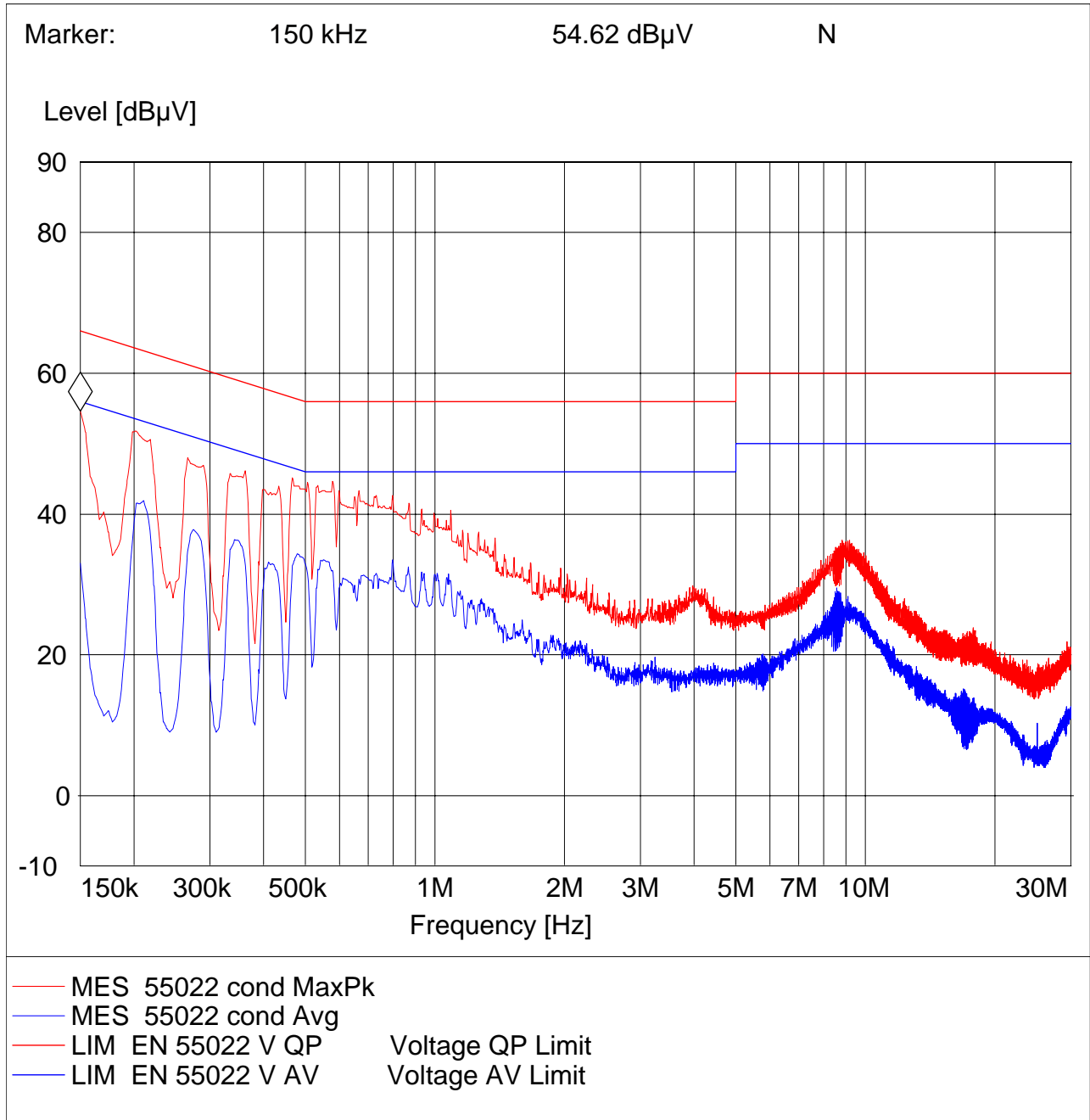

Test Report #: EMC_PSION_001_07502_15.247BT_GM37505BTS
DCMMC75

Date of Report : 2007-12-3

Page 59 of 62



LIMIT LINE: "EN 55022 V AV"

Short Description:		Voltage AV Limit
4/27/1998 2:24PM		
Frequency	Level	
MHz	dBuV	
0.150000	56.00	
0.500000	46.00	
5.000000	46.00	
5.000000	50.00	
30.000000	50.00	

LIMIT LINE: "EN 55022 V QP"

Short Description:		Voltage QP Limit
4/27/1998 2:24PM		
Frequency	Level	
MHz	dBuV	
0.150000	66.00	
0.500000	56.00	
5.000000	56.00	
5.000000	60.00	
30.000000	60.00	

7 TEST EQUIPMENT AND ANCILLARIES USED FOR TESTS

No	Instrument/Ancillary	Type	Manufacturer	Serial No.	Cal Due	Interval
01	Spectrum Analyzer	ESIB 40	Rohde & Schwarz	100107	May 2008	1 year
02	Spectrum Analyzer	FSEM 30	Rohde & Schwarz	100017	August 2008	1 year
03	Signal Generator	SMY02	Rohde & Schwarz	836878/011	May 2008	1 year
04	Power-Meter	NRVD	Rohde & Schwarz	0857.8008.02	May 2008	1 year
05	Biconilog Antenna	3141	EMCO	0005-1186	June 2008	1 year
06	Horn Antenna (1-18GHz)	SAS-200/571	AH Systems	325	June 2008	1 year
07	Horn Antenna (18-26.5GHz)	3160-09	EMCO	1240	June 2008	1 year
08	Power Splitter	11667B	Hewlett Packard	645348	n/a	n/a
09	Climatic Chamber	VT4004	Voltsch	G1115	May 2008	1 year
10	High Pass Filter	5HC2700	Trilithic Inc.	9926013	n/a	n/a
11	High Pass Filter	4HC1600	Trilithic Inc.	9922307	n/a	n/a
12	Pre-Amplifier	JS4-00102600	Miteq	00616	May 2008	1 year
13	Power Sensor	URV5-Z2	Rohde & Schwarz	DE30807	May 2008	1 year
14	Digital Radio Comm. Tester	CMD-55	Rohde & Schwarz	847958/008	May 2008	1 year
15	Universal Radio Comm. Tester	CMU 200	Rohde & Schwarz	832221/06	May 2008	1 year
16	LISN	ESH3-Z5	Rohde & Schwarz	836679/003	May 2008	1 year
17	Loop Antenna	6512	EMCO	00049838	July 2008	2 years

8 BLOCK DIAGRAMS

Conducted Testing

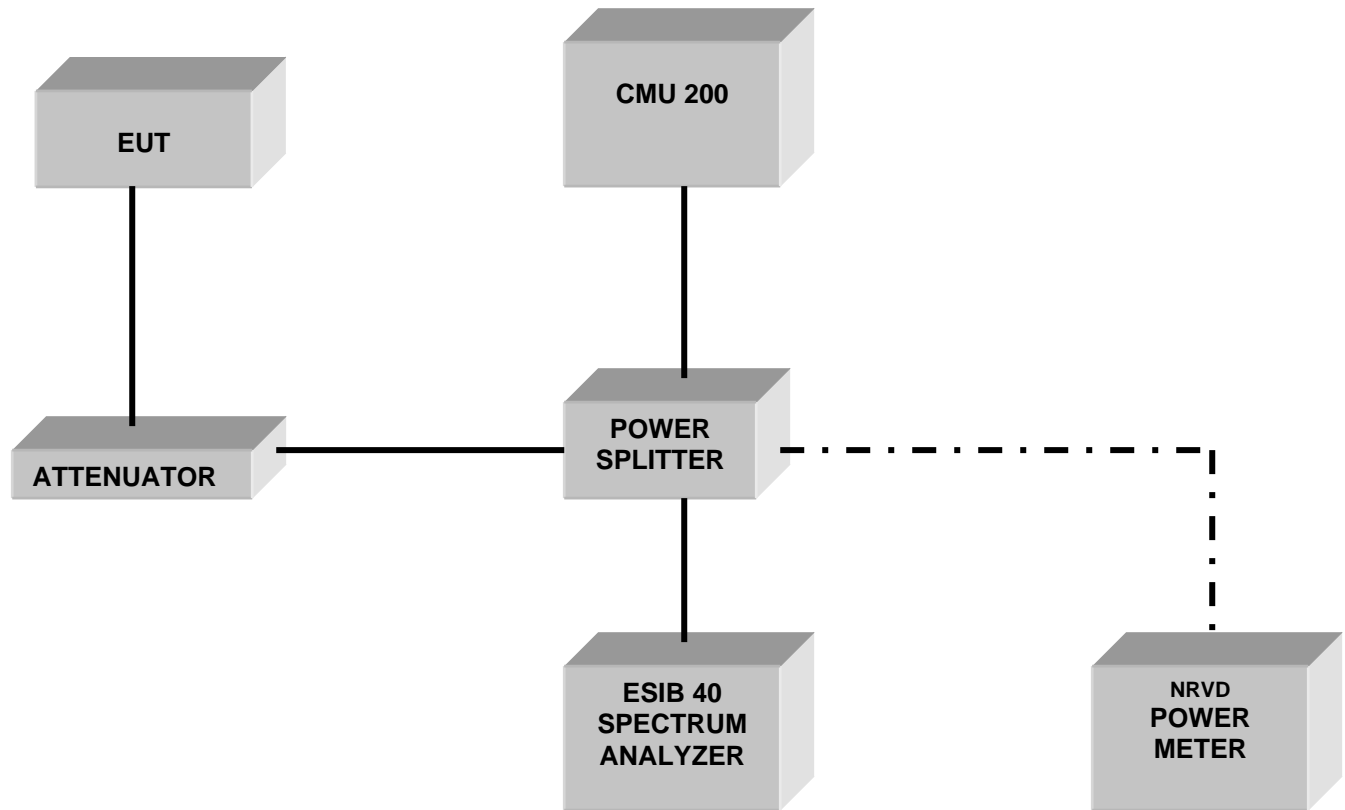

Radiated Testing

ANECHOIC CHAMBER

