



SAR Evaluation Report

in accordance with the requirements of
FCC Report and Order: ET Docket 93-62, and OET Bulletin 65 Supplement C

For

Compal Electronics Inc.

Wireless LAN module built in Notebook PC

Model No.: CL32

FCC ID: GKRWM3BAB32

Trade Name: acer / Compal

Prepared for

**Compal Electronics Inc.
581, Juikuang Rd., Neihu,
Taipei, Taiwan, R.O.C.**

Prepared by

**Compliance Certification Services Inc.
No. 81-1, Lane 210, Bade Rd. 2, Luchu Hsiang,
Taoyuan Hsien, (338) Taiwan, R.O.C.
TEL: 886-3-324-0332
FAX: 886-3-324-5235**



Note: This report shall not be reproduced except in full, without the written approval of Compliance Certification Services Inc. This document may be altered or revised by Compliance Certification Services Inc. personnel only, and shall be noted in the revision section of the document.



TABLE OF CONTENTS

1. TEST RESULT CERTIFICATION.....	3
2. EUT DESCRIPTION.....	4
3. REQUIREMENTS FOR COMPLIANCE TESTING DEFINED BY THE FCC.....	5
4. DOSIMETRIC ASSESSMENT SYSTEM	6
4.1 MEASUREMENT SYSTEM DIAGRAM.....	7
4.2 SYSTEM COMPONENTS	8
5. EVALUATION PROCEDURE	10
5.1 DATA EVALUATION	10
5.2 SAR EVALUATION PROCEDURE.....	12
6. MEASUREMENT UNCERTAINTY	13
7. EXPOSURE LIMIT.....	14
8. MEASUREMENT RESULTS	15
8.1 SYSTEM VALIDATION.....	15
8.2 TEST LIQUID CONFIRMATION	16
8.3 EUT SETUP PHOTOS.....	19
8.4 SAR MEASUREMENT RESULT	20
9. EUT PHOTOS.....	21
10. EQUIPMENT LIST & CALIBRATION.....	22
11. REFERENCES.....	23
12. ATTACHMENT	24



1. TEST RESULT CERTIFICATION

Applicant: COMPAL ELECTRONICS, INC.
581, Juikuang Rd., Neihu,
Taipei, Taiwan, R.O.C.

Equipment Under Test: Wireless LAN module built in Notebook PC

Trade Name: acer / Compal

Model No.: CL32

FCC ID GKRWM3BAB32

Device Category: PORTABLE DEVICES

Exposure Category: GENERAL POPULATION/UNCONTROLLED EXPOSURE

Report Number: B30827206-SAR-FCC

Date of Test: Sep 06, 2003

Test Sample is a: Wireless LAN module built in Notebook PC

Modulation Type: Direct Sequence Spread Spectrum

Operating Mode: Maximum continuous output

Tx Frequency: 2412 ~ 2462 MHz

Max. O/P Power: 16.3dBm (2412 MHz)
(Conducted)

Max. SAR (1g): 0.0631mW/g (2462MHz)

Application Type: Certification

FCC Rule part(s): § 15.247



This wireless portable device has been shown to be capable of compliance for localized specific absorption rate (SAR) for uncontrolled environment/general population exposure limits specified in ANSI/IEEE Std. C95.1-1999 and had been tested in accordance with the measurement procedures specified in FCC OET 65 Supplement C (released on 6/29/2001 - see Test Report).

I attest to accuracy of the data. All measurements reported herein were performed by me or were made under my supervision and are correct to the best of my knowledge and belief. I assume full responsibility for completeness of these measurements and vouch for the qualifications of all persons taking them.

Approved by:

Reviewed by:

Jonson Lee / Director
Compliance Certification Services Inc.

Miro Chueh / Section Manager
Compliance Certification Services Inc.



2. EUT DESCRIPTION

Applicant:	COMPAL ELECTRONICS, INC. 581, Juikuang Rd., Neihu, Taipei, Taiwan, R.O.C.
Equipment Under Test:	Wireless LAN module built in Notebook PC
Trade Name:	acer / Compal
Model:	CL32
FCC ID	GKRWM3BAB32
Device Category:	PORTABLE DEVICES
Exposure Category:	GENERAL POPULATION/UNCONTROLLED EXPOSURE
Report Number:	B30827206-SAR-FCC
Date of Test:	Sep 06; 2003

Test Sample is a:	Wireless LAN module built in Notebook PC
Modulation Type:	Direct Sequence Spread Spectrum
Operating Mode:	Maximum continuous output
Tx Frequency:	2412 ~ 2462 MHz
Max. O/P Power: (Conducted)	16.3dBm (2412MHz)
Max. SAR (1g):	0.0631mW/g (2462MHz)
Application Type:	Certification
FCC Rule part(s):	§ 15.247



Notes:

1. *Specific Absorption Rate (SAR) is a measure of the rate of energy absorption due to exposure to an RF transmitting source (wireless portable device).*
2. *IEEE/ANSI Std. C95.1-1999 limits are used to determine compliance with FCC ET Docket 93-62*



3. REQUIREMENTS FOR COMPLIANCE TESTING DEFINED BY THE FCC

The US Federal Communications Commission has released the report and order "Guidelines for Evaluating the Environmental Effects of RF Radiation", ET Docket No. 93-62 in August 1996 [1]. The order requires routine SAR evaluation prior to equipment authorization of portable transmitter devices, including portable telephones. For consumer products, the applicable limit is 1.6 mW/g for an uncontrolled environment and 8.0 mW/g for an occupational/controlled environment as recommended by the ANSI/IEEE standard C95.1-1999 [6]. According to the Supplement C of OET Bulletin 65 "Evaluating Compliance with FCC Guide-lines for Human Exposure to Radio frequency Electromagnetic Fields," released on Jun 29, 2001 by FCC, the device should be evaluated at maximum output power (radiated from the antenna) under "worst-case" conditions for normal or intended use, incorporating normal antenna operating positions, device peak performance frequencies and positions for maximum RF energy coupling.



4. DOSIMETRIC ASSESSMENT SYSTEM

These measurements were performed with the automated near-field scanning system DASY4 from Schmid & Partner Engineering AG (SPEAG). The system is based on a high precision robot (working range greater than 0.9 m) which positions the probes with a positional repeatability of better than ± 0.02 mm. Special E- and H-field probes have been developed for measurements close to material discontinuity, the sensors of which are directly loaded with a Schottky diode and connected via highly resistive lines to the data acquisition unit. The SAR measurements were conducted with the dosimetric probe ET3DV6 SN: 1762 (manufactured by SPEAG), designed in the classical triangular configuration [3] and optimized for dosimetric evaluation. The probe has been calibrated according to the procedure described in [7] with accuracy of better than $\pm 10\%$. The spherical isotropy was evaluated with the procedure described in [8] and found to be better than ± 0.25 dB. The phantom used was the SAM Twin Phantom as described in FCC supplement C, IEEE P1528 and EN50361.

The Tissue simulation liquid used for each test is in accordance with FCC OET65 supplement C as listed below.

Ingredients (%, by weight)	Frequency (MHz)									
	450		835		915		1900		2450	
Tissue Type	Head	Body	Head	Body	Head	Body	Head	Body	Head	Body
Water	38.56	51.16	41.45	52.4	41.05	56.0	54.9	40.4	62.7	73.2
Salt (NaCl)	3.95	1.49	1.45	1.4	1.35	0.76	0.18	0.5	0.5	0.04
Sugar	56.32	46.78	56.0	45.0	56.5	41.76	0.0	58.0	0.0	0.0
HEC	0.98	0.52	1.0	1.0	1.0	1.21	0.0	1.0	0.0	0.0
Bactericide	0.19	0.05	0.1	0.1	0.1	0.27	0.0	0.1	0.0	0.0
Triton X-100	0.0	0.0	0.0	0.0	0.0	0.0	0.0	0.0	36.8	0.0
DGBE	0.0	0.0	0.0	0.0	0.0	0.0	44.92	0.0	0.0	26.7
Dielectric Constant	43.42	58.0	42.54	56.1	42.0	56.8	39.9	54.0	39.8	52.5
Conductivity (S/m)	0.85	0.83	0.91	0.95	1.0	1.07	1.42	1.45	1.88	1.78

4.1 MEASUREMENT SYSTEM DIAGRAM

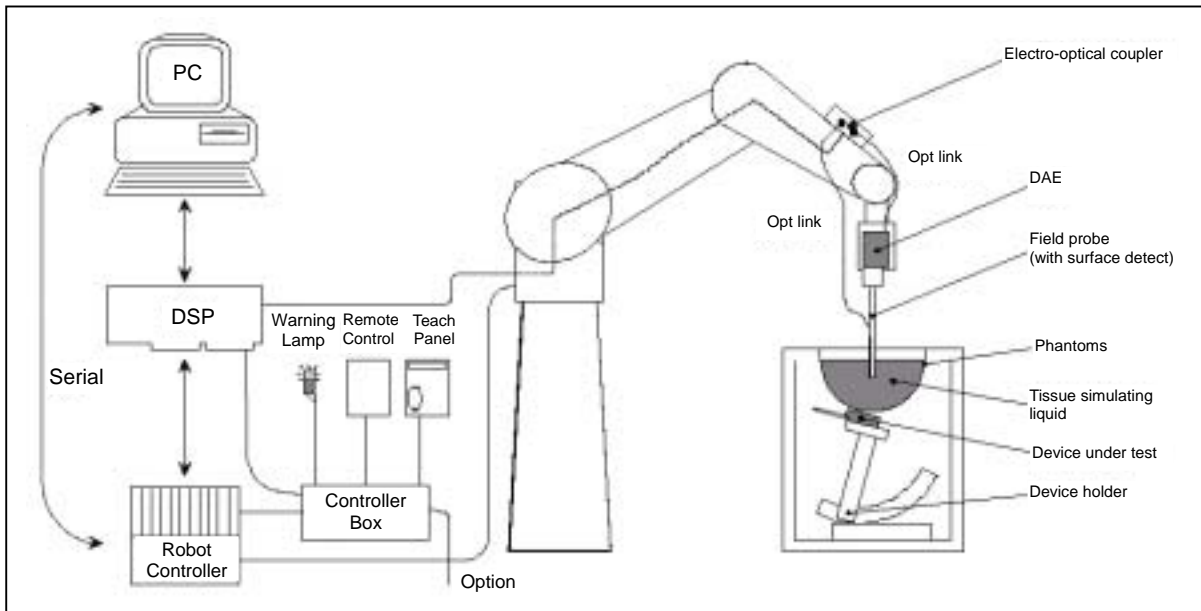

The DASY4 system for performing compliance tests consist of the following items:

1. A standard high precision 6-axis robot (Stäubli RX family) with controller and software.
2. An arm extension for accommodating the data acquisition electronics (DAE).
3. A dosimetric probe, i.e., an isotropic E-field probe optimized and calibrated for usage in tissue simulating liquid. The probe is equipped with an optical surface detector system.
4. A data acquisition electronic (DAE), which performs the signal amplification, signal multiplexing, AD-conversion, offset measurements, mechanical surface detection, collision detection, etc. The unit is battery powered with standard or rechargeable batteries. The signal is optically transmitted to the EOC.
5. A unit to operate the optical surface detector, which is connected to the EOC.
6. The Electro-optical coupler (EOC) performs the conversion from the optical into a digital electric signal of the DAE. The EOC is connected to the PC plug-in card.
7. The functions of the PC plug-in card based on a DSP is to perform the time critical task such as signal filtering, surveillance of the robot operation fast movement interrupts.
8. A computer operating Windows 95 or larger
9. DASY4 software
10. Remote control with teaches pendant and additional circuitry for robot safety such as warning lamps, etc.
11. The SAM phantom enabling testing left-hand and right-hand usage.
12. The device holder for handheld EUT.
13. Tissue simulating liquid mixed according to the given recipes (see Application Note).
14. System validation dipoles to validate the proper functioning of the system.

4.2 SYSTEM COMPONENTS

ET3DV5 Probe Specification

Construction Symmetrical design with triangular core

Built-in optical fiber for surface detection System

Built-in shielding against static charges

Calibration in air from 10 MHz to 2.5 GHz

In brain and muscle simulating tissue at frequencies of 450 MHz, 900 MHz and 1.8 GHz (accuracy of $\pm 8\%$)

Frequency 10 MHz to > 6 GHz; Linearity: ± 0.2 dB (30 MHz to 3 GHz)

Directivity ± 0.2 dB in brain tissue (rotation around probe axis)

± 0.4 dB in brain tissue (rotation normal probe axis)

Dynamic 5 mW/g to > 100 mW/g;

Range Linearity: ± 0.2 dB

Surface ± 0.2 mm repeatability in air and clear liquids

Detection over diffuse reflecting surfaces

Dimensions Overall length: 330 mm

Tip length: 16 mm

Body diameter: 12 mm

Tip diameter: 6.8 mm

Distance from probe tip to dipole centers: 2.7 mm

Application General dosimetric up to 3 GHz

Compliance tests of mobile phones

Fast automatic scanning in arbitrary phantoms

The SAR measurements were conducted with the dosimetric probe ET3DV6 designed in the classical triangular configuration and optimized for dosimetric evaluation. The probe is constructed using the thick film technique, with printed resistive lines on ceramic substrates. The probe is equipped with an optical multi-fiber line ending at the front of the probe tip. It is connected to the EOC box on the robot arm and provides an automatic detection of the phantom surface. Half of the fibers are connected to a pulsed infrared transmitter, the other half to a synchronized receiver. As the probe approaches the surface, the reflection from the surface produces a coupling from the transmitting to the receiving fibers. This reflection increases first during the approach, reaches maximum and then decreases. If the probe is flatly touching the surface, the coupling is zero. The distance of the coupling maximum to the surface is independent of the surface reflectivity and largely independent of the surface to probe angle. The DASY4 software reads the reflection during a software approach and looks for the maximum using a 2nd order fitting. The approach is stopped when reaching the maximum.



Photograph of the Probe



**Inside View of
ET3DV6 E-field Probe**

E-Field Probe Calibration Process

Each probe is calibrated according to a dosimetric assessment procedure described in [6] with accuracy better than +/- 10%. The spherical isotropy was evaluated with the procedure described in [7] and found to be better than +/-0.25dB. The sensitivity parameters (NormX, NormY, NormZ), the diode compression parameter (DCP) and the conversion factor (ConvF) of the probe are tested.

The free space E-field from amplified probe outputs is determined in a test chamber. This is performed in a TEM cell for frequencies below 1 GHz, and in a waveguide above 1 GHz for free space. For the free space calibration, the probe is placed in the volumetric center of the cavity and at the proper orientation with the field. The probe is then rotated 360 degrees.

E-field temperature correlation calibration is performed in a flat phantom filled with the appropriate simulated brain tissue. The measured free space E-field in the medium correlates to temperature rise in dielectric medium. For temperature correlation calibration a RF transparent thermistor-based temperature probe is used in conjunction with the E-field probe.

SAM Phantom

The SAM Phantom V4.0 is constructed of a fiberglass shell integrated in a wooden table. The shape of the shell is in compliance with the specification set in IEEE P1528 and CENELEC EN50361. The phantom enables the dosimetric evaluation of left and right hand phone usage as well as body mounted usage at the flat phantom region. A cover prevents the evaporation of the liquid. Reference markings on the Phantom allow the complete setup of all predefined phantom positions and measurement grids by manually teaching three points in the robot.

Shell Thickness: 2 ± 0.2 mm

Filling Volume: Approx. 25 liters

Dimensions (H x L x W): 810 x 1000 x 500 mm



SAM Phantom

Device Holder for Transmitters

In combination with the Generic Twin Phantom V3.0, the Mounting Device enables the rotation of the mounted transmitter in spherical coordinates whereby the rotation points is the ear opening. The devices can be easily, accurately, and repeatedly positioned according to the FCC and CENELEC specifications. The device holder can be locked at different phantom locations (left head, right head, flat phantom).

***Note:** A simulating human hand is not used due to the complex anatomical and geometrical structure of the hand that may produced infinite number of configurations [10]. To produce the worst-case condition (the hand absorbs antenna output power), the hand is omitted during the tests.*



Device Holder



5. EVALUATION PROCEDURE

5.1 DATA EVALUATION

The DASY4 software automatically executes the following procedure to calculate the field units from the microvolt readings at the probe connector. The parameters used in the evaluation are stored in the configuration modules of the software:

Probe parameters:	- Sensitivity	Norm _i , a _{i10} , a _{i11} , a _{i12}
	- Conversion factor	ConvFi
	- Diode compression point	Dcpi
Device parameters:	- Frequency	f
	- Crest factor	cf
Media parameters:	- Conductivity	σ
	- Density	ρ

These parameters must be set correctly in the software. They can either be found in the component documents or be imported into the software from the configuration files issued for the DASY4 components. In the direct measuring mode of the multi-meter option, the parameters of the actual system setup are used. In the scan visualization and export modes, the parameters stored in the corresponding document files are used.

The first step of the evaluation is a linearization of the filtered input signal to account for the compression characteristics of the detector diode. The compensation depends on the input signal, the diode type and the DC-transmission factor from the diode to the evaluation electronics. If the exciting field is pulsed, the crest factor of the signal must be known to correctly compensate for peak power. The formula for each channel can be given as:

$$V_i = U_i + U_i^2 \cdot \frac{cf}{dcp_i}$$

- Where V_i = Compensated signal of channel i ($i = x, y, z$)
- U_i = Input signal of channel i ($i = x, y, z$)
- cf = Crest factor of exciting field (DASY parameter)
- dcp_i = Diode compression point(DASY parameter)

From the compensated input signals the primary field data for each channel can be evaluated:

$$E\text{-field probes: } E_i = \sqrt{\frac{V_i}{Norm_i \cdot ConvF}}$$

$$H\text{-field probes: } H_i = \sqrt{V_i} \cdot \frac{a_{i10} + a_{i11}f + a_{i12}f^2}{f}$$

- Where V_i = Compensated signal of channel i ($i = x, y, z$)
- $Norm_i$ = Sensor sensitivity of channel i ($i = x, y, z$)
 $\mu V/(V/m)^2$ for E0field Probes
- $ConvF$ = Sensitivity enhancement in solution
- a_{ij} = Sensor sensitivity factors for H-field probes
- f = Carrier frequency (GHz)
- E_i = Electric field strength of channel i in V/m
- H_i = Magnetic field strength of channel i in A/m



The RSS value of the field components gives the total field strength (Hermitian magnitude):

$$E_{tot} = \sqrt{E_x^2 + E_y^2 + E_z^2}$$

The primary field data are used to calculate the derived field units.

$$SAR = E_{tot}^2 \cdot \frac{\sigma}{\rho \cdot 1000}$$

- where
- SAR = local specific absorption rate in mW/g
 - E_{tot} = total field strength in V/m
 - σ = conductivity in [mho/m] or [siemens/m]
 - ρ = equivalent tissue density in g/cm³

Note that the density is normally set to 1 (or 1.06), to account for actual brain density rather than the density of the simulation liquid.

The power flow density is calculated assuming the excitation field as a free space field.

$$P_{pwe} = \frac{E_{tot}^2}{3770} \quad \text{or} \quad P_{pwe} = H_{tot}^2 \cdot 37.7$$

- where
- P_{pwe} = Equivalent power density of a plane wave in mW/cm²
 - E_{tot} = total electric field strength in V/m
 - H_{tot} = total magnetic field strength in A/m



5.2 SAR EVALUATION PROCEDURE

The evaluation was performed with the following procedure:

Step 1: Measurement of the SAR value at a fixed location above the central position was used as a reference value for assessing the power drop.

Step 2: The SAR distribution at the exposed side of the body was measured at a distance of 4 mm from the inner surface of the shell. The area covered the entire dimension of the EUT and the horizontal grid spacing was 10 mm x 10 mm. Based on the data, the area of the maximum absorption was determined by spline interpolation.

Step 3: Around this point, a volume of 32 mm x 32 mm x 34 mm was assessed by measuring 7 x 7 x 7 points. On the basis of this data set, the spatial peak SAR value was evaluated under the following procedure:

1. The data at the surface were extrapolated, since the center of the dipoles is 2.7 mm away from the tip of the probe and the distance between the surface and the lowest measuring point is 1.2 mm. The extrapolation was based on a least square algorithm [11]. A polynomial of the fourth order was calculated through the points in z-axes. This polynomial was then used to evaluate the points between the surface and the probe tip.
2. The maximum interpolated value was searched with a straightforward algorithm. Around this maximum the SAR values averaged over the spatial volumes (1 g or 10 g) were computed by the 3D-Spline interpolation algorithm. The 3D-Spline is composed of three one-dimensional splines with the "Not a knot"-condition (in x, y and z-directions) [11], [12]. The volume was integrated with the trapezoidal-algorithm. One thousand points (10 x 10 x 10) were interpolated to calculate the average.
3. All neighboring volumes were evaluated until no neighboring volume with a higher average value was found.

Step 4: Re-measurement of the SAR value at the same location as in Step 1. If the value changed by more than 5%, the evaluation was repeated.



6. MEASUREMENT UNCERTAINTY

Error Description	Uncertainty Value ±%	Probablility distribution	Divisor	C ₁ 1g	Standard unc.(1g) ±%	V ₁ or V _{eff}
Measurement System						
Probe calibration	±4.8	normal	1	1	±4.8	
Axial isotropy of probe	±4.6	rectangular	3	$(1-C_p)^{1/2}$	±1.9	
Sph. Isotropy of probe	±9.7	rectangular	3	$(C_p)^{1/2}$	±3.9	
Probe linearity	±4.5	rectangular	3	1	±2.7	
Detection Limit	±0.9	rectangular	3	1	±0.6	
Boundary effects	±8.5	rectangular	3	1	±4.8	
Readoutelectronics	±1.0	normal	1	1	±1.0	
Response time	±0.9	rectangular	3	1	±0.5	
Integration time	±1.2	rectangular	3	1	±0.8	
Mech Constrains of robot	±0.5	rectangular	3	1	±0.2	
Probe positioning	±2.7	rectangular	3	1	±1.7	
Extrap. And integration	±4.0	rectangular	3	1	±2.3	
RF ambient conditiona	±0.54	rectangular	3	1	±0.43	
Test Sample Related						
Device positioning	±2.2	normal	1	1	±2.23	11
Device holder uncertainty	±5	normal	1	1	±5.0	7
Power drift	±5	rectangular	3	1	±2.9	
Phantom and Setup						
Phantom uncertainty	±4	rectangular	3	1	±2.3	
Liquid cinductivity	±5	rectangular	3	0.6	±1.7	
Liquid cinductivity	±5	rectangular	3	0.6	±3.5/1.7	
Liquid permittivity	±5	rectangular	3	0.6	±1.7	
Liquid permittivity	±5	rectangular	3	0.6	±1.7	
Combined Standard Uncertainty					±12.14/11.76	
Coverage Factor for 95%		kp=2				
Expanded Standard Uncertainty					±24.29/23.51	



7. EXPOSURE LIMIT

(A). Limits for Occupational/Controlled Exposure (W/kg)

Whole-Body	Partial-Body	Hands, Wrists, Feet and Ankles
0.4	8.0	20.0

(B). Limits for General Population/Uncontrolled Exposure (W/kg)

Whole-Body	Partial-Body	Hands, Wrists, Feet and Ankles
0.08	1.6	4.0

Note: Whole-Body SAR is averaged over the entire body, partial-body SAR is averaged over any 1 gram of tissue defined as a tissue volume in the shape of a cube. SAR for hands, wrists, feet and ankles is averaged over any 10 grams of tissue defined as a tissue volume in the shape of a cube.

Population/Uncontrolled Environments are defined as locations where there is the exposure of individuals who have no knowledge or control of their exposure.

Occupational/Controlled Environments are defined as locations where there is exposure that may be incurred by people who are aware of the potential for exposure, (i.e. as a result of employment or occupation).

<p>NOTE</p> <p>GENERAL POPULATION/UNCONTROLLED EXPOSURE</p> <p>PARTIAL BODY LIMIT</p> <p>1.6 mW/g</p>



8. MEASUREMENT RESULTS

8.1 SYSTEM VALIDATION

Prior to the assessment, the system validation kit was used to test whether the system was operating within its specifications of $\pm 5\%$. The validation results are tabulated below. And also the corresponding SAR plot is attached as well in the SAR plots files.

IEEE P1528 Recommended Reference Value

Frequency (MHz)	1g SAR	10g SAR	Local SAR at Surface (Above Feed Point)	Local SAR at Surface (y = 2cm offset from feed point)
900	10.3	6.57	16.4	5.4
1800	38.2	20.3	69.5	6.8
2450	54.8	24.2	104.2	7.7

System Validation Results

Ambient conduction: Temperature: 25.7 °C; Relative humidity: 60%

System Validation Dipole: D2450V2 SN:726

Date: Sep 06, 2003

Medium			Parameters	Target	Measured	Deviation[%]	Limited[%]
Type	Temp. [°C]	Dipth [cm]					
Head	25.30	15.00	Permittivity:	39	39.18	0.46	± 5
2450 MHz			Conductivity:	1.8	1.8212	1.18	± 5
			1g SAR:	54.8	54.4	-0.73	± 5



8.2 TEST LIQUID CONFIRMATION

Simulated Tissue Liquid Parameter confirmation

The dielectric parameters were checked prior to assessment using the HP85070C dielectric probe kit. The dielectric parameters measured are reported in each correspondent section.

IEEE SCC-34/SC-2 P1528 recommended Tissue Dielectric Parameters

The head tissue dielectric parameters recommended by the IEEE SCC-34/SC-2 in P1528 have been incorporated in the following table. These head parameters are derived from planar layer models simulating the highest expected SAR for the dielectric properties and tissue thickness variations in a human head. Other head and body tissue parameters that have not been specified in P1528 are derived from the tissue dielectric parameters computed from the 4-Cole-Cole equations and extrapolated according to the head parameters specified in P1528

Target Frequency (MHz)	Head		Body	
	ϵ_r	σ (S/m)	ϵ_r	σ (S/m)
150	52.3	0.76	61.9	0.80
300	45.3	0.87	58.2	0.92
450	43.5	0.87	56.7	0.94
835	41.5	0.90	55.2	0.97
900	41.5	0.97	55.0	1.05
915	41.5	0.98	55.0	1.06
1450	40.5	1.20	54.0	1.30
1610	40.3	1.29	53.8	1.40
1800-2000	40.0	1.40	53.3	1.52
2450	39.2	1.80	52.7	1.95
3000	38.5	2.40	52.0	2.73
5800	45.3	5.27	48.2	6.00

Note: ϵ_r = relative permittivity, σ = conductivity and $\rho = 1000 \text{ kg/m}^3$



Liquid Confirmation Results

Ambient conduction – Temperature: 25.7 °C; Relative humidity: 60% **Date:** Sep 06, 2003

Medium			Parameters	Target	Measured	Deviation[%]	Limited[%]
Type	Temp. [°C]	Dipth (cm)					
Muscle	25.40	15.00	Permitivity:	52.7	51	-3.23	± 5
2450 Mhz			Conductivity:	1.95	1.959	0.46	± 5



EUT TUNE-UP PROCEDURE

The following procedure had been used to prepare the EUT for the SAR test.

- The client supplied a special driver to program the EUT, allowing it to continually transmit the specified maximum power and change the channel frequency.
- The conducted power was measured at the high, middle and low channel frequency before and after the SAR measurement.
- The output power(dBm) we measured before SAR test in different transition rate and channel

Rate CH	1M	2M	5.5M	11M
1	16.10	16.18	16.30	16.28
6	16.08	16.16	16.28	16.26
11	15.50	15.58	15.70	15.68

8.3 EUT SETUP PHOTOS

EUT Setup Configuration 1

1. Installation conditions between host device and phantom - Bottom face in parallel with flat phantom.
2. Spacing between host device and phantom - In contact (0 cm).



EUT Setup Configuration 2

1. Installation conditions between host device and phantom - Host device perpendicular to flat phantom
2. Spacing between EUT and phantom - 1.5 cm

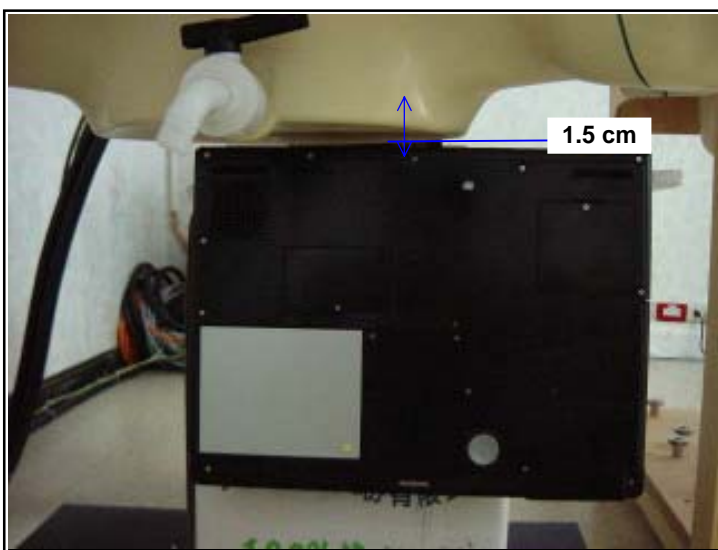



8.4 SAR MEASUREMENT RESULT

EUT Set-up Configuration 1 - Body/Flat							DATE : Sep 06,2003	
EUT Set-up conditions		Frequency		Conducted power [dBm] (Peak)		Liquid Temp [°C]	SAR (mW/g)	Limit (mW/g)
Sep. [cm]	Rate	Channel	MHz	Before	After			
0	5.5	1	2412	16.30	16.27	25.3	0.00902	1.6
		6	2437	16.28	16.24	25.3	0.01100	
		11	2462	15.70	15.61	25.3	0.00879	

Note (s): Please refer to attachment for the result presentation in plot format.

EUT Set-up Configuration 2 - Body/Flat								
EUT Set-up conditions		Frequency		Conducted power [dBm] (Peak)		Liquid Temp [°C]	SAR (mW/g)	Limit (mW/g)
Sep. [cm]	Rate	Channel	MHz	Before	After			
1.5	5.5	1	2412	16.30	16.26	25.3	0.03720	1.6
		6	2437	16.28	16.23	25.3	0.05810	
		11	2462	15.70	15.60	25.3	0.06310	

Note (s): Please refer to attachment for the result presentation in plot format.

9. EUT PHOTOS

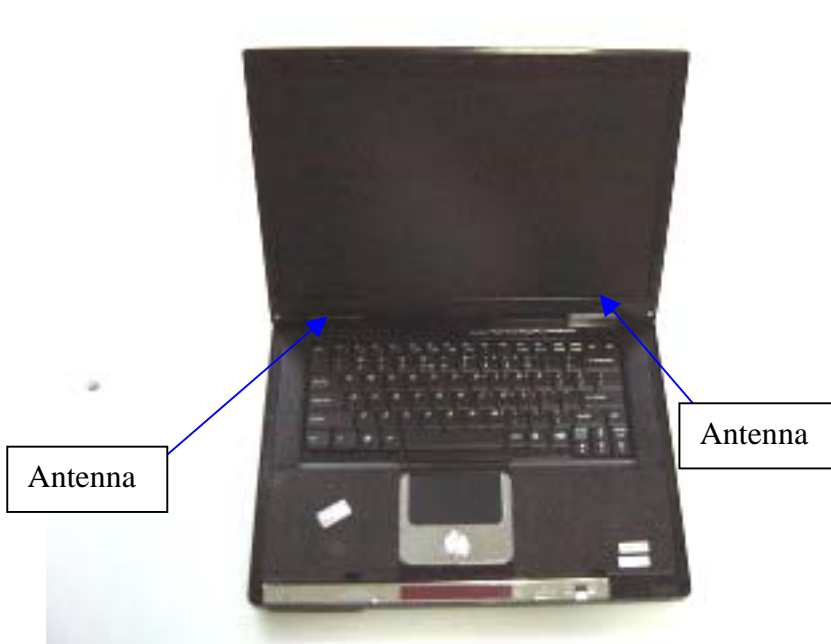



10. EQUIPMENT LIST & CALIBRATION

Name of Equipment	Manufacturer	Type/Model	Serial Number	Calibration Due
S-Parameter Network Analyzer	Agilent	E8358A	US40280243	03/24/04
Electronic Probe kit	Hewlett Packard	85070A	N/A	N/A
3.5mm electronic Calibration Kit	Agilent	85093C	US01400208	01/22/04
Power Meter	Boonton	4531	13061	01/10/04
Power Sensor	Boonton	56218	2240	01/10/04
Power Meter	Agilent	E4416A	GB41291611	03/15/04
Power Sensor	Agilent	E9327A	US40441097	03/15/04
Thermometer	Amarell	4046	23641	12/12/04
Universal Radio Communication Tester	Rohde & Schwarz	CMU 200	1100.0008.02	N/A
Signal Generator	Agilent	83630B	3844A01022	01/15/04
Amplifier	Mini-Circuit	ZHL-1724HL N	N/A	N/A
DC Power generator	ABM	8301HD		N/A
Data Acquisition Electronics (DAE)	SPEAG	DAE3	558	03/07/04
Dosimetric E-Field Probe	SPEAG	ET3DV6	1762	03/31/04
900 MHz System Validation Dipole	SPEAG	D900V2	179	03/31/04
1800 MHz System Validation Dipole	SPEAG	D1800V2	2d026	04/01/04
2450 MHz System Validation Dipole	SPEAG	D2450V2	728	03/05/04
Probe Alignment Unit	SPEAG	LB (V2)	348	N/A
Robot	Staubli	RX90B L	F02/5T69A1/A/01	N/A
SAM Twin Phantom V4.0	SPEAG	N/A	N/A	N/A
Devices Holder	SPEAG	N/A	N/A	N/A
Head 835 MHz	CCS	H835A	N/A	N/A
Muscle 835 MHz	CCS	M835A	N/A	N/A
Head 900 MHz	CCS	H900A	N/A	N/A
Muscle 900 MHz	CCS	M900A	N/A	N/A
Head 1800 MHz	CCS	H1800A	N/A	N/A
Muscle 1800 MHz	CCS	M1800A	N/A	N/A
Head 1900 MHz	CCS	H1900A	N/A	N/A
Muscle 1900 MHz	CCS	M1900A	N/A	N/A
Head 2450 MHz	CCS	H2450A	N/A	N/A
Muscle 2450 MHz	CCS	M2450A	N/A	N/A



11. REFERENCES

- [1] Federal Communications Commission, \Report and order: Guidelines for evaluating the environ-mental effects of radio frequency radiation", Tech. Rep. FCC 96-326, FCC, Washington, D.C. 20554, 1996.
- [2] David L. Means Kwok Chan, Robert F. Cleveland, \Evaluating compliance with FCC guidelines for human exposure to radio frequency electromagnetic fields", Tech. Rep., Federal Communication Commission, Office of Engineering & Technology, Washington, DC, 1997.
- [3] Thomas Schmid, Oliver Egger, and Niels Kuster, \Automated E-field scanning system for dosimetric assessments", IEEE Transactions on Microwave Theory and Techniques, vol. 44, pp. 105{113, Jan. 1996.
- [4] Niels Kuster, Ralph Kastle, and Thomas Schmid, \Dosimetric evaluation of mobile communications equipment with known precision", IEICE Transactions on Communications, vol. E80-B, no. 5, pp. 645{652, May 1997.
- [5] CENELEC, \Considerations for evaluating of human exposure to electromagnetic fields (EMFs) from mobile telecommunication equipment (MTE) in the frequency range 30MHz - 6GHz", Tech. Rep., CENELEC, European Committee for Electrotechnical Standardization, Brussels, 1997.
- [6] ANSI, ANSI/IEEE C95.1-1999: IEEE Standard for Safety Levels with Respect to Human Exposure to Radio Frequency Electromagnetic Fields, 3 kHz to 300 GHz, The Institute of Electrical and Electronics Engineers, Inc., New York, NY 10017, 1992.
- [7] Katja Pokovic, Thomas Schmid, and Niels Kuster, \Robust setup for precise calibration of E-field probes in tissue simulating liquids at mobile communications frequencies", in ICECOM _ 97, Dubrovnik, October 15{17, 1997, pp. 120{124.
- [8] Katja Pokovic, Thomas Schmid, and Niels Kuster, \E-field probe with improved isotropy in brain simulating liquids", in Proceedings of the ELMAR, Zadar, Croatia, 23{25 June, 1996, pp. 172{175.
- [9] Volker Hombach, Klaus Meier, Michael Burkhardt, Eberhard K. uhn, and Niels Kuster, \The dependence of EM energy absorption upon human head modeling at 900 MHz", IEEE Transactions on Microwave Theory and Techniques, vol. 44, no. 10, pp. 1865{1873, Oct. 1996.
- [10] Klaus Meier, Ralf Kastle, Volker Hombach, Roger Tay, and Niels Kuster, \The dependence of EM energy absorption upon human head modeling at 1800 MHz", IEEE Transactions on Microwave Theory and Techniques, Oct. 1997, in press.
- [11] W. Gander, Computermathematik, Birkhaeuser, Basel, 1992.
- [12] W. H. Press, S. A. Teukolsky, W. T. Vetterling, and B. P. Flannery, Numerical Recipes in C, The Art of Scientific Computing, Second Edition, Cambridge University Press, 1992. Dosimetric Evaluation of Sample device, month 1998 9
- [13] NIS81 NAMAS, \The treatment of uncertainty in EMC measurement", Tech. Rep., NAMAS Executive, National Physical Laboratory, Teddington, Middlesex, England, 1994.
- [14] Barry N. Taylor and Christ E. Kuyatt, \Guidelines for evaluating and expressing the uncertainty of NIST measurement results", Tech. Rep., National Institute of Standards and Technology, 1994. Dosimetric Evaluation of Sample device, month 1998 10



12. ATTACHMENT

Exhibit	Content
1.	Dosimetric E-Field Probe - ET3DV6, S/N: 1762
2.	Validation Dipole - D2450V2, S/N: 728
3.	System Performance Check Plots
4.	SAR Test Plots

End of Report

Client **C&C (Auden)**

CALIBRATION CERTIFICATE

Object(s) **ET3DV6 - SN:1762**

Calibration procedure(s) **QA CAL-01.v2
Calibration procedure for dosimetric E-field probes**

Calibration date: **March 31, 2003**

Condition of the calibrated item **In Tolerance (according to the specific calibration document)**

This calibration statement documents traceability of M&TE used in the calibration procedures and conformity of the procedures with the ISO/IEC 17025 international standard.

All calibrations have been conducted in the closed laboratory facility: environment temperature 22 +/- 2 degrees Celsius and humidity < 75%.

Calibration Equipment used (M&TE critical for calibration)

Model Type	ID #	Cal Date	Scheduled Calibration
RF generator HP 8684C	US3642U01700	4-Aug-99 (in house check Aug-02)	In house check: Aug-05
Power sensor E4412A	MY41495277	Mar-02	Mar-03
Power sensor HP 8481A	MY41092180	18-Sep-02	Sep-03
Power meter EPM E4419B	GB41293874	13-Sep-02	Sep-03
Network Analyzer HP 8753E	US38432426	3-May-00	In house check: May 03
Flyke Process Calibrator Type 702	SN: 6295803	3-Sep-01	Sep-03

Calibrated by: **Name: Nico Veltrop, Function: Technician, Signature: [Signature]**

Approved by: **Name: Katja Pokovic, Function: Laboratory Director, Signature: [Signature]**

Date issued: April 2, 2003

This calibration certificate is issued as an intermediate solution until the accreditation process (based on ISO/IEC 17025 International Standard) for Calibration Laboratory of Schmid & Partner Engineering AG is completed.

Client **C&C (Auden)**

CALIBRATION CERTIFICATE

Object(s) **D2450V2 - SN:728**

Calibration procedure(s) **QA CAL-05.v2
 Calibration procedure for dipole validation kits**

Calibration date: **March 5, 2003**

Condition of the calibrated item **In Tolerance (according to the specific calibration document)**

This calibration statement documents traceability of M&TE used in the calibration procedures and conformity of the procedures with the ISO/IEC 17025 international standard.

All calibrations have been conducted in the closed laboratory facility: environment temperature 22 +/- 2 degrees Celsius and humidity < 75%.

Calibration Equipment used (M&TE critical for calibration)

Model Type	ID #	Cal Date	Scheduled Calibration
RF generator R&S SML-03	100698	27-Mar-2002	In house check: Mar-05
Power sensor HP 8481A	MY41092317	18-Oct-02	Oct-04
Power sensor HP 8481A	US37292783	30-Oct-02	Oct-03
Power meter EPM E442	GB37480704	30-Oct-02	Oct-03
Network Analyzer HP 8753E	US38432426	3-May-00	In house check: May 03

Calibrated by: **Name: Nico Vetterli, Function: Technician, Signature: [Signature]**

Approved by: **Name: Katja Pokovic, Function: Laboratory Director, Signature: [Signature]**

Date issued: April 2, 2003

This calibration certificate is issued as an intermediate solution until the accreditation process (based on ISO/IEC 17025 International Standard) for Calibration Laboratory of Schmid & Partner Engineering AG is completed.

Test Laboratory: Compliance Certification Services Inc.
File Name: [2450-Dipole-1.da4](#)

2450-Dipole-1

DUT: Dipole 2450 MHz; Type: D2450V2; Serial: D2450V2 - SN:728
Program: System Performance Check at 2450MHz

Communication System: CW2450; Frequency: 2450 MHz; Duty Cycle: 1:1

Medium: HSL2450 ($\sigma = 1.8212$ mho/m, $\epsilon_r = 39.18$, $\rho = 1000$ kg/m³)

Air Temperature 25.7 deg C ; Liquid Temperature 25.3 deg C

Phantom section: Flat Section

DASY4 Configuration:

- Probe: ET3DV6 - SN1762; ConvF(5.1, 5.1, 5.1); Calibrated: 3/31/2003
- Sensor-Surface: 4mm (Mechanical And Optical Surface Detection)
Sensor-Surface: 0mm (Fix Surface)
- Electronics: DAE3 Sn558; Calibrated: 3/7/2003
- Phantom: SAM 34; Type: SAM V4.0; Serial: TP-1150
- Measurement SW: DASY4, V4.1 Build 47; Postprocessing SW: SEMCAD, V1.6 Build 115

Pin=250mW,d=10mm/Area Scan (5x5x1): Measurement grid: dx=15mm, dy=15mm

Reference Value = 92.8 V/m

Power Drift = 0.06 dB

Maximum value of SAR = 14.2 mW/g

Pin=250mW,d=10mm/Z Scan (1x1x21): Measurement grid: dx=20mm, dy=20mm, dz=5mm

Reference Value = 92.8 V/m

Power Drift = 0.03 dB

Maximum value of SAR = 13.9 mW/g

Pin=250mW,d=10mm/Zoom Scan (5x5x7)/Cube 0: Measurement grid: dx=7.5mm, dy=7.5mm, dz=5mm

Peak SAR (extrapolated) = 27.7 W/kg

SAR(1 g) = 13.6 mW/g; SAR(10 g) = 6.28 mW/g

Reference Value = 92.8 V/m

Power Drift = 0.06 dB

Maximum value of SAR = 15.1 mW/g

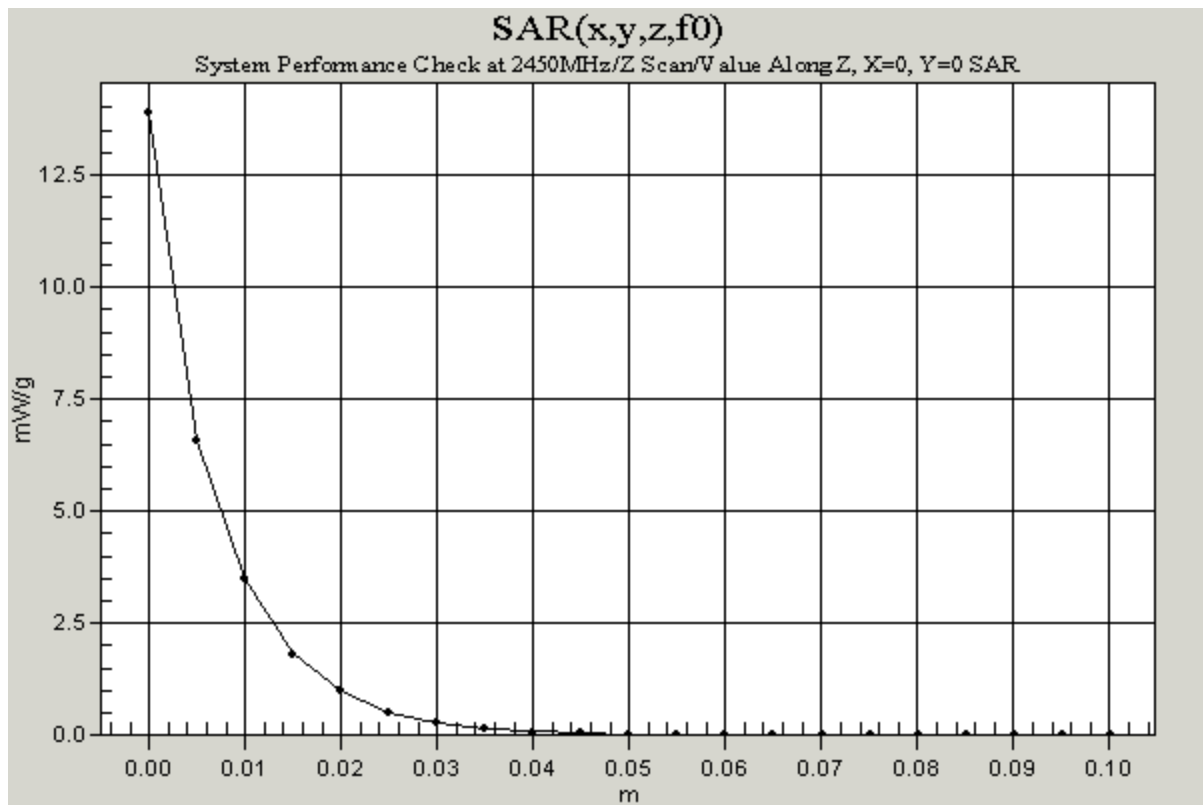
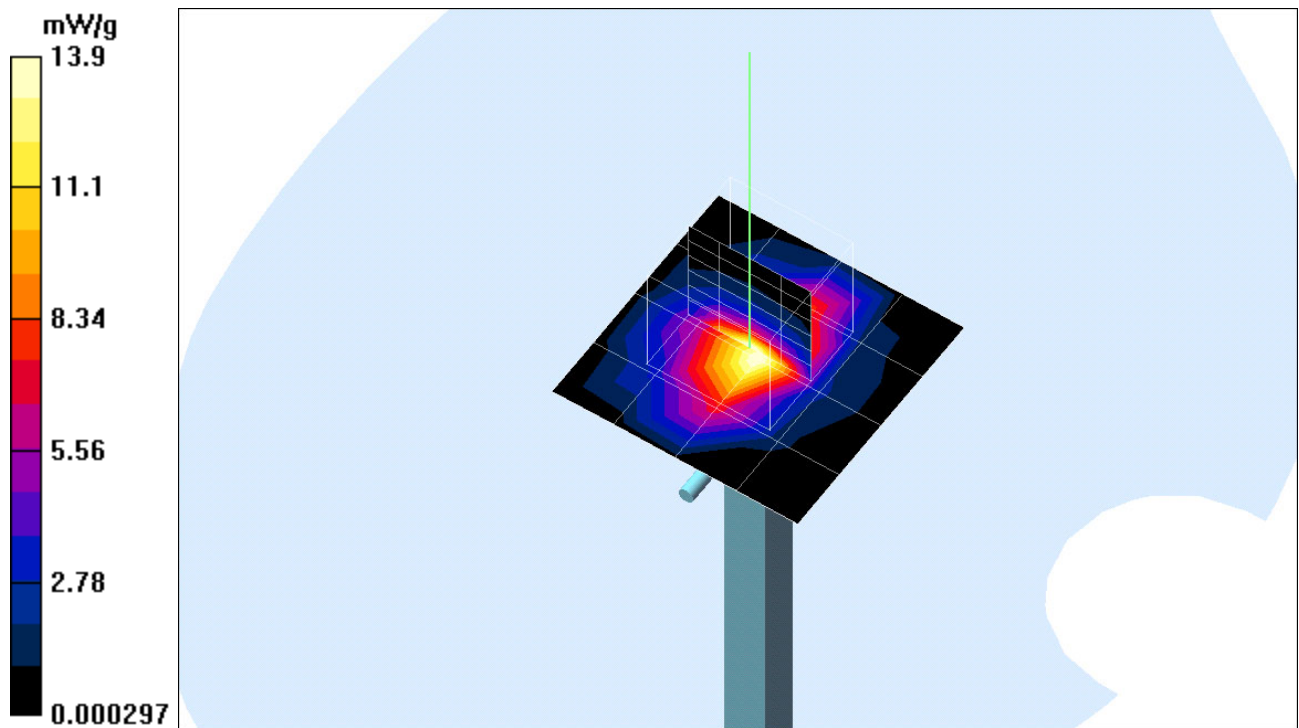

Test Laboratory: Compliance Certification Services Inc.

SETUP CONFIGURATION 1

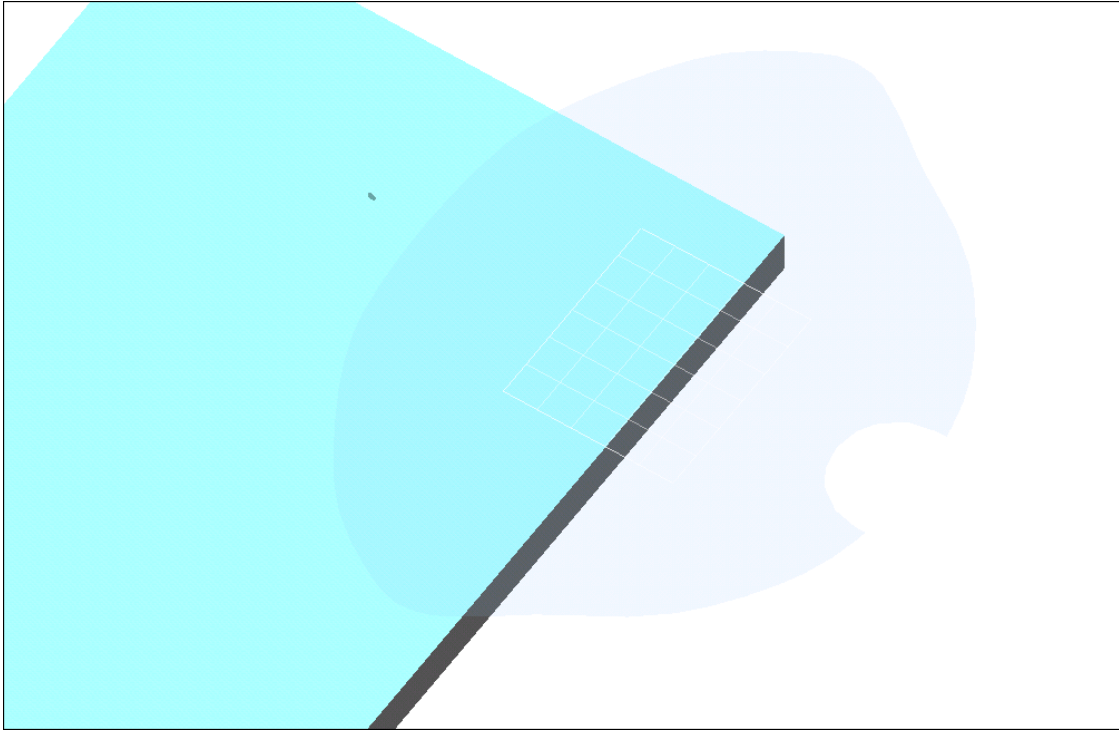

Test Laboratory: Compliance Certification Services Inc.
File Name: [0mm.da4](#)

0mm

DUT: NOTEBOOK; Type: CL32(a+b); Serial: n/a
Program: 0mm

Communication System: DSSS; Frequency: 2412 MHz; Duty Cycle: 1:1

Medium: HSL2450 ($\sigma = 1.959$ mho/m, $\epsilon_r = 51$, $\rho = 1000$ kg/m³)

Air Temperature 25.7 deg C ; Liquid Temperature 25.4 deg C

Phantom section: Flat Section

DASY4 Configuration:

- Probe: ET3DV6 - SN1762; ConvF(4.6, 4.6, 4.6); Calibrated: 3/31/2003
- Sensor-Surface: 4mm (Mechanical Surface Detection)
Sensor-Surface: 0mm (Fix Surface)
- Electronics: DAE3 Sn558; Calibrated: 3/7/2003
- Phantom: SAM 34; Type: SAM V4.0; Serial: TP-1150
- Measurement SW: DASY4, V4.1 Build 47; Postprocessing SW: SEMCAD, V1.6 Build 115

CH 1 rate=5.5/Area Scan (6x9x1): Measurement grid: dx=15mm, dy=15mm

Reference Value = 1.35 V/m

Power Drift = -0.2 dB

Maximum value of SAR = 0.00968 mW/g

CH 1 rate=5.5/Z Scan (1x1x21): Measurement grid: dx=20mm, dy=20mm, dz=5mm

Reference Value = 1.35 V/m

Power Drift = -0.2 dB

Maximum value of SAR = 0.00742 mW/g

CH 1 rate=5.5/Zoom Scan (5x5x7)/Cube 0: Measurement grid: dx=7.5mm, dy=7.5mm, dz=5mm

Peak SAR (extrapolated) = 0.0194 W/kg

SAR(1 g) = 0.00902 mW/g; SAR(10 g) = 0.00508 mW/g

Reference Value = 1.35 V/m

Power Drift = -0.2 dB

Maximum value of SAR = 0.00925 mW/g

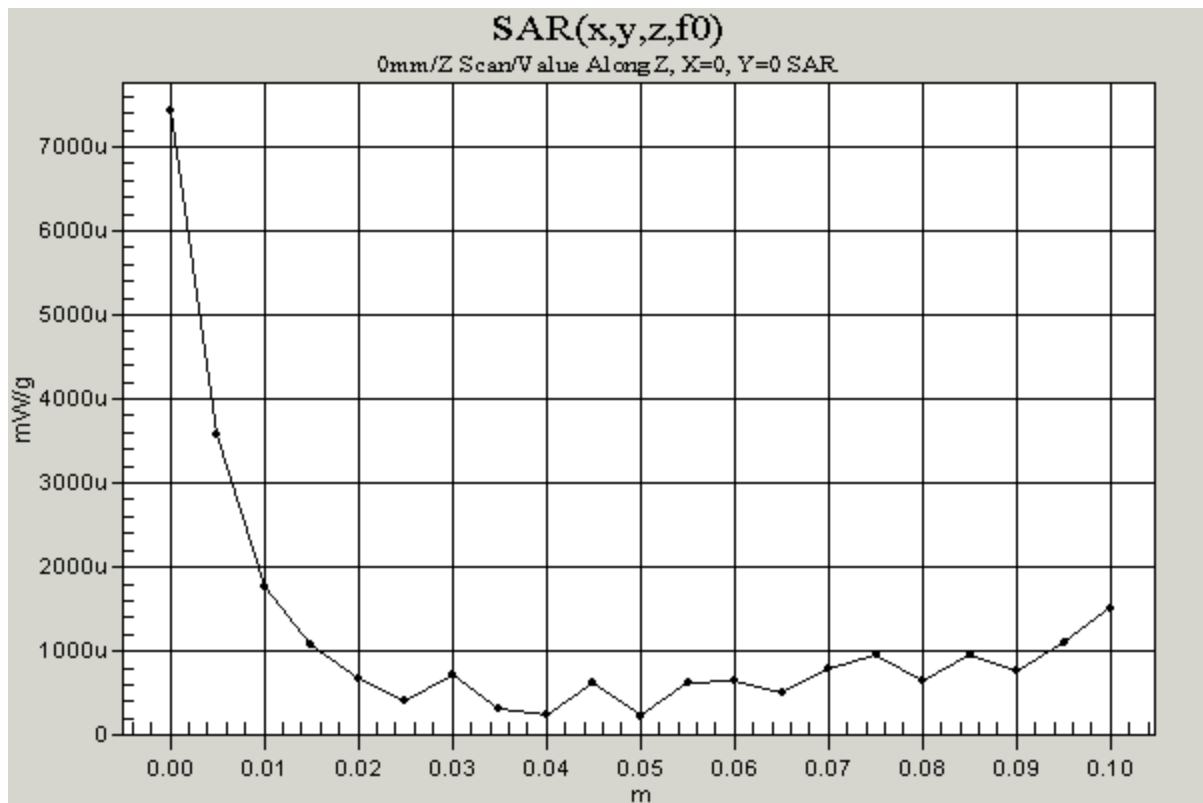
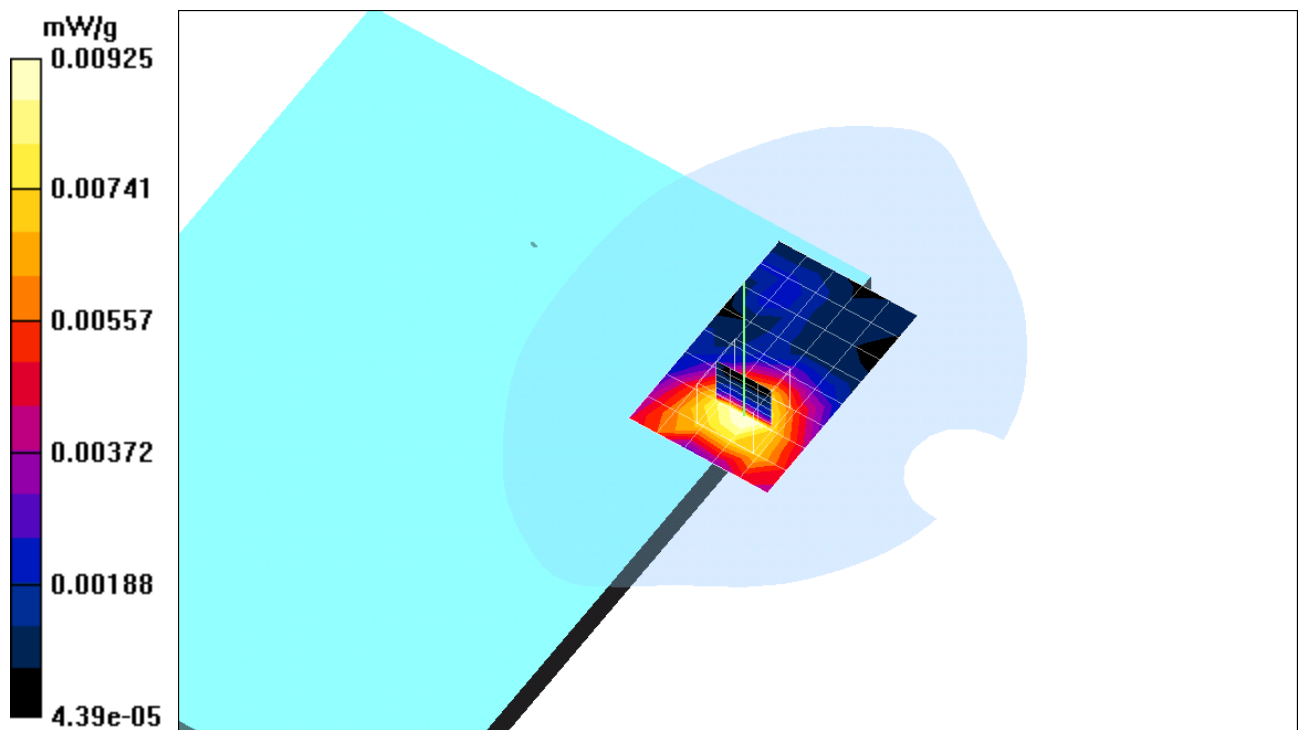

Test Laboratory: Compliance Certification Services Inc.
File Name: [0mm.da4](#)

0mm ch6 rate=5.5

DUT: NOTEBOOK; Type: CL32(a+b); Serial: n/a
Program: 0mm

Communication System: DSSS; Frequency: 2437 MHz; Duty Cycle: 1:1

Medium: HSL2450 ($\sigma = 1.959$ mho/m, $\epsilon_r = 51$, $\rho = 1000$ kg/m³)

Air Temperature 25.7 deg C ; Liquid Temperature 25.4 deg C

Phantom section: Flat Section

DASY4 Configuration:

- Probe: ET3DV6 - SN1762; ConvF(4.6, 4.6, 4.6); Calibrated: 3/31/2003
- Sensor-Surface: 4mm (Mechanical Surface Detection)
Sensor-Surface: 0mm (Fix Surface)
- Electronics: DAE3 Sn558; Calibrated: 3/7/2003
- Phantom: SAM 34; Type: SAM V4.0; Serial: TP-1150
- Measurement SW: DASY4, V4.1 Build 47; Postprocessing SW: SEMCAD, V1.6 Build 115

CH 6 rate=5.5/Area Scan (6x7x1): Measurement grid: dx=15mm, dy=15mm

Reference Value = 2.03 V/m

Power Drift = 0.2 dB

Maximum value of SAR = 0.0114 mW/g

CH 6 rate=5.5/Z Scan (1x1x21): Measurement grid: dx=20mm, dy=20mm, dz=5mm

Reference Value = 2.03 V/m

Power Drift = -0.03 dB

Maximum value of SAR = 0.0085 mW/g

CH 6 rate=5.5/Zoom Scan (5x5x7)/Cube 0: Measurement grid: dx=7.5mm, dy=7.5mm, dz=5mm

Peak SAR (extrapolated) = 0.0257 W/kg

SAR(1 g) = 0.011 mW/g; SAR(10 g) = 0.00601 mW/g

Reference Value = 2.03 V/m

Power Drift = 0.2 dB

Maximum value of SAR = 0.0116 mW/g

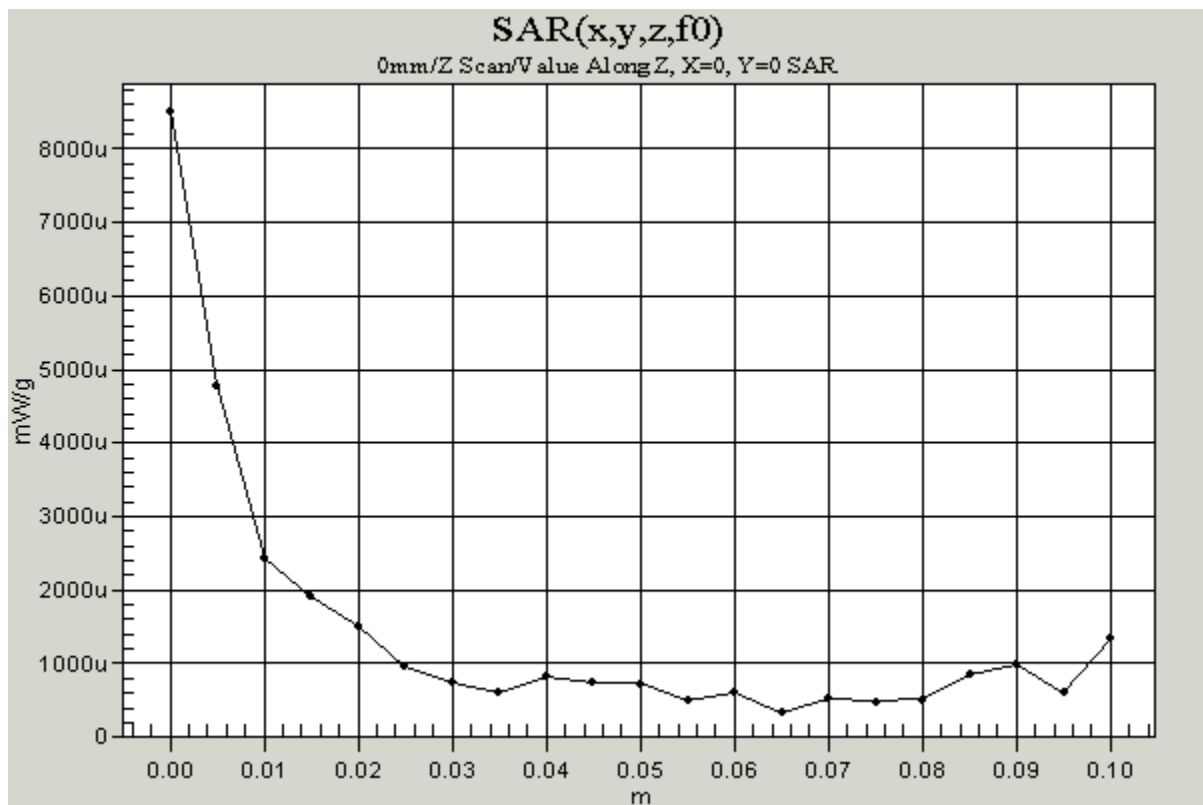
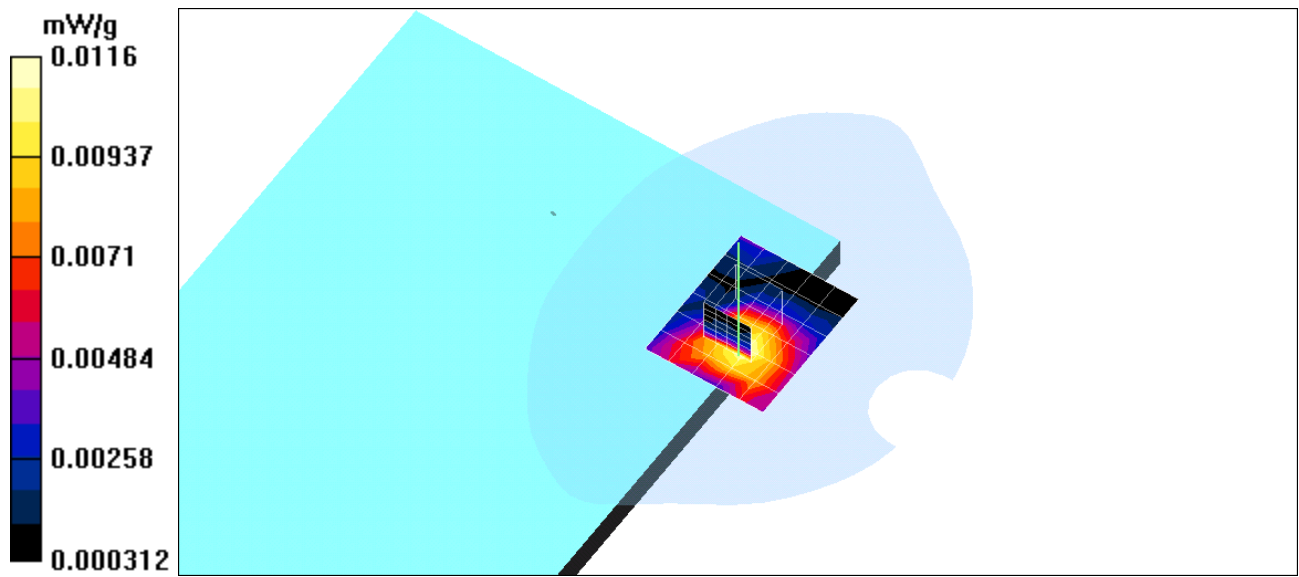

Test Laboratory: Compliance Certification Services Inc.
File Name: [0mm.da4](#)

0mm

DUT: NOTEBOOK; Type: CL32(a+b); Serial: n/a
Program: 0mm

Communication System: DSSS; Frequency: 2462 MHz; Duty Cycle: 1:1

Medium: HSL2450 ($\sigma = 1.959$ mho/m, $\epsilon_r = 51$, $\rho = 1000$ kg/m³)

Air Temperature 25.7 deg C ; Liquid Temperature 25.4 deg C

Phantom section: Flat Section

DASY4 Configuration:

- Probe: ET3DV6 - SN1762; ConvF(4.6, 4.6, 4.6); Calibrated: 3/31/2003
- Sensor-Surface: 4mm (Mechanical Surface Detection)
Sensor-Surface: 0mm (Fix Surface)
- Electronics: DAE3 Sn558; Calibrated: 3/7/2003
- Phantom: SAM 34; Type: SAM V4.0; Serial: TP-1150
- Measurement SW: DASY4, V4.1 Build 47; Postprocessing SW: SEMCAD, V1.6 Build 115

CH 11 rate=5.5/Area Scan (6x7x1): Measurement grid: dx=15mm, dy=15mm

Reference Value = 2.13 V/m

Power Drift = -0.003 dB

Maximum value of SAR = 0.00919 mW/g

CH 11 rate=5.5/Z Scan (1x1x21): Measurement grid: dx=20mm, dy=20mm, dz=5mm

Reference Value = 2.13 V/m

Power Drift = 0.01 dB

Maximum value of SAR = 0.00669 mW/g

CH 11 rate=5.5/Zoom Scan (5x5x7)/Cube 0: Measurement grid: dx=7.5mm, dy=7.5mm, dz=5mm

Peak SAR (extrapolated) = 0.0202 W/kg

SAR(1 g) = 0.00879 mW/g; SAR(10 g) = 0.00491 mW/g

Reference Value = 2.13 V/m

Power Drift = -0.003 dB

Maximum value of SAR = 0.00905 mW/g

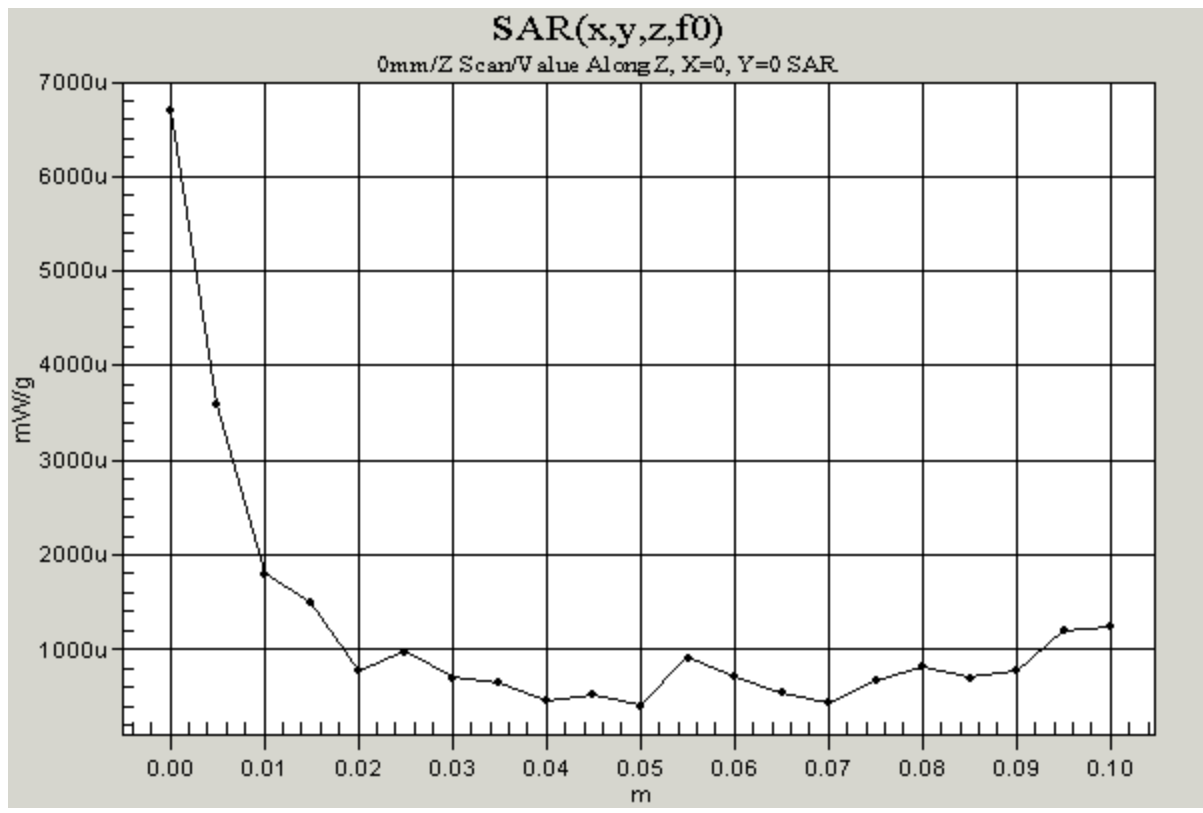
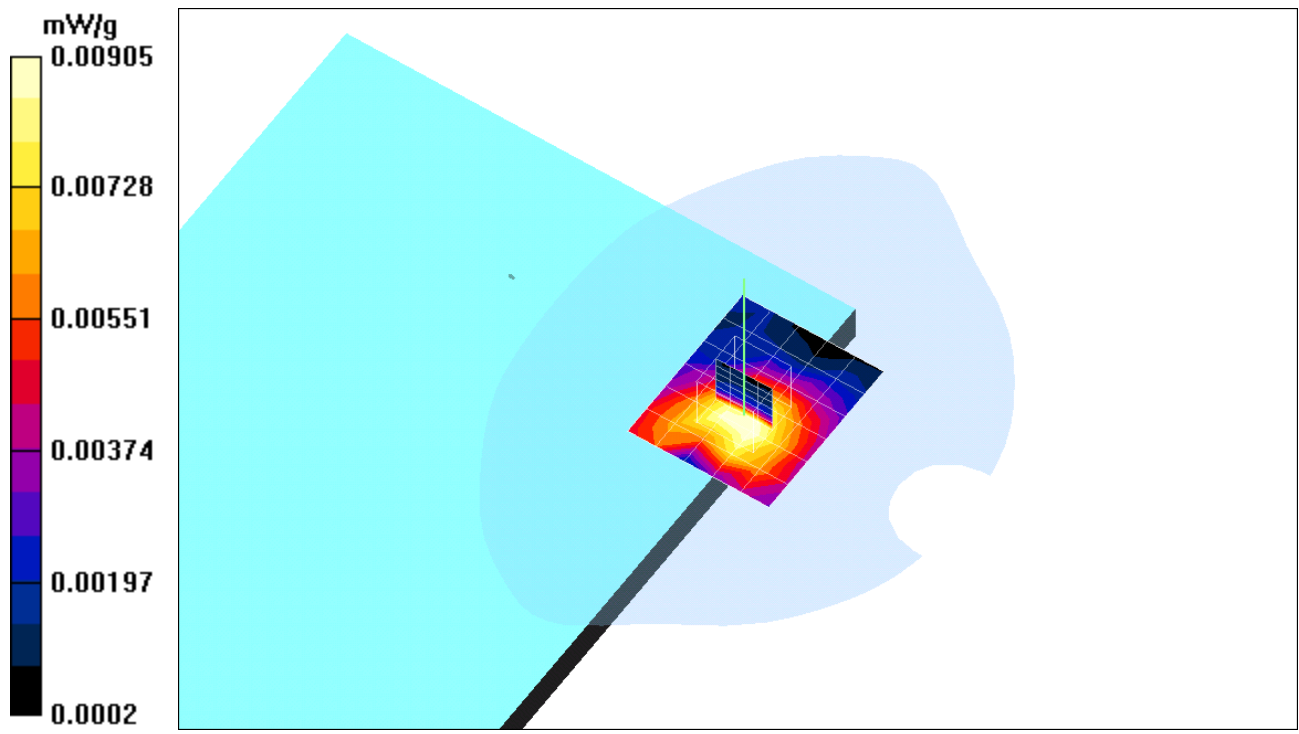

Test Laboratory: Compliance Certification Services Inc.
File Name: [0mmA2.da4](#)

TEST Configuration 2

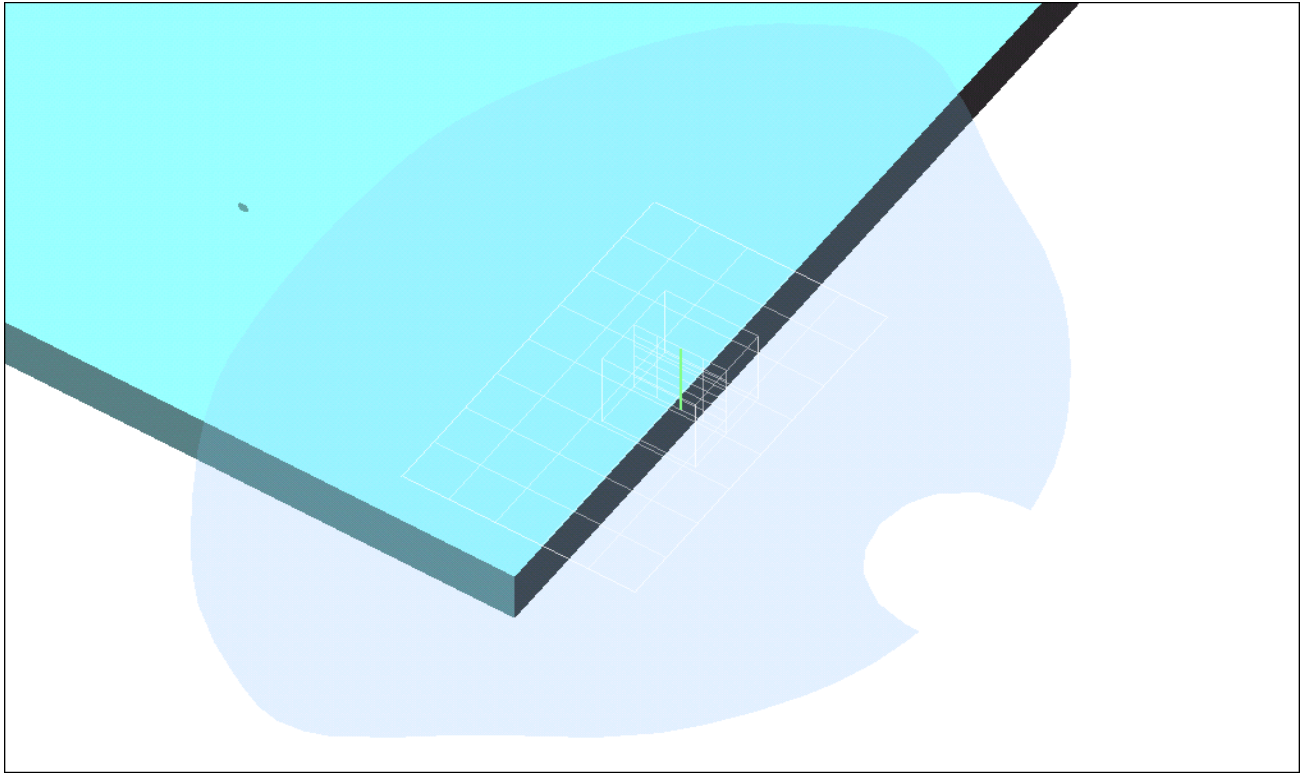

Test Laboratory: Compliance Certification Services Inc.
File Name: [15mm.da4](#)

15mm

DUT: NOTEBOOK; Type: CL32(a+b); Serial: n/a
Program: 15mm

Communication System: DSSS; Frequency: 2412 MHz; Duty Cycle: 1:1

Medium: HSL2450 ($\sigma = 1.959$ mho/m, $\epsilon_r = 51$, $\rho = 1000$ kg/m³)

Air Temperature 25.7 deg C ; Liquid Temperature 25.4 deg C

Phantom section: Flat Section

DASY4 Configuration:

- Probe: ET3DV6 - SN1762; ConvF(4.6, 4.6, 4.6); Calibrated: 3/31/2003
- Sensor-Surface: 4mm (Mechanical Surface Detection)
Sensor-Surface: 0mm (Fix Surface)
- Electronics: DAE3 Sn558; Calibrated: 3/7/2003
- Phantom: SAM 34; Type: SAM V4.0; Serial: TP-1150
- Measurement SW: DASY4, V4.1 Build 47; Postprocessing SW: SEMCAD, V1.6 Build 115

CH 1/Area Scan (6x9x1): Measurement grid: dx=15mm, dy=15mm

Reference Value = 3.72 V/m

Power Drift = -0.04 dB

Maximum value of SAR = 0.037 mW/g

CH 1/Z Scan (1x1x21): Measurement grid: dx=20mm, dy=20mm, dz=5mm

Reference Value = 3.72 V/m

Power Drift = -0.07 dB

Maximum value of SAR = 0.0401 mW/g

CH 1/Zoom Scan (5x5x7)/Cube 0: Measurement grid: dx=7.5mm, dy=7.5mm, dz=5mm

Peak SAR (extrapolated) = 0.0649 W/kg

SAR(1 g) = 0.0372 mW/g; SAR(10 g) = 0.0258 mW/g

Reference Value = 3.72 V/m

Power Drift = -0.04 dB

Maximum value of SAR = 0.0374 mW/g

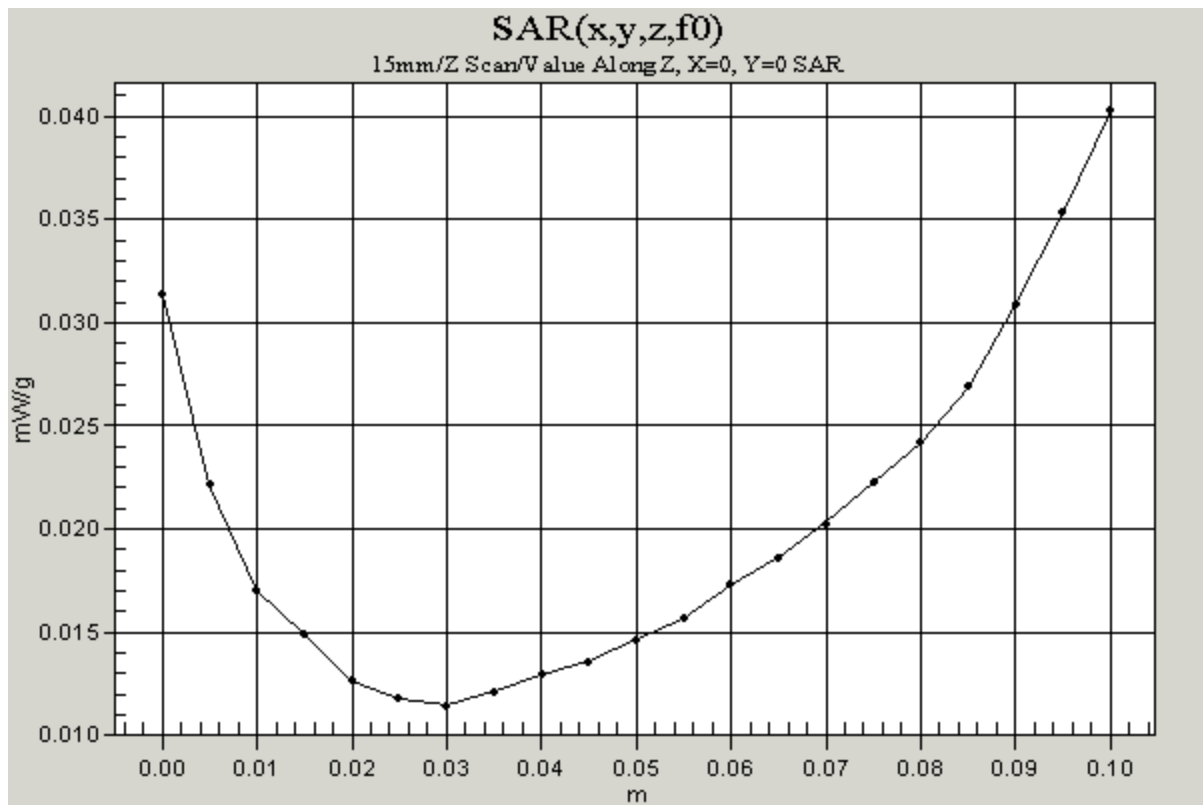
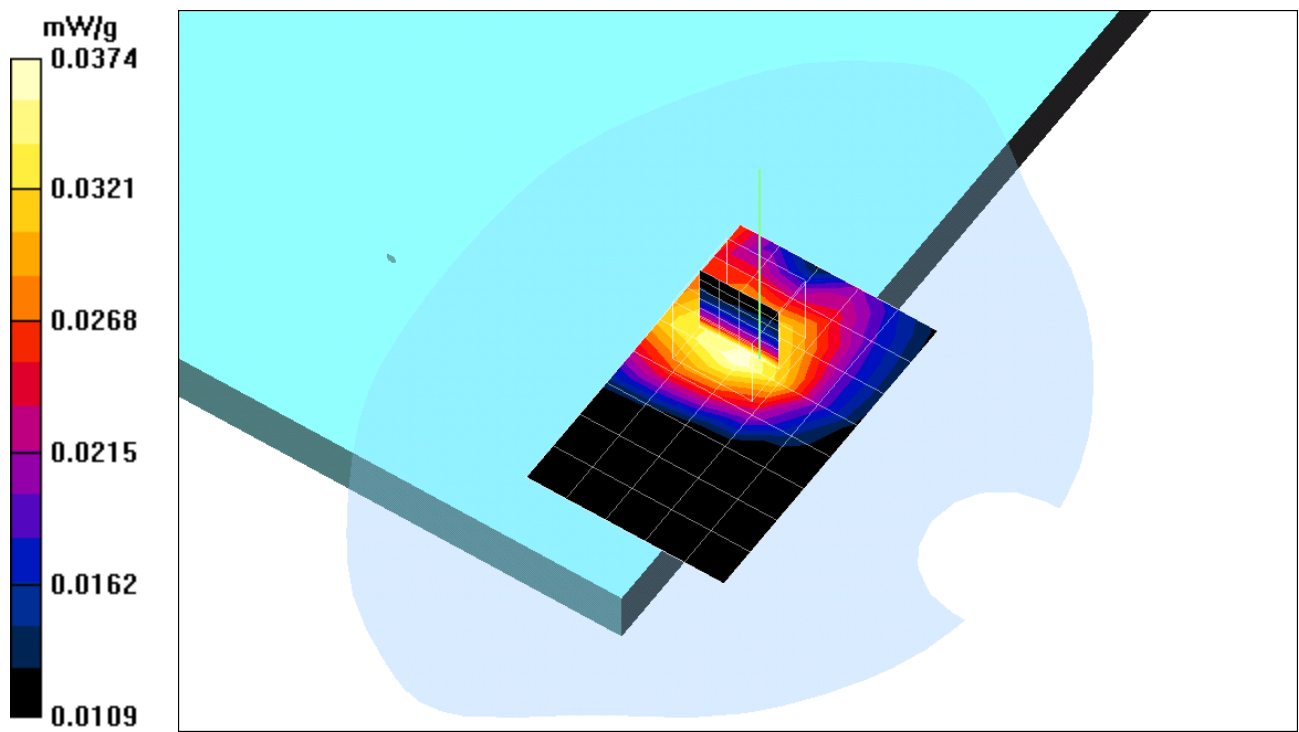

Test Laboratory: Compliance Certification Services Inc.
File Name: [15mm.da4](#)

15mm

DUT: NOTEBOOK; Type: CL32(a+b); Serial: n/a
Program: 15mm

Communication System: DSSS; Frequency: 2437 MHz; Duty Cycle: 1:1

Medium: HSL2450 ($\sigma = 1.959$ mho/m, $\epsilon_r = 51$, $\rho = 1000$ kg/m³)

Air Temperature 25.7 deg C ; Liquid Temperature 25.4 deg C

Phantom section: Flat Section

DASY4 Configuration:

- Probe: ET3DV6 - SN1762; ConvF(4.6, 4.6, 4.6); Calibrated: 3/31/2003
- Sensor-Surface: 4mm (Mechanical Surface Detection)
Sensor-Surface: 0mm (Fix Surface)
- Electronics: DAE3 Sn558; Calibrated: 3/7/2003
- Phantom: SAM 34; Type: SAM V4.0; Serial: TP-1150
- Measurement SW: DASY4, V4.1 Build 47; Postprocessing SW: SEMCAD, V1.6 Build 115

CH 6/Area Scan (6x8x1): Measurement grid: dx=15mm, dy=15mm

Reference Value = 5.81 V/m

Power Drift = -0.1 dB

Maximum value of SAR = 0.0593 mW/g

CH 6/Z Scan (1x1x21): Measurement grid: dx=20mm, dy=20mm, dz=5mm

Reference Value = 5.81 V/m

Power Drift = -0.1 dB

Maximum value of SAR = 0.148 mW/g

CH 6/Zoom Scan (5x5x7)/Cube 0: Measurement grid: dx=7.5mm, dy=7.5mm, dz=5mm

Peak SAR (extrapolated) = 0.0713 W/kg

SAR(1 g) = **0.0581** mW/g; SAR(10 g) = 0.0499 mW/g

Reference Value = 5.81 V/m

Power Drift = -0.1 dB

Maximum value of SAR = 0.0593 mW/g

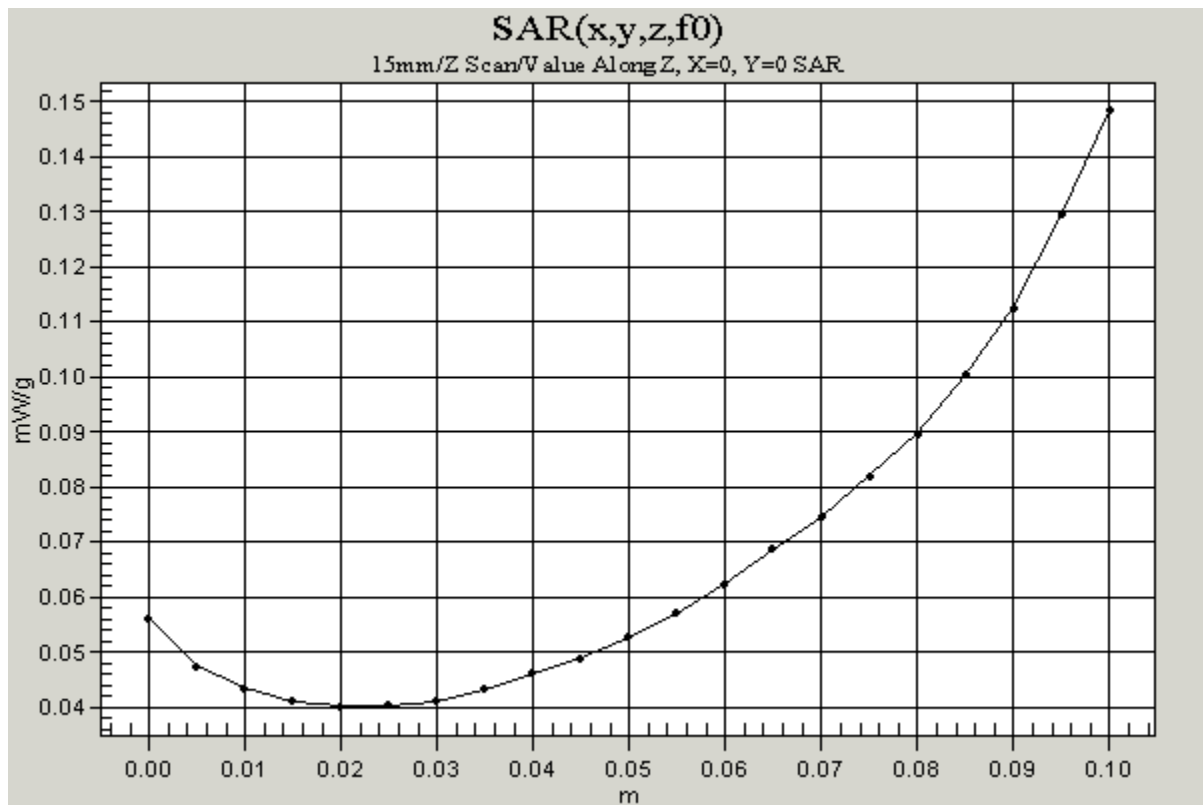
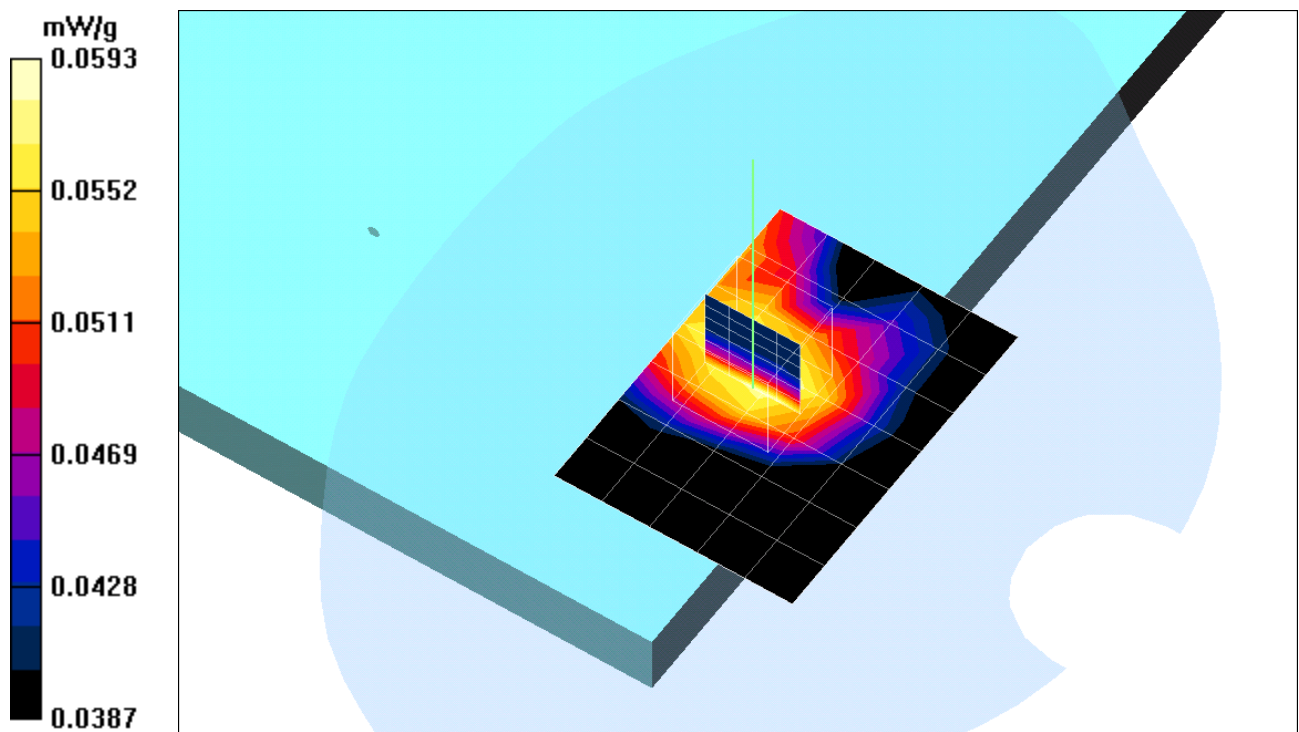

Test Laboratory: Compliance Certification Services Inc.
File Name: [15mm.da4](#)

15mm

DUT: NOTEBOOK; Type: CL32(a+b); Serial: n/a
Program: 15mm

Communication System: DSSS; Frequency: 2462 MHz; Duty Cycle: 1:1

Medium: HSL2450 ($\sigma = 1.959$ mho/m, $\epsilon_r = 51$, $\rho = 1000$ kg/m³)

Air Temperature 25.7 deg C ; Liquid Temperature 25.4 deg C

Phantom section: Flat Section

DASY4 Configuration:

- Probe: ET3DV6 - SN1762; ConvF(4.6, 4.6, 4.6); Calibrated: 3/31/2003
- Sensor-Surface: 4mm (Mechanical Surface Detection)
Sensor-Surface: 0mm (Fix Surface)
- Electronics: DAE3 Sn558; Calibrated: 3/7/2003
- Phantom: SAM 34; Type: SAM V4.0; Serial: TP-1150
- Measurement SW: DASY4, V4.1 Build 47; Postprocessing SW: SEMCAD, V1.6 Build 115

CH 11/Area Scan (6x8x1): Measurement grid: dx=15mm, dy=15mm

Reference Value = 3.73 V/m

Power Drift = -0.04 dB

Maximum value of SAR = 0.0617 mW/g

CH 11/Z Scan (1x1x21): Measurement grid: dx=20mm, dy=20mm, dz=5mm

Reference Value = 3.73 V/m

Power Drift = -0.2 dB

Maximum value of SAR = 0.0423 mW/g

CH 11/Zoom Scan (5x5x7)/Cube 0: Measurement grid: dx=7.5mm, dy=7.5mm, dz=5mm

Peak SAR (extrapolated) = 0.0992 W/kg

SAR(1 g) = 0.0631 mW/g; SAR(10 g) = 0.0425 mW/g

Reference Value = 3.73 V/m

Power Drift = -0.04 dB

Maximum value of SAR = 0.0656 mW/g

