



**ELECTROMAGNETIC EMISSIONS COMPLIANCE REPORT
INTENTIONAL RADIATOR CERTIFICATION TO
FCC PART 15 SUBPART C REQUIREMENT
OF**

Wireless LAN module build in Notebook PC

MODEL No.: CL50, CL51

FCC ID: GKRWM3B2100

REPORT NO: 030018-RF-ID

ISSUE DATE: March 4 2003

Prepared for

**Compal Electronics, Inc.
NO. 581, Juikuang Rd., Neihu,
Taipei (114) Taiwan, R.O.C**

Prepared by

**C&C LABORATORY, CO., LTD.
#B1, 1st Fl., Universal Center,
No. 183, Sec. 1, Tatung Rd., Hsi Chih,
Taipei Hsien, Taiwan, R.O.C.**



TEL: (02)8642-2071~3

FAX: (02)8642-2256



VERIFICATION OF COMPLIANCE

Applicant: Compal Electronics, Inc.
NO. 581, Juikuang Rd., Neihu,
Taipei (114) Taiwan, R.O.C

Product Description: Wireless LAN module build in Notebook PC

Model No.: CL50, CL51

Model Difference All the above models are same except the model designation

Serial Number: N/A

File Number: 030018-RF-ID

Date of test: February 15, 2003 ~March 4, 2003

We hereby certify that:

The above equipment was tested by C&C Laboratory Co., Ltd. The test data , data evaluation , test procedures, and equipment configurations shown in this report were made in accordance with the procedures given in ANSI C63.4 (1992) and the energy emitted by the sample EUT tested as described in this report is in compliance with conducted and radiated emission limits of FCC Rules Part 15.247

The test results of this report relate only to the tested sample identified in this report.

Approved By

A handwritten signature in black ink, appearing to read 'Vincent Su', is written over a horizontal line.

Vincent Su / Vice Manager
C&C Laboratory Co., Ltd..

Table of Contents

1.	GENERAL INFORMATION	5
1.1	PRODUCT DESCRIPTION	5
1.2	RELATED SUBMITTAL(S) / GRANT (S)	5
1.3	TEST METHODOLOGY	5
1.4	TEST FACILITY	5
1.5	SPECIAL ACCESSORIES	5
1.6	EQUIPMENT MODIFICATIONS.....	5
2.	SYSTEM TEST CONFIGURATION	6
2.1	EUT CONFIGURATION	6
2.2	EUT EXERCISE	6
2.3	TEST PROCEDURE	6
2.4	CONFIGURATION OF TESTED SYSTEM	7
4.	DESCRIPTION OF TEST MODES	8
5.	SPURIOUS EMISSION TEST	9
5.1	STANDARD APPLICABLE	9
5.2	EUT SETUP	9
5.3	MEASUREMENT PROCEDURE	9
5.4	TEST SET-UP (BLOCK DIAGRAM OF CONFIGURATION)	10
5.5	MEASUREMENT EQUIPMENT USED:.....	11
5.6	MEASUREMENT RESULT	11
6.	AC POWER LINE CONDUCTED EMISSION TEST	24
6.1	STANDARD APPLICABLE	24
6.2	EUT SETUP	24
6.3	MEASUREMENT PROCEDURE	24
6.4	MEASUREMENT EQUIPMENT USED:.....	25
6.5	MEASUREMENT RESULT	25
7.	6 DB BANDWIDTH MEASUREMENT.....	28
7.1	STANDARD APPLICABLE	28
7.2	MEASUREMENT EQUIPMENT USED:.....	28
7.3	TEST SET-UP:	28
7.4	MEASUREMENT PROCEDURE	29
7.5	MEASUREMENT RESULT	29
8.	PEAK OUTPUT POWER MEASUREMENT	32
8.1	STANDARD APPLICABLE	32
8.2	MEASUREMENT PROCEDURE	32
8.3	MEASUREMENT EQUIPMENT USED:.....	32
8.4	TEST RESULTS:	32



9.	100KHZ BANDWIDTH OF BAND EDGES MEASUREMENT	33
9.1	STANDARD APPLICABLE	33
9.2	MEASUREMENT PROCEDURE	33
9.3	MEASUREMENT RESULT	33
9.4	MEASUREMENT EQUIPMENT USED:.....	33
10.	PEAK POWER SPECTRAL DENSITY	35
10.1	STANDARD APPLICABLE	35
10.2	MEASUREMENT PROCEDURE	35
10.3	MEASUREMENT RESULT	35
10.4	MEASUREMENT EQUIPMENT USED:.....	35
11.	ANTENNA REQUIREMENT	38
11.1	STANDARD APPLICABLE	38
11.2	ANTENNA CONNECTED CONSTRUCTION	38
12.	RF EXPOURE.....	39
12.1	STANDARD APPLICABLE	39
12.2	MEASUREMENT RESULT:	39

1. GENERAL INFORMATION

1.1 Product Description

Compal Electronics, Inc. Model: CL50, CL51 (referred to as the EUT in this report) is a Wireless LAN module built in Notebook. PC. The EUT is compliance with IEEE802.11b Standard.

A major technical descriptions of EUT is described as following:

- A). Operation Frequency: 2.412GHz – 2.462GHz; 11 channels;
- B). Transmit Power: 16dBm (Peak)
- C). Modulation type: Direct Sequence Spread Spectrum, (CCK; DQPSK; DBPSK)
- D). Transition Speed: 1/2/5.5/11Mbps
- E). Antenna Designation: Metal Antenna, +1.28dBi; Non-User Replaceable (Fixed)
- F). Power Supply: MODEL: PA-1600-07
Input: 100~240Vac 50-60Hz 1.5A; Output: 19V, 1.5A

1.2 Related Submittal(s) / Grant (s)

This submittal(s) (test report) is intended for FCC ID: GKRWM3B2100 filing to comply with Section 15.247 of the FCC Part 15, Subpart C Rules. The composite system (digital device) is compliance with Subpart B is authorized under a DoC procedure.

1.3 Test Methodology

Both conducted and radiated testing was performed according to the procedures in ANSI C63.4 (1992). Radiated testing was performed at an antenna to EUT distance 3 meters..

1.4 Test Facility

The open area test site and conducted measurement facility used to collect the radiated data is located on the address of C&C Laboratory, Co., Ltd. No. 81-1, 210 Lane, Pa-de 2nd Road, Lu-Chu Hsiang, Taoyuan, Taiwan, R.O.C.. The Open Area Test Sites and the Line Conducted labs are constructed and calibrated to meet the FCC requirements in documents ANSI C63.4: 1992 and CISPR 22/EN 55022 requirements.

1.5 Special Accessories

Not available for this EUT intended for grant.

1.6 Equipment Modifications

Not available for this EUT intended for grant.

2. SYSTEM TEST CONFIGURATION

2.1 EUT Configuration

The EUT configuration for testing is installed on RF field strength measurement to meet the Commissions requirement and operating in a manner that intends to maximize its emission characteristics in a continuous normal application.

2.2 EUT Exercise

The EUT (Transmitter) was operated in the engineering mode to fix the Tx frequency that was for the purpose of the measurements.

2.3 Test Procedure

2.3.1 Conducted Emissions

The EUT is a placed on as turn table which is 0.8 m above ground plane. According to the requirements in Section 13.1.4.1 of ANSI C63.4-1992. Conducted emissions from the EUT measured in the frequency range between 0.15 MHz and 30MHz using CISPR Quasi-Peak / Average detector mode.

2.3.2 Radiated Emissions

The EUT is a placed on as turn table which is 0.8 m above ground plane. The turn table shall rotate 360 degrees to determine the position of maximum emission level. EUT is set 3m away from the receiving antenna which varied from 1m to 4m to find out the highest emission. And also, each emission was to be maximized by changing the polarization of receiving antenna both horizontal and vertical. In order to find out the max. emission, the relative positions of this hand-held transmitter(EUT) was rotated through three orthogonal axes according to the requirements in Section 13.1.4.1 of ANSI C63.4-1992.

2.4 Configuration of Tested System

Fig. 2-1 Configuration of Tested System

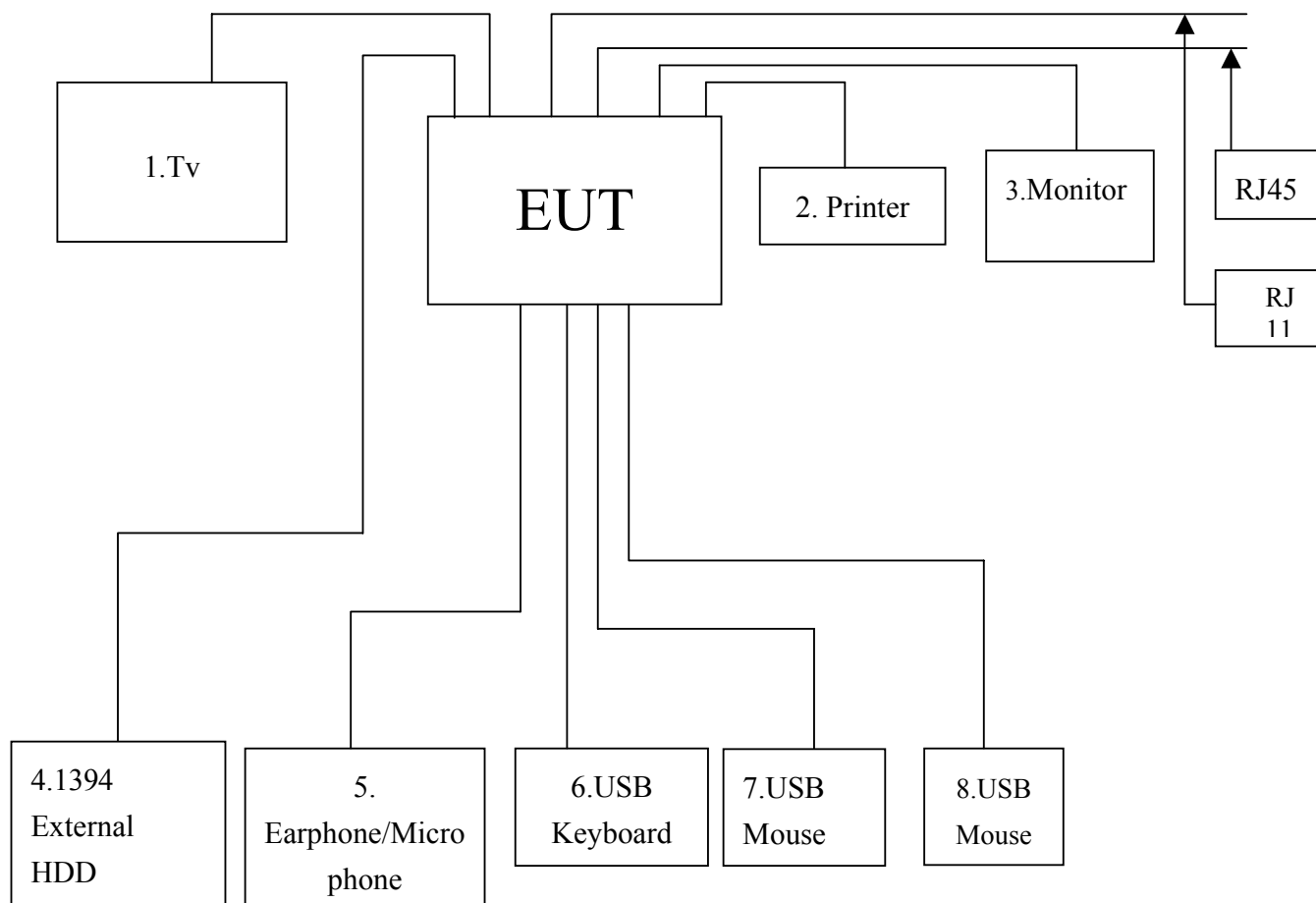

Table 2-1 Equipment Used in Tested System

Item	Equipment	Mfr/Brand	Model/Type No.	FCC ID	Series No.	Note
1.	TV	PROTON	FT-21S	N/A	FT-21S00002CA00 112	
2.	PRINTER	EPSON	P1114A	N/A	CAQY004717	
3.	Monitor	SONY	CPD-G200	FCC DoC	2715884	
4.	1394 External HDD	TSE	FSP024-1ADA21	FCC DoC	N/A	
5.	Earphone/Microp hone	GITON	GT-2004V	FCC DoC	FCC DoC	
6.	USB- KEYBORAD	IBM	SK-8805	FCC DoC	00037822	
7.	USB Mouse	Logitech	M-BB48	FCC DoC	LZE01450987	
8.	USB Mouse	Logitech	M-BB48	FCC DoC	LZE01360732	

3. SUMMARY OF TEST RESULTS

FCC Rules	Description Of Test	Result
§15.209(a) (f)	Spurious Emission	Compliant
§15.207(a)	AC Power Port Conducted Emission	Compliant
§15.247(a)(2)	6dB Bandwidth	Compliant
§15.247(b)	Peak Output Power	Compliant
§15.247(c)	100 KHz Bandwidth Of Frequency Band Edges	Compliant
§15.247(d)	Power Density	Compliant
§15.203	Antenna Requirement	Compliant
§1.1310 and §2.1093	RF exposures	Compliant

4. DESCRIPTION OF TEST MODES

The EUT (Wireless LAN module build in Notebook PC) has been tested under operating condition.

Software used to control the EUT for staying in continuous transmitting and receiving mode is programmed.

Channel 1(2412MHz) 、6(2437MHz) and 11(2462MHz) with 11Mbps highest data rate are chosen for full testing.

5. SPURIOUS EMISSION TEST

5.1 Standard Applicable

According to §15.247(c), all other emissions outside these bands shall not exceed the general radiated emission limits specified in §15.209(a). And according to §15.33(a)(1), for an intentional radiator operates below 10GHz, the frequency range of measurements: to the tenth harmonic of the highest fundamental frequency or to 40GHz, whichever is lower.

5.2 EUT Setup

1. The radiated emission tests were performed in the 3 meter open-test site, using the setup in accordance with the ANSI C63.4-1992.
2. The EUT was put in the front of the test table. The host PC system was placed on the center of the back edge on the test table. The peripherals like modem, monitor printer, K/B, and mouse were placed on the side of the host PC system. The rear of the EUT and peripherals were placed flushed with the rear of the tabletop.
3. The keyboard was placed directly in the front of the monitor, flushed with the front tabletop. The mouse was placed next to the Keyboard, flushed with the back of keyboard.
4. The spacing between the peripherals was 10 centimeters.
5. External I/O cables were draped along the edge of the test table and bundle when necessary.
6. The host PC system was connected with 110Vac/60Hz power source.

5.3 Measurement Procedure

1. The EUT was placed on a turn table which is 0.8m above ground plane.
2. The turn table shall rotate 360 degrees to determine the position of maximum emission level.
3. EUT is set 3m away from the receiving antenna which varied from 1m to 4m to find out the highest emissions.
4. Maximum procedure was performed on the six highest emissions to ensure EUT compliance.
5. And also, each emission was to be maximized by changing the polarization of receiving antenna both horizontal and vertical.
6. Repeat above procedures until all frequency measured were complete.

5.4 Test SET-UP (Block Diagram of Configuration)

(A) Radiated Emission Test Set-Up, Frequency Below 1000MHz

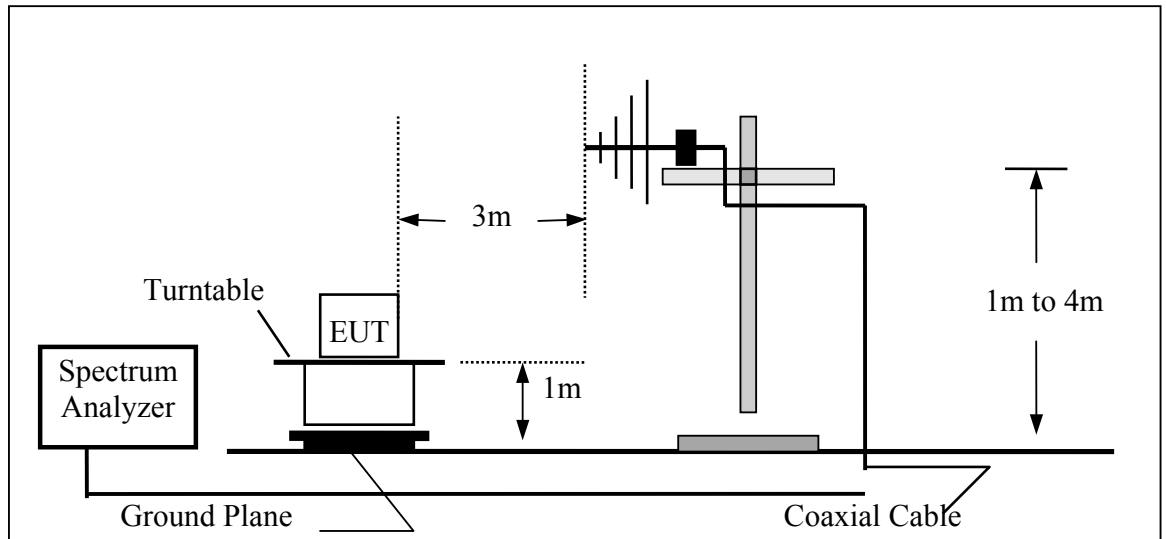

(B) Radiated Emission Test Set-UP Frequency Over 1 GHz

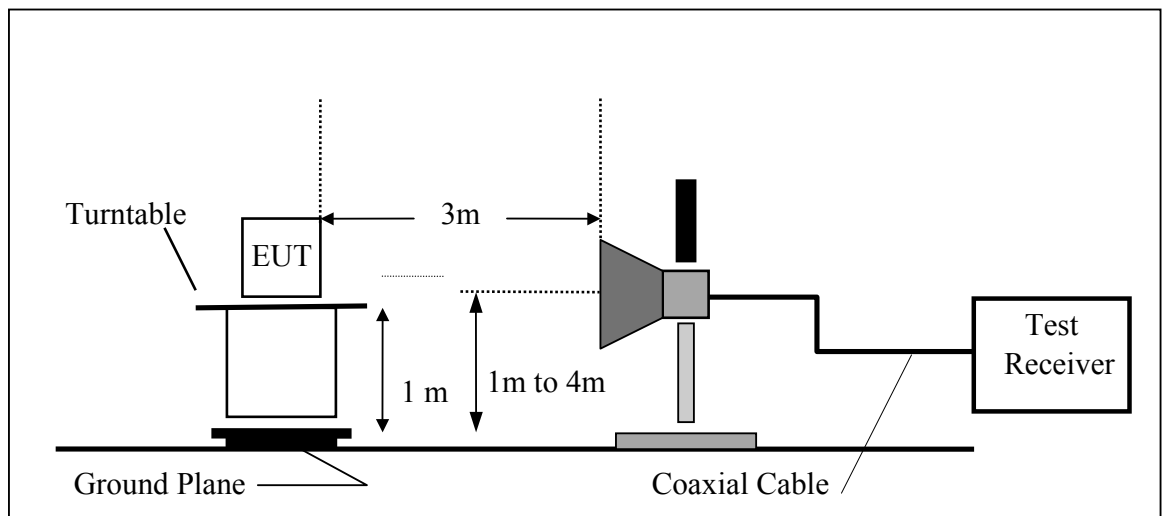

5.5 Measurement Equipment Used:

Open Area Test Site # 3					
EQUIPMENT TYPE	MFR	MODEL NUMBER	SERIAL NUMBER	LAST CAL.	CAL DUE.
Spectrum Analyzer	ADVANTEST	R3261A	N/A	03/19/2002	03/18/2003
Spectrum Analyzer	Advantest	R3182	110600647	11/16/2002	11/15/2003
Spectrum Analyzer	ROHDE & SCHWARZ	FSP30	100112	06/29/2002	06/28/2003
EMI Test Receiver	R&S	ESVS20	838804/004	01/05/2002	01/04/2003
Pre-Amplifier	HP	8447D	2944A09173	03/04/2002	03/03/2003
Bilog Antenna	SCHWAZBECK	VULB9163	145	07/06/2002	07/05/2003
Turn Table	EMCO	2081-1.21	9709-1885	N.C.R	N.C.R
Antenna Tower	EMCO	2075-2	9707-2060	N.C.R	N.C.R
Controller	EMCO	2090	9709-1256	N.C.R	N.C.R
RF Switch	ANRITSU	MP59B	M53867	N.C.R	N.C.R
Site NSA	C&C	N/A	N/A	11/17/2002	11/16/2003
Horn antenna	Schwarzbeck	BBHA 9120	D210	2/24/2003	2/23/2004
Pre-Amplifier	HP	8449B	3008B00965	10/01/2002	10/02/2003

Field Strength Calculation

The field strength is calculated by adding the Antenna Factor and Cable Factor and subtracting the Amplifier Gain and Duty Cycle Correction Factor(if any) from the measured reading. The basic equation with a sample calculation is as follows:

$$FS = RA + AF + CL - AG$$

Where	FS = Field Strength	CL = Cable Attenuation Factor (Cable Loss)
	RA = Reading Amplitude	AG = Amplifier Gain
	AF = Antenna Factor	

5.6 Measurement Result

Refer to attach tabular data sheets.

NOTE:

The resolution bandwidth and video bandwidth of test receiver/spectrum analyzer is 100kHz for Peak detection (PK) and Quasi-peak detection (QP) at frequency below 1GHz.

Conducted Spurious Emission Measurement Result CH Low 30MHz – 10GHz

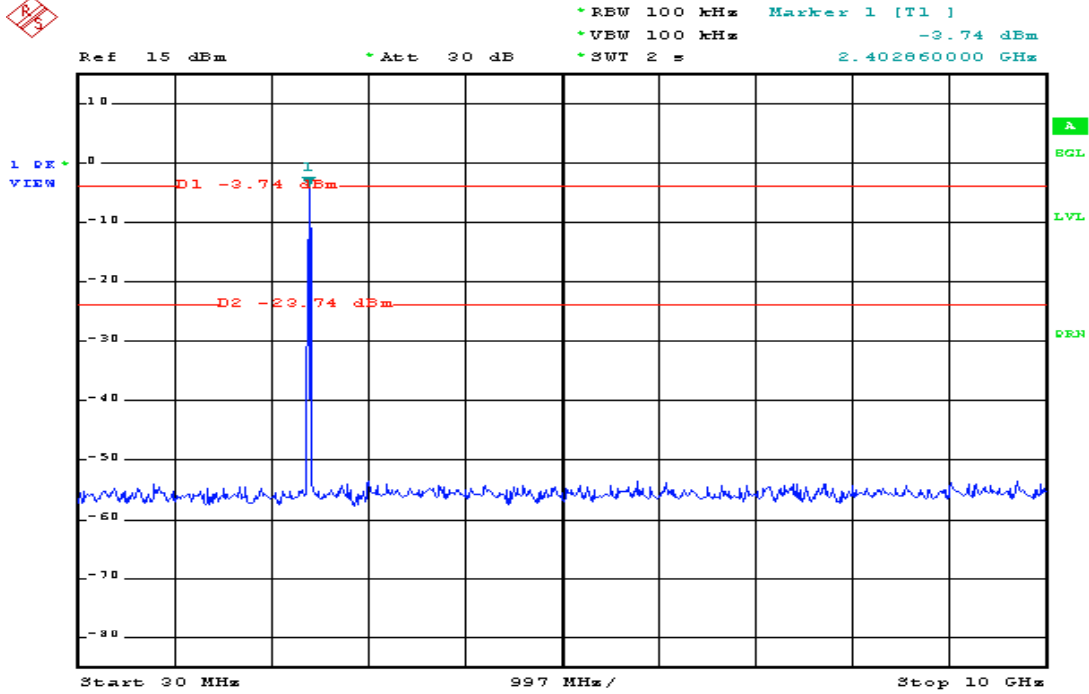

Date: 16.FEB.2003 15:03:32

CH LOW 10GHz – 26GHz

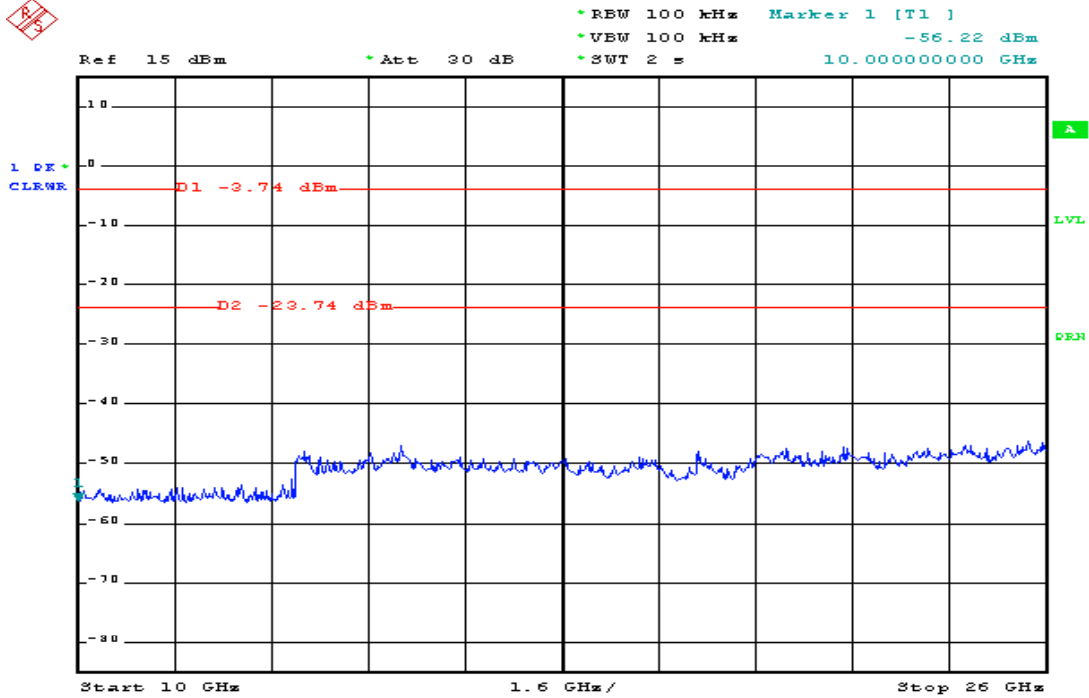

Date: 16.FEB.2003 15:04:15

Conducted Spurious Emission Measurement Result

CH MID 30MHz – 10GHz

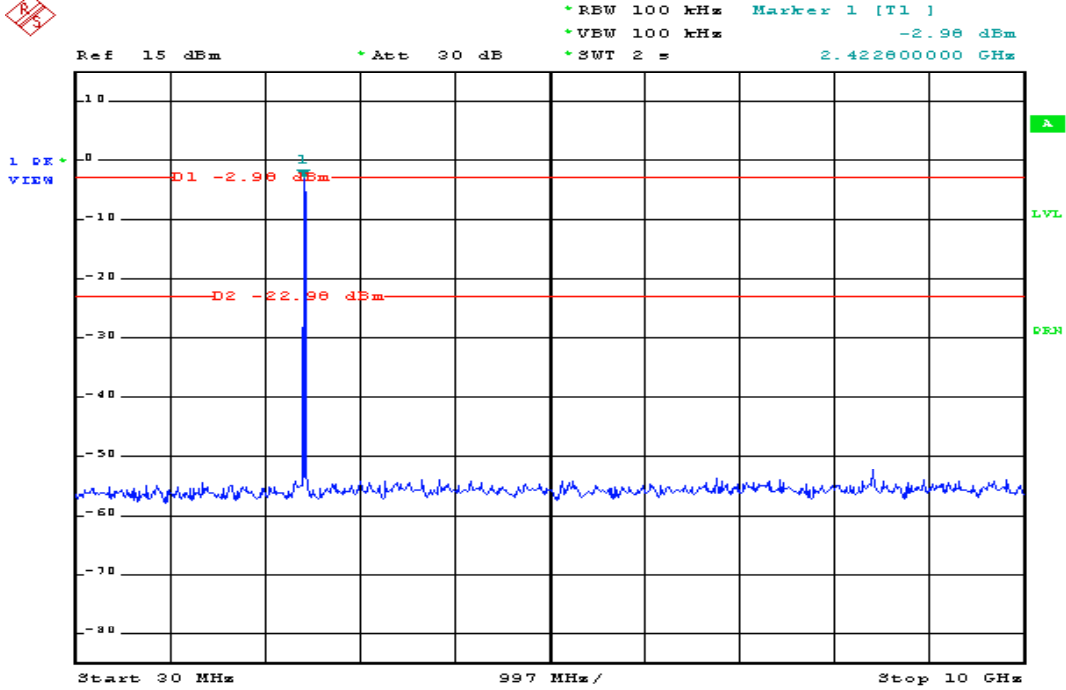

Date: 18.FEB.2003 15:07:29

CH MID 10GHz – 26GHz

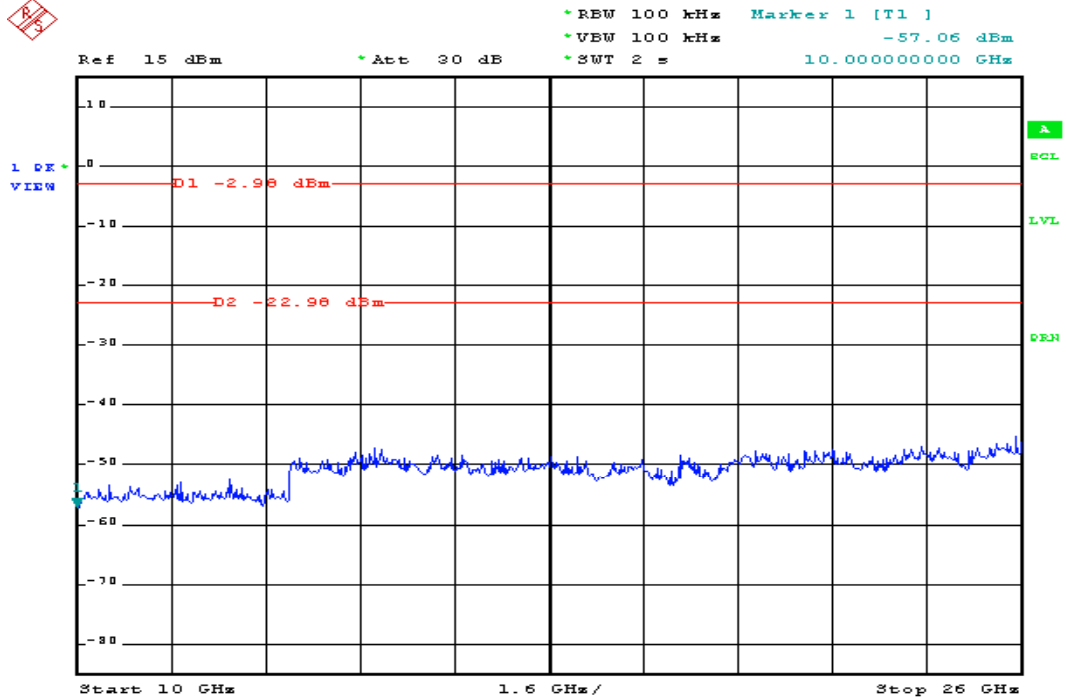

Date: 18.FEB.2003 15:08:26

Conducted Spurious Emission Measurement Result

CH HIGH 30MHz – 10GHz

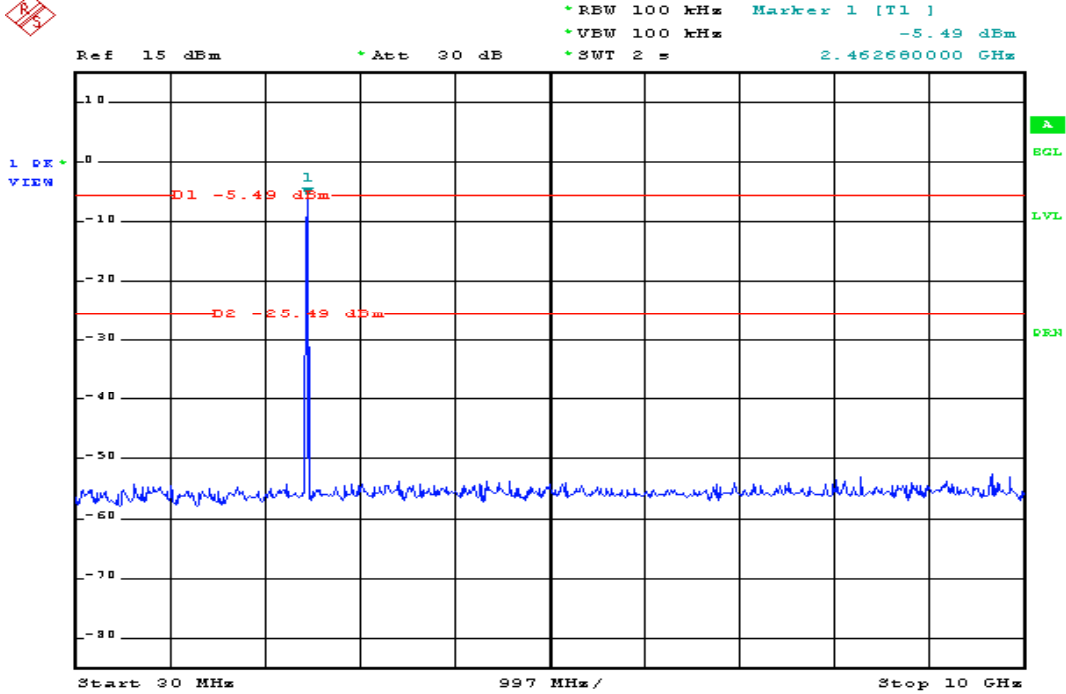

Date: 18.FEB.2003 15:09:44

CH HIGH 10GHz – 26GHz

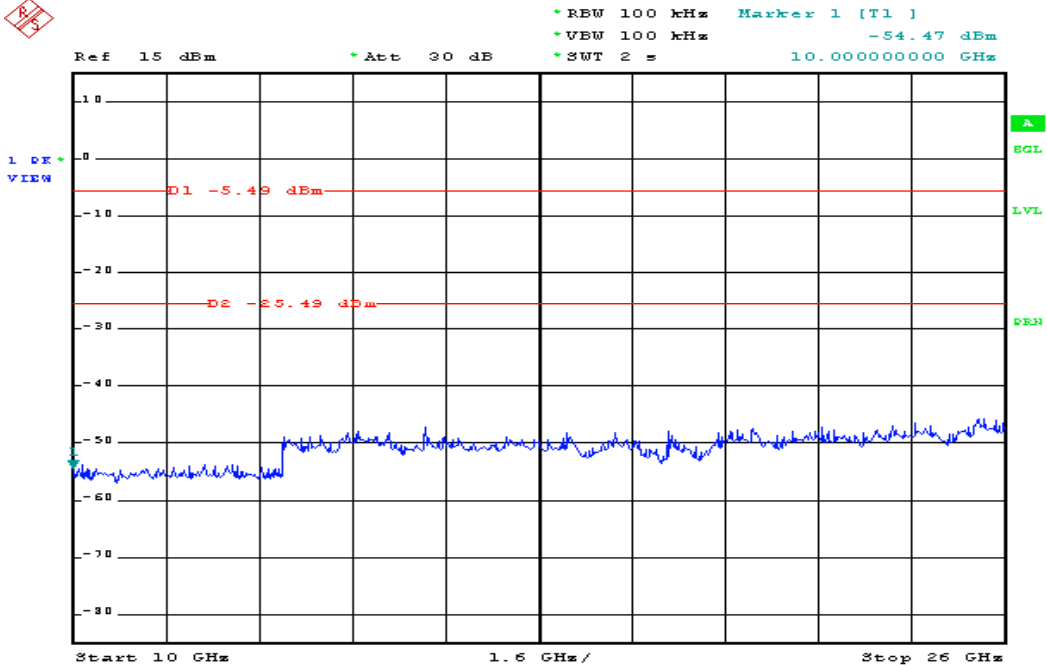

Date: 18.FEB.2003 15:10:17

Radiated Spurious Emission Measurement Result (below 1GHz)

Operation Mode:	TX CH Low	Test Date :	Mar. 3. 2003
Temperature :	23 °C	Test By:	Robin
Humidity :	65 %	Pol:	Ver./Hor

Freq. (MHz)	Ant.Pol. H/V	Detector Mode (PK/QP)	Reading (dBuV)	Ant./CL/ Amp. CF(dB)	Actual FS (dBuV/m)	Limit3m (dBuV/m)	Safe Margin (dB)
176.250	V	Peak	13.86	12.64	26.50	43.50	-17.00
199.200	V	Peak	11.07	14.84	25.91	43.50	-17.59
288.300	V	Peak	11.62	16.23	27.85	46.00	-18.15
321.000	V	Peak	16.52	17.25	33.77	46.00	-12.23
365.330	V	Peak	11.25	18.85	30.10	46.00	-15.90
528.667	V	Peak	3.18	23.52	26.70	46.00	-19.30
787.667	V	Peak	3.68	26.08	29.76	46.00	-16.24
176.250	H	Peak	16.19	12.64	28.83	43.50	-14.67
200.550	H	Peak	7.53	14.93	22.46	43.50	-21.04
289.200	H	Peak	11.13	16.26	27.39	46.00	-18.61
365.330	H	Peak	14.09	18.85	32.94	46.00	-13.06
528.667	H	Peak	7.85	23.52	31.37	46.00	-14.63
597.500	H	Peak	4.93	25.32	30.25	46.00	-15.75
788.830	H	Peak	7.04	26.08	33.12	46.00	-12.88

Remark :

- (1) Measuring frequencies from 30 MHz to the 1GHz °
- (2) Radiated emissions measured in frequency range from 30 MHz to 1000MHz were made with an instrument using Peak/ QP detector mode.
- (3) Datas of measurement within this frequency range shown “ - ” in the table above means the reading of emissions are attenuated more than 20dB below the permissible limits or the field strength is too small to be measured.
- (4) The IF bandwidth of SPA between 30MHz to 1GHz was 100KHz.

Radiated Spurious Emission Measurement Result (below 1GHz)

Operation Mode:	TX CH Mid	Test Date :	Mar. 3. 2003
Temperature :	23 °C	Test By:	Robin
Humidity :	65 %	Pol:	Ver./Hor

Freq. (MHz)	Ant.Pol. H/V	Detector Mode (PK/QP)	Reading (dBuV)	Ant./CL/ Amp. CF(dB)	Actual FS (dBuV/m)	Limit3m (dBuV/m)	Safe Margin (dB)
176.250	V	Peak	14.36	12.64	27.00	43.50	-16.50
199.200	V	Peak	10.57	14.84	25.41	43.50	-18.09
289.650	V	Peak	10.79	16.28	27.07	46.00	-18.93
323.330	V	Peak	16.12	17.31	33.43	46.00	-12.57
366.500	V	Peak	10.69	18.92	29.61	46.00	-16.39
528.670	V	Peak	3.51	23.52	27.03	46.00	-18.97
787.670	V	Peak	3.35	26.08	29.43	46.00	-16.57
176.250	H	Peak	15.52	12.64	28.16	43.50	-15.34
199.200	H	Peak	7.24	14.84	22.08	43.50	-21.42
291.450	H	Peak	10.30	16.35	26.65	46.00	-19.35
366.500	H	Peak	14.53	18.92	33.45	46.00	-12.55
528.670	H	Peak	7.18	23.52	30.70	46.00	-15.30
396.330	H	Peak	4.78	25.29	30.07	46.00	-15.93
786.500	H	Peak	7.68	26.07	33.75	46.00	-12.25

Remark :

- (1) Measuring frequencies from 30 MHz to the 1GHz °
- (2) Radiated emissions measured in frequency range from 30 MHz to 1000MHz were made with an instrument using Peak/ QP detector mode.
- (3) Datas of measurement within this frequency range shown “ - ” in the table above means the reading of emissions are attenuated more than 20dB below the permissible limits or the field strength is too small to be measured.
- (4) The IF bandwidth of SPA between 30MHz to 1GHz was 100KHz.

Radiated Spurious Emission Measurement Result (below 1GHz)

Operation Mode:	TX CH High	Test Date :	Mar. 3. 2003
Temperature :	23 °C	Test By:	Robin
Humidity :	65 %	Pol:	Ver./ Hor.

Freq. (MHz)	Ant.Pol. H/V	Detector Mode (PK/QP)	Reading (dBuV)	Ant./CL/ Amp. CF(dB)	Actual FS (dBuV/m)	Limit3m (dBuV/m)	Safe Margin (dB)
176.250	V	Peak	13.86	12.64	26.50	43.50	-17.00
199.650	V	Peak	11.21	14.86	26.07	43.50	-17.43
291.900	V	Peak	13.15	16.37	29.52	46.00	-16.48
323.330	V	Peak	14.29	17.31	31.60	46.00	-14.40
366.500	V	Peak	10.36	18.92	29.28	46.00	-16.72
787.670	V	Peak	4.35	26.08	30.43	46.00	-15.57
925.330	V	Peak	6.75	28.51	35.26	46.00	-10.74
176.250	H	Peak	16.69	12.64	29.33	43.50	-14.17
200.100	H	Peak	7.52	14.92	22.44	43.50	-21.06
289.650	H	Peak	10.96	16.28	27.24	46.00	-18.76
332.670	H	Peak	14.91	17.32	32.23	46.00	-13.77
366.500	H	Peak	13.36	18.92	32.28	46.00	-13.72
528.670	H	Peak	6.01	23.52	29.53	46.00	-16.47
788.830	H	Peak	6.20	26.08	32.28	46.00	-13.72

Remark :

- (1) Measuring frequencies from 30 MHz to the 1GHz °
- (2) Radiated emissions measured in frequency range from 30 MHz to 1000MHz were made with an instrument using Peak/ QP detector mode.
- (3) Datas of measurement within this frequency range shown “ - ” in the table above means the reading of emissions are attenuated more than 20dB below the permissible limits or the field strength is too small to be measured.
- (4) The IF bandwidth of SPA between 30MHz to 1GHz was 100KHz.

Radiated Spurious Emission Measurement Result (Above 1GHz)

Operation Mode:	TX CH Low	Test Date :	Mar. 3. 2003
Temperature :	23 °C	Test By:	Robin
Humidity :	65 %	Pol:	Vertical

Freq. (MHz)	Peak	AV	Ant./CL CF(dB)	Actual FS		Peak	AV	Margin (dB)
	Reading (dBuV)	Reading (dBuV)		Peak (dBuV/m)	AV (dBuV/m)	Limit (dBuV/m)	Limit (dBuV/m)	
1586.67	45.17	--	-9.01	36.16	--	74.00	54.00	-17.84
1853.33	45.67	--	-8.45	37.22	--	74.00	54.00	-16.78
4824	--	--				74.00	54.00	
7236	--	--				74.00	54.00	
9648	--	--				74.00	54.00	
12060	--	--				74.00	54.00	
14472	--	--				74.00	54.00	
16884	--	--				74.00	54.00	
19296	--	--				74.00	54.00	
21708	--	--				74.00	54.00	
24120	--	--				74.00	54.00	

Remark :

- (1) Measuring frequencies from 1 GHz to the 10th harmonic of highest fundamental frequency °
- (2) Datas of measurement within this frequency range shown “ - ” in the table above means the reading of emissions are attenuated more than 20dB below the permissible limits or the field strength is too small to be measured.
- (3) Radiated emissions measured in frequency above 1000MHz were made with an instrument using Peak detector mode and average detector mode of the emission shown in Actual FS column °
- (4) Spectrum Peak Setting 1GHz- 26GHz, RBW= 1MHz, VBW= 1MHz, Sweep time= 200 ms.
Spectrum AV Setting 1GHz- 26GHz, RBW= 1MHz, VBW= 10Hz, Sweep time= 200 ms.

Radiated Spurious Emission Measurement Result (Above 1GHz)

Operation Mode:	TX CH Low	Test Date :	Mar. 3. 2003
Temperature :	23 °C	Test By:	Robin
Humidity :	65 %	Pol:	Horizontal

Freq. (MHz)	Peak	AV	Ant./CL CF(dB)	Actual FS		Peak	AV	Margin (dB)
	Reading (dBuV)	Reading (dBuV)		Peak (dBuV/m)	AV (dBuV/m)	Limit (dBuV/m)	Limit (dBuV/m)	
1583.33	44.84	--	-9.03	35.81	--	74.00	54.00	-18.19
4824	--					74.00	54.00	
7236	--					74.00	54.00	
9648	--					74.00	54.00	
12060	--					74.00	54.00	
14472	--					74.00	54.00	
16884	--					74.00	54.00	
19296	--					74.00	54.00	
21708	--					74.00	54.00	
24120	--					74.00	54.00	

Remark :

- (1) Measuring frequencies from 1 GHz to the 10th harmonic of highest fundamental frequency °
- (2) Datas of measurement within this frequency range shown “ - ” in the table above means the reading of emissions are attenuated more than 20dB below the permissible limits or the field strength is too small to be measured.
- (3) Radiated emissions measured in frequency above 1000MHz were made with an instrument using Peak detector mode and average detector mode of the emission shown in Actual FS column °
- (4) Spectrum Peak Setting 1GHz- 26GHz, RBW= 1MHz, VBW= 1MHz, Sweep time= 200 ms.
Spectrum AV Setting 1GHz- 26GHz, RBW= 1MHz, VBW= 10Hz, Sweep time= 200 ms.

Radiated Spurious Emission Measurement Result (Above 1GHz)

Operation Mode:	TX CH Mid	Test Date :	Mar. 3. 2003
Temperature :	22 °C	Test By:	Robin
Humidity :	65%	Pol:	Vertical

Freq. (MHz)	Peak	AV	Ant./CL CF(dB)	Actual FS		Peak	AV	Margin (dB)
	Reading (dBuV)	Reading (dBuV)		Peak (dBuV/m)	AV (dBuV/m)	Limit (dBuV/m)	Limit (dBuV/m)	
1580	44.00	--	-9.04	34.96	--	74.00	54.00	-19.04
1920	44.67	--	-8.25	36.42	--	74.00	54.00	-17.58
5233	42.84	--	0.48	43.32	--	74.00	54.00	-10.68
2437								
4874	--					74.00	54.00	
7311	--					74.00	54.00	
9748	--					74.00	54.00	
12185	--					74.00	54.00	
14622	--					74.00	54.00	
17059	--					74.00	54.00	
19496	--					74.00	54.00	
21933	--					74.00	54.00	
24370	--					74.00	54.00	

Remark :

- (1) Measuring frequencies from 1 GHz to the 10th harmonic of highest fundamental frequency °
- (2) Datas of measurement within this frequency range shown “ - ” in the table above means the reading of emissions are attenuated more than 20dB below the permissible limits or the field strength is too small to be measured.
- (3) Radiated emissions measured in frequency above 1000MHz were made with an instrument using Peak detector mode and average detector mode of the emission shown in Actual FS column °
- (4) Spectrum Peak Setting 1GHz- 26GHz, RBW= 1MHz, VBW= 1MHz, Sweep time= 200 ms.
Spectrum AV Setting 1GHz- 26GHz, RBW= 1MHz, VBW= 10Hz, Sweep time= 200 ms.

Radiated Spurious Emission Measurement Result (Above 1GHz)

Operation Mode:	TX CH Mid	Test Date :	Mar. 3. 2003
Temperature :	22 °C	Test By:	Robin
Humidity :	65%	Pol:	Horizontal

Freq. (MHz)	Peak	AV	Ant./CL CF(dB)	Actual FS		Peak	AV	Margin (dB)
	Reading (dBuV)	Reading (dBuV)		Peak (dBuV/m)	AV (dBuV/m)	Limit (dBuV/m)	Limit (dBuV/m)	
1576	43.67	--	-9.05	34.62	--	74.00	54.00	-19.38
4874	--					74.00	54.00	
7311	--					74.00	54.00	
9748	--					74.00	54.00	
12185	--					74.00	54.00	
14622	--					74.00	54.00	
17059	--					74.00	54.00	
19496	--					74.00	54.00	
21933	--					74.00	54.00	
24370	--					74.00	54.00	

Remark :

- (1) Measuring frequencies from 1 GHz to the 10th harmonic of highest fundamental frequency °
- (2) Datas of measurement within this frequency range shown “ - ” in the table above means the reading of emissions are attenuated more than 20dB below the permissible limits or the field strength is too small to be measured.
- (3) Radiated emissions measured in frequency above 1000MHz were made with an instrument using Peak detector mode and average detector mode of the emission shown in Actual FS column °
- (4) Spectrum Peak Setting 1GHz- 26GHz, RBW= 1MHz, VBW= 1MHz, Sweep time= 200 ms.
Spectrum AV Setting 1GHz- 26GHz, RBW= 1MHz, VBW= 10Hz, Sweep time= 200 ms.

Radiated Spurious Emission Measurement Result (Above 1GHz)

Operation Mode:	TX CH High	Test Date :	Mar. 3. 2003
Temperature :	22 °C	Test By:	Robin
Humidity :	65%	Pol:	Vertital

Freq. (MHz)	Peak	AV	Ant./CL CF(dB)	Actual FS		Peak	AV	Margin (dB)
	Reading (dBuV)	Reading (dBuV)		Peak (dBuV/m)	AV (dBuV/m)	Limit (dBuV/m)	Limit (dBuV/m)	
4924	--					74.00	54.00	
7386	--					74.00	54.00	
9848	--					74.00	54.00	
12310	--					74.00	54.00	
14772	--					74.00	54.00	
17234	--					74.00	54.00	
19696	--					74.00	54.00	
22158	--					74.00	54.00	
24620	--					74.00	54.00	

Remark :

- (1) Measuring frequencies from 1 GHz to the 10th harmonic of highest fundamental frequency °
- (2) Datas of measurement within this frequency range shown “ - ” in the table above means the reading of emissions are attenuated more than 20dB below the permissible limits or the field strength is too small to be measured.
- (3) Radiated emissions measured in frequency above 1000MHz were made with an instrument using Peak detector mode and average detector mode of the emission shown in Actual FS column °
- (4) Spectrum Peak Setting 1GHz- 26GHz, RBW= 1MHz, VBW= 1MHz, Sweep time= 200 ms.
Spectrum AV Setting 1GHz- 26GHz, RBW= 1MHz, VBW= 10Hz, Sweep time= 200 ms.

Radiated Spurious Emission Measurement Result (Above 1GHz)

Operation Mode:	TX CH High	Test Date :	Mar. 3. 2003
Temperature :	22 °C	Test By:	Robin
Humidity :	65%	Pol:	Horizontal

Freq. (MHz)	Peak	AV	Ant./CL CF(dB)	Actual FS		Peak	AV	Margin (dB)
	Reading (dBuV)	Reading (dBuV)		Peak (dBuV/m)	AV (dBuV/m)	Limit (dBuV/m)	Limit (dBuV/m)	
4924	--					74.00	54.00	
7386	--					74.00	54.00	
9848	--					74.00	54.00	
12310	--					74.00	54.00	
14772	--					74.00	54.00	
17234	--					74.00	54.00	
19696	--					74.00	54.00	
22158	--					74.00	54.00	
24620	--					74.00	54.00	

Remark :

- (1) Measuring frequencies from 1 GHz to the 10th harmonic of highest fundamental frequency °
- (2) Datas of measurement within this frequency range shown “ - ” in the table above means the reading of emissions are attenuated more than 20dB below the permissible limits or the field strength is too small to be measured.
- (3) Radiated emissions measured in frequency above 1000MHz were made with an instrument using Peak detector mode and average detector mode of the emission shown in Actual FS column °
- (4) Spectrum Peak Setting 1GHz- 26GHz, RBW= 1MHz, VBW= 1MHz, Sweep time= 200 ms.
Spectrum AV Setting 1GHz- 26GHz, RBW= 1MHz, VBW= 10Hz, Sweep time= 200 ms.

6. AC POWER LINE CONDUCTED EMISSION TEST

6.1 Standard Applicable

According to §15.207. frequency within 150KHz to 30MHz shall not exceed

Frequency range MHz	Limits dB(uV)	
	Quasi-peak	Average
0.15 to 0.50	66 to 56	56 to 46
0.50 to 5	56	46
5 to 30	60	50

Note

- 1.The lower limit shall apply at the transition frequencies
- 2.The limit decreases linearly with the logarithm of the frequency in the range 0.15 MHz to 0.50 MHz.

6.2 EUT Setup

1. The conducted emission tests were performed in the test site, using the setup in accordance with the ANSI C63.4-1992.
2. The EUT was plug-in the host PC via USB port. The host PC system was placed on the center of the back edge on the test table. The peripherals like modem, monitor printer, K/B, and mouse were placed on the side of the host PC system. The rear of the EUT and peripherals were placed flushed with the rear of the tabletop.
3. The keyboard was placed directly in the front of the monitor, flushed with the front tabletop. The mouse was placed next to the Keyboard, flushed with the back of keyboard.
4. The spacing between the peripherals was 10 centimeters.
5. External I/O cables were draped along the edge of the test table and bundle when necessary.
6. The host PC system was connected with 110Vac/60Hz power source.

6.3 Measurement Procedure

1. The EUT was placed on a table which is 0.8m above ground plane.
2. Maximum procedure was performed on the six highest emissions to ensure EUT compliance.
3. Repeat above procedures until all frequency measured were complete.

6.4 Measurement Equipment Used:

Conducted Emission Test Site # 3					
EQUIPMENT TYPE	MFR	MODEL NUMBER	SERIAL NUMBER	LAST CAL.	CAL DUE.
EMI Test Receiver	R&S	ESHS30	828144/003	08/08/2002	08/07/2003
LISN	R&S	ESH2-Z5	843285/010	10/17/2002	10/16/2003
LISN	EMCO	3825/2	9003-1628	07/26/2002	07/25/2003
Spectrum Analyzer	ADVANTEST	R3261A	91720031	N/A	N/A
2X2 WIRE ISN	R&S	ENY22	100020	06/20/2002	06/19/2003
FOUR WIRE ISN	R&S	ENY41	100006	06/20/2002	06/19/2003

6.5 Measurement Result

The initial step in collecting conducted data is a spectrum analyzer peak scan of the measurement range. Significant peaks are then marked as shown on the following data page, and these signals are then quasi-peaked.

Operation Mode: TX + RX Mode
 Temperature : 24 °C
 Power Adaptor PA-1600-07

Test Date : Feb.15. 2003
 Test By: Robin
 _Humidity : 62%

FREQ MHz	Q.P. Raw dBuV	AVG Raw dBuV	Q.P. Limit dBuV	AVG Limit dBuV	Q.P. Margin dB	AVG Margin dB	NOTE
0.152	55.10	40.30	65.89	55.89	-10.79	-15.59	L1
0.235	48.70	---	62.27	52.27	-13.57	---	L1
0.308	36.70	---	60.02	50.02	-23.32	---	L1
0.436	37.40	---	57.14	47.14	-19.74	---	L1
4.703	32.50	---	56.00	46.00	-23.50	---	L1
22.571	33.00	---	60.00	50.00	-27.00	---	L1
0.153	56.10	40.80	65.84	55.84	-9.74	-15.04	L2
0.228	47.70	---	62.52	52.52	-14.82	---	L2
0.308	36.10	---	60.02	50.02	-23.92	---	L2
0.511	32.30	---	56.00	46.00	-23.70	---	L2
4.819	32.20	---	56.00	46.00	-23.80	---	L2
20.829	34.10	---	60.00	50.00	-25.90	---	L2

Remark :

- (1) Measuring frequencies from 0.15 MHz to 30MHz °
- (2) The emissions measured in frequency range from 0.15 MHz to 30MHz were made with an instrument using Qusia-Peak detector and Average detector.
- (3) “---” denotes the emission level was or more than 2dB below the Average limit, so no re-check anymore.
- (4) The IF bandwidth of SPA between 0.15MHz to 30MHz was 10KHz;
The IF bandwidth of Test Receiver between 0.15MHz to 30MHz was 9KHz;
- (5) L1 = Line One (Hot side) / L2 = Line Two (Neutral side)

Conducted Test Data

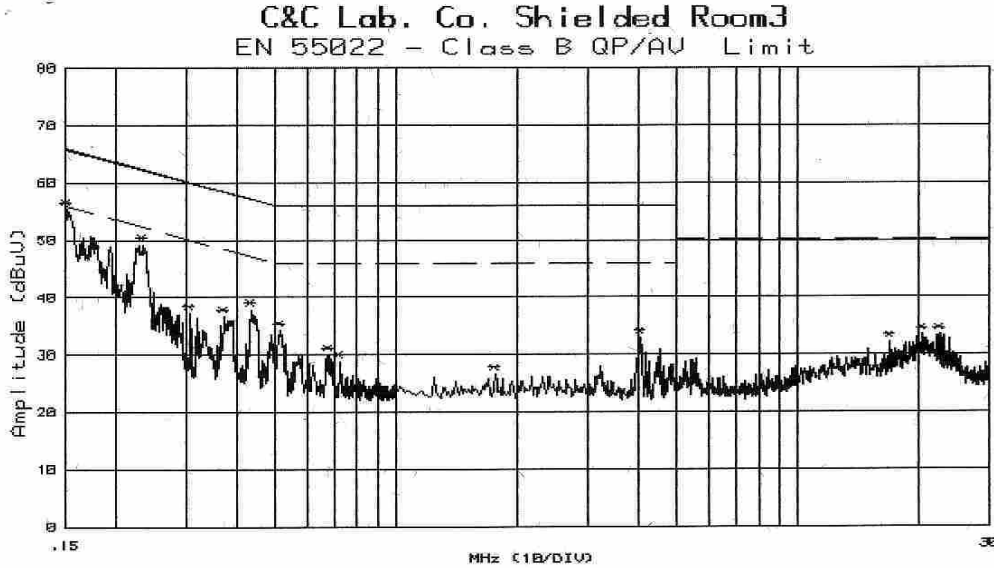

Customer: Compal
Model : PRO2100
Mode :
Reading : Peak (R3261C SPA)
Remark : 110V

File#: 1178
Humd.: 68 (%)
Port : L1

Date : 15 Feb 2003 13:59:16
Temp. : 22 (C)
Tested by: Robin

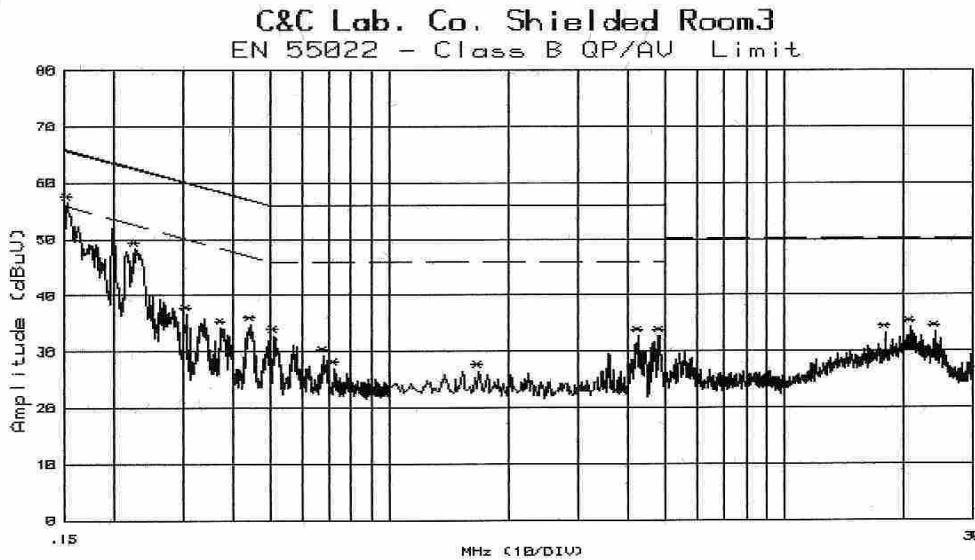

Customer: Compal
Model : PRO2100
Mode :
Reading : Peak (R3261C SPA)
Remark : 110V

File#: 1179
Humd.: 68 (%)
Port : L2

Date : 15 Feb 2003 14:01:42
Temp. : 22 (C)
Tested by: Robin

7. 6 dB Bandwidth Measurement

7.1 Standard Applicable

According to § 15.247(a)(2), DSSS Systems operating in the 2400MHz-2483.5 MHz and 5725MHz – 5850MHz bands. The Minimum 6dB bandwidth shall be at least 500KHz.

7.2 Measurement Equipment Used:

EQUIPMENT TYPE	MFR	Model No.	Serial No.	LAST CAL.	Cal. Due.
Spectrum Analyzer	Advantest	R3182	110600647	11/16/2002	11/15/2003
Spectrum Analyzer	R&S	FSP30	1093.4495.30	07/23/2002	07/22/2003
low loss cable	Huber + Suhner	Sucoflex 104	N/A	N/A	N/A

7.3 Test Set-up:

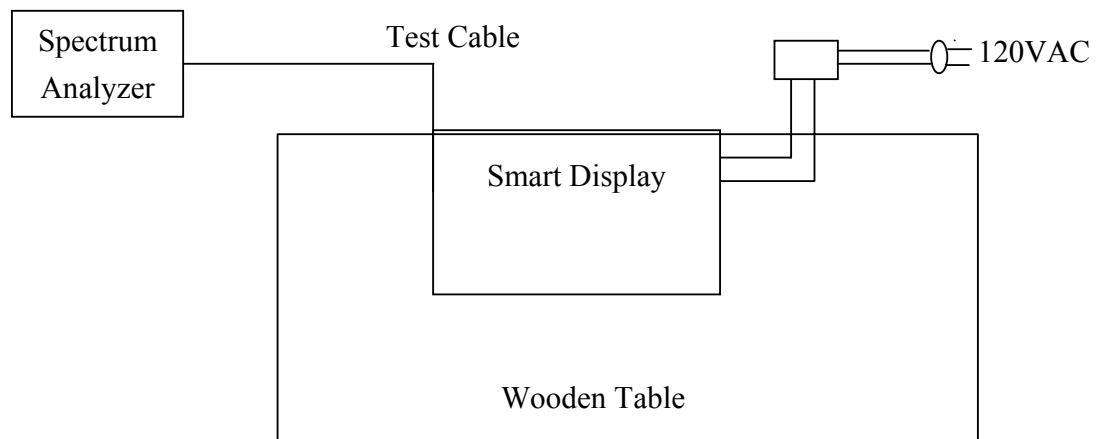

Fig. 4

Fig. 4 : Measurement setup for testing on Antenna connector



7.4 Measurement Procedure

1. Place the EUT on the table and set it in transmitting mode.
2. Remove the antenna from the EUT and then connect a low loss RF cable from the antenna port to the spectrum analyzer.
3. Set the spectrum analyzer as RBW=100KHz, VBW = RBW, Span= 50MHz, Sweep=auto
4. Mark the peak frequency and -6dB (upper and lower) frequency.
5. Repeat above procedures until all frequency measured were complete.

7.5 Measurement Result

CH	Bandwidth (MHz)	Bandwidth (KHz)	Result
Low	11.8	> 500	PASS
Mid	11.9	> 500	PASS
High	11.8	> 500	PASS

6dB Band Width Test Data CH-LOW

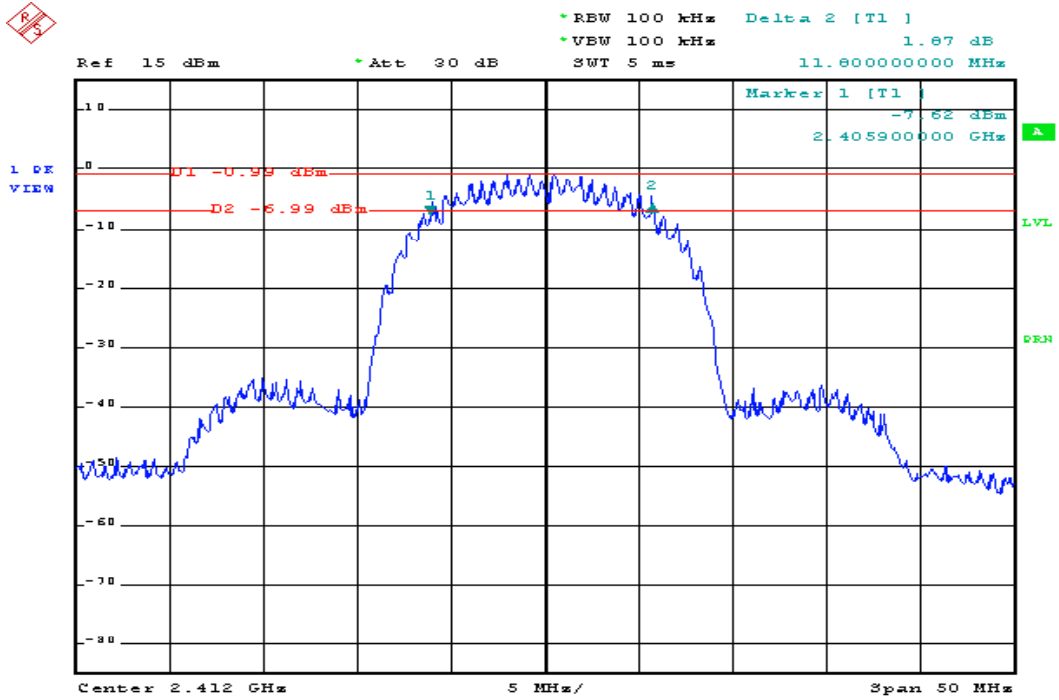

Date: 18.FEB.2003 13:45:59

6dB Band Width Test Data CH-MID

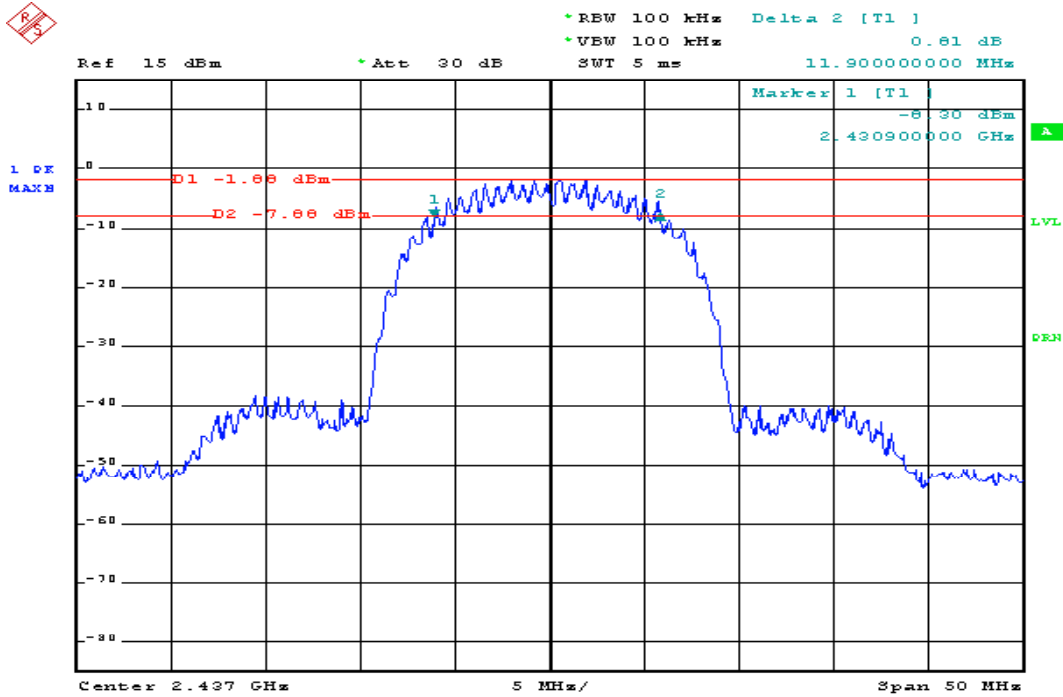

Date: 18.FEB.2003 13:44:15

6dB Band Width Test Data CH-HIGH

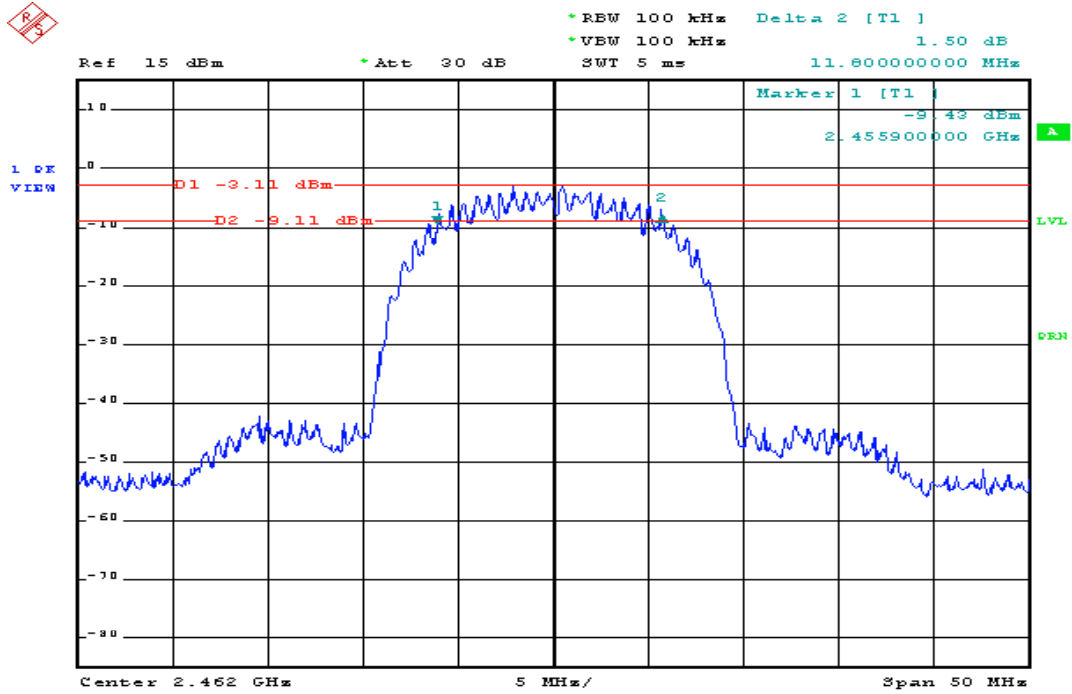

Date: 18.FEB.2003 13:42:33

8. PEAK OUTPUT POWER MEASUREMENT

8.1 Standard Applicable

According to §15.247(b)(2), for direct sequence systems, the maximum peak output power of the intentional radiator shall not exceed 1 Watt.

8.2 Measurement Procedure

1. Place the EUT on the table and set it in transmitting mode.
2. Remove the antenna from the EUT and then connect a low loss RF cable from the antenna port to the power meter or spectrum. (Channel power function, RBW, VBW = 1MHz, Bandwidth=26dB occupied Bandwidth)
3. Record the max. reading.
4. Repeat above procedures until all frequency measured were complete.

8.3 Measurement Equipment Used:

EQUIPMENT TYPE	MFR	Model No.	Serial No.	LAST CAL.	Cal. Due.
Power meter	Boonton	4531	130601	01/10/2003	30/9/2004
low loss cable	Huber + Suhner	Sucoflex 104	N/A	N/A	N/A

8.4 Test Results:

CH	Reading Power dBm	Cable Loss dB	Output Power dBm	Output Power W	Limit (W)	Result
LOW	15.60	1.00	16.60	0.04571	1	PASS
MID	15.50	1.00	16.50	0.04467	1	PASS
HIGH	15.10	1.00	16.10	0.04074	1	PASS

9. 100KHz BANDWIDTH OF BAND EDGES MEASUREMENT

9.1 Standard Applicable

According to §15.247(c), in any 100 KHz bandwidth outside the frequency bands in which the spread spectrum intentional radiator is operating, the radio frequency power that is produced by the intentional radiator shall be at least 20dB below that in the 100KHz bandwidth within the band that contains the highest level of the desired power, In addition, radiated emissions which fall in the restricted bands, as defined in §15.205(a), must also comply with the radiated emission limits specified in 15.209(a).

9.2 Measurement Procedure

1. Place the EUT on the table and set it in transmitting mode.
2. Remove the antenna from the EUT and then connect a low loss RF cable from the antenna port to the spectrum analyzer.
3. Set center frequency of spectrum analyzer = operating frequency.
4. Set the spectrum analyzer as RBW, VBW=100KHz, Center Freq. 2.39GHz, 2.4835GHz, Span=50MHz, Sweep = auto.
5. Mark Peak 2.4GHz and 2.4835GHz and record the max. level.
6. Repeat above procedures until all frequency measured were complete.

9.3 Measurement Result

Refer to attach spectrum analyzer data chart.

9.4 Measurement Equipment Used:

EQUIPMENT TYPE	MFR	Model No.	Serial No.	LAST CAL.	Cal. Due.
Spectrum Analyzer	Advantest	R3182	110600647	11/16/2002	11/15/2003
Spectrum Analyzer	R&S	FSP30	1093.4495.30	07/23/2002	07/22/2003
low loss cable	Huber + Suhner	Sucoflex 104	N/A	N/A	N/A

Out of Band Test Data CH-LOW

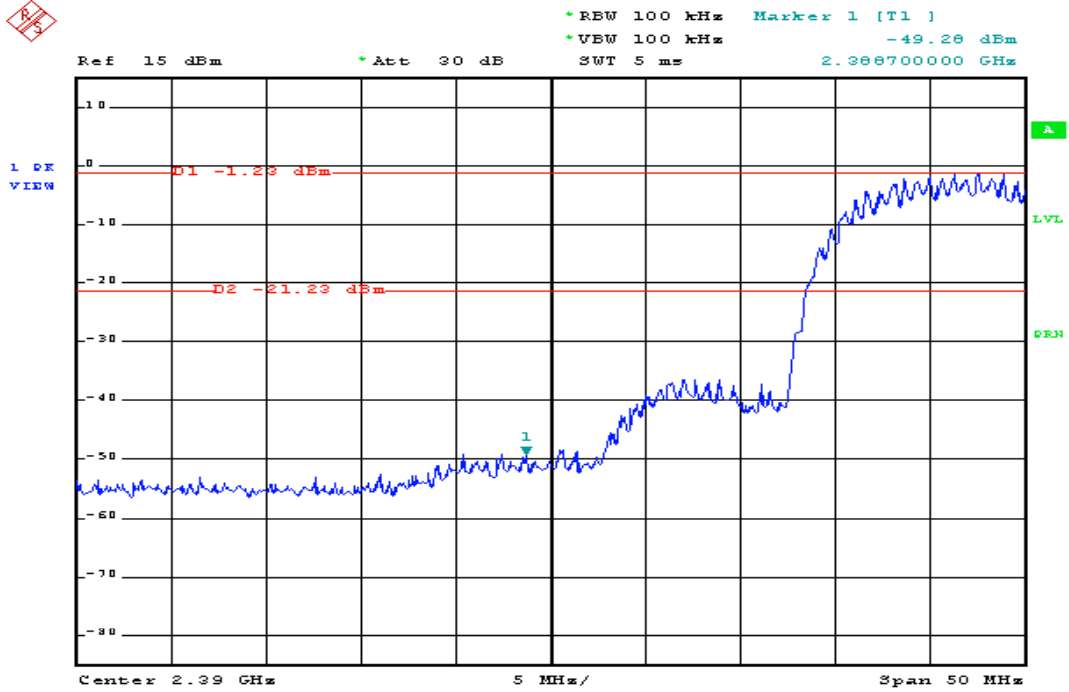

Date: 18.FEB.2003 14:14:17

Out of Band Test Data CH-HIGH

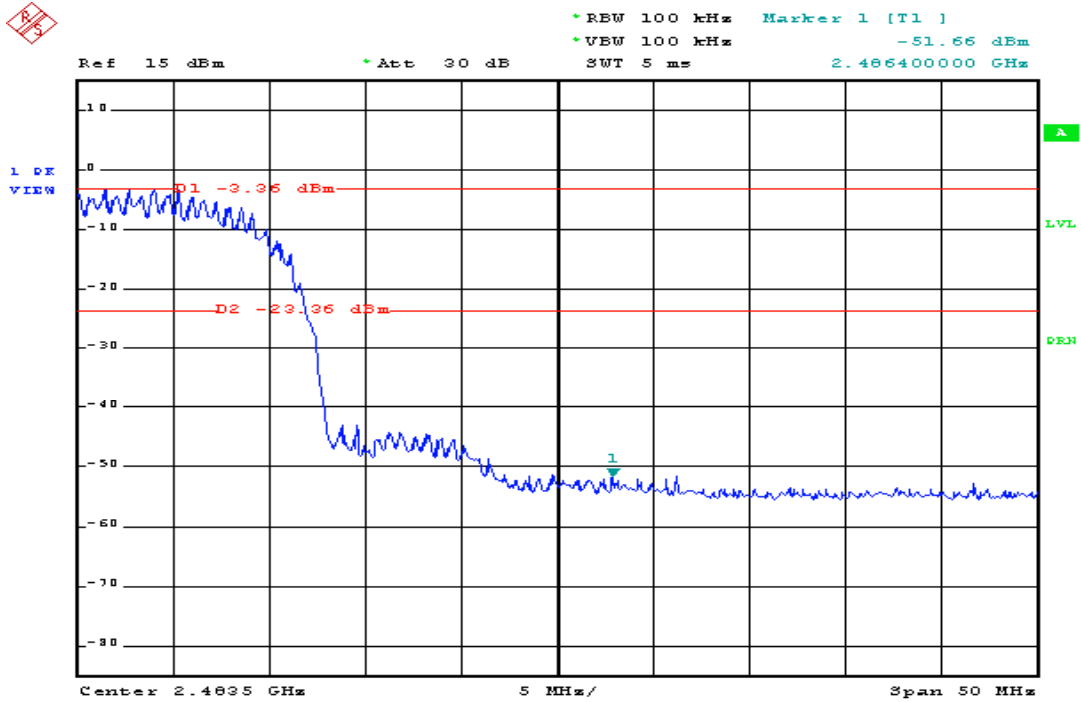

Date: 18.FEB.2003 14:12:05

10. Peak Power Spectral Density

10.1 Standard Applicable

According to §15.247(d), for direct sequence systems, the peak power spectral density conducted from the intentional radiator to the antenna shall not be greater than 8 dBm in any 3kHz band during any time interval of continuous transmission.

10.2 Measurement Procedure

1. Place the EUT on the table and set it in transmitting mode.
2. Remove the antenna from the EUT and then connect a low loss RF cable from the antenna port to the spectrum analyzer.
3. Set the spectrum analyzer as RBW = 3KHz, VBW = 3KHz, Span = 300KHz, Sweep=100s
4. Record the max. reading.
5. Repeat above procedures until all frequency measured were complete.

10.3 Measurement Result

	Reading dBm	Cable Loss dB	Density dBm	Limint dBm	Result
CH-LOW	-9.56	1.00	-8.56	8	PASS
CH-MID	-10.56	1.00	-9.56	8	PASS
CH-HIGH	-11.01	1.00	-10.01	8	PASS

10.4 Measurement Equipment Used:

EQUIPMENT TYPE	MFR	Model No.	Serial No.	LAST CAL.	Cal. Due.
Spectrum Analyzer	Advantest	R3182	110600647	11/16/2002	11/15/2003
Spectrum Analyzer	R&S	FSP30	1093.4495.30	07/23/2002	07/22/2003
low loss cable	Huber + Suhner	Sucoflex 104	N/A	N/A	N/A



Power Density Test Data CH-LOW

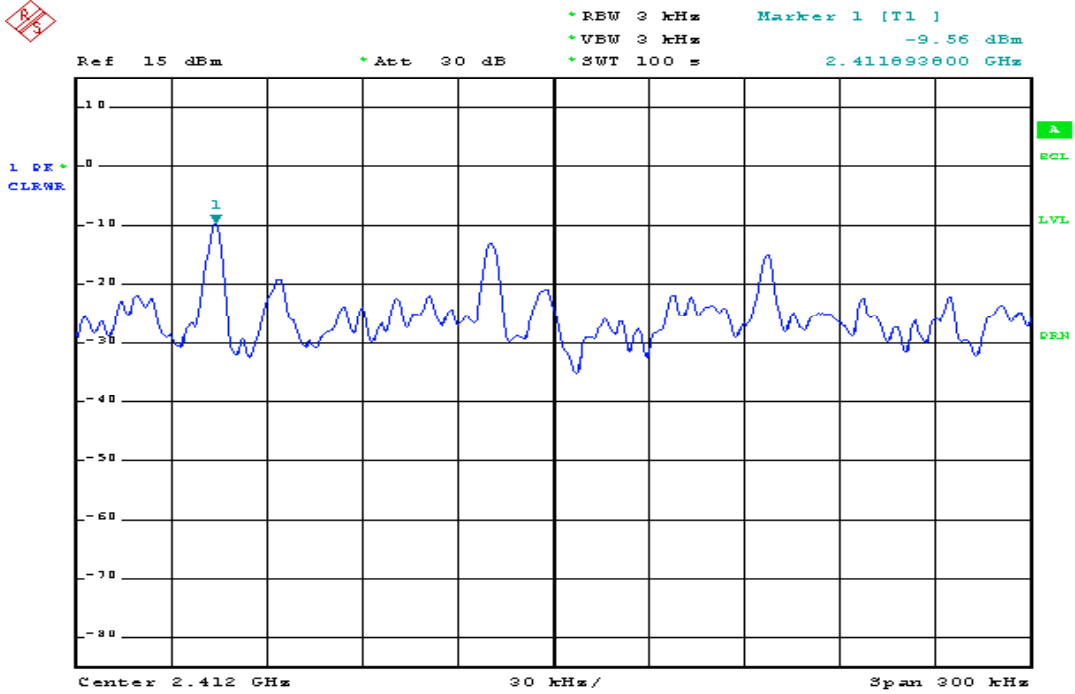

Date: 18.FEB.2003 13:52:54

Power Density Test Data CH-MID

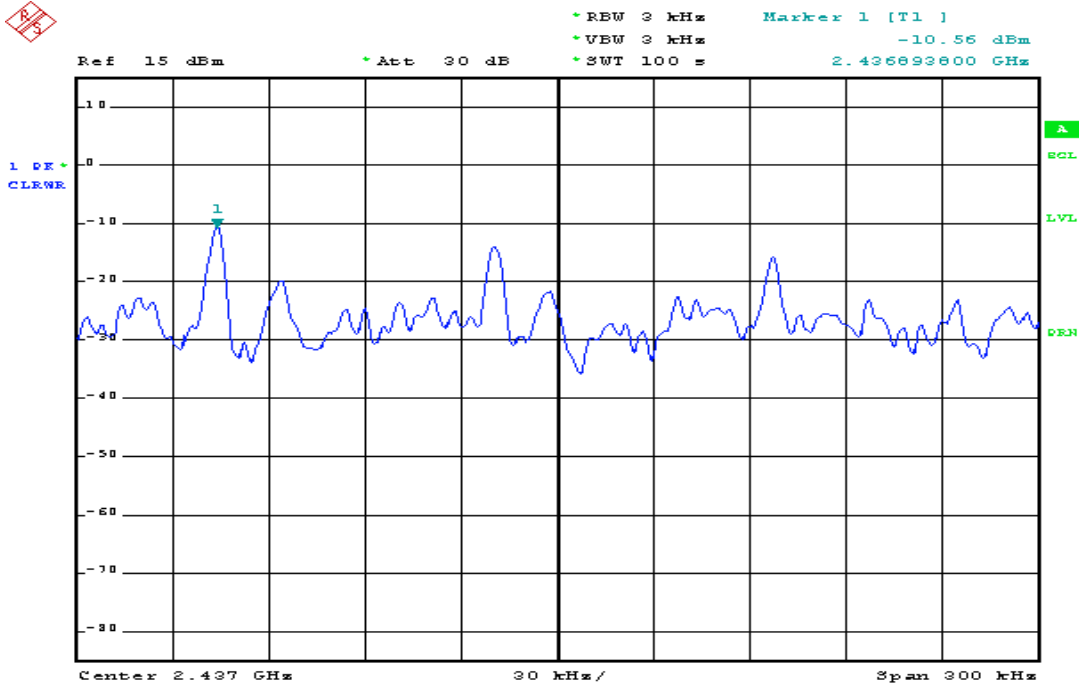

Date: 18.FEB.2003 13:57:39

Power Density Test Data CH-HIGH

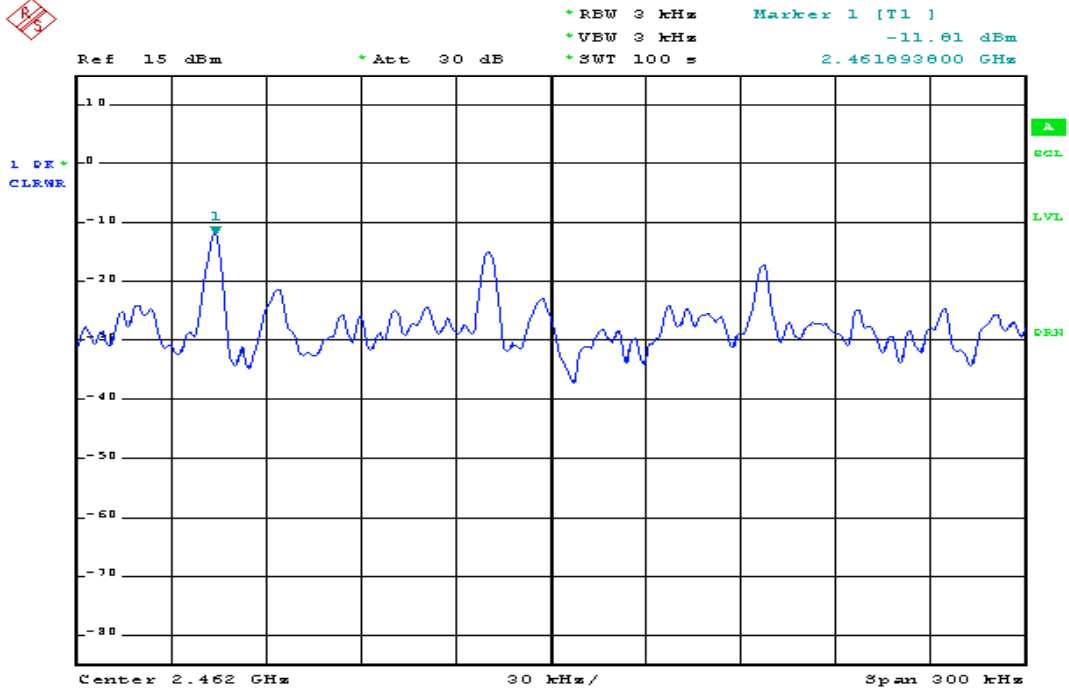

Date: 16.FEB.2003 14:01:34

11. ANTENNA REQUIREMENT

11.1 Standard Applicable

For intentional device, according to §15.203, an intentional radiator shall be designed to ensure that no antenna other than furnished by the responsible party shall be used with the device.

And according to §15.247(i), if transmitting antennas of directional gain greater than 6dBi are used the power shall be reduced by the amount in 1dB that the directional gain of the antenna exceeds 6 dBi.

11.2 Antenna Connected Construction

The directional gains of antenna used for transmitting is +1.28 dBi, and the antenna connector is designed with permanent attachment and no consideration of replacement by end user. Please see EUT photo for details.

12. RF Expoure

12.1 Standard Applicable

According to §15.247(b)(4) and §1.1307(b)(1), systems operating under the provisions of this section shall be operated in a manner that ensure that the public is not exposed to radio frequency energy level in excess of the Commission's guideline.

The device is classed as a portable device.

12.2 Measurement Result:

The SAR test report was attached.