



FCC 47 CFR PART 15 SUBPART C

TEST REPORT

For

Compal Electronics Inc.

Wireless LAN module built in Notebook PC

Model: CL32

Trade Name: acer; Compal

Prepared for

**Compal Electronics Inc.
No. 581, Jui Kuang Rd., Neihu,
Taipei, (114) Taiwan, R.O.C.**

Prepared by

**Compliance Certification Services Inc.
No. 81-1, Lane 210, Bade Rd. 2, Luchu Hsiang,
Taoyuan Hsien, (338) Taiwan, R.O.C.
TEL: 886-3-324-0332
FAX: 886-3-324-5235**



Note: This report shall not be reproduced except in full, without the written approval of Compliance Certification Services Inc. This document may be altered or revised by Compliance Certification Services Inc. personnel only, and shall be noted in the revision section of the document.



TABLE OF CONTENTS

1. TEST RESULT CERTIFICATION..... 3

2. EUT DESCRIPTION..... 4

3. TEST METHODOLOGY 5

3.1 EUT CONFIGURATION 5

3.2 EUT EXERCISE 5

3.3 GENERAL TEST PROCEDURES 5

3.4 FCC PART 15.205 RESTRICTED BANDS OF OPERATIONS 6

3.5 DESCRIPTION OF TEST MODES 6

4. INSTRUMENT CALIBRATION..... 7

5. FACILITIES AND ACCREDITATIONS 8

5.1 FACILITIES..... 8

5.2 EQUIPMENT 8

5.3 LABORATORY ACCREDITATIONS AND LISTING 8

5.4 TABLE OF ACCREDITATIONS AND LISTINGS 9

6. SETUP OF EQUIPMENT UNDER TEST 10

6.1 SUPPORT EQUIPMENT 10

7. FCC PART 15.247 REQUIREMENTS..... 11

7.1 6DB BANDWIDTH..... 11

7.2 PEAK POWER 14

7.3 BAND EDGES MEASUREMENT..... 17

7.4 PEAK POWER SPECTRAL DENSITY 22

7.5 RADIO FREQUENCY EXPOSURE..... 25

7.6 RADIATED EMISSIONS 26

7.7 POWERLINE CONDUCTED EMISSIONS 38



1. TEST RESULT CERTIFICATION

| | |
|------------------------------|---|
| Applicant: | Compal Electronics Inc. No. 581, Jui Kuang Rd., Neihu, Taipei, (114) Taiwan, R.O.C. |
| Equipment Under Test: | Wireless LAN module built in Notebook PC |
| Trade Name: | acer; Compal |
| Model: | CL32 |
| Model Difference | N/A |
| Report Number: | B30827205-RP |
| Date of Test: | September 3 ~ 6, 2003 |

| APPLICABLE STANDARDS | |
|-----------------------|-------------------------|
| STANDARD | TEST RESULT |
| FCC Part 15 Subpart C | No non-compliance noted |

We hereby certify that:

The above equipment was tested by Compliance Certification Services Inc. The test data, data evaluation, test procedures, and equipment configurations shown in this report were made in accordance with the procedures given in ANSI C63.4 (1992) and the energy emitted by the sample EUT tested as described in this report is in compliance with conducted and radiated emission limits of FCC Rules Part 15.247.

The test results of this report relate only to the tested sample identified in this report.

Approved by:

Reviewed by:

Jonson Lee
 Director of Linkou Laboratory
 Compliance Certification Services Inc.

Eric Wong
 Section Manager
 Compliance Certification Services Inc.



2. EUT DESCRIPTION

| | |
|-----------------------------------|---|
| Product | Wireless LAN module built in Notebook PC |
| Trade Name | acer; Compal |
| Model Number | CL32 |
| Power Adapter Manufacturer | Delta |
| Power Adapter Model | ADP-65DB |
| Power Rating | Powered by Power Adapter I/P: 100-240VAC, 50-60Hz, 1.5A O/P: 19VDC, 3.42A |
| Frequency Range | 2412 ~ 2462 MHz |
| Transmit Power | 16.26dBm |
| Modulation Technique | DSSS (CCK; DQPSK; DBPSK) |
| Transmitting Speed | 1/2/5.5/11 Mbps |
| Number of Channels | 11 |
| Antenna Gain | 1.31dBi (Max) |
| Antenna Designation | Metal PIFA Antenna |

Note: This submittal(s) (test report) is intended for FCC ID: GKRWM3B0B32 filing to comply with Section 15.247 of the FCC Part 15, Subpart C Rules. The composite system (digital device) is compliance with Subpart B is authorized under a DoC procedure.



3. TEST METHODOLOGY

The tests documented in this report were performed in accordance with ANSI C63.4 and FCC CFR 47 2.1046, 2.1047, 2.1049, 2.1051, 2.1053, 2.1055, 2.1057, and 15.247.

3.1 EUT CONFIGURATION

The EUT configuration for testing is installed on RF field strength measurement to meet the Commissions requirement and operating in a manner that intends to maximize its emission characteristics in a continuous normal application.

3.2 EUT EXERCISE

The EUT (Wireless LAN module built in Notebook PC) was operated in the engineering mode to fix the TX frequency that was for the purpose of the measurements.

According to its specifications, the EUT must comply with the requirements of the Section 15.247 under the FCC Rules Part 15 Subpart C. The composite system (Digital device) is compliance with the Subpart B is authorized under the DoC procedure.

3.3 GENERAL TEST PROCEDURES

Conducted Emissions

The EUT is placed on the turntable, which is 0.8 m above ground plane. According to the requirements in Section 13.1.4.1 of ANSI C63.4-1992. Conducted emissions from the EUT measured in the frequency range between 0.15 MHz and 30MHz using CISPR Quasi-peak and average detector modes.

Radiated Emissions

The EUT is placed on a turn table, which is 0.8 m above ground plane. The turntable shall rotate 360 degrees to determine the position of maximum emission level. EUT is set 3m away from the receiving antenna, which varied from 1m to 4m to find out the highest emission. And also, each emission was to be maximized by changing the polarization of receiving antenna both horizontal and vertical. In order to find out the max. emission, the relative positions of this hand-held transmitter (EUT) was rotated through three orthogonal axes according to the requirements in Section 13.1.4.1 of ANSI C63.4-1992.



3.4 FCC PART 15.205 RESTRICTED BANDS OF OPERATIONS

(a) Except as shown in paragraph (d) of this section, only spurious emissions are permitted in any of the frequency bands listed below:

| MHz | MHz | MHz | GHz |
|----------------------------|---------------------|-----------------|------------------|
| 0.090 - 0.110 | 16.42 - 16.423 | 399.9 - 410 | 4.5 - 5.15 |
| ¹ 0.495 - 0.505 | 16.69475 - 16.69525 | 608 - 614 | 5.35 - 5.46 |
| 2.1735 - 2.1905 | 16.80425 - 16.80475 | 960 - 1240 | 7.25 - 7.75 |
| 4.125 - 4.128 | 25.5 - 25.67 | 1300 - 1427 | 8.025 - 8.5 |
| 4.17725 - 4.17775 | 37.5 - 38.25 | 1435 - 1626.5 | 9.0 - 9.2 |
| 4.20725 - 4.20775 | 73 - 74.6 | 1645.5 - 1646.5 | 9.3 - 9.5 |
| 6.215 - 6.218 | 74.8 - 75.2 | 1660 - 1710 | 10.6 - 12.7 |
| 6.26775 - 6.26825 | 108 - 121.94 | 1718.8 - 1722.2 | 13.25 - 13.4 |
| 6.31175 - 6.31225 | 123 - 138 | 2200 - 2300 | 14.47 - 14.5 |
| 8.291 - 8.294 | 149.9 - 150.05 | 2310 - 2390 | 15.35 - 16.2 |
| 8.362 - 8.366 | 156.52475 - | 2483.5 - 2500 | 17.7 - 21.4 |
| 8.37625 - 8.38675 | 156.52525 | 2655 - 2900 | 22.01 - 23.12 |
| 8.41425 - 8.41475 | 156.7 - 156.9 | 3260 - 3267 | 23.6 - 24.0 |
| 12.29 - 12.293 | 162.0125 - 167.17 | 3332 - 3339 | 31.2 - 31.8 |
| 12.51975 - 12.52025 | 167.72 - 173.2 | 3345.8 - 3358 | 36.43 - 36.5 |
| 12.57675 - 12.57725 | 240 - 285 | 3600 - 4400 | (²) |
| 13.36 - 13.41 | 322 - 335.4 | | |

¹ Until February 1, 1999, this restricted band shall be 0.490-0.510 MHz.

² Above 38.6

(b) Except as provided in paragraphs (d) and (e), the field strength of emissions appearing within these frequency bands shall not exceed the limits shown in Section 15.209. At frequencies equal to or less than 1000 MHz, compliance with the limits in Section 15.209 shall be demonstrated using measurement instrumentation employing a CISPR quasi-peak detector. Above 1000 MHz, compliance with the emission limits in Section 15.209 shall be demonstrated based on the average value of the measured emissions. The provisions in Section 15.35 apply to these measurements.

3.5 DESCRIPTION OF TEST MODES

The EUT has been tested with both antenna 1 & 2 (as specified in the internal photos) separately under operating condition and the data recorded in the report is the worst one with antenna 2.

Software used to control the EUT for staying in continuous transmitting and receiving mode is programmed.

Channel 1 (2412MHz), Channel 6 (2437MHz) and Channel 11 (2462MHz) with 11Mbps highest data rate (worst case) are chosen for the final testing.



4. INSTRUMENT CALIBRATION

The measuring equipment, which was utilized in performing the tests documented herein, has been calibrated in accordance with the manufacturer's recommendations for utilizing calibration equipment, which is traceable to recognized national standards.



5. FACILITIES AND ACCREDITATIONS

5.1 FACILITIES

All measurement facilities used to collect the measurement data are located at

No. 81-1, Lane 210, Bade Rd. 2, Luchu Hsiang, Taoyuan Hsien, Taiwan, R.O.C.

No. 199, Chunghsen Road, Hsintien City, Taipei Hsien, Taiwan, R.O.C.

The sites are constructed in conformance with the requirements of ANSI C63.7, ANSI C63.4 and CISPR Publication 22.

5.2 EQUIPMENT

Radiated emissions are measured with one or more of the following types of linearly polarized antennas: tuned dipole, biconical, log periodic, bi-log, and/or ridged waveguide, horn. Spectrum analyzers with pre-selectors and quasi-peak detectors are used to perform radiated measurements.

Conducted emissions are measured with Line Impedance Stabilization Networks and EMI Test Receivers.







Calibrated wideband preamplifiers, coaxial cables, and coaxial attenuators are also used for making measurements.

All receiving equipment conforms to CISPR Publication 16-1, "Radio Interference Measuring Apparatus and Measurement Methods."

5.3 LABORATORY ACCREDITATIONS AND LISTING

The test facilities used to perform radiated and conducted emissions tests are accredited by National Voluntary Laboratory Accreditation Program for the specific scope of accreditation under Lab Code: 200600-0 to perform Electromagnetic Interference tests according to FCC PART 15 AND CISPR 22 requirements. No part of this report may be used to claim or imply product endorsement by NVLAP or any agency of the US Government. In addition, the test facilities are listed with Federal Communications Commission (registration no: 93105 and 90471).

5.4 TABLE OF ACCREDITATIONS AND LISTINGS

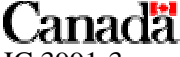
| Country | Agency | Scope of Accreditation | Logo |
|---------|-----------------|---|---|
| USA | NVLAP* | EN 55011, EN 55014-1, AS/NZS 1044, CNS 13783-1, EN 55022, CNS 13438, EN 61000-3-2, EN 61000-3-3, ANSI C63.4, FCC OST/MP-5, AS/NZS 3548 IEC 61000-4-2, IEC 61000-4-3, IEC 61000-4-4, IEC 61000-4-5, IEC 61000-4-6, IEC 61000-4-8, IEC 61000-4-11 |  200600-0 |
| USA | FCC | 3/10 meter Open Area Test Sites to perform FCC Part 15/18 measurements |  93105, 90471 |
| Japan | VCCI | 4 3/10 meter Open Area Test Sites to perform conducted/radiated measurements |  R-393/1066/725/879 C-402/747/912 |
| Norway | NEMKO | EN 50081-1/2, EN 50082-1/2, IEC 61000-6-1/2, EN 50091-2, EN 50130-4, EN 55011, EN 55013, EN 55014-1/2, EN 55015, EN 55022, EN 55024, EN 61000-3-2/3, EN 61326-1, IEC 61000-4-2/3/4/5/6/8/11, EN 60601-1-2, EN 300 328-2, EN 300 422-2, EN 301 419-1, EN 301 489-01/03/07/08/09/17, EN 301 419-2/3, EN 300 454-2, EN 301 357-2 |  ELA 124a ELA 124b ELA 124c |
| Taiwan | CNLA | EN 300 328-1, EN 300 328-2, EN 300 220-1, EN 300 220-2, EN 300 220-3, 47 CFR FCC Part 15 Subpart C, EN 61000-3-2, EN 61000-3-3, CNS 13439, CNS 13783-1, CNS 14115, CNS 13438, AS/NZS 3548, CNS 13022-1, IEC 1000-4-3/4/5/6/8/11, CNS 13022-2/3 |  0363 ILAC MRA |
| Taiwan | BSMI | CNS 13438, CNS 13783-1, CNS 13439, CNS 14115 |  SL2-IS-E-0014 SL2-IN-E-0014 SL2-A1-E-0014 SL2-R1-E-0014 SL2-R2-E-0014 SL2-L1-E-0014 |
| Canada | Industry Canada | RSS212, Issue 1 |  IC 3991-3 IC 3991-4 |

* No part of this report may be used to claim or imply product endorsement by NVLAP or any agency of the US Government.

6. SETUP OF EQUIPMENT UNDER TEST

6.1 SUPPORT EQUIPMENT

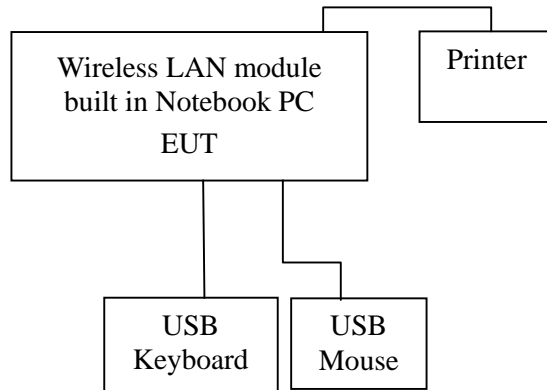

| Device Type | Brand | Model | FCC ID | Series No. | Data Cable | Power Cord |
|--------------|----------|------------|----------|-------------|----------------|------------------|
| Printer | ESPON | STYLUS C60 | DoC | DR3K041995 | Shielded, 1.8m | Unshielded, 1.8m |
| USB Keyboard | IBM | KU-9958 | 3982A185 | 0004195 | Shielded, 1.8m | N/A |
| USB Mouse | Logitech | M-BB48 | 4872A221 | LZE92250102 | Shielded, 1.8m | N/A |

Notes:

1. All the equipment/cables were placed in the worst-case configuration to maximize the emission during the test.
2. Grounding was established in accordance with the manufacturer's requirements and conditions for the intended use.



7. FCC PART 15.247 REQUIREMENTS

7.16DB BANDWIDTH

LIMIT

For the direct sequence systems, the minimum 6dB bandwidth shall be at least 500kHz.

MEASUREMENT EQUIPMENT USED

| Name of Equipment | Manufacturer | Model | Serial Number | Calibration Due |
|-------------------|----------------|--------------|---------------|-----------------|
| Spectrum Analyzer | Agilent | E4446A | US42510252 | 04/28/2004 |
| Low Loss RF Cable | Huber + Suhner | Sucoflex 104 | N/A | N/A |

Remark: Each piece of equipment is scheduled for calibration once a year.

Test Configuration

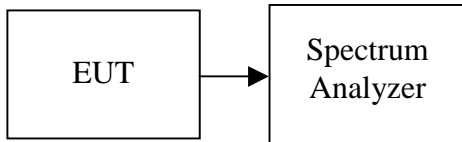

TEST PROCEDURE

1. Place the EUT on the table and set it in the transmitting mode.
2. Remove the antenna from the EUT and then connect a low loss RF cable from the antenna port to the spectrum analyzer.
3. Set the spectrum analyzer as RBW=100kHz, VBW = RBW, Span = 20MHz, Sweep = auto.
4. Mark the peak frequency and -6dB (upper and lower) frequency.
5. Repeat until all the rest channels are investigated.

TEST RESULTS

No non-compliance noted

Test Data

| Channel | Frequency (MHz) | Bandwith (kHz) | Limit (kHz) | Margin (MHz) |
|---------|-----------------|----------------|-------------|--------------|
| Low | 2412 | 12470 | 500 | Pass |
| Mid | 2437 | 12430 | | Pass |
| High | 2462 | 12870 | | Pass |



Test Plot

6dB Bandwidth – Ch Low

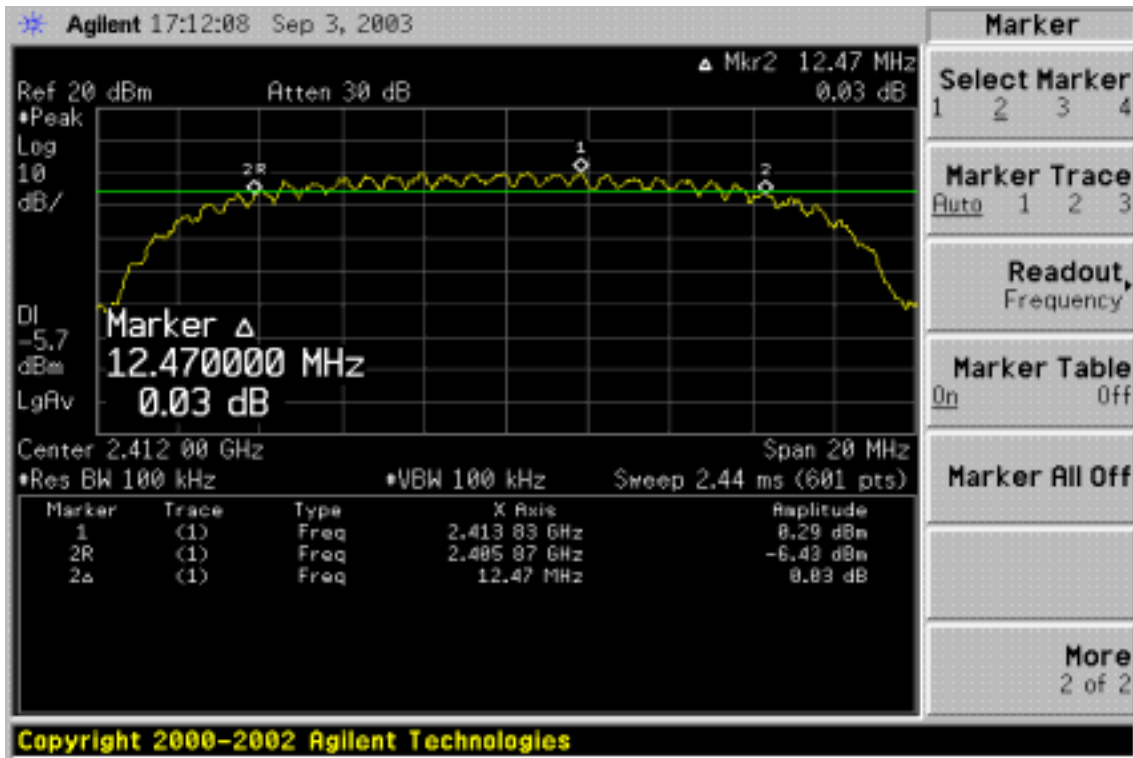

6dB Bandwidth – Ch Mid

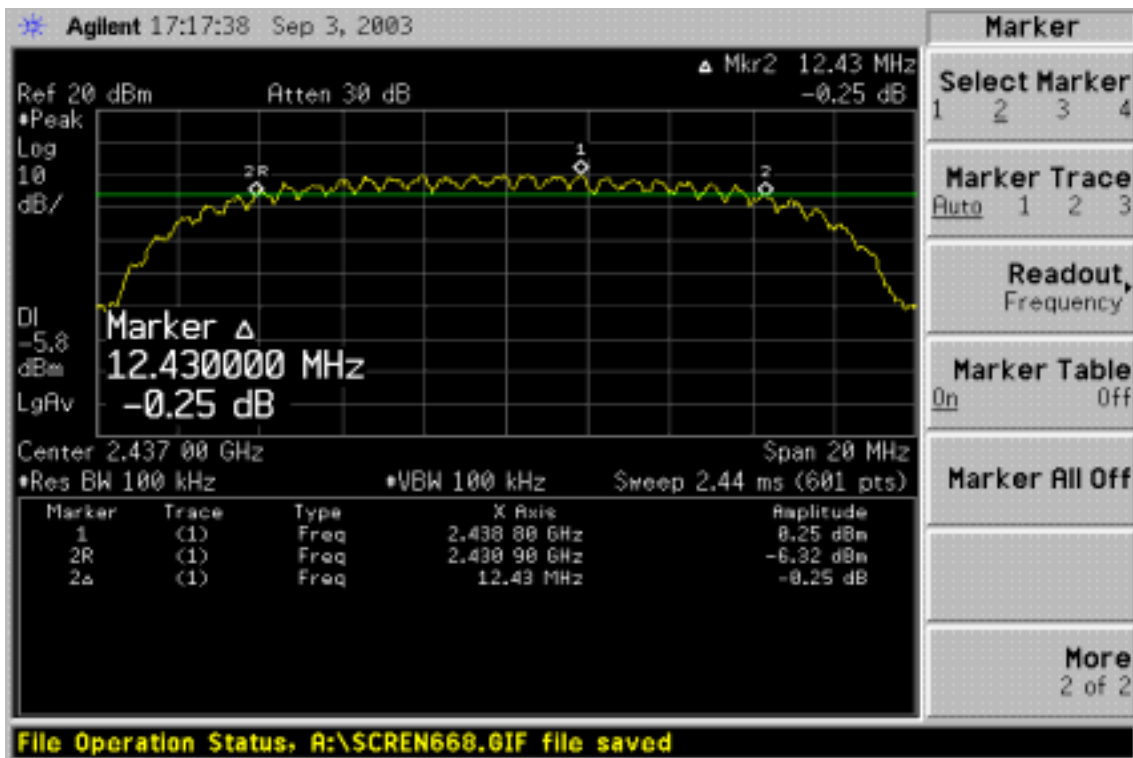



6dB Bandwidth – Ch High

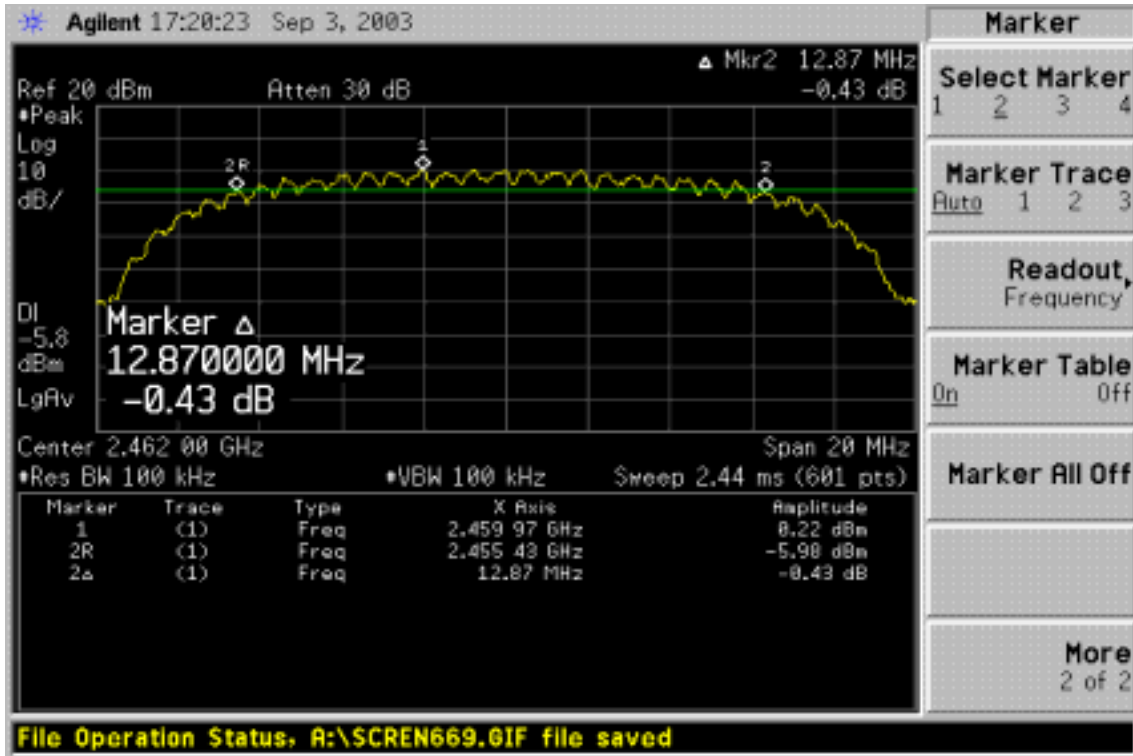



7.2 PEAK POWER

LIMIT

The maximum peak output power of the intentional radiator shall not exceed the following:

1. For systems using digital modulation in the bands of 902-928 MHz, 2400-2483.5 MHz, and 5725-5850 MHz: 1 watt.
2. Except as shown in paragraphs (b)(3) (i), (ii) and (iii) of this section, if transmitting antennas of directional gain greater than 6 dBi are used the peak output power from the intentional radiator shall be reduced below the stated values in paragraphs (b)(1) or (b)(2) of this section, as appropriate, by the amount in dB that the directional gain of the antenna exceeds 6 dBi.

MEASUREMENT EQUIPMENT USED

| Name of Equipment | Manufacturer | Model | Serial Number | Calibration Due |
|-------------------|----------------|--------------|---------------|-----------------|
| Spectrum Analyzer | Agilent | E4446A | US42510252 | 04/28/2004 |
| Low Loss Cable | Huber + Suhner | Sucoflex 104 | N/A | N/A |

Remark: Each piece of equipment is scheduled for calibration once a year.

Test Configuration

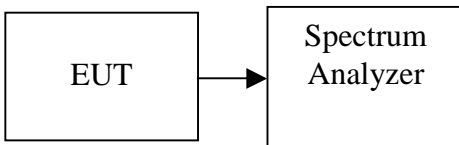

TEST PROCEDURE

The transmitter output is connected to the Spectrum analyzer. The Spectrum analyzer is set to the peak power detection.

TEST RESULTS

non-compliance noted

Test Data

| Channel | Reading Power (dBm) | Cable Loss (dB) | Output Power (dBm) | Output Power (W) | Limit (W) | Result |
|---------|---------------------|-----------------|--------------------|------------------|-----------|--------|
| Low | 14.09 | 1.70 | 15.79 | 0.03793 | 1 | PASS |
| Mid | 14.32 | 1.70 | 16.02 | 0.03999 | 1 | PASS |
| High | 14.56 | 1.70 | 16.26 | 0.04227 | 1 | PASS |



Test Plot

Peak power – Ch Low

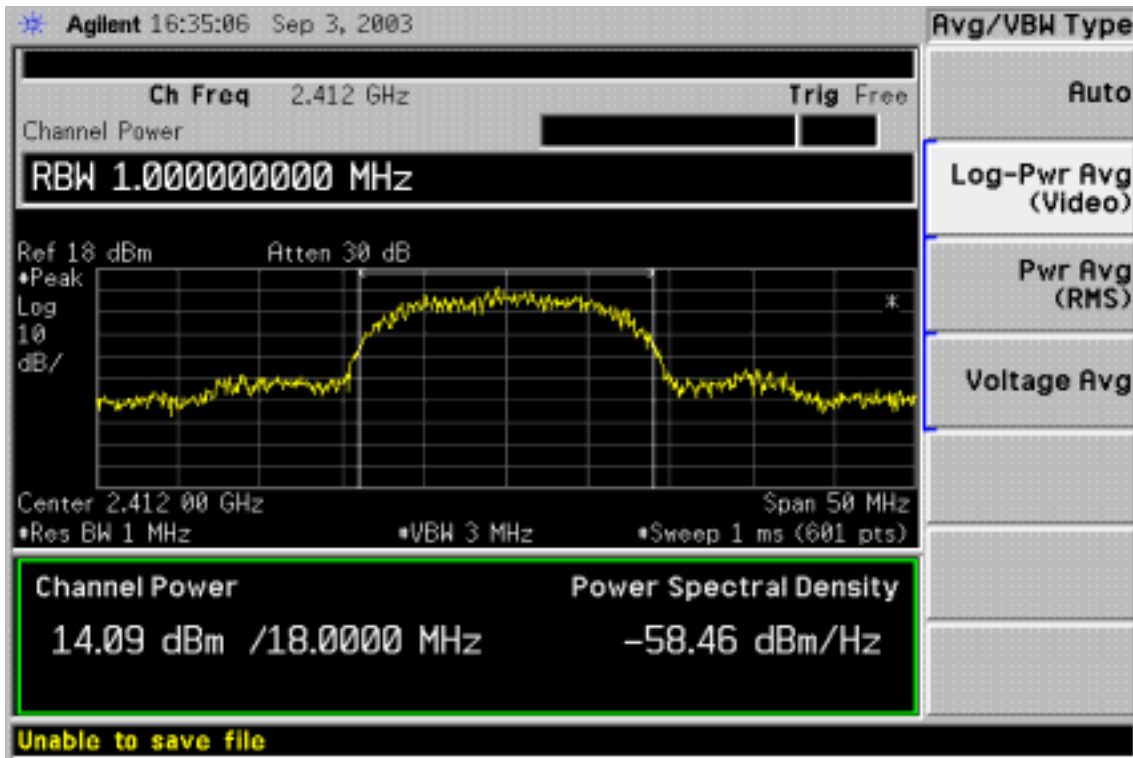

Peak power – Ch Mid

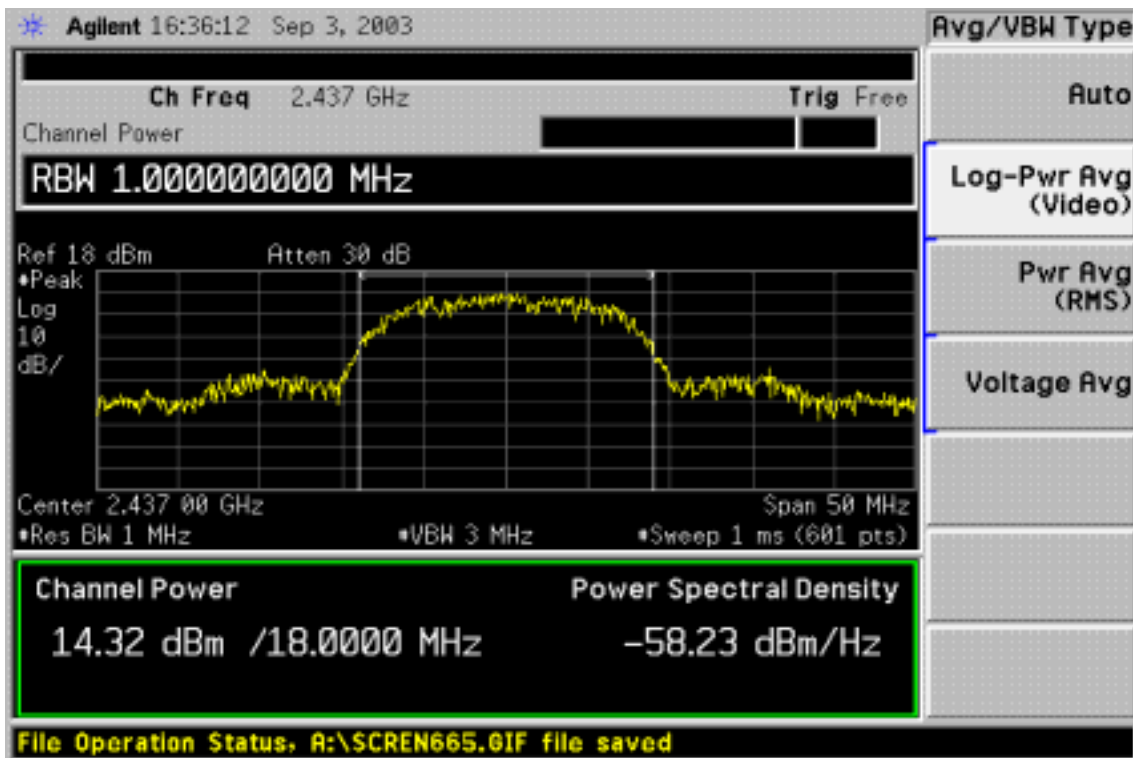



Peak power – Ch High

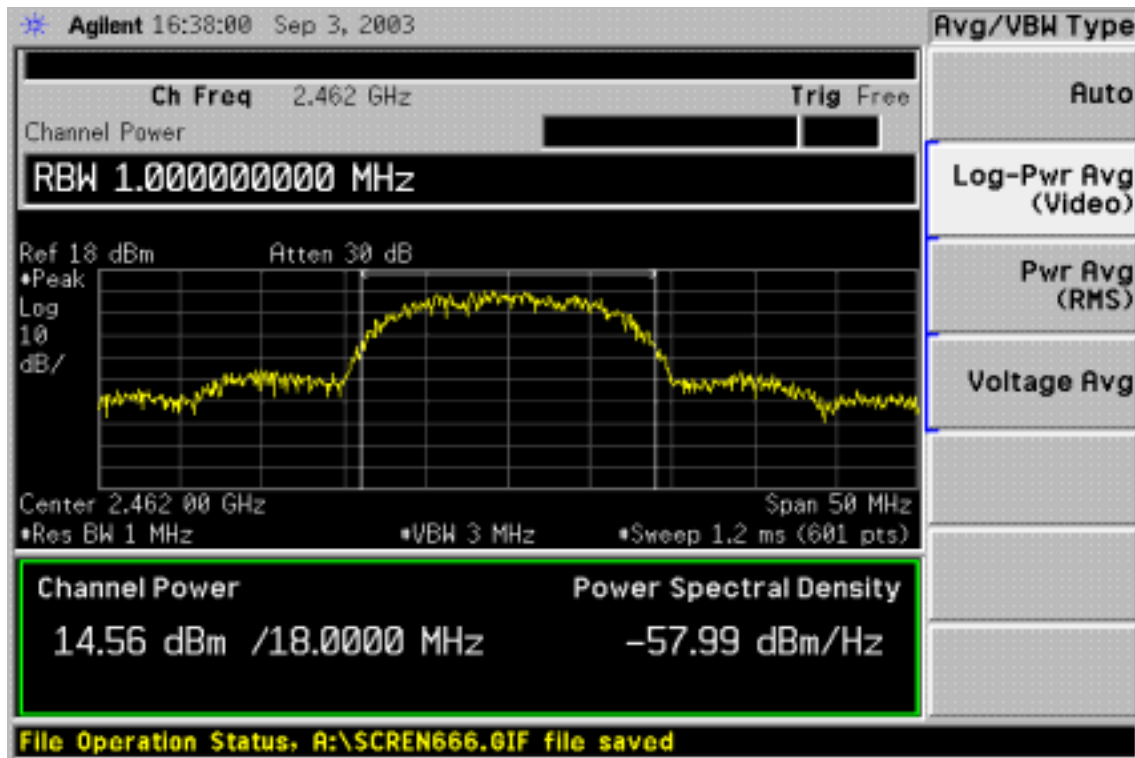

7.3BAND EDGES MEASUREMENT

LIMIT

According to §15.247(c), in any 100 kHz bandwidth outside the frequency bands in which the spread spectrum intentional radiator is operating, the radio frequency power that is produced by the intentional radiator shall be at least 20dB below that in the 100kHz bandwidth within the band that contains the highest level of the desired power, In addition, radiated emissions which fall in the restricted bands, as defined in §15.205(a), must also comply with the radiated emission limits specified in 15.209(a).

MEASUREMENT EQUIPMENT USED

| EQUIPMENT TYPE | MFR | Model No. | Serial No. | LAST CAL. | Cal. Due. |
|-------------------|----------------|--------------|--------------|------------|------------|
| Spectrum Analyzer | Agilent | E4446A | US42510252 | 04/28/2003 | 04/27/2004 |
| Spectrum Analyzer | R&S | FSP30 | 1093.4495.30 | 07/23/2003 | 07/22/2004 |
| Low loss cable | Huber + Suhner | Sucoflex 104 | N/A | N/A | N/A |

TEST CONFIGURATION

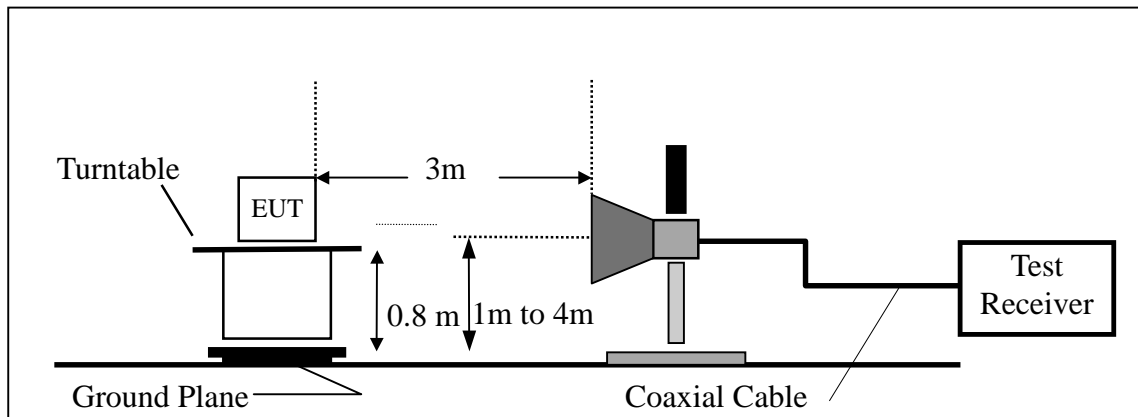

TEST PROCEDURE

1. The EUT is placed on a turntable, which is 0.8m above the ground plane.
2. The turntable shall be rotated for 360 degrees to determine the position of maximum emission level.
3. EUT is set 3m away from the receiving antenna, which is varied from 1m to 4m to find out the highest emission.
4. Set the spectrum analyzer in the following setting in order to capture the lower and upper band-edges of the emission:
 - (a) PEAK: RBW=VBW=1MHz / Sweep=AUTO
 - (b) AVERAGE: RBW=1MHz / VBW=10Hz / Sweep=AUTO
5. Repeat the procedures until all the PEAK and AVERAGE versus POLARIZATION are measured.

TEST RESULTS

Refer to attach spectrum analyzer data chart.



Band Edges – CH-Low

Detector mode: Peak

Polarity: Vertical

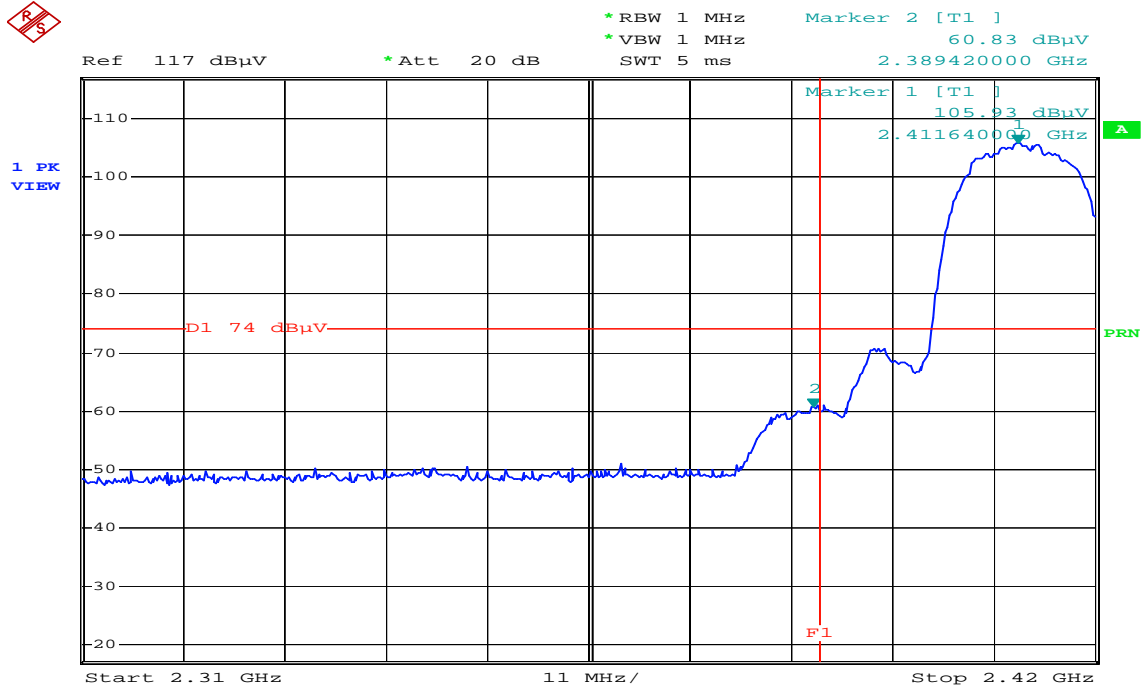

Date: 6.SEP.2003 13:12:36

Detector mode: Average

Polarity: Vertical

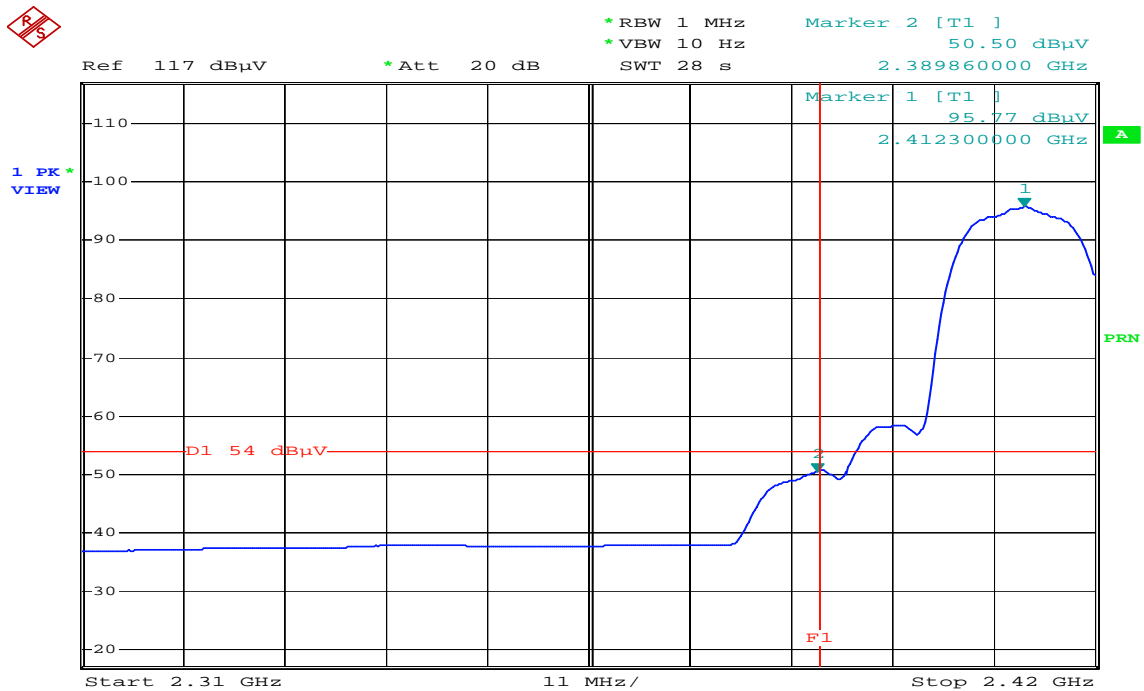

Date: 6.SEP.2003 13:13:48



Detector mode: Peak

Polarity: Horizontal

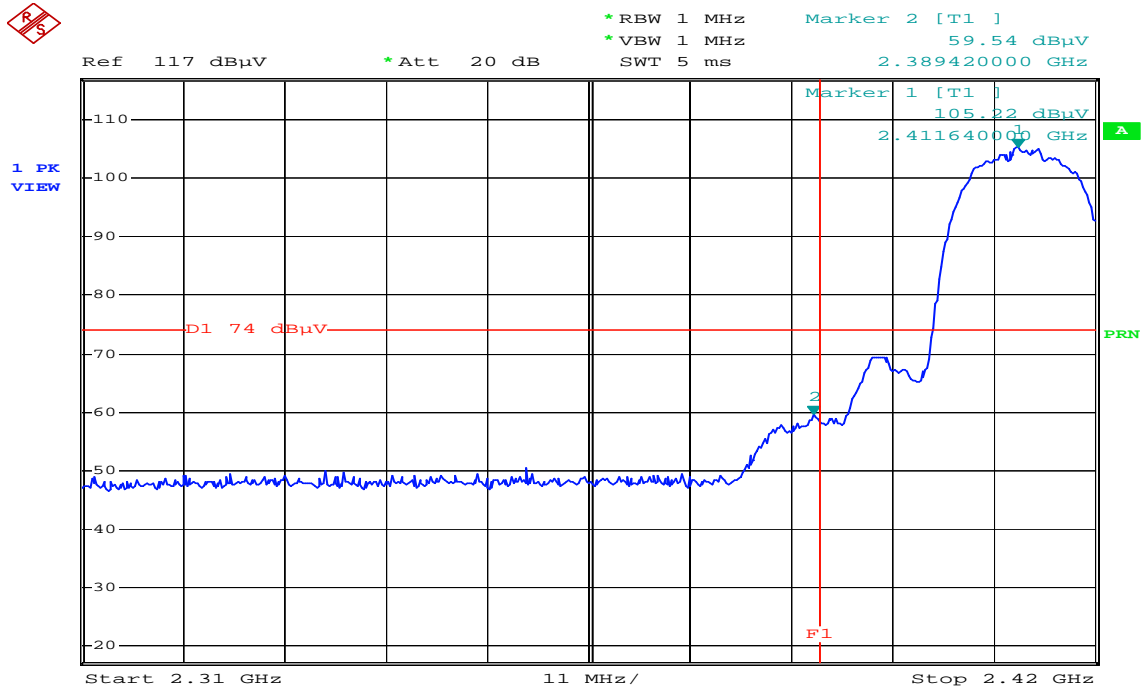

Date: 6.SEP.2003 13:06:42

Detector mode: Average

Polarity: Horizontal

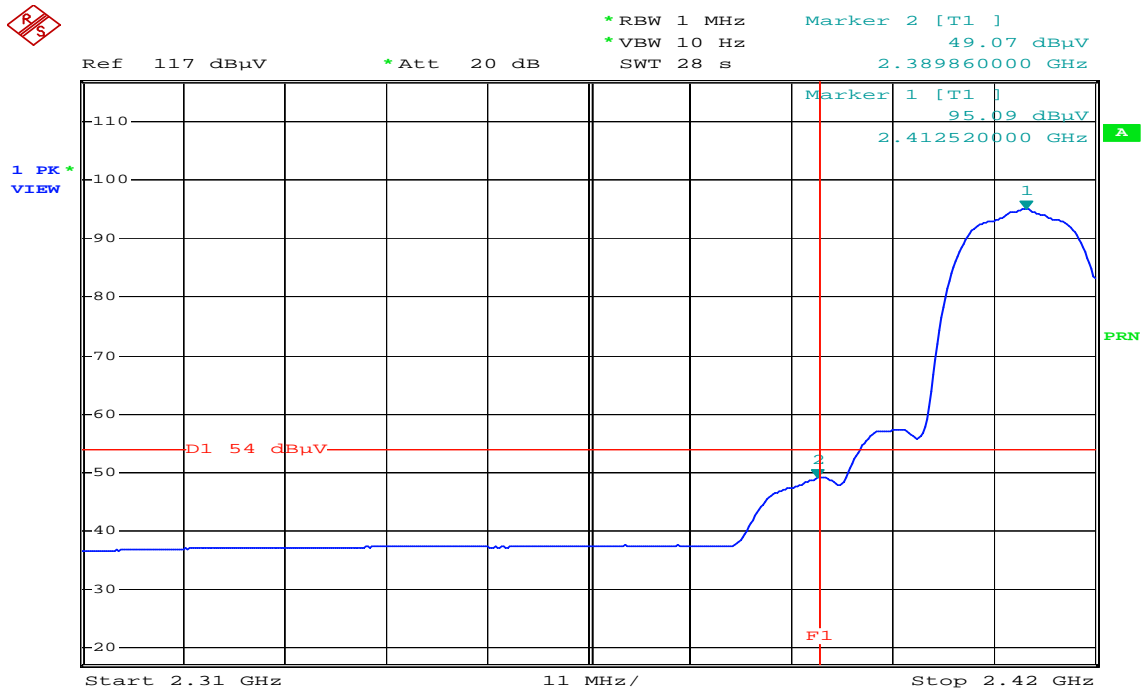

Date: 6.SEP.2003 13:08:21



Band Edges – CH-High

Detector mode: Peak

Polarity: Vertical

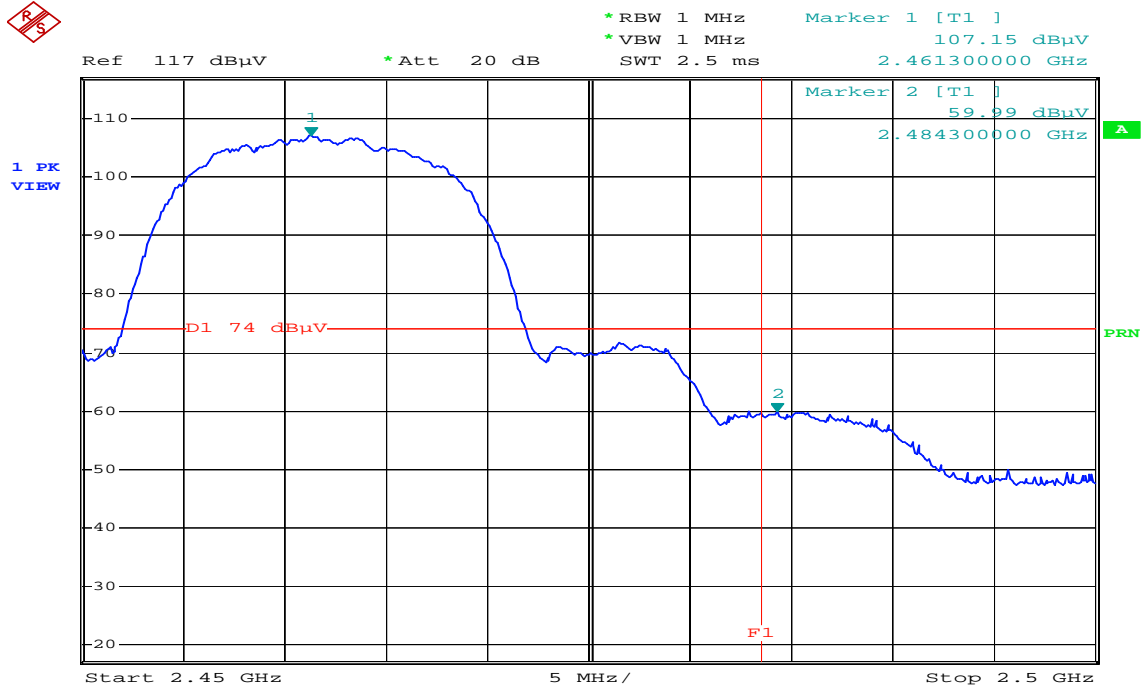

Date: 6.SEP.2003 12:55:53

Detector mode: Average

Polarity: Vertical

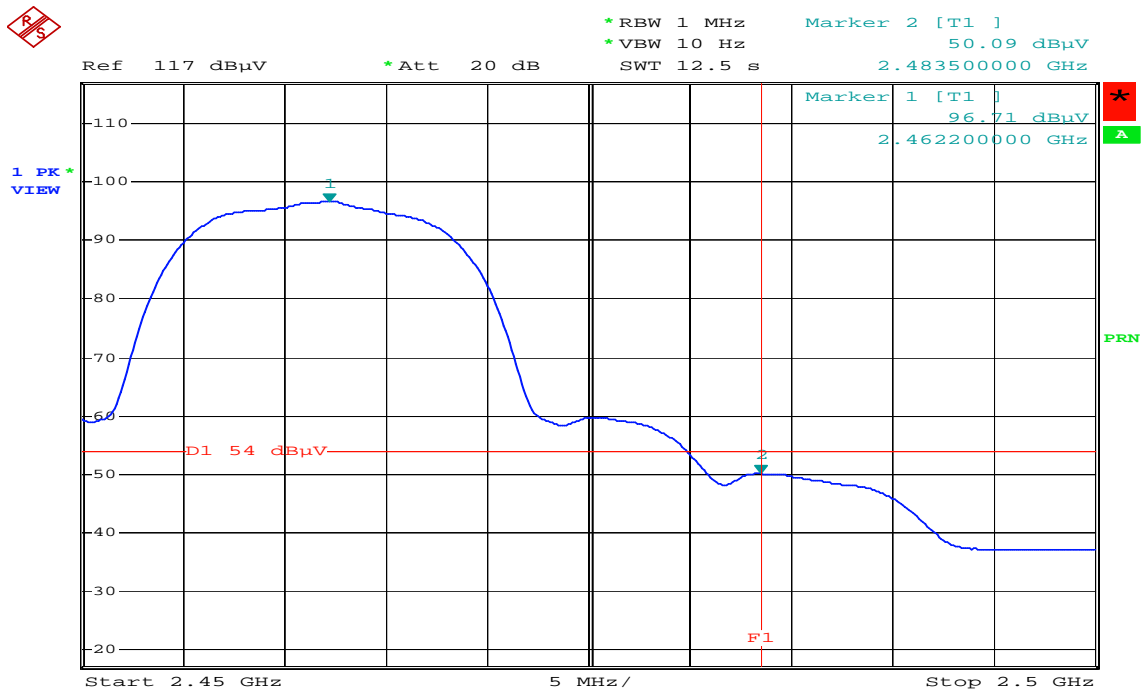

Date: 6.SEP.2003 12:56:52



Detector mode: Peak

Polarity: Horizontal

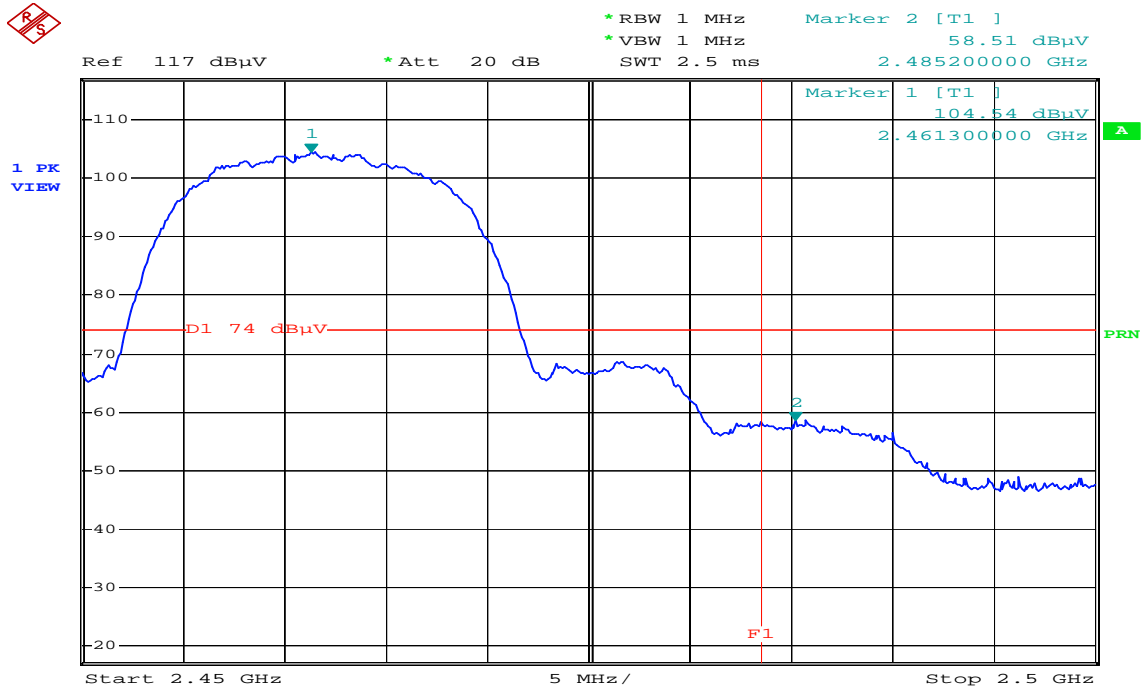

Date: 6.SEP.2003 13:02:03

Detector mode: Average

Polarity: Horizontal

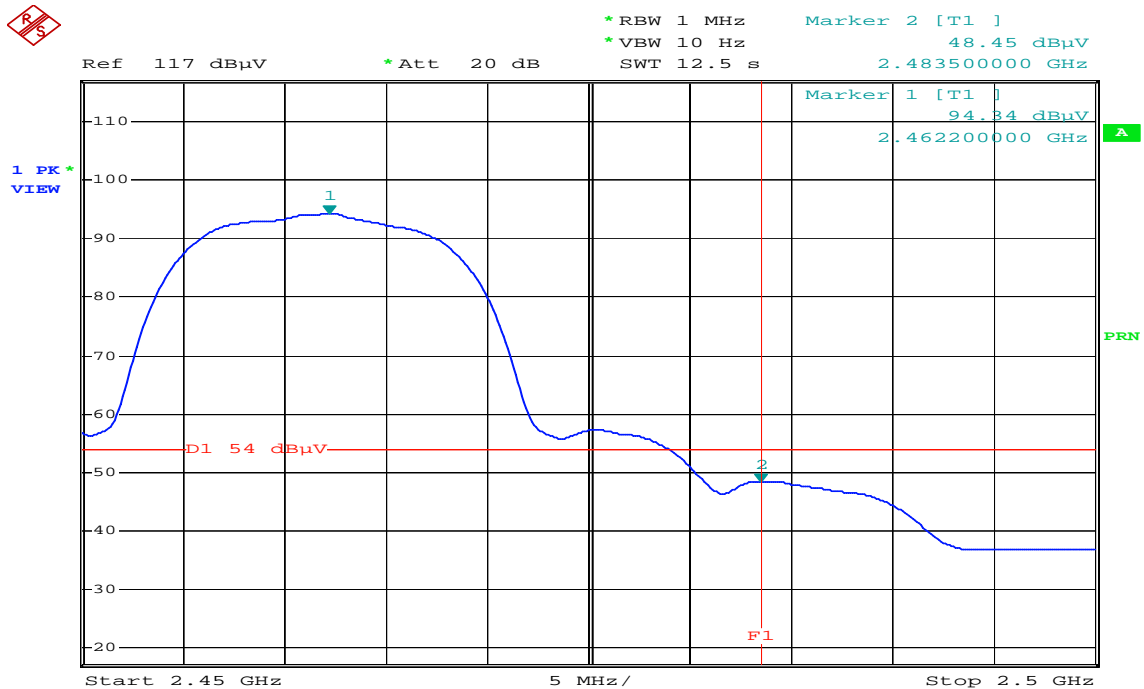

Date: 6.SEP.2003 13:02:56



7.4 PEAK POWER SPECTRAL DENSITY

LIMIT

1. For direct sequence systems, the peak power spectral density conducted from the intentional radiator to the antenna shall not be greater than 8dBm in any 3kHz band during any time interval of continuous transmission.
2. The direct sequence operating of the hybrid system, with the frequency hopping operation turned off, shall comply with the power density requirements of paragraph (d) of this section.

MEASUREMENT EQUIPMENT USED

| Name of Equipment | Manufacturer | Model | Serial Number | Calibration Due |
|-------------------|----------------|--------------|---------------|-----------------|
| Spectrum Analyzer | Agilent | E4446A | US42510252 | 04/28/2004 |
| Low loss Cable | Huber + Suhner | Sucoflex 104 | N/A | N/A |

Remark: Each piece of equipment is scheduled for calibration once a year.

Test Configuration

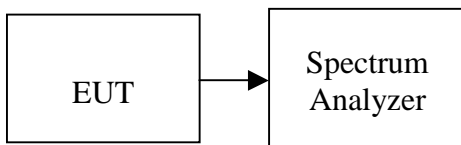

TEST PROCEDURE

1. Place the EUT on the table and set it in transmitting mode.
2. Remove the antenna from the EUT and then connect a low loss RF cable from the antenna port to the spectrum analyzer.
3. Set the spectrum analyzer as RBW = 3kHz, VBW = 10kHz, Span = 300kHz, Sweep=100s
4. Record the max. reading.
5. Repeat the above procedure until the measurements for all frequencies are completed.

TEST RESULTS

No non-compliance noted

Test Data

| Channel | Reading (dBm) | Cable Loss (dB) | PPSD (dBm) | Limit (dBm) | Result |
|---------|---------------|-----------------|------------|-------------|--------|
| Low | -9.05 | 1.70 | -7.35 | 8.00 | PASS |
| Mid | -8.74 | 1.70 | -7.04 | | PASS |
| High | -8.41 | 1.70 | -6.71 | | PASS |



Test Plot

PPSD – Ch Low

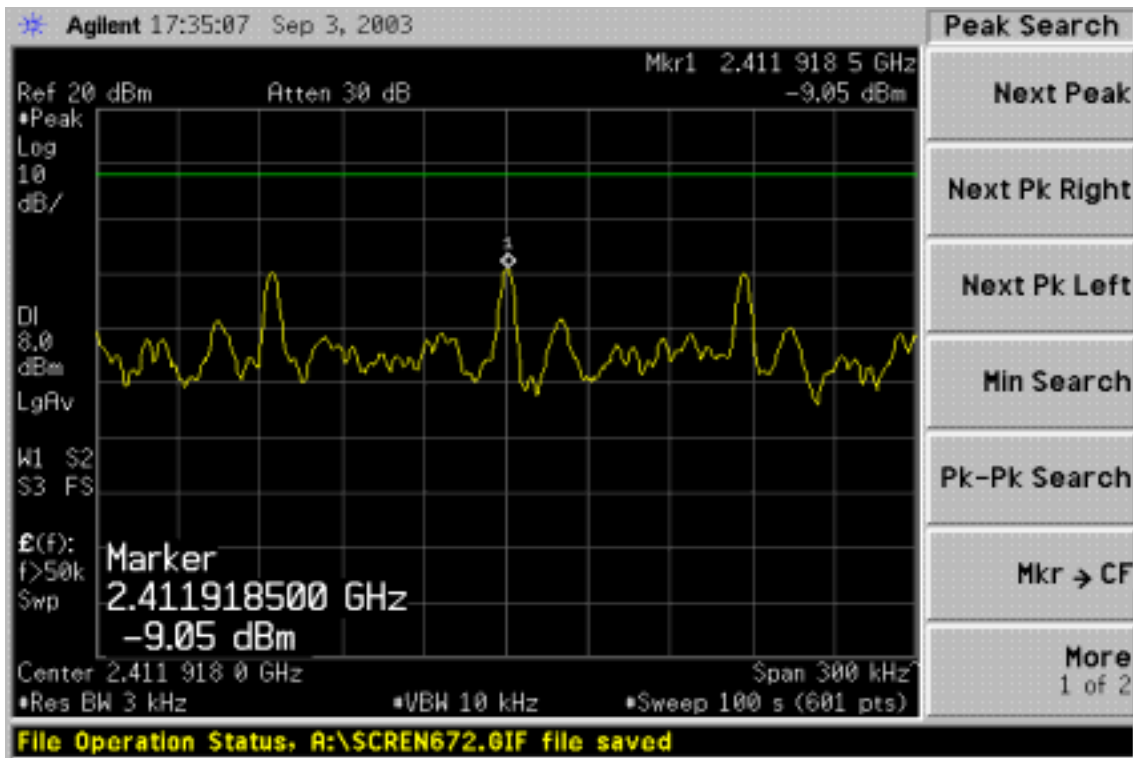

PPSD – Ch Mid

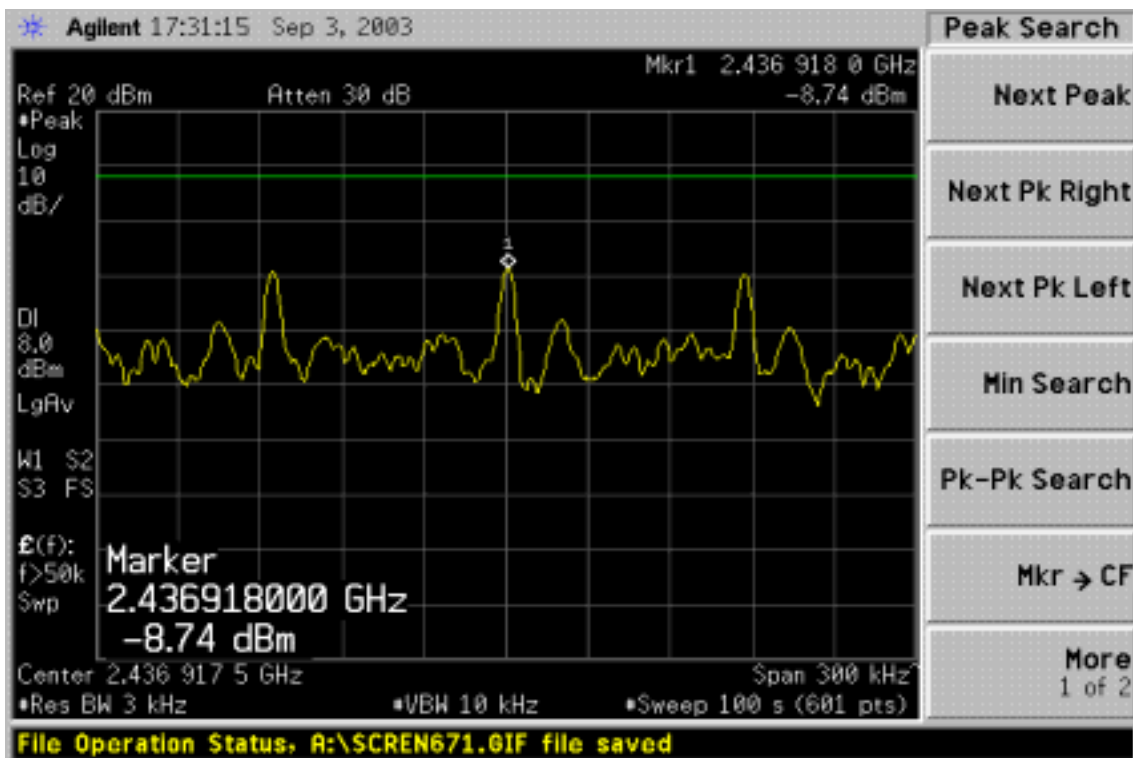



PPSD – Ch High

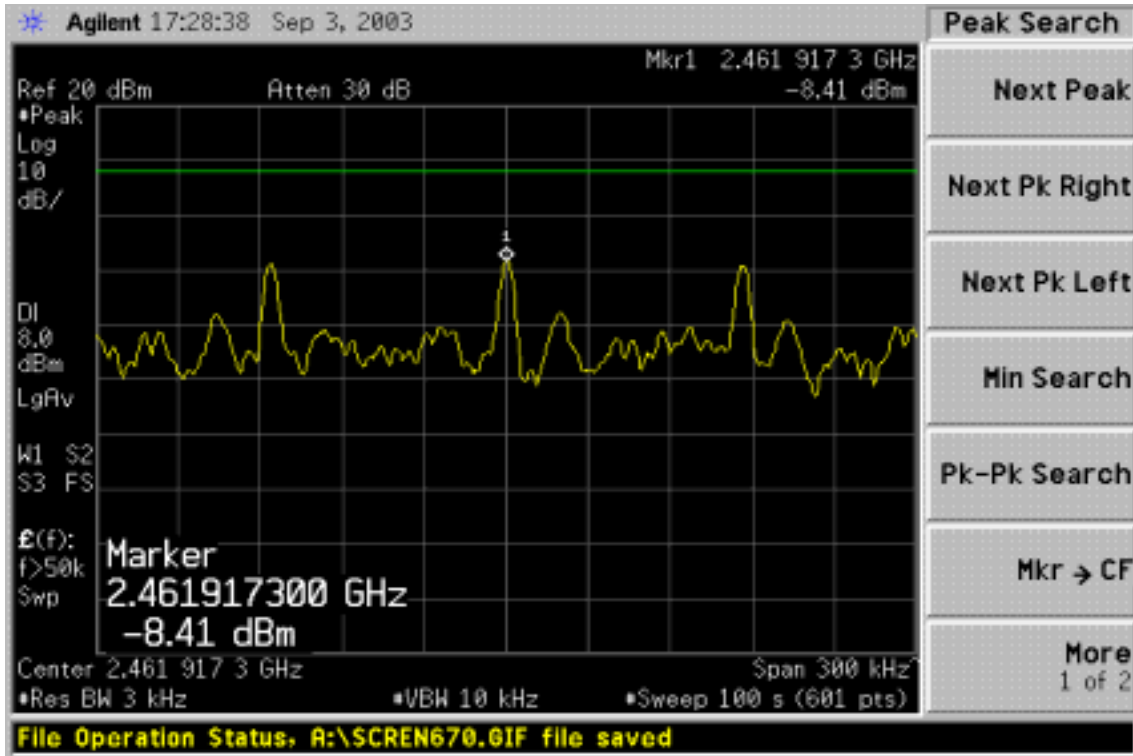



7.5 RADIO FREQUENCY EXPOSURE

LIMIT

Systems operating under the provisions of this section shall be operated in a manner that ensures that the public is not exposed to radio frequency energy levels in excess of the Commission's guidelines. See §15.247(b)(4) and §1.1307(b)(1) of this chapter.

EUT Specification

| | |
|--|---|
| EUT | Wireless LAN module built in Notebook PC |
| Frequency band (Operating) | <input checked="" type="checkbox"/> WLAN: 2.412GHz ~ 2.462GHz <input type="checkbox"/> WLAN: 5.18GHz ~ 5.32GHz / 5.50GHz ~ 5.70GHz <input type="checkbox"/> WLAN: 5.745GHz ~ 5825GHz <input type="checkbox"/> Others _____ |
| Device category | <input checked="" type="checkbox"/> Portable (<20cm separation) <input type="checkbox"/> Mobile (>20cm separation) <input type="checkbox"/> Others _____ |
| Exposure classification | <input type="checkbox"/> Occupational/Controlled exposure ($S = 5mW/cm^2$) <input checked="" type="checkbox"/> General Population/Uncontrolled exposure ($S=1mW/cm^2$) |
| Antenna diversity | <input type="checkbox"/> Single antenna <input checked="" type="checkbox"/> Multiple antennas <input type="checkbox"/> TX diversity <input type="checkbox"/> RX diversity <input checked="" type="checkbox"/> TX/RX diversity |
| Max. output power | 16.26 dBm (42.27mW) |
| Antenna gain (Max) | 1.31 dBi (Numeric gain: 0.00112) |
| Evaluation applied | <input type="checkbox"/> MPE Evaluation* <input checked="" type="checkbox"/> SAR Evaluation |
| <i>Note:</i> | |
| 1. *The maximum output power is 16.26dBm(42.27mW) at 2462MHz. | |
| 2. For mobile or fixed location transmitters, the minimum separation distance is 20 cm, even if calculations indicate that the MPE distance would be less. | |

TEST RESULTS

Please refer to SAR test report.



7.6 RADIATED EMISSIONS

LIMIT

1. Except as provided elsewhere in this Subpart, the emissions from an intentional radiator shall not exceed the field strength levels specified in the following table:

| Frequency (MHz) | Field Strength (mV/m) | Measurement Distance (m) |
|-----------------|-----------------------|--------------------------|
| 30-88 | 100* | 3 |
| 88-216 | 150* | 3 |
| 216-960 | 200* | 3 |
| Above 960 | 500 | 3 |

Note: Except as provided in paragraph (g), fundamental emissions from intentional radiators operating under this Section shall not be located in the frequency bands 54-72 MHz, 76-88 MHz, 174-216 MHz or 470-806 MHz. However, operation within these frequency bands is permitted under other sections of this Part, e.g., Sections 15.231 and 15.241.

2. In the above emission table, the tighter limit applies at the band edges.

| Frequency (Hz) | Field Strength (μ V/m at 3-meter) | Field Strength (dB μ V/m at 3-meter) |
|----------------|--|--|
| 30-88 | 100 | 40 |
| 88-216 | 150 | 43.5 |
| 216-960 | 200 | 46 |
| Above 960 | 500 | 54 |

MEASUREMENT EQUIPMENT USED

| Open Area Test Site # 3 | | | | |
|-------------------------|--------------|-----------|---------------|-----------------|
| Name of Equipment | Manufacturer | Model | Serial Number | Calibration Due |
| Spectrum Analyzer | ADVANTEST | R3261A | N/A | 03/18/2004 |
| EMI Test Receiver | R&S | ESVS20 | 838804/004 | 01/04/2004 |
| Pre-Amplifier | HP | 8447D | 2944A09173 | 03/03/2004 |
| Bilog Antenna | SCHWAZBECK | VULB9163 | 145 | 07/05/2004 |
| Turn Table | EMCO | 2081-1.21 | 9709-1885 | N.C.R |
| Antenna Tower | EMCO | 2075-2 | 9707-2060 | N.C.R |
| Controller | EMCO | 2090 | 9709-1256 | N.C.R |
| RF Switch | ANRITSU | MP59B | M53867 | N.C.R |
| Site NSA | C&C | N/A | N/A | 09/06/2004 |
| Horn antenna | Schwarzbeck | BBHA 9120 | D210 | 02/23/2004 |
| Loop Antenna | EMCO | 6502 | 2356 | 07/10/2004 |
| Pre-Amplifier | HP | 8449B | 3008B00965 | 10/02/2003 |

Remark: Each piece of equipment is scheduled for calibration once a year.

Test Configuration

Below 1 GHz

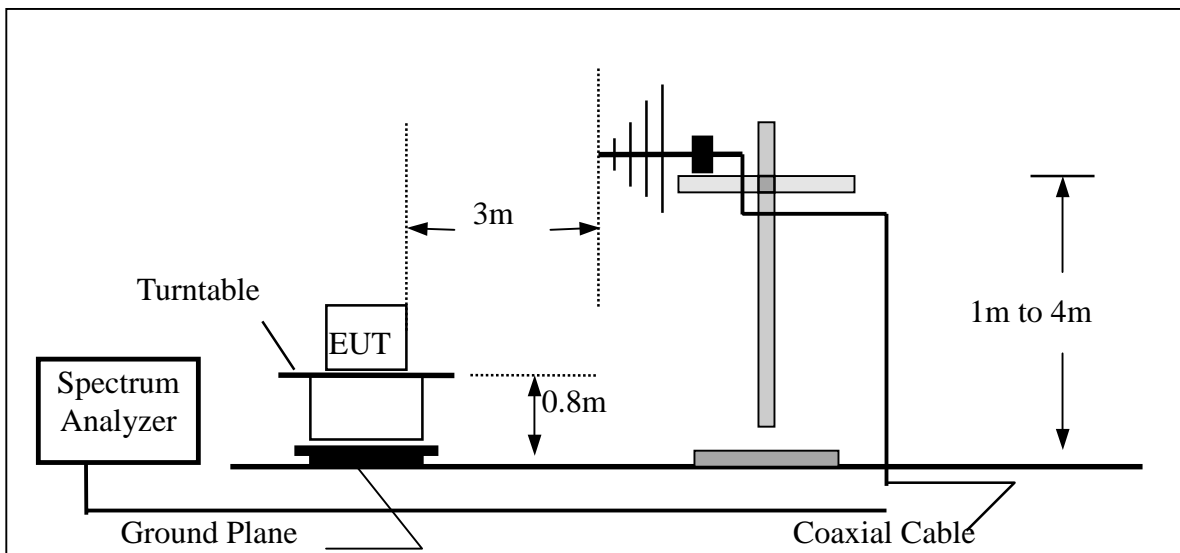

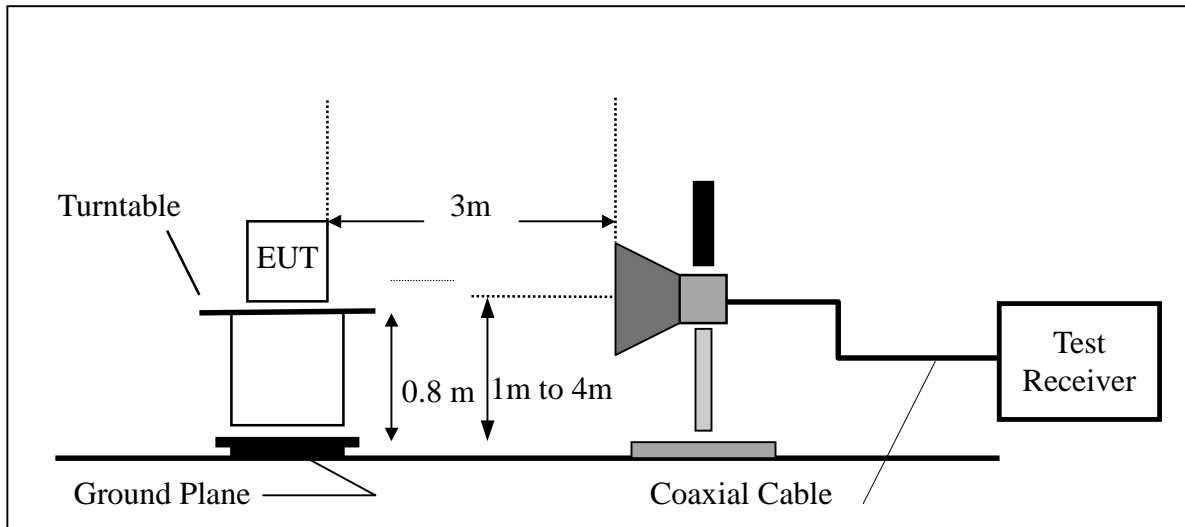
Above 1 GHz**TEST PROCEDURE**

1. The EUT is placed on a turntable, which is 0.8m above ground plane.
2. The turntable shall be rotated for 360 degrees to determine the position of maximum emission level.
3. EUT is set 3m away from the receiving antenna, which is varied from 1m to 4m to find out the highest emissions.
4. Maximum procedure was performed on the six highest emissions to ensure EUT compliance.
5. And also, each emission was to be maximized by changing the polarization of receiving antenna both horizontal and vertical.
6. Repeat above procedures until the measurements for all frequencies are complete.



TEST RESULTS

Below 1 GHz

| | | | |
|------------------------|----------------|-------------------|-------------------|
| Operation Mode: | TX CH Low Mode | Test Date: | September 6, 2003 |
| Temperature: | 20°C | Tested by: | Jacky |
| Humidity: | 70 % RH | Polarity: | Ver. / Hor. |

| Freq. (MHz) | Ant.Pol. H/V | Detector Mode (PK/QP) | Reading (dBuV) | Factor (dB) | Actual FS (dBuV/m) | Limit 3m (dBuV/m) | Safe Margin (dB) |
|----------------|-----------------|-----------------------------|-------------------|----------------|-----------------------|----------------------|---------------------|
| 107.40 | V | Peak | 14.86 | 13.18 | 28.04 | 43.50 | -15.46 |
| 430.66 | V | Peak | 12.67 | 20.38 | 33.05 | 46.00 | -12.95 |
| 499.50 | V | Peak | 9.99 | 22.49 | 32.48 | 46.00 | -13.52 |
| 666.33 | V | Peak | 14.50 | 25.17 | 39.67 | 46.00 | -6.33 |
| 695.50 | V | Peak | 10.17 | 25.69 | 35.86 | 46.00 | -10.14 |
| 721.16 | V | Peak | 4.80 | 25.82 | 30.62 | 46.00 | -15.38 |
| 200.10 | H | Peak | 10.86 | 14.92 | 25.78 | 43.50 | -17.72 |
| 308.16 | H | Peak | 11.41 | 16.90 | 28.31 | 46.00 | -17.69 |
| 500.66 | H | Peak | 10.95 | 22.53 | 33.48 | 46.00 | -12.52 |
| 662.83 | H | Peak | 14.71 | 25.11 | 39.82 | 46.00 | -6.18 |
| 720.00 | H | Peak | 3.45 | 25.81 | 29.26 | 46.00 | -16.74 |
| 865.83 | H | Peak | 1.39 | 27.56 | 28.95 | 46.00 | -17.05 |

Notes:

1. Measuring frequencies from 30 MHz to the 1GHz.
2. Radiated emissions measured in frequency range from 30 MHz to 1000MHz were made with an instrument using Peak detector mode.
3. Data of measurement within this frequency range shown “ - ” in the table above means the reading of emissions are attenuated more than 20dB below the permissible limits or the field strength is too small to be measured.
4. The IF bandwidth of SPA between 30MHz to 1GHz was 100kHz.



Operation Mode: TX CH Mid Mode **Test Date:** September 10, 2003
Temperature: 20°C **Tested by:** Jacky
Humidity: 70 % RH **Polarity:** Ver. / Hor.

| Freq. (MHz) | Ant.Pol. H/V | Detector Mode (PK/QP) | Reading (dBuV) | Factor (dB) | Actual FS (dBuV/m) | Limit 3m (dBuV/m) | Safe Margin (dB) |
|----------------|-----------------|-----------------------------|-------------------|----------------|-----------------------|----------------------|---------------------|
| 200.10 | V | Peak | 10.19 | 14.92 | 25.11 | 43.50 | -18.39 |
| 220.35 | V | Peak | 13.02 | 15.25 | 28.27 | 46.00 | -17.73 |
| 308.16 | V | Peak | 11.41 | 16.90 | 28.31 | 46.00 | -17.69 |
| 497.16 | V | Peak | 11.23 | 22.38 | 33.61 | 46.00 | -12.39 |
| 662.83 | V | Peak | 14.38 | 25.11 | 39.49 | 46.00 | -6.51 |
| 865.83 | V | Peak | 0.72 | 27.56 | 28.28 | 46.00 | -17.72 |
| 430.66 | H | Peak | 12.50 | 20.38 | 32.88 | 46.00 | -13.12 |
| 499.50 | H | Peak | 10.82 | 22.49 | 33.31 | 46.00 | -12.69 |
| 627.83 | H | Peak | 7.12 | 25.10 | 32.22 | 46.00 | -13.78 |
| 665.16 | H | Peak | 15.68 | 25.15 | 40.83 | 46.00 | -5.17 |
| 695.50 | H | Peak | 10.50 | 25.69 | 36.19 | 46.00 | -9.81 |
| 863.33 | H | Peak | 4.67 | 27.62 | 32.29 | 46.00 | -13.71 |

Notes:

1. Measuring frequencies from 30 MHz to the 1GHz.
2. Radiated emissions measured in frequency range from 30 MHz to 1000MHz were made with an instrument using Peak detector mode.
3. Data of measurement within this frequency range shown “ - ” in the table above means the reading of emissions are attenuated more than 20dB below the permissible limits or the field strength is too small to be measured.
4. The IF bandwidth of SPA between 30MHz to 1GHz was 100kHz.



Operation Mode: TX CH High Mode **Test Date:** September 6, 2003
Temperature: 20°C **Tested by:** Jacky
Humidity: 70 % RH **Polarity:** Ver. / Hor.

| Freq. (MHz) | Ant.Pol. H/V | Detector Mode (PK/QP) | Reading (dBuV) | Factor (dB) | Actual FS (dBuV/m) | Limit 3m (dBuV/m) | Safe Margin (dB) |
|----------------|-----------------|-----------------------------|-------------------|----------------|-----------------------|----------------------|---------------------|
| 104.25 | V | Peak | 15.05 | 13.59 | 28.64 | 43.50 | -14.86 |
| 219.90 | V | Peak | 14.35 | 15.24 | 29.59 | 46.00 | -16.41 |
| 430.66 | V | Peak | 13.00 | 20.38 | 33.38 | 46.00 | -12.62 |
| 466.83 | V | Peak | 8.24 | 20.96 | 29.20 | 46.00 | -16.80 |
| 497.16 | V | Peak | 10.56 | 22.38 | 32.94 | 46.00 | -13.06 |
| 662.83 | V | Peak | 16.55 | 25.11 | 41.66 | 46.00 | -4.34 |
| 199.20 | H | Peak | 9.24 | 14.84 | 24.08 | 43.50 | -19.42 |
| 220.35 | H | Peak | 12.85 | 15.25 | 28.10 | 46.00 | -17.90 |
| 308.16 | H | Peak | 11.41 | 16.90 | 28.31 | 46.00 | -17.69 |
| 497.16 | H | Peak | 11.06 | 22.38 | 33.44 | 46.00 | -12.56 |
| 662.83 | H | Peak | 15.55 | 25.11 | 40.66 | 46.00 | -5.34 |
| 732.83 | H | Peak | 1.70 | 25.84 | 27.54 | 46.00 | -18.46 |

Notes:

1. Measuring frequencies from 30 MHz to the 1GHz.
2. Radiated emissions measured in frequency range from 30 MHz to 1000MHz were made with an instrument using Peak detector mode.
3. Data of measurement within this frequency range shown “ - ” in the table above means the reading of emissions are attenuated more than 20dB below the permissible limits or the field strength is too small to be measured.
4. The IF bandwidth of SPA between 30MHz to 1GHz was 100kHz.



Above 1 GHz

Operation Mode: TX CH Low Mode **Test Date:** September 6, 2003
Temperature: 20°C **Tested by:** Jacky
Humidity: 70% RH **Polarity:** Ver.

| Freq. (MHz) | Peak | AV | Ant./CL CF(dB) | Actual FS | | Peak | AV | Margin (dB) | Remark |
|----------------|-------------------|-------------------|-------------------|------------------|----------------|-------------------|-------------------|----------------|--------|
| | Reading (dBuV) | Reading (dBuV) | | Peak (dBuV/m) | AV (dBuV/m) | Limit (dBuV/m) | Limit (dBuV/m) | | |
| 1600.00 | 45.00 | --- | -6.79 | 38.21 | --- | 74.00 | 54.00 | -15.79 | Peak |
| 4824.00 | --- | --- | --- | --- | --- | 74.00 | 54.00 | --- | --- |
| 7236.00 | --- | --- | --- | --- | --- | 74.00 | 54.00 | --- | --- |
| 9648.00 | --- | --- | --- | --- | --- | 74.00 | 54.00 | --- | --- |
| 12060.00 | --- | --- | --- | --- | --- | 74.00 | 54.00 | --- | --- |
| 14472.00 | --- | --- | --- | --- | --- | 74.00 | 54.00 | --- | --- |
| 16884.00 | --- | --- | --- | --- | --- | 74.00 | 54.00 | --- | --- |
| 19296.00 | --- | --- | --- | --- | --- | 74.00 | 54.00 | --- | --- |
| 21708.00 | --- | --- | --- | --- | --- | 74.00 | 54.00 | --- | --- |
| 24120.00 | --- | --- | --- | --- | --- | 74.00 | 54.00 | --- | --- |

Notes:

1. Measuring frequencies from 1 GHz to the 10th harmonic of highest fundamental frequency.
2. Data of measurement within this frequency range shown " --- " in the table above means the reading of emissions are attenuated more than 20dB below the permissible limits or the field strength is too small to be measured.
3. Radiated emissions measured in frequency above 1000MHz were made with an instrument using Peak detector mode and average detector mode of the emission shown in Actual FS column.
4. Spectrum Peak Setting 1GHz - 26GHz, RBW = 1MHz, VBW = 1MHz, Sweep time = 200 ms.
5. Spectrum AV Setting 1GHz - 26GHz, RBW = 1MHz, VBW = 10Hz, Sweep time = 200 ms



Operation Mode: TX CH Low Mode **Test Date:** September 6, 2003
Temperature: 20°C **Tested by:** Jacky
Humidity: 70 % RH **Polarity:** Hor.

| Freq. (MHz) | Peak | AV | Ant./CL CF(dB) | Actual FS | | Peak | AV | Margin (dB) | Remark |
|----------------|-------------------|-------------------|-------------------|------------------|----------------|-------------------|-------------------|----------------|--------|
| | Reading (dBuV) | Reading (dBuV) | | Peak (dBuV/m) | AV (dBuV/m) | Limit (dBuV/m) | Limit (dBuV/m) | | |
| 4824.00 | --- | --- | --- | --- | --- | 74.00 | 54.00 | --- | --- |
| 7236.00 | --- | --- | --- | --- | --- | 74.00 | 54.00 | --- | --- |
| 9648.00 | --- | --- | --- | --- | --- | 74.00 | 54.00 | --- | --- |
| 12060.00 | --- | --- | --- | --- | --- | 74.00 | 54.00 | --- | --- |
| 14472.00 | --- | --- | --- | --- | --- | 74.00 | 54.00 | --- | --- |
| 16884.00 | --- | --- | --- | --- | --- | 74.00 | 54.00 | --- | --- |
| 19296.00 | --- | --- | --- | --- | --- | 74.00 | 54.00 | --- | --- |
| 21708.00 | --- | --- | --- | --- | --- | 74.00 | 54.00 | --- | --- |
| 24120.00 | --- | --- | --- | --- | --- | 74.00 | 54.00 | --- | --- |

Notes:

1. Measuring frequencies from 1 GHz to the 10th harmonic of highest fundamental frequency.
2. Data of measurement within this frequency range shown " --- " in the table above means the reading of emissions are attenuated more than 20dB below the permissible limits or the field strength is too small to be measured.
3. Radiated emissions measured in frequency above 1000MHz were made with an instrument using Peak detector mode and average detector mode of the emission shown in Actual FS column.
4. Spectrum Peak Setting 1GHz - 26GHz, RBW = 1MHz, VBW = 1MHz, Sweep time = 200 ms.
5. Spectrum AV Setting 1GHz - 26GHz, RBW = 1MHz, VBW = 10Hz, Sweep time = 200 ms



Operation Mode: TX CH Mid Mode **Test Date:** September 6, 2003
Temperature: 20°C **Tested by:** Jacky
Humidity: 70 % RH **Polarity:** Ver.

| Freq. (MHz) | Peak | AV | Ant./CL CF(dB) | Actual FS | | Peak | AV | Margin (dB) | Remark |
|----------------|-------------------|-------------------|-------------------|------------------|----------------|-------------------|-------------------|----------------|--------|
| | Reading (dBuV) | Reading (dBuV) | | Peak (dBuV/m) | AV (dBuV/m) | Limit (dBuV/m) | Limit (dBuV/m) | | |
| 1600.00 | 44.34 | --- | -6.79 | 37.55 | --- | 74.00 | 54.00 | -16.45 | Peak |
| 4874.00 | --- | --- | --- | --- | --- | 74.00 | 54.00 | --- | --- |
| 7311.00 | --- | --- | --- | --- | --- | 74.00 | 54.00 | --- | --- |
| 9748.00 | --- | --- | --- | --- | --- | 74.00 | 54.00 | --- | --- |
| 12185.00 | --- | --- | --- | --- | --- | 74.00 | 54.00 | --- | --- |
| 14622.00 | --- | --- | --- | --- | --- | 74.00 | 54.00 | --- | --- |
| 17059.00 | --- | --- | --- | --- | --- | 74.00 | 54.00 | --- | --- |
| 19496.00 | --- | --- | --- | --- | --- | 74.00 | 54.00 | --- | --- |
| 21933.00 | --- | --- | --- | --- | --- | 74.00 | 54.00 | --- | --- |
| 24370.00 | --- | --- | --- | --- | --- | 74.00 | 54.00 | --- | --- |

Notes:

1. Measuring frequencies from 1 GHz to the 10th harmonic of highest fundamental frequency.
2. Data of measurement within this frequency range shown " --- " in the table above means the reading of emissions are attenuated more than 20dB below the permissible limits or the field strength is too small to be measured.
3. Radiated emissions measured in frequency above 1000MHz were made with an instrument using Peak detector mode and average detector mode of the emission shown in Actual FS column.
4. Spectrum Peak Setting 1GHz - 26GHz, RBW = 1MHz, VBW = 1MHz, Sweep time = 200 ms.
5. Spectrum AV Setting 1GHz - 26GHz, RBW = 1MHz, VBW = 10Hz, Sweep time = 200 ms



Operation Mode: TX CH Mid Mode **Test Date:** September 6, 2003
Temperature: 20°C **Tested by:** Jacky
Humidity: 70 % RH **Polarity:** Hor.

| Freq. (MHz) | Peak | AV | Ant./CL CF(dB) | Actual FS | | Peak | AV | Margin (dB) | Remark |
|----------------|-------------------|-------------------|-------------------|------------------|----------------|-------------------|-------------------|----------------|--------|
| | Reading (dBuV) | Reading (dBuV) | | Peak (dBuV/m) | AV (dBuV/m) | Limit (dBuV/m) | Limit (dBuV/m) | | |
| 4874.00 | --- | --- | --- | --- | --- | 74.00 | 54.00 | --- | --- |
| 7311.00 | --- | --- | --- | --- | --- | 74.00 | 54.00 | --- | --- |
| 9748.00 | --- | --- | --- | --- | --- | 74.00 | 54.00 | --- | --- |
| 12185.00 | --- | --- | --- | --- | --- | 74.00 | 54.00 | --- | --- |
| 14622.00 | --- | --- | --- | --- | --- | 74.00 | 54.00 | --- | --- |
| 17059.00 | --- | --- | --- | --- | --- | 74.00 | 54.00 | --- | --- |
| 19496.00 | --- | --- | --- | --- | --- | 74.00 | 54.00 | --- | --- |
| 21933.00 | --- | --- | --- | --- | --- | 74.00 | 54.00 | --- | --- |
| 24370.00 | --- | --- | --- | --- | --- | 74.00 | 54.00 | --- | --- |

Notes:

1. Measuring frequencies from 1 GHz to the 10th harmonic of highest fundamental frequency.
2. Data of measurement within this frequency range shown " --- " in the table above means the reading of emissions are attenuated more than 20dB below the permissible limits or the field strength is too small to be measured.
3. Radiated emissions measured in frequency above 1000MHz were made with an instrument using Peak detector mode and average detector mode of the emission shown in Actual FS column.
4. Spectrum Peak Setting 1GHz - 26GHz, RBW = 1MHz, VBW = 1MHz, Sweep time = 200 ms.
5. Spectrum AV Setting 1GHz - 26GHz, RBW = 1MHz, VBW = 10Hz, Sweep time = 200 ms



Operation Mode: TX CH High Mode **Test Date:** September 6, 2003
Temperature: 20°C **Tested by:** Jacky
Humidity: 70 % RH **Polarity:** Ver.

| Freq. (MHz) | Peak | AV | Ant./CL CF(dB) | Actual FS | | Peak | AV | Margin (dB) | Remark |
|----------------|-------------------|-------------------|-------------------|------------------|----------------|-------------------|-------------------|----------------|--------|
| | Reading (dBuV) | Reading (dBuV) | | Peak (dBuV/m) | AV (dBuV/m) | Limit (dBuV/m) | Limit (dBuV/m) | | |
| 1600.00 | 44.00 | --- | -6.79 | 37.21 | --- | 74.00 | 54.00 | -16.79 | Peak |
| 4924.00 | --- | --- | --- | --- | --- | 74.00 | 54.00 | --- | --- |
| 7386.00 | --- | --- | --- | --- | --- | 74.00 | 54.00 | --- | --- |
| 9848.00 | --- | --- | --- | --- | --- | 74.00 | 54.00 | --- | --- |
| 12310.00 | --- | --- | --- | --- | --- | 74.00 | 54.00 | --- | --- |
| 14772.00 | --- | --- | --- | --- | --- | 74.00 | 54.00 | --- | --- |
| 17234.00 | --- | --- | --- | --- | --- | 74.00 | 54.00 | --- | --- |
| 19696.00 | --- | --- | --- | --- | --- | 74.00 | 54.00 | --- | --- |
| 22158.00 | --- | --- | --- | --- | --- | 74.00 | 54.00 | --- | --- |
| 24620.00 | --- | --- | --- | --- | --- | 74.00 | 54.00 | --- | --- |

Notes:

1. Measuring frequencies from 1 GHz to the 10th harmonic of highest fundamental frequency.
2. Data of measurement within this frequency range shown " --- " in the table above means the reading of emissions are attenuated more than 20dB below the permissible limits or the field strength is too small to be measured.
3. Radiated emissions measured in frequency above 1000MHz were made with an instrument using Peak detector mode and average detector mode of the emission shown in Actual FS column.
4. Spectrum Peak Setting 1GHz - 26GHz, RBW = 1MHz, VBW = 1MHz, Sweep time = 200 ms.
5. Spectrum AV Setting 1GHz - 26GHz, RBW = 1MHz, VBW = 10Hz, Sweep time = 200 ms



Operation Mode: TX CH High Mode **Test Date:** September 6, 2003
Temperature: 20°C **Tested by:** Jacky
Humidity: 70 % RH **Polarity:** Hor.

| Freq. (MHz) | Peak | AV | Ant./CL CF(dB) | Actual FS | | Peak | AV | Margin (dB) | Remark |
|----------------|-------------------|-------------------|-------------------|------------------|----------------|-------------------|-------------------|----------------|--------|
| | Reading (dBuV) | Reading (dBuV) | | Peak (dBuV/m) | AV (dBuV/m) | Limit (dBuV/m) | Limit (dBuV/m) | | |
| 4924.00 | --- | --- | --- | --- | --- | 74.00 | 54.00 | --- | --- |
| 7386.00 | --- | --- | --- | --- | --- | 74.00 | 54.00 | --- | --- |
| 9848.00 | --- | --- | --- | --- | --- | 74.00 | 54.00 | --- | --- |
| 12310.00 | --- | --- | --- | --- | --- | 74.00 | 54.00 | --- | --- |
| 14772.00 | --- | --- | --- | --- | --- | 74.00 | 54.00 | --- | --- |
| 17234.00 | --- | --- | --- | --- | --- | 74.00 | 54.00 | --- | --- |
| 19696.00 | --- | --- | --- | --- | --- | 74.00 | 54.00 | --- | --- |
| 22158.00 | --- | --- | --- | --- | --- | 74.00 | 54.00 | --- | --- |
| 24620.00 | --- | --- | --- | --- | --- | 74.00 | 54.00 | --- | --- |

Notes:

1. Measuring frequencies from 1 GHz to the 10th harmonic of highest fundamental frequency.
2. Data of measurement within this frequency range shown " --- " in the table above means the reading of emissions are attenuated more than 20dB below the permissible limits or the field strength is too small to be measured.
3. Radiated emissions measured in frequency above 1000MHz were made with an instrument using Peak detector mode and average detector mode of the emission shown in Actual FS column.
4. Spectrum Peak Setting 1GHz - 26GHz, RBW = 1MHz, VBW = 1MHz, Sweep time = 200 ms.
5. Spectrum AV Setting 1GHz - 26GHz, RBW = 1MHz, VBW = 10Hz, Sweep time = 200 ms



7.7 POWERLINE CONDUCTED EMISSIONS

LIMIT

For an intentional radiator which is designed to be connected to the public utility (AC) power line, the radio frequency voltage that is conducted back onto the AC power line on any frequency or frequencies within the band 150 kHz to 30 MHz shall not exceed 250 microvolts (The limit decreases linearly with the logarithm of the frequency in the range 0.15 MHz to 0.50 MHz). The limits at specific frequency range is listed as follows:

| Frequency Range (MHz) | Limits (dBµV) | |
|-----------------------|---------------|----------|
| | Quasi-peak | Average |
| 0.15 to 0.50 | 66 to 56 | 56 to 46 |
| 0.50 to 5 | 56 | 46 |
| 5 to 30 | 60 | 50 |

Compliance with this provision shall be based on the measurement of the radio frequency voltage between each power line (LINE and NEUTRAL) and ground at the power terminals.

MEASUREMENT EQUIPMENT USED

| Name of Equipment | Manufacturer | Model | Serial Number | Calibration Due |
|-------------------|--------------|---------|---------------|-----------------|
| EMI Test Receiver | R&S | ESCS30 | 847793/012 | 12/20/2003 |
| LISN | R&S | ESH2-Z5 | 843285/010 | 12/15/2003 |
| LISN | EMCO | 3825/2 | 9003-1628 | 07/25/2004 |

Remark: Each piece of equipment is scheduled for calibration once a year.



Test Configuration

1. The conducted emission tests were performed in the test site, using the setup in accordance with the ANSI C63.4-1992.
2. The EUT was plug-in the host PC via USB port. The host PC system was placed on the center of the back edge on the test table. The peripherals like modem, monitor printer, K/B, and mouse were placed on the side of the host PC system. The rear of the EUT and peripherals were placed flushed with the rear of the tabletop.
3. The keyboard was placed directly in the front of the monitor, flushed with the front tabletop. The mouse was placed next to the Keyboard, flushed with the back of keyboard.
4. The spacing between the peripherals was 10 centimeters.
5. External I/O cables were draped along the edge of the test table and bundle when necessary.
6. The host PC system was connected with 110Vac/60Hz power source.

The EUT is set to transmit in a continuous mode.

Test Procedure

1. The EUT was placed on a table, which is 0.8m above ground plane.
2. Maximum procedure was performed on the six highest emissions to ensure EUT compliance.
3. Repeat above procedures until all frequency measured were complete.



TEST RESULTS

The initial step in collecting conducted data is a spectrum analyzer peak scan of the measurement range. Significant peaks are then marked as shown on the following data page, and these signals are then quasi-peaked.

Operation Mode: TX + RX mode **Test Date:** September 6, 2003
Temperature: 25°C **Tested by:** Jacky
Humidity: 68% RH

| FREQ MHz | Q.P. Raw dBuV | AVG Raw dBuV | Q.P. Limit dBuV | AVG Limit dBuV | Q.P. Margin dB | AVG Margin dB | NOTE |
|-------------|---------------------|--------------------|-----------------------|----------------------|----------------------|---------------------|------|
| 0.150 | 40.00 | --- | 66.00 | 56.00 | -26.00 | --- | L1 |
| 0.221 | 54.80 | 46.10 | 62.78 | 52.78 | -7.98 | -6.68 | L1 |
| 0.337 | 43.30 | --- | 59.28 | 49.28 | -15.98 | --- | L1 |
| 0.402 | 42.70 | --- | 57.81 | 47.81 | -15.11 | --- | L1 |
| 0.466 | 36.80 | --- | 56.59 | 46.59 | -19.79 | --- | L1 |
| 0.558 | 33.40 | --- | 56.00 | 46.00 | -22.60 | --- | L1 |
| 0.150 | 38.50 | --- | 66.00 | 56.00 | -27.50 | --- | L2 |
| 0.278 | 44.00 | --- | 60.88 | 50.88 | -16.88 | --- | L2 |
| 0.336 | 42.10 | --- | 59.30 | 49.30 | -17.20 | --- | L2 |
| 0.400 | 41.70 | --- | 57.85 | 47.85 | -16.15 | --- | L2 |
| 0.465 | 34.40 | --- | 56.60 | 46.60 | -22.20 | --- | L2 |
| 0.559 | 40.80 | --- | 56.00 | 46.00 | -15.20 | --- | L2 |

Note:

1. Measuring frequencies from 0.15 MHz to 30MHz.
2. The emissions measured in frequency range from 0.15 MHz to 30MHz were made with an instrument using Quasi-peak detector and average detector.
3. “---” denotes the emission level was or more than 2dB below the Average limit
4. The IF bandwidth of SPA between 0.15MHz to 30MHz was 10kHz; the IF bandwidth of Test Receiver between 0.15MHz to 30MHz was 9kHz;
5. L1 = Line One (Live Line) / L2 = Line Two (Neutral Line)



Test Data Plots

Conducted emissions (Line 1)

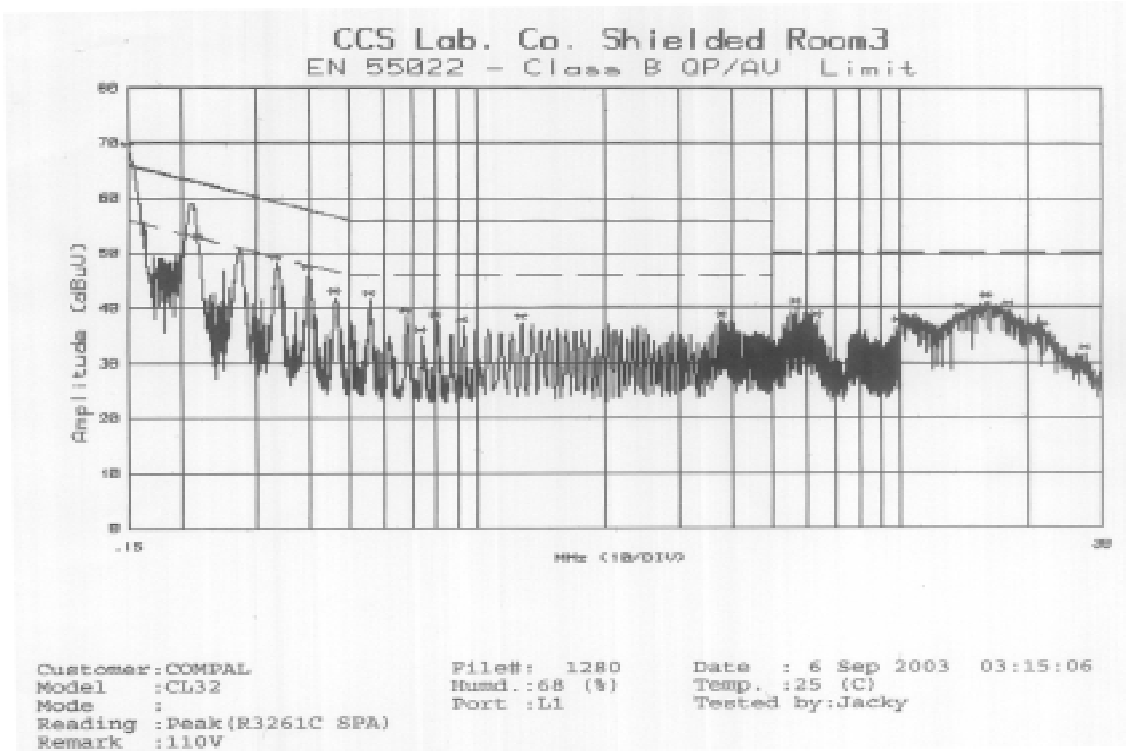

Conducted emissions (Line 2)

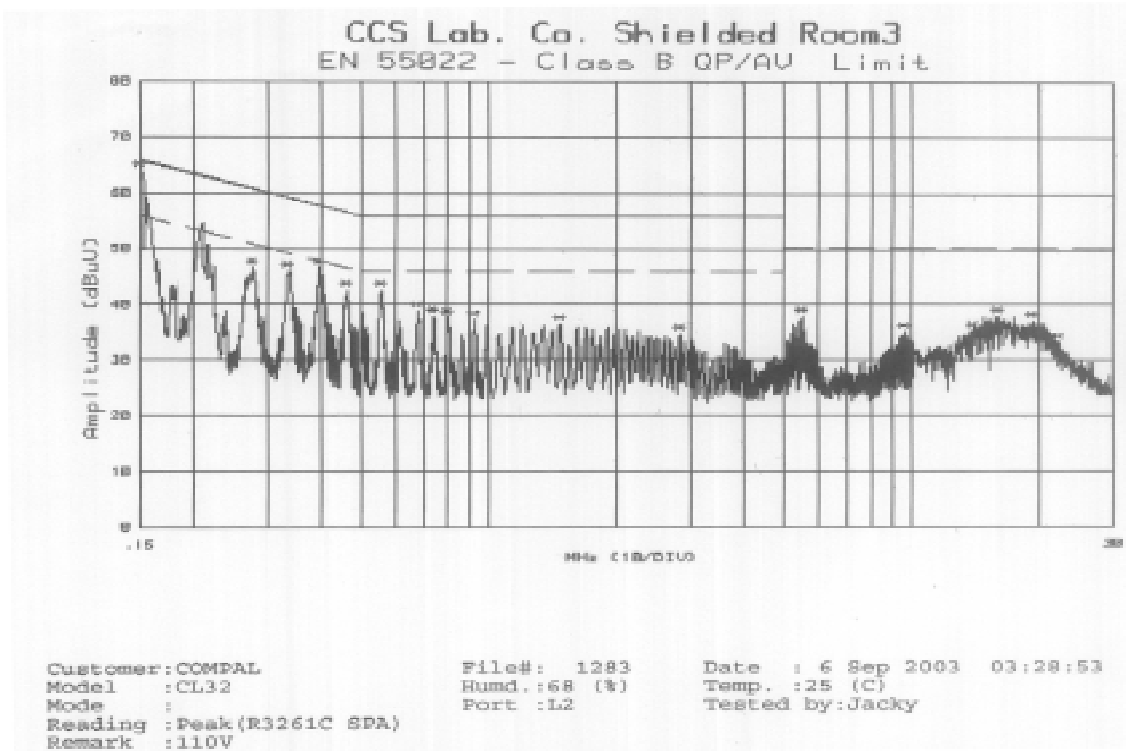

APPENDIX 1 PHOTOGRPHS OF TEST SETUP

Radiated Emission Set up Photos



Conducted Emission Set Up Photos



APPENDIX 2

EXTERNAL PHOTOGRPHS OF EUT

Front View of EUT



Back View of EUT



Left View of EUT



Right View of EUT



Front View of Power Adapter



Back View of Power Adapter



APPENDIX 3 INTERNAL PHOTOGRPHS OF EUT

Internal of EUT --- 1



Internal of EUT --- 2



Internal of EUT --- 3



Internal of EUT --- 4



Internal of EUT --- 5



Internal of EUT --- 6



Internal of EUT --- 7



Internal of EUT --- 8



Internal of EUT --- 9



Internal of EUT --- 10



Internal of EUT --- 11

