



**FCC CFR47 PART 22 SUBPART H
CERTIFICATION
TEST REPORT**

FOR

SINGLE BAND CDMA CELLULAR PHONE

MODEL NUMBER: VS510

FCC ID: GKRVS510

REPORT NUMBER: 05I3294

ISSUE DATE: MARCH 25, 2005

Prepared for
**COMPAL ELECTRONICS, INC.
8F, NO. 500, JUIKUANG ROAD
NEIHU, TAIPEI, TAIWAN ROC 114**

Prepared by
**COMPLIANCE ENGINEERING SERVICES, INC.
d.b.a.
COMPLIANCE CERTIFICATION SERVICES
561F MONTEREY ROAD,
MORGAN HILL, CA 95037, USA
TEL: (408) 463-0885
FAX: (408) 463-0888**

NVLAP[®]
LAB CODE:200065-0

Revision History

<u>Rev.</u>	<u>Revisions</u>	<u>Revised By</u>
-------------	------------------	-------------------

TABLE OF CONTENTS

1. ATTESTATION OF TEST RESULTS.....	4
2. TEST METHODOLOGY	5
3. FACILITIES AND ACCREDITATION	5
4. CALIBRATION AND UNCERTAINTY.....	5
4.1. MEASURING INSTRUMENT CALIBRATION.....	5
4.2. MEASUREMENT UNCERTAINTY.....	5
5. EQUIPMENT UNDER TEST.....	6
5.1. DESCRIPTION OF EUT.....	6
5.2. MAXIMUM OUTPUT POWER.....	6
5.3. DESCRIPTION OF AVAILABLE ANTENNAS.....	6
5.4. WORST-CASE CONFIGURATION AND MODE.....	6
5.5. DESCRIPTION OF TEST SETUP.....	7
6. TEST AND MEASUREMENT EQUIPMENT	9
7. LIMITS AND RESULTS	10
7.1. OCCUPIED BANDWIDTH.....	10
7.2. RF POWER OUTPUT.....	14
7.3. FREQUENCY STABILITY.....	16
7.4. SPURIOUS EMISSION AT ANTENNA TERMINAL.....	17
7.5. FIELD STRENGTH OF SPURIOUS RADIATION.....	24
8. DIGITAL DEVICE CONFIGURATION - LIMITS AND RESULTS	26
8.1. WORST-CASE RADIATED EMISSIONS BELOW 1 GHz.....	26
8.2. AC MAINS LINE CONDUCTED EMISSIONS.....	34
9. SETUP PHOTOS.....	39

1. ATTESTATION OF TEST RESULTS

COMPANY NAME: COMPAL ELECTRONICS INC.
8F, NO. 500, JUI-KUANG RD.
NEIHU, TAIPEI 114
TAIWAN

EUT DESCRIPTION: SINGLE BAND CDMA CELLULAR PHONE

MODEL: VS510

SERIAL NUMBER: 67255364

DATE TESTED: MARCH 15 – 23, 2005

APPLICABLE STANDARDS	
STANDARD	TEST RESULTS
FCC PART 22 SUBPART H	NO NON-COMPLIANCE NOTED
DIGITAL DEVICE CONFIGURATION: FCC PART 15 SUBPART B	NO NON-COMPLIANCE NOTED

Compliance Certification Services, Inc. tested the above equipment in accordance with the requirements set forth in the above standards. The test results show that the equipment tested is capable of demonstrating compliance with the requirements as documented in this report.

Note: The results documented in this report apply only to the tested sample, under the conditions and modes of operation as described herein. This document may not be altered or revised in any way unless done so by Compliance Certification Services and all revisions are duly noted in the revisions section. Any alteration of this document not carried out by Compliance Certification Services will constitute fraud and shall nullify the document. No part of this report may be used to claim product certification, approval, or endorsement by NVLAP, NIST, or any government agency.

Approved & Released For CCS By:

Tested By:



THU CHAN
EMC SUPERVISOR
COMPLIANCE CERTIFICATION SERVICES

WILLIAM ZHUANG & VIEN TRAN
EMC ENGINEERS
COMPLIANCE CERTIFICATION SERVICES

2. TEST METHODOLOGY

The tests documented in this report were performed in accordance with TIA/EIA 603A (2001), ANSI C63.4-2003, FCC CFR 47 Part 2, FCC CFR 47 Part 15 and FCC CFR 47 Part 22.

3. FACILITIES AND ACCREDITATION

The test sites and measurement facilities used to collect data are located at 561F Monterey Road, Morgan Hill, California, USA. The sites are constructed in conformance with the requirements of ANSI C63.4, ANSI C63.7 and CISPR Publication 22. All receiving equipment conforms to CISPR Publication 16-1, "Radio Interference Measuring Apparatus and Measurement Methods."

CCS is accredited by NVLAP, Laboratory Code 200065-0. The full scope of accreditation can be viewed at <http://www.ccsemc.com>.

4. CALIBRATION AND UNCERTAINTY

4.1. MEASURING INSTRUMENT CALIBRATION

The measuring equipment utilized to perform the tests documented in this report has been calibrated in accordance with the manufacturer's recommendations, and is traceable to recognized national standards.

4.2. MEASUREMENT UNCERTAINTY

Where relevant, the following measurement uncertainty levels have been estimated for tests performed on the apparatus:

PARAMETER	UNCERTAINTY
Radiated Emission, 30 to 200 MHz	+/- 3.3 dB
Radiated Emission, 200 to 1000 MHz	+4.5 / -2.9 dB
Radiated Emission, 1000 to 2000 MHz	+4.5 / -2.9 dB
Power Line Conducted Emission	+/- 2.9 dB

Uncertainty figures are valid to a confidence level of 95%.

5. EQUIPMENT UNDER TEST

5.1. DESCRIPTION OF EUT

The EUT is a Single mode (CDMA only) portable mobile station of which frequency range is 824 - 894MHz

5.2. MAXIMUM OUTPUT POWER

The transmitter has a maximum ERP as follows:

800 to 880 MHz Authorized Band			
Frequency Range (MHz)	Modulation	Output ERP (dBm)	Output ERP (mW)
824.76 - 848.31	CDMA	27.20	524.81

5.3. DESCRIPTION OF AVAILABLE ANTENNAS

The radio utilizes a Helix -Fixed antenna with 1.5dBi gain.

5.4. WORST-CASE CONFIGURATION AND MODE

The worst-case channel is determined as the channel with the highest output power. The highest measured output power was at 835.89 MHz.

5.5. DESCRIPTION OF TEST SETUP

SET UP FOR RF TEST

SUPPORT EQUIPMENT

The EUT is installed as a stand-alone device during the tests

I/O CABLES

The EUT is installed as a stand-alone device during the tests

TEST SETUP

The EUT is installed as a stand-alone device during the tests

SET UP FOR DIGITAL TEST

SUPPORT EQUIPMENT

TEST PERIPHERALS				
Device Type	Manufacturer	Model Number	Serial Number	FCC ID
AC Adapter Earphone	Compal Electronic NA	KWT05A7JL0017 NA	NA NA	DoC NA

I/O CABLES

TEST I / O CABLES								
Cable No	I/O Port	# of I/O Port	Connector Type	Type of Cable	Cable Length	Data Traffic	Bundled	Remark
1	AC	1	US 115V	Un-shielded	2m	No	No	N/A
2	DC	1	DC	Un-shielded	1m	No	No	N/A

TEST SETUP

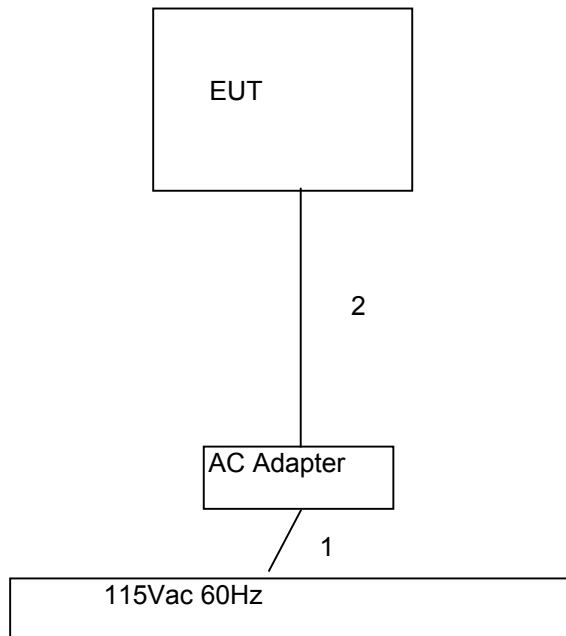

6. TEST AND MEASUREMENT EQUIPMENT

The following test and measurement equipment was utilized for the tests documented in this report:

TEST EQUIPMENT LIST				
Description	Manufacturer	Model	Serial Number	Cal Due
Peak / Average Power Sensor	Agilent	E9327A	US40440755	3/9/2006
Peak Power Meter	Agilent	E4416A	GB41291160	3/9/06
Spectrum Analyzer, 26.5 GHz	HP	8593EM	3710A00205	1/6/06
Site A Preamplifier, 1300MHz	HP	8447D	2944A06833	8/17/05
Spectrum Analyzer 20 Hz ~ 44 GHz	Agilent	E4446A	US42070220	1/13/06
Signal Generator, 2 ~ 40 GHz	R & S	SMP04	DE 34210	5/25/05
Site B Antenna, Bilog	Chase	CBL6112B	2586	3/3/2006
Antenna, Horn 1 ~ 18 GHz	EMCO	3115	2238	2/4/06
Antenna, Tuned Dipoe	CDI	ROBERTS	117	5/15/05
Antenna, Horn 1 ~ 18 GHz	EMCO	3115	6717	2/4/06
Antenna, Tuned Dipoe	CDI	ROBERTS	117	5/15/05
LISN, 10 kHz ~ 30 MHz	FCC	50/250-25-2	114	10/21/05
EMI Test Receiver	R & S	ESHS 20	827129/006	10/22/05
Line Filter	Lindgren	LMF-3489	497	CNR

7. LIMITS AND RESULTS

7.1. OCCUPIED BANDWIDTH

LIMIT

None; for reporting purposes only.

TEST PROCEDURE

The transmitter output is connected to the spectrum analyzer. The RBW is set to 1% to 3% of the -26 dB bandwidth. The VBW is set to 3 times the RBW. The sweep time is coupled. The spectrum analyzer internal -26 dB bandwidth function is utilized.

RESULTS

No non-compliance noted:

CDMA Modulation

Channel	Frequency (MHz)	Bandwidth (MHz)
Low	824.76	1.412
Middle	835.89	1.395
High	848.31	1.369

CDMA 26 dB BANDWIDTH

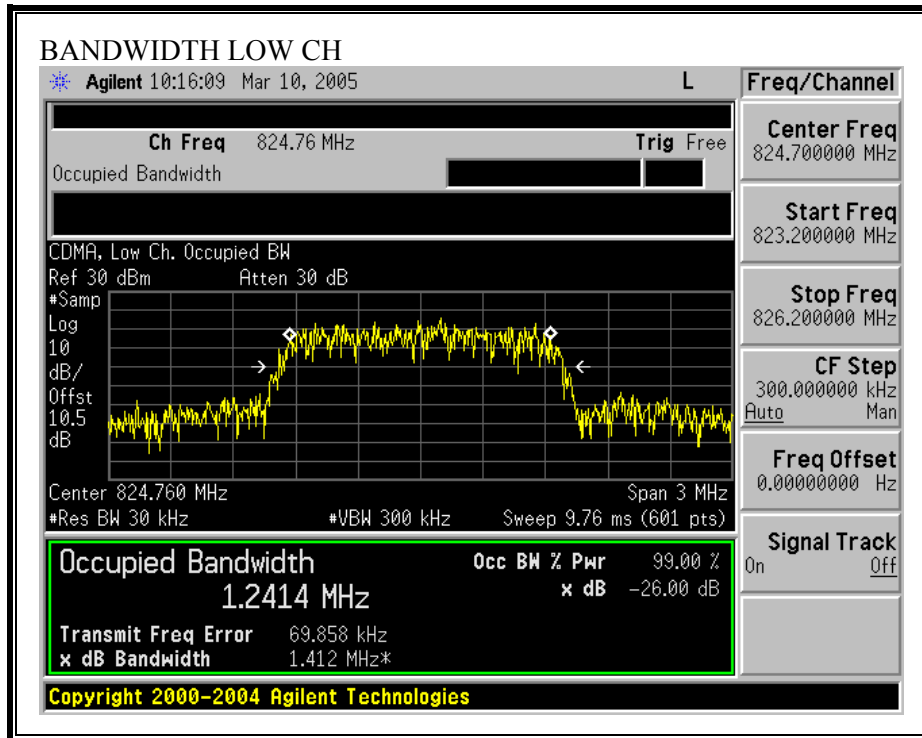

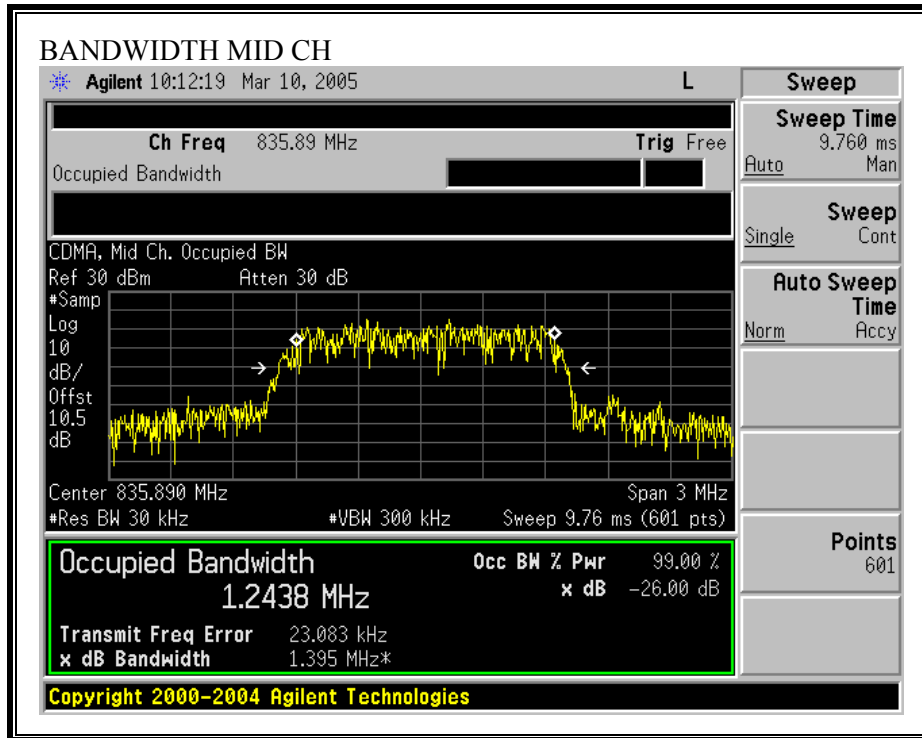

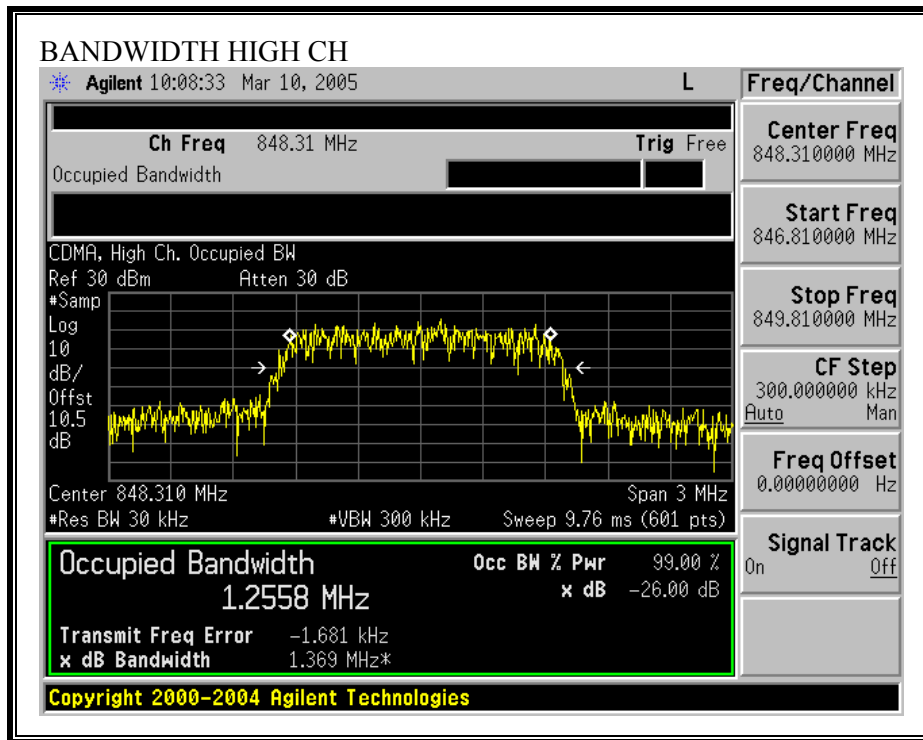

7.2. RF POWER OUTPUT

LIMIT

22.913(a) The ERP of mobile transmitters and auxiliary test transmitters must not exceed 7 Watts.

TEST PROCEDURE

ANSI / TIA / EIA 603 Clause 2.2.17

RESULTS

No non-compliance noted.

CDMA Output Power (ERP)

03/10/05 **High Frequency Substitution Measurement**
 Compliance Certification Services, Morgan Hill Open Field Site

Test Engr: William Zhuang
 Project #: 05I3294
 Company: Vacom Wireless Inc.
 EUT Descrip.: 800MHz CDMA cellular Phone
 EUT M/N: V8510 (FCC ID: GKRVS510)
 Test Target: FCC Part 22
 Mode Oper: TX LOW, MID & HI CHANNELS FUNDAMENTAL SUBSTITUTION

Test Equipment:

EMCO Horn 1-18 GHz	Pre-amplifier 1-26GHz	Spectrum Analyzer	Horn > 18GHz	Limit
▼	▼	▼	▼	ERP

Hi Frequency Cables

<input type="checkbox"/> (2 ft)	<input type="checkbox"/> (2 ~ 3 ft)	<input checked="" type="checkbox"/> (4 ~ 6 ft)	<input type="checkbox"/> (12 ft)
---------------------------------	-------------------------------------	------------------------------------------------	----------------------------------

Peak Measurements:

Fundamental: RBW>99% or 26dB Emissions BW VBW=RBW	Bandedge: RBW=>1% Emissions BW VBW=> 3*RBW	Spurious RBW=1MHz VBW=1MHz
----------------------------------------------------------------	---------------------------------------------------------	-----------------------------------------

f GHz	SA reading (dBuV)	SG reading (dBm)	CL (dB)	Gain (dBi)	Gain (dBd)	ERP (dBm)	Limit (dBm)	Margin (dB)	Notes
0.82476	90.4	24.3	0.3	0.0	-2.2	24.0	38.0	-14.0	Low Ch, V
0.82476	88.1	18.3	0.3	0.0	-2.2	18.0	38.0	-20.0	Low Ch, H
0.83589	91.7	25.6	0.3	0.0	-2.2	25.3	38.0	-12.7	Mid Ch, V
0.83589	97.3	27.5	0.3	0.0	-2.2	27.2	38.0	-10.8	Mid Ch, H
0.84831	91.4	25.3	0.3	0.0	-2.2	25.0	38.0	-13.0	High Ch, V
0.84831	86.4	16.6	0.3	0.0	-2.2	16.3	38.0	-21.7	High Ch, H

7.3. FREQUENCY STABILITY

LIMIT

§22.355 Except as otherwise provided in this part, the carrier frequency of each transmitter in the Public Mobile Services must be maintained within the tolerances given in Table C-1 of this section.

For Mobile devices operating in the 824 to 849 MHz band at a power level less than or equal to 3 Watts, the limit specified in Table C-1 is +/- 2.5 ppm.

TEST PROCEDURE

ANSI / TIA / EIA 603 Clause 2.3.1 and 2.3.2

RESULTS

No non-compliance noted.

Reference Frequency: CDMA Mid Channel 835.23433MHz @ 25°C				
Limit: ± 2.5 ppm = 2088.086 Hz				
Power Supply (Vdc)	Environment Temperature (°C)	Frequency Deviation Measured with Time Elapse		
		(MHz)	Delta (ppm)	Limit (ppm)
3.80	50	835.23383	0.599	± 2.5
3.80	40	835.23423	0.122	± 2.5
3.80	30	835.23430	0.042	± 2.5
3.80	25	835.23433	0	± 2.5
3.80	20	835.23415	0.220	± 2.5
3.80	10	835.23426	0.087	± 2.5
3.80	0	835.23427	0.068	± 2.5
3.80	-10	835.23414	0.230	± 2.5
3.80	-20	835.23439	-0.068	± 2.5
3.80	-30	835.23456	-0.272	± 2.5
3.23	25	835.23363	0.838	± 2.5
4.37	25	835.23416	0.204	± 2.5
3.0 (endpoint)	25	835.23303	1.556	± 2.5

7.4. SPURIOUS EMISSION AT ANTENNA TERMINAL

LIMIT

§22.917 (e) Out of band emissions. The power of any emission outside of the authorized operating frequency ranges must be attenuated below the transmitting power (P) by a factor of at least $43 + 10 \log (P)$ dB.

TEST PROCEDURE

ANSI / TIA / EIA 603 Clause 3.2.13 & FCC 22.917 (h)

RESULTS

No non-compliance noted.

CDMA MODULATION RESULTS

CDMA Modulation: Low Channel Out-Of-Band Emissions

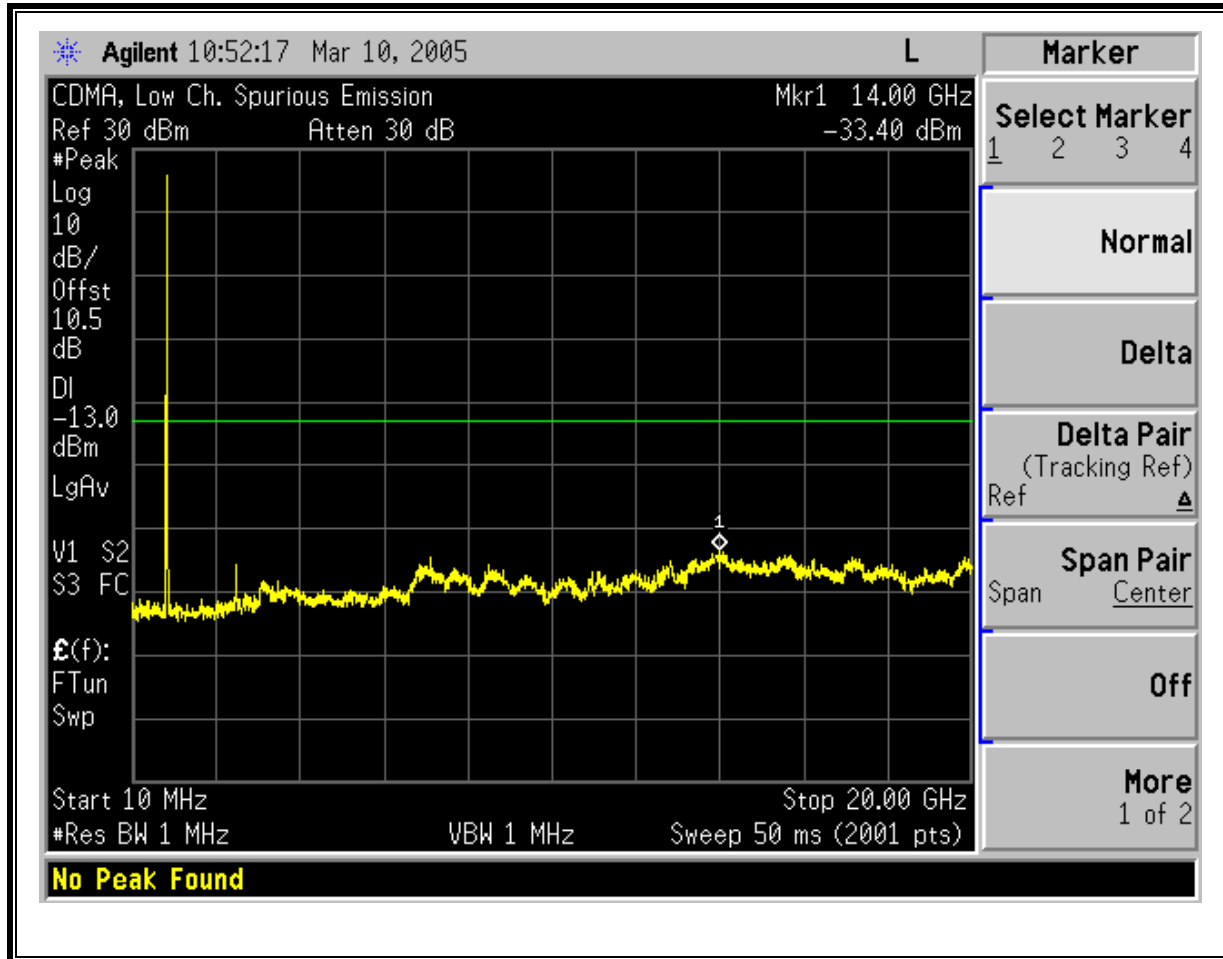

CDMA Modulation: Mid Channel Out-Of-Band Emissions

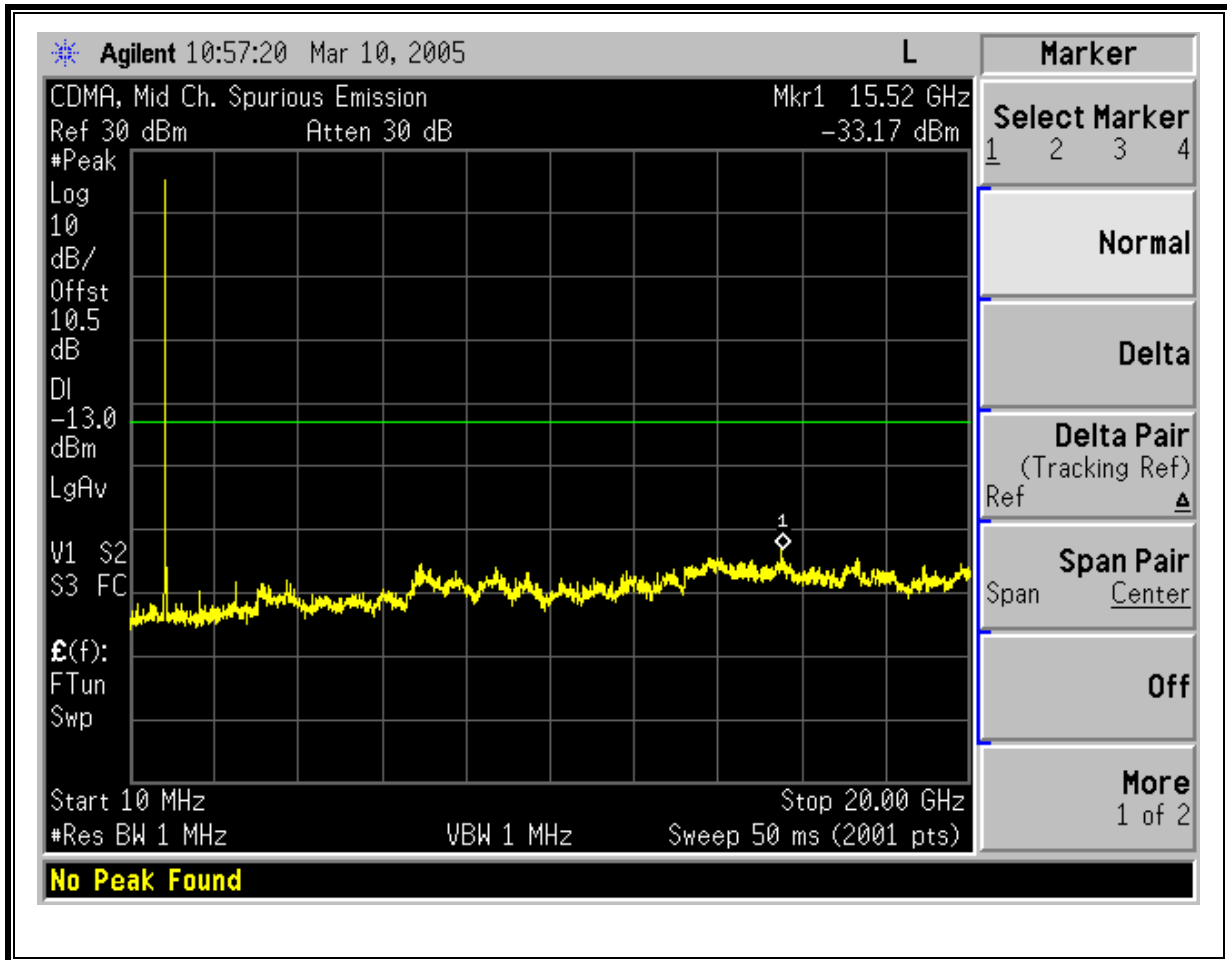

CDMA Modulation: High Channel Out-Of-Band Emissions

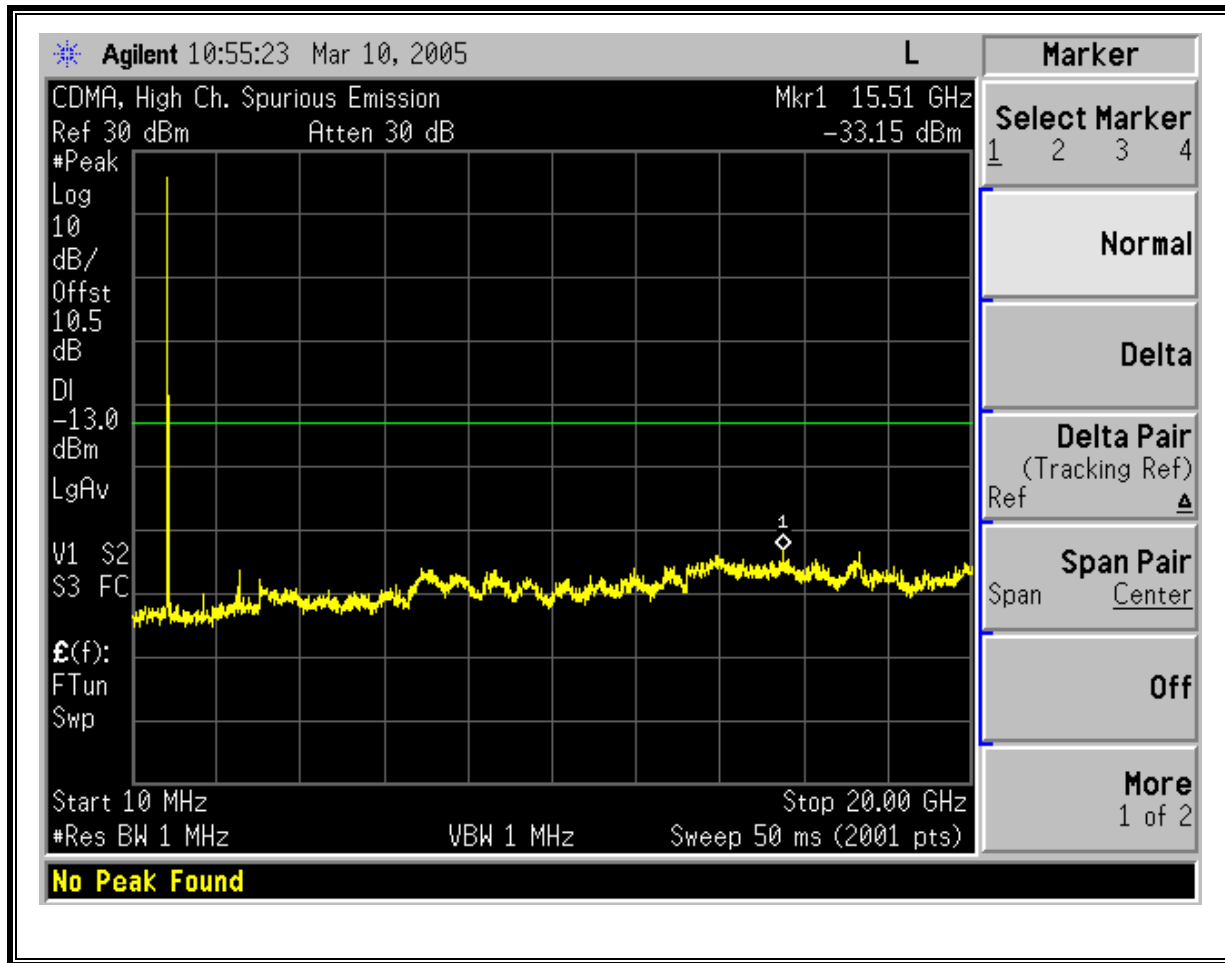

CDMA Modulation: Low Channel Band Edge

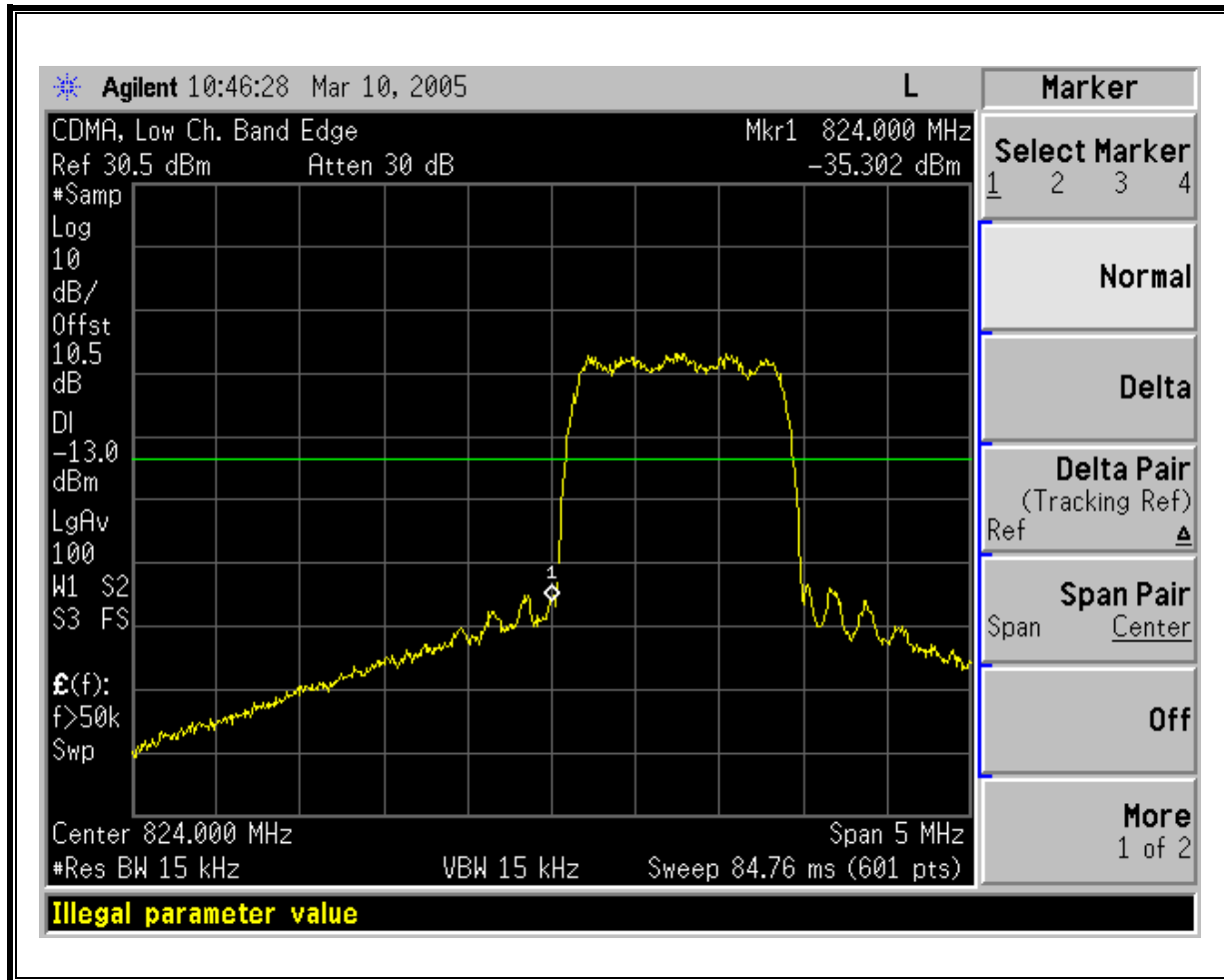

CDMA Modulation: High Channel Band Edge

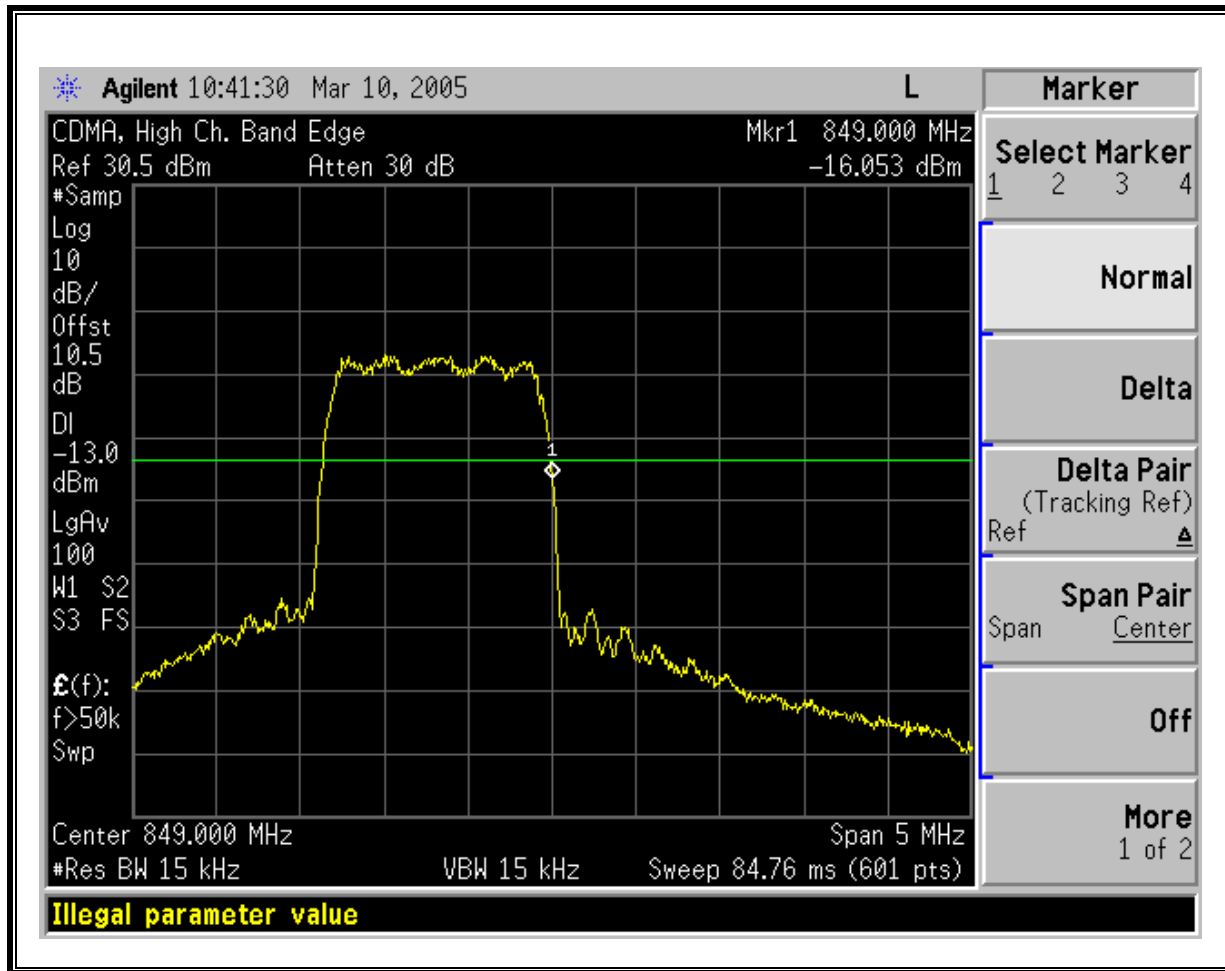

CDMA Mobile Emissions in Base Frequency Range

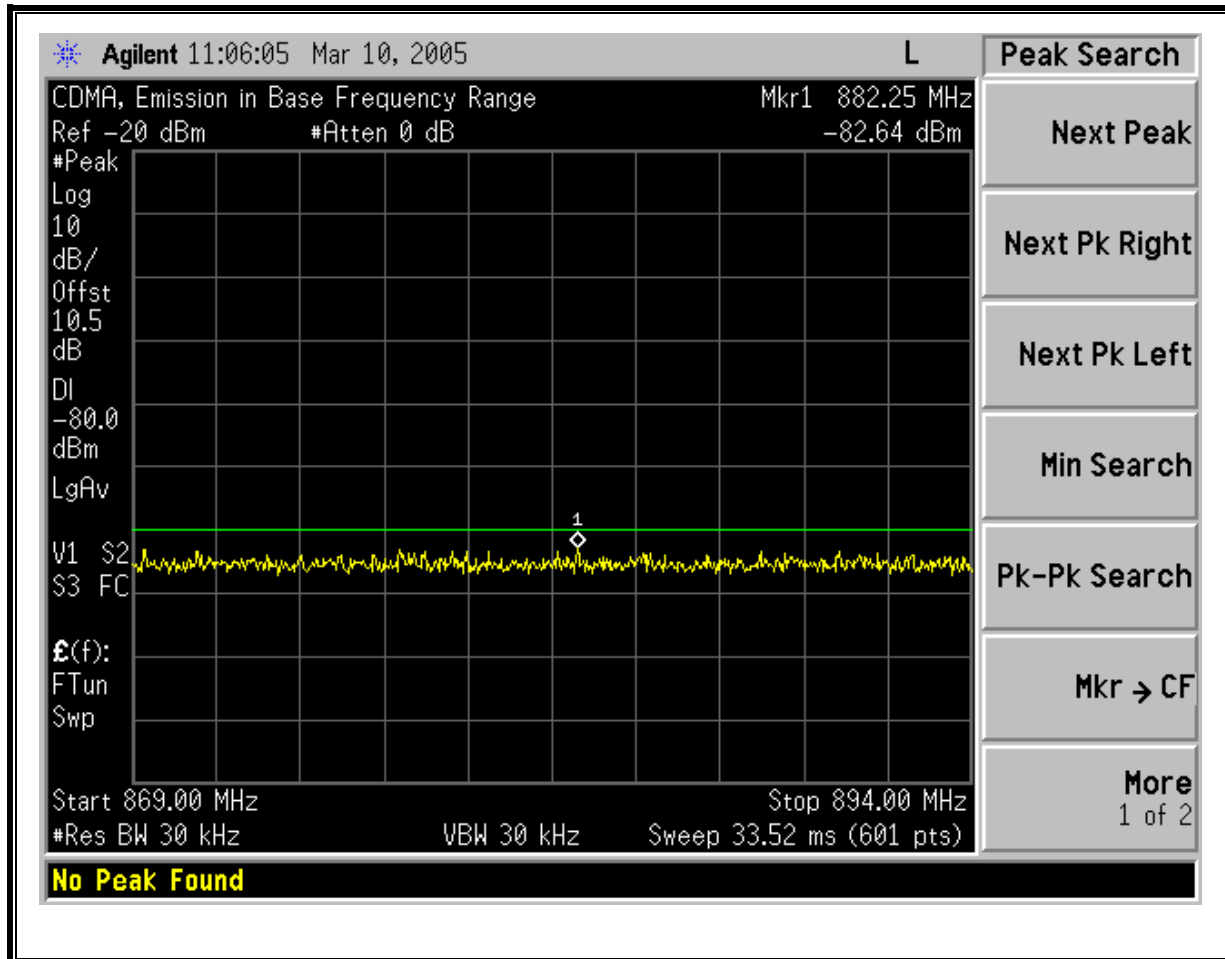

7.5. FIELD STRENGTH OF SPURIOUS RADIATION

LIMIT

§22.917 (a) Out of band emissions. The power of any emission outside of the authorized operating frequency ranges must be attenuated below the transmitting power (P) by a factor of at least $43 + 10 \log (P)$ dB.

TEST PROCEDURE

ANSI / TIA / EIA 603 Clause 3.2.12 & FCC 22.917 (b)

RESULTS

No non-compliance noted.

CDMA Spurious & Harmonic (ERP)

3/12/2005 High Frequency Substitution Measurement
 Compliance Certification Services, Morgan Hill 5m Chamber Site

Test Engr: Chin Pang
 Project #:05I3294-1
 Company: Vacom Wireless, Inc.
 EUT Descrip.: 800MHz CDMA Cellular Phone
 EUT M/N: VS510 (FCC ID: GKRVS510)
 Test Target: FCC Part 22
 Mode Oper: TX HAR & SPUR_LOW, MID & HI CHANNELS SUBSTITUTION

Test Equipment:

EMCO Horn 1-18GHz Horn > 18GHz Limit High Pass Filter
 T73; S/N: 6717 @3m FCC 22

Hi Frequency Cables Pre-amplifier 1-26GHz Pre-amplifier 26-40GHz
 (2 ft) (2~3 ft) (4~6 ft) (12 ft) T63 Miteq 646456

f GHz	SA reading (dBuV/m)	Ant. Pol. (H/V)	SG reading (dBm)	CL (dB)	Gain (dBi)	Gain (dBd)	ERP (dBm)	Limit (dBm)	Margin (dB)	Notes
low ch, 824.76MHz										
1.649	63.6	V	-40.9	1.6	7.5	5.4	-37.1	-13.0	-24.1	
2.474	62.3	V	-38.6	1.9	8.6	6.4	-34.1	-13.0	-21.1	
3.299	45.6	V	-52.7	2.3	9.3	7.2	-47.8	-13.0	-34.8	Noise floor
1.649	62.0	H	-41.8	1.6	7.5	5.4	-38.0	-13.0	-25.0	
2.474	64.0	H	-36.7	1.9	8.6	6.4	-32.2	-13.0	-19.2	
3.299	45.0	H	-53.2	2.3	9.3	7.2	-48.3	-13.0	-35.3	Noise floor
Mid Ch, 835.89MHz										
1.672	64.1	V	-40.3	1.6	7.6	5.4	-36.5	-13.0	-23.5	
2.508	60.4	V	-39.8	1.9	8.6	6.4	-35.3	-13.0	-22.3	
3.344	45.0	V	-53.2	2.3	9.3	7.2	-48.3	-13.0	-35.3	Noise floor
1.672	61.0	H	-42.7	1.6	7.6	5.4	-38.8	-13.0	-25.8	
2.508	59.2	H	-41.4	1.9	8.6	6.4	-36.9	-13.0	-23.9	
3.344	44.6	H	-53.5	2.3	9.3	7.2	-48.6	-13.0	-35.6	Noise floor
High Ch, 848.31MHz										
1.697	62.6	V	-41.7	1.6	7.6	5.5	-37.8	-13.0	-24.8	
2.545	58.7	V	-42.0	2.0	8.6	6.5	-37.4	-13.0	-24.4	
3.393	45.8	V	-52.3	2.3	9.4	7.2	-47.4	-13.0	-34.4	Noise floor
1.697	60.0	H	-43.6	1.6	7.6	5.5	-39.7	-13.0	-26.7	
2.545	56.0	H	-44.5	2.0	8.6	6.5	-39.9	-13.0	-26.9	
3.393	44.5	H	-53.5	2.3	9.4	7.2	-48.6	-13.0	-35.6	Noise floor
Note: No other emissions were detected above the system noise floor.										

8. DIGITAL DEVICE CONFIGURATION - LIMITS AND RESULTS

8.1. WORST-CASE RADIATED EMISSIONS BELOW 1 GHz

SPURIOUS EMISSIONS 30 TO 1000 MHz (WORST-CASE CONFIGURATION, HORIZONTAL)

LINK TO LAPTOP

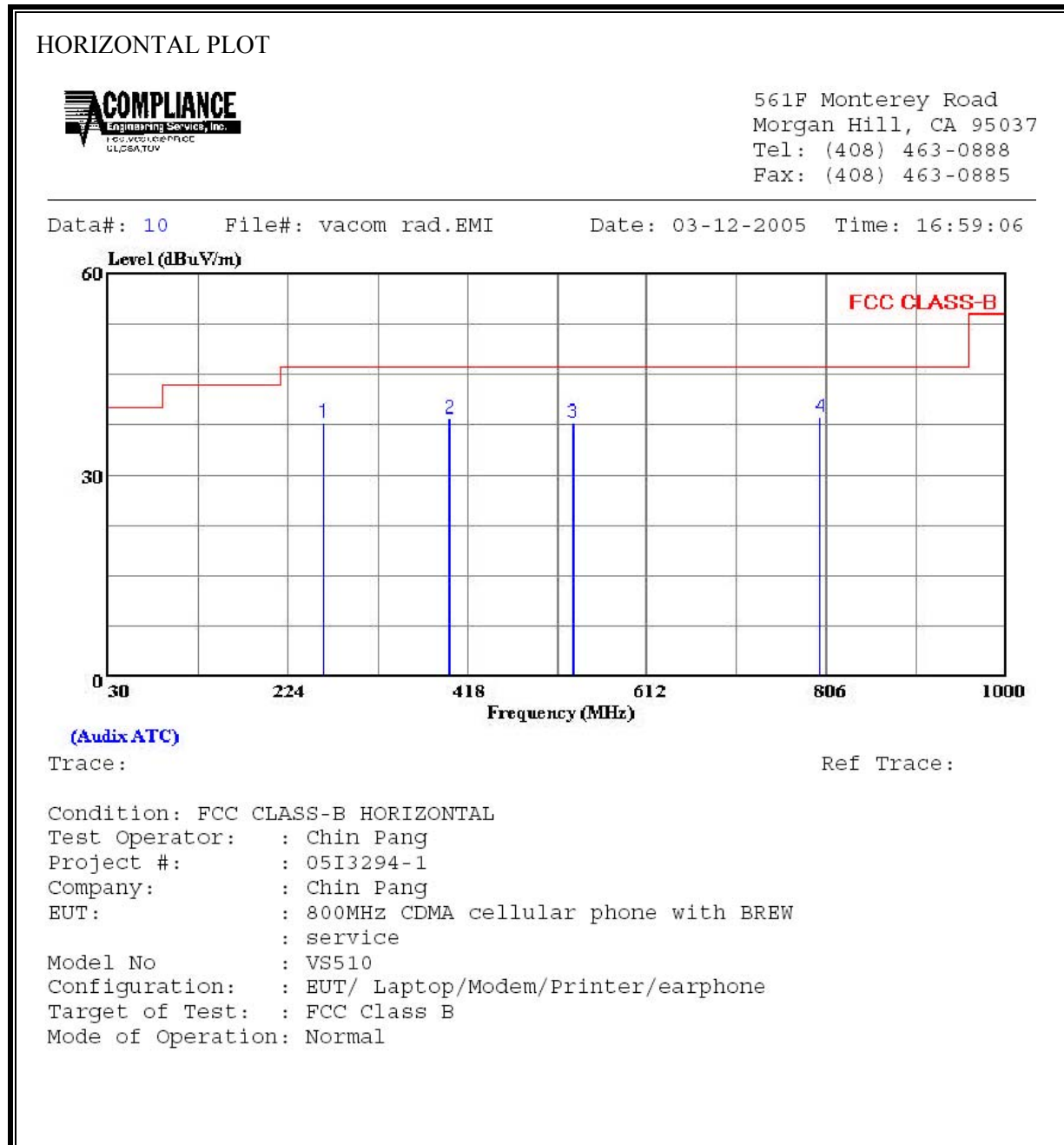

HORIZONTAL DATA

	Freq	Read Level	Factor	Level	Limit Line	Over Limit	Remark
	MHz	dBuV	dB	dBuV/m	dBuV/m	dB	
1	262.800	51.10	-13.22	37.88	46.00	-8.12	Peak
2	398.600	47.90	-9.55	38.35	46.00	-7.65	Peak
3	532.460	44.50	-6.70	37.80	46.00	-8.20	Peak
4	799.210	40.40	-1.80	38.60	46.00	-7.40	Peak

SPURIOUS EMISSIONS 30 TO 1000 MHz (WORST-CASE CONFIGURATION, VERTICAL)

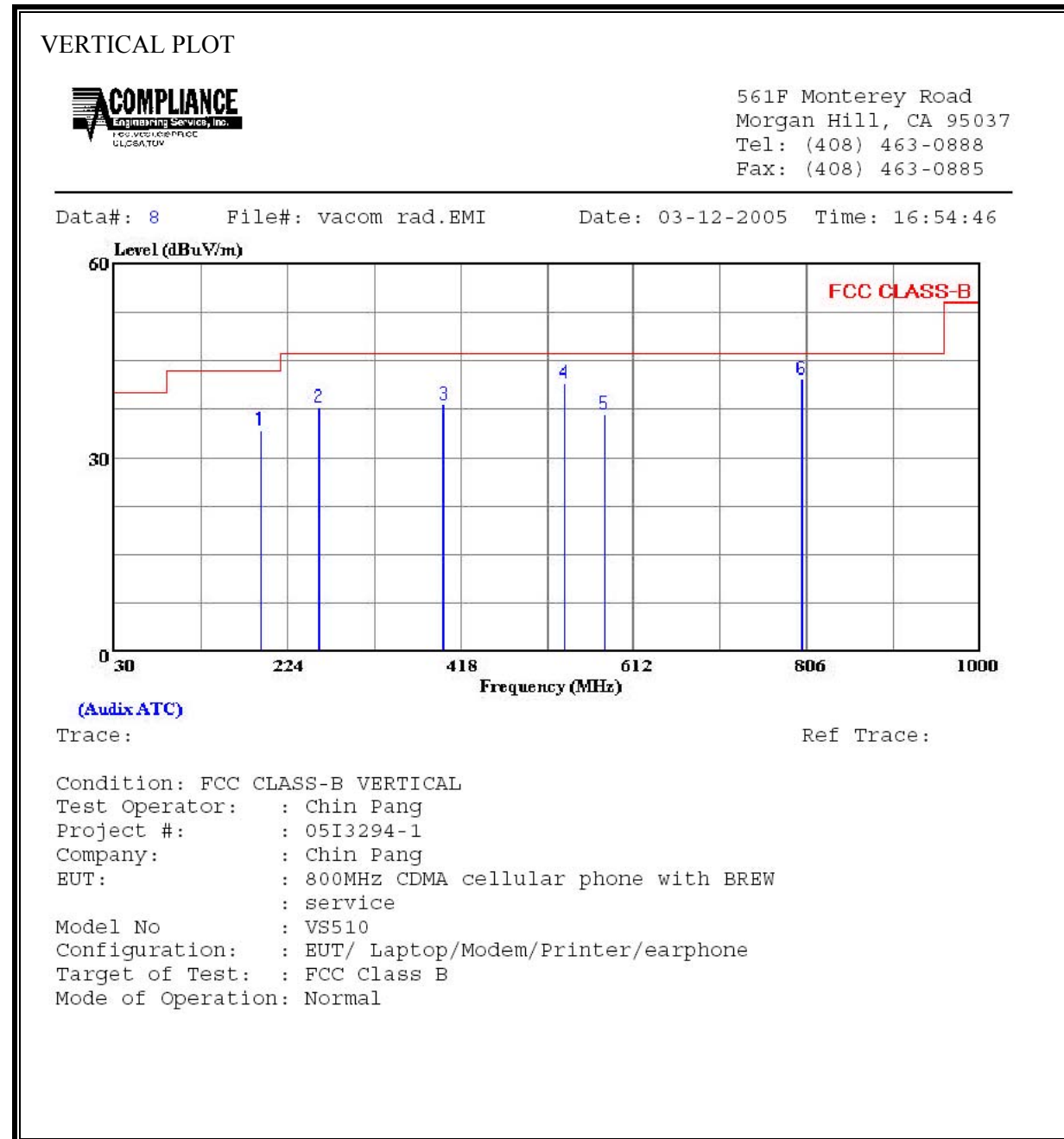

VERTICAL DATA							
	Freq	Read Level	Factor	Level	Limit Line	Over Limit	Remark
	MHz	dBuV	dB	dBuV/m	dBuV/m	dB	
1	193.930	48.30	-14.11	34.19	43.50	-9.31	Peak
2	258.920	51.10	-13.35	37.75	46.00	-8.25	Peak
3	398.600	47.70	-9.55	38.15	46.00	-7.85	Peak
4	533.430	48.20	-6.67	41.53	46.00	-4.47	Peak
5	579.020	42.50	-5.83	36.67	46.00	-9.33	Peak
6	800.180	44.00	-1.79	42.21	46.00	-3.79	Peak

SPURIOUS EMISSIONS 30 TO 1000 MHz (WORST-CASE CONFIGURATION, HORIZONTAL)

STAND-ALONE

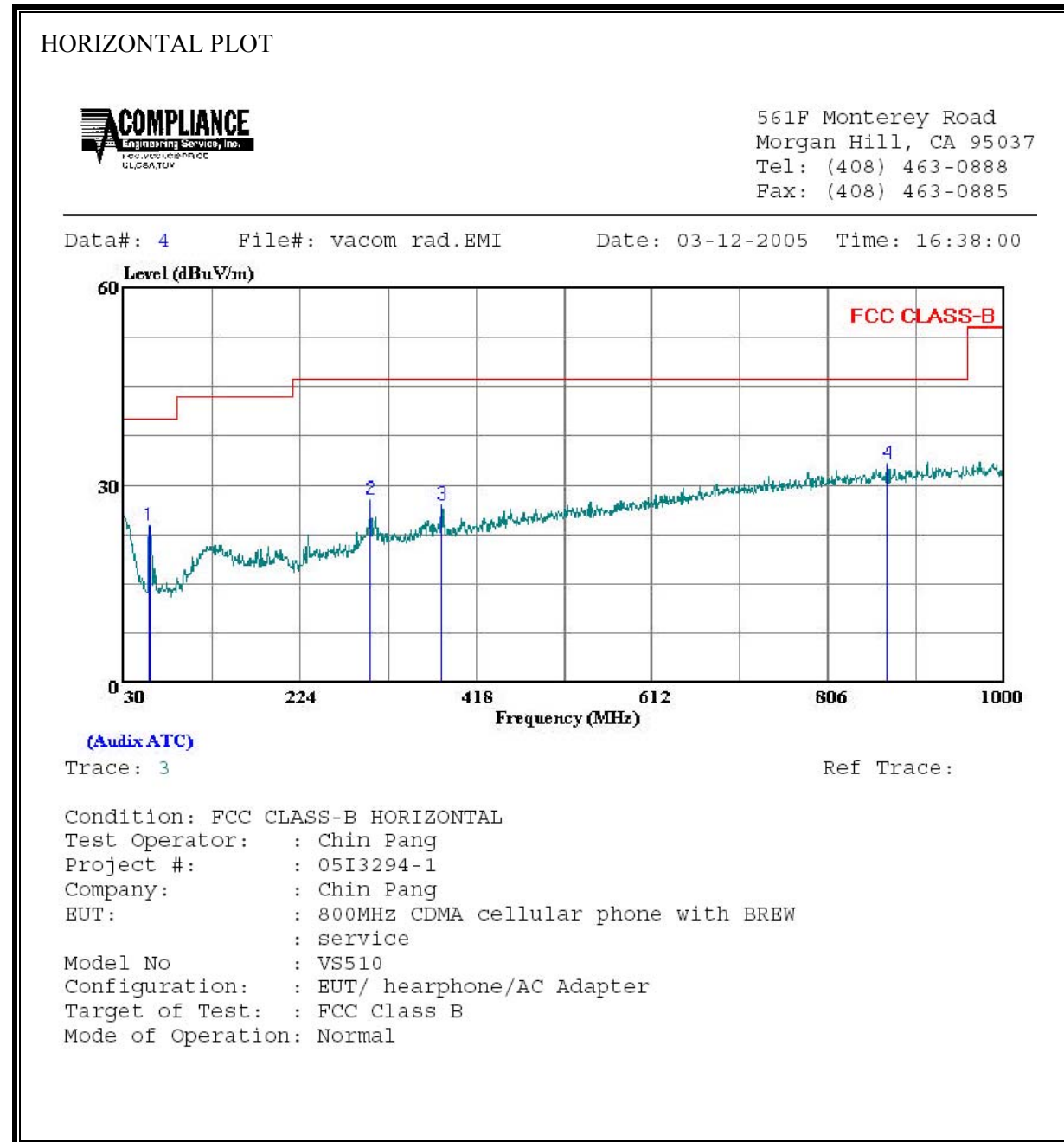

HORIZONTAL DATA

	Freq	Read Level	Factor	Level	Limit Line	Over Limit	Remark
	MHz	dBuV	dB	dBuV/m	dBuV/m	dB	
1	58.130	43.20	-19.28	23.92	40.00	-16.08	Peak
2	301.600	39.70	-11.82	27.88	46.00	-18.12	Peak
3	380.170	36.90	-9.95	26.95	46.00	-19.05	Peak
4	870.990	34.30	-1.17	33.13	46.00	-12.87	Peak

SPURIOUS EMISSIONS 30 TO 1000 MHz (WORST-CASE CONFIGURATION, VERTICAL)

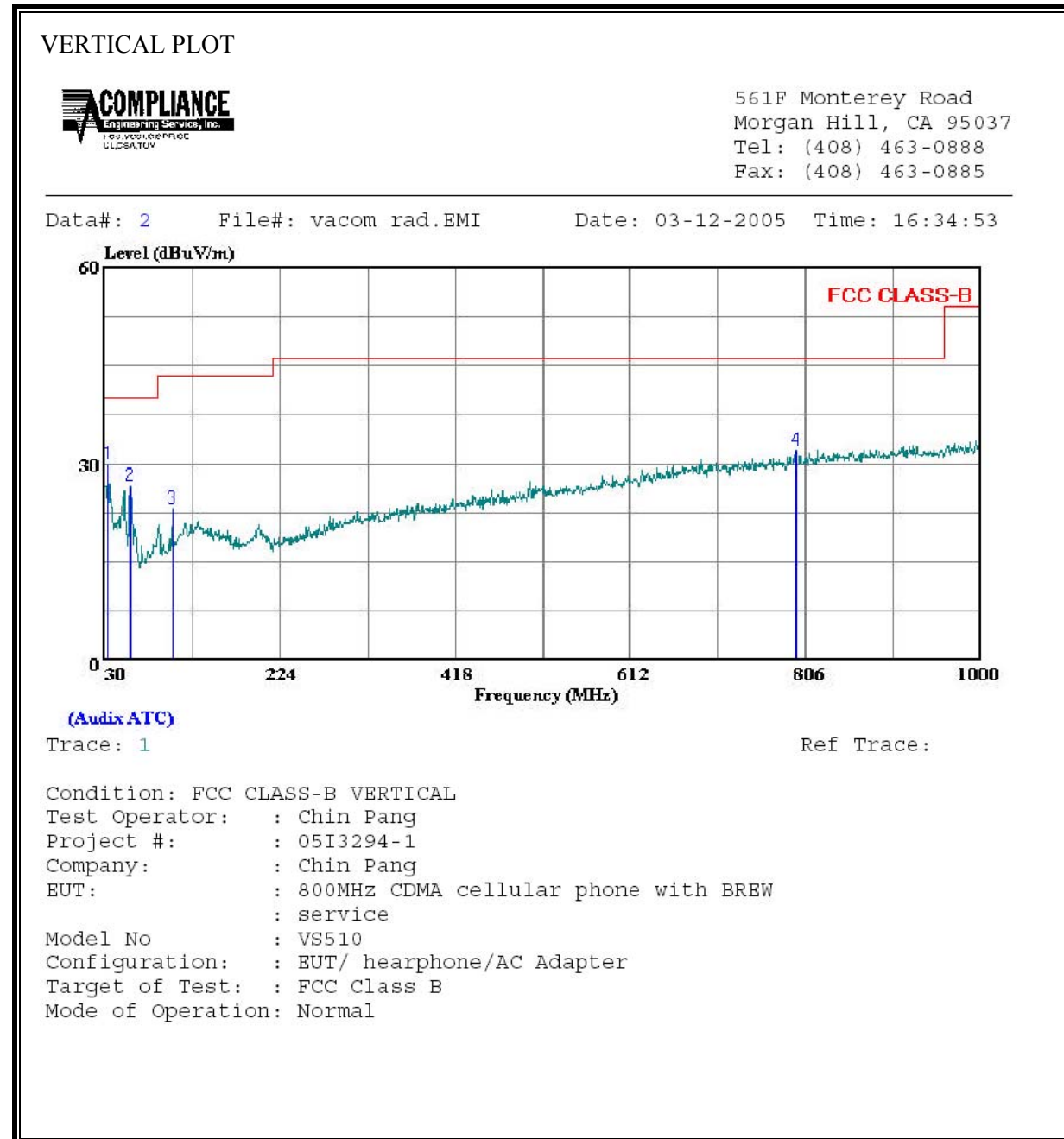

VERTICAL DATA

	Freq	Read Level	Factor	Level	Limit Line	Over Limit	Remark
	MHz	dBuV	dB	dBuV/m	dBuV/m	dB	
1	33.880	38.70	-8.87	29.83	40.00	-10.17	Peak
2	58.130	45.80	-19.28	26.52	40.00	-13.48	Peak
3	104.690	38.40	-15.42	22.98	43.50	-20.52	Peak
4	795.330	33.80	-1.87	31.93	46.00	-14.07	Peak

8.2. AC MAINS LINE CONDUCTED EMISSIONS

TEST PROCEDURE

ANSI C63.4

LIMIT

§15.107 (a) Except for Class A digital devices, for equipment that is designed to be connected to the public utility (AC) power line, the radio frequency voltage that is conducted back onto the AC power line on any frequency or frequencies within the band 150 kHz to 30 MHz shall not exceed the limits in the following table, as measured using a 50 μ H/50 ohms line impedance stabilization network (LISN). Compliance with the provisions of this paragraph shall be based on the measurement of the radio frequency voltage between each power line and ground at the power terminal. The lower limit applies at the band edges.

Frequency range (MHz)	Limits (dB μ V)	
	Quasi-peak	Average
0.15 to 0.50	66 to 56	56 to 46
0.50 to 5	56	46
5 to 30	60	50

Notes:
1. The lower limit shall apply at the transition frequencies
2. The limit decreases linearly with the logarithm of the frequency in the range 0.15 MHz to 0.50 MHz.

RESULTS

No non-compliance noted:

LINK TO LAPTOP

LINE 1 RESULTS

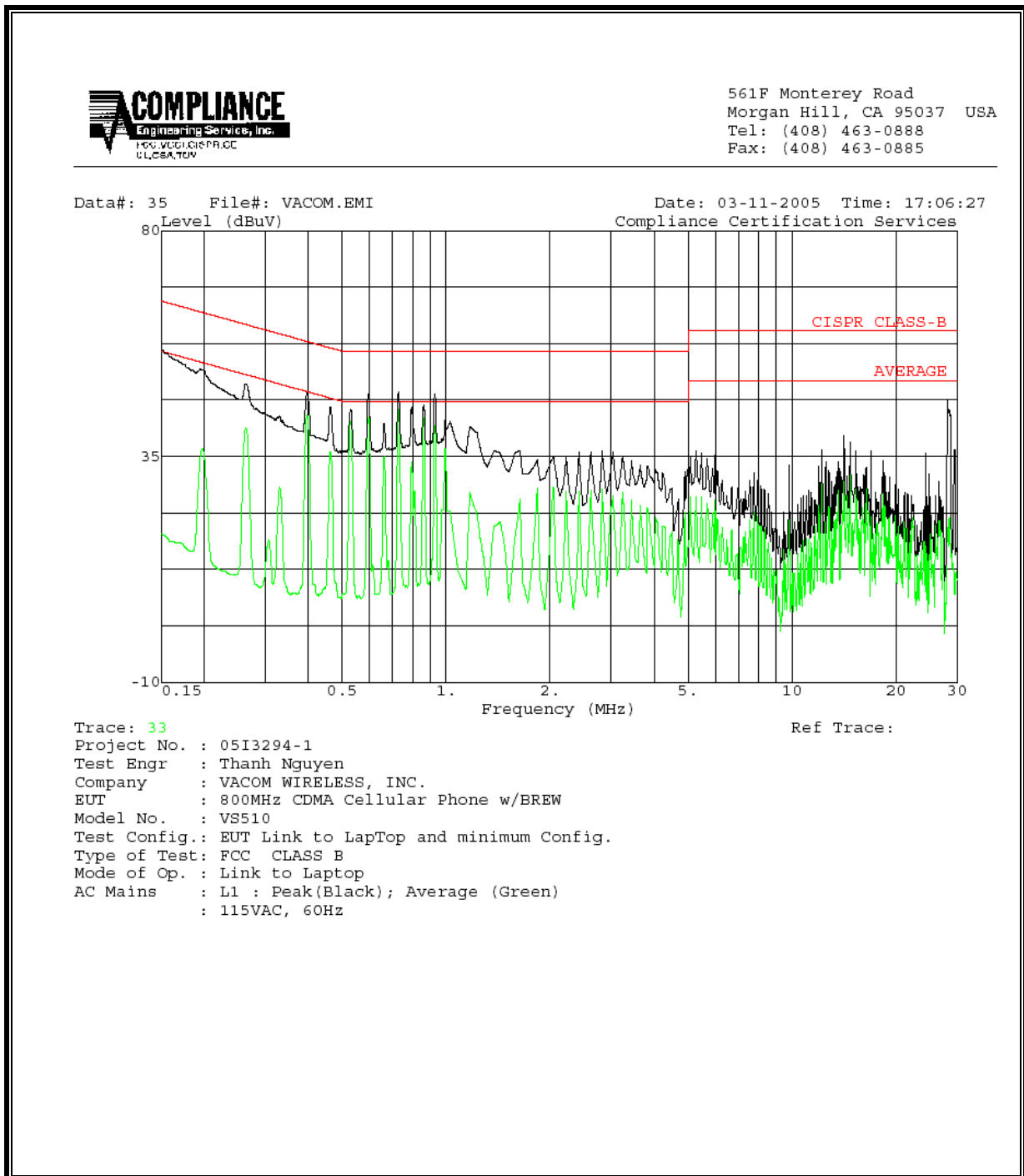

LINE 2 RESULTS

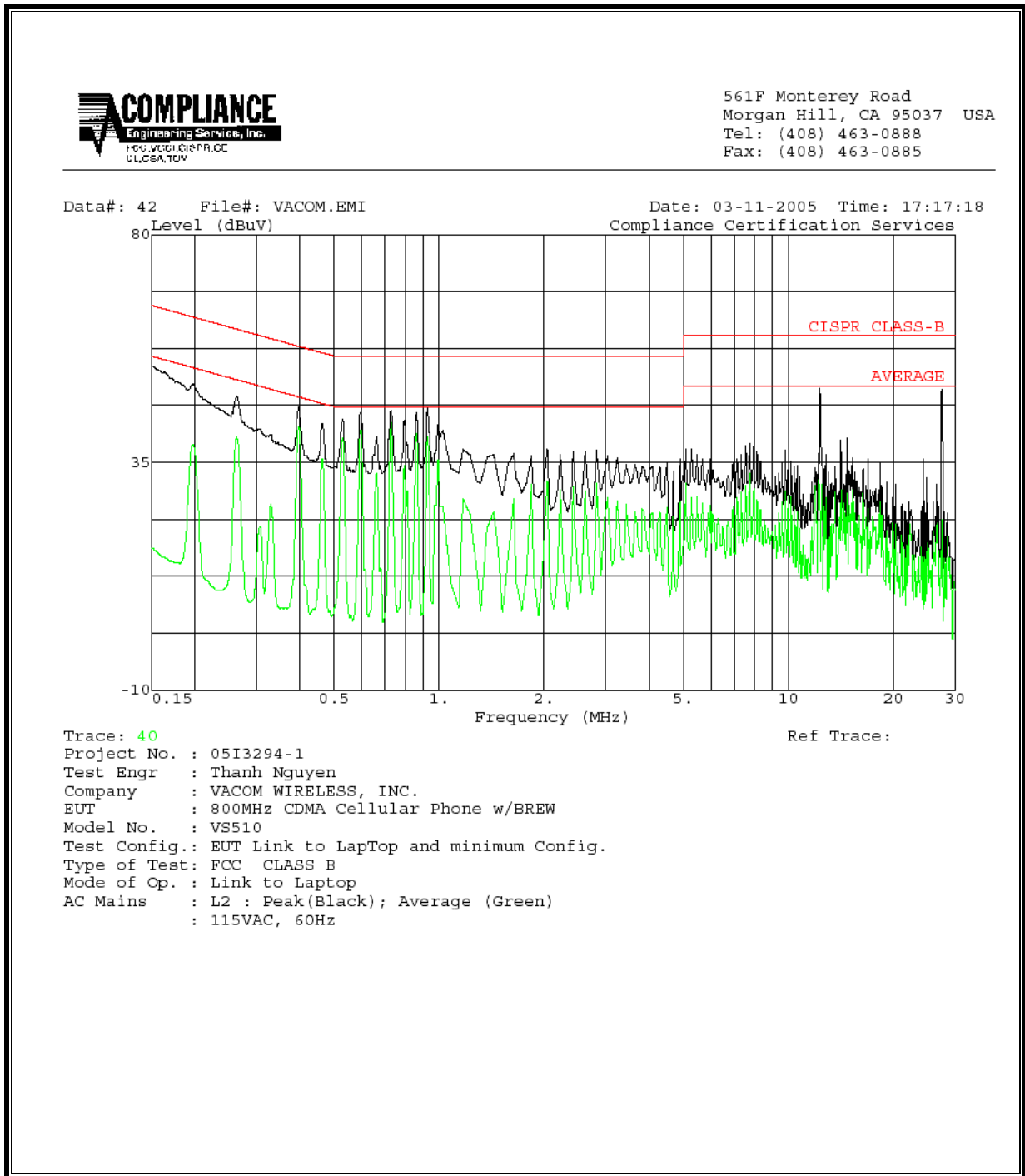

STAND-ALONE

LINE 1 RESULTS

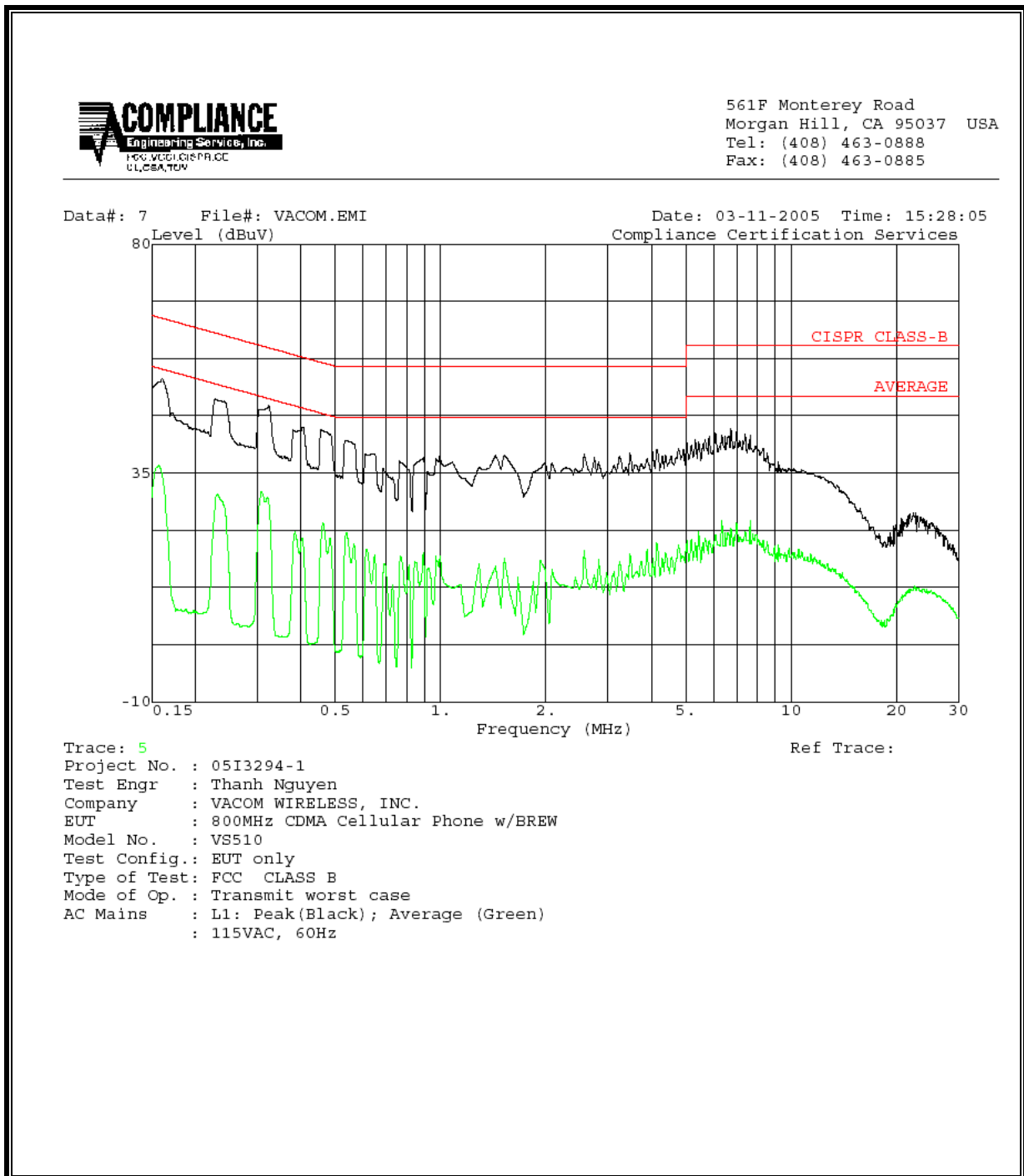

LINE 2 RESULTS

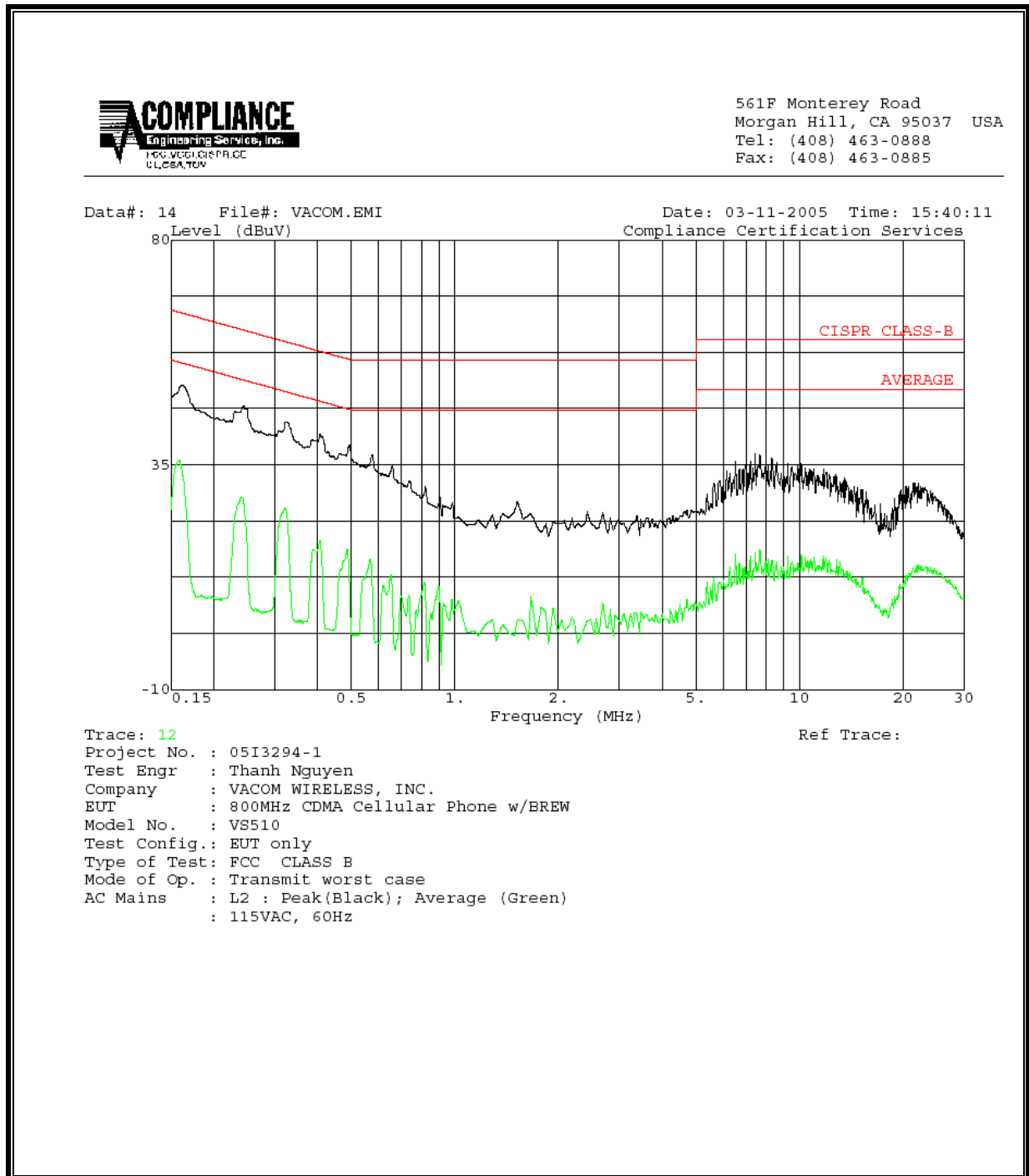

9. SETUP PHOTOS

ANTENNA PORT CONDUCTED RF MEASUREMENT SETUP

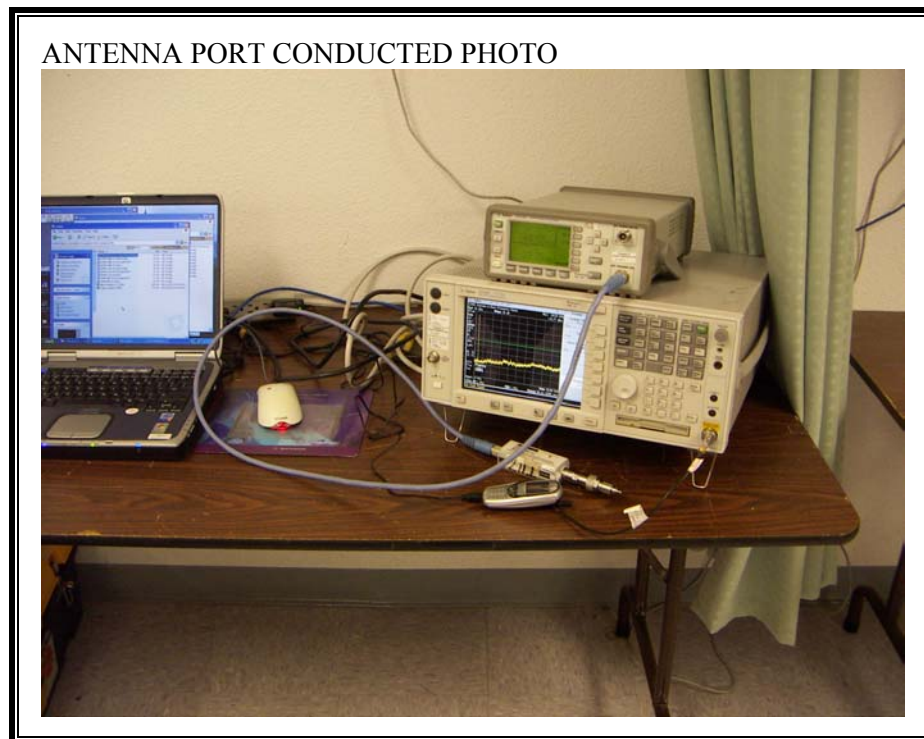

RADIATED RF MEASUREMENT SETUP FOR PORTABLE CONFIGURATION

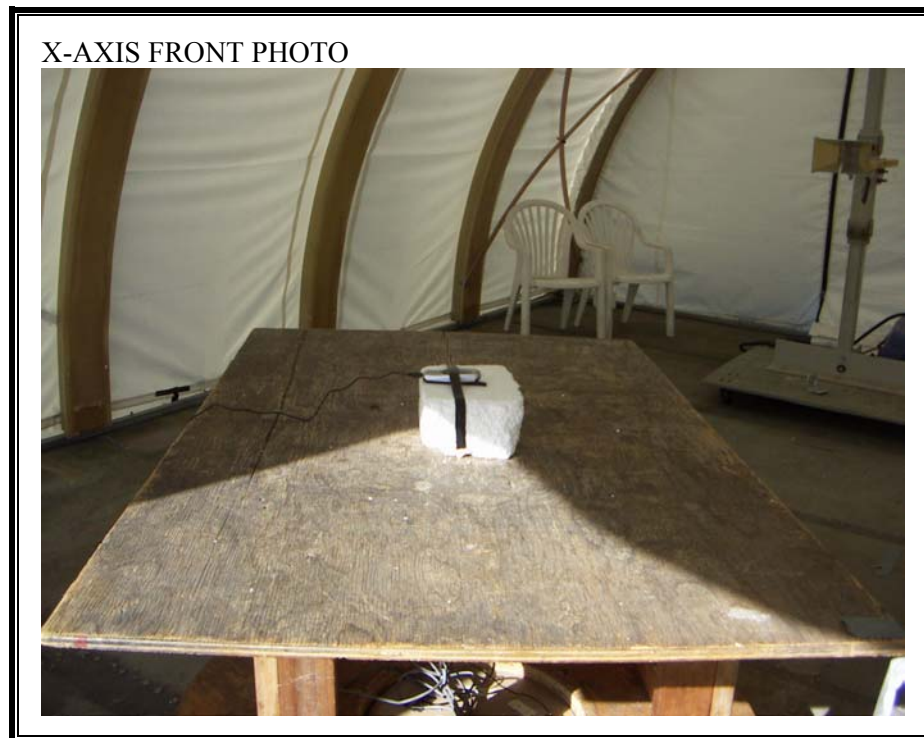

X-AXIS BACK PHOTO



Y-AXIS FRONT PHOTO



Y-AXIS BACK PHOTO



Z-AXIS FRONT PHOTO



Z-AXIS BACK PHOTO



DIGITAL DEVICE RADIATED EMISSIONS SETUP

LINK TO LAPTOP

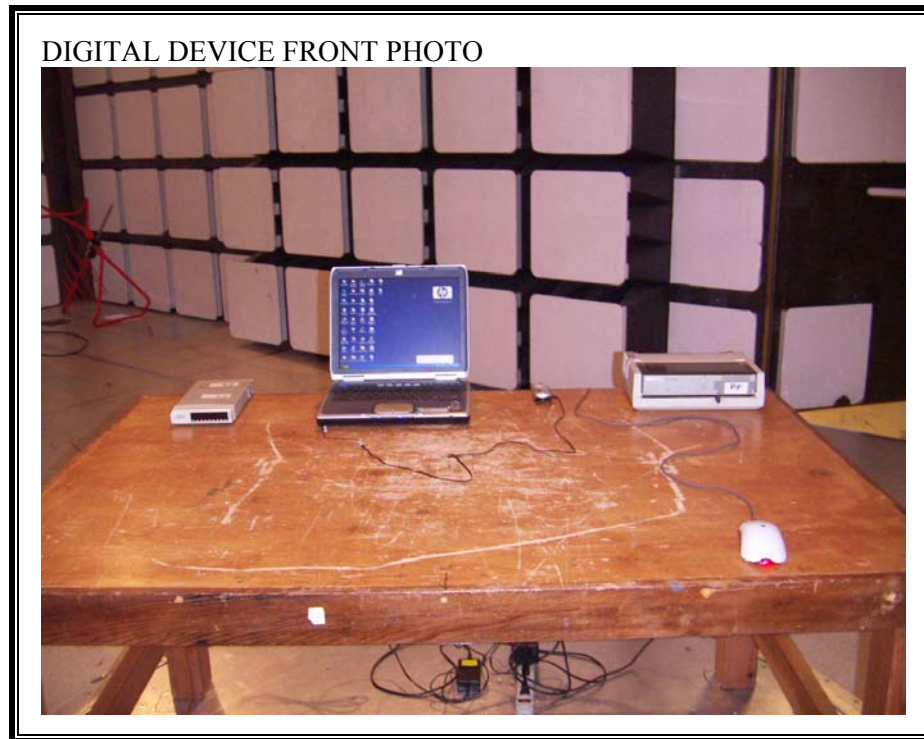

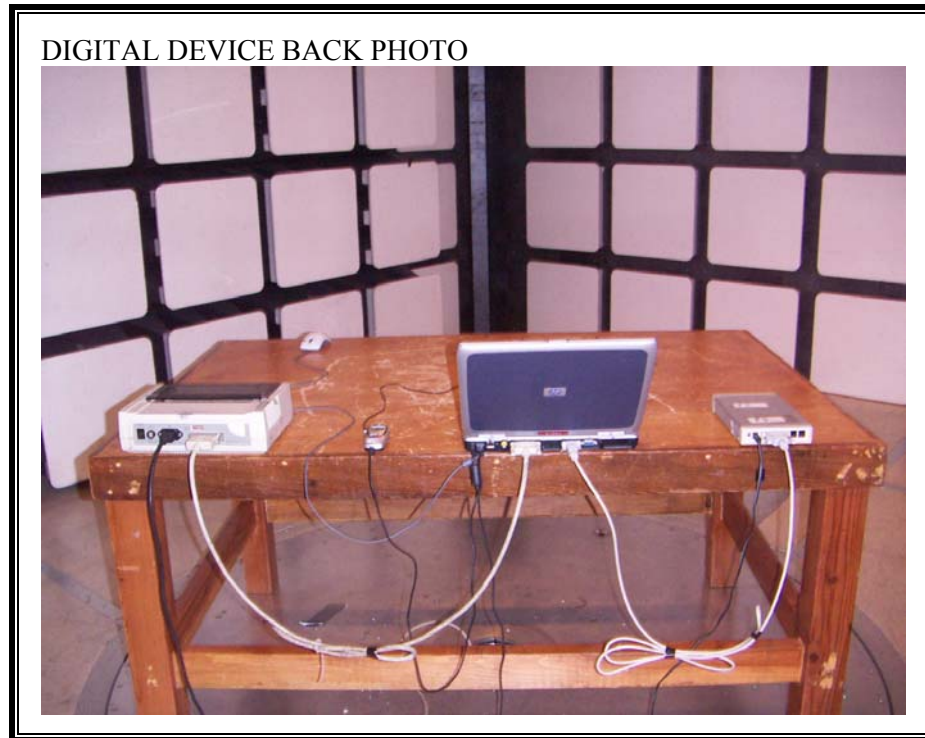

POWERLINE CONDUCTED EMISSIONS MEASUREMENT SETUP

LINK TO LAPTOP



LINE CONDUCTED BACK PHOTO



STAND-ALONE



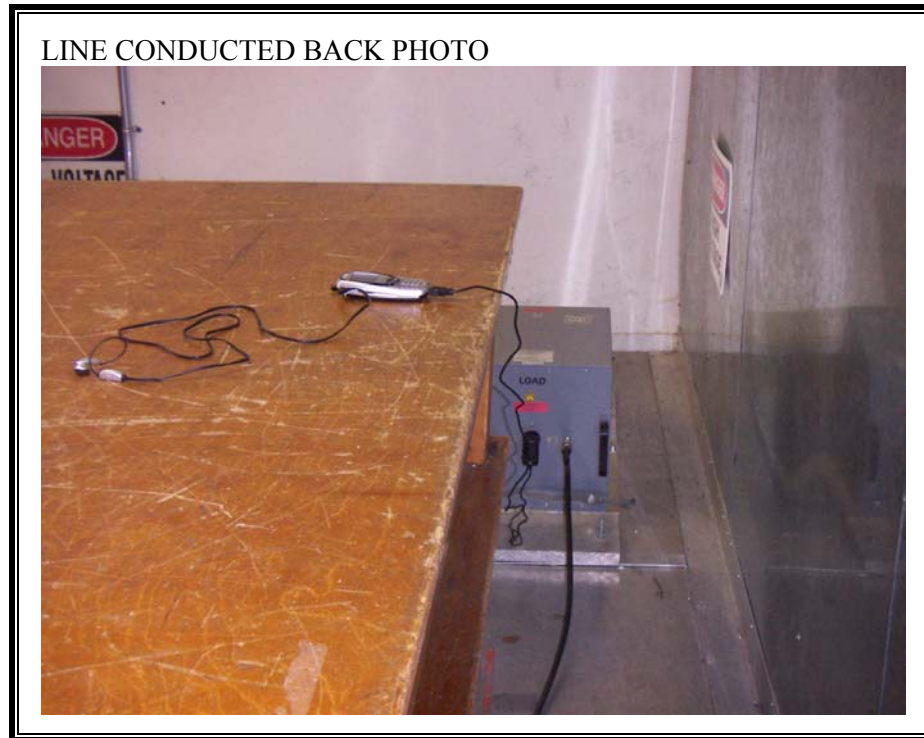

END OF REPORT