



**FCC CFR47 PART 22 SUBPART H  
CERTIFICATION  
TEST REPORT**

**FOR**

**SINGLE BAND SINGLE MODE CDMA CELLULAR PHONE**

**MODEL NUMBER: VS-5L**

**FCC ID: GKRVS-5L**

**REPORT NUMBER: 04I3099-1**

**ISSUE DATE: DECEMBER 24, 2004**

*Prepared for*

**COMPAL ELECTRONICS, INC.  
7F, NO. 500, JUIKUANG ROAD  
NEIHU, TAIPEI TAIWAN ROC 114**

*Prepared by*

**COMPLIANCE ENGINEERING SERVICES, INC.**

**d.b.a.**

**COMPLIANCE CERTIFICATION SERVICES**

**561F MONTEREY ROAD,  
MORGAN HILL, CA 95037, USA**

**TEL: (408) 463-0885**

**FAX: (408) 463-0888**



**LAB CODE:200065-0**

Revision History

<u>Rev.</u>	<u>Revisions</u>	<u>Revised By</u>
-------------	------------------	-------------------

## TABLE OF CONTENTS

<b>1. ATTESTATION OF TEST RESULTS.....</b>	<b>4</b>
<b>2. TEST METHODOLOGY .....</b>	<b>5</b>
<b>3. FACILITIES AND ACCREDITATION .....</b>	<b>5</b>
<b>4. CALIBRATION AND UNCERTAINTY.....</b>	<b>5</b>
4.1. <i>MEASURING INSTRUMENT CALIBRATION.....</i>	<i>5</i>
4.2. <i>MEASUREMENT UNCERTAINTY.....</i>	<i>5</i>
<b>5. EQUIPMENT UNDER TEST.....</b>	<b>6</b>
5.1. <i>DESCRIPTION OF EUT.....</i>	<i>6</i>
5.2. <i>MAXIMUM OUTPUT POWER.....</i>	<i>6</i>
5.3. <i>DESCRIPTION OF AVAILABLE ANTENNAS.....</i>	<i>6</i>
5.4. <i>WORST-CASE CONFIGURATION AND MODE.....</i>	<i>6</i>
5.5. <i>DESCRIPTION OF TEST SETUP.....</i>	<i>7</i>
<b>6. TEST AND MEASUREMENT EQUIPMENT .....</b>	<b>9</b>
<b>7. LIMITS AND RESULTS .....</b>	<b>10</b>
7.1. <i>OCCUPIED BANDWIDTH.....</i>	<i>10</i>
7.2. <i>RF POWER OUTPUT.....</i>	<i>17</i>
7.3. <i>FREQUENCY STABILITY.....</i>	<i>19</i>
7.4. <i>SPURIOUS EMISSION AT ANTENNA TERMINAL.....</i>	<i>20</i>
<b>8. DIGITAL DEVICE CONFIGURATION - LIMITS AND RESULTS .....</b>	<b>27</b>
8.1. <i>RADIATED EMISSIONS.....</i>	<i>27</i>
8.2. <i>POWERLINE CONDUCTED EMISSIONS.....</i>	<i>30</i>
<b>9. SETUP PHOTOS.....</b>	<b>34</b>

# 1. ATTESTATION OF TEST RESULTS

**COMPANY NAME:** COMPAL ELECTRONICS INC.  
8F, NO. 500, JUI-KUANG RD.  
NEIHU, TAIPEI 114  
TAIWAN

**EUT DESCRIPTION:** SINGLE BAND SINGLE MODE CDMA CELLULAR PHONE

**MODEL:** VS-5L

**SERIAL NUMBER:** 6725524B

**DATE TESTED:** DECEMBER 15 – 17, 2004

APPLICABLE STANDARDS	
STANDARD	TEST RESULTS
FCC PART 22 SUBPART H	NO NON-COMPLIANCE NOTED
DIGITAL DEVICE CONFIGURATION: FCC PART 15 SUBPART B	NO NON-COMPLIANCE NOTED

Compliance Certification Services, Inc. tested the above equipment in accordance with the requirements set forth in the above standards. The test results show that the equipment tested is capable of demonstrating compliance with the requirements as documented in this report.

**Note:** The results documented in this report apply only to the tested sample, under the conditions and modes of operation as described herein. This document may not be altered or revised in any way unless done so by Compliance Certification Services and all revisions are duly noted in the revisions section. Any alteration of this document not carried out by Compliance Certification Services will constitute fraud and shall nullify the document. No part of this report may be used to claim product certification, approval, or endorsement by NVLAP, NIST, or any government agency.

Approved & Released For CCS By:

Tested By:



THU CHAN  
EMC SUPERVISOR  
COMPLIANCE CERTIFICATION SERVICES

CHIN PANG  
EMC TECHNICIAN  
COMPLIANCE CERTIFICATION SERVICES

## 2. TEST METHODOLOGY

The tests documented in this report were performed in accordance with TIA/EIA 603A (2001), ANSI C63.4-2003, FCC CFR 47 Part 2, FCC CFR 47 Part 15 and FCC CFR 47 Part 22.

## 3. FACILITIES AND ACCREDITATION

The test sites and measurement facilities used to collect data are located at 561F Monterey Road, Morgan Hill, California, USA. The sites are constructed in conformance with the requirements of ANSI C63.4, ANSI C63.7 and CISPR Publication 22. All receiving equipment conforms to CISPR Publication 16-1, "Radio Interference Measuring Apparatus and Measurement Methods."

CCS is accredited by NVLAP, Laboratory Code 200065-0. The full scope of accreditation can be viewed at <http://www.ccsemc.com>.

## 4. CALIBRATION AND UNCERTAINTY

### 4.1. MEASURING INSTRUMENT CALIBRATION

The measuring equipment utilized to perform the tests documented in this report has been calibrated in accordance with the manufacturer's recommendations, and is traceable to recognized national standards.

### 4.2. MEASUREMENT UNCERTAINTY

Where relevant, the following measurement uncertainty levels have been estimated for tests performed on the apparatus:

PARAMETER	UNCERTAINTY
Radiated Emission, 30 to 200 MHz	+/- 3.3 dB
Radiated Emission, 200 to 1000 MHz	+4.5 / -2.9 dB
Radiated Emission, 1000 to 2000 MHz	+4.5 / -2.9 dB
Power Line Conducted Emission	+/- 2.9 dB

Uncertainty figures are valid to a confidence level of 95%.

## 5. EQUIPMENT UNDER TEST

### 5.1. DESCRIPTION OF EUT

The EUT is a Single mode (CDMA only) portable mobile station of which frequency range is 824 - 894MHz

It uses 3G CDMA 1x-RTT solution and the MSM6000 Mobile Station Modem Chipset.

### 5.2. MAXIMUM OUTPUT POWER

The transmitter has a maximum peak conducted output power and ERP as follows:

800 to 880 MHz Authorized Band

Frequency Range (MHz)	Modulation	Output Power (dBm)	Output Power (mW)	Output ERP (dBm)	Output ERP (mW)
824.76 - 848.25	CDMA	30.26	1061.70	31.10	1288.25

### 5.3. DESCRIPTION OF AVAILABLE ANTENNAS

The radio utilizes a Helix -Fixed antenna.

### 5.4. WORST-CASE CONFIGURATION AND MODE

The worst-case channel is determined as the channel with the highest output power. The highest measured output power was at 824.76 MHz.

## **5.5. DESCRIPTION OF TEST SETUP**

### **SET UP FOR RF TEST**

#### **SUPPORT EQUIPMENT**

The EUT is installed as a stand-alone device during the tests

#### **I/O CABLES**

The EUT is installed as a stand-alone device during the tests

#### **TEST SETUP**

The EUT is installed as a stand-alone device during the tests

**SET UP FOR DIGITAL TEST**

**SUPPORT EQUIPMENT**

TEST PERIPHERALS				
Device Type	Manufacturer	Model Number	Serial Number	FCC ID
AC Adapter Earphone	Compal Electronic NA	KWT05A7JL0017 NA	NA NA	DoC NA

**I/O CABLES**

TEST I / O CABLES								
Cable No	I/O Port	# of I/O Port	Connector Type	Type of Cable	Cable Length	Data Traffic	Bundled	Remark
1	AC	1	US 115V	Un-shielded	2m	No	No	N/A
2	DC	1	DC	Un-shielded	1m	No	No	N/A

**TEST SETUP**

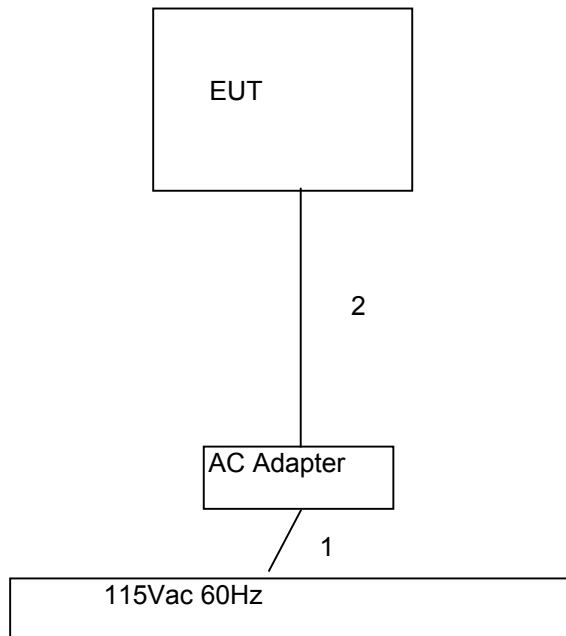



## 6. TEST AND MEASUREMENT EQUIPMENT

The following test and measurement equipment was utilized for the tests documented in this report:

TEST EQUIPMENT LIST				
Description	Manufacturer	Model	Serial Number	Cal Due
Peak / Average Power Sensor	Agilent	E9327A	US40440755	11/7/2005
Peak Power Meter	Agilent	E4416A	GB41291160	11/7/05
EMI Receiver, 9 kHz ~ 2.9 GHz	HP	8542E	3942A00286	11/20/05
RF Filter Section	HP	85420E	3705A00256	11/20/05
Spectrum Analyzer 20 Hz ~ 44 GHz	Agilent	E4446A	US42070220	1/13/05
Signal Generator, 2 ~ 40 GHz	R & S	SMP04	DE 34210	5/25/05
Antenna, Horn 1 ~ 18 GHz	EMCO	3115	2238	2/4/05
Antenna, Tuned Dipole	CDI	ROBERTS	117	5/15/05
Antenna, Horn 1 ~ 18 GHz	EMCO	3115	6717	2/4/05

## 7. LIMITS AND RESULTS

### 7.1. OCCUPIED BANDWIDTH

#### LIMIT

None; for reporting purposes only.

#### TEST PROCEDURE

The transmitter output is connected to the spectrum analyzer. The RBW is set to 1% to 3% of the -26 dB (99% for IC) bandwidth. The VBW is set to 3 times the RBW. The sweep time is coupled. The spectrum analyzer internal -26 dB (99% for IC) bandwidth function is utilized.

#### RESULTS

No non-compliance noted:

#### CDMA Modulation

Channel	Frequency (MHz)	99% BW (MHz)	26dBc BW (MHz)
Low	824.76	1.2625	1.3948
Middle	835.89	1.2625	1.3948
High	848.25	1.2685	1.3948

**CDMA 99% BANDWIDTH**

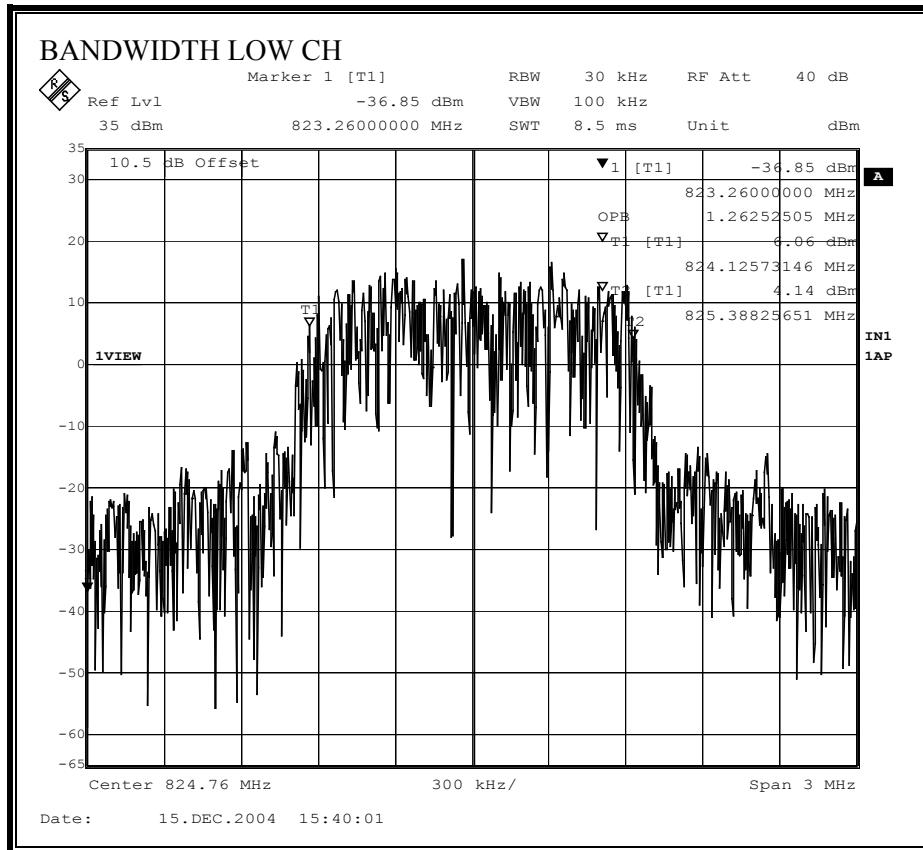

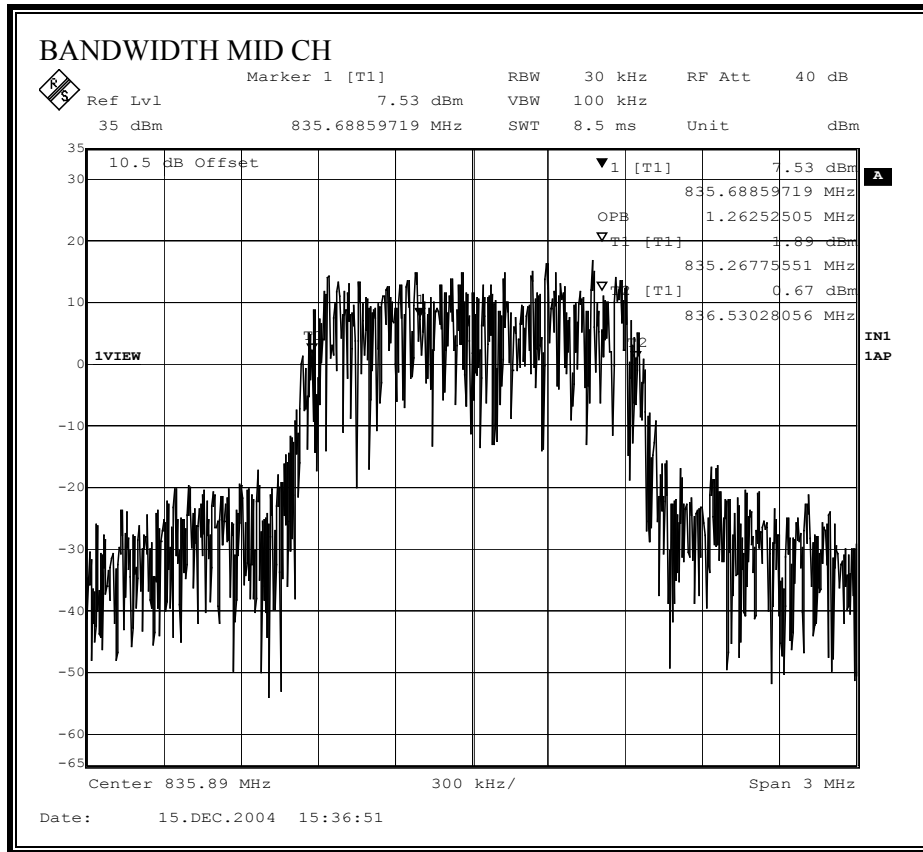

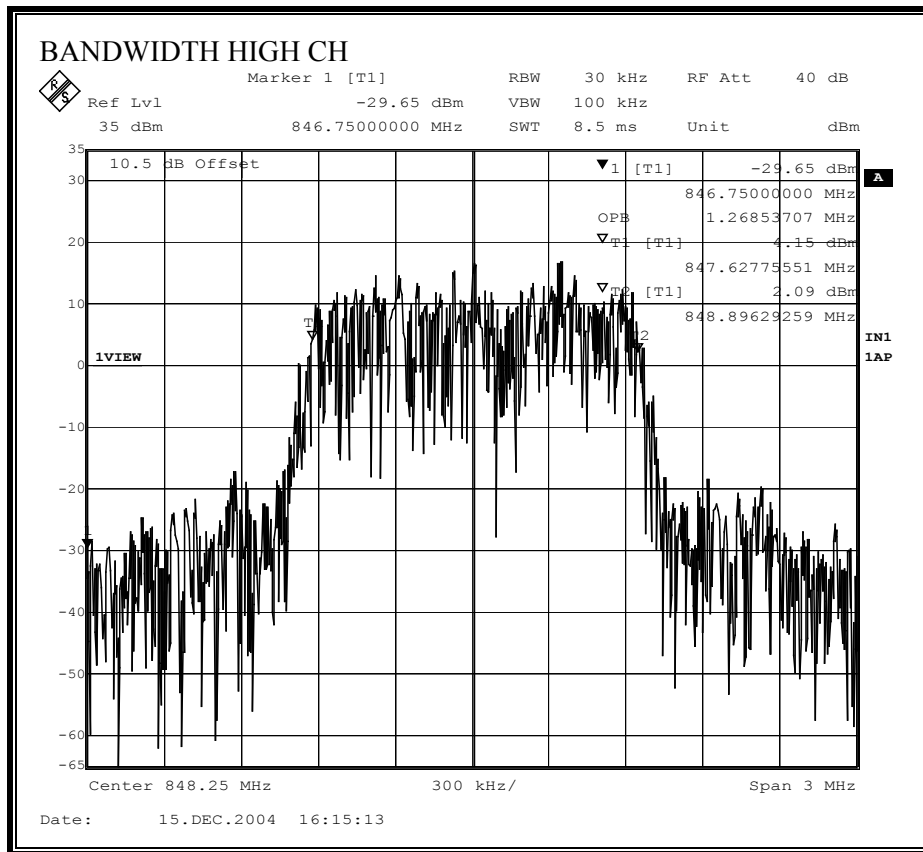

**CDMA 26 dB BANDWIDTH**

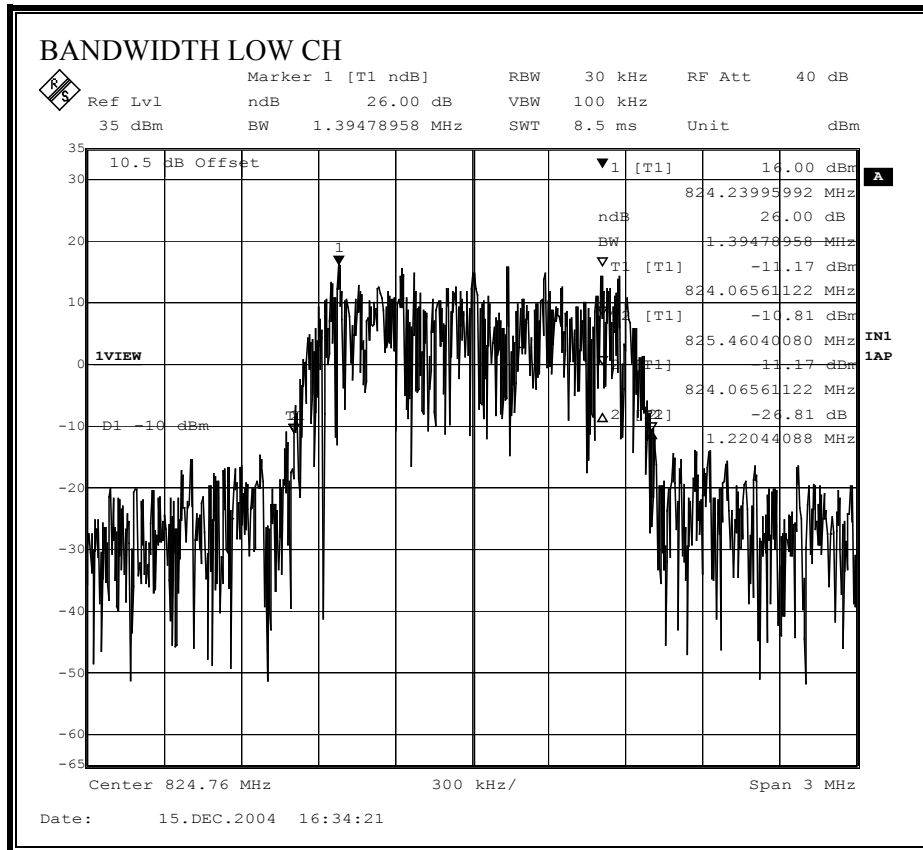

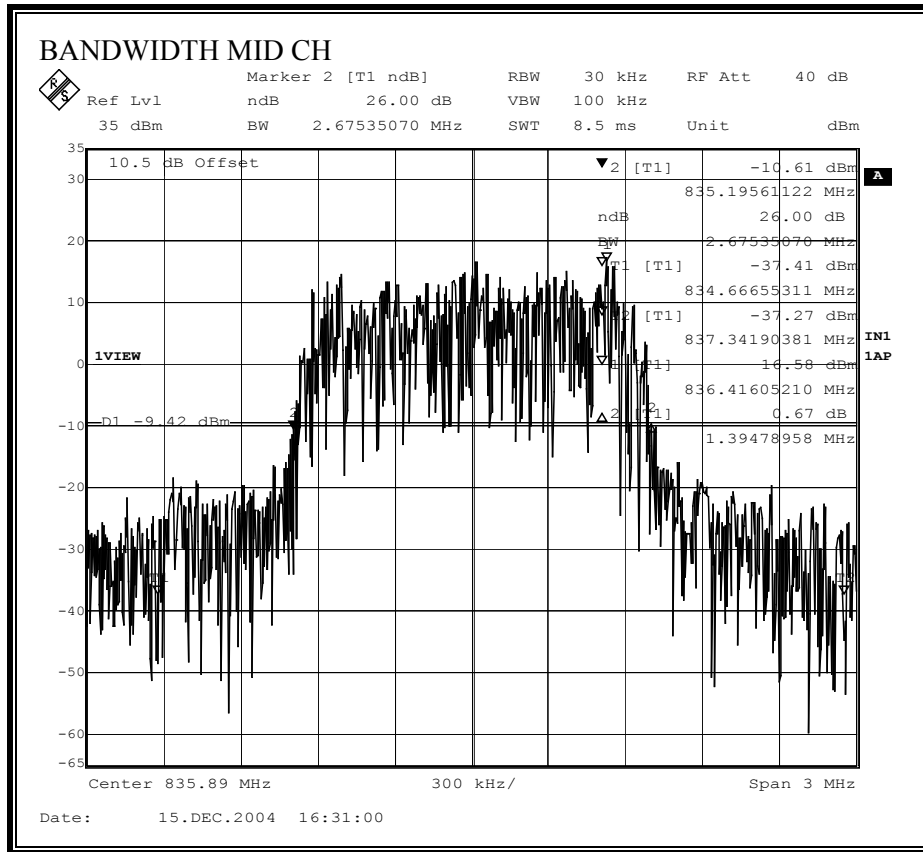

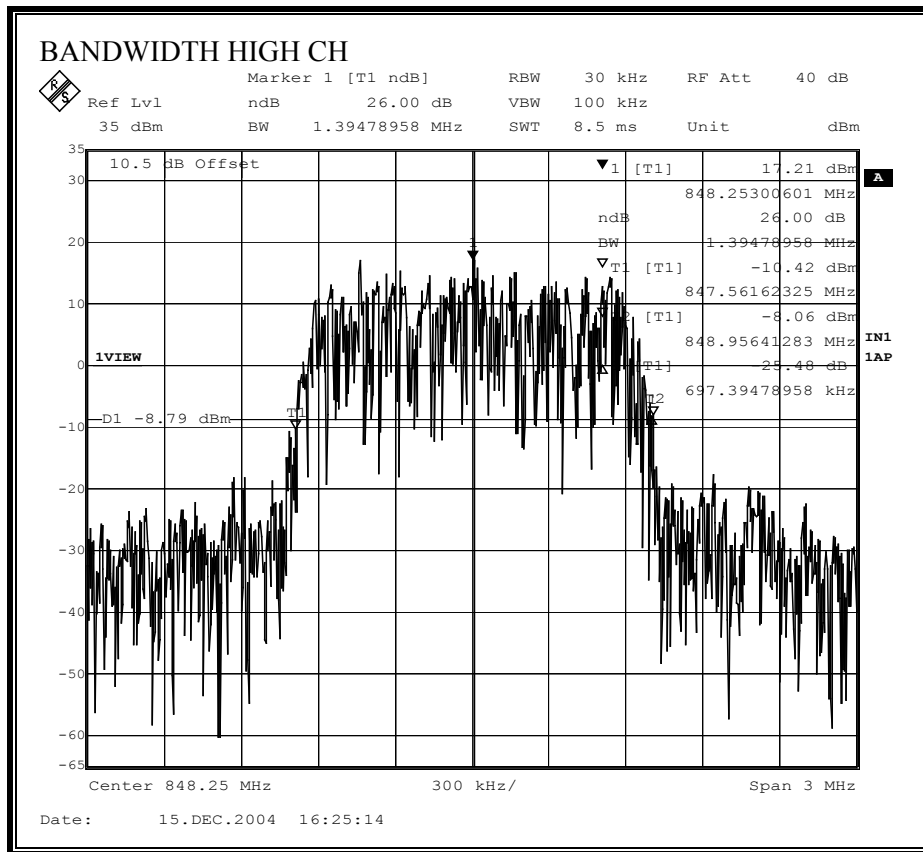



## **7.2. RF POWER OUTPUT**

### **LIMIT**

22.913(a) The ERP of mobile transmitters and auxiliary test transmitters must not exceed 7 Watts.

### **TEST PROCEDURE**

ANSI / TIA / EIA 603 Clause 2.2.17

### **RESULTS**

No non-compliance noted.

**CDMA Output Power (ERP)**

f MHz	SA reading (dBuV/m)	Ant. Pol. (H/V)	SG reading (dBm)	CL (dB)	Gain (dBi)	Gain (dBd)	ERP (dBm)	Limit (dBm)	Margin (dB)	Notes
<b>Y Worst Position</b>										
<b>Low Channel</b>										
824.76	100.3	V	30.0	3.4	6.7	4.6	31.1	38.0	-6.9	
824.76	93.1	H	22.3	3.4	6.7	4.6	23.4	38.0	-14.6	
<b>Mid Channel</b>										
835.89	100.0	V	29.8	3.5	6.7	4.6	30.9	38.0	-7.1	
835.89	89.5	H	18.8	3.5	6.7	4.6	19.9	38.0	-18.1	
<b>High Channel</b>										
848.25	99.2	V	29.2	3.5	6.7	4.6	30.2	38.0	-7.8	
848.25	89.3	H	18.8	3.5	6.7	4.6	19.9	38.0	-18.1	

**VBW=VBW=3 MHz**

### 7.3. FREQUENCY STABILITY

#### LIMIT

§22.355 Except as otherwise provided in this part, the carrier frequency of each transmitter in the Public Mobile Services must be maintained within the tolerances given in Table C-1 of this section.

For Mobile devices operating in the 824 to 849 MHz band at a power level less than or equal to 3 Watts, the limit specified in Table C-1 is +/- 2.5 ppm.

#### TEST PROCEDURE

ANSI / TIA / EIA 603 Clause 2.3.1 and 2.3.2

#### RESULTS

No non-compliance noted.

Reference Frequency: CDMA Mid Channel 835.208264 MHz @ 25°C				
Limit: ± 2.5 ppm = 2088.021 Hz				
Power Supply (Vdc)	Environment Temperature (°C)	Frequency Deviation Measured with Time Elapse		
		(MHz)	Delta (ppm)	Limit (ppm)
3.70	50	835.20825	0.016	± 2.5
3.70	40	835.20824	0.035	± 2.5
3.70	30	835.20820	0.078	± 2.5
<b>3.70</b>	<b>25</b>	<b>835.20826</b>	<b>0</b>	<b>± 2.5</b>
3.70	20	835.20802	0.290	± 2.5
3.70	10	835.20768	0.705	± 2.5
3.70	0	835.20747	0.953	± 2.5
3.70	-10	835.20746	0.969	± 2.5
3.70	-20	835.20737	1.074	± 2.5
3.70	-30	835.20726	1.207	± 2.5
3.32 endpoint	25	835.20826	0.011	± 2.5
4.255	25	835.20824	0.035	± 2.5

## 7.4. SPURIOUS EMISSION AT ANTENNA TERMINAL

### LIMIT

§22.917 (a) Out of band emissions. The power of any emission outside of the authorized operating frequency ranges must be attenuated below the transmitting power (P) by a factor of at least  $43 + 10 \log (P)$  dB.

### TEST PROCEDURE

ANSI / TIA / EIA 603 Clause 3.2.13 & FCC 22.917 (b)

### RESULTS

No non-compliance noted.

**CDMA MODULATION RESULTS**

**CDMA Modulation: Low Channel Out-Of-Band Emissions**

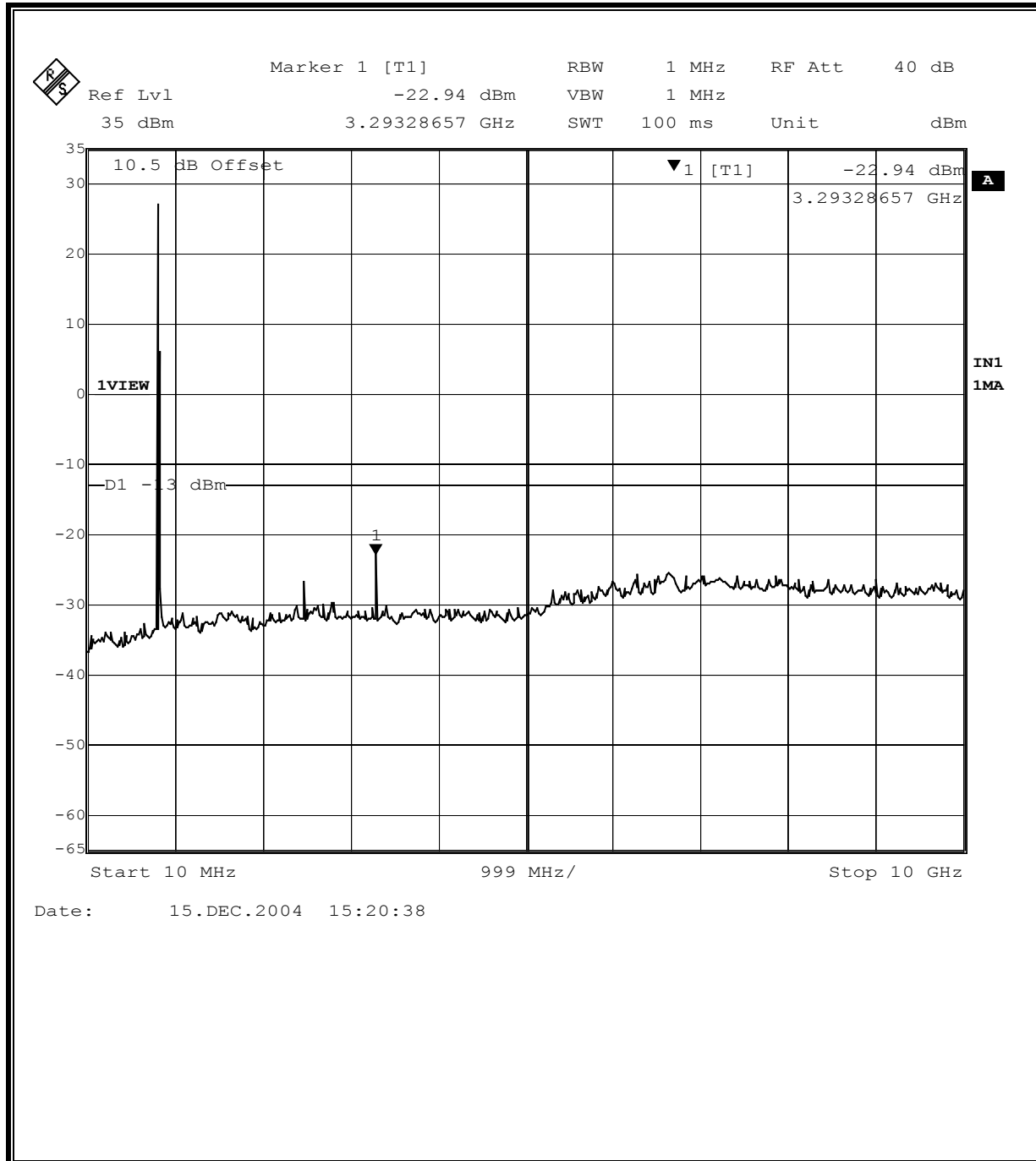

**CDMA Modulation: Mid Channel Out-Of-Band Emissions**

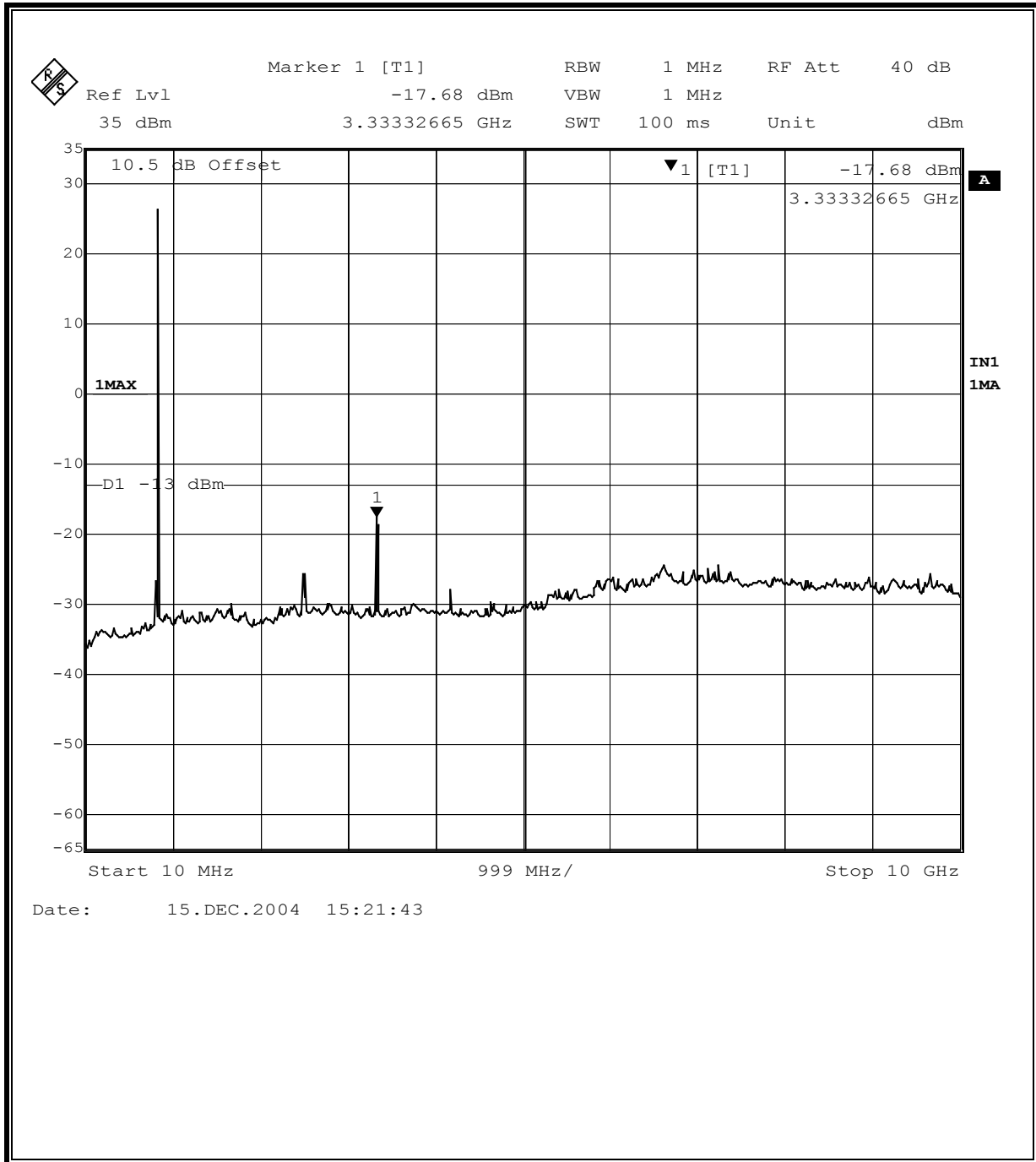

**CDMA Modulation: High Channel Out-Of-Band Emissions**

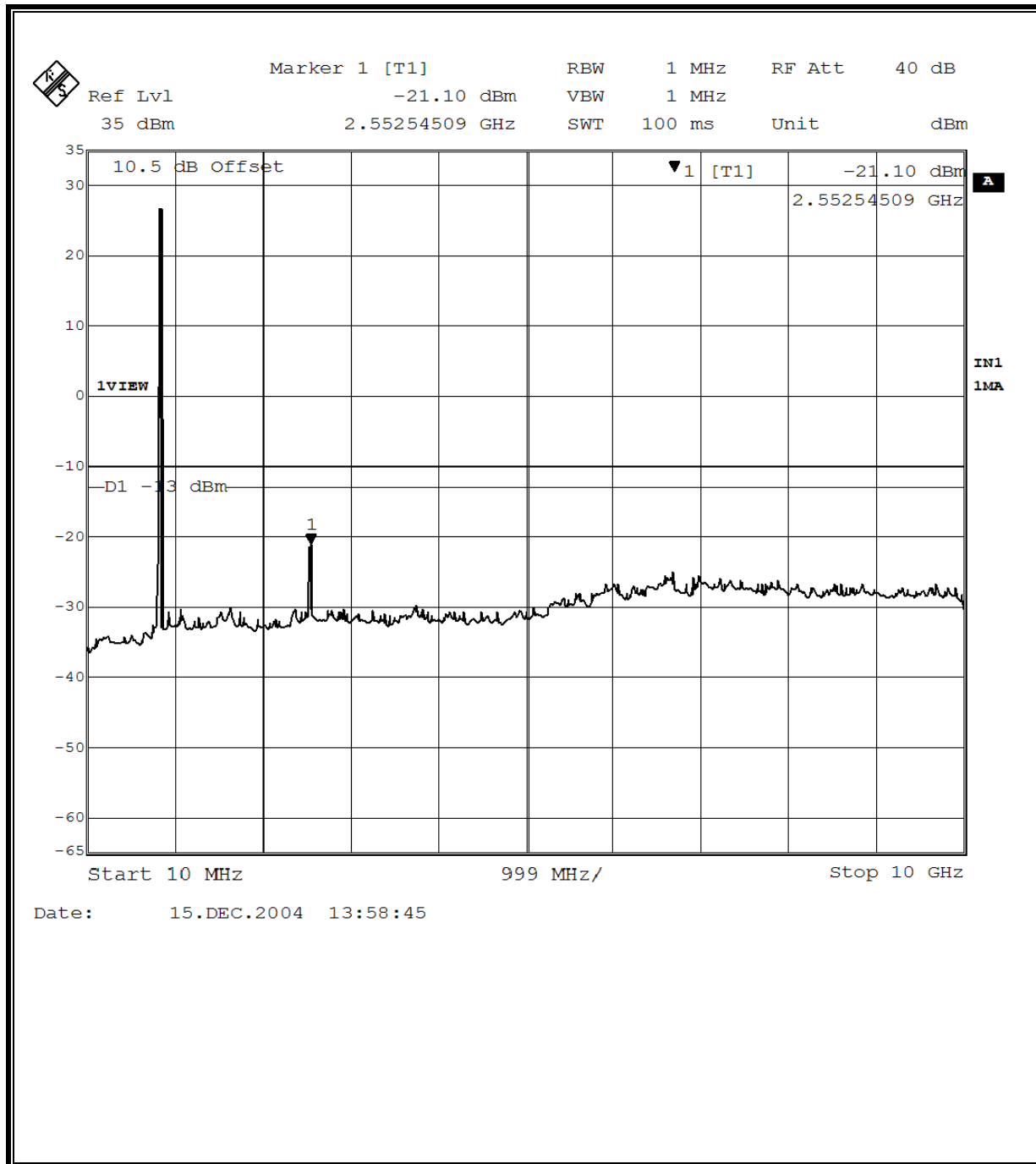

**CDMA Modulation: Low Channel Band Edge**

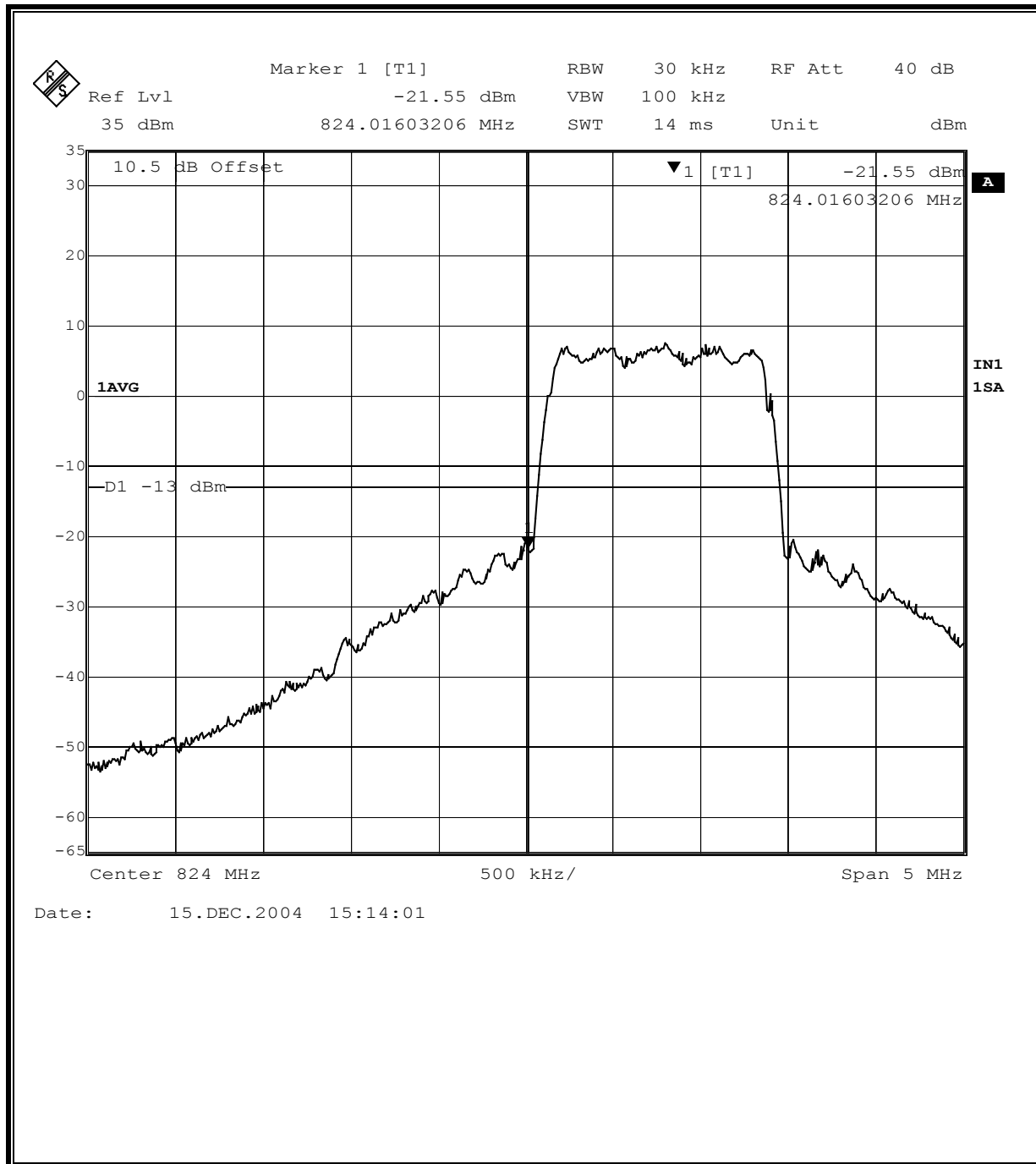



**CDMA Modulation: High Channel Band Edge**

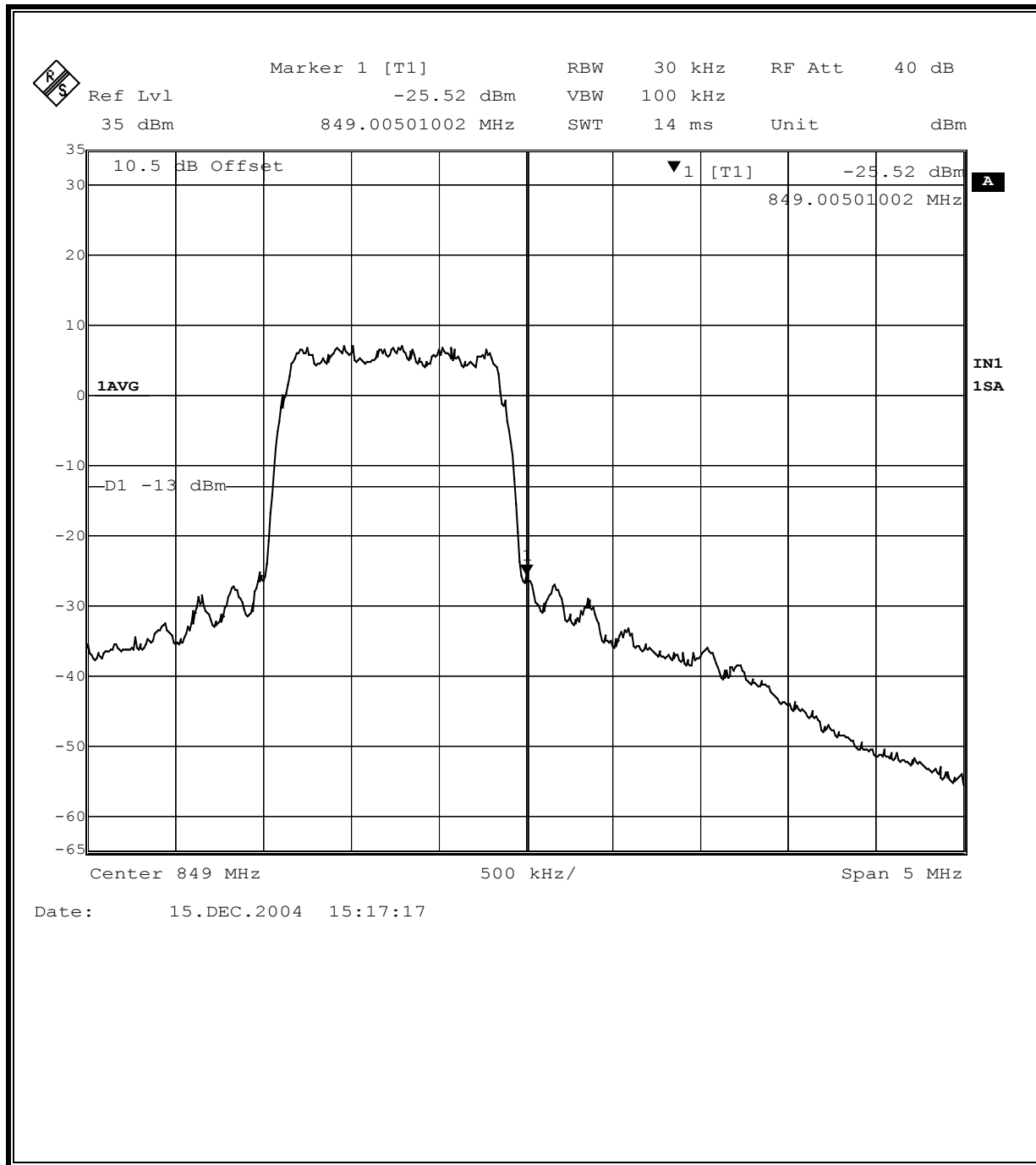

**CDMA Mobile Emissions in Base Frequency Range**

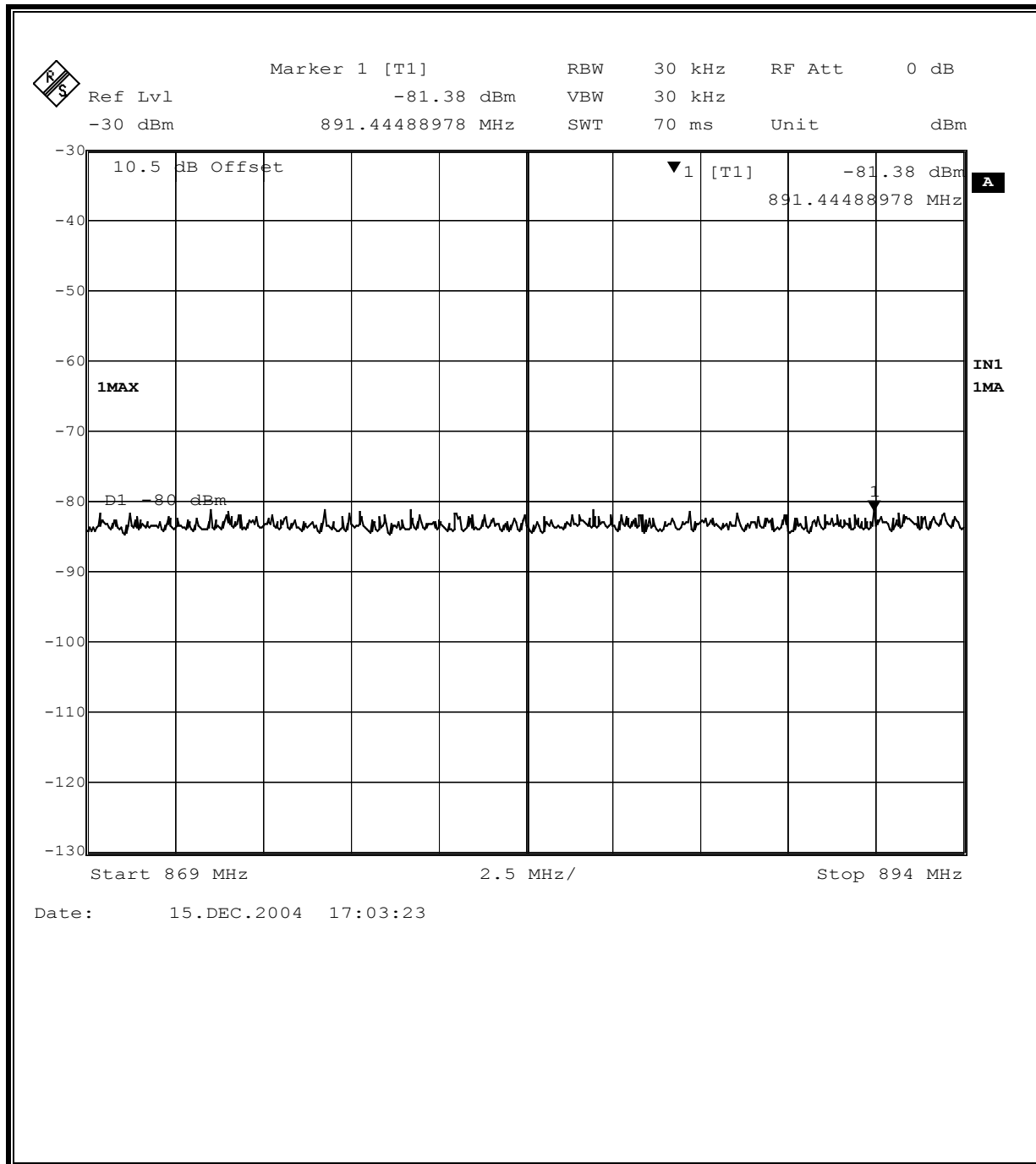

## 8. DIGITAL DEVICE CONFIGURATION - LIMITS AND RESULTS

### 8.1. RADIATED EMISSIONS

#### TEST PROCEDURE

ANSI C63.4

The frequency range was investigated from 30 MHz to 1000 MHz.

#### CLASS B LIMITS

§15.107 (a) Except for Class A digital devices, the field strength of radiated emissions from unintentional radiators at a distance of 3 meters shall not exceed the following values:

Limits for radiated disturbance of Class B ITE at measuring distance of 3 m	
Frequency range (MHz)	Quasi-peak limits (dB $\mu$ V/m)
30 to 88	40
88 to 216	43.5
216 to 960	46
Above 960 MHz	54

Note: The lower limit shall apply at the transition frequency.

#### RESULTS

No non-compliance noted:



561F Monterey Road  
 Morgan Hill, CA 95037  
 Tel: (408) 463-0888  
 Fax: (408) 463-0885

Data#: 2 File#: 3099 compal.EMI Date: 12-15-2004 Time: 16:24:04

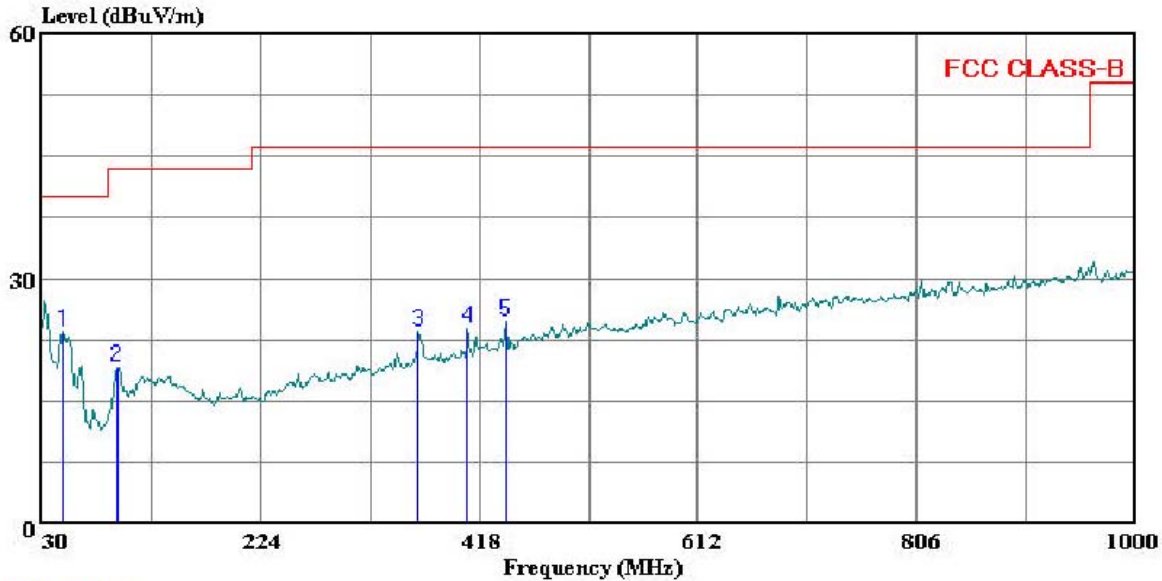

(Auxix ATC)

Trace: 1

Ref Trace:

Condition: FCC CLASS-B VERTICAL  
 Test Operator: : Chin Pang  
 Project #: : 04I3099-2  
 Company: : Vacom Wireless Inc.  
 EUT: : 800MHz CDMA Phone  
 Model No: : VS-5L  
 Configuration: : EUT / Earphone  
 Target of Test: : FCC Class B  
 Mode of Operation: Normal

Page: 1

	Freq	Read Level	Factor	Level	Limit Line	Over Limit	Remark
	MHz	dBuV	dB	dBuV/m	dBuV/m	dB	
1	48.430	40.78	-17.38	23.40	40.00	-16.60	Peak
2	96.930	37.29	-18.09	19.20	43.50	-24.30	Peak
3	363.680	33.69	-10.28	23.41	46.00	-22.59	Peak
4	407.330	33.02	-9.10	23.92	46.00	-22.08	Peak
5	441.280	32.85	-8.16	24.69	46.00	-21.31	Peak



561F Monterey Road  
 Morgan Hill, CA 95037  
 Tel: (408) 463-0888  
 Fax: (408) 463-0885

Data#: 4 File#: 3099 compal.EMI Date: 12-15-2004 Time: 16:28:50

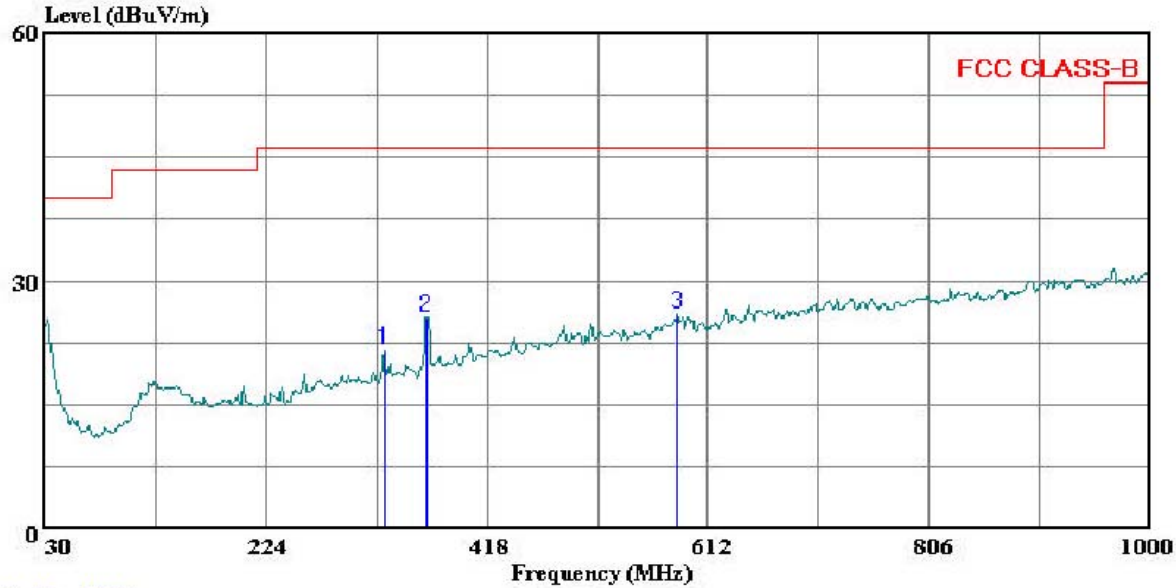

(Auxiliary)

Trace: 3

Ref Trace:

Condition: FCC CLASS-B HORIZONTAL  
 Test Operator: : Chin Pang  
 Project #: : 04I3099-2  
 Company: : Vacom Wireless Inc.  
 EUT: : 800MHz CDMA Phone  
 Model No: : VS-5L  
 Configuration: : EUT / Earphone  
 Target of Test: : FCC Class B  
 Mode of Operation: Normal

Page: 1

	Read	Limit	Over				
Freq	Level	Factor	Level	Line	Limit	Remark	
MHz	dBuV	dB	dBuV/m	dBuV/m	dB		
1	327.790	32.78	-11.21	21.57	46.00	-24.43	Peak
2	364.650	35.87	-10.23	25.64	46.00	-20.36	Peak
3	584.840	30.97	-5.06	25.91	46.00	-20.09	Peak

## 8.2. POWERLINE CONDUCTED EMISSIONS

### LIMIT

§15.107 (a) (a) Except for Class A digital devices, for equipment that is designed to be connected to the public utility (AC) power line, the radio frequency voltage that is conducted back onto the AC power line on any frequency or frequencies within the band 150 kHz to 30 MHz shall not exceed the limits in the following table, as measured using a 50  $\mu$  H/50 ohms line impedance stabilization network (LISN). Compliance with the provisions of this paragraph shall be based on the measurement of the radio frequency voltage between each power line and ground at the power terminal. The lower limit applies at the band edges.

Frequency of Emission (MHz)	Conducted Limit (dBuV)	
	Quasi-peak	Average
0.15-0.5	66 to 56*	56 to 46*
0.5-5	56	46
5-30	60	50

\* Decreases with the logarithm of the frequency.

### TEST PROCEDURE

ANSI C63.4

### RESULTS

No non-compliance noted:

**6 WORST EMISSIONS**

CONDUCTED EMISSIONS DATA (115VAC 60Hz)									
Freq.	Reading			Closs	Limit	EN B	Margin		Remark
(MHz)	PK (dBuV)	QP (dBuV)	AV (dBuV)	(dB)	QP	AV	QP (dB)	AV (dB)	L1 / L2
0.26	49.99	--	37.81	0.00	61.59	51.59	-11.60	-13.78	L1
0.51	44.72	--	34.75	0.00	56.00	46.00	-11.28	-11.25	L1
0.77	35.64	--	27.95	0.00	56.00	46.00	-20.36	-18.05	L1
0.26	49.28	--	29.69	0.00	61.43	51.43	-12.15	-21.74	L2
0.52	43.80	--	36.62	0.00	56.00	46.00	-12.20	-9.38	L2
0.79	32.95	--	23.04	0.00	56.00	46.00	-23.05	-22.96	L2
6 Worst Data									

**LINE 1 RESULTS**

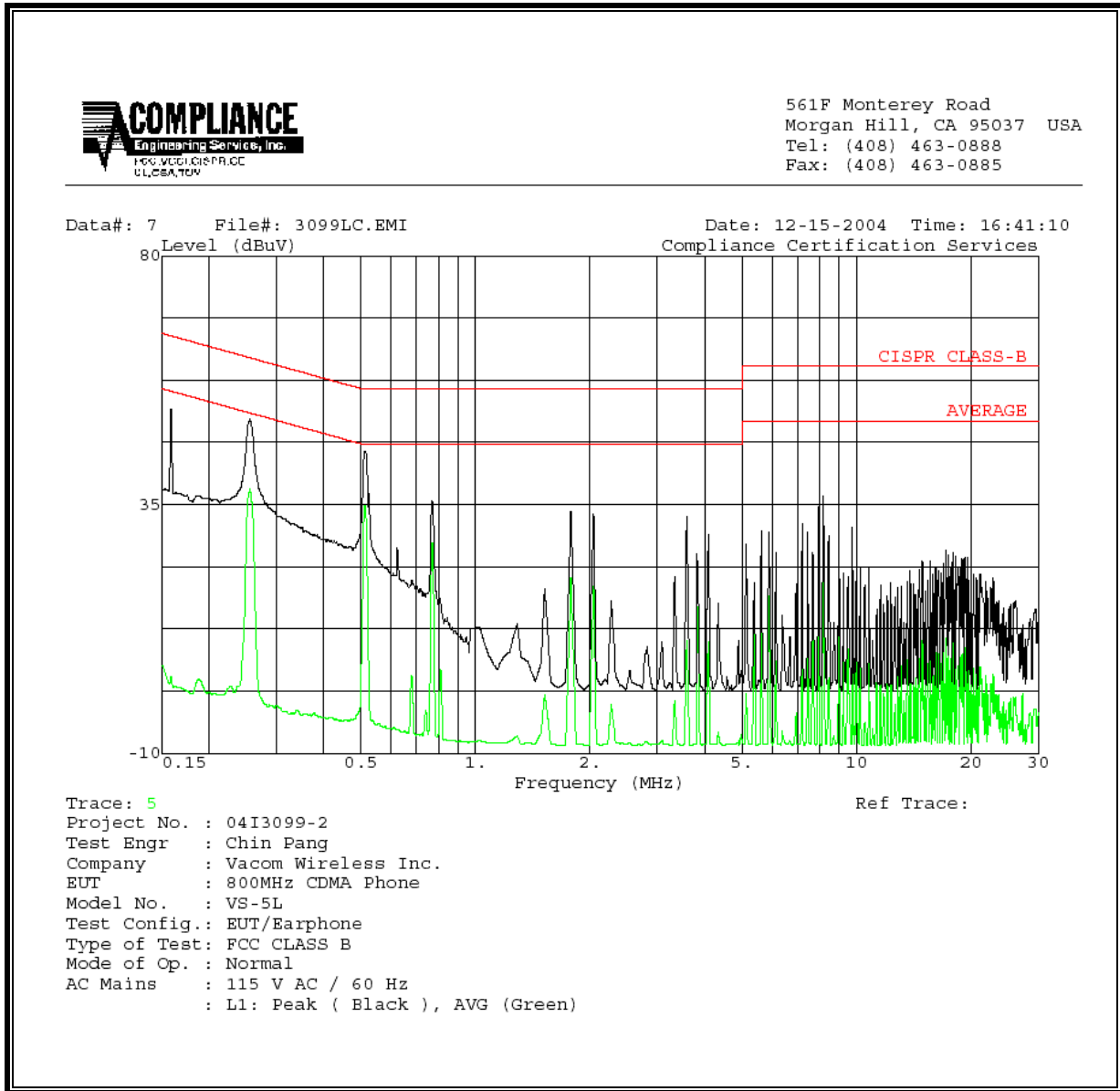



**LINE 2 RESULTS**

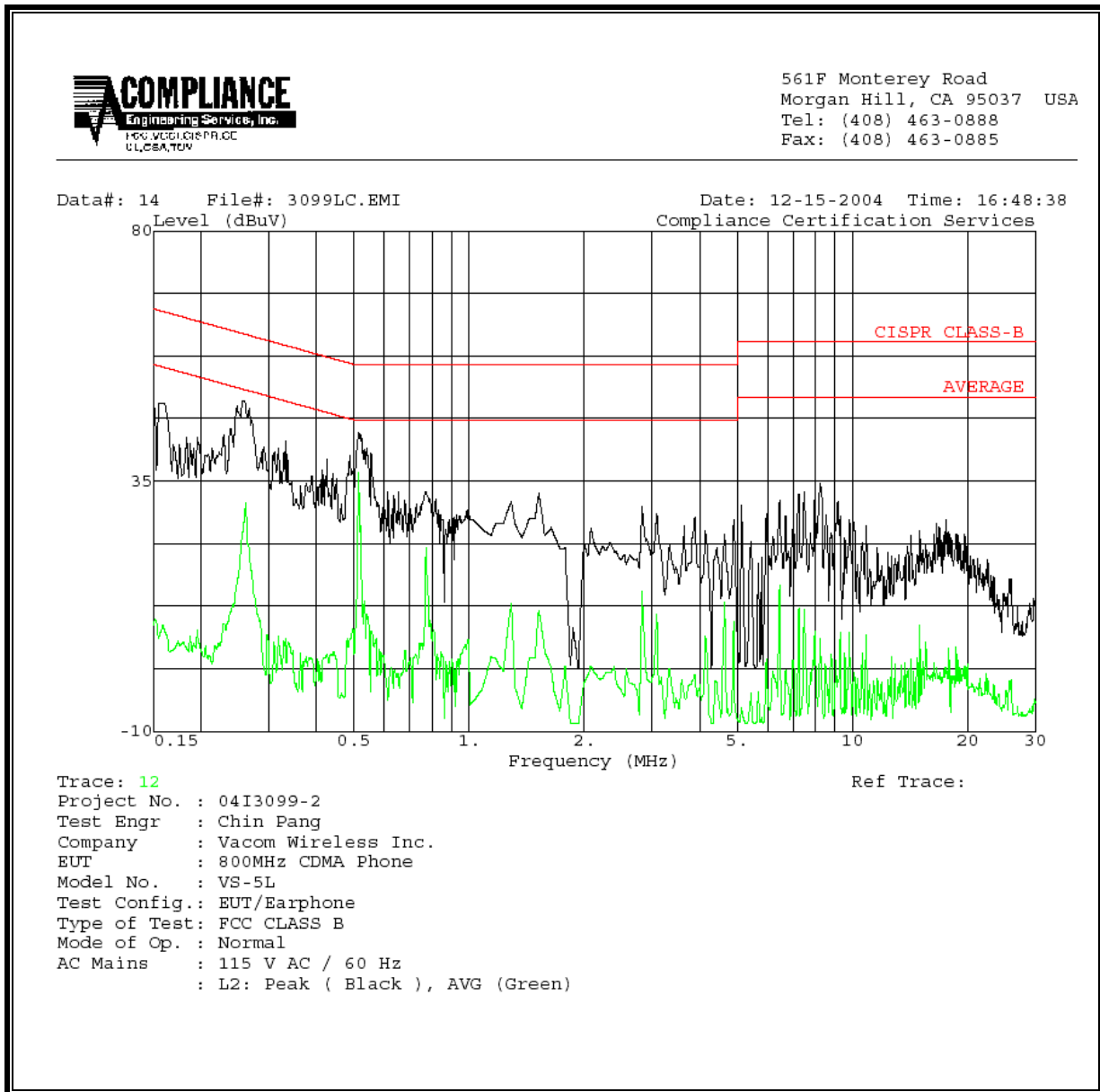

## 9. SETUP PHOTOS

### ANTENNA PORT CONDUCTED RF MEASUREMENT SETUP

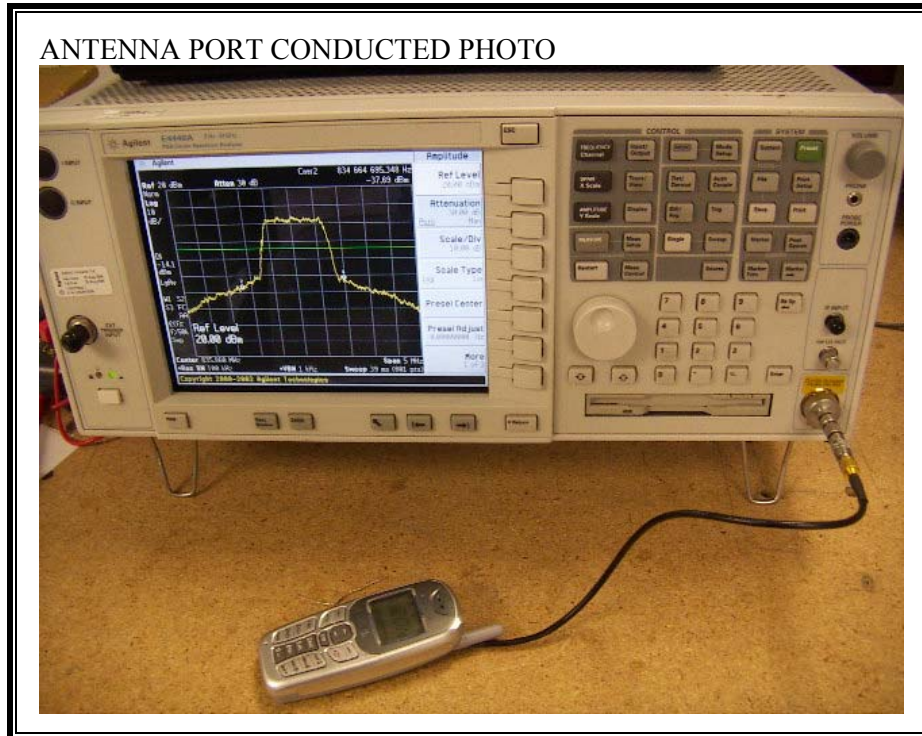

**RADIATED RF MEASUREMENT SETUP FOR FREQUENCY V.S. TEMPERATURE**



**RADIATED RF MEASUREMENT SETUP FOR PORTABLE CONFIGURATION**

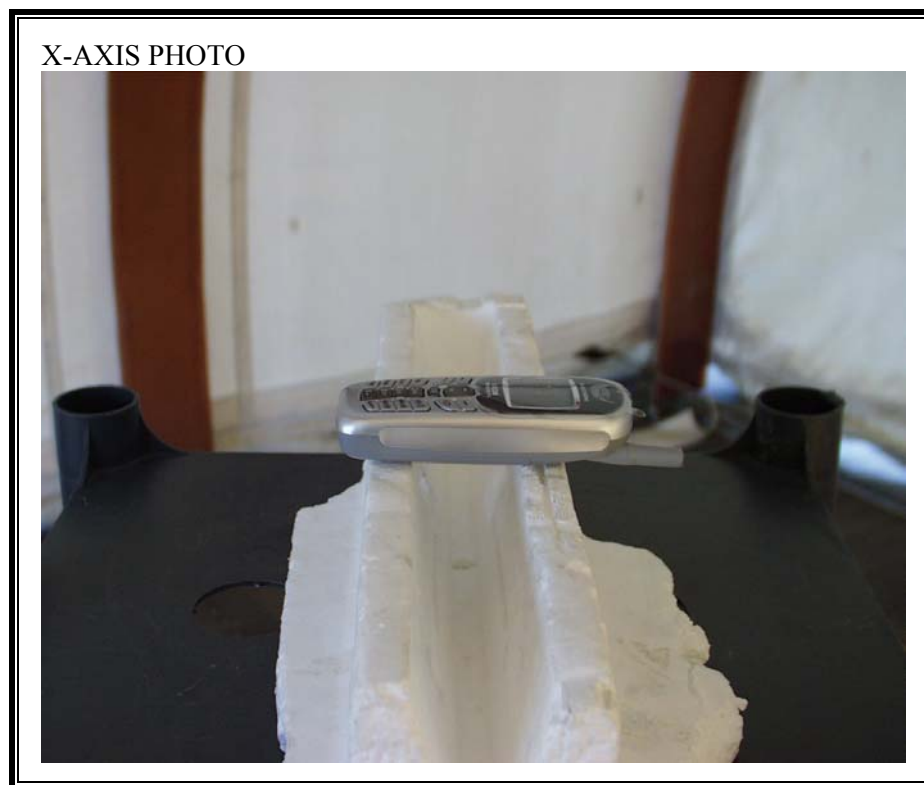

Y-AXIS PHOTO



Z-AXIS PHOTO



**DIGITAL DEVICE RADIATED EMISSIONS SETUP**

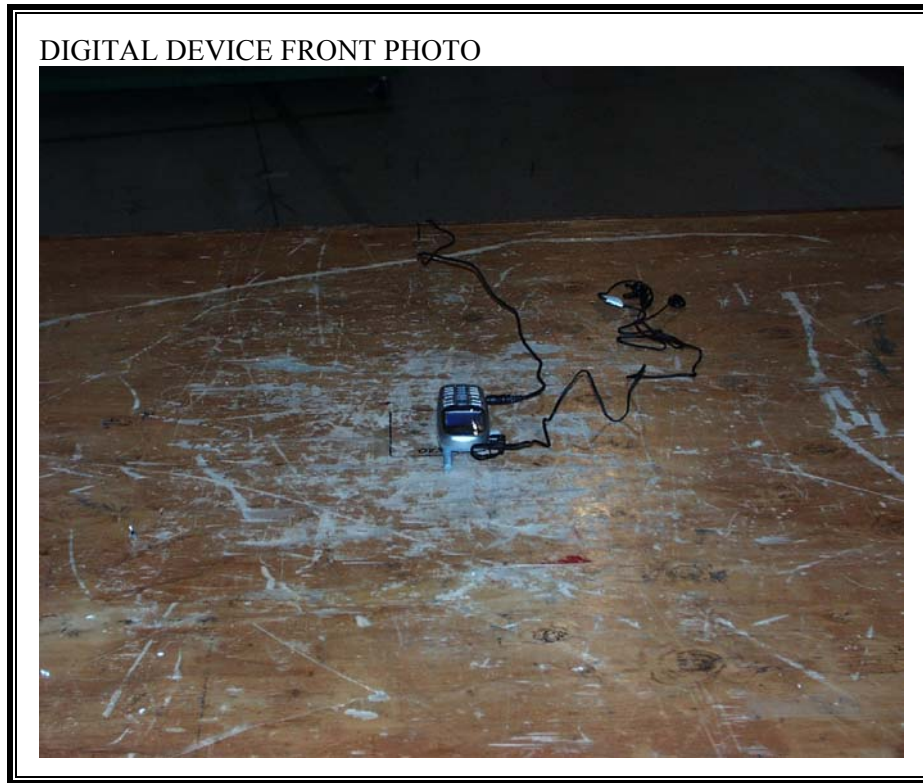





**POWERLINE CONDUCTED EMISSIONS MEASUREMENT SETUP**

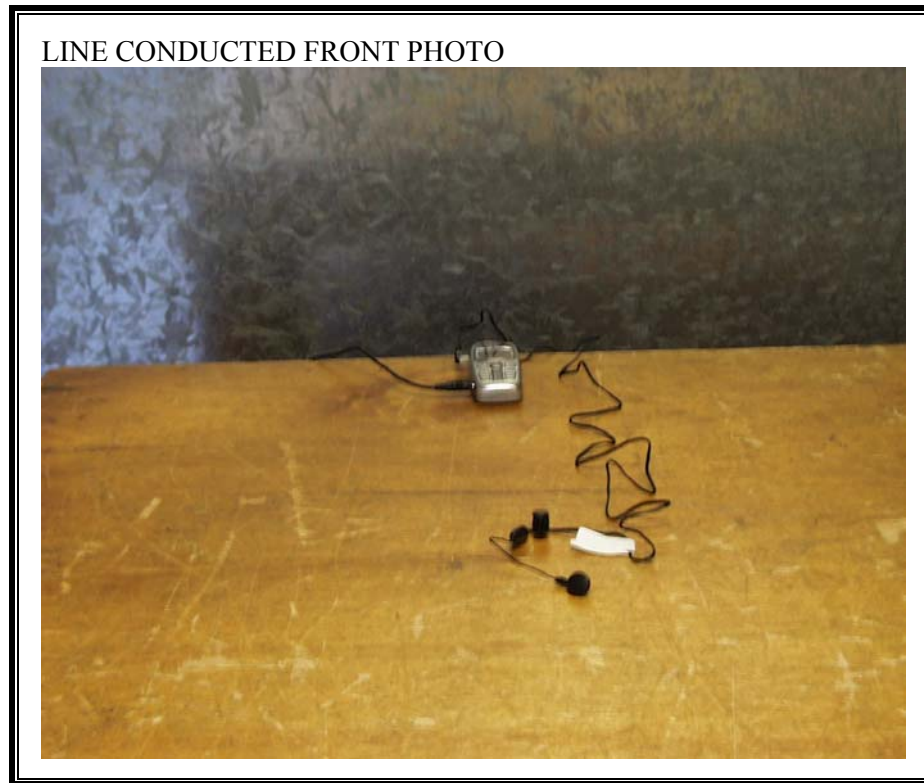



**END OF REPORT**