



FCC CFR47 CERTIFICATION

PART 22H

TEST REPORT

FOR

**SINGLE BAND 800MHZ DUAL MODE AMPS / CDMA
CELLULAR PHONE HANDSET WITH FIXED ANTENNA**

MODEL: VC-7C

FCC ID: GKRVC-7C

REPORT NUMBER: 03I2069-1

ISSUE DATE: JULY 6, 2003

Prepared for
**COMPAL ELECTRONICS, INC.
7F, NO. 500, JUIKUANG ROAD
NEIHU, TAIPEI TAIWAN ROC 114**

Prepared by
**COMPLIANCE CERTIFICATION SERVICES
561F MONTEREY ROAD, ROUTE 2
MORGAN HILL, CA 95037, USA
TEL: (408) 463-0885
FAX: (408) 463-0888**

TABLE OF CONTENT

1.	TEST RESULT CERTIFICATION.....	3
2.	EUT DESCRIPTION.....	4
3.	TEST METHODOLOGY.....	4
4.	TEST FACILITY.....	4
5.	ACCREDITATION AND LISTING.....	4
6.	MEASURING INSTRUMENT CALIBRATION.....	4
7.	TEST SETUP, PROCEDURE AND RESULT.....	5
7.1.	SECTION 2.1046: RF POWER OUTPUT.....	5
7.2.	SECTION 2.1047: MODULATION CHARACTERISTICS	12
7.3.	SECTION 2.1049: EMISSIONS MASK & OCCUPIED BANDWIDTH.....	18
7.3.1.	<i>Un-modulated Signal.....</i>	<i>19</i>
7.3.2.	<i>Voice</i>	<i>20</i>
7.3.3.	<i>Signalling Tone (ST).....</i>	<i>21</i>
7.3.4.	<i>Supervisory Audio Tone (SAT).....</i>	<i>22</i>
7.3.5.	<i>Signalling Tone (ST) + Supervisory Audio Tone (SAT).....</i>	<i>23</i>
7.3.6.	<i>Voice + Supervisory Audio Tone (SAT).....</i>	<i>24</i>
7.3.7.	<i>Wide Band Data (WBD).....</i>	<i>25</i>
7.4.	SECTION 2.1051: SPURIOUS EMISSION AT ANTENNA TERMINAL.....	33
7.5.	SECTION 2.1053: FIELD STRENGTH OF SPURIOUS RADIATION	46
7.6.	SECTION 2.1055: FREQUENCY STABILITY.....	51
8.	APENDIX.....	54
8.1.	EXTERNAL & INTERNAL PHOTOS.....	54
8.2.	SCHEMATICS.....	54
8.3.	BLOCK DIAGRAM.....	54
8.4.	USER MANUAL.....	54

1. TEST RESULT CERTIFICATION

COMPANY NAME: COMPAL ELECTRONICS, INC.
7F, NO. 500, JUIKUANG ROAD
NEIHU, TAIPEI TAIWAN ROC 114

CONTACT PERSON: ALLEN CHEN

TELEPHONE NO: (2) 8797-8599 EXT 6739

EUT DESCRIPTION: SINGLE BAND 800MHZ DUAL MODE AMPS / CDMA CELLULAR
PHONE HANDSET WITH FIXED ANTENNA

MODEM NAME: VC-7C

SERIAL NUMBER: LPP-0025

DATE TESTED: JULY 1, 2003

TYPE OF EQUIPMENT	INTENTIONAL RADIATOR
EQUIPMENT TYPE	LICENSED TX MODULE IN MOBILE APPLICATION
MEASUREMENT PROCEDURE	ANSI 63.4 / 2001, TIA/EIA 603
PROCEDURE	CERTIFICATION
FCC RULE	CFR 47 PART 22 Subpart H

Compliance Certification Services, Inc. tested the above equipment for compliance with the requirement set forth in CFR 47, PART 22 Subpart H-Cellular Radiotelephone Service. The equipment in the configuration described in this report, shows the measured emission levels emanating from the equipment do not exceed the specified limit.

Note: This document reports conditions under which testing was conducted and results of tests performed. This document may not be altered or revised in any way unless done so by Compliance Certification Services and all revisions are duly noted in the revisions section. Any alteration of this document not carried out by Compliance Certification Services will constitute fraud and shall nullify the document.

Tested By:



WILLIAM ZHUANG
EMC ENGINEER
COMPLIANCE CERTIFICATION SERVICES

Released For CCS By:



THU CHAN
EMC SUPERVISOR
COMPLIANCE CERTIFICATION SERVICES

2. EUT DESCRIPTION

The Dual Mode Mobile Phone has an output power 23.6dBm (AMPS, ERP) and 25.2dBm (CDMA, ERP), It has a Helix type antenna, -0.7dBi gain which is designed for the bands transmitting of frequency range 824 ~ 849MHz.

3. TEST METHODOLOGY

Both conducted and radiated testing were performed according to the procedures documented on chapter 13 of ANSI C63.4 and FCC CFR 47 2.1046, 2.1047, 2.1049, 2.1051, 2.1053, 2.1055 and 2.1057.

4. TEST FACILITY

The open area test sites and conducted measurement facilities used to collect the radiated data are located at 561F Monterey Road, Morgan Hill, California, USA. The sites are constructed in conformance with the requirements of ANSI C63.7, ANSI C63.4 and CISPR Publication 22.

5. ACCREDITATION AND LISTING

The test facilities used to perform radiated and conducted emissions tests are accredited by National Voluntary Laboratory Accreditation Program for the specific scope of accreditation under Lab Code: 200065-0 to perform Electromagnetic Interference tests according to FCC PART 15 AND CISPR 22 requirements. No part of this report may be used to claim or imply product endorsement by NVLAP or any agency of the US Government. In addition, the test facilities are listed with Federal Communications Commission (reference no: 31040/SIT (1300B3) and 31040/SIT (1300F2))

6. MEASURING INSTRUMENT CALIBRATION

The measuring equipment, which was utilized in performing the tests documented herein, has been calibrated in accordance with the manufacturer's recommendations for utilizing calibration equipment, which is traceable to recognized national standards.

7. TEST SETUP, PROCEDURE AND RESULT

7.1. SECTION 2.1046: RF POWER OUTPUT

INSTRUMENTS LIST

EQUIPMENT	MANUFACTURE	MODEL NO.	SERIAL NO.	CAL. DUE DATE
Modulation Analyzer	HP	8901b	3438A05272	6/23/04
PSA Analyzer	Agilent	E446A	US42070220	1/13/04
Audio Signal Generator	HP	3325A	2652A24749	5/8/04
10dB Attenuator	Agilent	8493C	59028	N/A
DC Power Supply	Kenwood	PA36-3A	7060074	N/A
Bilog Antenna	A.R.A.	LPB 2520/A	1185	3/6/04
Tune Dipole	ETS	DB-4	1629	5/14/04
Tx Horn Antenna	EMCO	3115	6739	2/4/2004
Rx Horn Antenna	EMCO	3115	6717	2/4/2004
Amplifier	MITEQ	NSP2600-SP	924342	4/25/2004
HPF	MICROLAB	FH-1800H	N/A	N/A

MEASUREMENT PROCEDURE

- 1). On a test site, the EUT shall be placed on a turntable, and in the position closest to the normal use as declared by the user.
- 2). The test antenna shall be oriented initially for vertical polarization located 3m from the EUT to correspond to the frequency of the transmitter.
- 3). The output of the test antenna shall be connected to the measuring receiver and either a peak or quasi-peak detector was used for the measurement as indicated on the report. The detector selection is based on how close the emission level was approaching the limit.
- 4). The transmitter shall be switched on, if possible, without the modulation and the measurement receiver shall be tuned to the frequency of the transmitter under test.
- 5). The test antenna shall be raised and lowered through the specified range of height until a maximum signal level is detected by the measuring receiver.
- 6). The transmitter shall than be rotated through 360° in the horizontal plane, until the maximum signal level is detected by the measuring receiver.
- 7). The test antenna shall be raised and lowered again through the specified range of height until a maximum signal level is detected by the measuring receiver.

- 8). The maximum signal level detected by the measuring receiver shall be noted.
- 9). The transmitter shall be replaced by a tuned dipole (substitution antenna).
- 10). The substitution antenna shall be oriented for vertical polarization and the length of the substitution antenna shall be adjusted to correspond to the frequency of the transmitter.
- 11). The substitution antenna shall be connected to a calibrated signal generator.
- 12). If necessary, the input attenuator setting of the measuring receiver shall be adjusted in order to increase the sensitivity of the measuring receiver.
- 13). The test antenna shall be raised and lowered through the specified range of the height to ensure that the maximum signal is received.
- 14). The input signal to the substitution antenna shall be adjusted to the level that produces a level detected by the measuring receiver, that is equal to the level noted while the transmitter radiated power was measured, corrected for the change of input attenuation setting of the measuring receiver.
- 15). The input level to the substitution antenna shall be recorded as power level in dBm, corrected for any change of input attenuator setting of the measuring receiver.
- 16). The measurement shall be repeated with the test antenna and the substitution antenna oriented for horizontal polarization.
- 17). The measure of the effective radiated power is the larger of the two levels recorded, at the input to the substitution antenna, corrected for the gain of the substitution antenna if necessary.

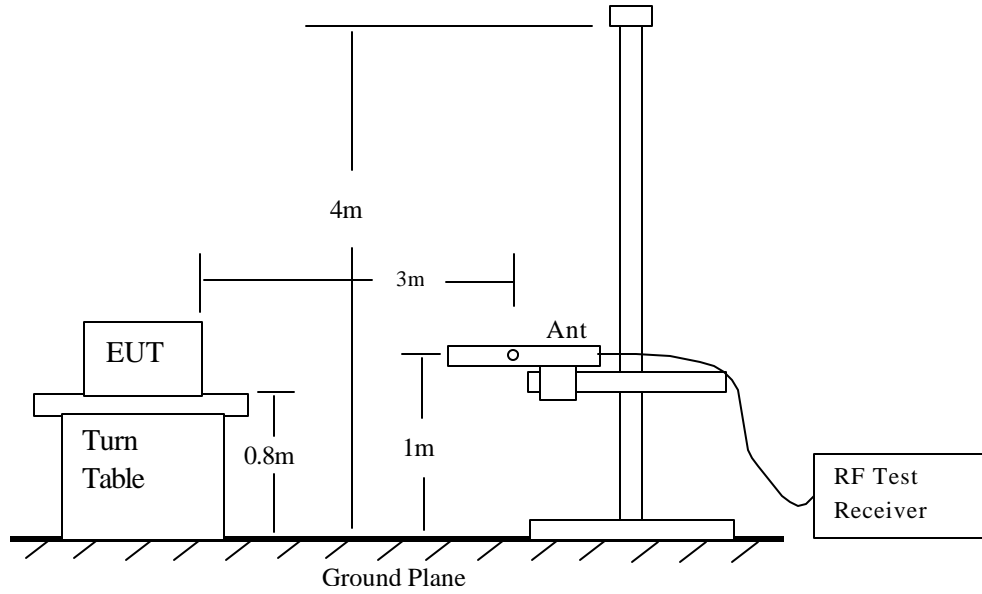

Radiated Emission Measurement 30 to 1000 MHz

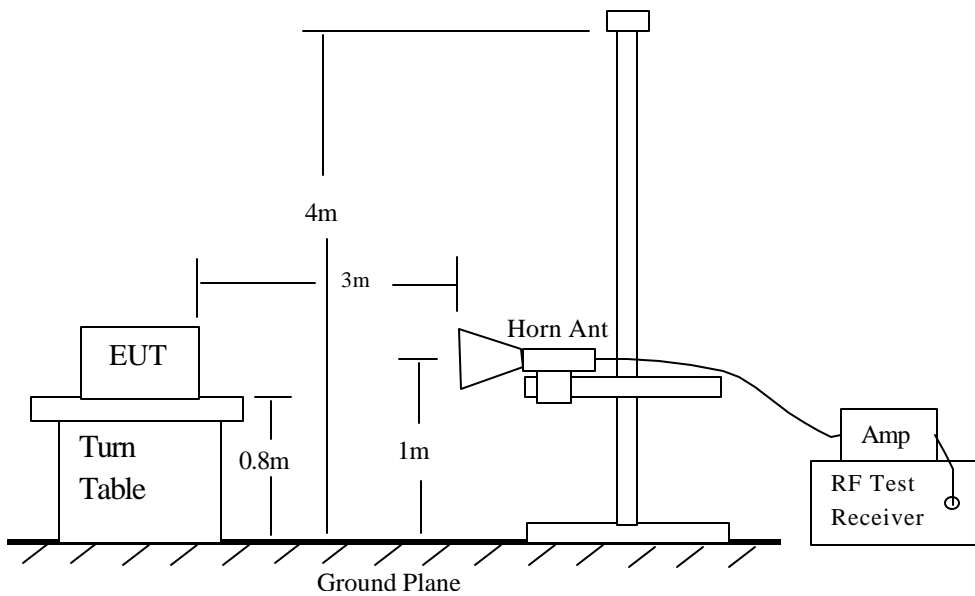

Radiated Emission Above 1000 MHz

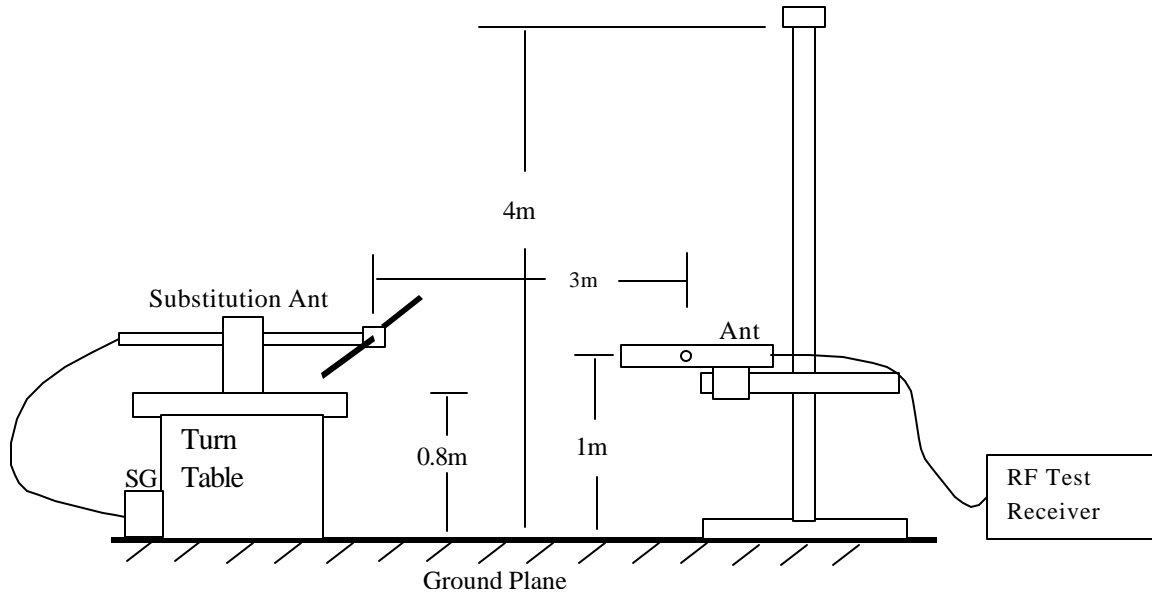

Radiated Emission – Substitution Method Set-up

MEASUREMENT RESULT:Conducted Output Power Measurement:

Company Name: Compal Electronics, Inc.

Project No.: 03I2069

EUT Description: Dual-Mode Single-Band Cellular Phone

AMPS

	Ch.#	Freq. (MHz)	Peak Power Meter (dBm)	Avg. Power Meter (dBm)
Low Ch.	991	824.04	26.44	26.09
Mid Ch.	383	836.49	26.31	25.96
High Ch.	799	848.97	26.36	26.05

RF Cable Loss 0.5 dB

CDMA

	Ch.#	Freq. (MHz)	Peak Power Meter (dBm)	Avg. Power Meter (dBm)
Low Ch.	1013	824.7	28.94	24.01
Mid Ch.	384	835.89	29.18	24.02
High Ch.	777	848.31	29.16	24.04

RF Cable Loss 0.5 dB

Note: Antenna Gain is -0.7dBi

Radiated Emissions



X-Position



Y-Position



Z-Position

AMPS Output Power (ERP):

f GHz	SA reading (dBuV)	SG reading (dBm)	CL (dB)	Gain (dBi)	Gain (dBd)	ERP (dBm)	Limit (dBm)	Margin (dB)	Notes
0.824	98.3	27.0	2.9	0.6	-1.6	22.5	38.5	-15.9	V, Z position
0.824	89.3	14.8	2.9	0.6	-1.6	10.3	38.5	-28.2	H, Z position
0.836	99.1	28.1	2.9	0.6	-1.6	23.6	38.5	-14.8	V, Z position
0.836	90.4	16.0	2.9	0.6	-1.6	11.6	38.5	-26.8	H, Z position
0.849	96.2	25.3	2.9	0.6	-1.6	20.9	38.5	-17.5	V, Z position
0.849	88.9	14.6	2.9	0.6	-1.6	10.2	38.5	-28.2	H, Z position

CDMA Output Power (ERP):

f GHz	SA reading (dBuV)	SG reading (dBm)	CL (dB)	Gain (dBi)	Gain (dBd)	ERP (dBm)	Limit (dBm)	Margin (dB)	Notes
0.824	98.7	27.4	2.9	0.6	-1.6	24.5	38.5	-14.0	V, Z position
0.824	89.7	15.2	2.9	0.6	-1.6	12.2	38.5	-26.3	H, Z position
0.836	99.2	28.1	2.9	0.6	-1.6	25.2	38.5	-13.3	V, Z position
0.836	90.4	16.0	2.9	0.6	-1.6	13.1	38.5	-25.4	H, Z position
0.848	98.4	27.6	2.9	0.6	-1.6	24.6	38.5	-13.9	V, Z position
0.848	89.3	15.1	2.9	0.6	-1.6	12.2	38.5	-26.3	H, Z position

7.2. SECTION 2.1047: MODULATION CHARACTERISTICS

PROVISIONS APPLICABLE

According to CFR 47 section 2.1047 (a), for Voice Modulated Communication Equipment, the frequency response of the audio modulation circuit over a range of 100 to 5000 Hz shall be measured.

According to CFR 47 section 22.915 _ An unit that transmits emission type F3E must not exceed a peak frequency deviation of ± 5 KHz, and the audio frequency response shall not exceed 3.125 KHz.

According to CFR 47 section 22.915 _ Audio Frequency Low Pass Filter between the modulation limiter & the modulation stage of the transmitter. At any frequency (f in KHz) between 3 and 20 KHz, the filter must have an attenuation of at least $60 \log_{10}(f/3)$ dB greater than the attenuation at 1 KHz. Above 20 KHz, it must have an attenuation of at least 50 dB greater than the attenuation at 1 KHz.

MEASUREMENT METHOD

Modulation Limit

- 1). Configure the EUT as shown below, adjust the audio input for 60% of rated system deviation at 1 KHz using this level as a reference (0 dB) and vary the input level from -20 to +20 dB. Record the frequency deviation obtained as a function of the input level.
- 2). Repeat step 1 with input frequency changing to 300, 1004, and 2500 Hz in sequence.

Audio Frequency Response

- 1). Configure the EUT as shown below.
- 2). Adjust the audio input for 20% of rated system deviation at 1 KHz using this level as a reference (0 dB).
- 3). Vary the Audio frequency from 100 Hz to 10 KHz and record the frequency deviation.
- 4). Audio Frequency Response = $20 \log_{10}$ (Deviation of test frequency / Deviation of 1KHz reference).

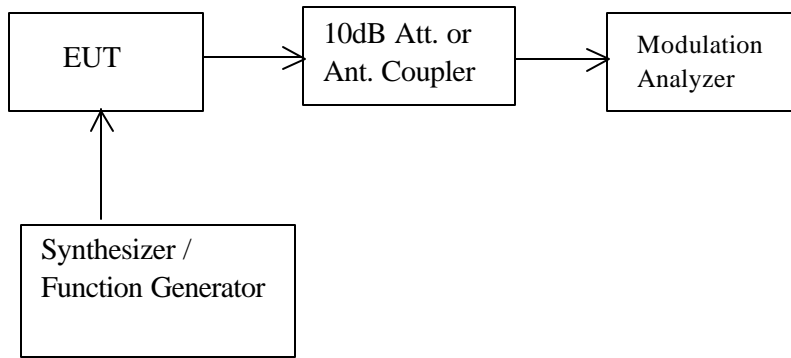

Modulation characteristic measurement configuration

Audio Low Pass Filter Response

- 1). Configure the EUT as shown below.
- 2). Connect the audio frequency generator as close as possible the input of the post limiter low pass filter within the transmitter under test.
- 3). Connect the audio spectrum analyzer to the output of the post limiter low pass filter within the transmitter under test.
- 4). Apply 1000 Hz tone from the audio frequency generator and adjust the level per manufacturer's specifications.
- 5). Record the dB level of the 1000 Hz spectral line on the audio spectrum analyzer as LEV_{REF} .
- 6). Set the audio frequency generator to the desired test frequency between 3000 Hz and the upper low pass filter limit.
- 7). Record audio spectrum analyzer levels, at the frequency in step 6).
- 8). Record the dB level on the audio spectrum analyzer as LEV_{FREQ} .
- 9). Calculate the audio frequency response at the test frequency as:

$$\text{low pass filter response} = LEV_{FREQ} - LEV_{REF}$$
- 10). Repeat the 6) through 9) for all the desired test frequencies.

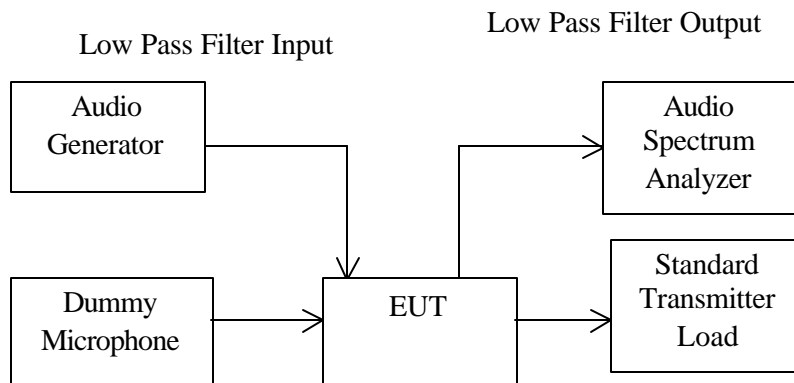

Audio low pass filter response measurement configuration

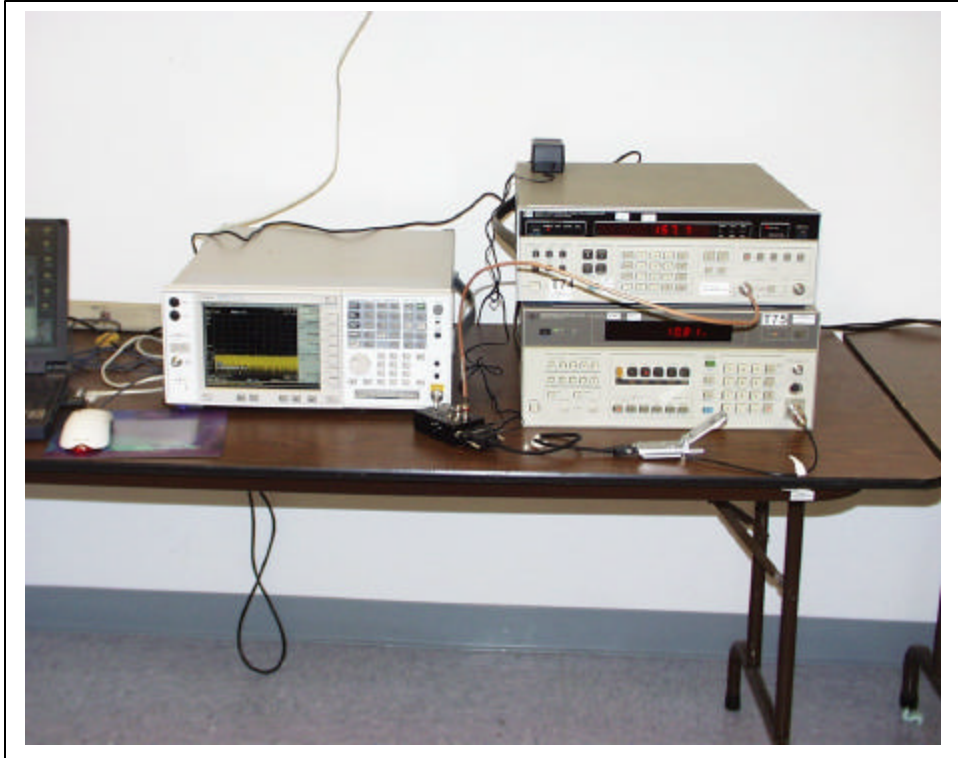

MEASUREMENT INSTRUMENT

EQUIPMENT	MANUFACTURE	MODEL NO.	SERIAL NO.	CAL. DUE DATE
Modulation Analyzer	HP	8901b	3438A05272	6/23/04
PSA Analyzer	Agilent	E446A	US42070220	1/13/04
Audio Signal Generator	HP	3325A	2652A24749	5/8/04
10dB Attenuator	Agilent	8493C	59028	N/A
DC Power Supply	Kenwood	PA36-3A	7060074	N/A

MEASUREMENT RESULT:

a). Modulation Limit:

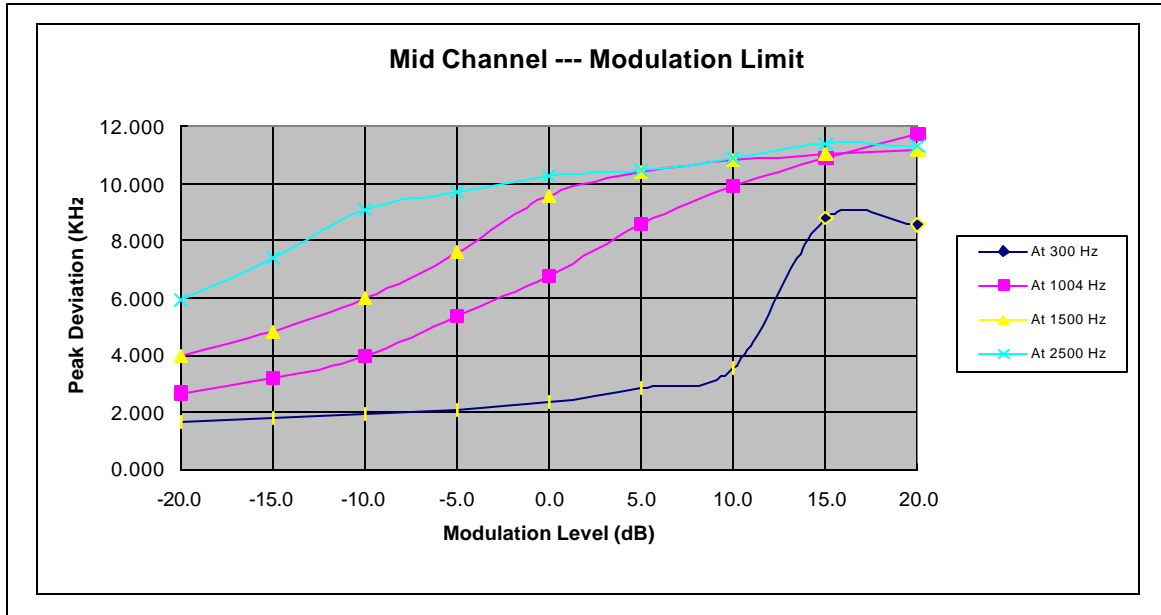

b). Audio Frequency Response:

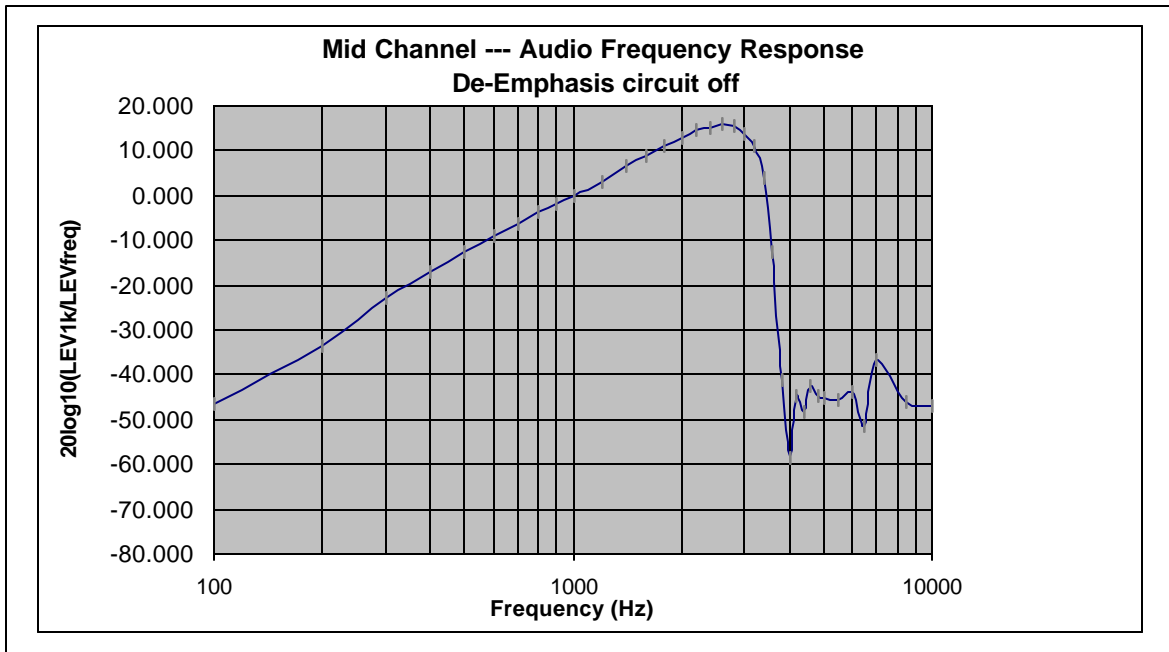

c). Audio low pass filter response:

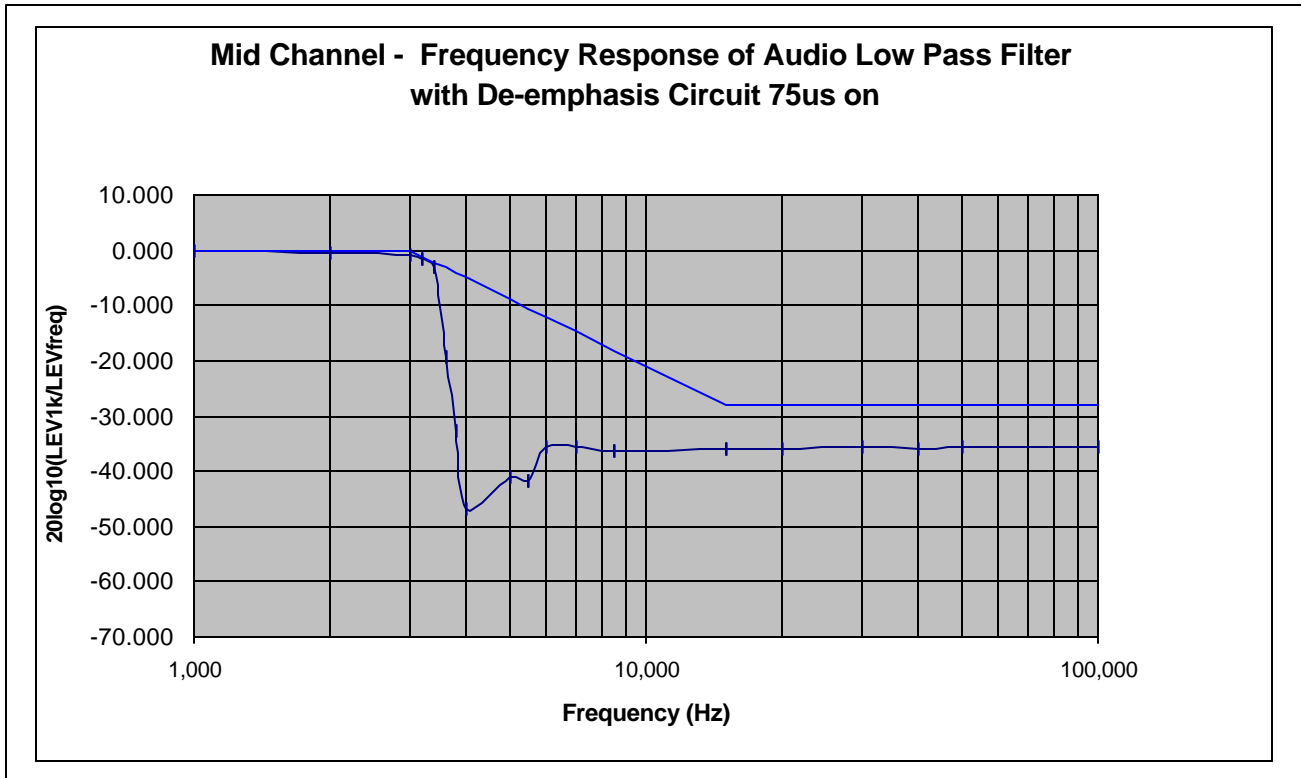

7.3. SECTION 2.1049: EMISSIONS MASK & OCCUPIED BANDWIDTH

PROVISIONS APPLICABLE

According to CFR 47 section 22.917.

TEST SETUP

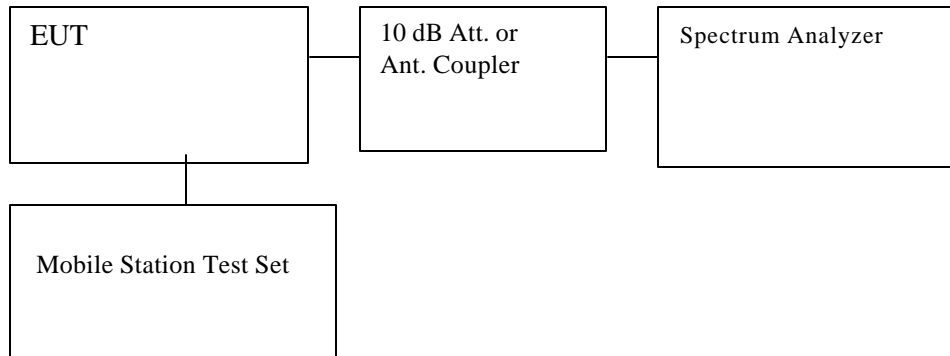

Set-up Configuration

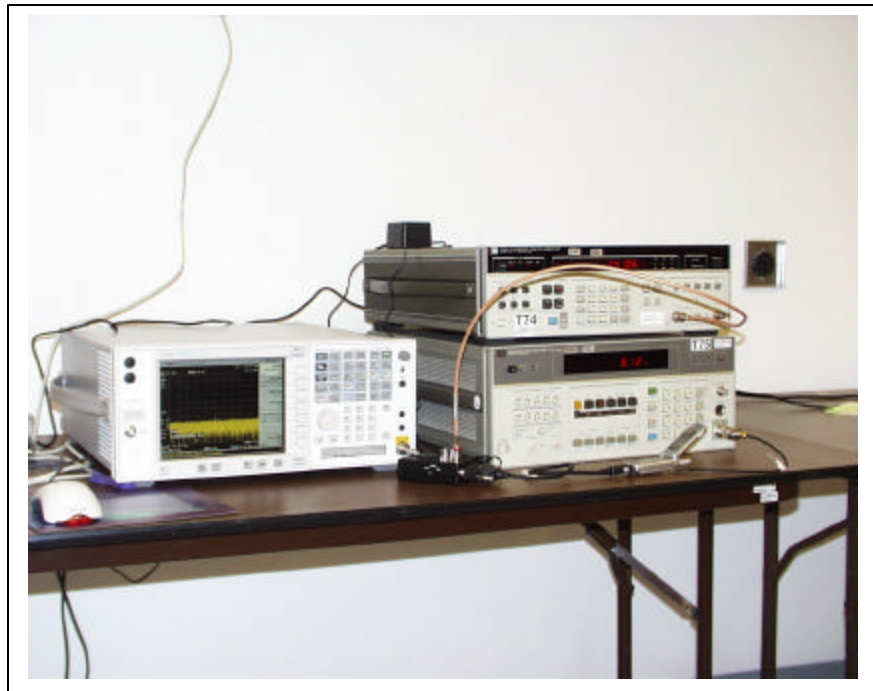

7.3.1. Un-modulated Signal

INSTRUMENT SETTING:

Resolution Bandwidth = 300Hz

Video Bandwidth = 300Hz

Limit:

N/A

Test Result:

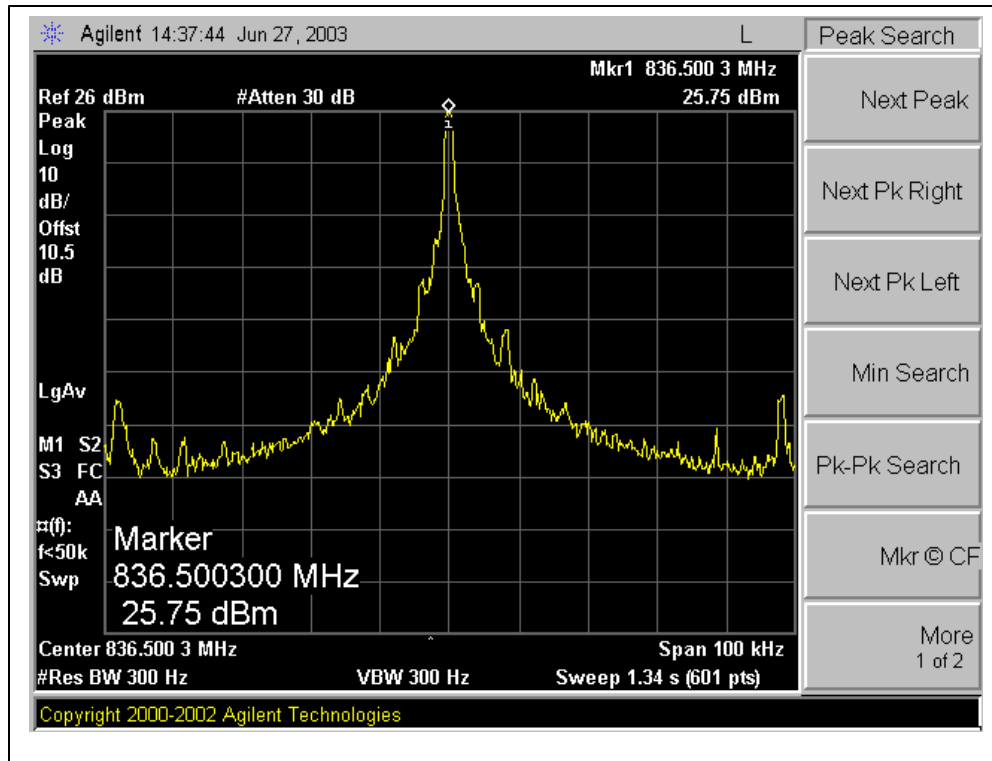

7.3.2. Voice

INSTRUMENT SETTING:

Resolution Bandwidth = 300Hz

Video Bandwidth = 300Hz

Audio Tone = 2.5KHz

Audio Level = 16dB greater than level required to produce ±6KHz

Limit (22.917b):

- a. On any frequency removed from the assigned carrier frequency by more than 20KHz, up to and including 45KHz, the sideband is at least 26dB below the carrier.
- b. On any frequency removed from the assigned carrier frequency by more than 45KHz, up to the first multiple of the carrier frequency, the sideband is at least 60dB below the carrier or $43 + 10 \log_{10}$ (mean output power in W) dB, whichever is the smaller attenuation

Test Result:

Voice

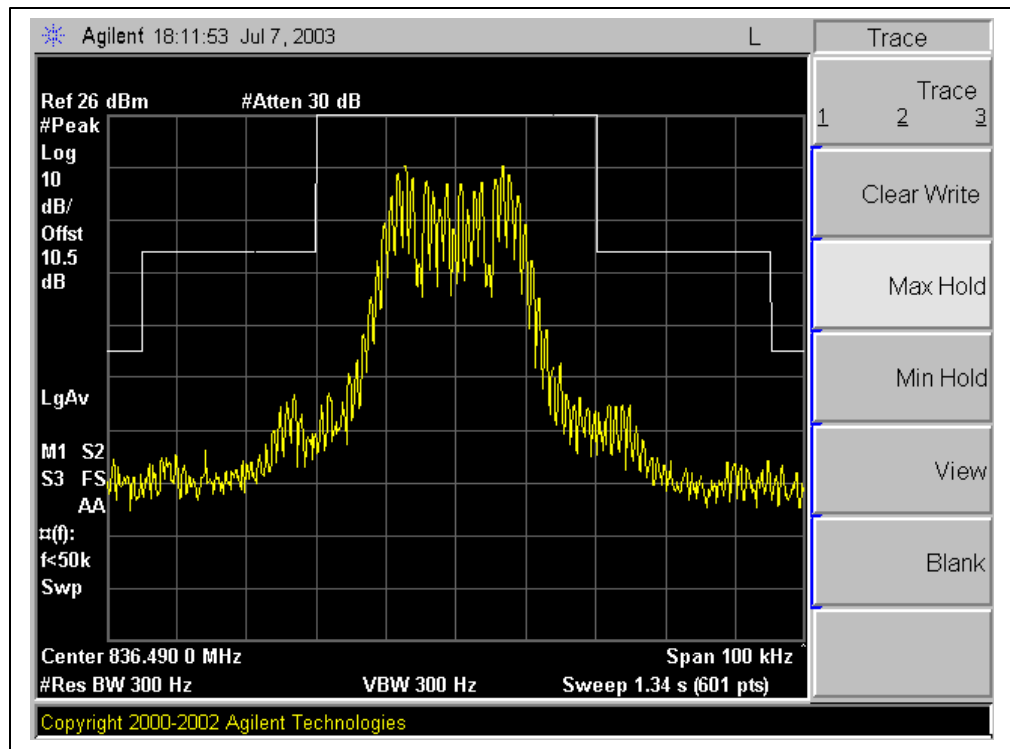

7.3.3. Signalling Tone (ST)

INSTRUMENT SETTING:

Resolution Bandwidth = 300Hz

Video Bandwidth = 300Hz

Signal Tone = 10KHz

Limit (22.917d):

- a. On any frequency removed from the assigned carrier frequency by more than 20KHz, up to and including 45KHz, the sideband is at least 26dB below the carrier.
- b. On any frequency removed from the assigned carrier frequency by more than 45KHz, up to and including 90KHz, the sideband is at least 45dB below the carrier.
- c. On any frequency removed from the assigned carrier frequency by more than 90KHz, up to the first multiple of the carrier frequency, the sideband is at least 60dB below the carrier or $43 + 10 \log_{10}$ (mean output power in W) dB, whichever is the smaller attenuation.

Test Result:

Signalling Tone (ST)

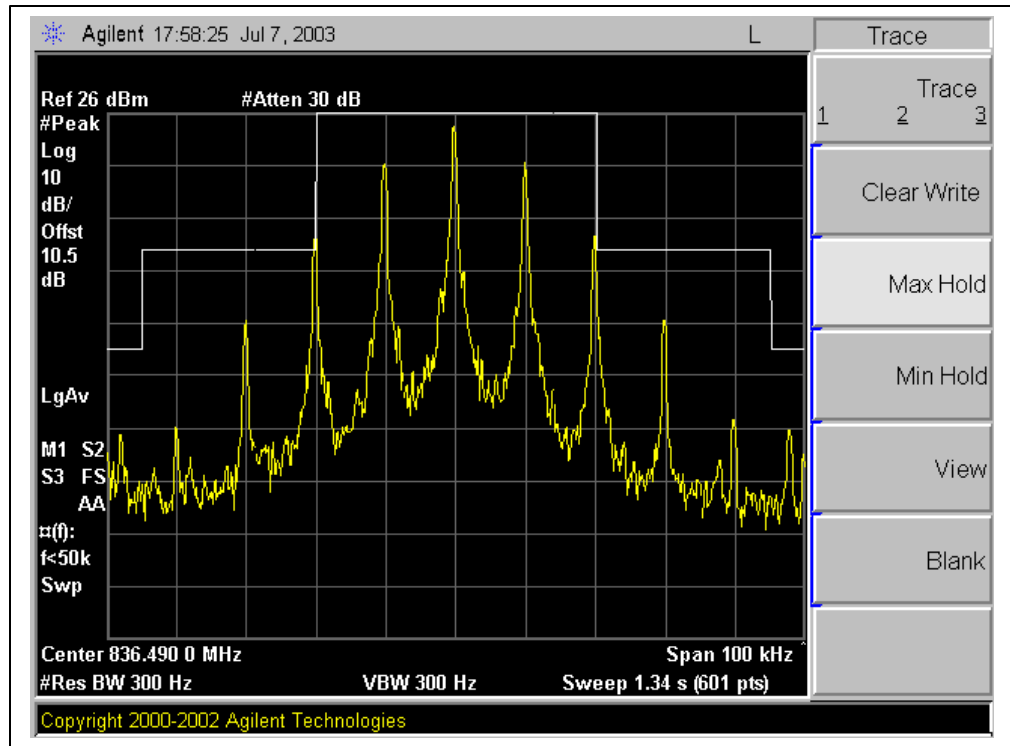

7.3.4. Supervisory Audio Tone (SAT)

INSTRUMENT SETTING:

Resolution Bandwidth = 300Hz

Video Bandwidth = 300Hz

Signal Tone = 10KHz

Limit (22.917d):

- d. On any frequency removed from the assigned carrier frequency by more than 20KHz, up to and including 45KHz, the sideband is at least 26dB below the carrier.
- e. On any frequency removed from the assigned carrier frequency by more than 45KHz, up to and including 90KHz, the sideband is at least 45dB below the carrier.
- f. On any frequency removed from the assigned carrier frequency by more than 90KHz, up to the first multiple of the carrier frequency, the sideband is at least 60dB below the carrier or $43 + 10 \log_{10}$ (mean output power in W) dB, whichever is the smaller attenuation.

Test Result:

Supervisory Audio Tone (SAT)

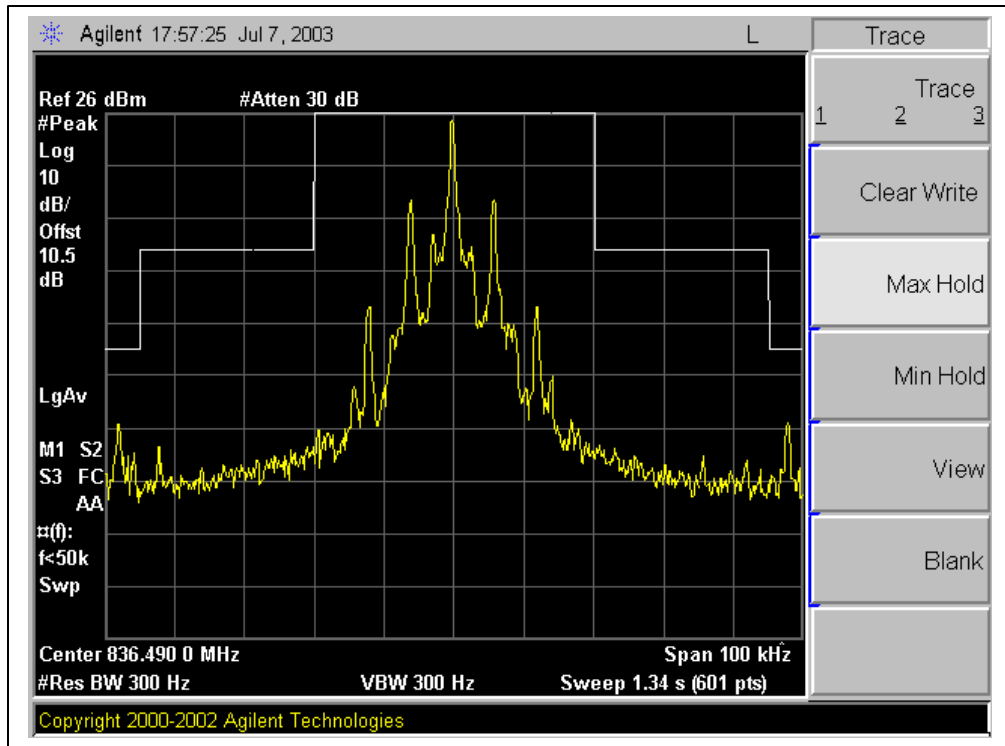

7.3.5. Signalling Tone (ST) + Supervisory Audio Tone (SAT)

INSTRUMENT SETTING:

Resolution Bandwidth = 300Hz

Video Bandwidth = 300Hz

Signal Tone = 10KHz

Limit (22.917d):

- g. On any frequency removed from the assigned carrier frequency by more than 20KHz, up to and including 45KHz, the sideband is at least 26dB below the carrier.
- h. On any frequency removed from the assigned carrier frequency by more than 45KHz, up to and including 90KHz, the sideband is at least 45dB below the carrier.
- i. On any frequency removed from the assigned carrier frequency by more than 90KHz, up to the first multiple of the carrier frequency, the sideband is at least 60dB below the carrier or $43 + 10 \log_{10}$ (mean output power in W) dB, whichever is the smaller attenuation.

Test Result:

Signalling Tone (ST) + Supervisory Audio Tone (SAT)

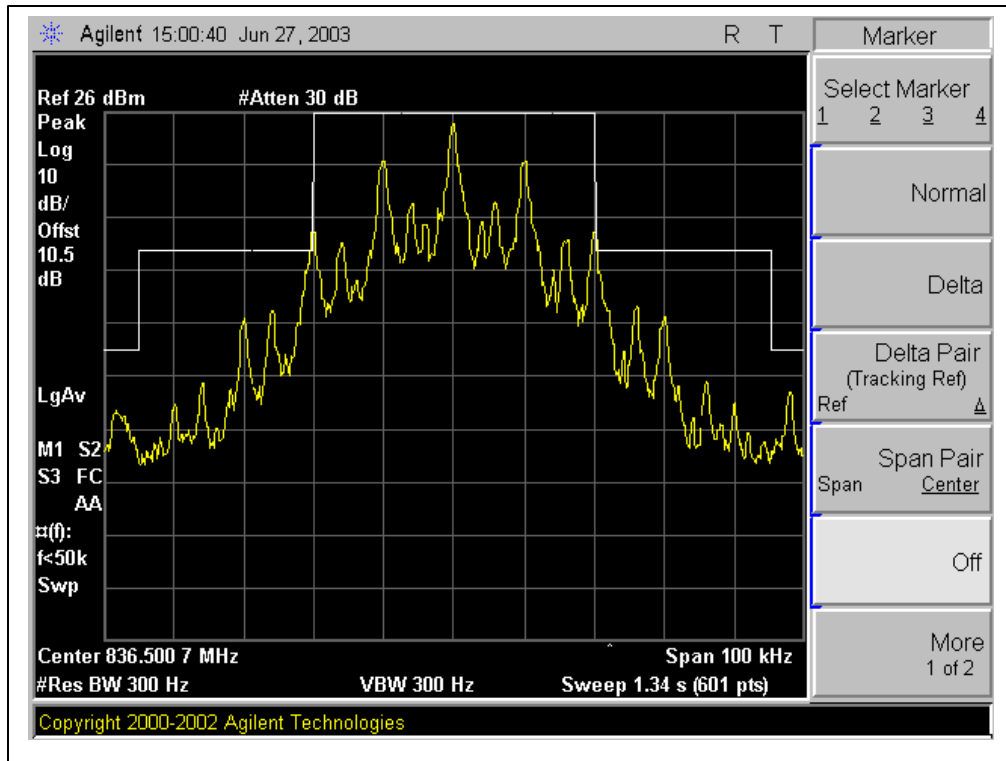

7.3.6. Voice + Supervisory Audio Tone (SAT)

INSTRUMENT SETTING:

Resolution Bandwidth = 300Hz

Video Bandwidth = 300Hz

Audio Tone = 2.5KHz

Audio Level = Tone, 16dB greater than level required to produce ±6KHz of deviation add SAT with ±2KHz of deviation (Minimum level from technical specifications)

Limit (22.917b):

- b. On any frequency removed from the assigned carrier frequency by more than 20KHz, up to and including 45KHz, the sideband is at least 26dB below the carrier.
- c. On any frequency removed from the assigned carrier frequency by more than 45KHz, up to the first multiple of the carrier frequency, the sideband is at least 60dB below the carrier or $43 + 10 \log_{10}$ (mean output power in W) dB, whichever is the smaller attenuation

Test Result:

Voice + Supervisory Audio Tone (SAT)

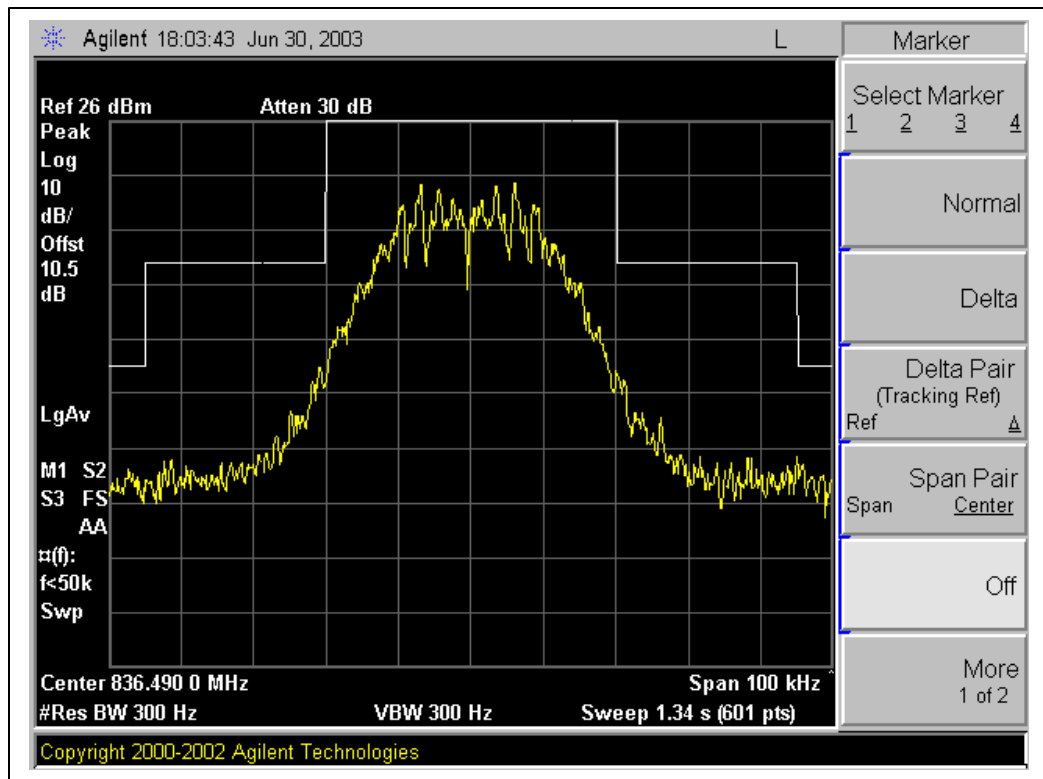

7.3.7. Wide Band Data (WBD)

INSTRUMENT SETTING:

Resolution Bandwidth = 300Hz

Video Bandwidth = 300Hz

Limit (22.917d):

- a. On any frequency removed from the assigned carrier frequency by more than 20KHz, up to and including 45KHz, the sideband is at least 26dB below the carrier.
- b. On any frequency removed from the assigned carrier frequency by more than 45KHz, up to and including 90KHz, the sideband is at least 45dB below the carrier.
- c. On any frequency removed from the assigned carrier frequency by more than 90KHz, up to the first multiple of the carrier frequency, the sideband is at least 60dB below the carrier or $43 + 10 \log_{10}$ (mean output power in W) dB, whichever is the smaller attenuation.

Test Result:

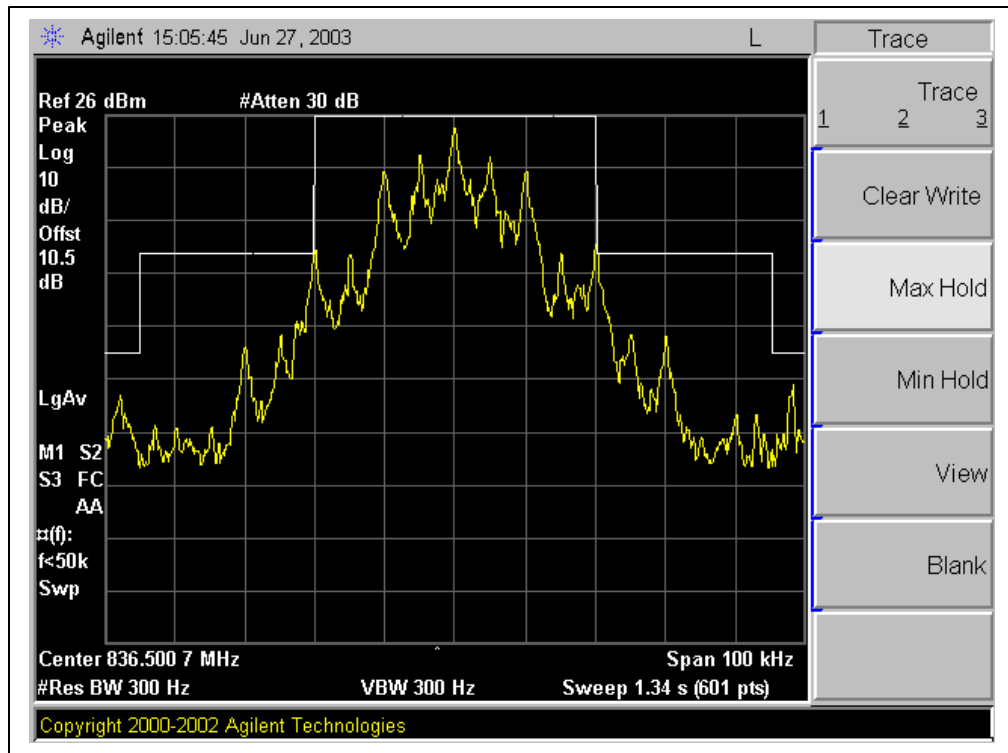

TEST PROCEDURE FOR OCCUPIED BANDWIDTH

The EUT's output RF connector was connected with a short cable to the spectrum analyzer, RES BW was set to about 1% of emission BW, -26 dBc display line was placed on the screen, the occupied BW is the delta frequency between the two points where the display line intersects the signal trace. 26dB BW was measured for low, middle and high channels on both RF input and output ports of the EUT.

TEST SETUP

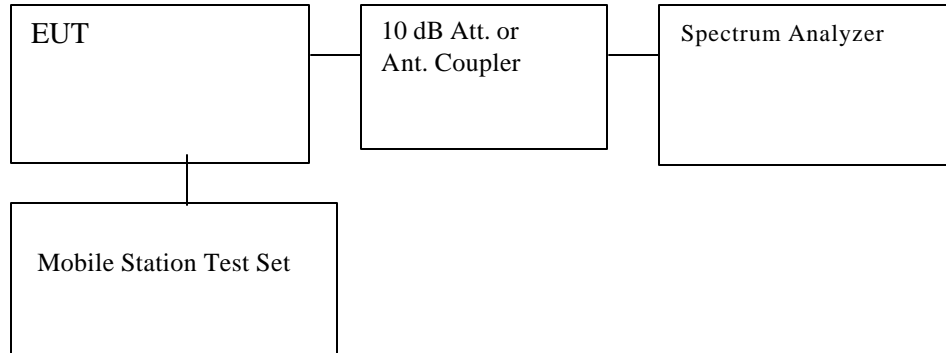
RESULT

Reporting requirement only.

Channel	Frequency (MHz)	AMPS -26dBc BW (KHz)	CDMA -26dBc BW (MHz)
Low	824.70	41.476	1.372
Middle	836.49	41.500	1.401
High	848.31	41.808	1.393

AMPS MODULATION:

Low Channel

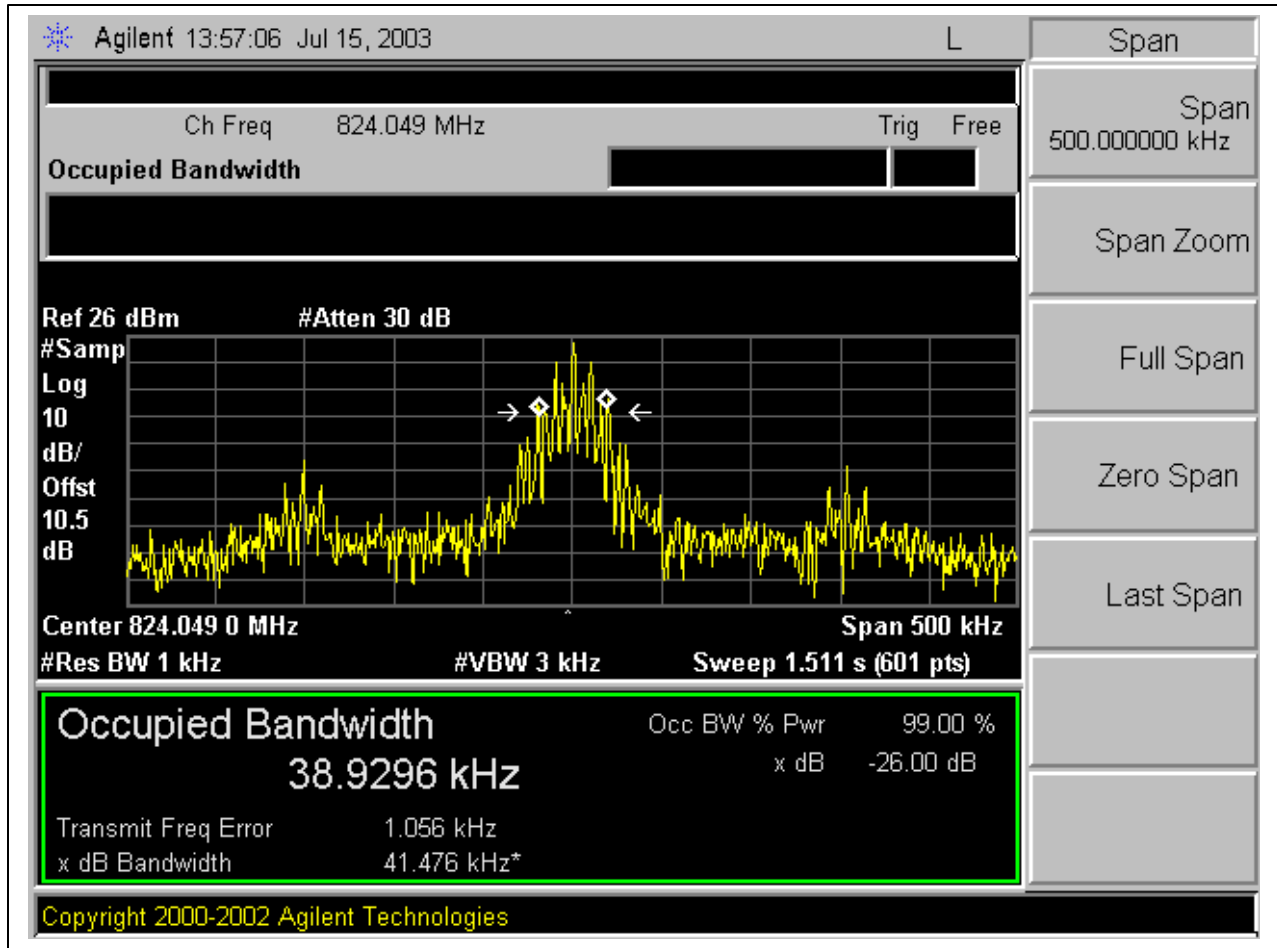

Mid Channel

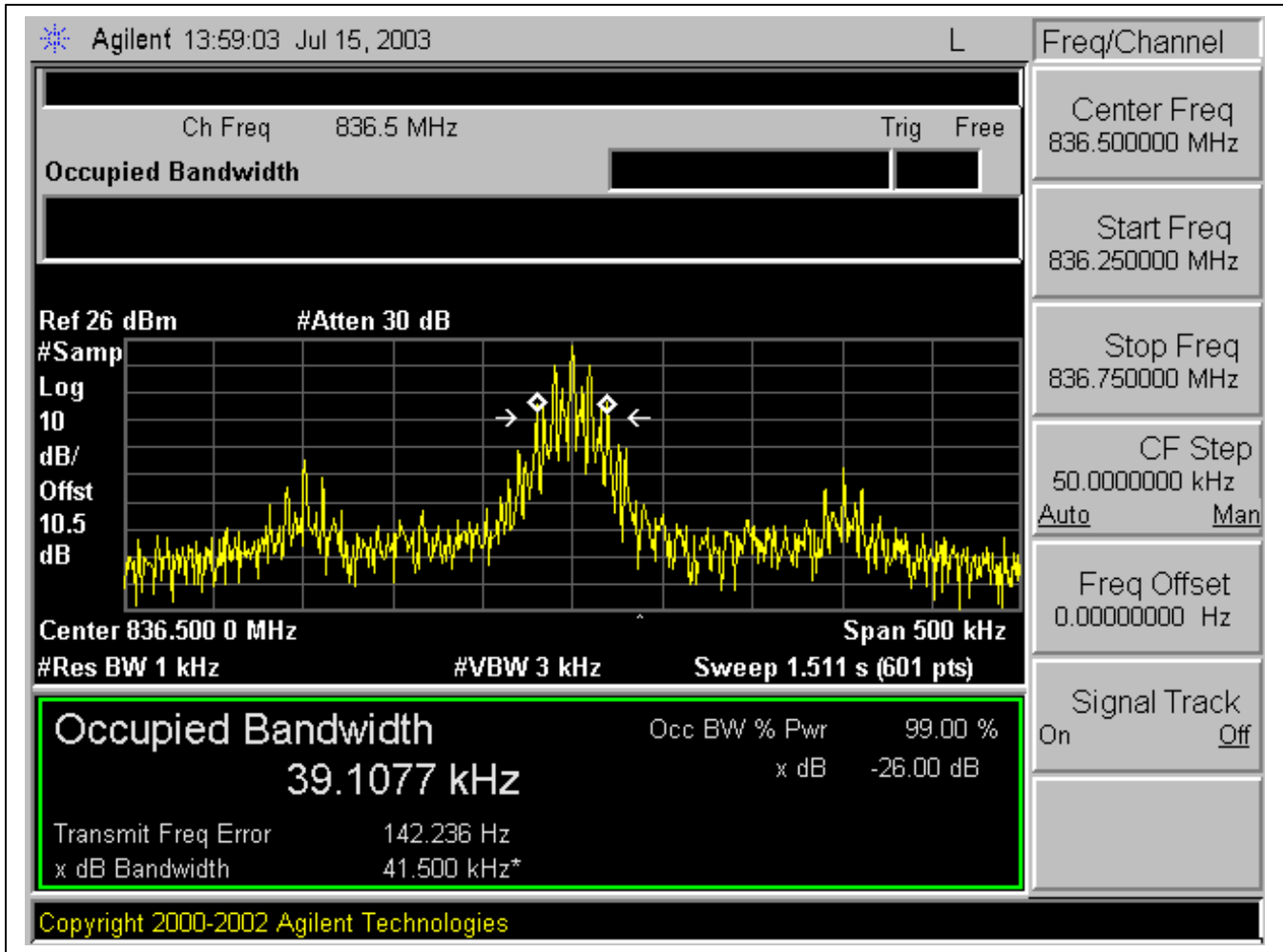

High Channel

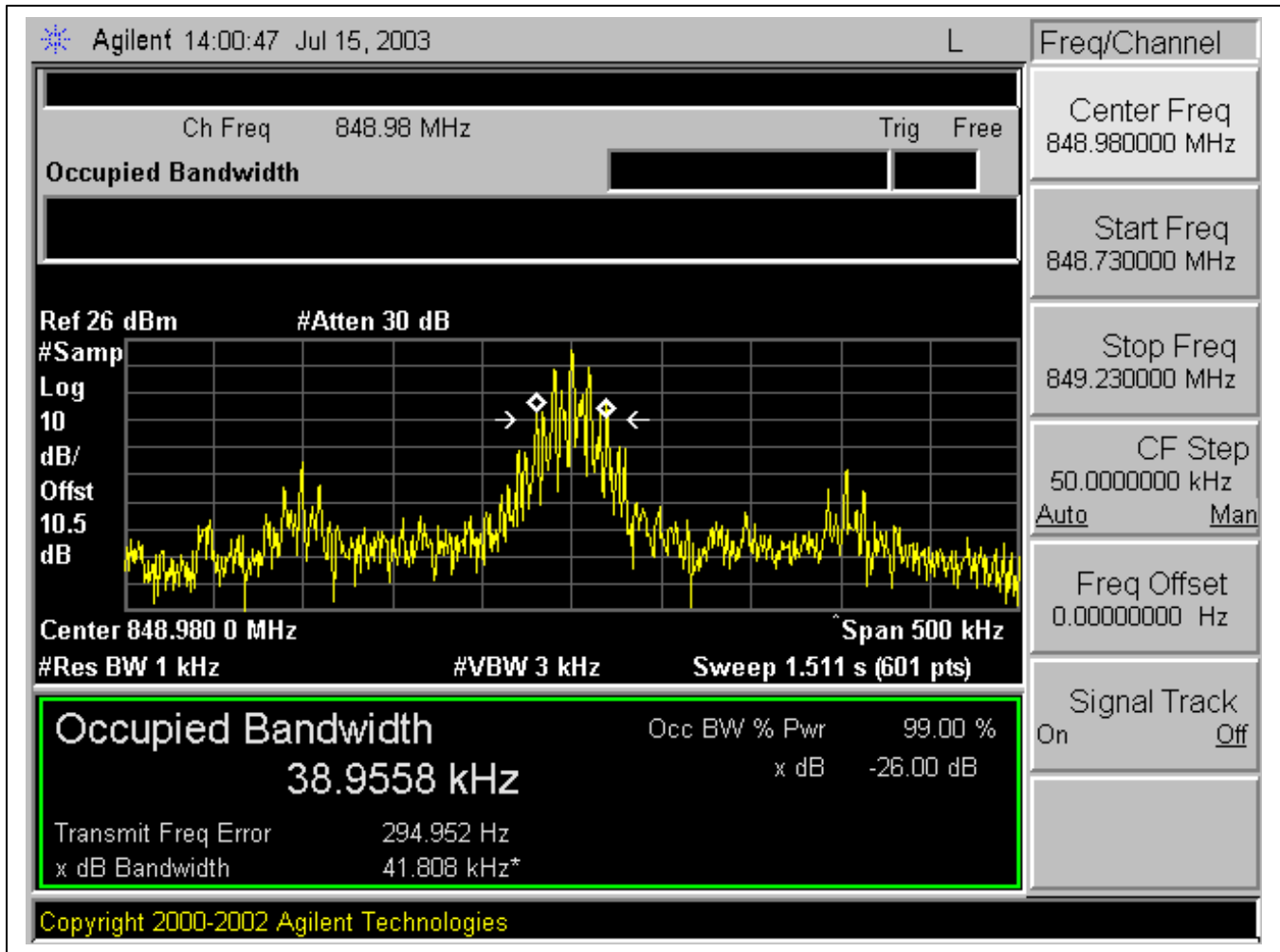

CDMA MODULATION:

Low Channel

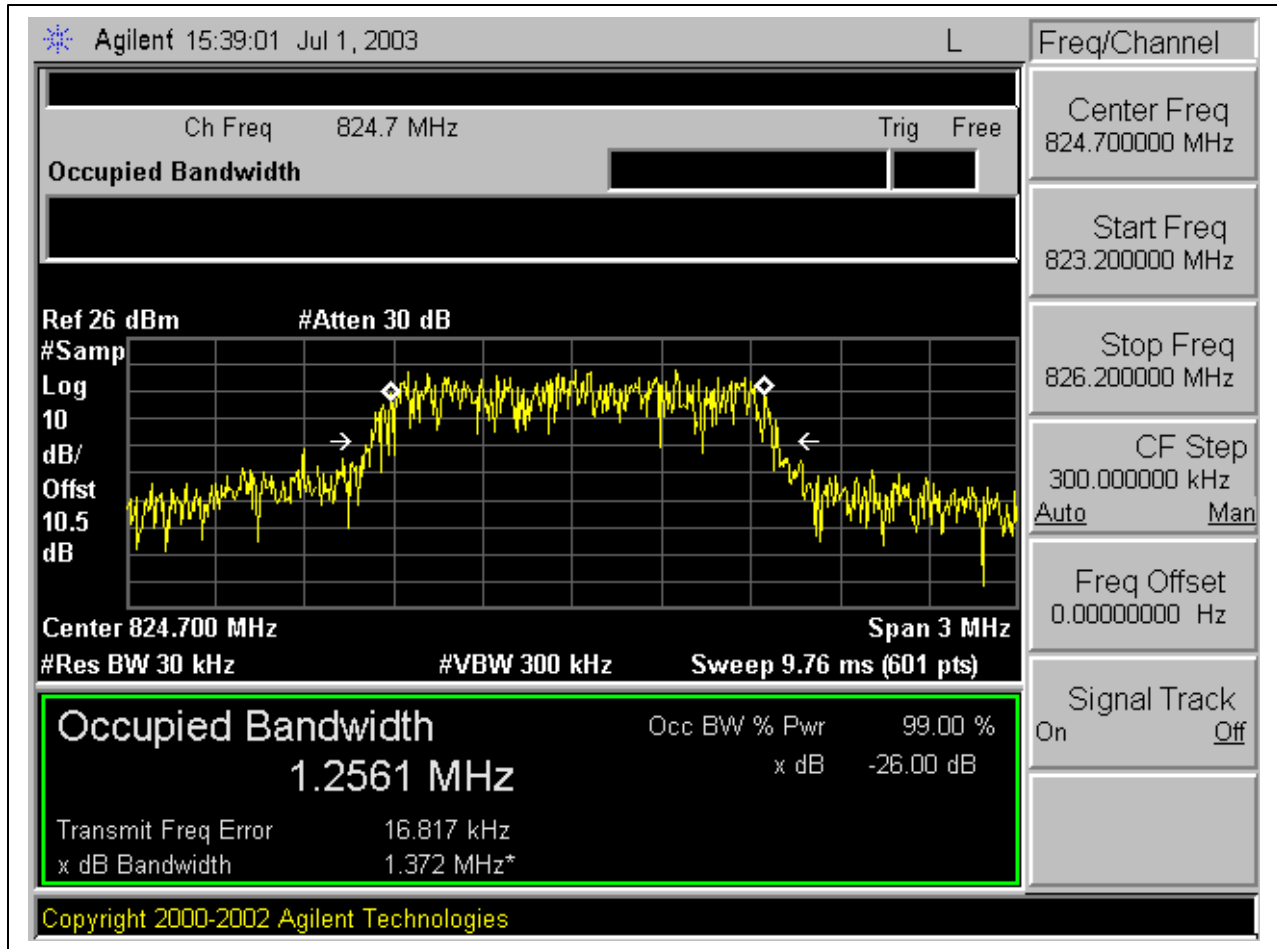

Mid Channel

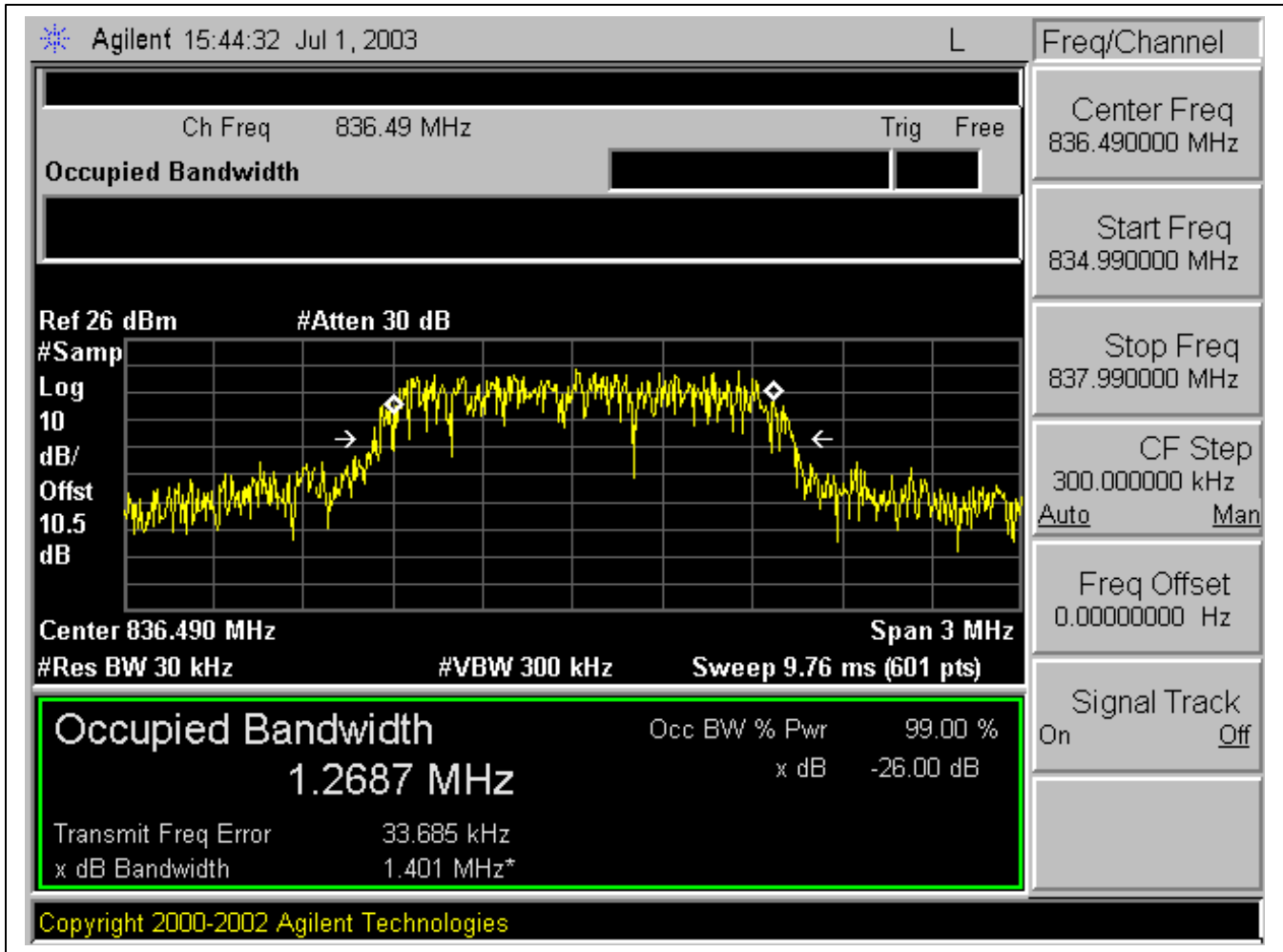

High Channel

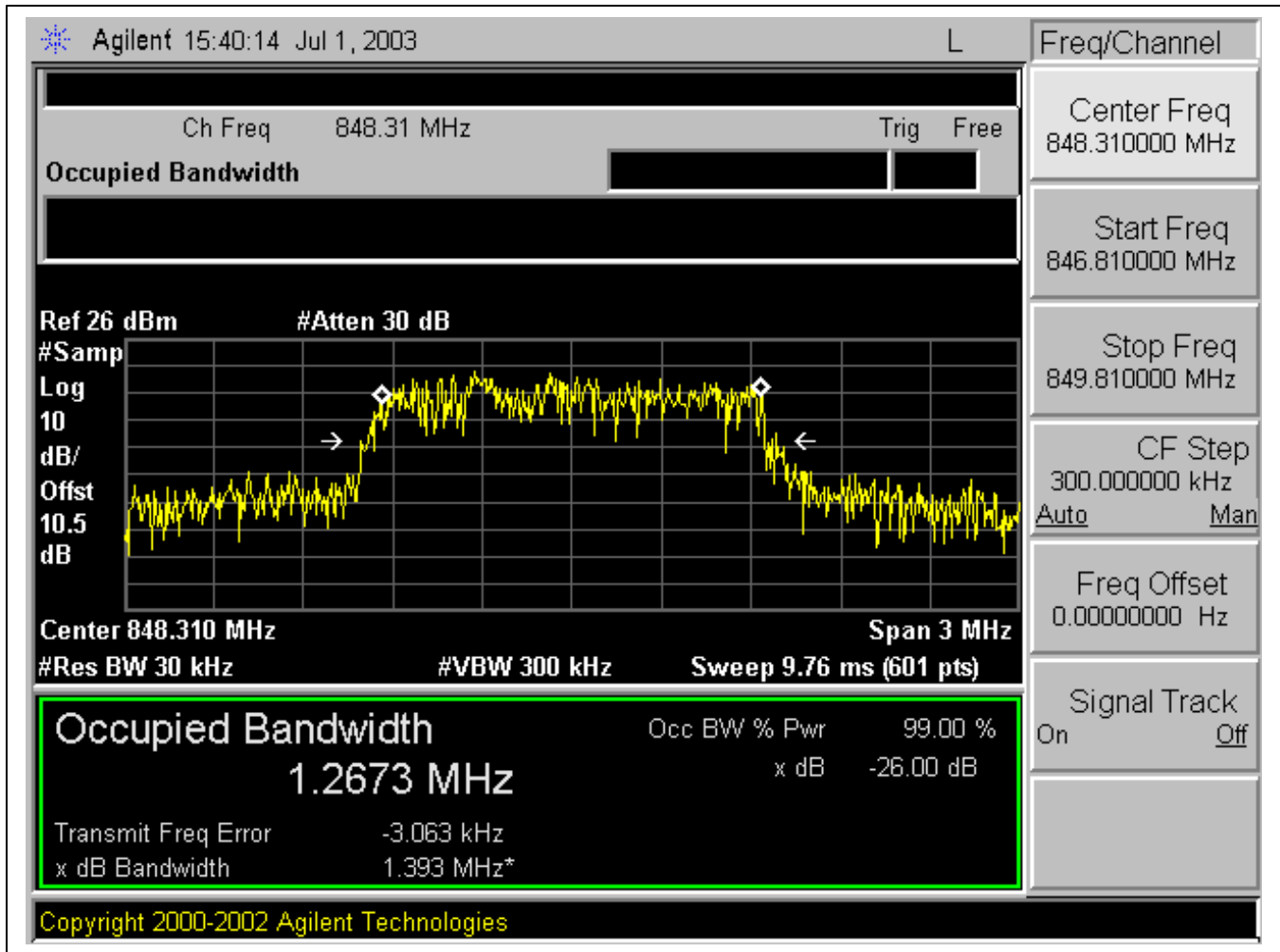

7.4. SECTION 2.1051: SPURIOUS EMISSION AT ANTENNA TERMINAL

INSTRUMENTS LIST

EQUIPMENT	MANUFACTURE	MODEL NO.	SERIAL NO.	CAL. DUE DATE
Modulation Analyzer	HP	8901b	3438A05272	6/23/04
PSA Analyzer	Agilent	E446A	US42070220	1/13/04
Audio Signal Generator	HP	3325A	2652A24749	5/8/04
Mobile Test Set	Agilent	E8285A	GB4131011	9/11/04
10dB Attenuator	Agilent	8493C	59028	N/A
Power Splitter	Agilent	11667B	53331	N/A

TEST SETUP

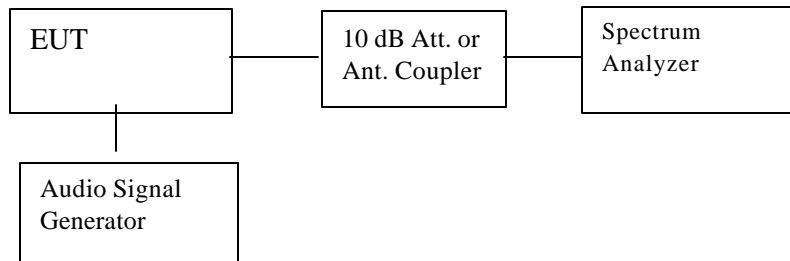

TEST PROCEDURE

- 1) EUT's RF output connector (made solely for the purpose of the test) is connected to the spectrum analyzer, and set as close as possible to the bottom of the block edge and one set as close as possible to the top of the block edge. Set the RES BW to 1% of the emission bandwidth to show compliance with the -13dBm limit, in the 1 MHz bands immediately outside and adjacent to the top and bottom edges of the frequency block.
- 2) For the Out-of-Band measurements a 1 MHz RES BW was used to scan from 15 MHz to $10 \times f_0$ of the fundamental carrier for all frequency block. A display line was placed at -13dBm to show compliance for spurious, and harmonics.
- 3) 22.917(f): Mobile emissions in base frequency range. The mean power of any emissions appearing in the base station frequency range from cellular mobile transmitter operated must be attenuated to a level not to exceed -80dBm at the transmit antenna connector.

MEASUREMENT RESULT:

AMPS Modulation:

Low Band Edge- Ch 991-824MHz-SAT+ST (Channel Block A 824.04 – 834.99MHz)

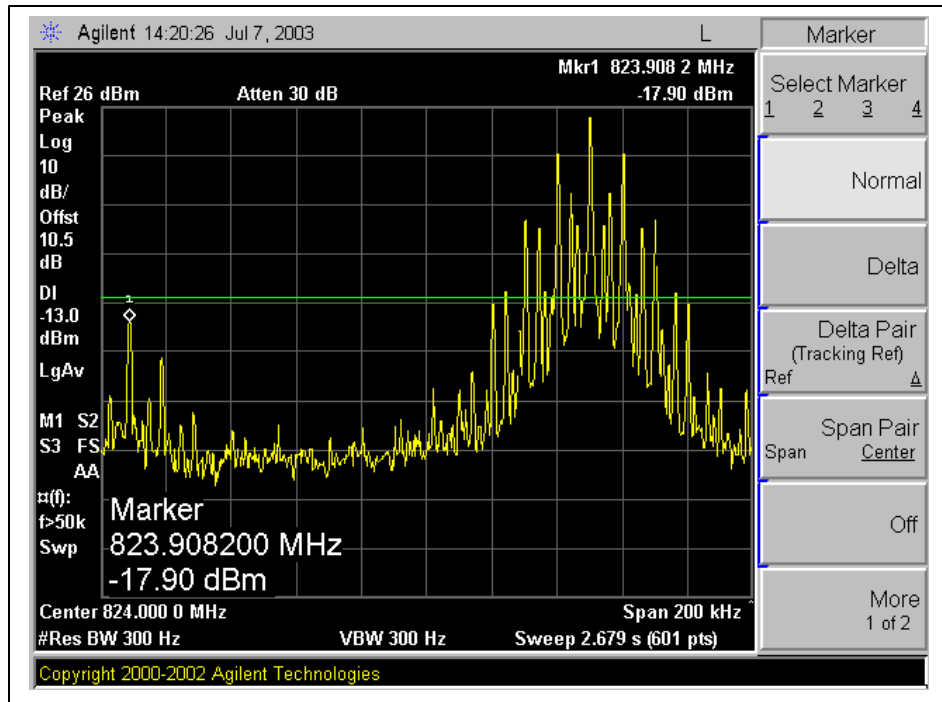

Low Band Edge- Ch 335-835MHz-SAT+ST (Channel Block B 835.02 – 844.98MHz)

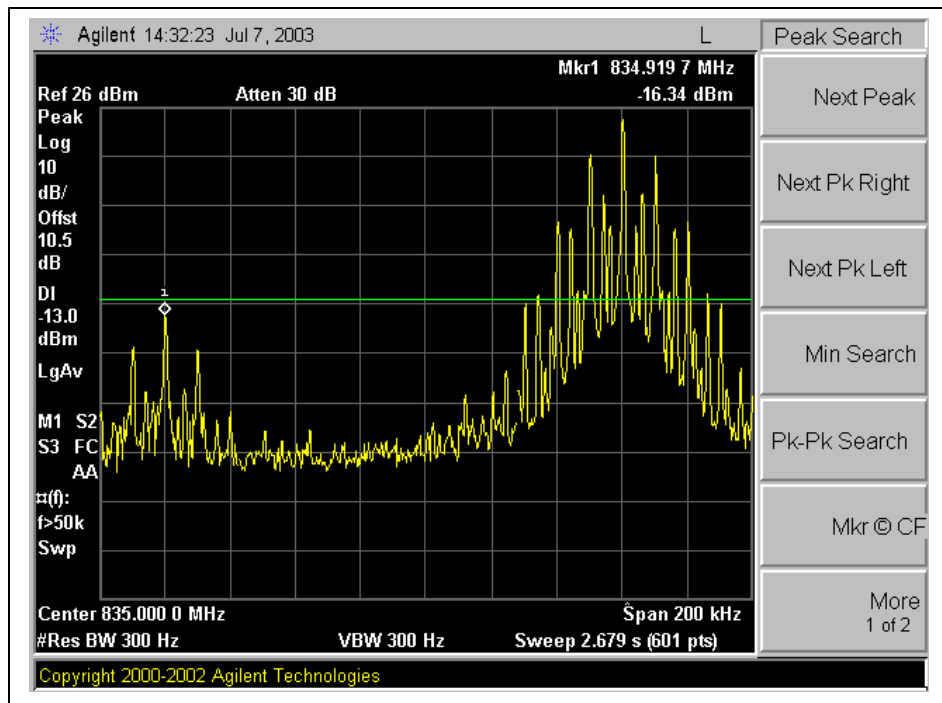

Low Band Edge-Ch 668-845MHz-SAT+ST (Channel Block A 845.01 – 846.48MHz)

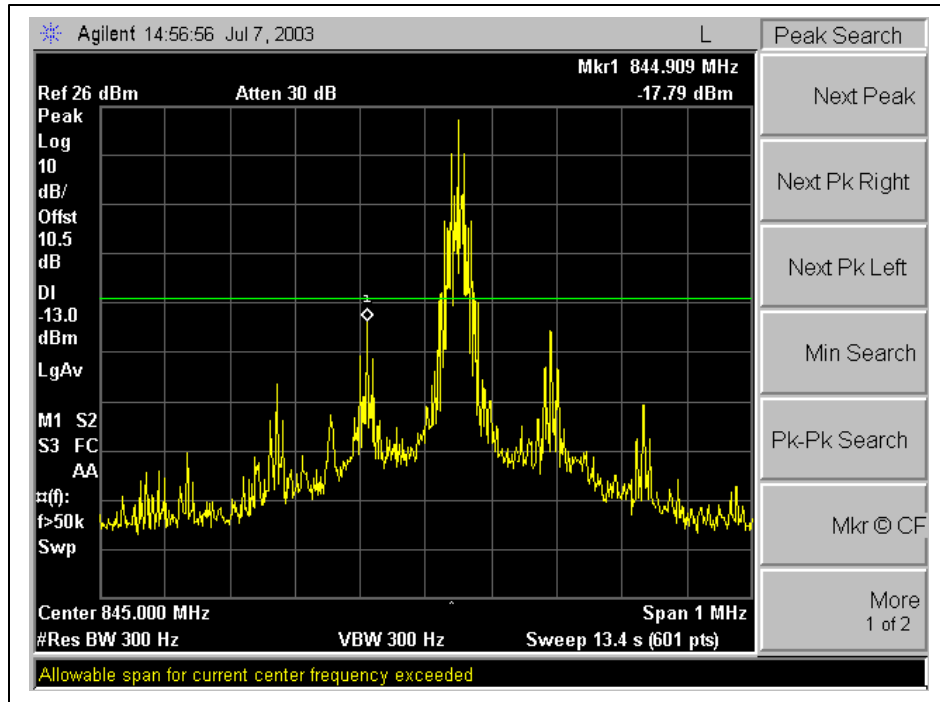

Low Band Edge-Ch 718-846.5MHz-SAT+ST (Channel Block B 846.51 - 848.97MHz)

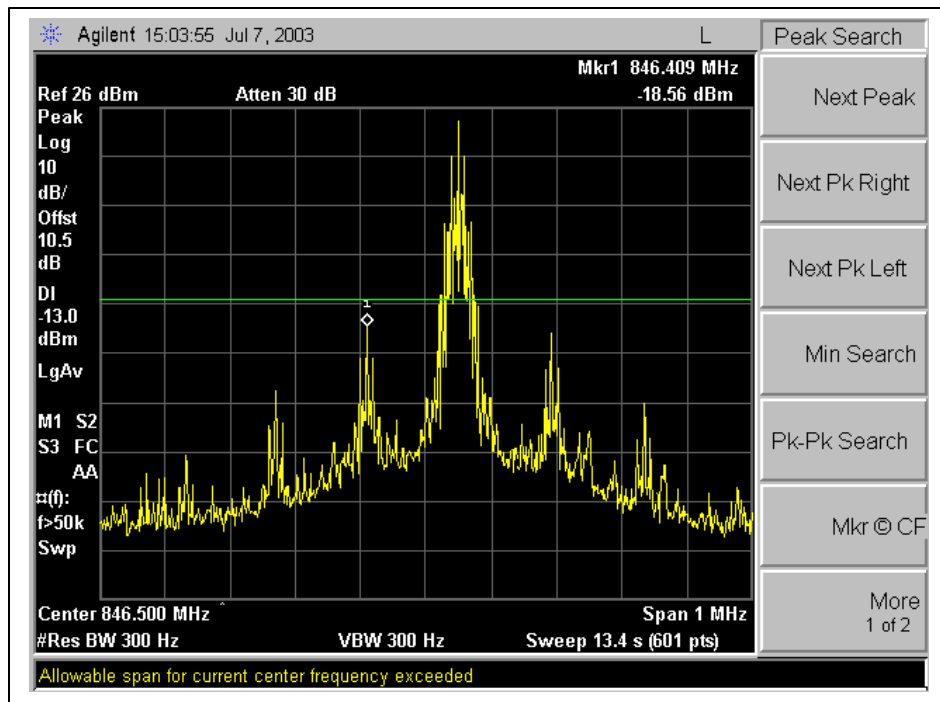

High Band Edge-Ch 332-835MHz-SAT+ST (Channel Block A 824.04 – 834.99MHz)

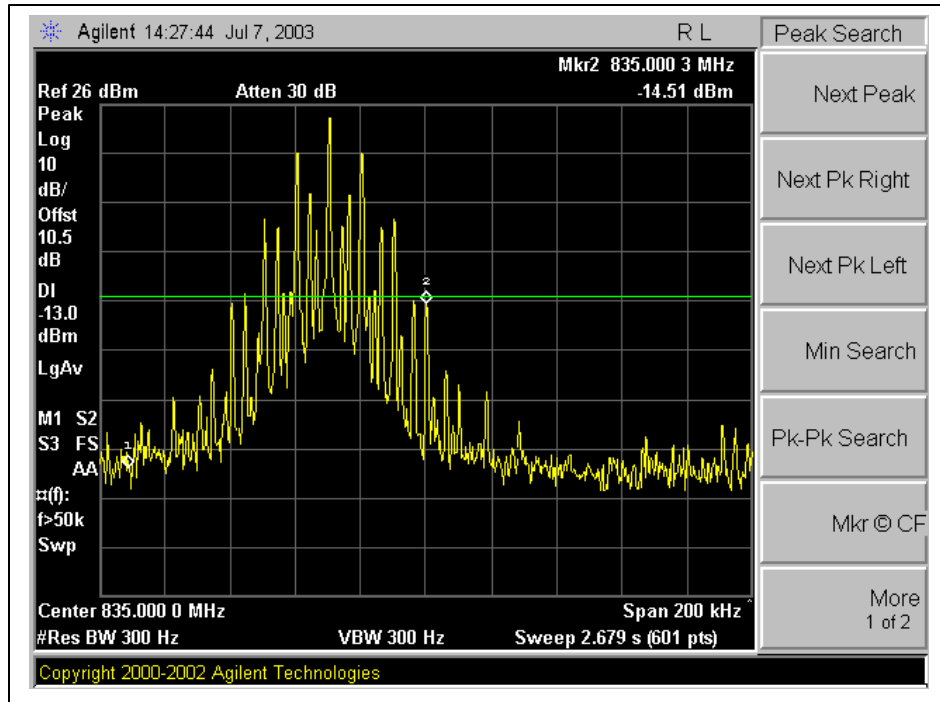

High Band Edge-Ch 665-845MHz-SAT+ST (Channel Block B 835.02 – 844.98MHz)

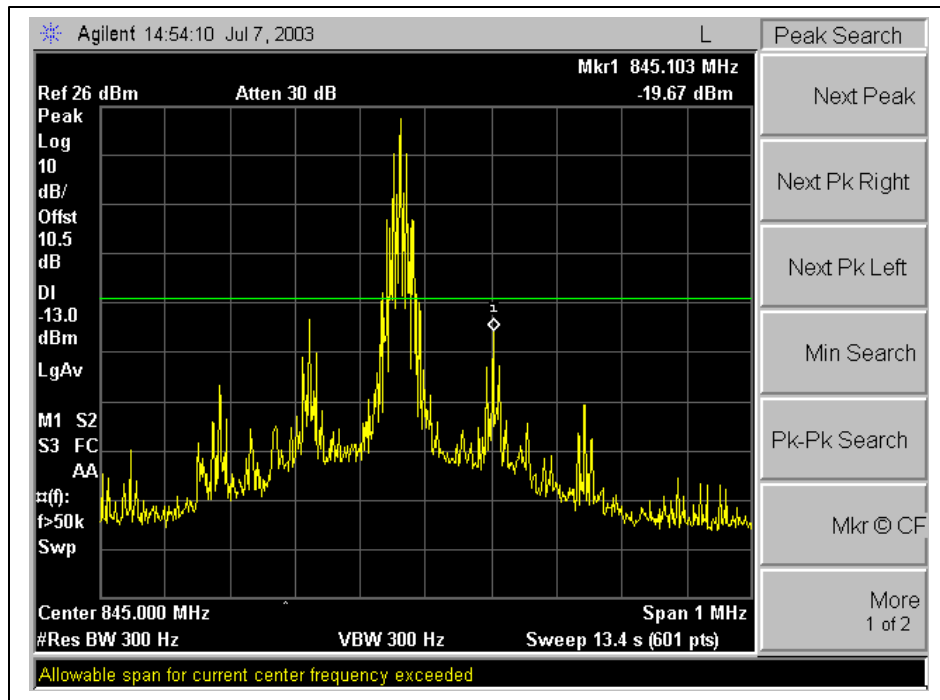

High Band Edge-Ch 715-846.5MHz-SAT+ST (Channel Block A 845.01 – 846.48MHz)

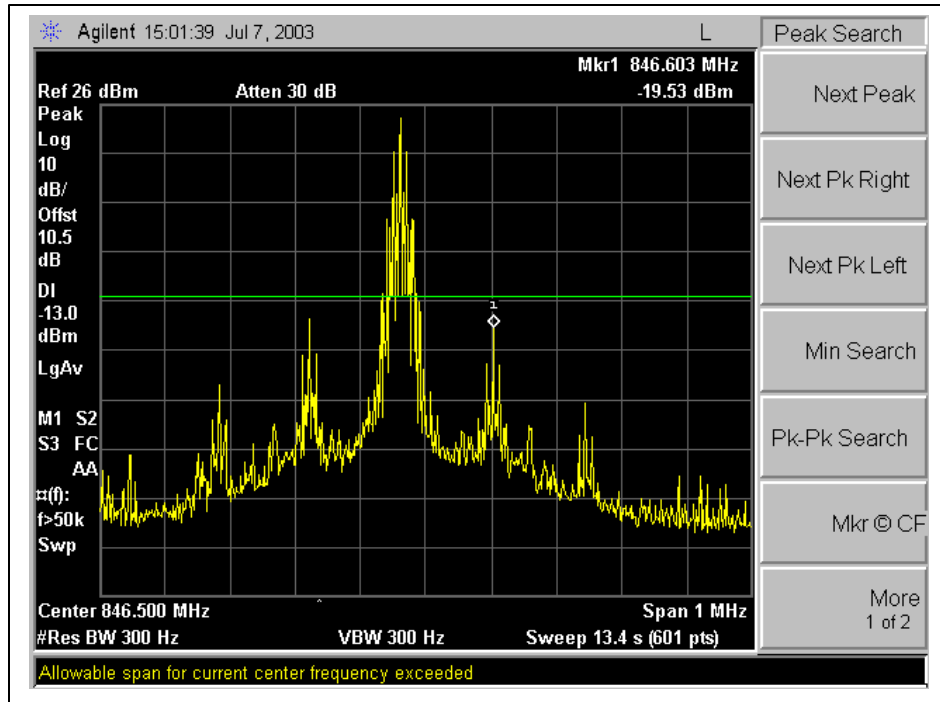

High Band Edge- Low Ch 799-849MHz-SAT+ST (Channel Block B 846.51 – 848.97MHz)

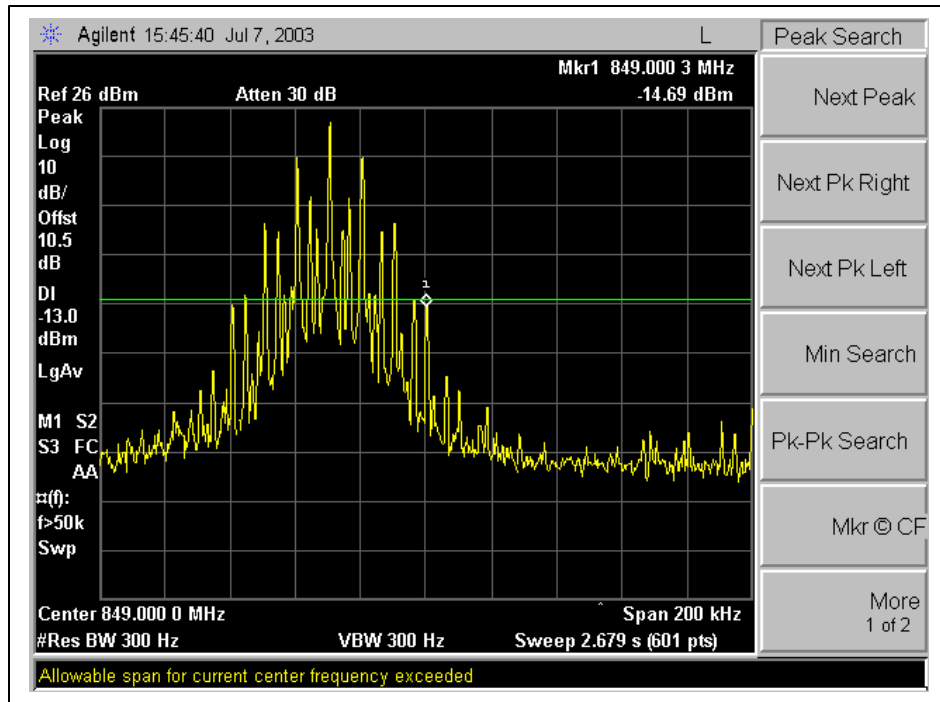

Out-Of-Band Emissions-Low Channel

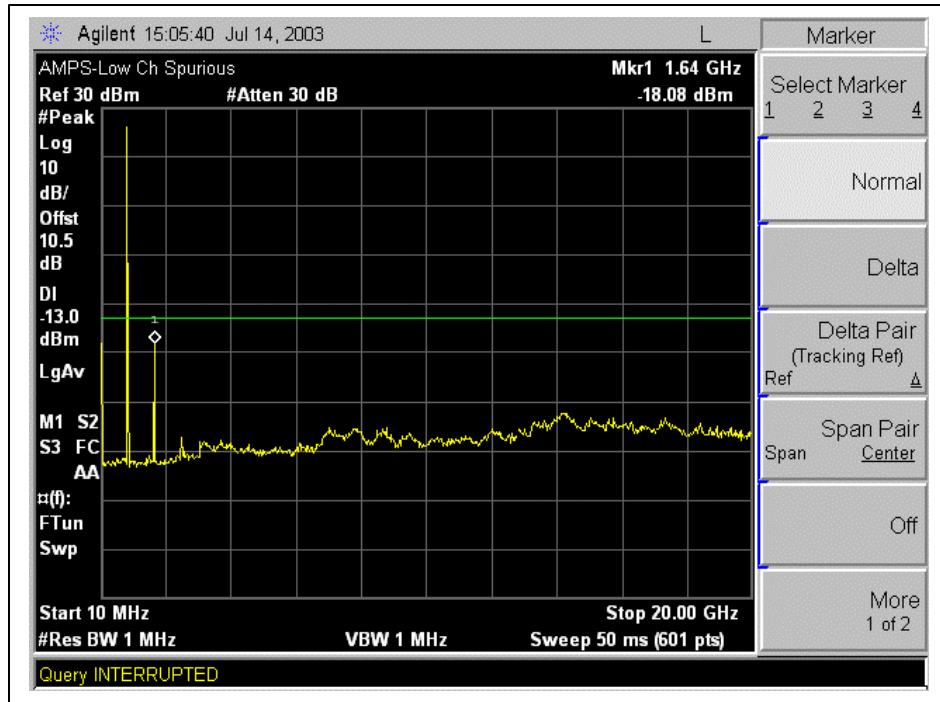

Out-Of-Band Emissions-Mid Channel

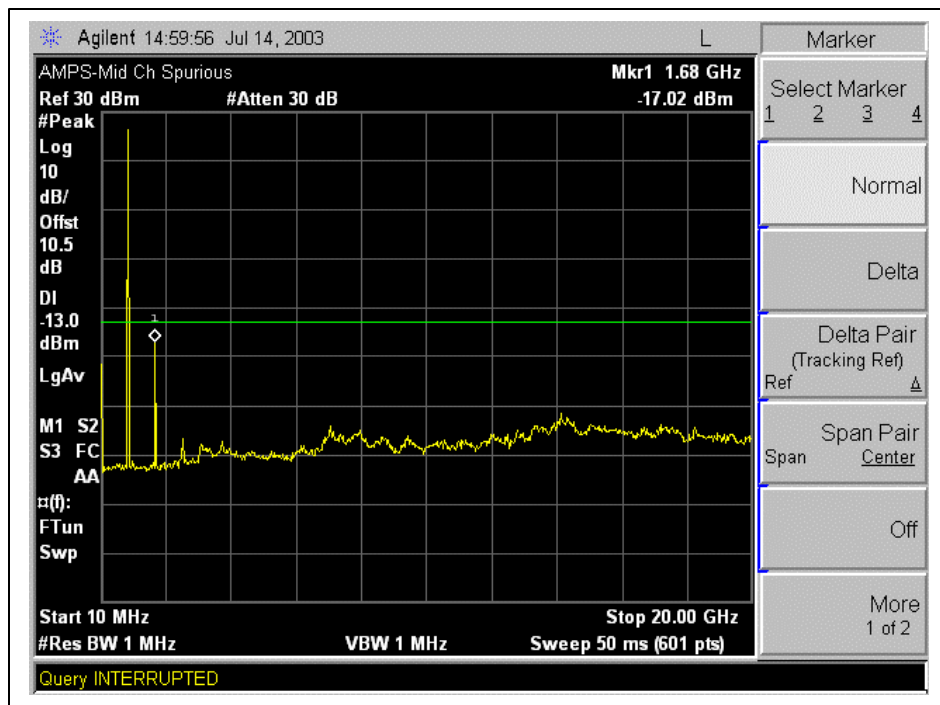

Out-Of-Band Emissions-High Channel

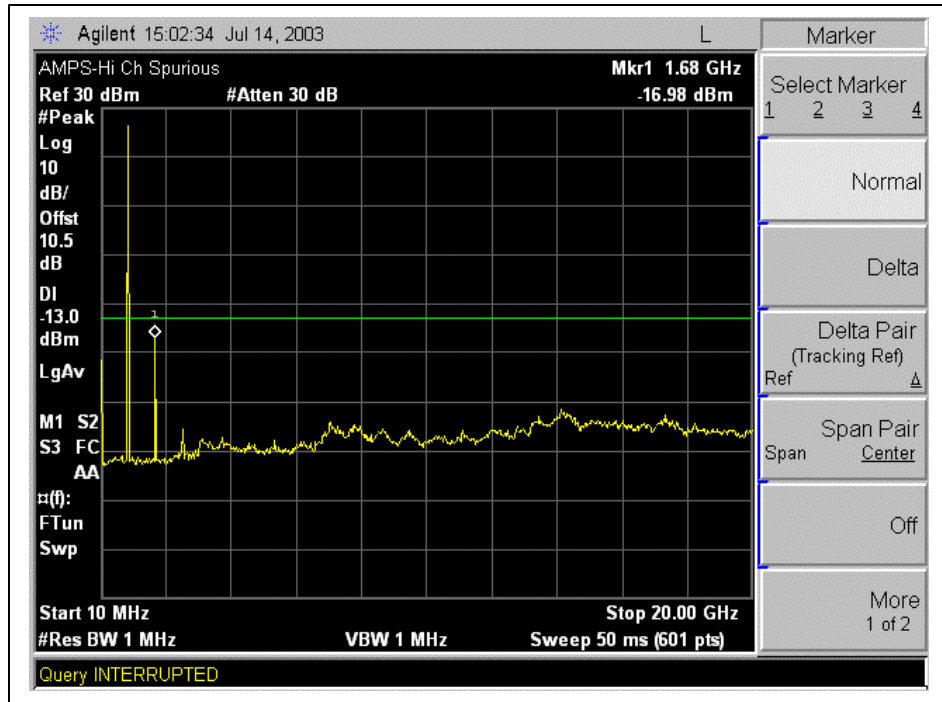

Mobile Emissions in Base Frequency Range

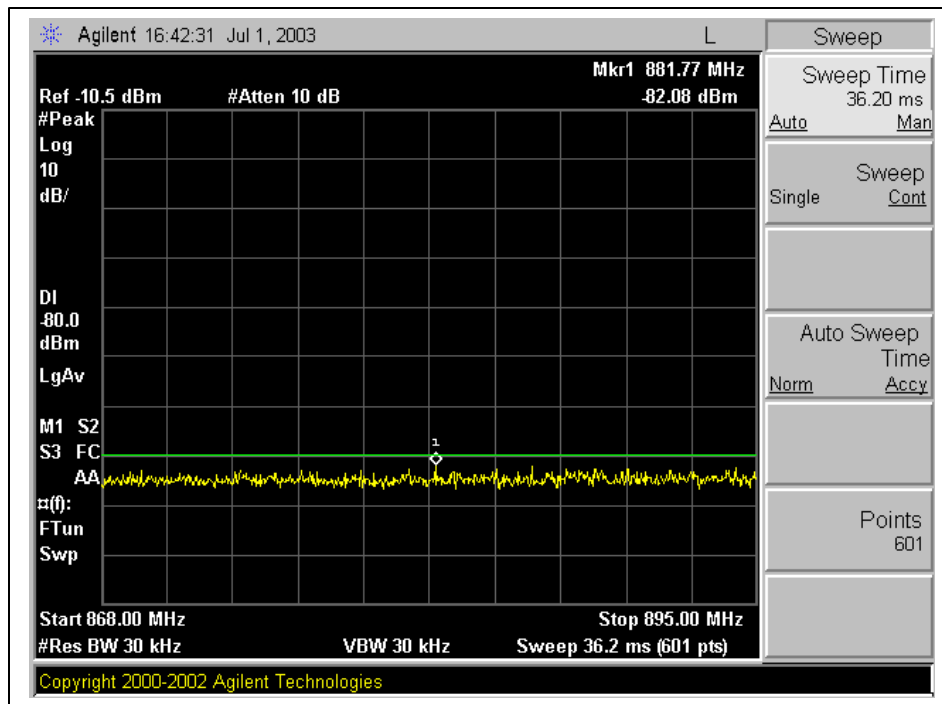

CDMA Modulation: Low / Mid / High, Band Edge, Out-Of-Band Emissions

Low Band Edge-Low Ch 1013-824.7MHz (Channel Block A 824.04 – 834.99MHz)

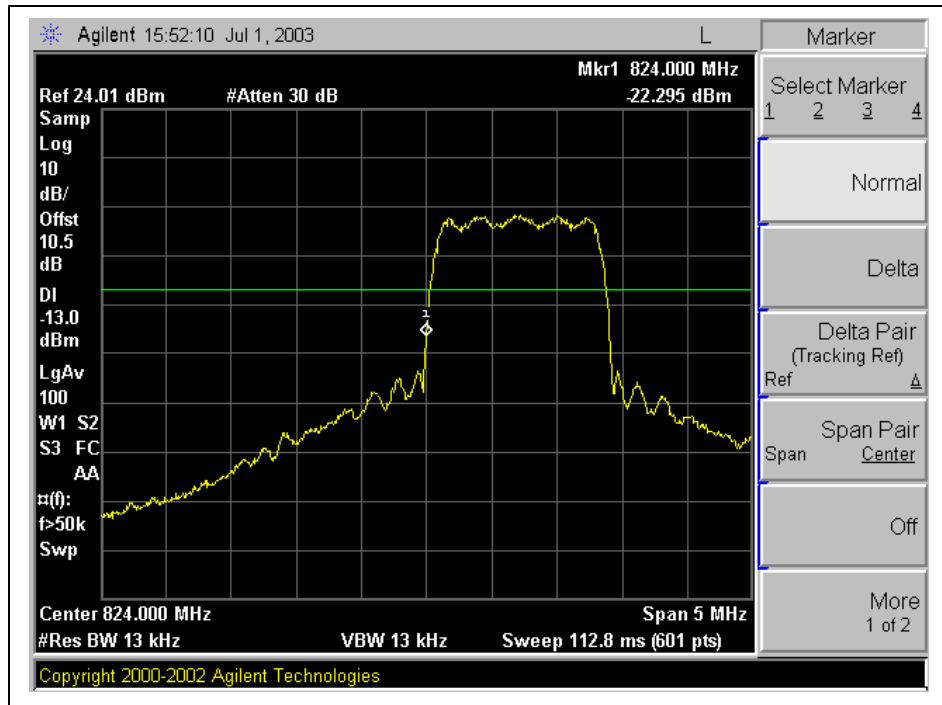

Low Band Edge- Ch 357 (Channel Block B 835.02 – 844.98MHz)

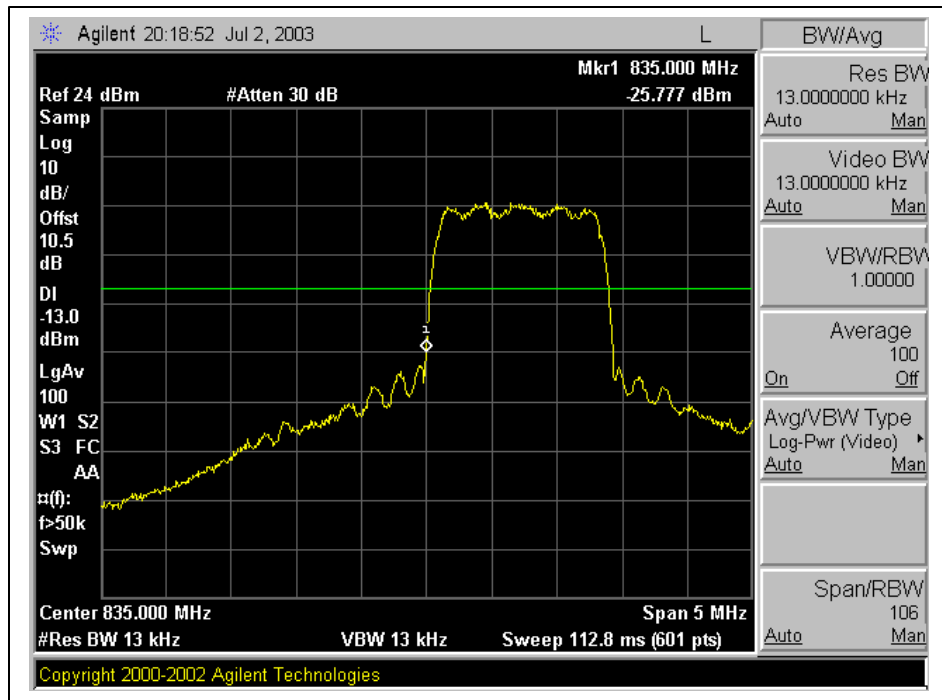

Low Band Edge- Ch 690 (Channel Block A 845.01 – 846.48MHz)

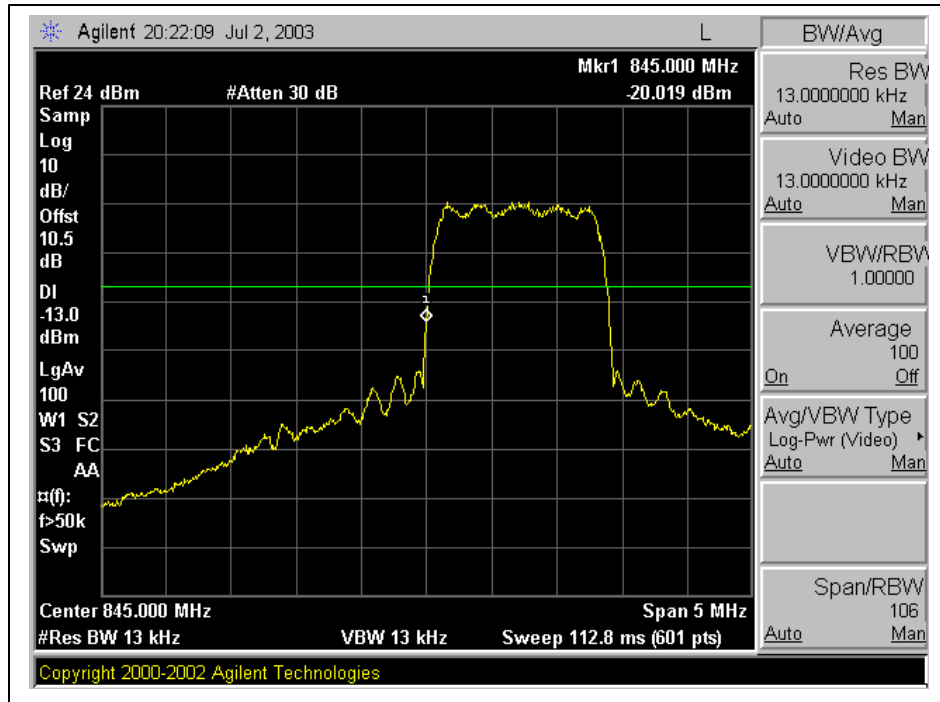

Low Band Edge- Ch 740 (Channel Block B 846.51 - 848.97MHz)

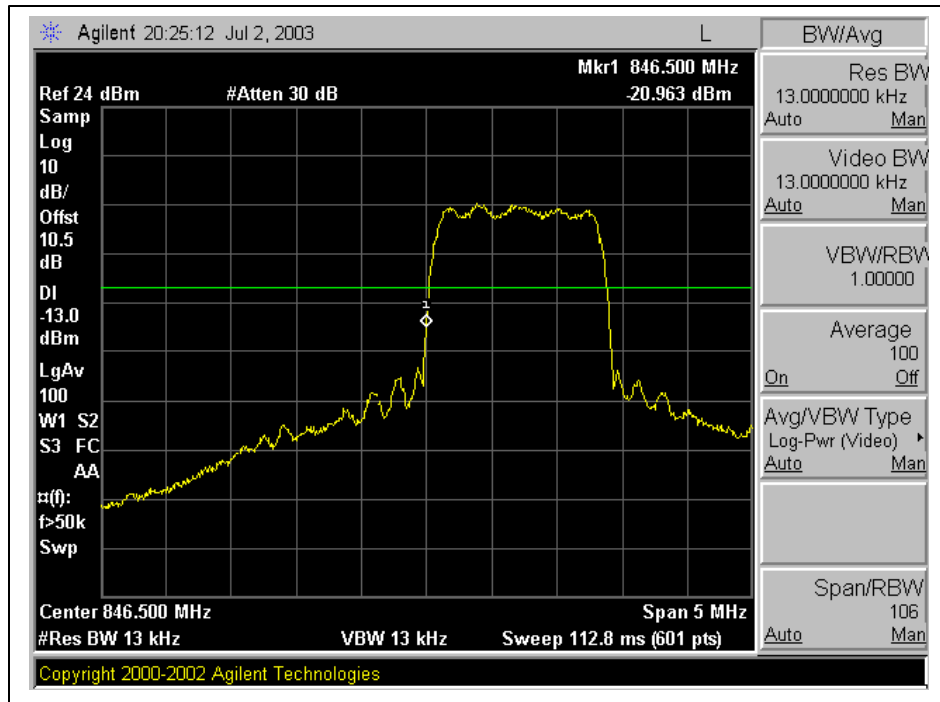

High Band Edge- Ch 310 (Channel Block A 824.04 – 834.99MHz)

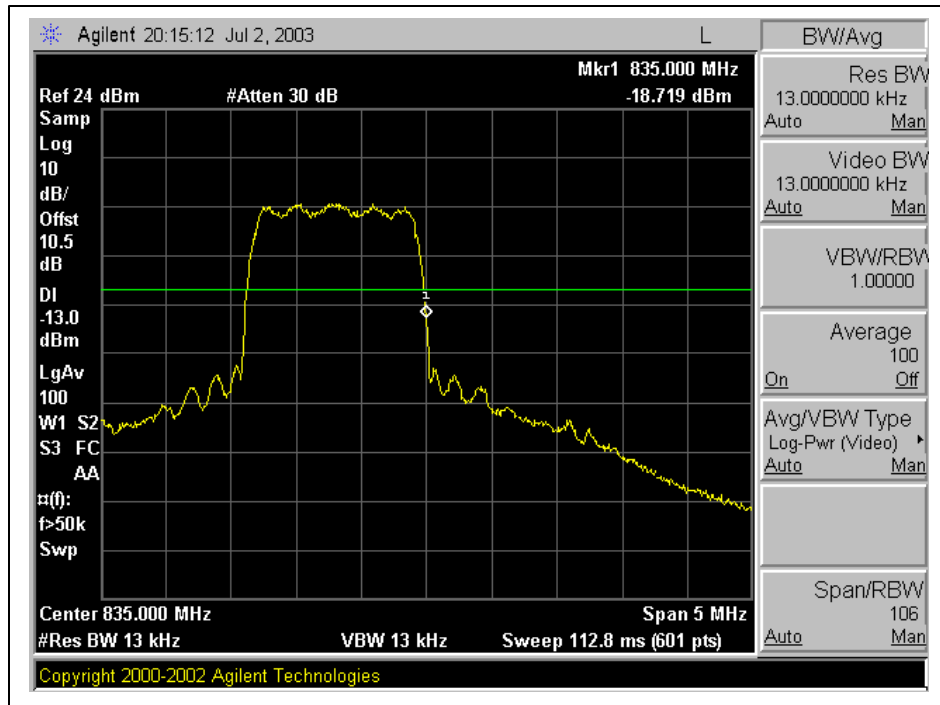

High Band Edge- Ch 643 (Channel Block B 835.02 – 844.98MHz)

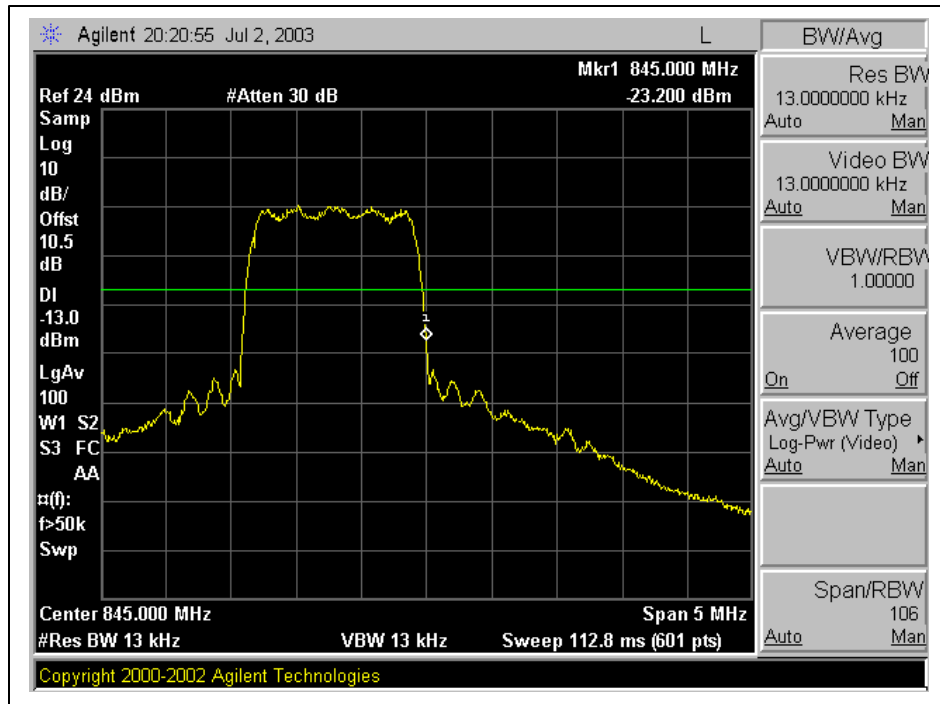

High Band Edge- Ch 693 (Channel Block A 845.01 – 846.48MHz)

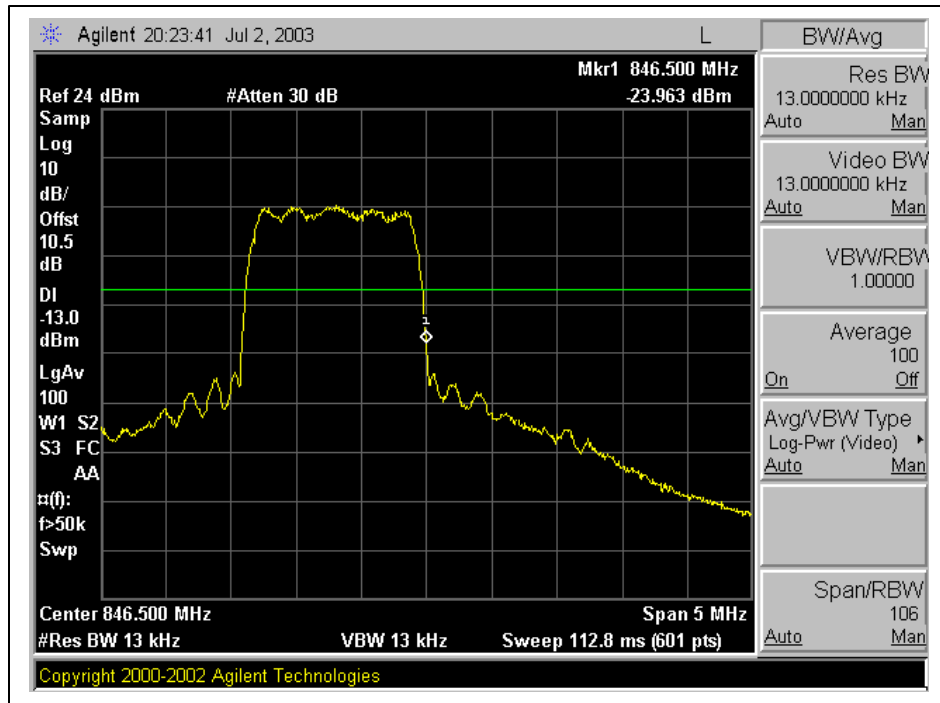

High Band Edge- Ch 777-848.31MHz (Channel Block B 846.51 – 848.97MHz)

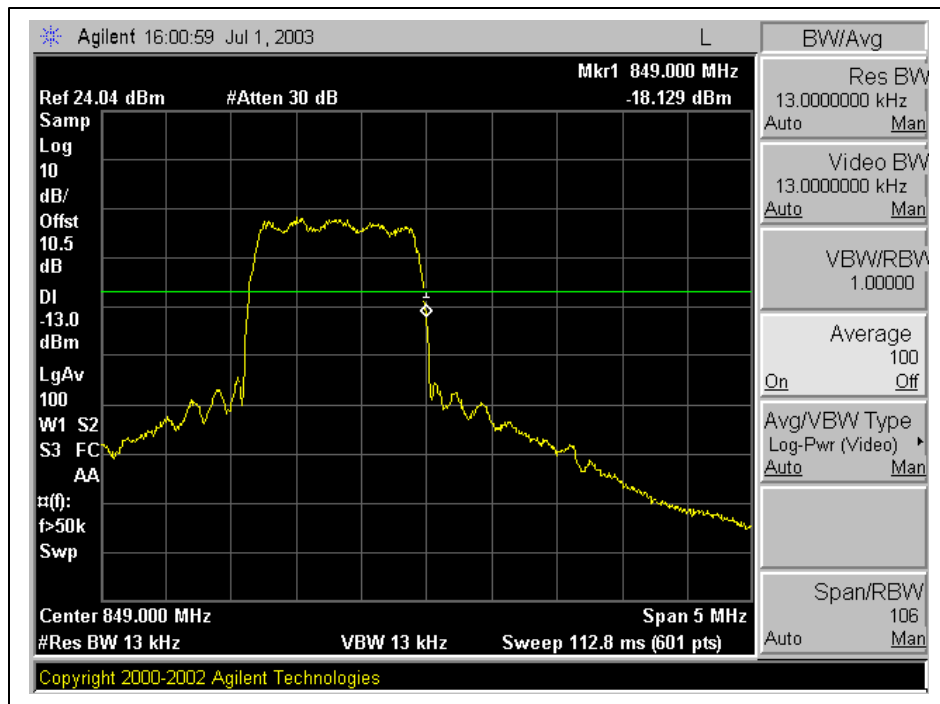

Out-Of-Band Emissions-Low Channel

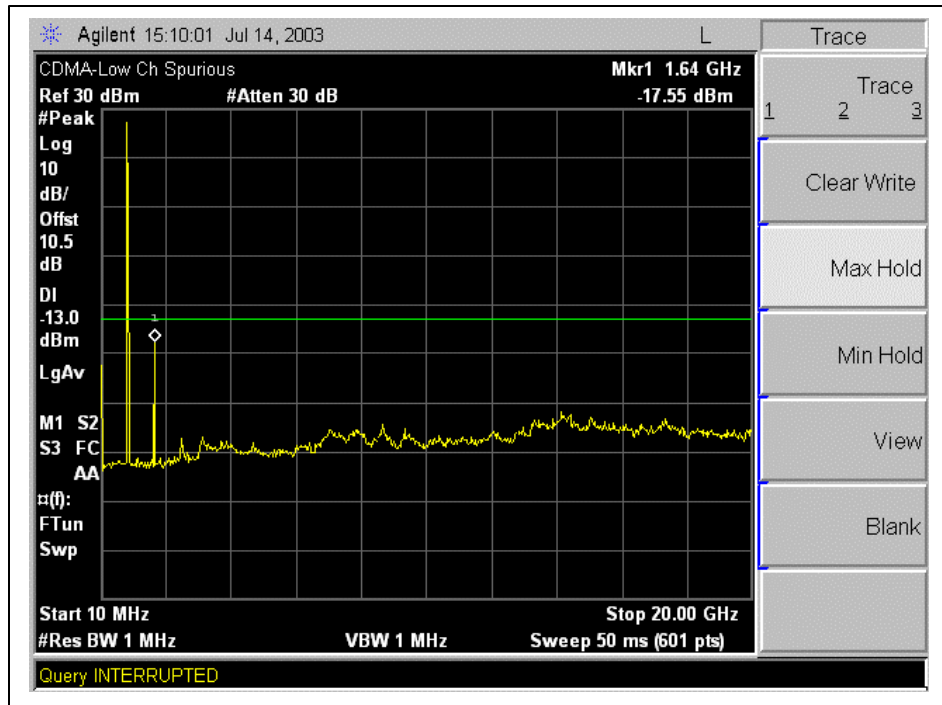

Out-Of-Band Emissions-Mid Channel

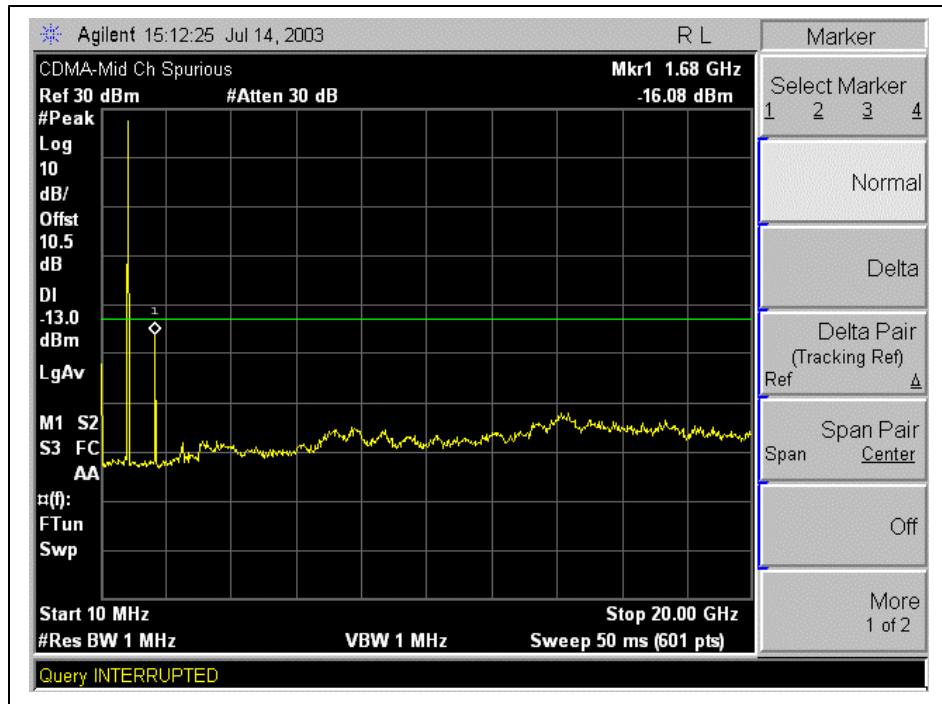

Out-Of-Band Emissions-High Channel

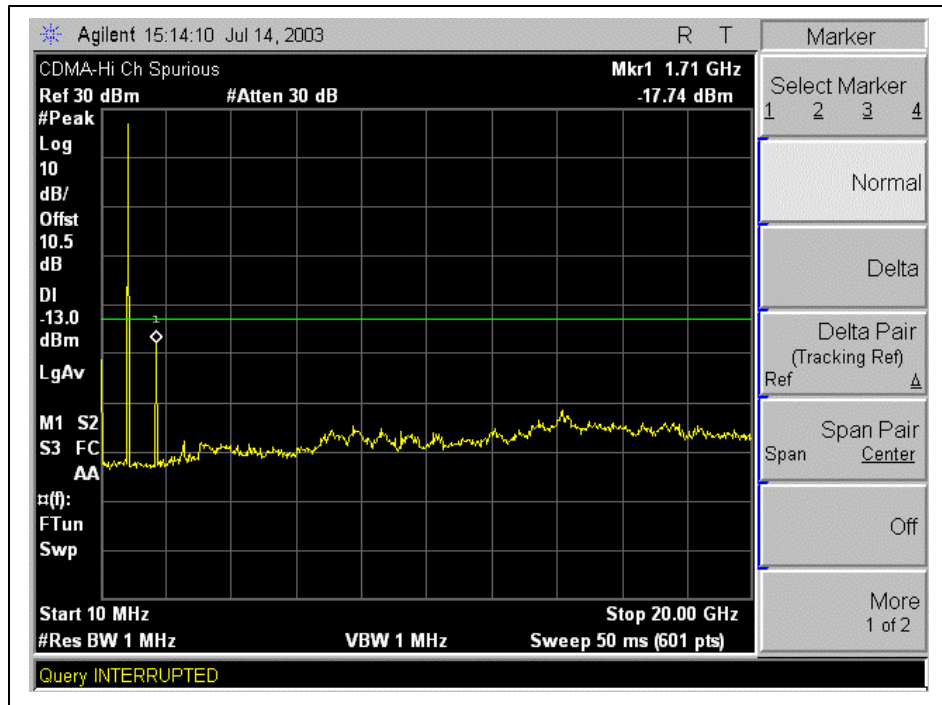

Mobile Emissions in Base Frequency Range

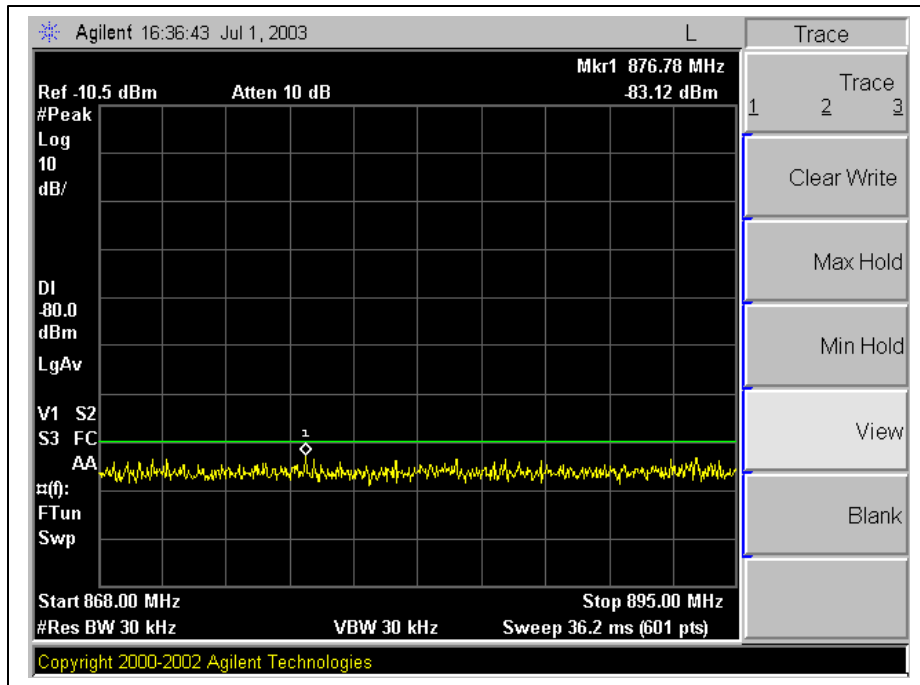

7.5. SECTION 2.1053: FIELD STRENGTH OF SPURIOUS RADIATION

INSTRUMENTS LIST

EQUIPMENT	MANUFACTURE	MODEL NO.	SERIAL NO.	CAL. DUE DATE
Modulation Analyzer	HP	8901b	3438A05272	6/23/04
PSA Analyzer	Agilent	E446A	US42070220	1/13/04
Audio Signal Generator	HP	3325A	2652A24749	5/8/04
10dB Attenuator	Agilent	8493C	59028	N/A
Power Splitter	Agilent	11667B	53331	N/A
DC Power Supply	Kenwood	PA36-3A	7060074	N/A
Bilog Antenna	A.R.A.	LPB 2520/A	1185	3/6/04
Tune Dipole	ETS	DB-4	1629	5/14/04
Tx Horn Antenna	EMCO	3115	6739	2/4/2004
Rx Horn Antenna	EMCO	3115	6717	2/4/2004
Amplifier	MITEQ	NSP2600-SP	924342	4/25/2004
HPF	MICROLAB	FH-1800H	N/A	N/A
HPF	MICROLAB	FH-2400H	N/A	N/A

Detector Function Setting of Test Receiver

Frequency Range (MHz)	Detector Function	Resolution Bandwidth	Video Bandwidth
Above 1000	<input checked="" type="checkbox"/> Peak <input type="checkbox"/> Average	<input checked="" type="checkbox"/> 1 MHz <input type="checkbox"/> 1 MHz	<input checked="" type="checkbox"/> 1 MHz <input type="checkbox"/> 10 Hz

TEST SETUP

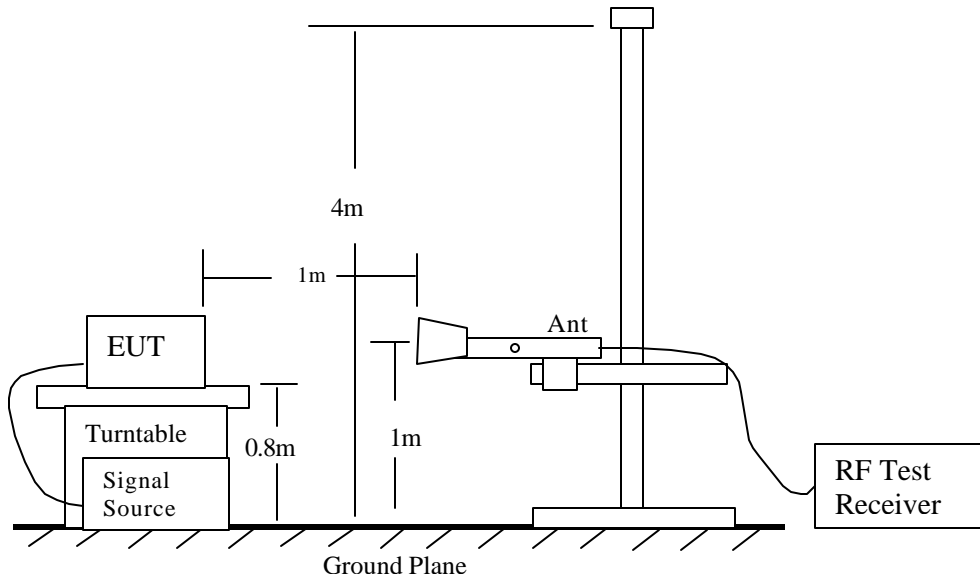

Radiated Emission Measurement

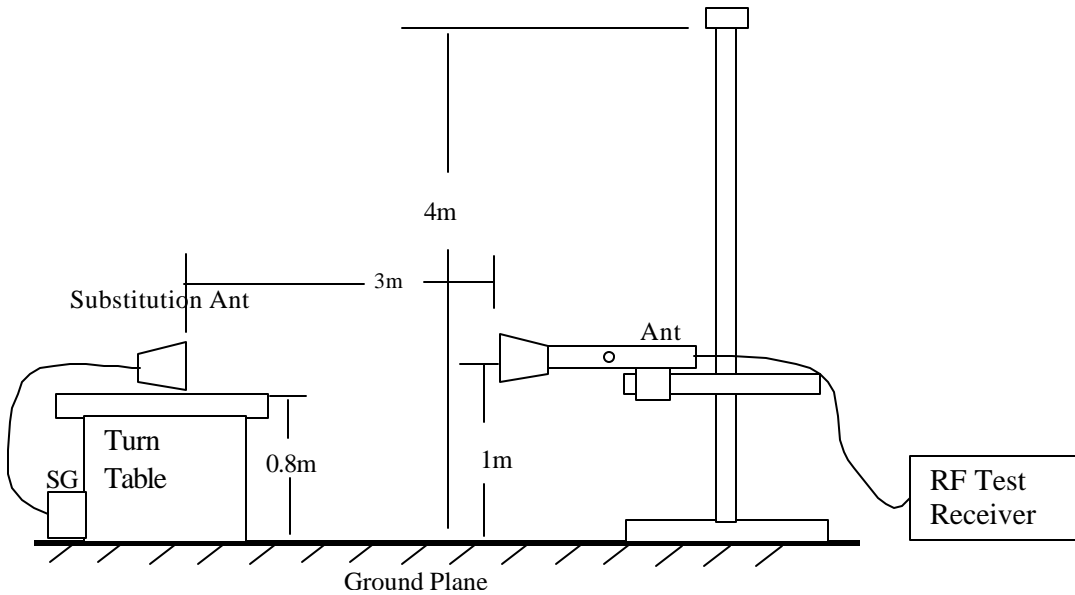

Radiated Emission - Substitution Method set-up

TEST PROCEDURE

- 1). On a test site, the EUT shall be placed on a turntable, and in the position closest to the normal use as declared by the user.
- 2). The test antenna shall be oriented initially for vertical polarization located 1m from the EUT to correspond to the frequency of the transmitter.
- 3). The output of the test antenna shall be connected to the measuring receiver and either a peak or average detector was used for the measurement as indicated on the report. The detector selection is based on how close the emission level was approaching the limit.
- 4). The transmitter shall be switched on, if possible, without the modulation and the measurement receiver shall be tuned to the frequency of the transmitter under test.
- 5). The test antenna shall be raised and lowered through the specified range of height until a maximum signal level is detected by the measuring receiver.
- 6). The transmitter shall than be rotated through 360° in the horizontal plane, until the maximum signal level is detected by the measuring receiver.
- 7). The test antenna shall be raised and lowered again through the specified range of height until a maximum signal level is detected by the measuring receiver.
- 8). The maximum signal level detected by the measuring receiver shall be noted.
- 9). The transmitter shall be replaced by a substitution antenna.
- 10). The substitution antenna shall be oriented for vertical polarization.
- 11). The substitution antenna shall be connected to a calibrated signal generator.
- 12). If necessary, the input attenuator setting of the measuring receiver shall be adjusted in order to increase the sensitivity of the measuring receiver.
- 13). The test antenna shall be raised and lowered through the specified range of the height to ensure that the maximum signal is received.
- 14). The input signal to the substitution antenna shall be adjusted to the level that produces a level detected by the measuring receiver, that is equal to the level noted while the transmitter radiated power was measured, corrected for the change of input attenuation setting of the measuring receiver.
- 15). The input level to the substitution antenna shall be recorded as power level in dBm, corrected for any change of input attenuator setting of the measuring receiver.
- 16). The measurement shall be repeated with the test antenna and the substitution antenna oriented for horizontal polarization.
- 17). The measure of the effective radiated power is the larger of the two levels recorded, at the input to the substitution antenna, corrected for the gain of the substitution antenna if necessary.

MEASUREMENT RESULT

No non-compliance noted, as shown below

AMPS Harmonics & Spurious Emissions: Low, Mid, & High Channels:

f GHz	SA reading (dBuV)	SG reading (dBm)	CL (dB)	Gain (dBi)	Gain (dBd)	ERP (dBm)	Limit (dBm)	Margin (dB)	Notes
Low Channel:									
1.648	95.2	-20.8	1.2	7.3	5.2	-16.9	-13.0	-3.9	V
2.472	73.6	-39.5	1.6	8.4	6.3	-34.8	-13.0	-21.8	V
3.296	59.6	-50.9	1.9	9.2	7.0	-45.8	-13.0	-32.8	V
4.120	55.1	-53.4	2.4	9.8	7.7	-48.1	-13.0	-35.1	V
4.944	52.3	-56.5	2.7	10.9	8.8	-50.4	-13.0	-37.4	V, Noise Floor
1.648	85.0	-31.0	1.2	7.3	5.2	-27.0	-13.0	-14.0	H
2.472	76.9	-36.7	1.6	8.4	6.3	-32.0	-13.0	-19.0	H
3.296	58.7	-52.0	1.9	9.2	7.0	-46.9	-13.0	-33.9	H
4.120	53.6	-55.0	2.4	9.8	7.7	-49.7	-13.0	-36.7	H
4.944	52.8	-56.0	2.7	10.9	8.8	-50.0	-13.0	-37.0	H,Noise Floor
Mid Channel:									
1.673	89.4	-26.6	1.2	7.4	5.2	-22.6	-13.0	-9.6	V
2.509	70.2	-41.7	1.6	8.4	6.3	-37.1	-13.0	-24.1	V
3.346	64.66	-45.7	2.0	9.2	7.1	-40.6	-13.0	-27.6	V
4.182	51.1	-57.4	2.4	9.9	7.8	-52.1	-13.0	-39.1	V
5.019	52.0	-56.9	2.7	11.0	8.9	-50.7	-13.0	-37.7	V, Noise Floor
1.673	85.0	-30.9	1.2	7.4	5.2	-26.9	-13.0	-13.9	H
2.509	72.7	-43.3	1.6	8.4	6.3	-38.6	-13.0	-25.6	H
3.346	62.1	-48.5	2.0	9.2	7.1	-43.4	-13.0	-30.4	H
4.182	51.6	-57.0	2.4	9.9	7.8	-51.7	-13.0	-38.7	H
5.019	52.3	-56.5	2.7	11.0	8.9	-50.4	-13.0	-37.4	H,Noise Floor
High Channel:									
1.697	90.2	-25.8	1.2	7.4	5.2	-21.8	-13.0	-8.8	V
2.546	71.7	-41.1	1.6	8.5	6.3	-36.4	-13.0	-23.4	V
3.395	62.2	-48.0	2.0	9.2	7.1	-42.9	-13.0	-29.9	V
4.244	55.6	-53.0	2.4	10.0	7.8	-47.6	-13.0	-34.6	V
5.093	51.9	-56.9	2.8	11.1	8.9	-50.8	-13.0	-37.8	V, Noise Floor
1.697	85.1	-30.8	1.2	7.4	5.2	-26.8	-13.0	-13.8	H
2.546	72.0	-41.3	1.6	8.5	6.3	-36.6	-13.0	-23.6	H
3.395	61.6	-48.8	2.0	9.2	7.1	-43.7	-13.0	-30.7	H
4.244	54.4	-54.2	2.4	10.0	7.8	-48.7	-13.0	-35.7	H
5.093	52.1	-56.7	2.8	11.1	8.9	-50.6	-13.0	-37.6	H,Noise Floor

CDMA Harmonics & Spurious Emissions: Low, Mid, & High Channels:

f GHz	SA reading (dBuV)	SG reading (dBm)	CL (dB)	Gain (dBi)	Gain (dBd)	EIRP (dBm)	Limit (dBm)	Margin (dB)	Notes
Low Channel:									
1.648	95.8	-20.2	1.2	7.3	5.2	-16.3	-13.0	-3.3	V
2.472	76.6	-36.5	1.6	8.4	6.3	-31.8	-13.0	-18.8	V
3.296	60.7	-49.8	1.9	9.2	7.0	-44.7	-13.0	-31.7	V
4.120	51.9	-56.6	2.4	9.8	7.7	-51.3	-13.0	-38.3	V, Noise Floor
1.648	89.8	-26.2	1.2	7.3	5.2	-22.3	-13.0	-9.3	H
2.472	77.1	-36.5	1.6	8.4	6.3	-31.8	-13.0	-18.8	H
3.296	60.1	-50.6	1.9	9.2	7.0	-45.6	-13.0	-32.6	H
4.120	52.3	-56.3	2.4	9.8	7.7	-51.0	-13.0	-38.0	H,Noise Floor
Mid Channel:									
1.673	94.1	-21.9	1.2	7.4	5.2	-17.9	-13.0	-4.9	V
2.509	74.0	-38.0	1.6	8.4	6.3	-33.3	-13.0	-20.3	V
3.346	63.0	-47.4	2.0	9.2	7.1	-42.3	-13.0	-29.3	V
4.182	55.5	-53.1	2.4	9.9	7.8	-47.7	-13.0	-34.7	V, Noise Floor
1.673	85.1	-30.8	1.2	7.4	5.2	-26.9	-13.0	-13.9	H
2.509	74.9	-41.1	1.6	8.4	6.3	-36.4	-13.0	-23.4	H
3.346	60.8	-49.8	2.0	9.2	7.1	-44.7	-13.0	-31.7	H
4.182	53.3	-55.3	2.4	9.9	7.8	-49.9	-13.0	-36.9	H,Noise Floor
High Channel									
1.697	93.2	-22.7	1.2	7.4	5.2	-18.7	-13.0	-5.7	V
2.546	72.3	-40.5	1.6	8.5	6.3	-35.8	-13.0	-22.8	V
3.395	60.8	-49.5	2.0	9.2	7.1	-44.4	-13.0	-31.4	V
4.241	51.4	-57.2	2.4	10.0	7.8	-51.8	-13.0	-38.8	V, Noise Floor
1.697	83.4	-32.5	1.2	7.4	5.2	-28.5	-13.0	-15.5	H
2.546	69.7	-43.6	1.6	8.5	6.3	-38.9	-13.0	-25.9	H
3.395	60.3	-50.1	2.0	9.2	7.1	-45.0	-13.0	-32.0	H
4.241	51.4	-57.7	2.4	10.0	7.8	-52.3	-13.0	-39.3	H,Noise Floor

7.6. SECTION 2.1055: FREQUENCY STABILITY

INSTRUMENTS LIST

EQUIPMENT	MANUFACTURE	MODEL NO.	SERIAL NO.	CAL. DUE DATE
Modulation Analyzer	HP	8901b	3438A05272	6/23/04
PSA Analyzer	Agilent	E446A	US42070220	1/13/04
Audio Signal Generator	HP	3325A	2652A24749	5/8/04
Environmental Chamber	Thermotron	SE 600-10-10	2980	4/23/04
Mobile Test Set	Agilent	E8285A	GB4131011	9/11/04
10dB Attenuator	Agilent	8493C	59028	N/A
Power Splitter	Agilent	11667B	53331	N/A
DC Power Supply	Kenwood	PA36-3A	7060074	N/A

Detector Function Setting of Test Receiver

Frequency Range (MHz)	Detector Function	Resolution Bandwidth	Video Bandwidth
Above 1000	Peak	300 Hz	300 Hz

TEST SETUP

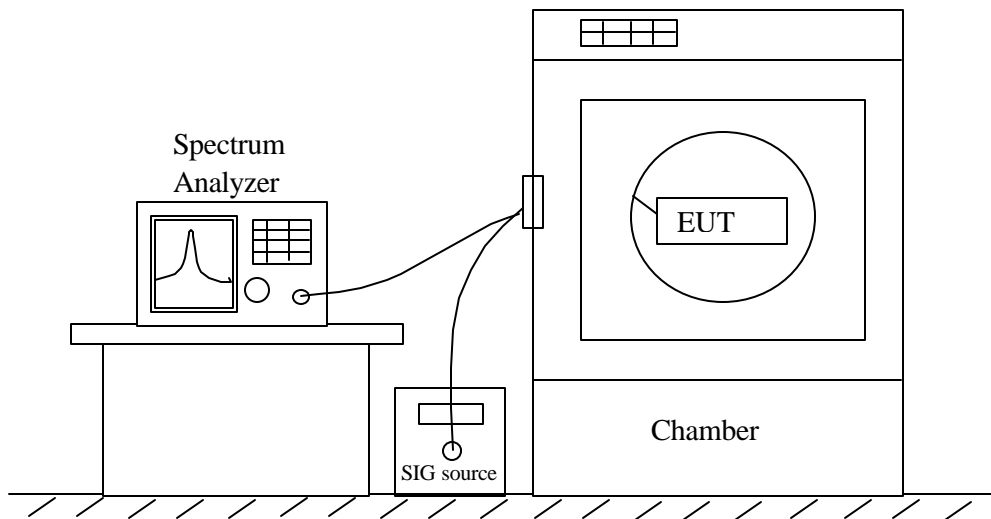

Frequency Stability Setup

TEST PROCEDURE

- **Frequency stability versus environmental temperature**

- 1). Setup the configuration per figure 6 for frequencies measurement inside the environmental chamber. Set the temperature of the chamber to 25°C. Set SA Resolution Bandwidth low enough to obtain the desired frequency resolution and measure the EUT 25°C operating frequency as reference frequency.
- 2). Turn EUT off and set Chamber temperature to -30°C.
- 3). Allow sufficient time (approximately 20 to 30 minus after chamber reach the assigned temperature) for EUT to stabilize. Turn on EUT and measure the EUT operating frequency. Turn off EUT after the measurement.
- 4). Repeat step 3 with a 10°C increased per stage until the highest temperature of +50°C reached, record all measured frequencies on each temperature step.

- **Frequency stability versus AC input voltage**

- 1). Setup the configuration per figure 6 and set chamber temperature to 25°C. Use a variable AC power supply to power the EUT and set AC output voltage to EUT nominal input AC voltage. Set SA Resolution Bandwidth low enough to obtain the desired frequency resolution and measure the EUT 25°C operating frequency as reference frequency.
- 2). Slowly reduce the EUT input voltage to specified extreme voltage variation ($\pm 15\%$) and record the maximum frequency change.

MEASUREMENT RESULT

No non-compliance noted, as shown below.



Reference Frequency: AMPS Mid Channel 836.490000MHz @ 25°C				
Limit: to stay ± 2.5 ppm = 2091.249 Hz				
Power Supply (Vdc)	Environment Temperature (°C)	Frequency Deviation Measured with Time Elapse		
		(MHz)	Delta (ppm)	Limit (ppm)
3.70	50	836.50042	-0.754	± 2.5
3.70	40	836.50029	-0.599	± 2.5
3.70	30	836.49995	-0.182	± 2.5
3.70	25	836.49979	0	± 2.5
3.70	20	836.49973	0.079	± 2.5
3.70	10	836.49973	0.077	± 2.5
3.70	0	836.49975	0.055	± 2.5
3.70	-10	836.49942	0.446	± 2.5
3.70	-20	836.49921	0.693	± 2.5
3.70	-30	836.49899	0.961	± 2.5
3.15 (end point)	25	836.49963	0.197	± 2.5
4.2	25	836.49975	0.055	± 2.5

Reference Frequency: CDMA Mid Channel 837.181560MHz @ 25°C				
Limit: to stay ± 2.5 ppm = 2092.954 Hz				
Power Supply (Vdc)	Environment Temperature (°C)	Frequency Deviation Measured with Time Elapse		
		(MHz)	Delta (ppm)	Limit (ppm)
3.70	50	837.18288	-1.574	± 2.5
3.70	40	837.18087	0.829	± 2.5
3.70	30	837.18123	0.400	± 2.5
3.70	25	837.18156	0	± 2.5
3.70	20	837.18195	-0.467	± 2.5
3.70	10	837.18197	-0.486	± 2.5
3.70	0	837.18235	-0.941	± 2.5
3.70	-10	837.18251	-1.132	± 2.5
3.70	-20	837.18054	1.221	± 2.5
3.70	-30	837.18138	0.211	± 2.5
3.15 (end point)	25	837.17975	2.16202	± 2.5
4.2	25	837.18091	0.78239	± 2.5

8. APENDIX

- 8.1. EXTERNAL & INTERNAL PHOTOS
- 8.2. SCHEMATICS
- 8.3. BLOCK DIAGRAM
- 8.4. USER MANUAL

END OF REPORT