



FCC CFR47 CERTIFICATION

PART 22H

TEST REPORT

FOR

800MHZ DUAL MODE AMPS/CDMA CELLULAR CAMERA PHONE

MODEL NUMBER: VC-5D

FCC ID: GKRVC-5D

REPORT NUMBER: 04I2555-1

ISSUE DATE: MARCH 30, 2004

Prepared for

**COMPAL ELECTRONICS, INC.
7F, NO. 500, JUIKUANG ROAD
NEIHU, TAIPEI TAIWAN ROC 114**

Prepared by

**COMPLIANCE CERTIFICATION SERVICES
561F MONTEREY ROAD, ROUTE 2
MORGAN HILL, CA 95037, USA
TEL: (408) 463-0885
FAX: (408) 463-0888**

TABLE OF CONTENT

1. TEST RESULT CERTIFICATION	3
2. EUT DESCRIPTION	4
3. TEST METHODOLOGY	4
4. TEST FACILITY	4
5. ACCREDITATION AND LISTING	4
6. MEASURING INSTRUMENT CALIBRATION	4
7. TEST SETUP, PROCEDURE AND RESULT	5
7.1. SECTION 2.1046: RF POWER OUTPUT	5
7.2. SECTION 2.1047: MODULATION CHARACTERISTICS	13
7.3. SECTION 2.1049: OCCUPIED BANDWIDTH	19
7.3.1. Un-modulated Signal	24
7.3.2. Voice	25
7.3.3. Signaling Tone (ST) + Supervisory Audio Tone (SAT)	28
7.3.4. Wide Band Data (WBD).....	29
7.3.5. Voice + Supervisory Audio Tone (SAT).....	30
7.3.6. DTMF + Supervisory Audio Tone (SAT)	31
7.4. SECTION 2.1051: SPURIOUS EMISSION AT ANTENNA TERMINAL	32
7.5. SECTION 2.1053: FIELD STRENGTH OF SPURIOUS RADIATION	43
7.6. SECTION 2.1055: FREQUENCY STABILITY	48
7.7. RADIATED EMISSION	52
7.8. POWERLINE CONDUCTED EMISSION	57
8. APENDIX	62
8.1. EXTERNAL & INTERNAL PHOTOS	62
8.2. SCHEMATICS	65
8.3. BLOCK DIAGRAM.....	65
8.4. USER MANUAL.....	65

1. TEST RESULT CERTIFICATION

COMPANY NAME: COMPAL ELECTRONICS INC.
8F, NO. 500, JUI-KUANG RD.
NEIHU, TAIPEI 114
TAIWAN

EUT DESCRIPTION: DUAL-MODE AMPS / CDMA CELLULAR PHONE

MODEL NUMBER: VC-5D

DATE TESTED: MARCH 17, 2004 – MARCH 19, 2004

TYPE OF EQUIPMENT	INTENTIONAL RADIATOR
MEASUREMENT PROCEDURE	ANSI 63.4 / 2001, TIA/EIA 603
PROCEDURE	CERTIFICATION
FCC RULE	CFR 47 PART 22 Subpart H

Compliance Certification Services, Inc. tested the above equipment for compliance with the requirement set forth in CFR 47, PART 22 Subpart H-Cellular Radiotelephone Service. The equipment in the configuration described in this report, shows the measured emission levels emanating from the equipment do not exceed the specified limit.

Note : This document reports conditions under which testing was conducted and results of tests performed. This document may not be altered or revised in any way unless done so by Compliance Certification Services and all revisions are duly noted in the revisions section. Any alteration of this document not carried out by Compliance Certification Services will constitute fraud and shall nullify the document.

Tested By:

Released For CCS By:

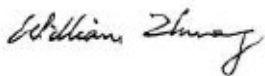

WILLIAM ZHUANG
EMC ENGINEER
COMPLIANCE CERTIFICATION SERVICES

THU CHAN
EMC SUPERVISOR
COMPLIANCE CERTIFICATION SERVICES

2. EUT DESCRIPTION

The 800MHz AMPS/CDMA Cellular Phone has an output power 24.9dBm / 309.03mW (AMPS, ERP) and 25.9dBm / 389.05mW (CDMA, ERP), with 1.38dBi antenna gain which is designed for the Cellular band transmitting of frequency range 824 – 849 MHz.

3. TEST METHODOLOGY

Both conducted and radiated testing were performed according to the procedures documented on chapter 13 of ANSI C63.4 and FCC CFR 47 2.1046, 2.1047, 2.1049, 2.1051, 2.1053, 2.1055 and 2.1057.

4. TEST FACILITY

The open area test sites and conducted measurement facilities used to collect the radiated data are located at 561F Monterey Road, Morgan Hill, California, USA. The sites are constructed in conformance with the requirements of ANSI C63.7, ANSI C63.4 and CISPR Publication 22.

5. ACCREDITATION AND LISTING

The test facilities used to perform radiated and conducted emissions tests are accredited by National Voluntary Laboratory Accreditation Program for the specific scope of accreditation under Lab Code: 200065-0 to perform Electromagnetic Interference tests according to FCC PART 15 AND CISPR 22 requirements. No part of this report may be used to claim or imply product endorsement by NVLAP or any agency of the US Government. In addition, the test facilities are listed with Federal Communications Commission (reference no: 31040/SIT (1300B3) and 31040/SIT (1300F2))

6. MEASURING INSTRUMENT CALIBRATION

The measuring equipment, which was utilized in performing the tests documented herein, has been calibrated in accordance with the manufacturer's recommendations for utilizing calibration equipment, which is traceable to recognized national standards.

7. TEST SETUP, PROCEDURE AND RESULT

7.1. SECTION 2.1046: RF POWER OUTPUT

INSTRUMENTS LIST

TEST EQUIPMENT LIST				
Name of Equipment	Manufacturer	Model No.	Serial No.	Due Date
Peak Power Meter	Agilent	E4416A	GB41291160	11/7/2004
EMI Receiver, 9 kHz ~ 2.9 GHz	HP	8542E	3942A00286	11/21/2004
RF Filter Section	HP	85420E	3705A00256	11/21/2004
Antenna, Tuned Dipole	CDI	Roberts	117	5/15/2004

MEASUREMENT PROCEDURE

- 1). On a test site, the EUT shall be placed on a turntable, and in the position closest to the normal use as declared by the user.
- 2). The test antenna shall be oriented initially for vertical polarization located 3m from the EUT to correspond to the frequency of the transmitter.
- 3). The output of the test antenna shall be connected to the measuring receiver and either a peak or quasi-peak detector was used for the measurement as indicated on the report. The detector selection is based on how close the emission level was approaching the limit.
- 4). The transmitter shall be placed 0.80 meter above the ground plane, the X, Y, and Z positions shall be tested and the worst case reported. The transmitter shall be switched on with typical modulation and the measurement receiver shall be tuned to the frequency of the transmitter under test.
- 5). The test antenna shall be raised and lowered through the specified range of height until a maximum signal level is detected by the measuring receiver.
- 6). The transmitter shall than be rotated through 360° in the horizontal plane, until the maximum signal level is detected by the measuring receiver.
- 7). The test antenna shall be raised and lowered again through the specified range of height until a maximum signal level is detected by the measuring receiver.
- 8). The maximum signal level detected by the measuring receiver shall be noted.
- 9). The transmitter shall be replaced by a tuned dipole (substitution antenna).
- 10). The substitution antenna shall be oriented for vertical polarization and the length of the substitution antenna shall be adjusted to correspond to the frequency of the transmitter.
- 11). The substitution antenna shall be connected to a calibrated signal generator.
- 12). If necessary, the input attenuator setting of the measuring receiver shall be adjusted in order to increase the sensitivity of the measuring receiver.
- 13). The test antenna shall be raised and lowered through the specified range of the height to ensure that the maximum signal is received.

14). The input signal to the substitution antenna shall be adjusted to the level that produces a level detected by the measuring receiver, that is equal to the level noted while the transmitter radiated power was measured, corrected for the change of input attenuation setting of the measuring receiver.

15). The input level to the substitution antenna shall be recorded as power level in dBm, corrected for any change of input attenuator setting of the measuring receiver.

16). The measurement shall be repeated with the test antenna and the substitution antenna oriented for horizontal polarization.

17). The measure of the effective radiated power is the larger of the two levels recorded, at the input to the substitution antenna, corrected for the gain of the substitution antenna if necessary.

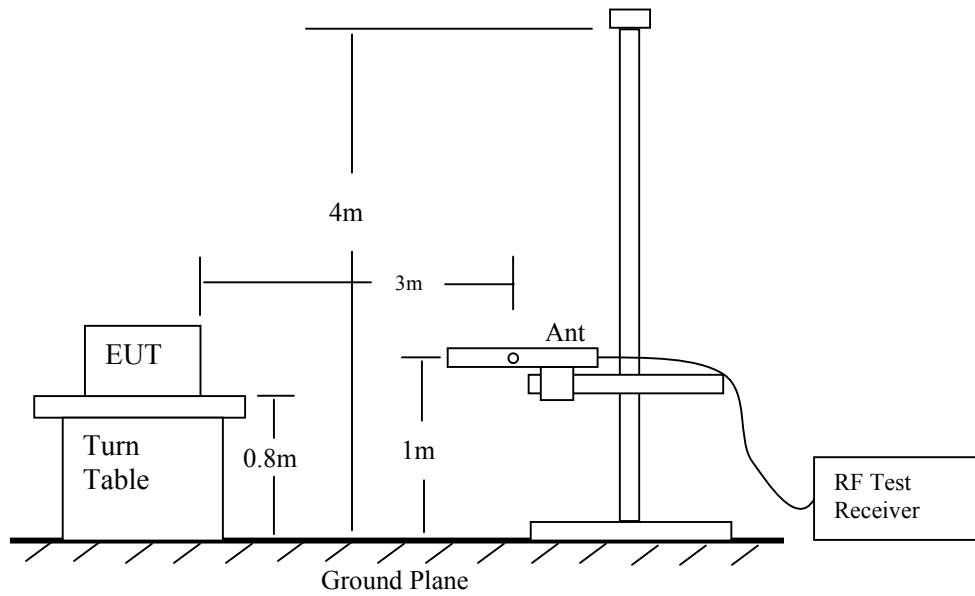

Radiated Emission Measurement 30 to 1000 MHz

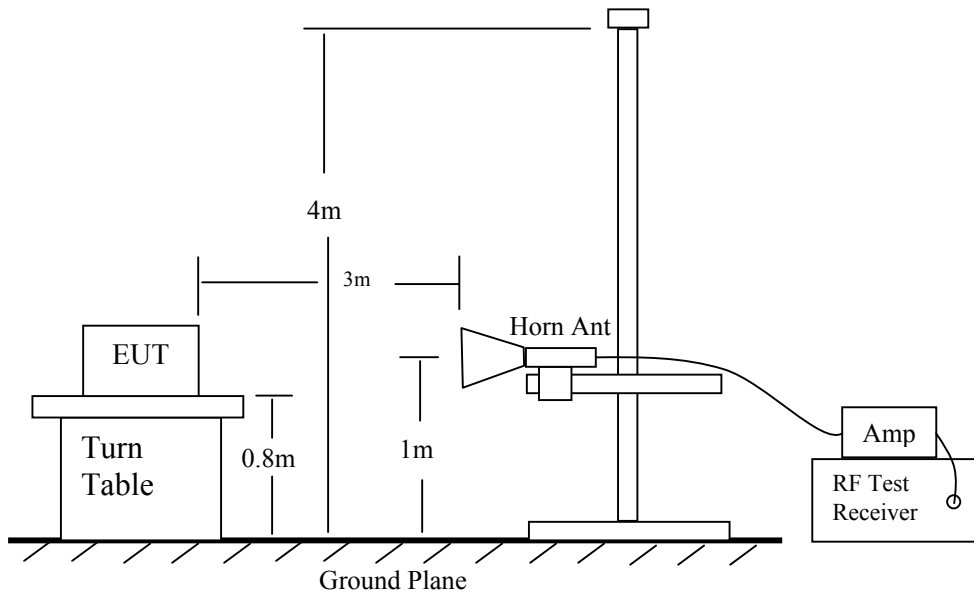

Radiated Emission Above 1000 MHz

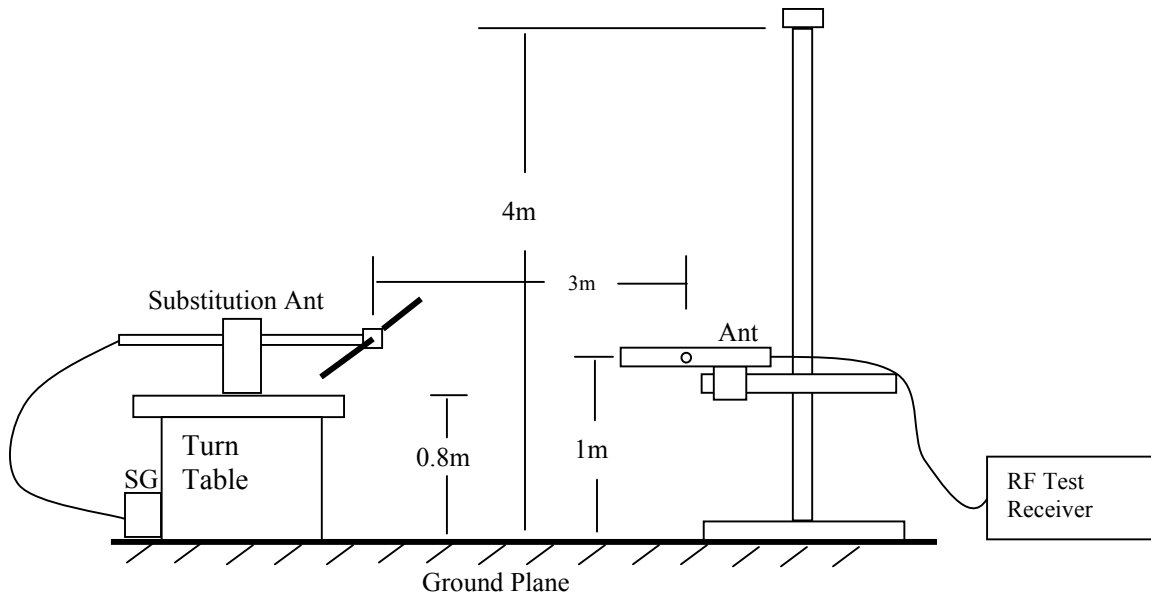

Radiated Emission – Substitution Method Setup

X position:



Y position:



Z position:



Test result:

CDMA Output Power (ERP):

f GHz	SA reading (dBm)	SG reading (dBm)	CL (dB)	Gain (dBi)	Gain (dBd)	ERP (dBm)	Limit (dBm)	Margin (dB)	Notes
CDMA (Y position worst case)									
0.825	103.0	27.4	0.8	0.0	-2.2	24.5	38.0	-13.5	Low Ch, V
0.825	98.4	25.9	0.8	0.0	-2.2	22.9	38.0	-15.1	Low Ch, H
0.83589	104.5	28.9	0.8	0.0	-2.2	25.9	38.0	-12.1	Mid Ch, V
0.83589	94.0	21.5	0.8	0.0	-2.2	18.5	38.0	-19.5	Mid Ch, H
0.84831	102.4	26.8	0.8	0.0	-2.2	23.9	38.0	-14.1	High Ch, V
0.84831	97.0	24.5	0.8	0.0	-2.2	21.5	38.0	-16.5	High Ch, H

RBW=VBW=3MHz

AMPS Output Power (ERP):

f GHz	SA reading (dBuV)	SG reading (dBm)	CL (dB)	Gain (dBi)	Gain (dBd)	ERP (dBm)	Limit (dBm)	Margin (dB)	Notes
AMPS (Y position worst case)									
0.824	96.4	20.8	0.8	0.0	-2.2	17.8	38.0	-20.2	Low Ch, H
0.824	100.3	27.8	0.8	0.0	-2.2	24.9	38.0	-13.1	Low Ch, V
0.83649	97.9	22.3	0.8	0.0	-2.2	19.3	38.0	-18.7	Mid Ch, H
0.83649	99.1	26.6	0.8	0.0	-2.2	23.7	38.0	-14.3	Mid Ch, V
0.84897	95.4	19.8	0.8	0.0	-2.2	16.8	38.0	-21.2	High Ch, H
0.84897	99.3	26.8	0.8	0.0	-2.2	23.9	38.0	-14.1	High Ch, V

RBW = VBW = 1MHz

7.2. SECTION 2.1047: MODULATION CHARACTERISTICS

PROVISIONS APPLICABLE

According to CFR 47 section 2.1047 (a), for Voice Modulated Communication Equipment, the frequency response of the audio modulation circuit over a range of 100 to 5000 Hz shall be measured.

According to CFR 47 section 22.915 (d) _ Audio Filter Characteristics

(1) For mobile stations, these signals must be attenuated, relative to the level at 1KHz, as follows:

- (i) In the frequency ranges of 3.0 to 5.9KHz and 6.1 to 15.0KHz, signals must be attenuated by at least $40 \log (f / 3)$ dB, where f is the frequency of the signal in KHz.
- (ii) In the frequency ranges of 5.9 to 6.1KHz, signals must be attenuated at least 35dB.
- (iii) In the frequency ranges above 15KHz, signals must be attenuated at least 28dB.

MEASUREMENT METHOD

Modulation Limit

- 1). Configure the EUT as shown below, adjust the audio input for 60% of rated system deviation at 1 KHz using this level as a reference (0 dB) and vary the input level from -20 to +20 dB. Record the frequency deviation obtained as a function of the input level.
- 2). Repeat step 1 with input frequency changing to 300, 1004, 1500Hz, and 2500 Hz in sequence.

Audio Frequency Response

- 1). Configure the EUT as shown below.
- 2). Adjust the audio input for 20% of rated system deviation at 1 KHz using this level as a reference (0 dB).
- 3). Vary the Audio frequency from 100 Hz to 10 KHz and record the frequency deviation.
- 4). Audio Frequency Response = $20 \log_{10} (\text{Deviation of test frequency} / \text{Deviation of 1KHz reference})$.

TETS SETUP

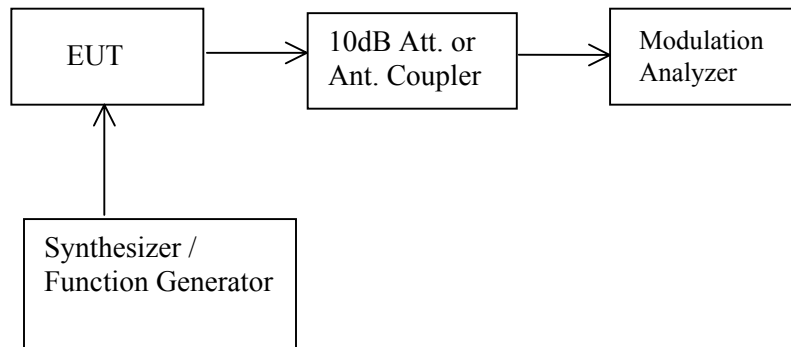

Modulation characteristic measurement configuration

Audio Low Pass Filter Response

- 1). Configure the EUT as shown below.
- 2). Connect the audio frequency generator as close as possible the input of the post limiter low pass filter within the transmitter under test.
- 3). Connect the audio spectrum analyzer to the output of the post limiter low pass filter within the transmitter under test.
- 4). Apply 1000 Hz tone from the audio frequency generator and adjust the level per manufacturer's specifications.
- 5). Record the dB level of the 1000 Hz spectral line on the audio spectrum analyzer as LEV_{REF} .
- 6). Set the audio frequency generator to the desired test frequency between 3000 Hz and the upper low pass filter limit.
- 7). Record audio spectrum analyzer levels, at the frequency in step 6).
- 8). Record the dB level on the audio spectrum analyzer as LEV_{FREQ} .
- 9). Calculate the audio frequency response at the test frequency as:
$$\text{low pass filter response} = LEV_{FREQ} - LEV_{REF}$$
- 10). Repeat the 6) through 9) for all the desired test frequencies.

TEST SETUP

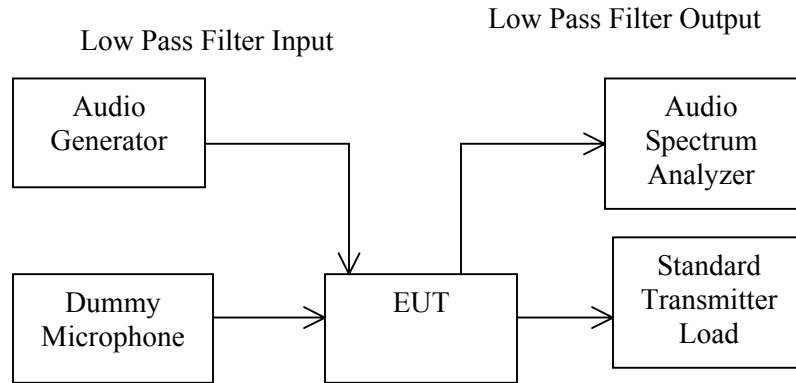

Audio low pass filter response measurement configuration



MEASUREMENT INSTRUMENT

TEST EQUIPMENT LIST				
Name of Equipment	Manufacturer	Model No.	Serial No.	Due Date
Spectrum Analyzer	HP	E4446A	US42510266	7/23/04
Function Generator	HP	3325A	2652A24749	5/8/04
Modulation Analyzer	HP	8901B	3438A05272	6/23/04

MEASUREMENT RESULT:

a). Modulation Limit:

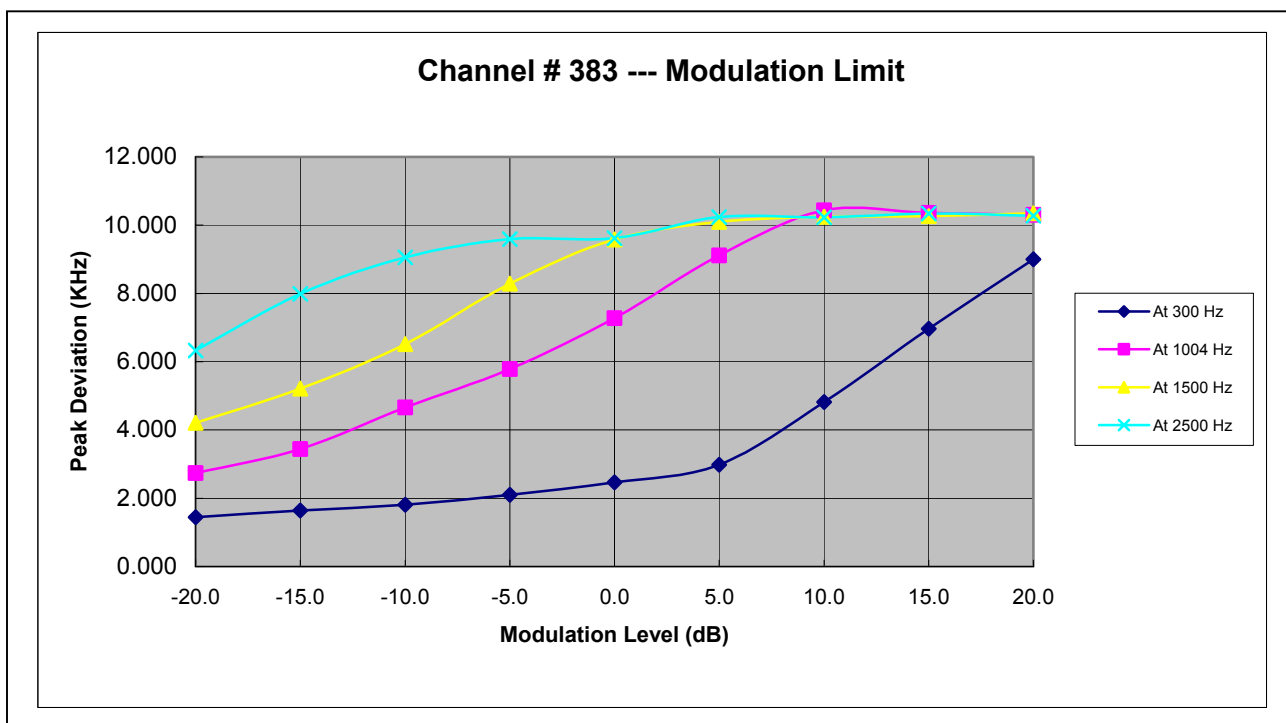

b). Audio Frequency Response:

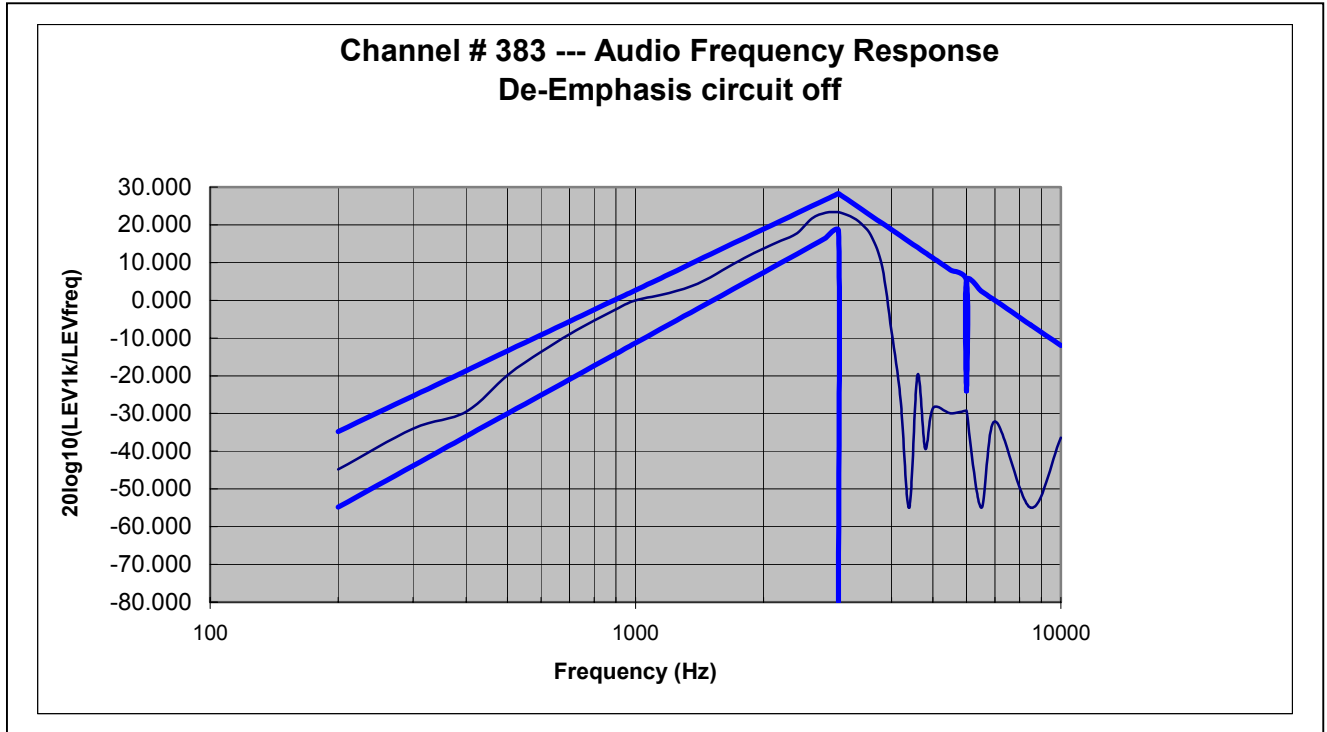

c). Audio low pass filter response:

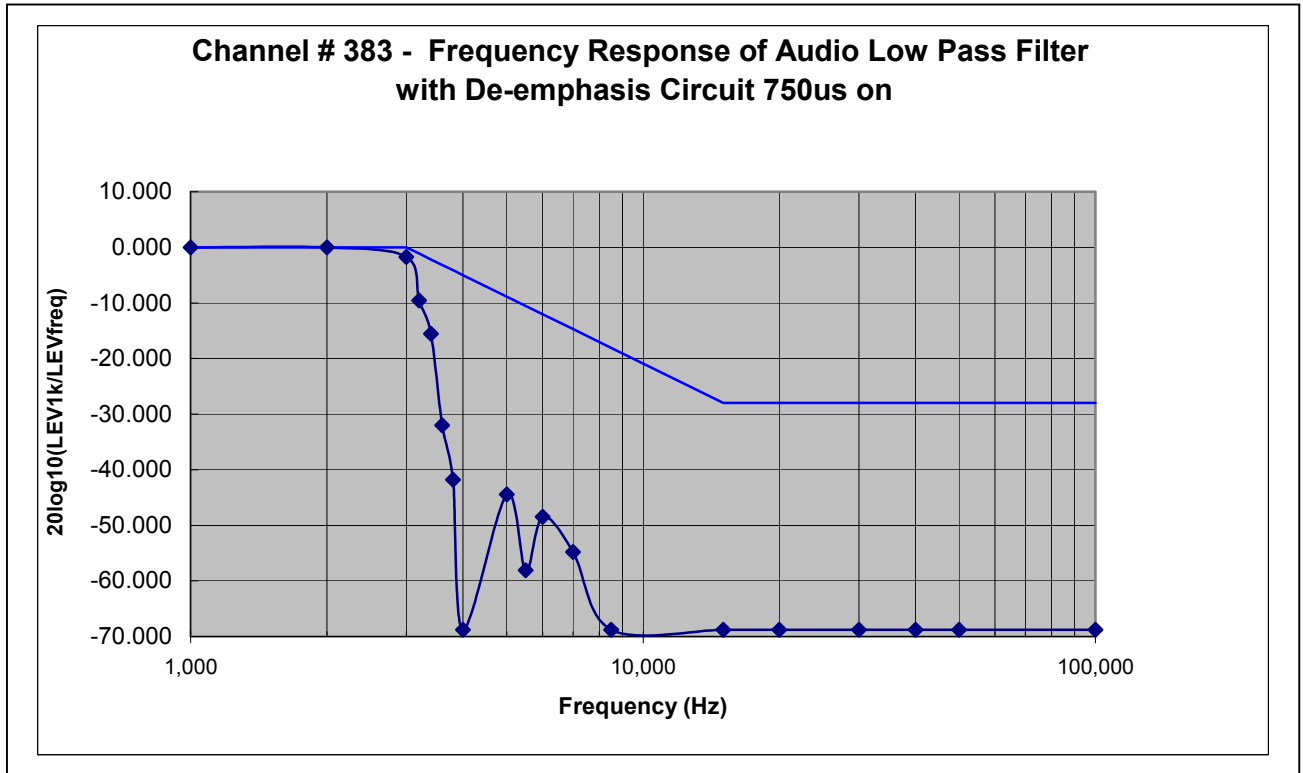

7.3. SECTION 2.1049: OCCUPIED BANDWIDTH

OCCUPIED BANDWIDTH FOR CDMA MODULATION:

TEST SETUP

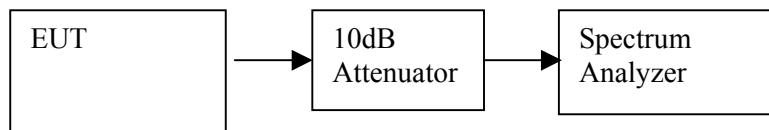

TEST PROCEDURE

The EUT's output RF connector (made solely for the purpose of the test) was connected with a short cable to the spectrum analyzer, RES BW was set to about 1% of emission BW, -26 dBc display line was placed on the screen (or 99% bandwidth), the occupied BW is the delta frequency between the two points where the display line intersects the signal trace.

RESULT

No non-compliance noted, reference only.

Channel	Frequency (MHz)	99% BW (MHz)	-26dBc BW (MHz)
Low	824.70	1.2540	1.375
Middle	835.89	1.2417	1.365
High	848.31	1.2452	1.405

Low Channel:

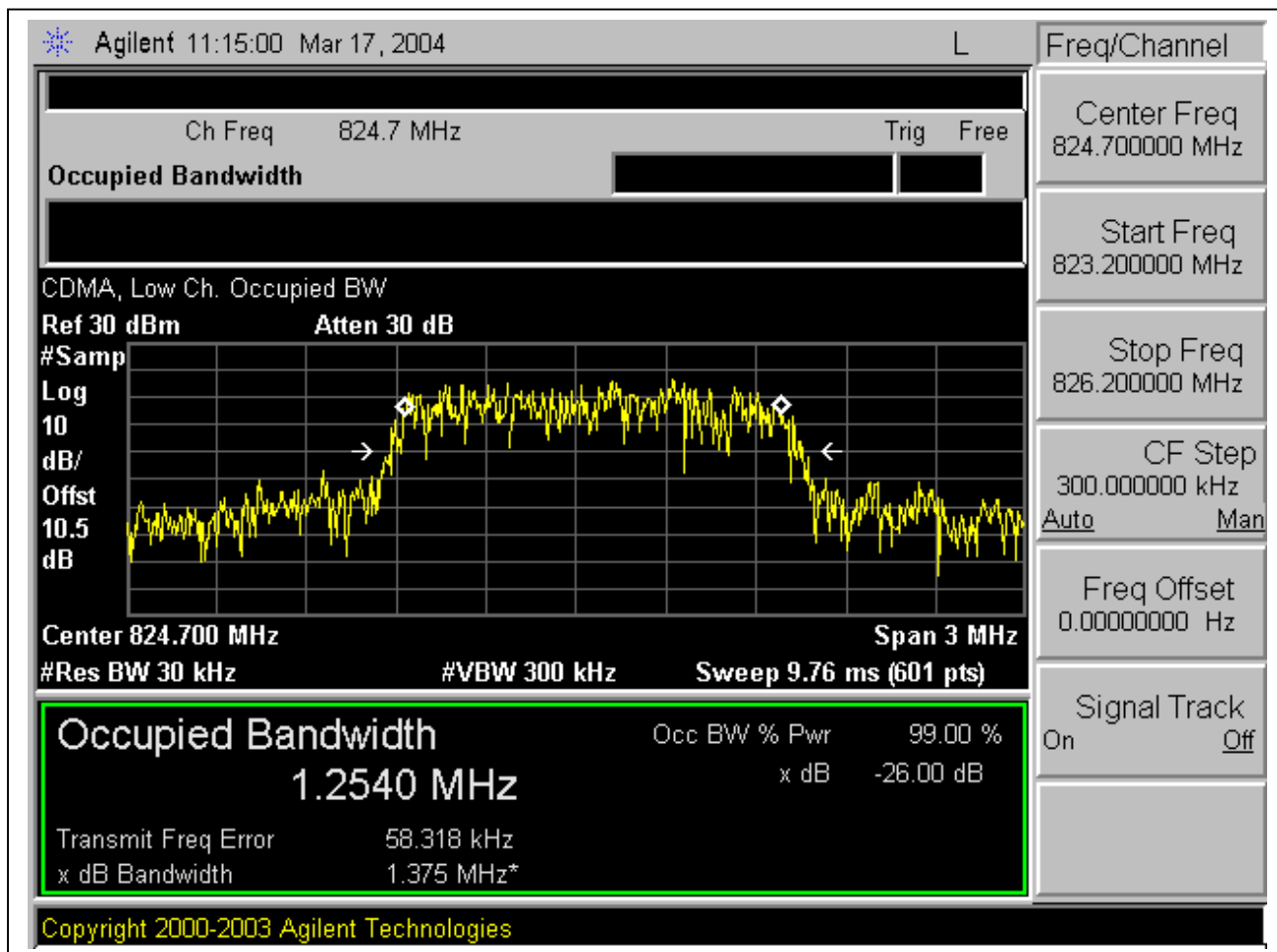

Mid Channel:

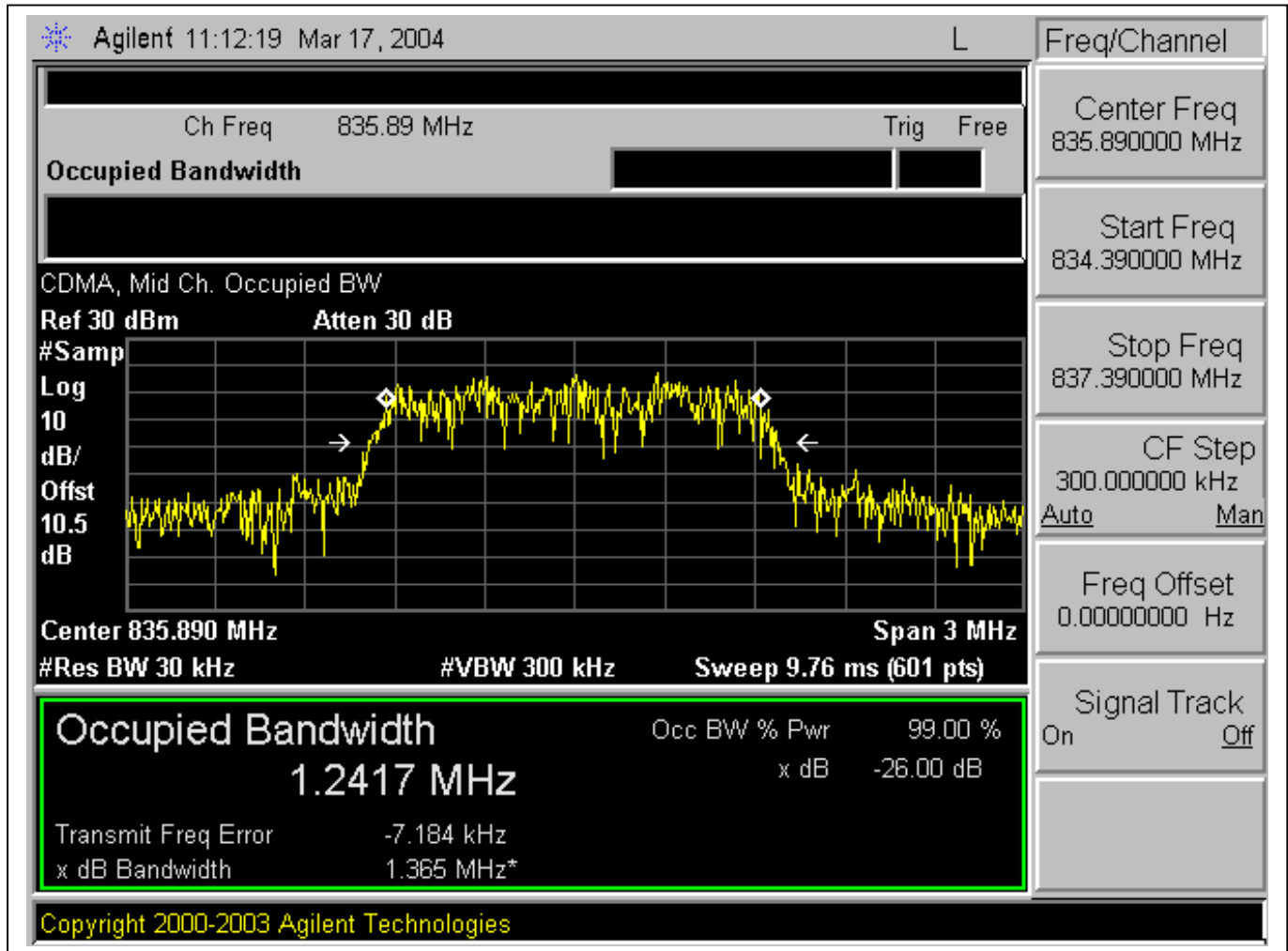

High Channel:

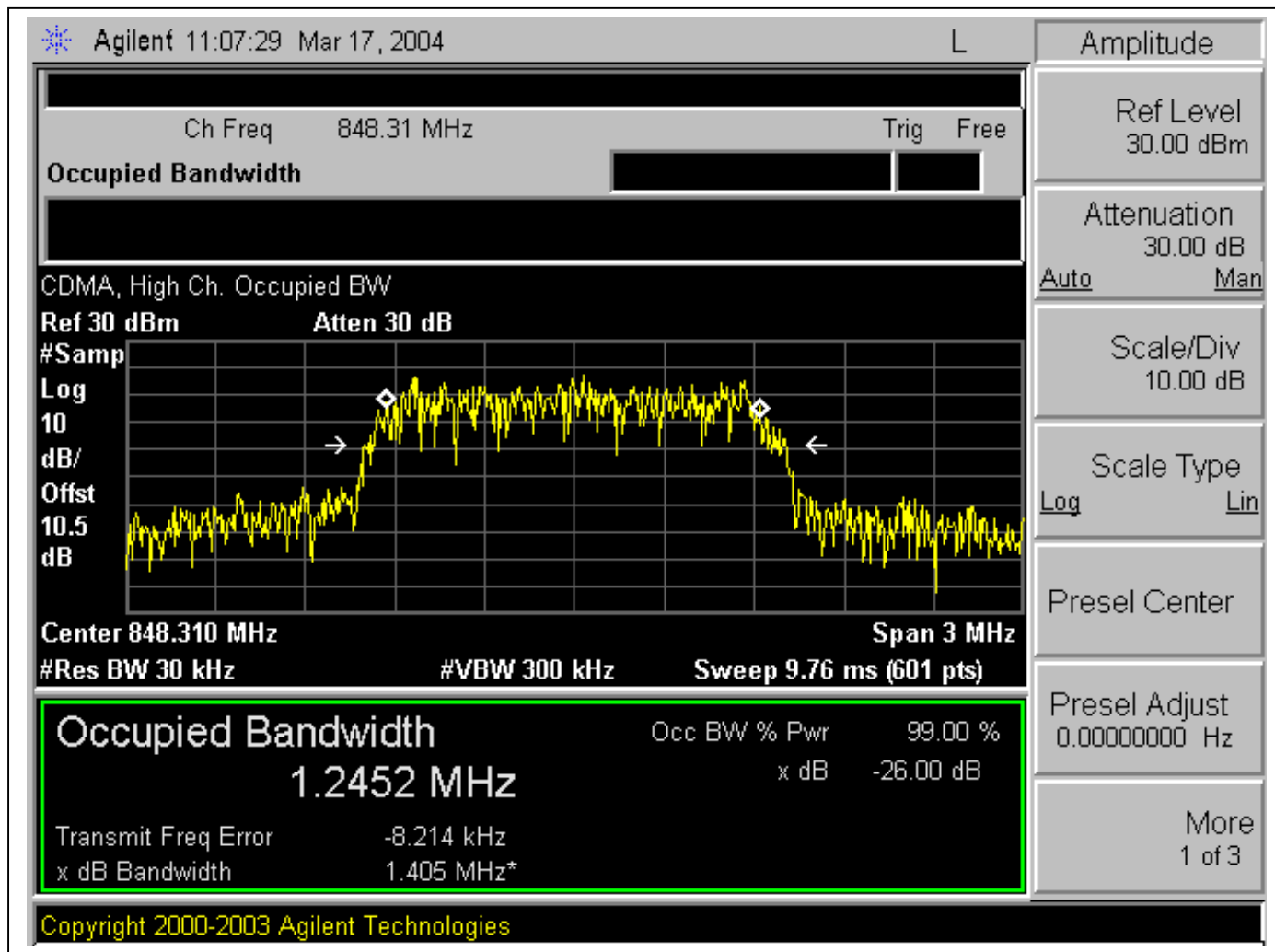

OCCUPIED BANDWIDTH FOR AMPS MODULATION:

PROVISIONS APPLICABLE

According to CFR 47 section 22.917, the authorized bandwidth for emission type of F3E unit is 20 KHz.

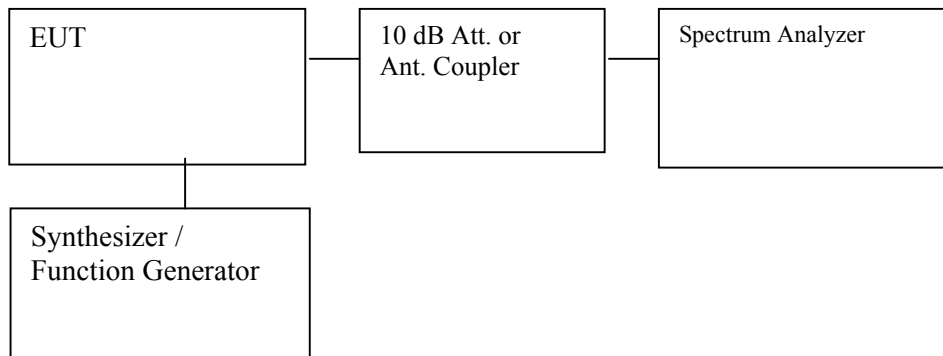

Set-up Photo

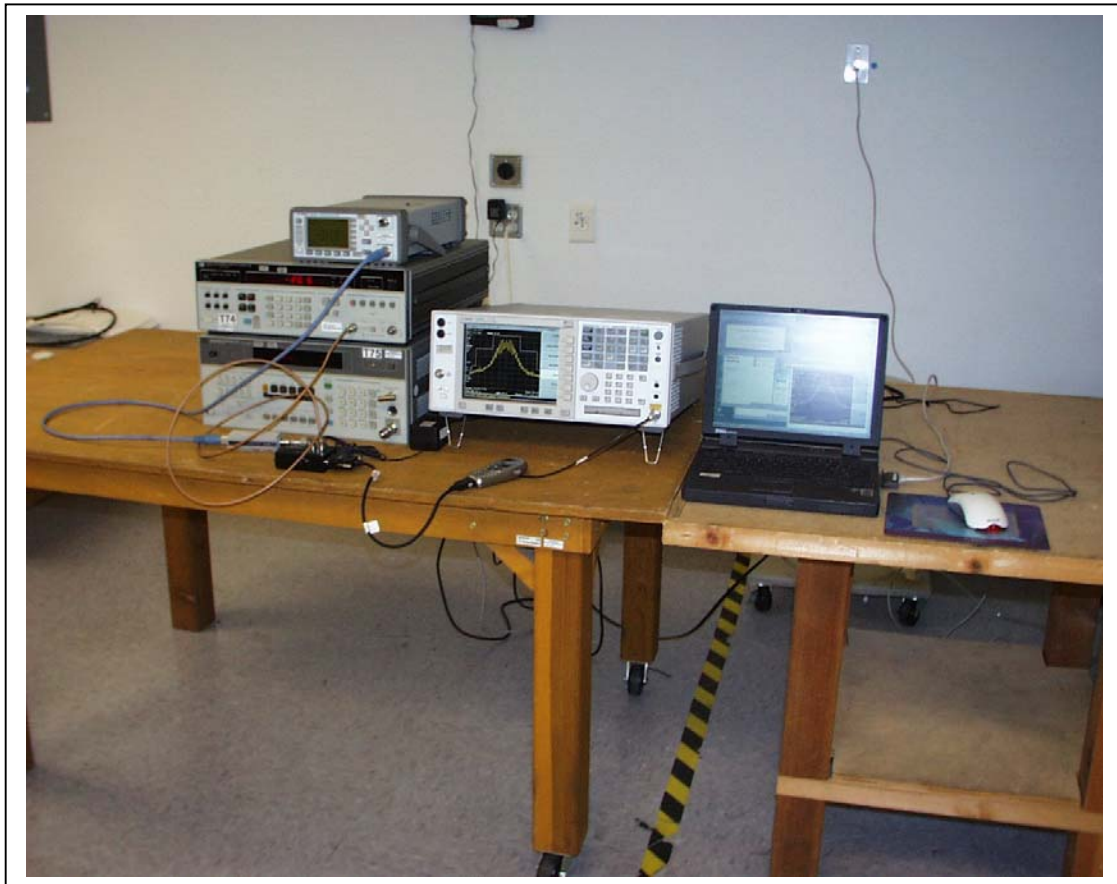

7.3.1. Un-modulated Signal

INSTRUMENT SETTING:
Resolution Bandwidth = 300Hz
Video Bandwidth = 300Hz

Limit:
N/A

Test Result:

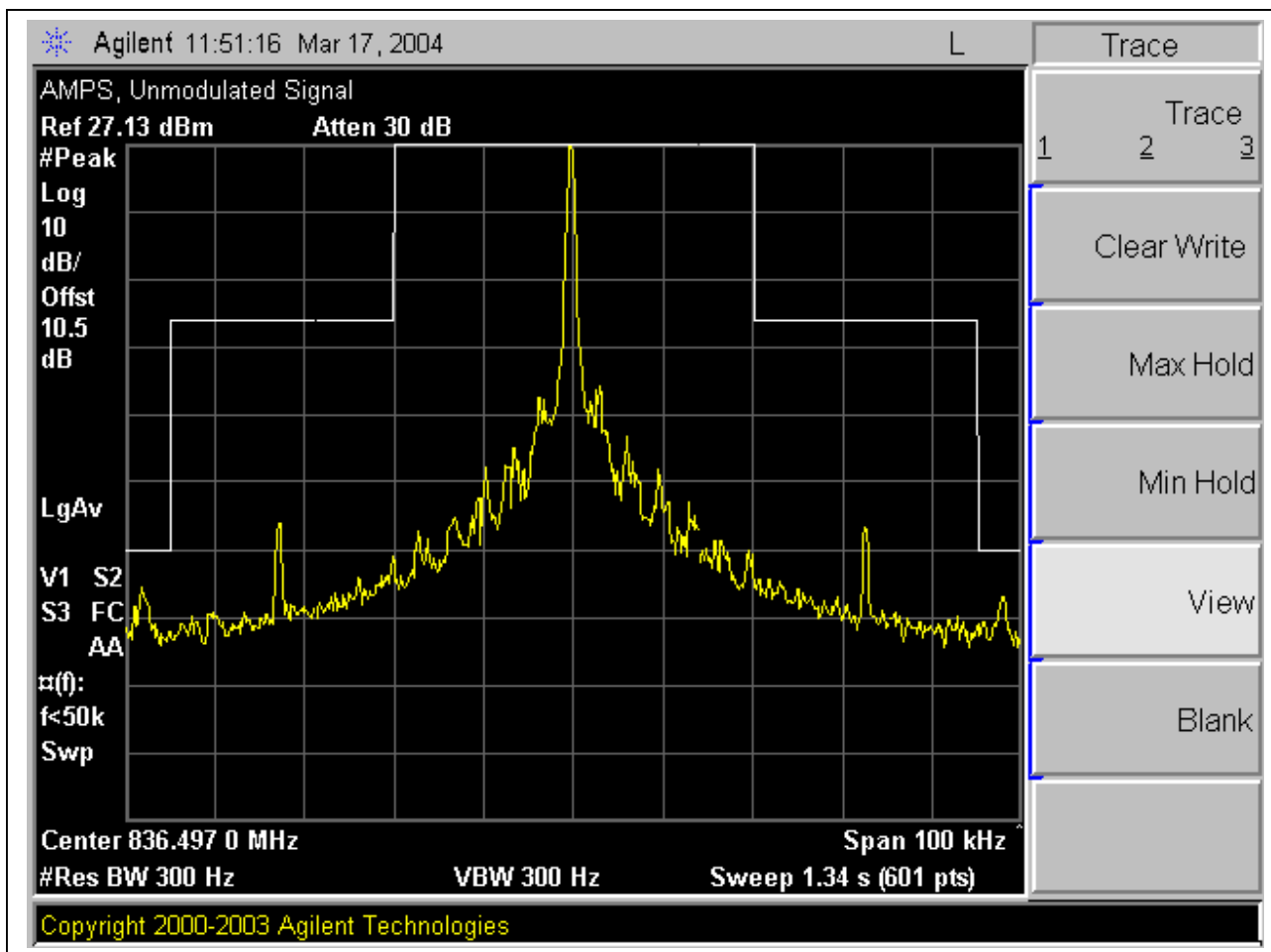

7.3.2. Voice

INSTRUMENT SETTING:

Resolution Bandwidth = 300Hz

Video Bandwidth = 300Hz

Audio Tone = 2.5KHz

Audio Level = 16dB greater than level required to produce ± 6 KHz

Limit (22.917b):

- a. On any frequency removed from the assigned carrier frequency by more than 20KHz, up to and including 45KHz, the sideband is at least 26dB below the carrier.
- b. On any frequency removed from the assigned carrier frequency by more than 45KHz, up to the first multiple of the carrier frequency, the sideband is at least 60dB below the carrier or $43 + 10 \log_{10}$ (mean output power in W) dB, whichever is the smaller attenuation

Test Result:

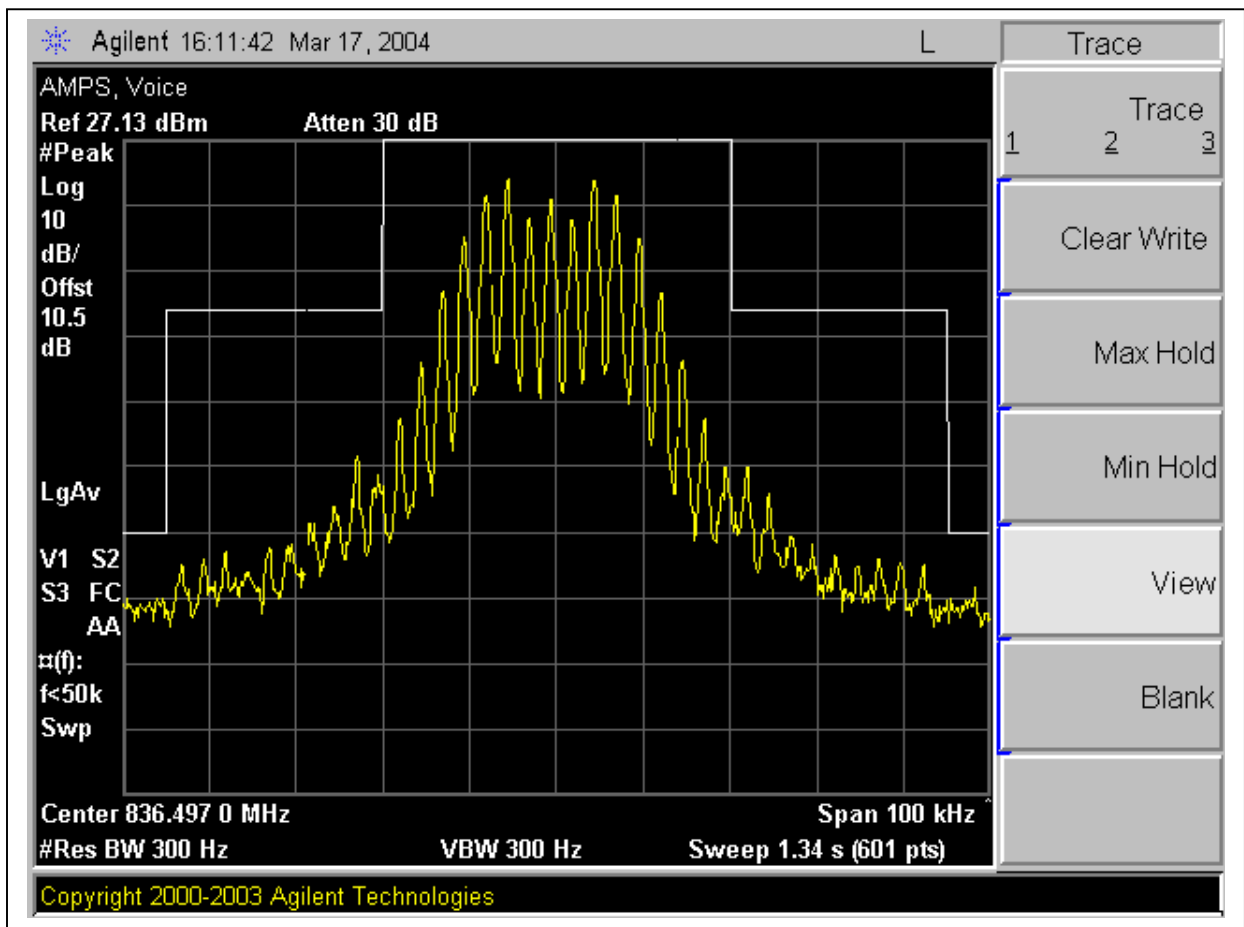

Signaling Tone (ST)

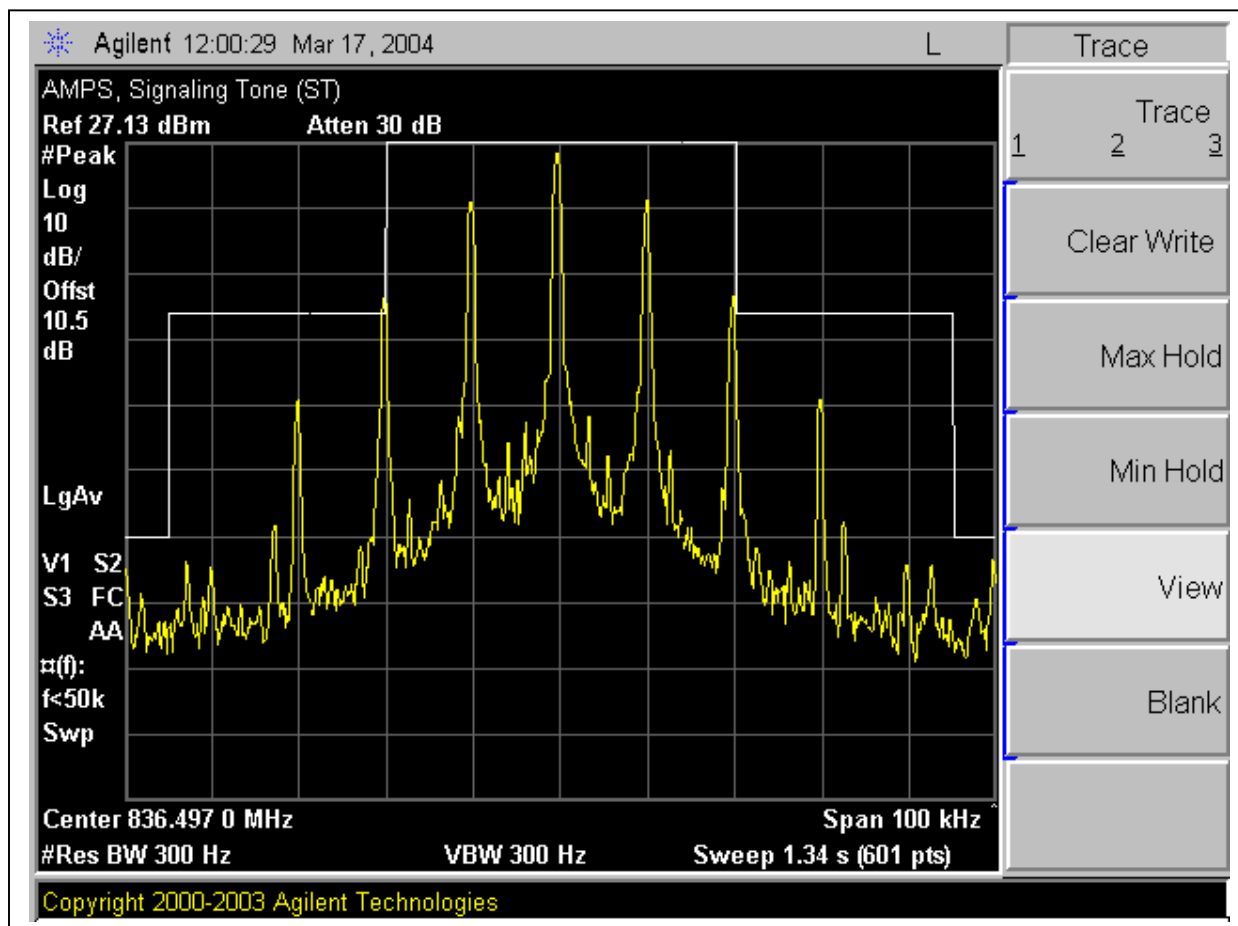

Supervisory Audio Tone (SAT)

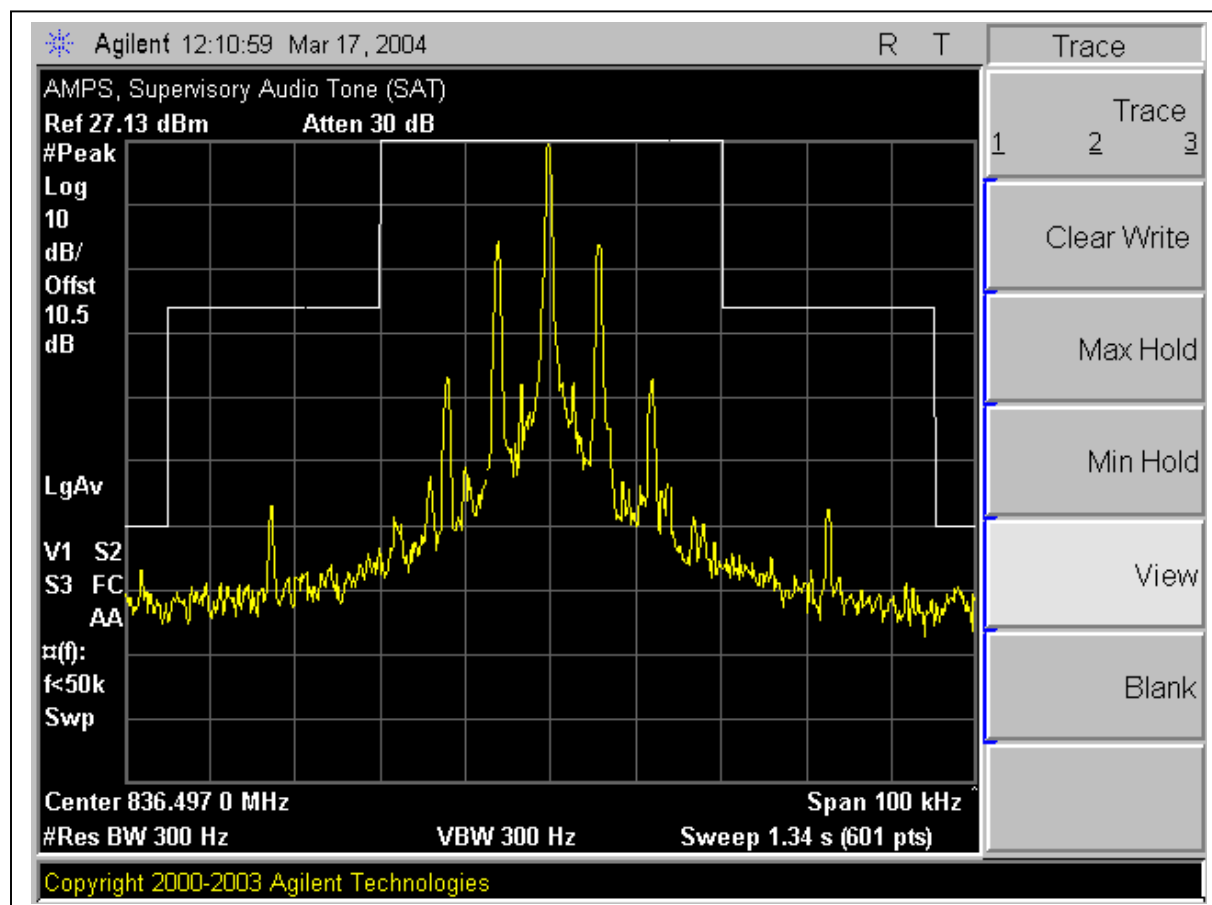

7.3.3. Signaling Tone (ST) + Supervisory Audio Tone (SAT)

INSTRUMENT SETTING:

Resolution Bandwidth = 300Hz

Video Bandwidth = 300Hz

Signal Tone = 10KHz

Limit (22.917d):

- a. On any frequency removed from the assigned carrier frequency by more than 20KHz, up to and including 45KHz, the sideband is at least 26dB below the carrier.
- b. On any frequency removed from the assigned carrier frequency by more than 45KHz, up to and including 90KHz, the sideband is at least 45dB below the carrier.
- c. On any frequency removed from the assigned carrier frequency by more than 90KHz, up to the first multiple of the carrier frequency, the sideband is at least 60dB below the carrier or $43 + 10 \log_{10}$ (mean output power in W) dB, whichever is the smaller attenuation.

Test Result:

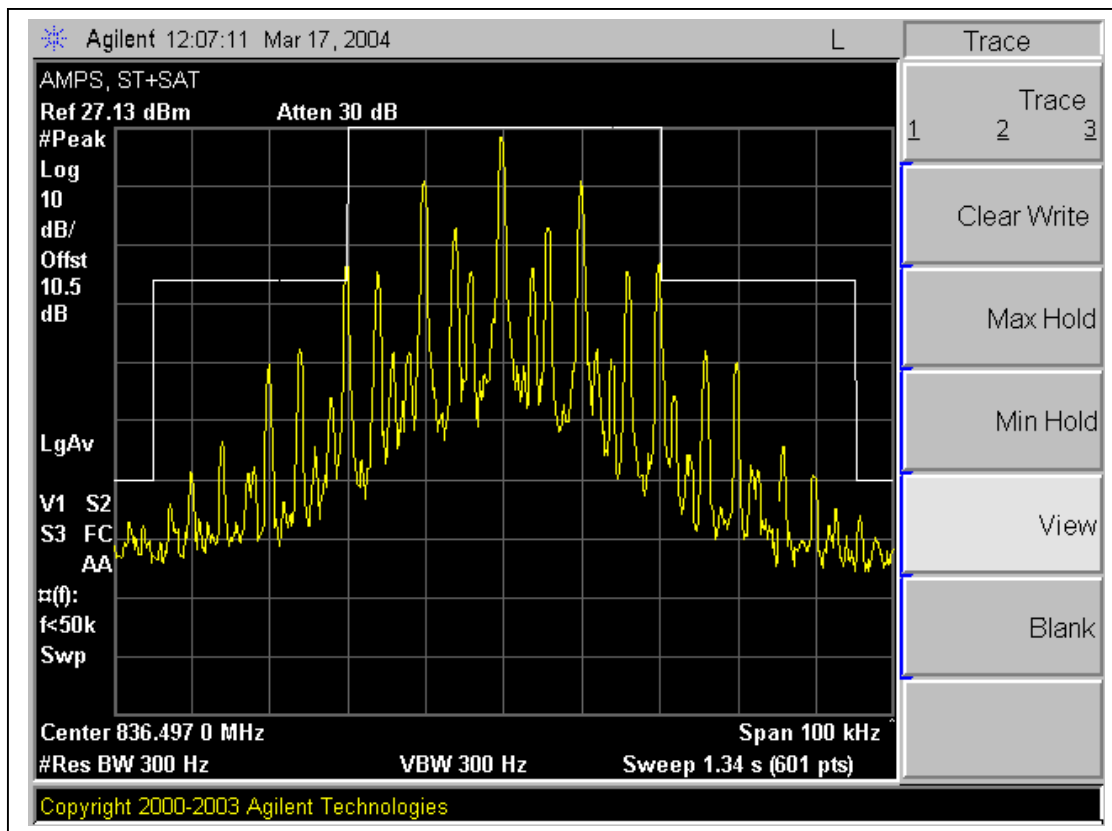

7.3.4. Wide Band Data (WBD)

INSTRUMENT SETTING:
 Resolution Bandwidth = 300Hz
 Video Bandwidth = 300Hz

Limit (22.917d):

- a. On any frequency removed from the assigned carrier frequency by more than 20KHz, up to and including 45KHz, the sideband is at least 26dB below the carrier.
- b. On any frequency removed from the assigned carrier frequency by more than 45KHz, up to and including 90KHz, the sideband is at least 45dB below the carrier.
- c. On any frequency removed from the assigned carrier frequency by more than 90KHz, up to the first multiple of the carrier frequency, the sideband is at least 60dB below the carrier or $43 + 10 \log_{10}$ (mean output power in W) dB, whichever is the smaller attenuation.

Test Result:

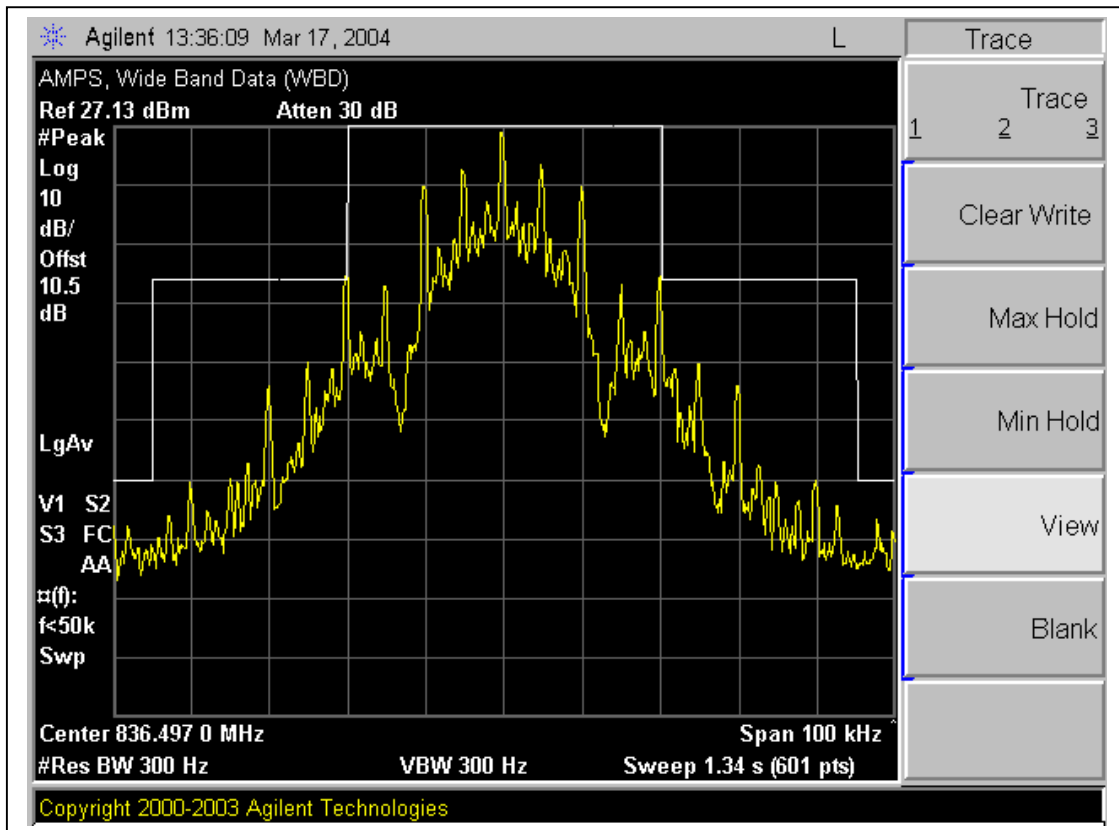

7.3.5. Voice + Supervisory Audio Tone (SAT)

INSTRUMENT SETTING:

Resolution Bandwidth = 300Hz

Video Bandwidth = 300Hz

Audio Tone = 2.5KHz

Audio Level = 16dB greater than level required to produce ± 8 KHz (Minimum level from technical specifications)

Limit (22.917b):

- b. On any frequency removed from the assigned carrier frequency by more than 20KHz, up to and including 45KHz, the sideband is at least 26dB below the carrier.
- c. On any frequency removed from the assigned carrier frequency by more than 45KHz, up to the first multiple of the carrier frequency, the sideband is at least 60dB below the carrier or $43 + 10 \log_{10}$ (mean output power in W) dB, whichever is the smaller attenuation

Test Result:

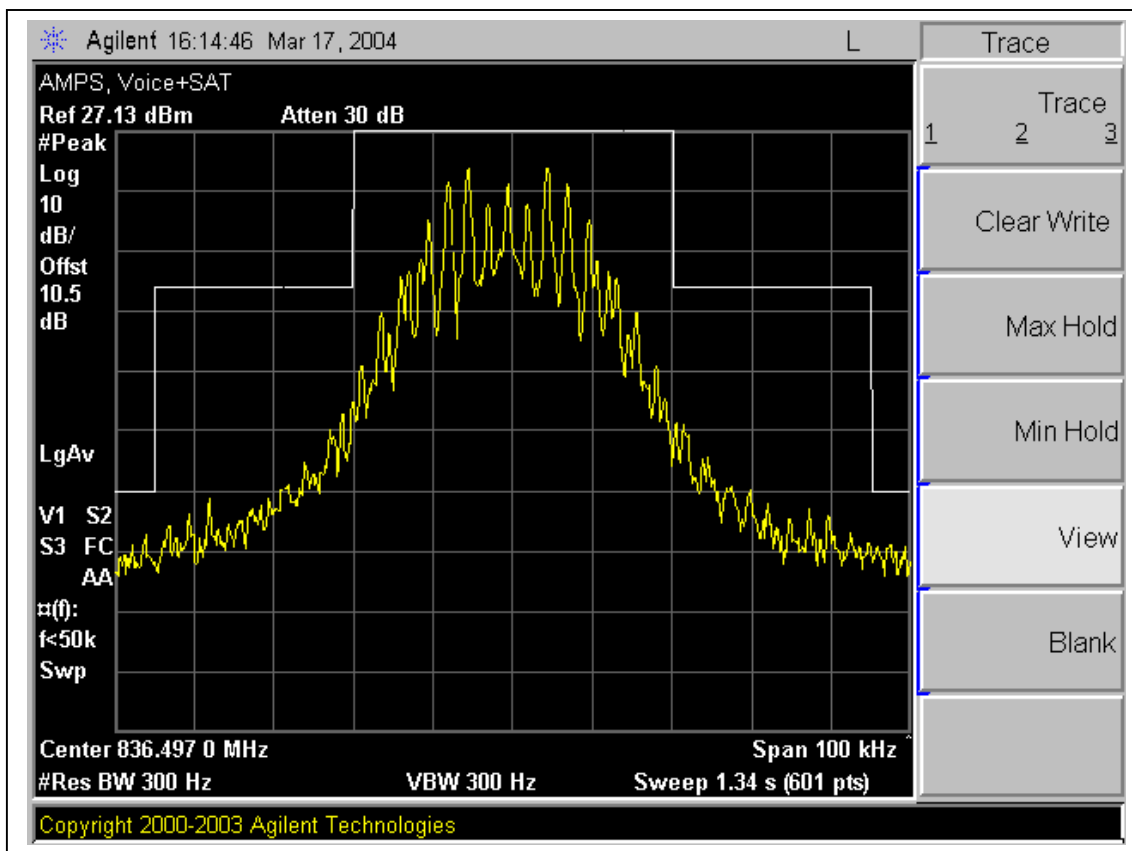

7.3.6. DTMF + Supervisory Audio Tone (SAT)

INSTRUMENT SETTING:
 Resolution Bandwidth = 300Hz
 Video Bandwidth = 300Hz

Limit (22.917d):

- a. On any frequency removed from the assigned carrier frequency by more than 20KHz, up to and including 45KHz, the sideband is at least 26dB below the carrier.
- b. On any frequency removed from the assigned carrier frequency by more than 45KHz, up to and including 90KHz, the sideband is at least 45dB below the carrier.
- c. On any frequency removed from the assigned carrier frequency by more than 90KHz, up to the first multiple of the carrier frequency, the sideband is at least 60dB below the carrier or $43 + 10 \log_{10}$ (mean output power in W) dB, whichever is the smaller attenuation.

Test Result:

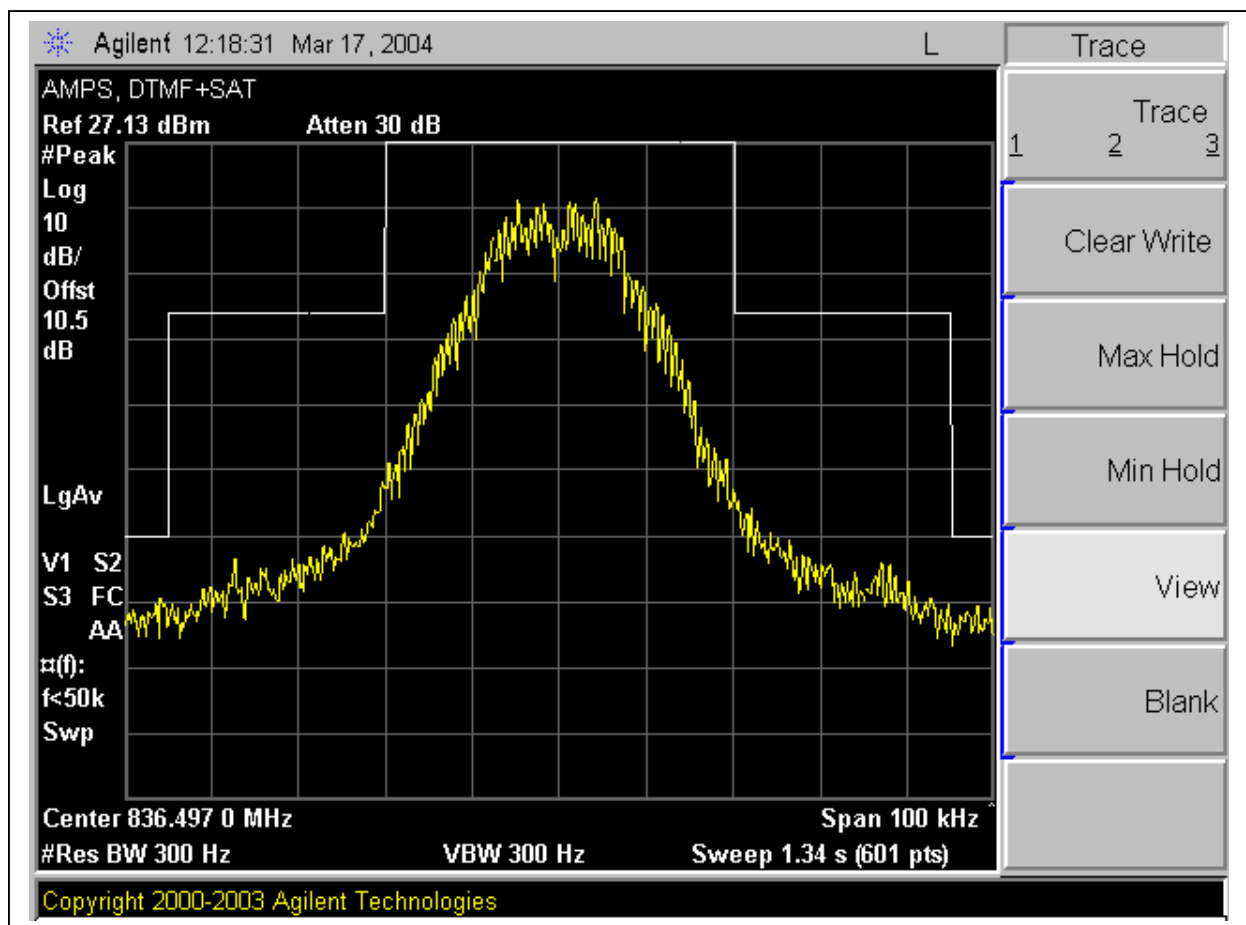

7.4. SECTION 2.1051: SPURIOUS EMISSION AT ANTENNA TERMINAL

INSTRUMENTS LIST

TEST EQUIPMENT LIST				
Name of Equipment	Manufacturer	Model No.	Serial No.	Due Date
Peak Power Meter	Agilent	E4416A	GB41291160	11/7/2004
Spectrum Analyzer	HP	E4446A	US42510266	7/23/2004
Function Generator	HP	3325A	2652A24749	5/8/2004
Modulation Analyzer	HP	8901B	3438A05272	6/23/2004

TEST SETUP

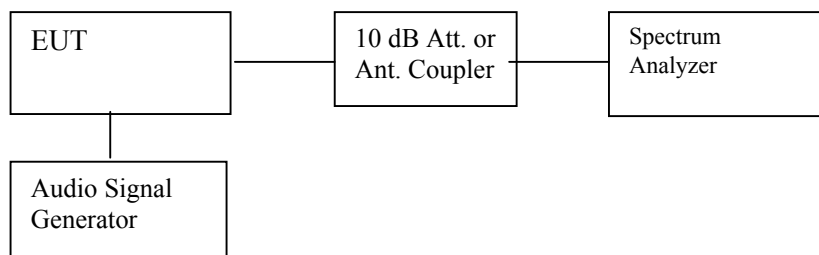

TEST PROCEDURE

- 1) RF signal or three balanced signals (intermodulation measurement) were applied to the RF input. One set as close as possible to the bottom of the block edge and one set as close as possible to the top of the block edge. Set the RES BW to 1% of the emission bandwidth to show compliance with the -13dBm limit, in the 1 MHz bands immediately outside and adjacent to the top and bottom edges of the frequency block.
- 2) For the Out-of-Band measurements a 1 MHz RES BW was used to scan from 15 MHz to 10xfo of the fundamental carrier for all frequency block. A display line was placed at -13dBm to show compliance for spurious, harmonics, and intermodulation emissions.
- 3) 22.917(f); Mobile emissions in base frequency range. The mean power of any emissions appearing in the base station frequency range from cellular mobile transmitter operated must be attenuated to a level not to exceed -80dBm at the transmit antenna connector.

RESULT:

CDMA Modulation: Low / Mid / High, Band Edge, Out-Of-Band Emissions

Low Channel, Out-Of-Band Emissions

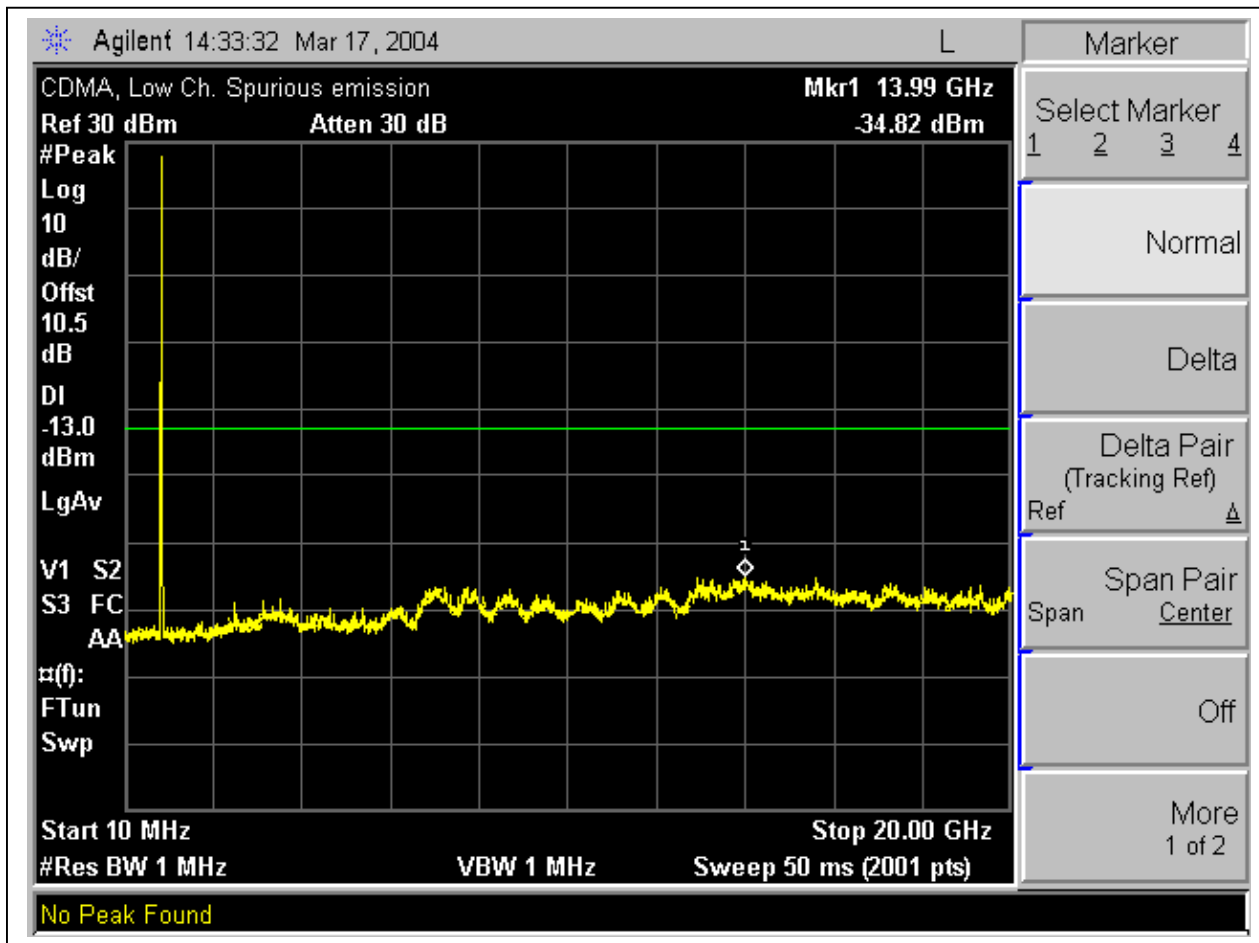

Mid Channel, Out-Of-Band Emissions

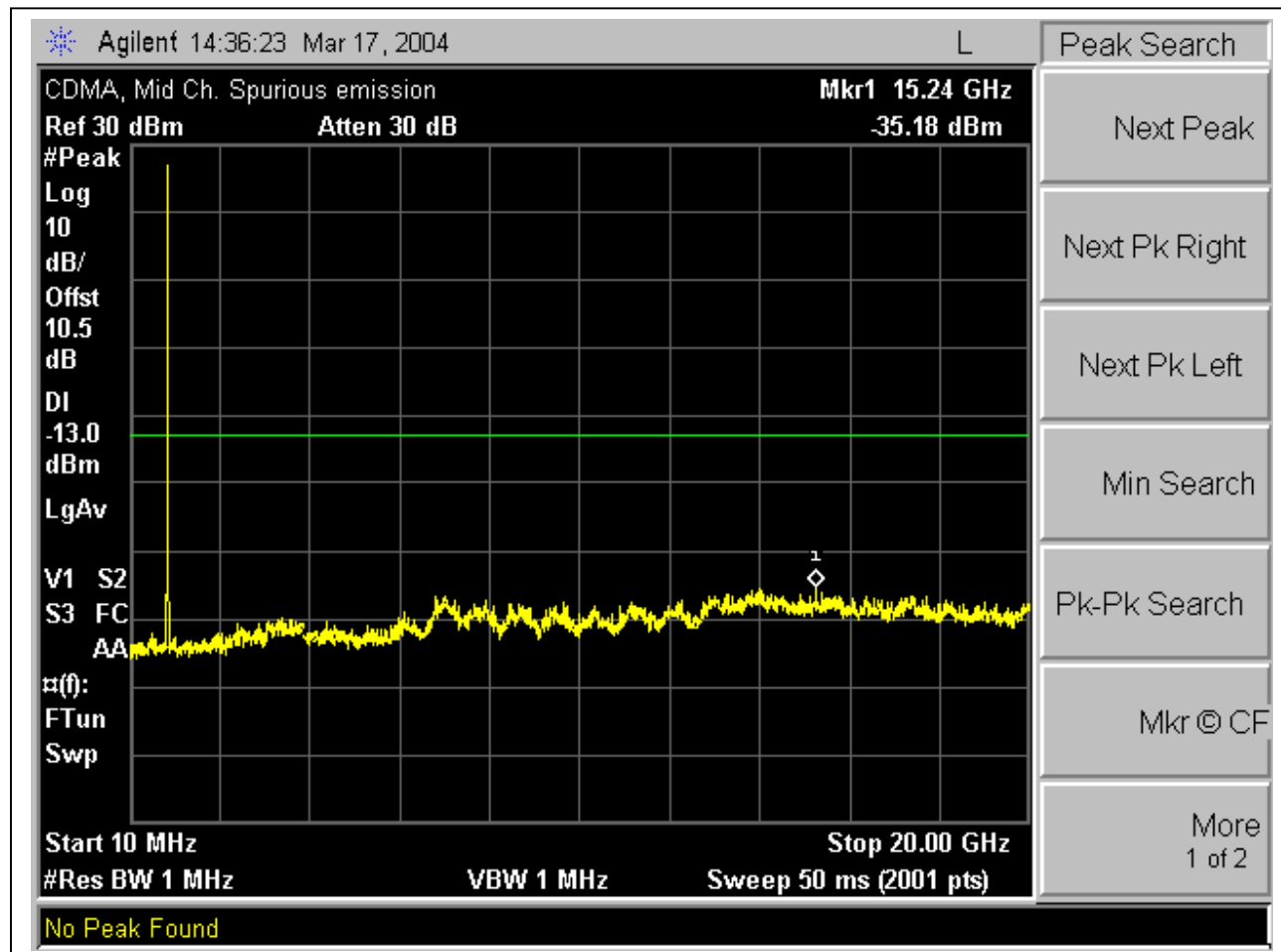

High Channel, Out-Of-Band Emissions

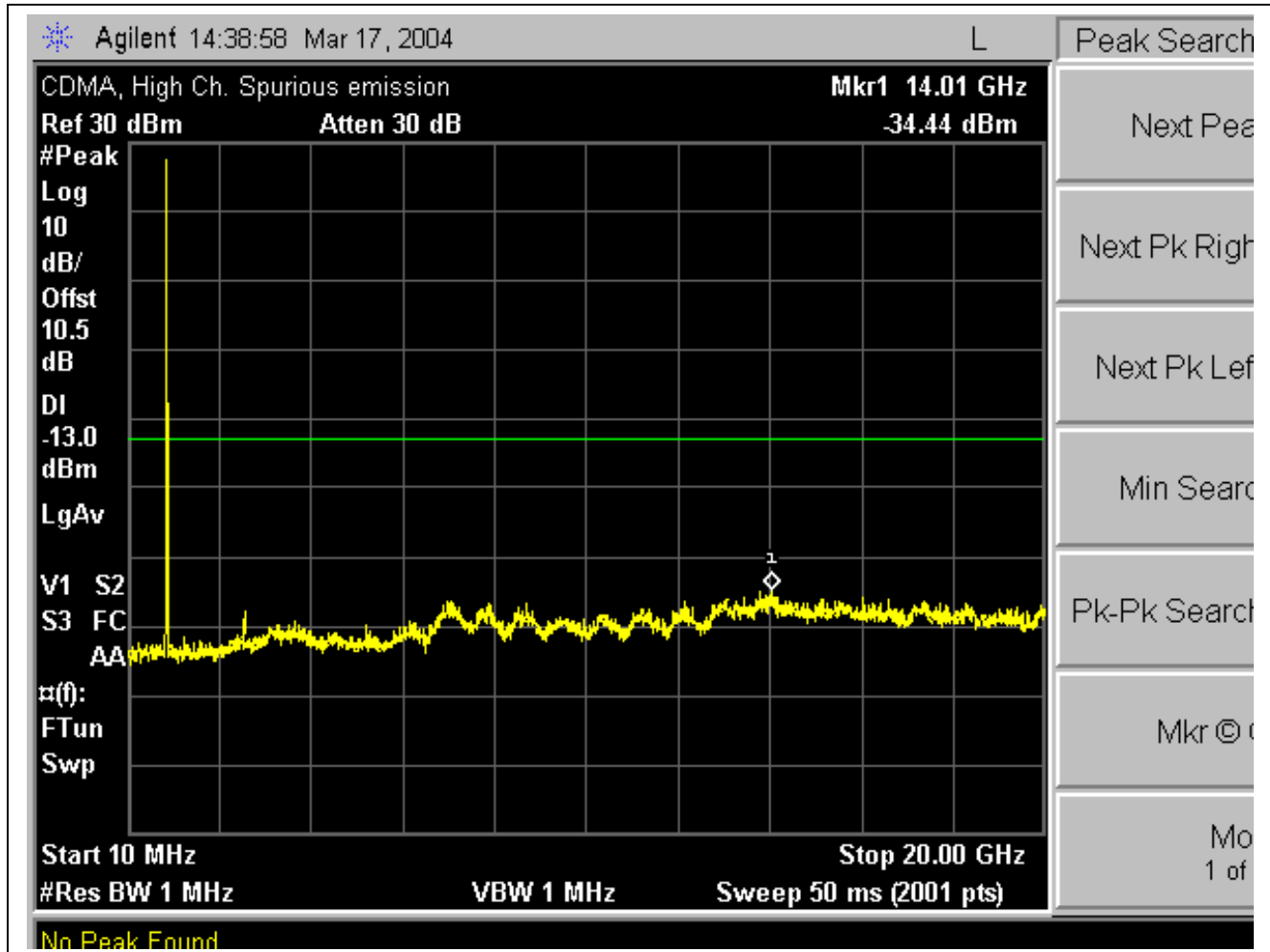

Low Channel Band Edge

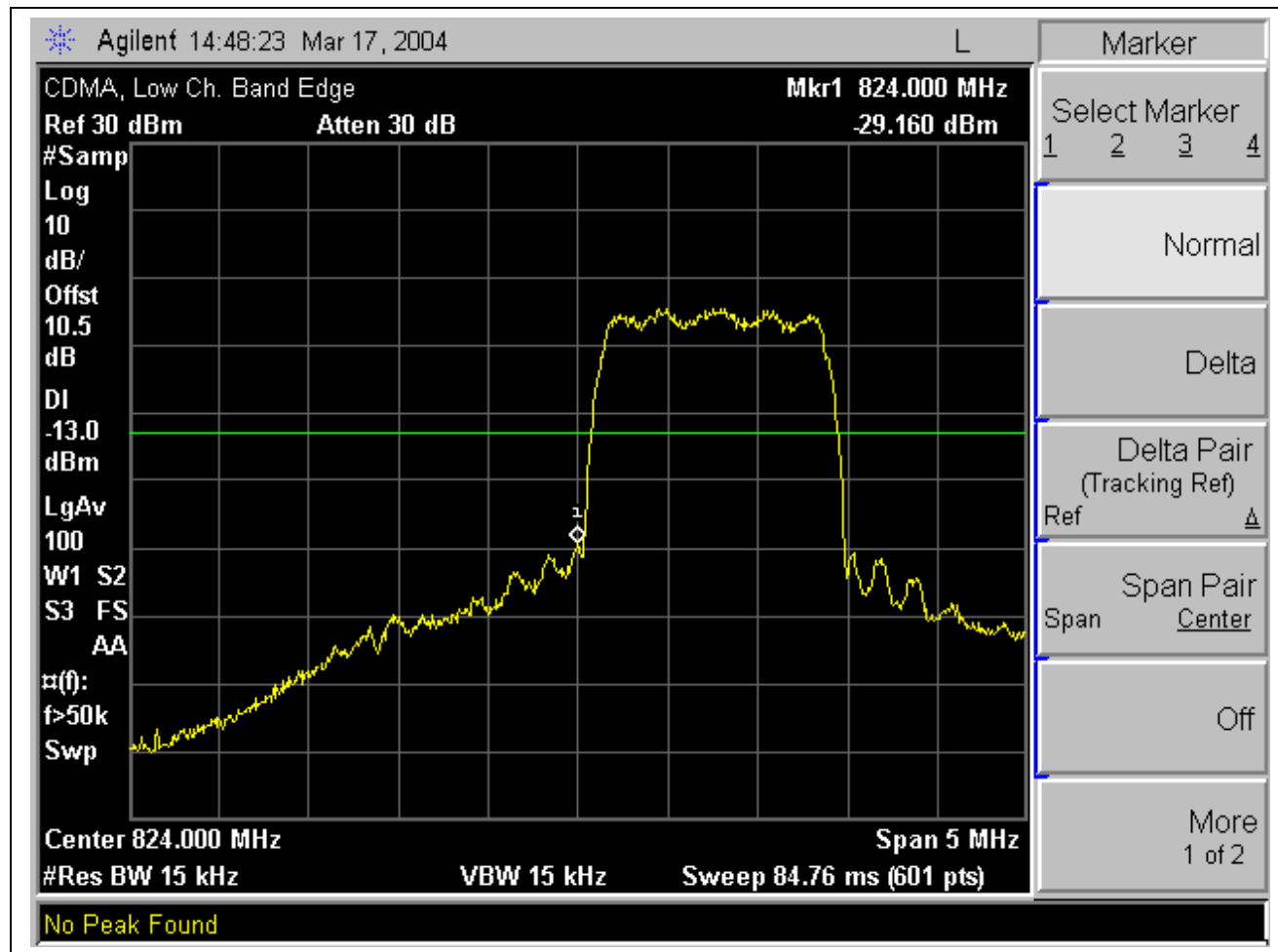

High Channel Band Edge

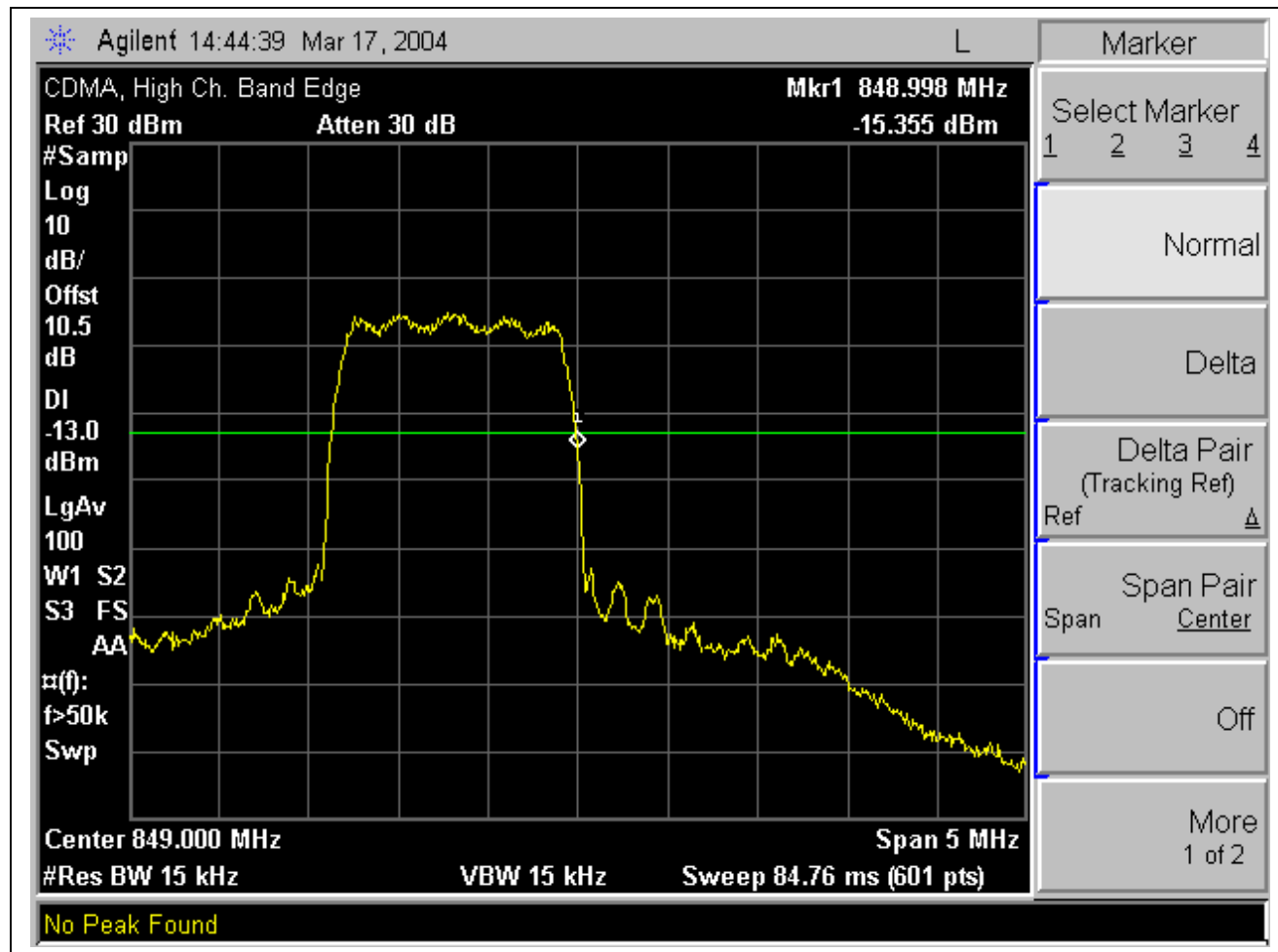

CDMA Mobile Emissions in Base Frequency Range:

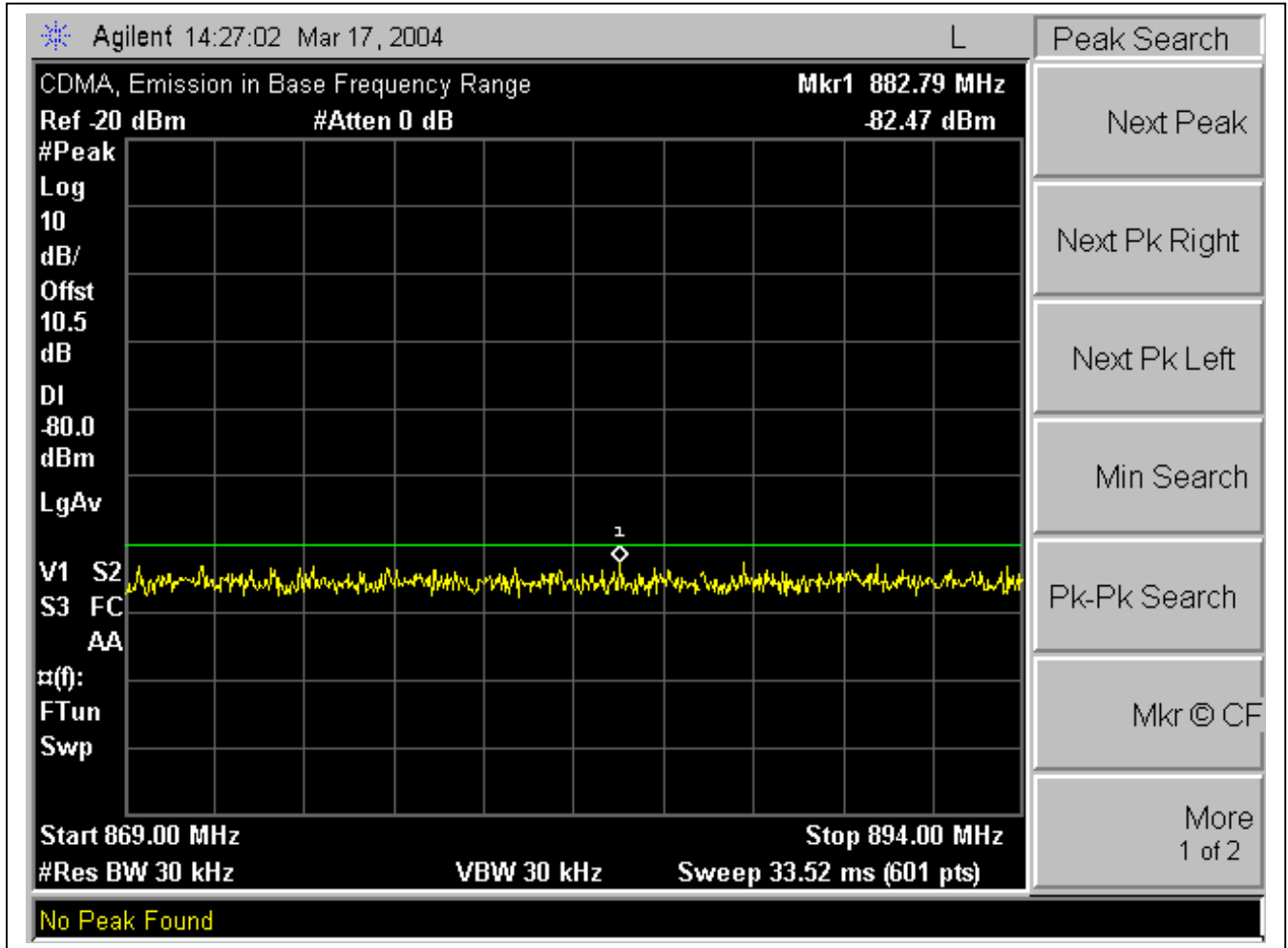

AMPS Modulation: Low Channel Out-Of-Band Emissions

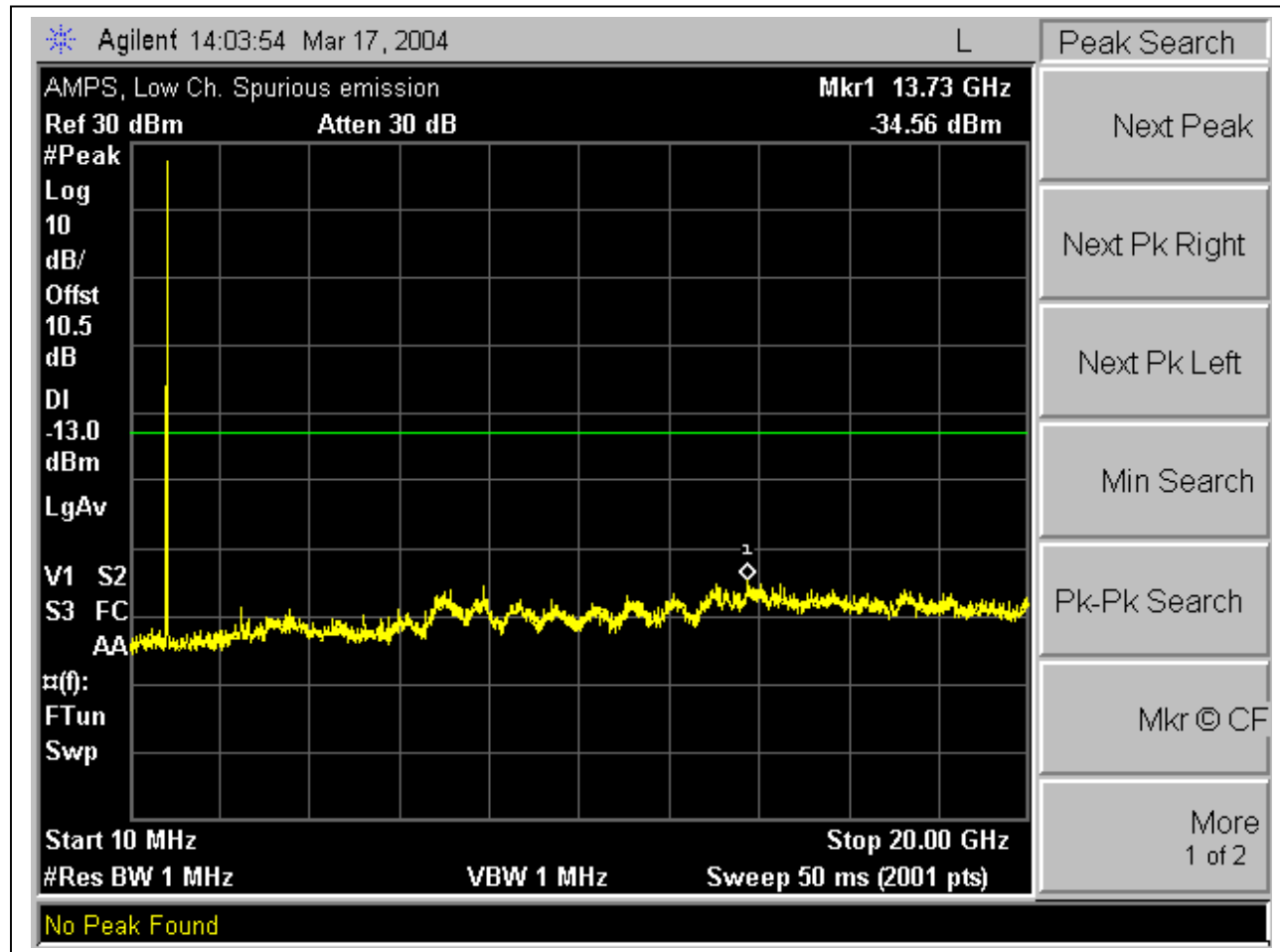

AMPS Modulation: Mid Channel Out-Of-Band Emissions

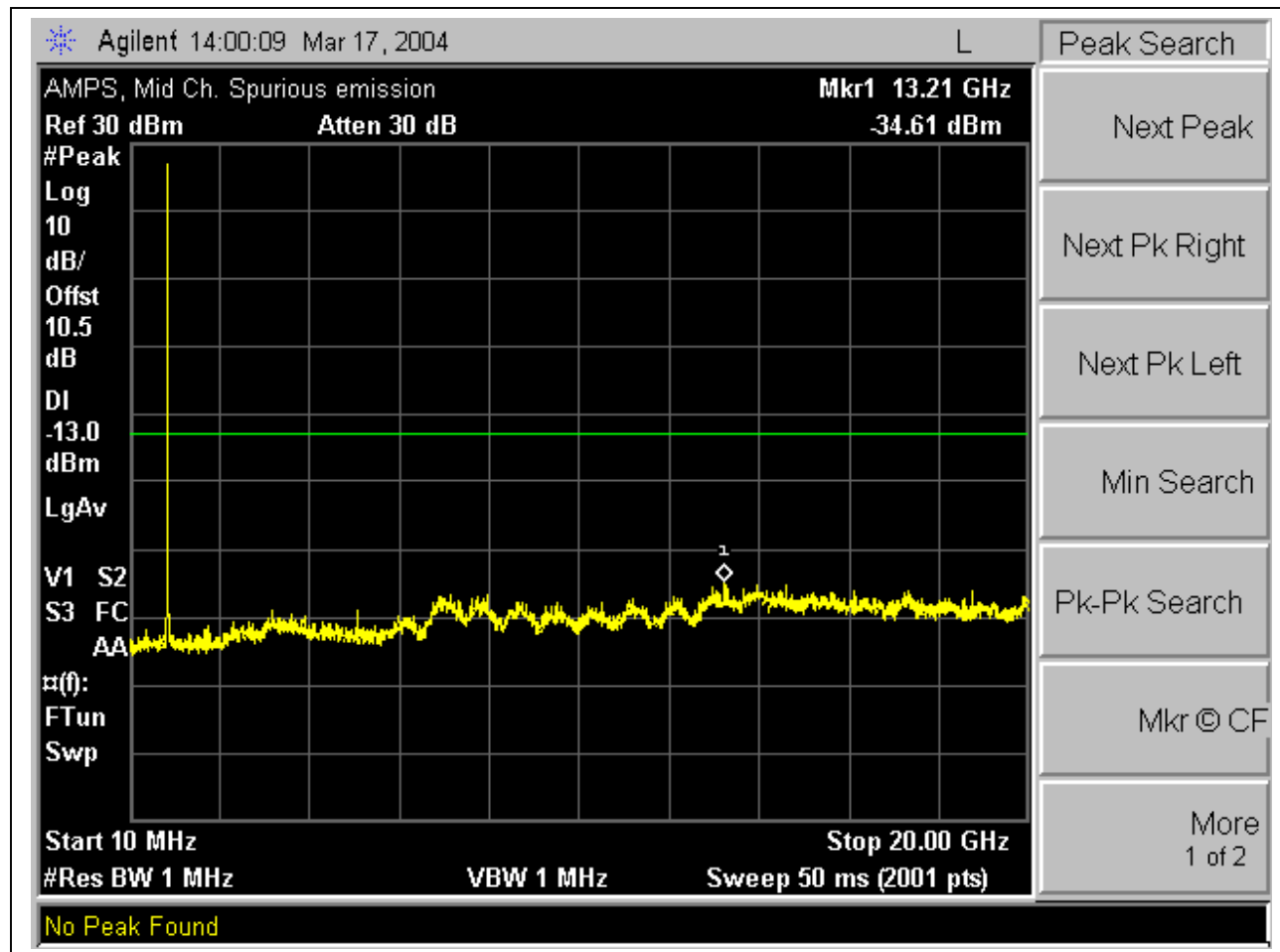

AMPS Modulation: High Channel Out-Of-Band Emissions

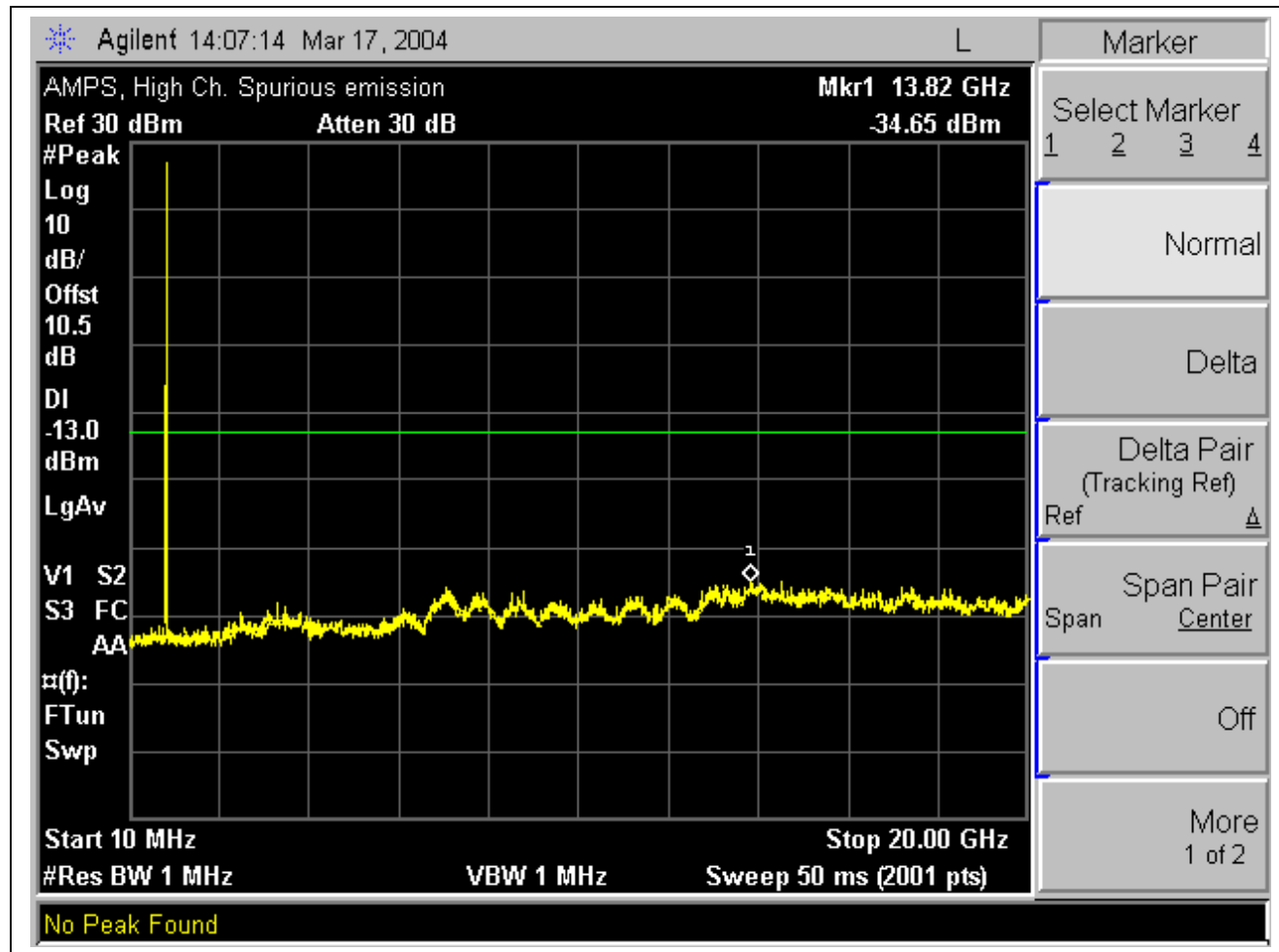

AMPS Mobile Emissions in Base Frequency Range:

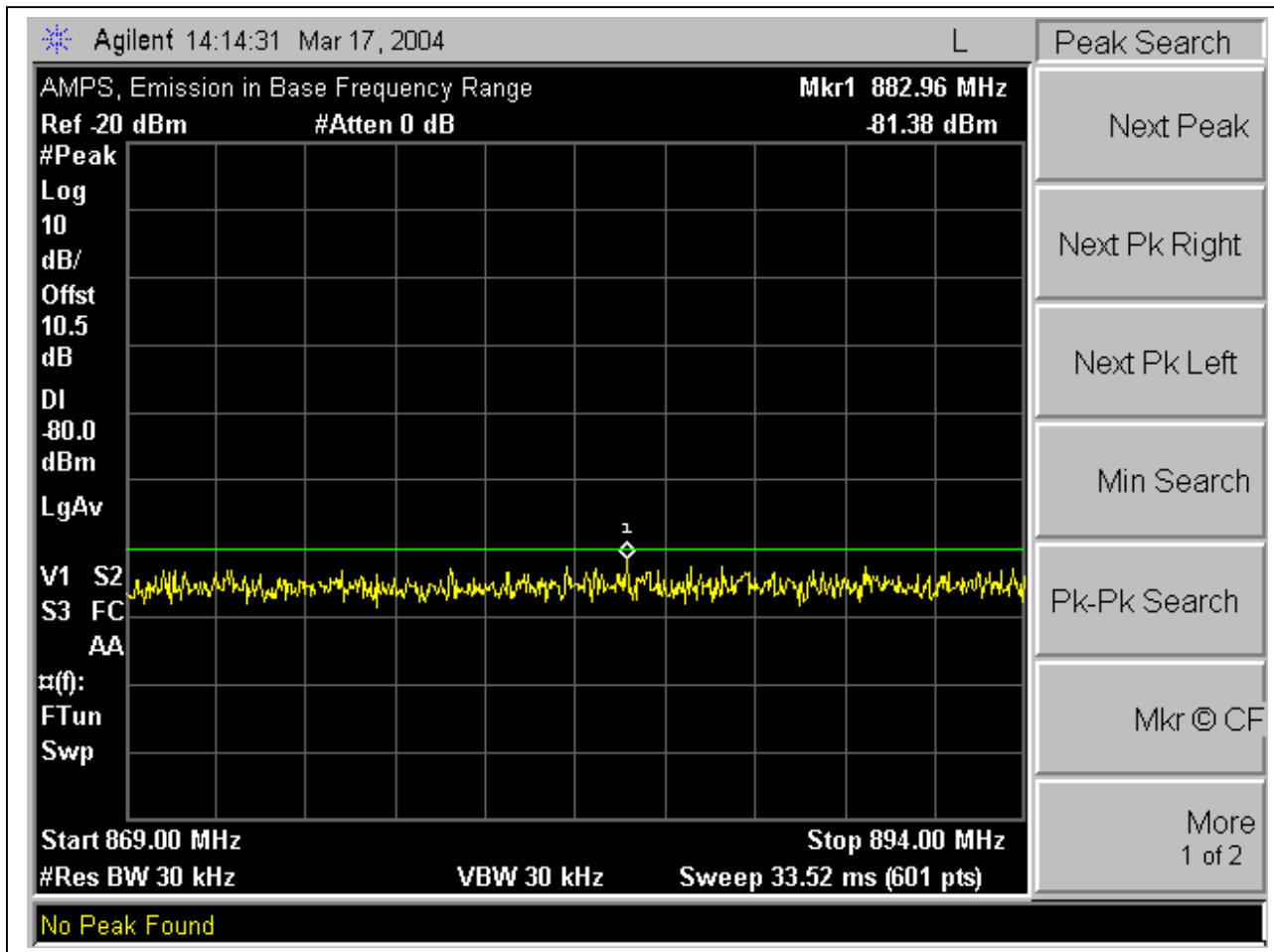

7.5. SECTION 2.1053: FIELD STRENGTH OF SPURIOUS RADIATION

INSTRUMENTS LIST

TEST EQUIPMENT LIST				
Name of Equipment	Manufacturer	Model No.	Serial No.	Due Date
Spectrum Analyzer, 26.5 GHz	HP	8593EM	3710A00205	10/1/2004
Amplifier 1-26GHz	MITEQ	NSP2600-SP	924342	4/25/2004
Antenna, Horn 1 ~ 18 GHz	EMCO	3115	9001-3245	2/4/2005

Detector Function Setting of Test Receiver

Frequency Range (MHz)	Detector Function	Resolution Bandwidth	Video Bandwidth
Above 1000	<input checked="" type="checkbox"/> Peak <input type="checkbox"/> Average	<input checked="" type="checkbox"/> 1 MHz <input type="checkbox"/> 1 MHz	<input checked="" type="checkbox"/> 1 MHz <input type="checkbox"/> 10 Hz

TEST SETUP

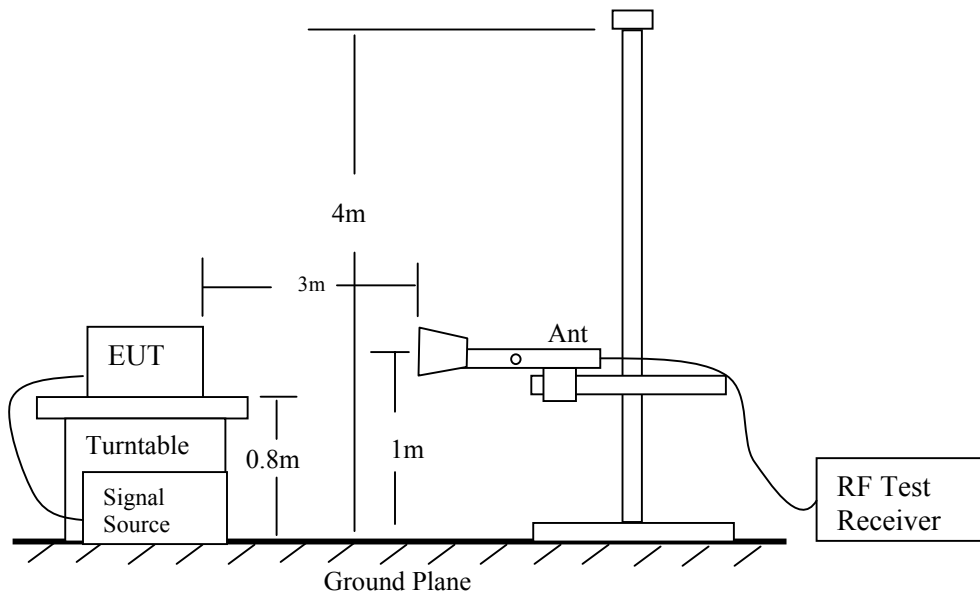

Fig 1: Radiated Emission Measurement

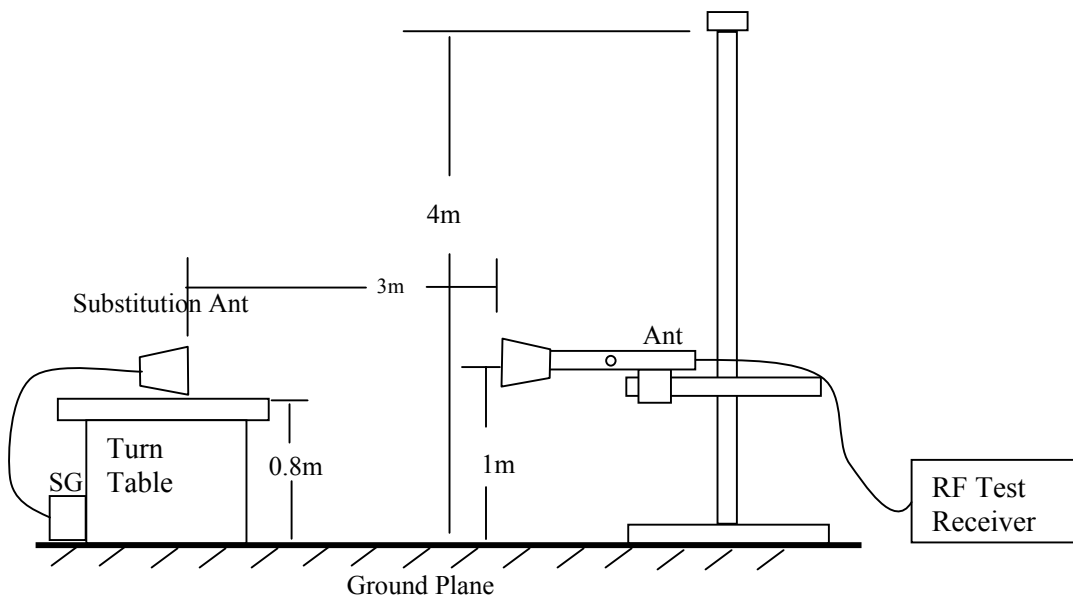

Fig 2: Radiated Emission – Substitution Method set-up

TEST PROCEDURE

- 1). On a test site, the EUT shall be placed on a turntable, and in the position closest to the normal use as declared by the user.
- 2). The test antenna shall be oriented initially for vertical polarization located 1m from the EUT to correspond to the frequency of the transmitter.
- 3). The output of the test antenna shall be connected to the measuring receiver and either a peak or average detector was used for the measurement as indicated on the report. The detector selection is based on how close the emission level was approaching the limit.
- 4). The transmitter shall be switched on, if possible, without the modulation and the measurement receiver shall be tuned to the frequency of the transmitter under test.
- 5). The test antenna shall be raised and lowered through the specified range of height until a maximum signal level is detected by the measuring receiver.
- 6). The transmitter shall then be rotated through 360° in the horizontal plane, until the maximum signal level is detected by the measuring receiver.
- 7). The test antenna shall be raised and lowered again through the specified range of height until a maximum signal level is detected by the measuring receiver.
- 8). The maximum signal level detected by the measuring receiver shall be noted.
- 9). The transmitter shall be replaced by a substitution antenna.
- 10). The substitution antenna shall be oriented for vertical polarization.
- 11). The substitution antenna shall be connected to a calibrated signal generator.
- 12). If necessary, the input attenuator setting of the measuring receiver shall be adjusted in order to increase the sensitivity of the measuring receiver.
- 13). The test antenna shall be raised and lowered through the specified range of the height to ensure that the maximum signal is received.
- 14). The input signal to the substitution antenna shall be adjusted to the level that produces a level detected by the measuring receiver, that is equal to the level noted while the transmitter radiated power was measured, corrected for the change of input attenuation setting of the measuring receiver.
- 15). The input level to the substitution antenna shall be recorded as power level in dBm, corrected for any change of input attenuator setting of the measuring receiver.
- 16). The measurement shall be repeated with the test antenna and the substitution antenna oriented for horizontal polarization.
- 17). The measure of the effective radiated power is the larger of the two levels recorded, at the input to the substitution antenna, corrected for the gain of the substitution antenna if necessary.

RESULT

No non-compliance noted, as shown below

CDMA: Low, Mid, & High Channels:

f GHz	Dist feet	Read Pk dBuV	Read Avg. dBuV	AF dB/m	CL dB	Amp dB	D Corr dB	HPF	Peak dBuV/m	Avg dBuV/m	Pk Lim dBuV/m	Avg Lim dBuV/m	Pk Mar dB	Avg Mar dB	Notes
CDMA, Low Ch. 824.7MHz, Y position															
1.649	9.8	62.5	51.6	27.1	1.7	-43.3	0.0	1.0	49.0	38.1	74.0	54.0	-25.0	-15.9	V
1.649	9.8	56.3	43.1	27.1	1.7	-43.3	0.0	1.0	42.8	29.6	74.0	54.0	-31.2	-24.4	H
2.474	9.8	55.3	38.7	30.0	2.3	-43.2	0.0	1.0	45.3	28.8	74.0	54.0	-28.7	-25.2	V
2.474	9.8	56.3	37.7	30.0	2.3	-43.2	0.0	1.0	46.3	27.7	74.0	54.0	-27.7	-26.3	H
3.299	9.8	47.9	35.2	32.0	2.5	-43.4	0.0	1.0	39.9	27.2	74.0	54.0	-34.1	-26.8	V, Noise Floor
3.299	9.8	47.4	35.3	32.0	2.5	-43.4	0.0	1.0	39.5	27.4	74.0	54.0	-34.5	-26.6	H, Noise Floor
CDMA, Mid Ch. 835.89MHz, Y position															
1.672	9.8	55.1	44.4	27.2	1.7	-43.3	0.0	1.0	41.8	31.1	74.0	54.0	-32.2	-22.9	V
1.672	9.8	52.4	40.4	27.2	1.7	-43.3	0.0	1.0	39.0	27.0	74.0	54.0	-35.0	-27.0	H
2.508	9.8	48.3	36.1	30.1	2.3	-43.2	0.0	1.0	38.4	26.3	74.0	54.0	-35.6	-27.7	V
2.508	9.8	52.9	36.6	30.1	2.3	-43.2	0.0	1.0	43.0	26.8	74.0	54.0	-31.0	-27.2	H
3.344	9.8	48.0	35.2	32.1	2.5	-43.4	0.0	1.0	40.1	27.3	74.0	54.0	-33.9	-26.7	V, Noise Floor
3.344	9.8	48.0	35.3	32.1	2.5	-43.4	0.0	1.0	40.2	27.5	74.0	54.0	-33.8	-26.5	H, Noise Floor
CDMA, High Ch. 848.31MHz, Y position															
1.697	9.8	54.8	44.6	27.4	1.8	-43.3	0.0	1.0	41.6	31.4	74.0	54.0	-32.4	-22.6	V
1.697	9.8	53.2	42.9	27.4	1.8	-43.3	0.0	1.0	40.0	29.7	74.0	54.0	-34.0	-24.3	H
2.545	9.8	60.4	47.9	30.2	2.3	-43.2	0.0	1.0	50.7	38.2	74.0	54.0	-23.3	-15.8	V
2.545	9.8	56.6	43.7	30.2	2.3	-43.2	0.0	1.0	46.9	34.0	74.0	54.0	-27.1	-20.0	H
3.393	9.8	48.5	35.1	32.2	2.5	-43.5	0.0	1.0	40.7	27.3	74.0	54.0	-33.3	-26.7	V, Noise Floor
3.393	9.8	47.2	35.2	32.2	2.5	-43.5	0.0	1.0	39.4	27.4	74.0	54.0	-34.6	-26.6	H, Noise Floor

AMPS: Low, Mid, & High Channels:

f GHz	Dist feet	Read Pk dBuV	Read Avg. dBuV	AF dB/m	CL dB	Amp dB	D Corr dB	HPF	Peak dBuV/m	Avg dBuV/m	Pk Lim dBuV/m	Avg Lim dBuV/m	Pk Mar dB	Avg Mar dB	Notes
AMPS, Low Ch. 824.04MHz, X position															
1.648	9.8	57.1	53.7	27.1	1.7	-43.3	0.0	1.0	43.6	40.2	74.0	54.0	-30.4	-13.8	V
1.648	9.8	60.3	58.4	27.1	1.7	-43.3	0.0	1.0	46.8	44.9	74.0	54.0	-27.2	-9.1	H
2.472	9.8	61.0	59.2	30.0	2.2	-43.2	0.0	1.0	51.0	49.2	74.0	54.0	-23.0	-4.8	V
2.472	9.8	64.5	62.9	30.0	2.2	-43.2	0.0	1.0	54.5	53.0	74.0	54.0	-19.5	-1.0	H
3.296	9.8	47.3	37.2	32.0	2.5	-43.4	0.0	1.0	39.4	29.3	74.0	54.0	-34.6	-24.7	V, Noise Floor
3.296	9.8	46.6	34.6	32.0	2.5	-43.4	0.0	1.0	38.7	26.7	74.0	54.0	-35.3	-27.3	H, Noise Floor
AMPS, Mid Ch. 836.49MHz, X position															
1.673	9.8	57.1	54.3	27.3	1.7	-43.3	0.0	1.0	43.7	41.0	74.0	54.0	-30.3	-13.0	V
1.673	9.8	57.8	55.4	27.3	1.7	-43.3	0.0	1.0	44.4	42.0	74.0	54.0	-29.6	-12.0	H
2.510	9.8	47.9	35.9	30.1	2.3	-43.2	0.0	1.0	38.0	26.0	74.0	54.0	-36.0	-28.0	V
2.510	9.8	48.9	37.3	30.1	2.3	-43.2	0.0	1.0	39.0	27.5	74.0	54.0	-35.0	-26.5	H
3.346	9.8	47.1	35.8	32.1	2.5	-43.4	0.0	1.0	39.3	27.9	74.0	54.0	-34.7	-26.1	V, Noise Floor
3.346	9.8	46.6	35.0	32.1	2.5	-43.4	0.0	1.0	38.7	27.1	74.0	54.0	-35.3	-26.9	H, Noise Floor
AMPS, High Ch. 848.97MHz, X position															
1.678	9.8	54.0	50.0	27.3	1.7	-43.3	0.0	1.0	40.6	36.6	74.0	54.0	-33.4	-17.4	V
1.678	9.8	59.5	57.8	27.3	1.7	-43.3	0.0	1.0	46.2	44.5	74.0	54.0	-27.8	-9.5	H
2.547	9.8	53.7	49.0	30.2	2.3	-43.2	0.0	1.0	44.0	39.3	74.0	54.0	-30.0	-14.7	V
2.547	9.8	59.4	57.7	30.2	2.3	-43.2	0.0	1.0	49.6	48.0	74.0	54.0	-24.4	-6.0	H
3.396	9.8	47.8	35.1	32.2	2.6	-43.5	0.0	1.0	40.0	27.3	74.0	54.0	-34.0	-26.7	V, Noise Floor
3.396	9.8	47.6	35.7	32.2	2.6	-43.5	0.0	1.0	39.8	27.9	74.0	54.0	-34.2	-26.1	H, Noise Floor

7.6. SECTION 2.1055: FREQUENCY STABILITY

INSTRUMENTS LIST

TEST EQUIPMENT LIST				
Name of Equipment	Manufacturer	Model No.	Serial No.	Due Date
Spectrum Analyzer	HP	E4446A	US42510266	7/23/2004
Spectrum Analyzer, 26.5 GHz	HP	8593EM	3710A00205	10/1/2004
Temperature / Humidity Chamber	Thermotron	SE 600-10-10	29800	4/26/2004

Detector Function Setting of Test Receiver

Frequency Range (MHz)	Detector Function	Resolution Bandwidth	Video Bandwidth
800-1000	Peak	300 Hz	300 Hz

TEST SETUP

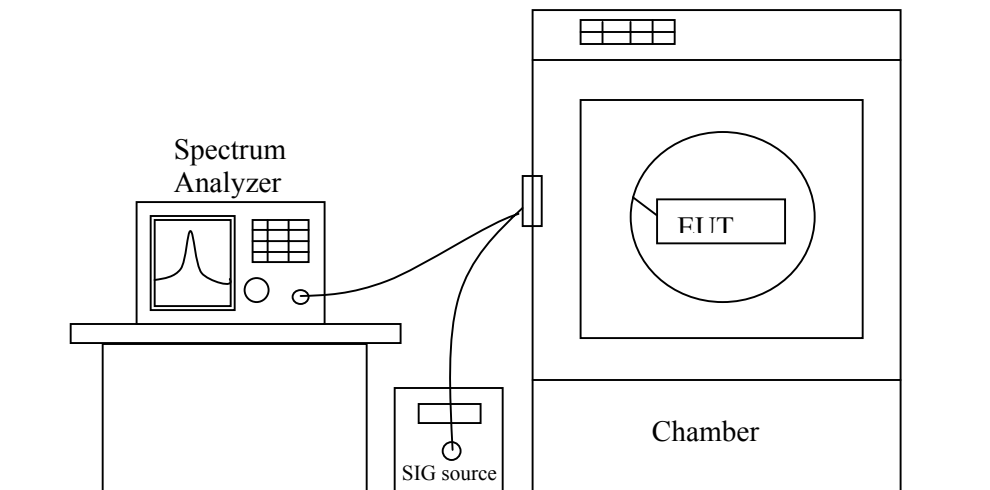
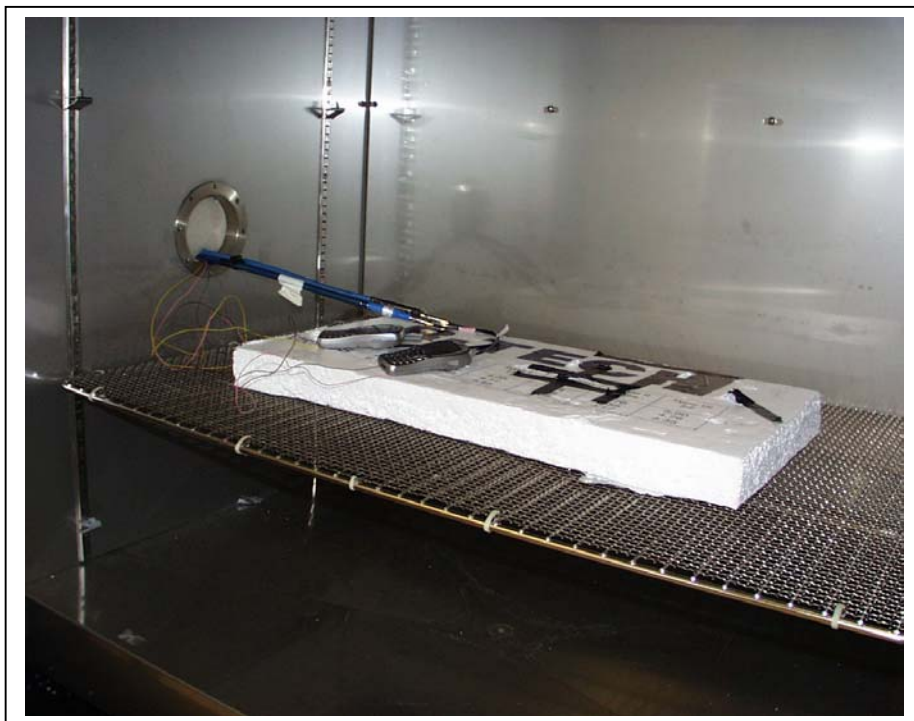

Fig. 3: Frequency Stability Setup

Test Setup Photos



TEST PROCEDURE

- **Frequency stability versus environmental temperature**

- 1). Setup the configuration per figure 6 for frequencies measurement inside the environmental chamber. Set the temperature of the chamber to 25°C. Set SA Resolution Bandwidth low enough to obtain the desired frequency resolution and measure the EUT 25°C operating frequency as reference frequency.
- 2). Turn EUT off and set Chamber temperature to -30°C.
- 3). Allow sufficient time (approximately 20 to 30 minus after chamber reach the assigned temperature) for EUT to stabilize. Turn on EUT and measure the EUT operating frequency. Turn off EUT after the measurement.
- 4). Repeat step 3 with a 10°C increased per stage until the highest temperature of +50°C reached, record all measured frequencies on each temperature step.

- **Frequency stability versus AC input voltage**

- 1). Setup the configuration per figure 6 and set chamber temperature to 25°C. Use a variable AC power supply to power the EUT and set AC output voltage to EUT nominal input AC voltage. Set SA Resolution Bandwidth low enough to obtain the desired frequency resolution and measure the EUT 25°C operating frequency as reference frequency.
- 2). Slowly reduce the EUT input voltage to specified extreme voltage variation ($\pm 15\%$) and record the maximum frequency change.

RESULT

No non-compliance noted, as shown below because the EUT uses the same OSC in both receiver and transmitter LO circuit. As a result, the frequency does not shift in Frequency Stability Test.

Frequency stability versus environmental temperature

Reference Frequency: AMPS Mid Channel 836.490000MHz @ 25°C				
Limit: to stay ± 2.5 ppm = 2091.241 Hz				
Power Supply (Vdc)	Environment Temperature (°C)	Frequency Deviation Measured with Time Elapse		
		(MHz)	Delta (ppm)	Limit (ppm)
4.20	50	836.49625	0.412	± 2.5
4.20	40	836.49652	0.090	± 2.5
4.20	30	836.49674	-0.179	± 2.5
4.20	25	836.49659	0	± 2.5
4.20	20	836.49664	-0.060	± 2.5
4.20	10	836.49646	0.161	± 2.5
4.20	0	836.49625	0.406	± 2.5
4.20	-10	836.49608	0.616	± 2.5
4.20	-20	836.49587	0.867	± 2.5
4.20	-30	836.49544	1.381	± 2.5
3.50 (end point)	25	836.49665	-0.068	± 2.5
3.57	25	836.49665	-0.066	± 2.5
4.83	25	836.49671	-0.137	± 2.5

Reference Frequency: CDMA Mid Channel 835.890000MHz @ 25°C				
Limit: to stay ± 2.5 ppm = 2091.446 Hz				
Power Supply (Vdc)	Environment Temperature (°C)	Frequency Deviation Measured with Time Elapse		
		(MHz)	Delta (ppm)	Limit (ppm)
4.20	50	836.57858	-0.185	± 2.5
4.20	40	836.57879	-0.436	± 2.5
4.20	30	836.57851	-0.105	± 2.5
4.20	25	836.57842	0	± 2.5
4.20	20	836.57868	-0.306	± 2.5
4.20	10	836.57834	0.102	± 2.5
4.20	0	836.57846	-0.049	± 2.5
4.20	-10	836.57843	-0.011	± 2.5
4.20	-20	836.57833	0.112	± 2.5
4.20	-30	836.57828	0.16735	± 2.5
3.50 (end point)	25	836.57846	-0.04542	± 2.5
3.57	25	836.57846	-0.049	± 2.5
4.83	25	836.57845	-0.03467	± 2.5

7.7. RADIATED EMISSION

Detector Setting of Spectrum Analyzer

Frequency Range (MHz)	Detector Function	Resolution Bandwidth	Video Bandwidth
30 to 1000	<input checked="" type="checkbox"/> Peak	<input checked="" type="checkbox"/> 100 KHz	<input checked="" type="checkbox"/> 100 KHz
	<input checked="" type="checkbox"/> Quasi Peak	<input checked="" type="checkbox"/> 1 MHz	<input checked="" type="checkbox"/> 1 MHz

TEST SETUP

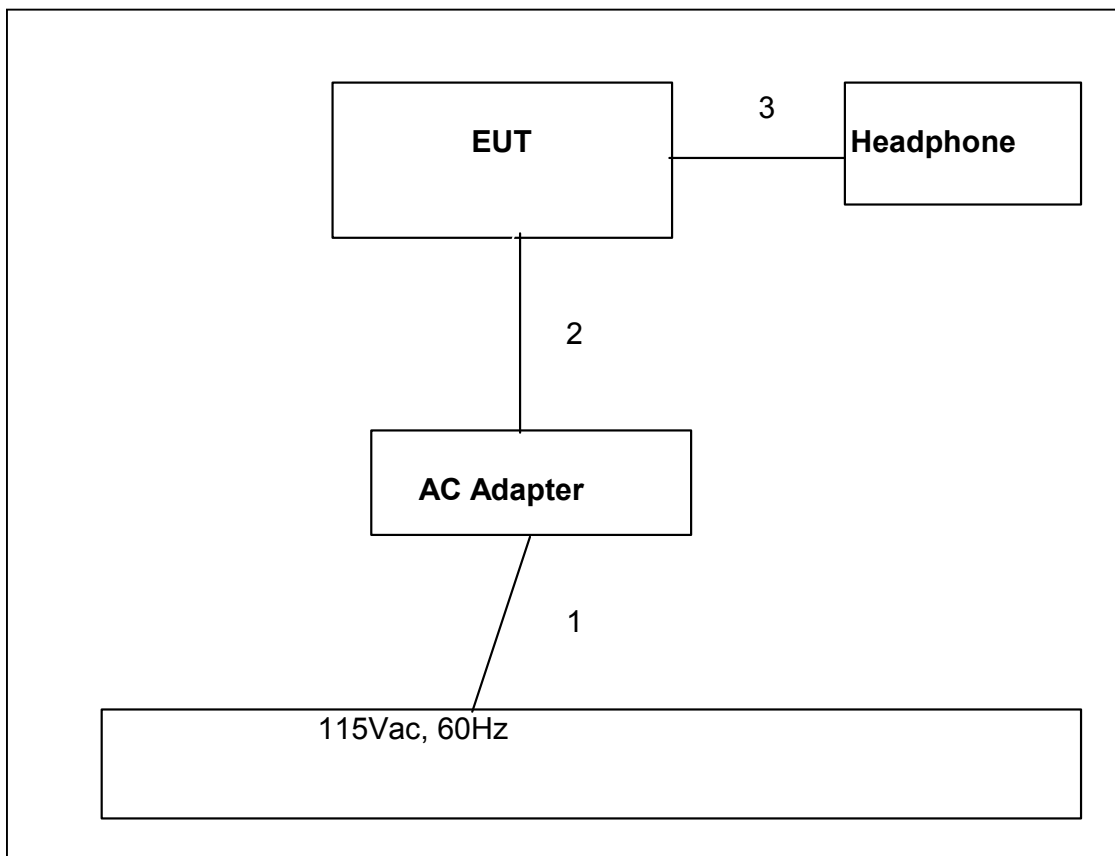

Test Setup Photos



TEST PROCEDURE

1. The EUT was placed on the turn table 0.8 meter above ground inside 3 meter Anechoic Chamber.
2. Set the resolution bandwidth to 120KHz in the test receiver and select Peak function to scan the frequency below 1 GHz.
3. Shift the interference-receiving antenna located in antenna tower upwards and downwards between 1 and 4 meters above ground and find out the local peak emission on frequency domain.
4. Locate the interference-receiving antenna at the position where the local peak reach the maximum emission.
5. Rotate the turn table and stop at the angle where the measurement device has maximum reading
6. Shift the interference-receiving antenna again to detect the maximum emission of the local peak
7. If the reading of the local peak under Peak function is lower than limit by 6dB, then Quasi Peak detection is not needed and this reading should be recorded. And if it is higher than Peak limit, then the test is fail. Others, switch the receiver to Quasi Peak function, set the resolution bandwidth to 100kHz and repeat the procedures (3)~(6). If the reading is lower than limit, this reading should be recorded, otherwise, the test is fail.

MEASUREMENT RESULT

No non-compliance noted, as shown below.



561F Monterey Road
 San Jose, CA 95131
 Tel: (408) 463-0888
 Fax: (408) 463-0885

Data#: 4 File#: Compal.EMI Date: 03-19-2004 Time: 21:55:50

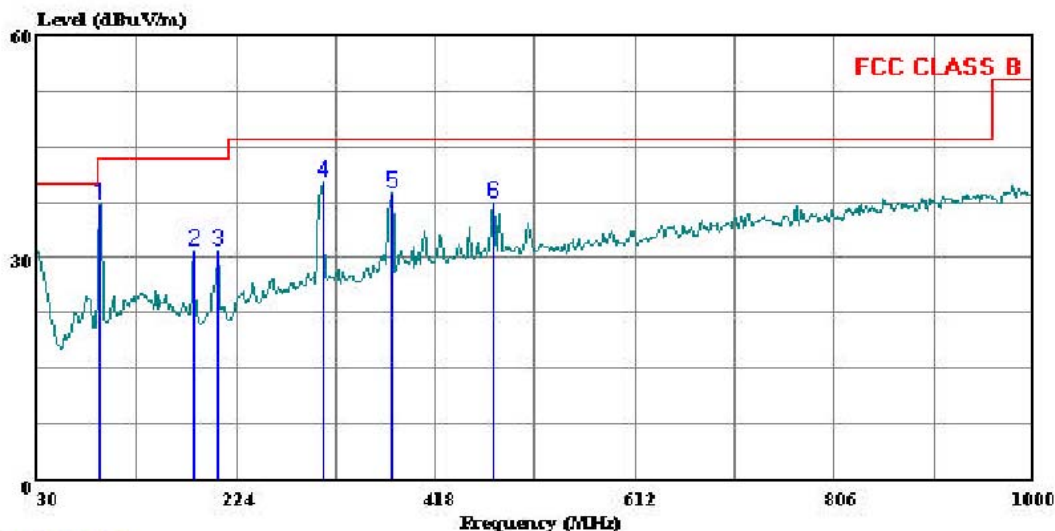

(Auxiliary ATC)

Trace: 3

Ref Trace:

Condition: FCC CLASS B HORIZONTAL
 Test Operator: : Chin Pang
 Project #: : 04I2555-1
 Company: : Compal Electronic Inc.
 EUT: : Single Band 800MHz Dual Mode AMPS/
 : CDMA Cellular Phone
 Model No: : VC-5D
 Configuration: : EUT / Support Equipment
 Target of Test: : FCC Class B
 Mode of Operation: Communication Link

Page: 1

	Freq	Remark	Read Level	Read Factor	Limit Level	Limit Line	Over Limit
	MHz		dBuV	dB	dBuV/m	dBuV/m	dB
1	91.110	Peak	28.10	9.01	37.11	43.50	-6.40
2	182.290	Peak	17.93	12.94	30.87	43.50	-12.63
3	206.540	Peak	17.26	13.61	30.87	43.50	-12.63
4	308.390	Peak	24.29	16.07	40.36	46.00	-5.64
5	376.290	Peak	21.03	17.64	38.67	46.00	-7.33
6	473.290	Peak	17.55	19.98	37.53	46.00	-8.47



561F Monterey Road
 San Jose, CA 95131
 Tel: (408) 463-0888
 Fax: (408) 463-0885

Data#: 2 File#: Compal.EMI Date: 03-19-2004 Time: 21:43:34

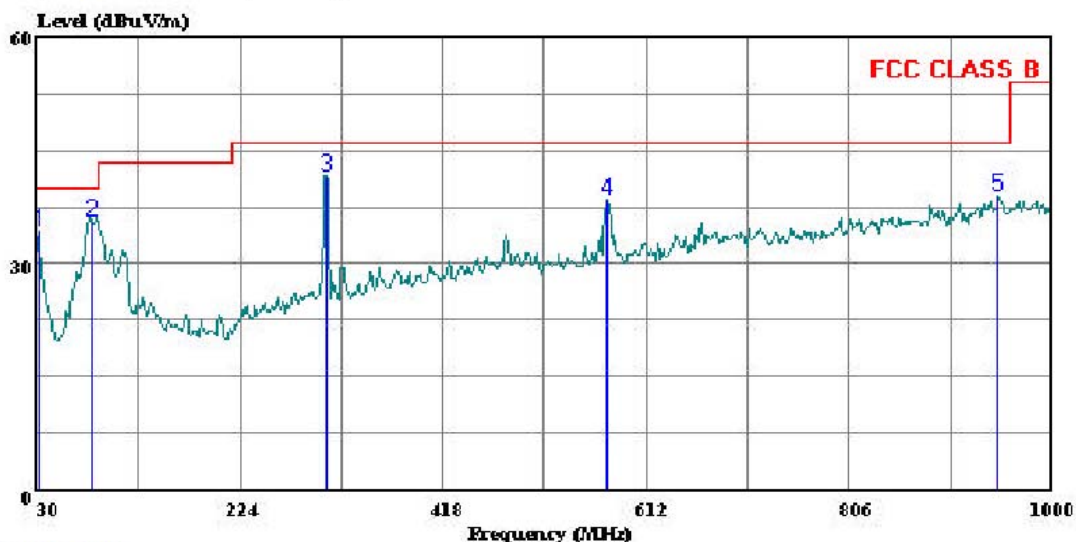

(Audix A TC)

Trace: 1

Ref Trace:

Condition: FCC CLASS B VERTICAL
 Test Operator: : Chin Pang
 Project #: : 04I2555-1
 Company: : Compal Electronic Inc.
 EUT: : Single Band 800MHz Dual Mode AMPS/
 : CDMA Cellular Phone
 Model No: : VC-5D
 Configuration: : EUT / Support Equipment
 Target of Test: : FCC Class B
 Mode of Operation: Communication Link

Page: 1

	Freq	Remark	Read Level	Factor	Limit Level	Over Limit
	MHz		dBuV	dB	dBuV/m	dB
1	31.940	Peak	12.11	22.06	34.17	-5.83
2	82.380	Peak	26.32	9.23	35.55	-4.45
3	306.450	Peak	25.43	16.04	41.47	-4.53
4	575.140	Peak	16.52	21.84	38.36	-7.65
5	948.590	Peak	12.18	26.88	39.06	-6.94

7.8. POWERLINE CONDUCTED EMISSION

Detector Function Setting of Test Receiver

Frequency Range (MHz)	Detector Function	Resolution Bandwidth	Video Bandwidth
150 KHz to 30 MHz	<input checked="" type="checkbox"/> Peak <input type="checkbox"/> CISPR Quasi Peak	<input checked="" type="checkbox"/> 9 KHz	<input checked="" type="checkbox"/> 9 KHz

TEST SETUP

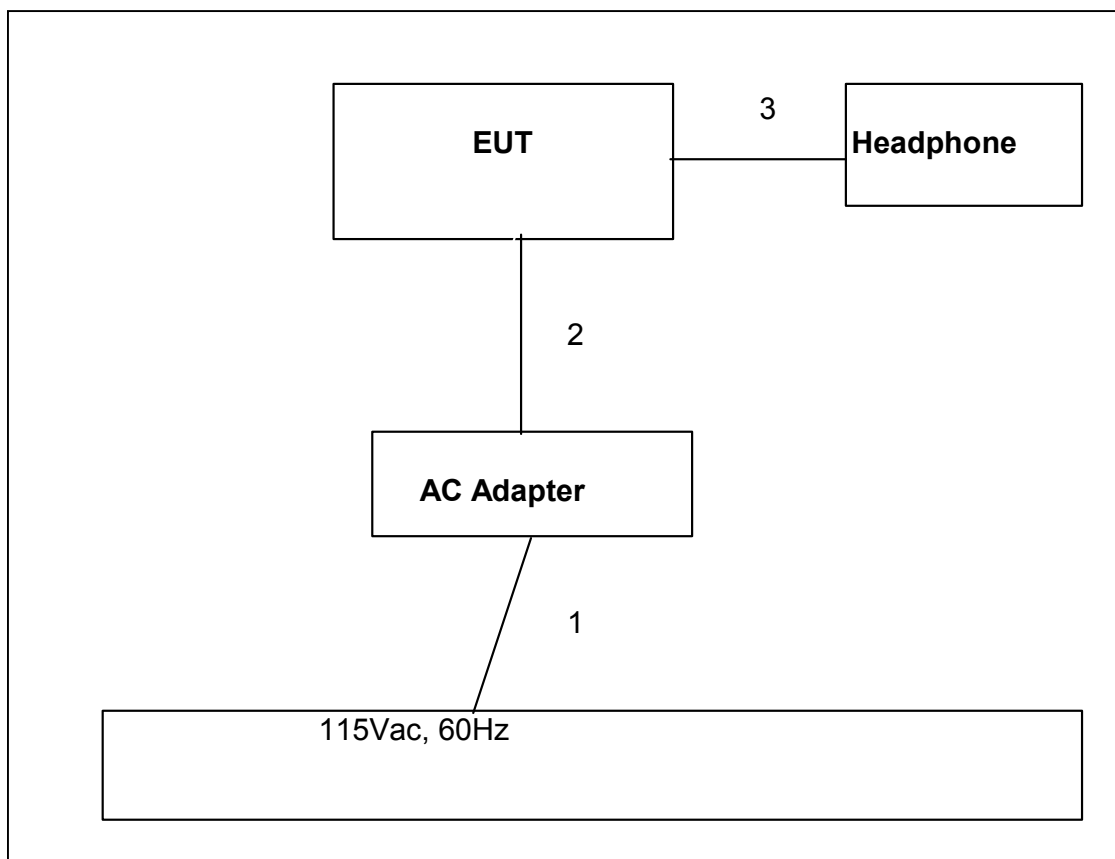

Test Setup Photos



TEST PROCEDURE

1. The EUT was placed on a wooden table 40 cm from a vertical ground plane and approximately 80 cm above the horizontal ground plane on the floor. The EUT was set to transmit in a continuous mode.
2. Line conducted data was recorded for both NEUTRAL and HOT lines.

MEASUREMENT RESULT

No non-compliance noted, as shown below.



561F Monterey Road,
San Jose, CA 95037 USA
Tel: (408) 463-0885
Fax: (408) 463-0888

Data#: 7 File#: 2555LC.EMI Date: 03-19-2004 Time: 19:20:37
Compliance Certification Service

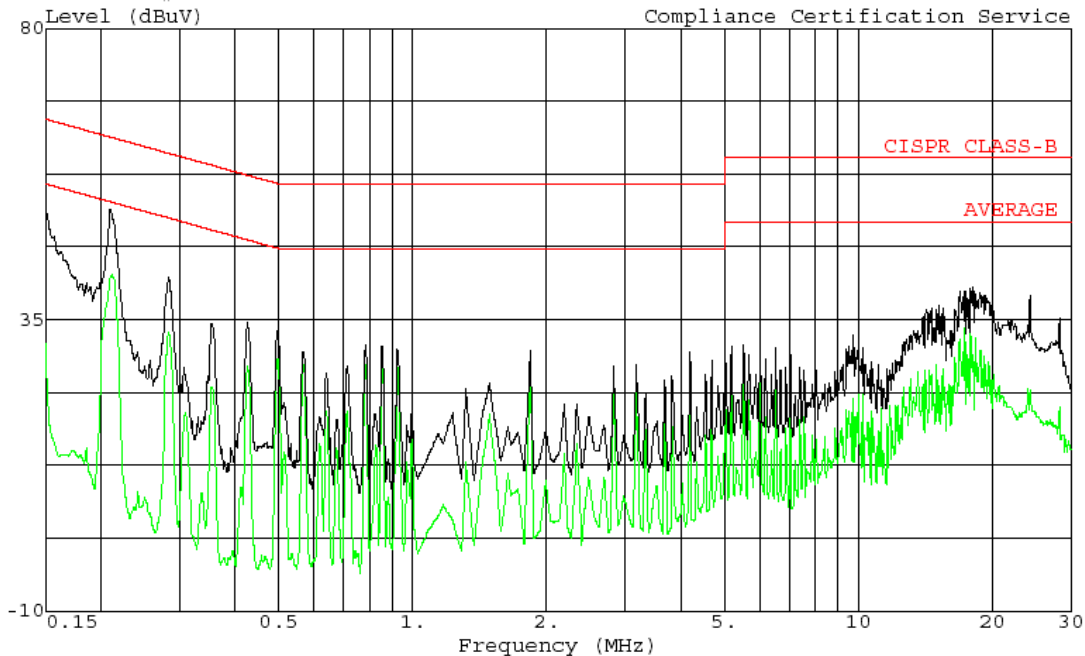

Trace: 5
Project # : 04I2555-1
Test Operator : Chin Pang
Company : Compal Electronic Inc
EUT : Single Band 800 MHz Dual Mode AMPS/CDMA
Cellular Camera Phone
Model : VC-5D
Configuration : EUT / Support Equipment
Mode of Operation: Communication Link
Target of Test : FCC Class B
Voltage : 115 VAC / 60 Hz
Ref Trace: : LINE 1: PEAK (Black), Average (Green)



561F Monterey Road,
San Jose, CA 95037 USA
Tel: (408) 463-0885
Fax: (408) 463-0888

Data#: 14 File#: 2555LC.EMI Date: 03-19-2004 Time: 19:36:53
Level (dBuV) Compliance Certification Service

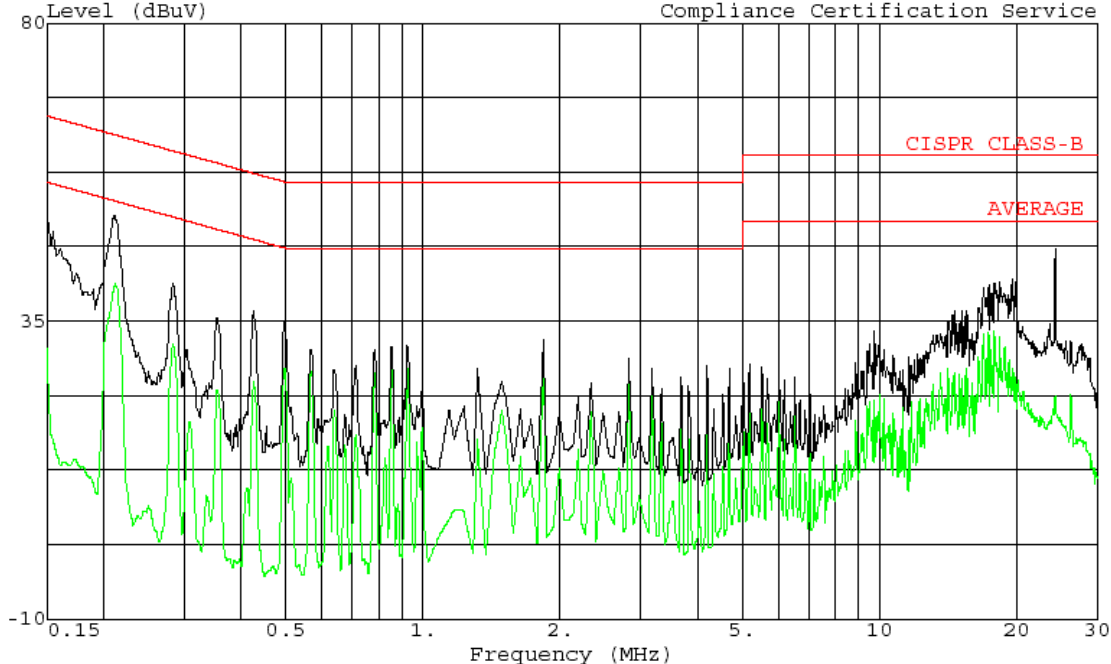

Trace: 12 Ref Trace:
Project # : 04I2555-1
Test Operator : Chin Pang
Company : Compal Electronic Inc
EUT : Single Band 800 MHz Dual Mode AMPS/CDMA
Cellular Camera Phone
Model : VC-5D
Configuration : EUT / Support Equipment
Mode of Operation: Communication Link
Target of Test : FCC Class B
Voltage : 115 VAC / 60 Hz
LINE 2: PEAK (Black), Average (Green)

8. APENDIX

8.1. EXTERNAL & INTERNAL PHOTOS



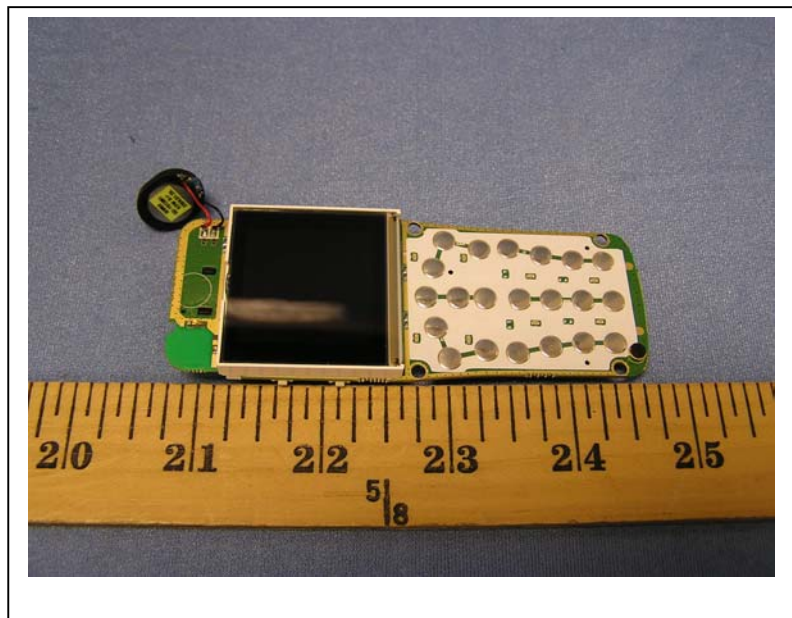

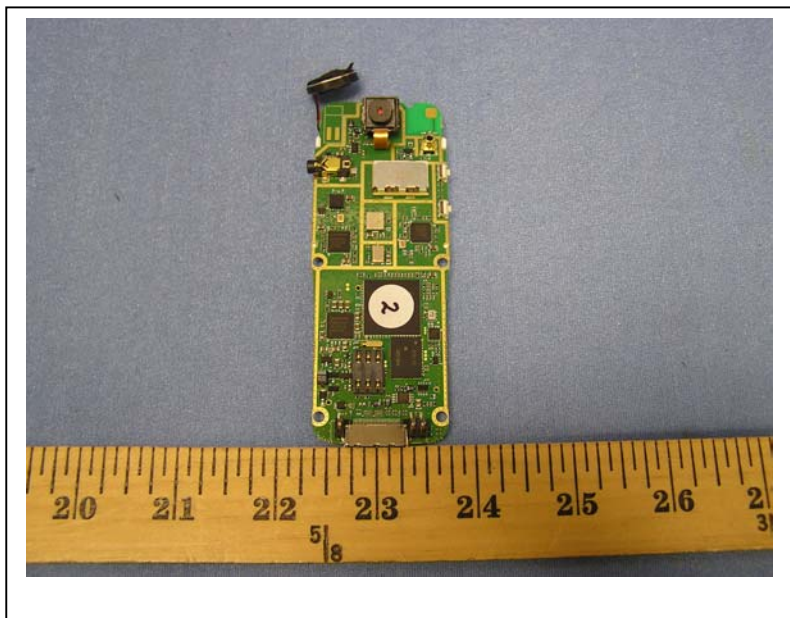
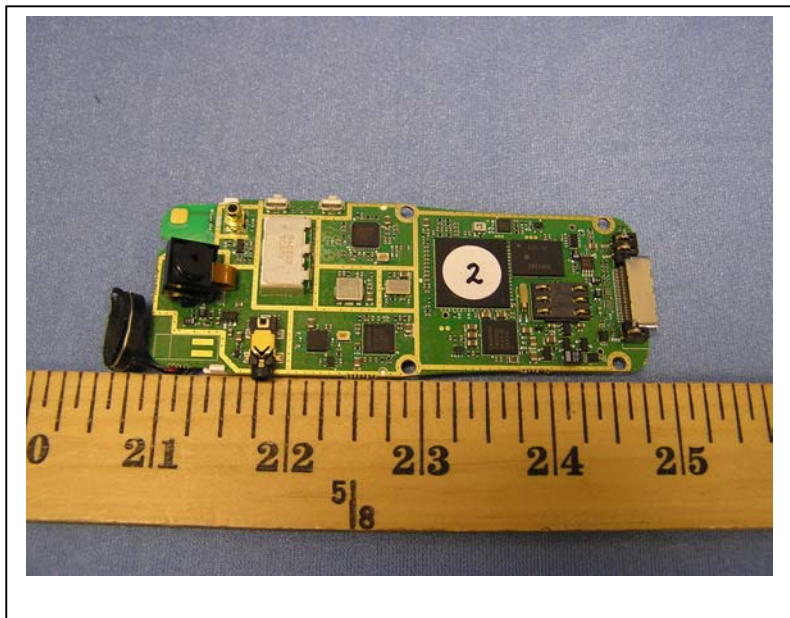



8.2. SCHEMATICS

Please refer to attached sheets.

8.3. BLOCK DIAGRAM

Please refer to attached sheets.

8.4. USER MANUAL

Please refer to attached sheets.

END OF REPORT