

## FCC TEST REPORT

for

**47 CFR Part 24E**

**Equipment** : GSM Mobile Phone  
**Trade Name** : Palmax  
**Model No.** : TGH  
**FCC ID** : GKRTGH  
**Tx Frequency Range** : 1850.2~1909.8MHz  
**Max. RF Output Power** : 0.45W  
**Emission Designator** : 300 KGXW  
**Applicant** : **Compal Electronics, Inc.**  
No. 581, Juikuang Rd., Neihu, Taipei, (114)  
Taiwan, R.O.C.

- The test result refers exclusively to the test presented test model / sample.
- Without written approval of SPORTON International Inc., the test report shall not be reproduced except in full.
- **Certificate or Test Report must not be used by the applicant to claim the product in this test report endorsement by NVLAP or any agency of U.S. government.**
- The data shown in this test report were carried out on Dec. 09, 2004 at **Sporton International Inc. LAB.**

*Daniel Lee 12/13/2004*

Dr. Daniel Lee  
EMC/SAR Manager

**SPORTON International Inc.**

6F, No.106, Sec. 1, Hsin Tai Wu Rd., Hsi Chih, Taipei Hsien, Taiwan, R.O.C.

**SPORTON International Inc.**

TEL : 886-2-2696-2468

FAX : 886-2-2696-2255



# Table of Contents

**History of this test report.....ii**

**1. General Information ..... 1**

    1.1. Applicant..... 1

    1.2. Manufacturer..... 1

    1.3. Basic Description of Equipment under Test..... 1

    1.4. Feature of Equipment under Test..... 2

    1.5. Report Date ..... 2

**2 Test Configuration of Equipment under Test .....3**

    2.1 Test Manner..... 3

    2.2 Test Mode..... 3

    2.3 Connection Diagram of Test System ..... 4

    2.4 Ancillary Equipment List..... 4

**3. General Information of Test Site .....5**

    3.1 Test Voltage..... 5

    3.2 Test in Compliance with ..... 5

    3.3 Frequency Range Investigated..... 5

    3.4 Test Distance..... 5

**4. Test Data and Test Result.....6**

    4.1 List of Measurements and Examinations ..... 6

    4.2 RF Output Power ..... 7

    4.3 ERP / EIRP Measurement..... 8

    4.4 Occupied Bandwidth and Band Edge Measurement..... 10

    4.5 Conducted Emission ..... 15

    4.6 Field Strength of Spurious Radiation ..... 21

    4.7 Frequency Stability (Temperature Variation) ..... 25

    4.8 Frequency Stability (Voltage Variation) ..... 26

**5. List of Measurement Equipments .....27**

**6. Uncertainty Evaluation.....28**

**Appendix A. Photographs of EUT External**

**Appendix B. Photographs of EUT Internal**

**Appendix C. Photographs of Setup**



### History of this test report

Original Report Issue Date: Dec. 09, 2004

No additional attachment.

Additional attachment were issued as following record:

Attachment No.	Issue Date	Description



## **1. General Information**

### **1.1. Applicant**

**Compal Electronics, Inc.**

No. 581, Juikuang Rd., Neihu, Taipei, (114) Taiwan, R.O.C.

### **1.2 Manufacturer**

**Compal Electronics, Inc.**

No. 581, Juikuang Rd., Neihu, Taipei, (114) Taiwan, R.O.C.

### **1.3 Basic Description of Equipment under Test**

Equipment	: GSM Mobile Phone
Trade Name	: Palmax
Model No.	: TGH
FCC ID	: GKRTGH

**1.4 Feature of Equipment under Test**

<b>DUT Type :</b>	GSM Mobile Phone
<b>Trade Name :</b>	Palmax
<b>Model Name :</b>	TGH
<b>FCC ID :</b>	GKRTGH
<b>Tx Frequency :</b>	1850.2-1909.8MHz
<b>Rx Frequency :</b>	1930.2-1989.8MHz
<b>Antenna Type :</b>	Fixed Internal
<b>Maximum Output Power :</b>	0.708 W (28.5 dBm)
<b>Maximum EIRP</b>	0.45 W ( 26.553 dBm)
<b>HW Version :</b>	V1.0
<b>SW Version :</b>	W04.38.03
<b>Digital Modulation Emission :</b>	GMSK
<b>Type of Emission :</b>	300 KGXW
<b>DUT Stage :</b>	Production Unit

**1.5 Report Date**

EUT Received : Dec. 08, 2004

Report Date : Dec. 09, 2004



## 2 Test Configuration of Equipment under Test

### 2.1 Test Manner

- a. The spurious emission measurements were carried out in semi-anechoic chamber with 3-meter test range.
- b. During all testings, EUT is in link mode with base station emulator at maximum power level. (PCL=0 for PCS 1900)
- c. Frequency range investigated: radiated emission 30 MHz to 19000MHz.

### 2.2 Test Mode

Application	PCS 1900
Radiated Emission	<input checked="" type="checkbox"/> Mode 1: CH 661
Conducted Measurement	<input checked="" type="checkbox"/> Mode 1: CH 661

### 2.3 Connection Diagram of Test System

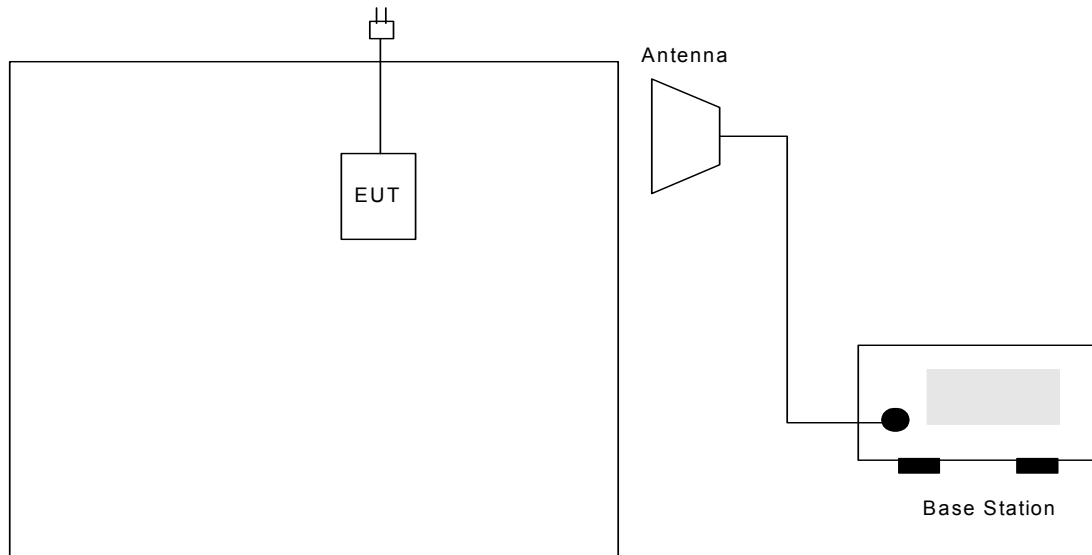

### 2.4 Ancillary Equipment List

Item	Equipment	Model No.	Serial No.
1.	Base Station	E5515C	GB43460754



### **3. General Information of Test Site**

Test Site Location : No. 52, Hwa Ya 1st Rd., Hwa Ya Technology Park,  
Kwei-Shan Hsiang, Tao Yuan Hsien, Taiwan, R.O.C.  
TEL : 886-3-327-3456  
FAX : 886-3-318-0055

Test Site No : 03CH06-HY

The chamber meets the characteristics of ANSI C63.4-2003. This site is on file with the FCC. The Industry Canada file number for this site is IC 4088.

#### **3.1 Test Voltage**

110V/ 60Hz

#### **3.2 Test in Compliance with**

47 CFR Part 24E and Part 2.

#### **3.3 Frequency Range Investigated**

a. Radiation: from 30 MHz to 19000 MHz for PCS 1900

#### **3.4 Test Distance**

The test distance of radiated emission from antenna to EUT is 3 m.



**4. Test Data and Test Result****4.1 List of Measurements and Examinations**

FCC Rule	IC RULE	DESCRIPTION OF TEST	Result	Section
§2.1046	RSS-133 §6.2	RF Output Power	Passed	4.2
§24.232	RSS-133 §6.2	EIRP	Passed	4.3
§2.1049, §24.238(b)	RSS-133 §6.3	Occupied Bandwidth & Band Edge Measurement	Passed	4.4
§2.1051	RSS-133 §6.3	Conducted Emission	Passed	4.5
§2.1053	RSS-133 §6.3	Field Strength of Spurious Radiation	Passed	4.6
§2.1055, §24.235	RSS-133 §7	Frequency Stability vs. Temperature	Passed	4.7
§2.1055, §24.235	RSS-133 §7	Frequency Stability vs. Voltage	Passed	4.8

## 4.2 RF Output Power

### 4.2.1 Measurement Instruments :

As described in chapter 5 of this test report.

### 4.2.2 Test Procedure :

1. The transmitter output was connected to power meter and base station through power divider.
2. Set EUT at PCL=0 for PCS 1900 through base station.
3. Select lowest, middle, and highest channels for each band.

### 4.2.3 Test Setup Layout :

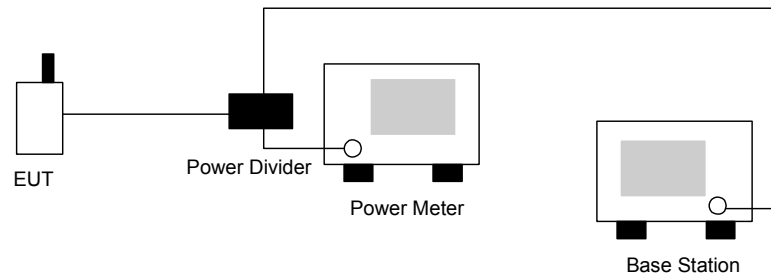

### 4.2.4 Test Result :

Bands	Channel	Frequency (MHz)	Conducted Power (dBm)	Conducted Power (Watts)
GSM 1900	512	1850.2 (Low)	28.5	0.708
	661	1880.0 (Mid)	28.4	0.692
	810	1909.8 (High)	28.2	0.661

### 4.3 ERP / EIRP Measurement

Equivalent isotropic radiated power measurements by substitution method according to ANSI/TIA/EIA-603-A.

#### 4.3.1 Measurement Instruments

As described in chapter 5 of this test report.

#### 4.3.2 Test Procedure

1. The EUT was placed on a rotatable wooden table with 0.8 meter about ground.
2. The EUT was set 3 meters from the receiving antenna which was mounted on the antenna tower.
3. The table was rotated 360 degrees to determine the position of the highest radiated power.
4. The height of the receiving antenna is varied between one meter and four meters to reach the maximum radiated power for both horizontal and vertical polarizations.
5. Taking the record of maximum ERP/EIRP.
6. A Horn antenna was substituted in place of the EUT and was driven by a signal generator.
7. The conducted power at the terminal of the Horn antenna is measured.
8. Repeat step 3 to step 5.

#### 4.3.3 Test Setup Layout of ERP/EIRP

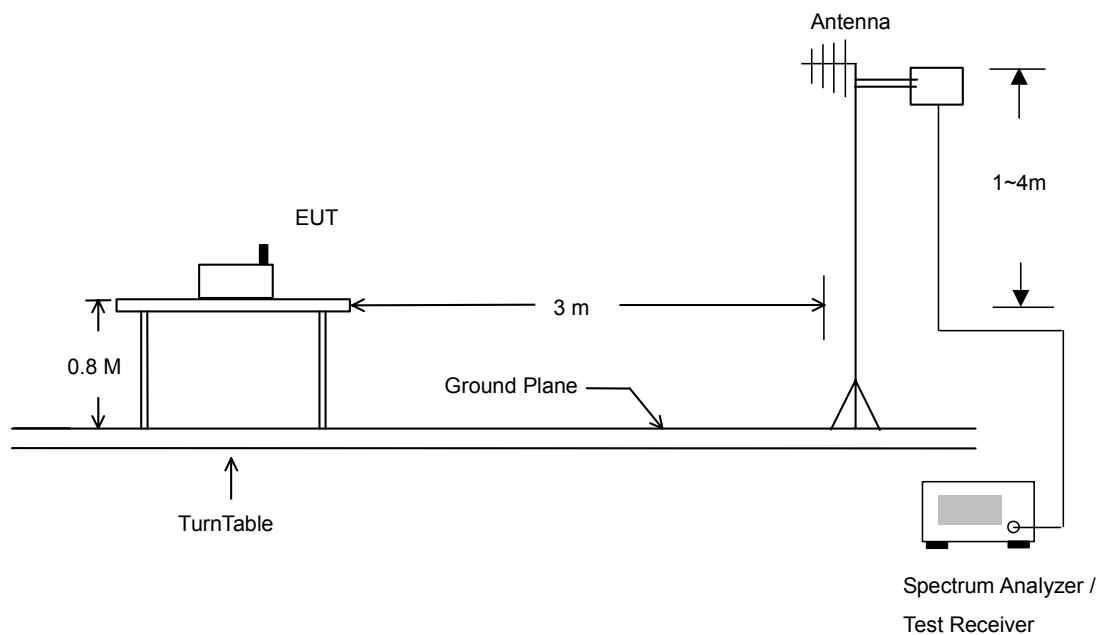



4.3.4 Test Result

<b>PCS1900 Radiated Power EIRP</b>					
<b>H Polarization</b>			<b>V Polarization</b>		
<b>Frequency (MHz)</b>	<b>EIRP (dBm)</b>	<b>EIRP (Watts)</b>	<b>Frequency (MHz)</b>	<b>EIRP (dBm)</b>	<b>EIRP (Watts)</b>
1850.140	23.224	0.21	1850.240	23.067	0.20
1879.990	26.553	0.45	1880.020	25.757	0.38
1909.740	23.174	0.21	1909.820	25.301	0.34

## 4.4 Occupied Bandwidth and Band Edge Measurement

### 4.4.1 Measurement Instruments

As described in chapter 5 of this test report.

### 4.4.2 Test Procedure

1. The EUT was connected to Spectrum Analyzer and Base Station via power divider.
2. The occupied bandwidth of middle channel for the highest and lowest RF powers were measured.
3. The bandedge of low and high channels for the highest RF powers within the transmitting frequency band were measured. Setting RBW as roughly  $BW/10$ .

### 4.4.3 Test Setup Layout

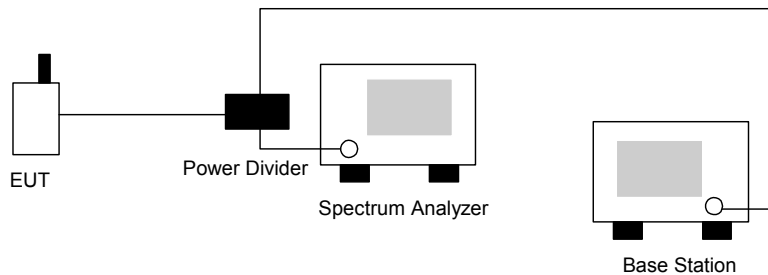



4.4.4 Test Result

- Test Mode : PCS 1900 CH661 Lower Band Edge
- Power State : High



Ref 30 dBm      \*Att 30 dB      \*RBW 3 kHz      Marker 1 [T1 ]  
 \*VBW 3 kHz      -18.86 dBm  
 \*SWT 300 ms      1.850000000 GHz

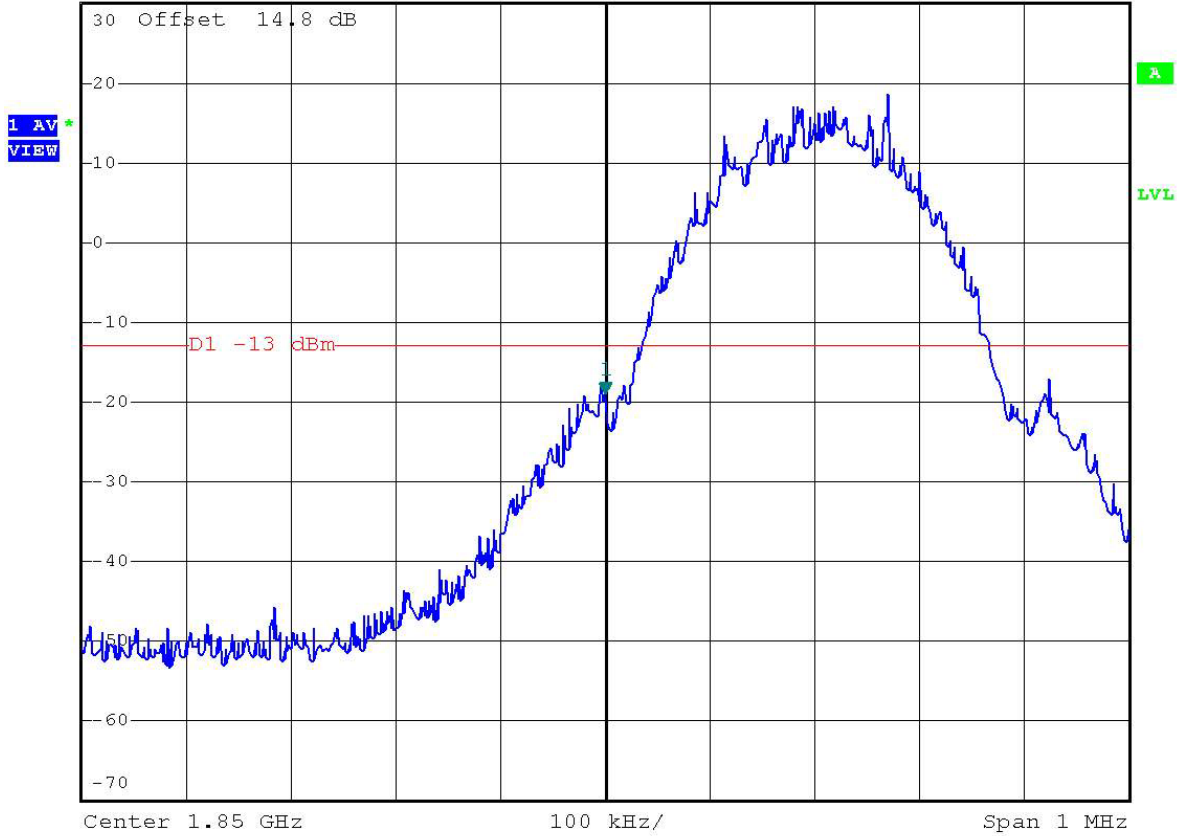

Date: 9.DEC.2004 03:21:33



- Test Mode : PCS 1900 CH661 99% Occupid Bandwidth
- Power State : Low

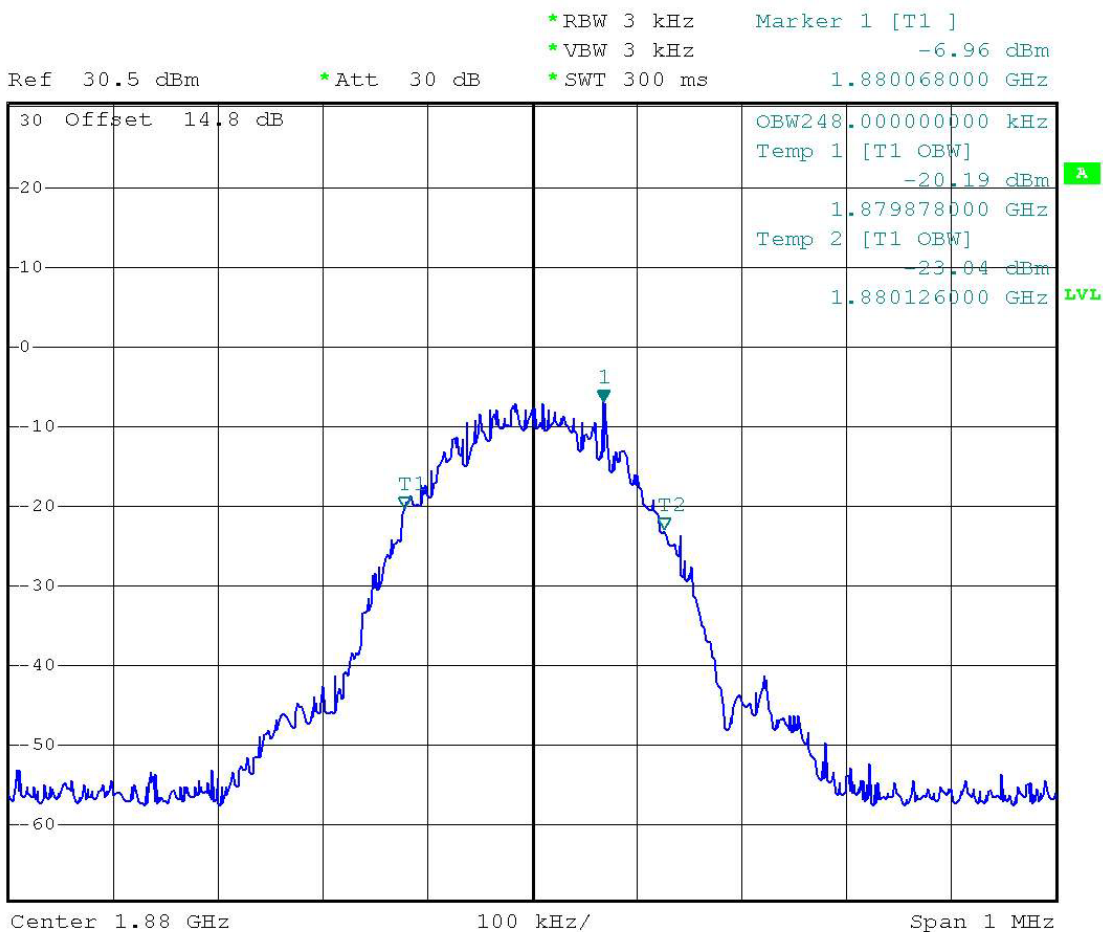

Date: 8.DEC.2004 23:08:29



- Test Mode : PCS 1900 CH661 99% Occupied Bandwidth
- Power State : High



Ref 30.5 dBm      \*Att 30 dB      \*RBW 3 kHz      Marker 1 [T1 ]      23.21 dBm  
 \*VBW 3 kHz      1.880070000 GHz  
 \*SWT 300 ms

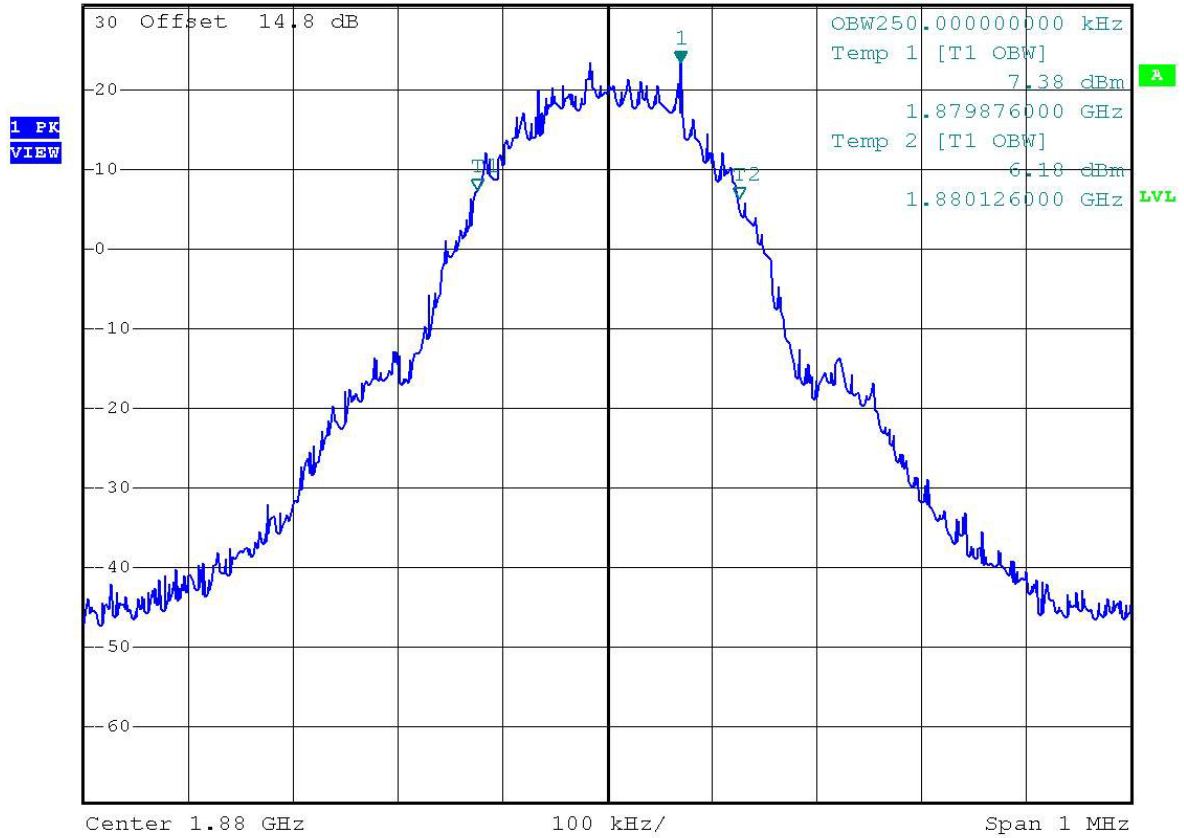

Date: 8.DEC.2004 23:07:39





**FCC TEST REPORT**

**Report No. : FG4D0806**

- Test Mode : PCS 1900 CH661 99% Occupied Band Edge
- Power State : High

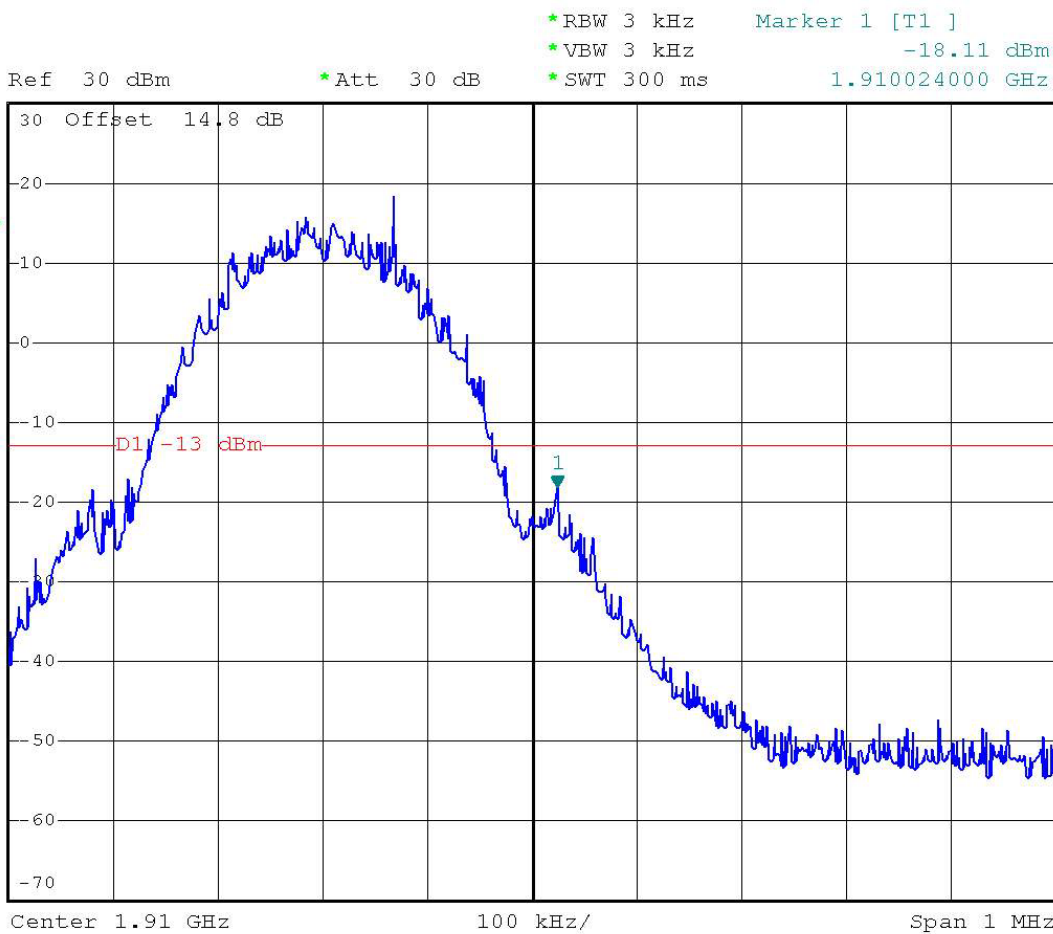

Date: 9.DEC.2004 03:20:25

## 4.5 Conducted Emission

### 4.5.1 Measurement Instruments

As described in chapter 5 of this test report.

### 4.5.2 Test Procedure

1. The EUT was connected to Spectrum Analyzer and Base Station via power divider.
2. The middle channel for the highest RF power within the transmitting frequency was measured.
3. The conducted spurious emission for the whole frequency range was taken.

### 4.5.3 Test Setup Layout

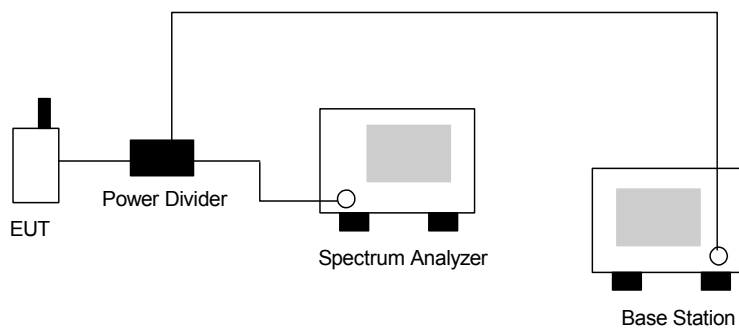



4.5.4 Test Result

- Test Mode : PCS 1900 CH661
- Frequency Range : 30M-1G

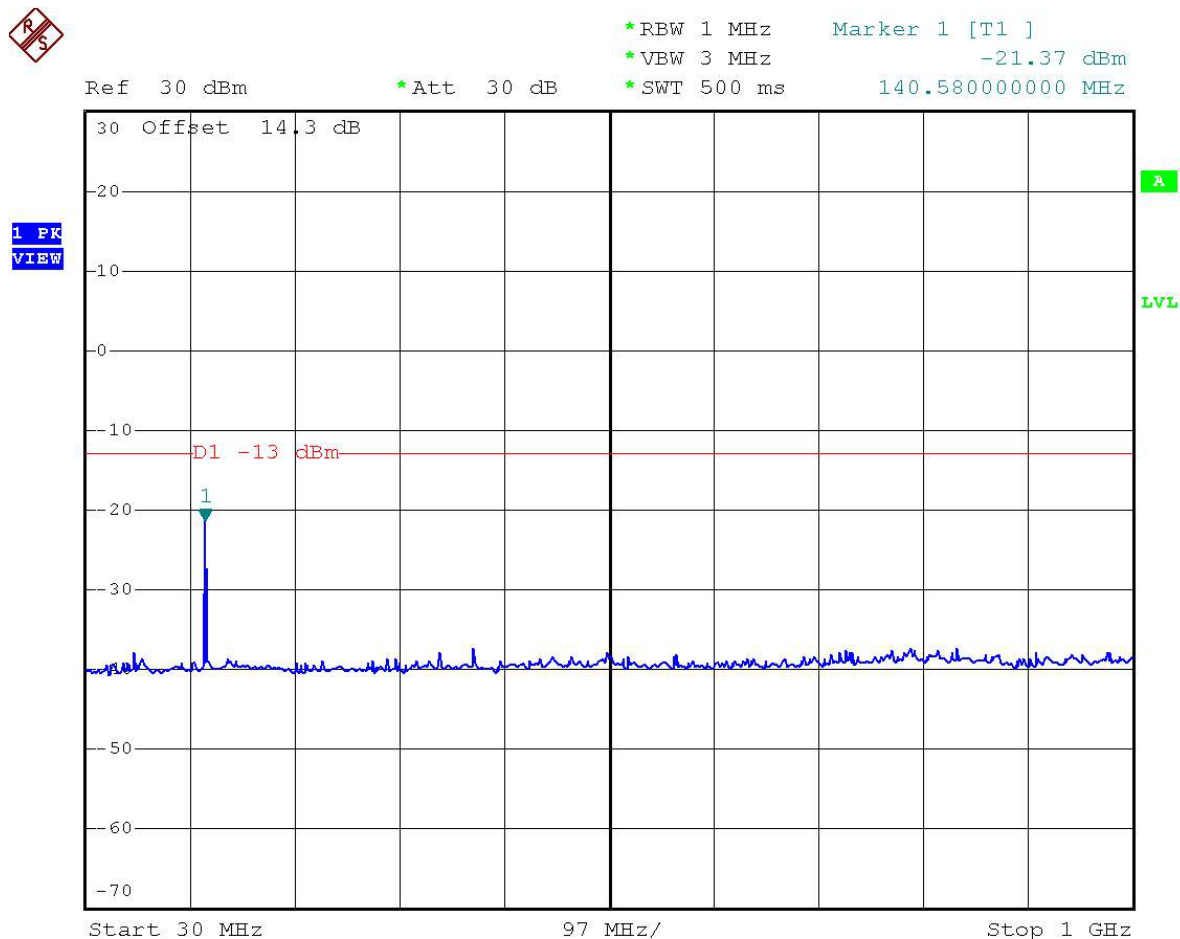

Date: 8.DEC.2004 23:03:27



- Test Mode : PCS 1900 CH661
- Frequency Range : 1G-3G

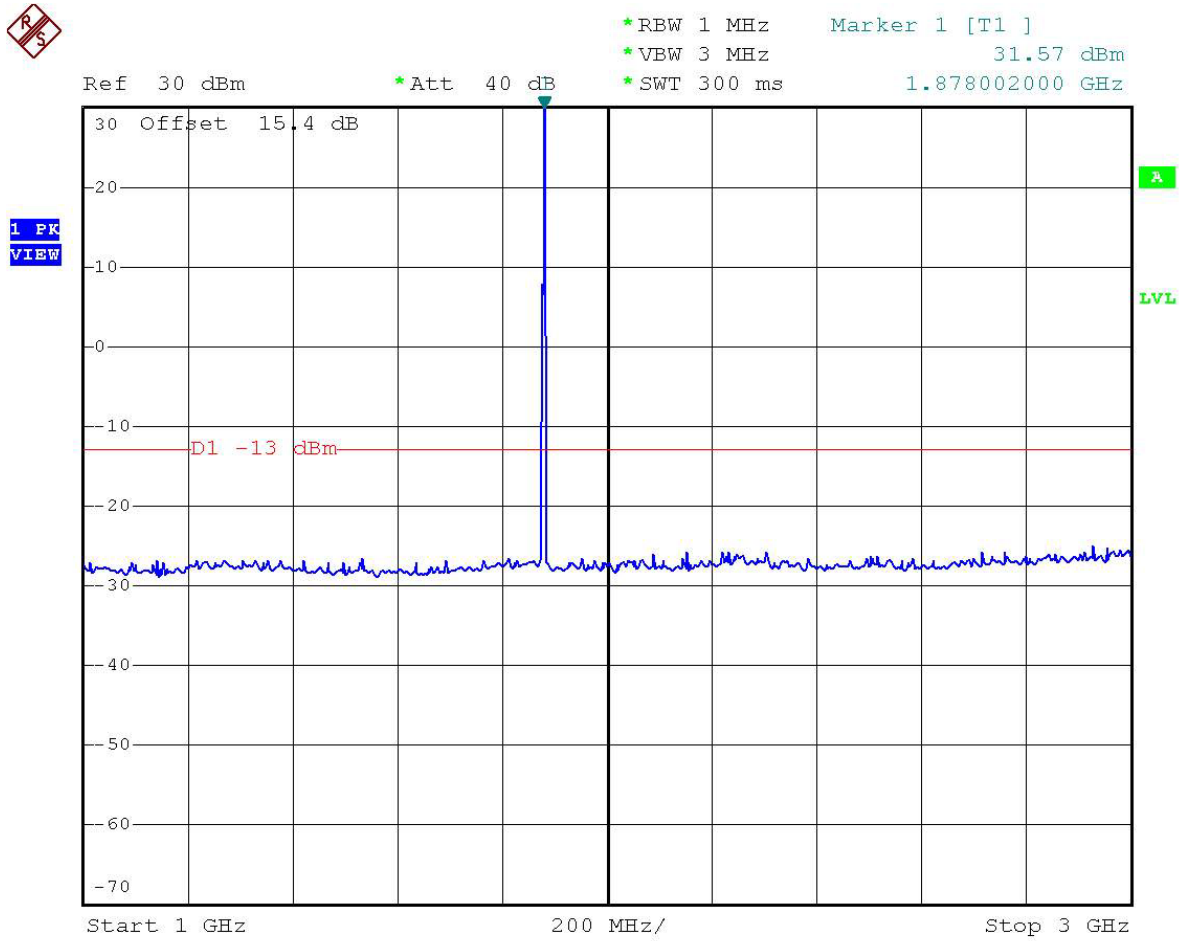

Date: 8.DEC.2004 23:13:38

Remark:

#Marker 1: The fundamental frequency of Ch661.



- Test Mode : PCS 1900 CH661
- Frequency Range : 3G-7G



Ref 0 dBm      \*Att 0 dB      \*RBW 1 MHz      Marker 2 [T1]      -51.84 dBm  
\*VBW 3 MHz      5.640000000 GHz  
\*SWT 300 ms

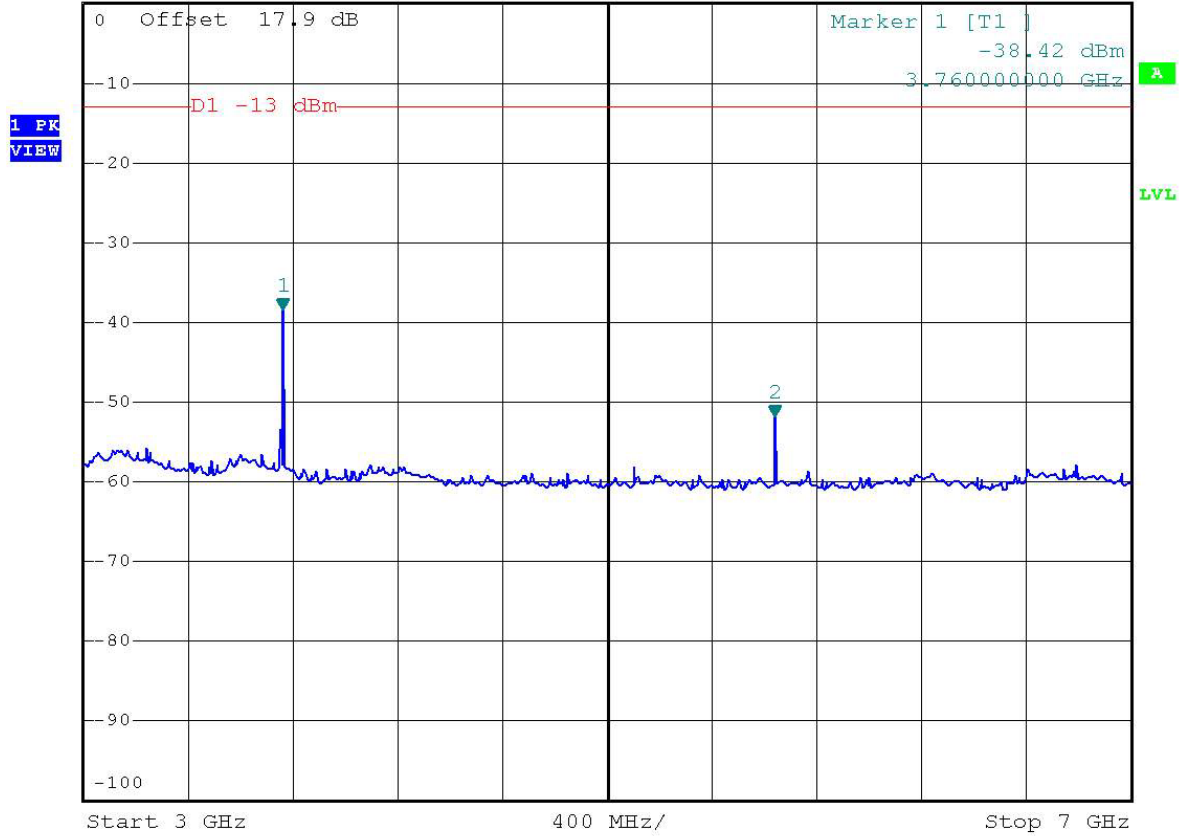

Date: 8.DEC.2004 23:17:58



- Test Mode : PCS 1900 CH661
- Frequency Range : 7G-13.6G



Ref 0 dBm      \*Att 0 dB      \*RBW 1 MHz      Marker 2 [T1]      -53.67 dBm  
\*VBW 3 MHz      11.284000000 GHz  
\*SWT 300 ms

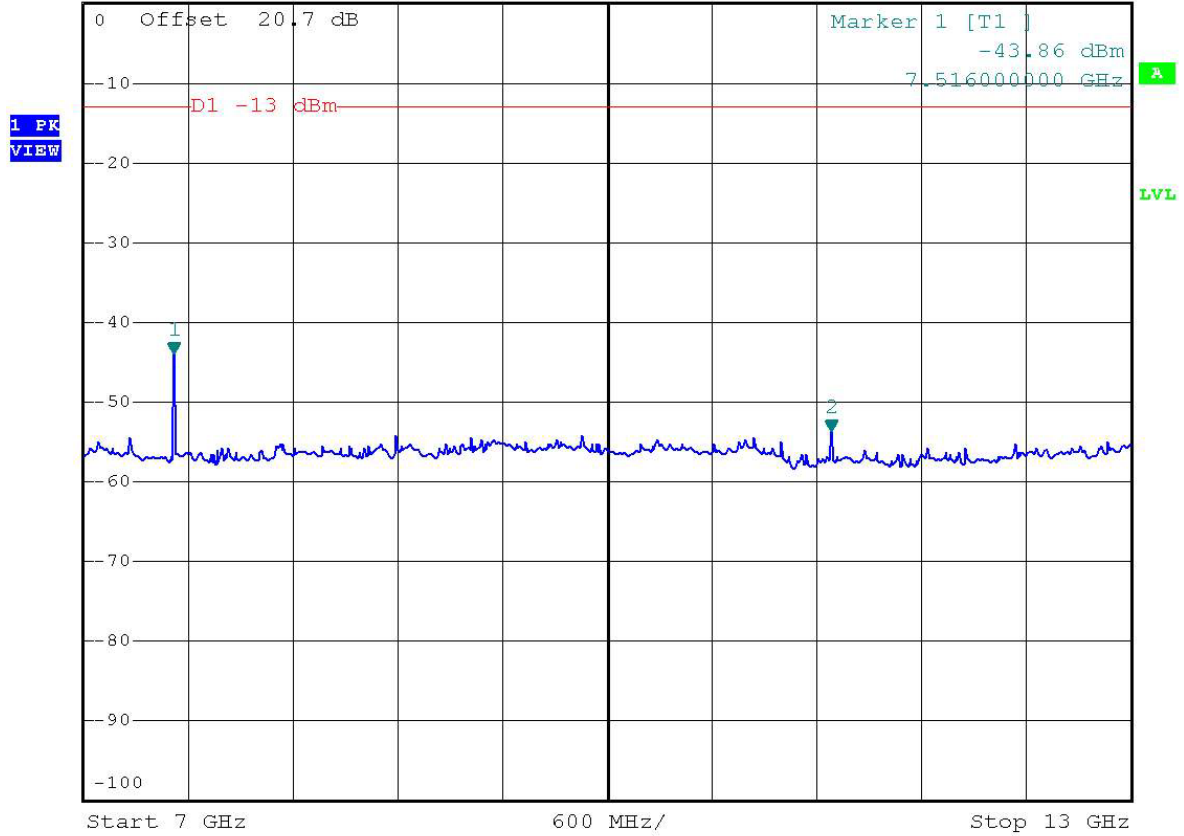

Date: 8.DEC.2004 23:21:04



- Test Mode : PCS 1900 CH661
- Frequency Range : 13.6G-19.1G

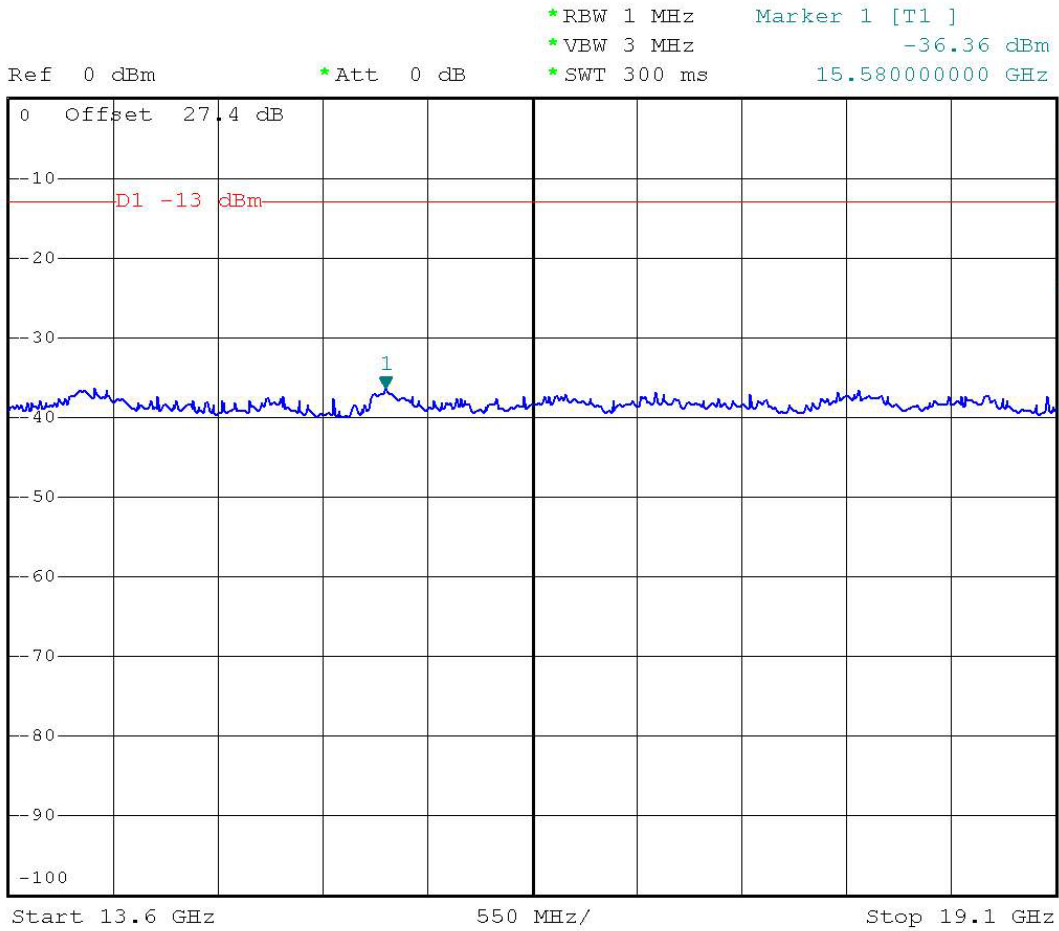

Date: 8.DEC.2004 23:23:21

## 4.6 Field Strength of Spurious Radiation

Equivalent isotropic radiated Power Measurements by substitution method according to ANSI/TIA/EIA-603-A.

### 4.6.1 Measurement Instruments

As described in chapter 5 of this test report.

### 4.6.2 Test Procedure

1. The EUT was placed on a rotatable wooden table with 0.8 meter about ground.
2. The EUT was set 3 meters from the receiving antenna which was mounted on the antenna tower.
3. The table was rotated 360 degrees to determine the position of the highest spurious emission.
4. The height of the receiving antenna is varied between one meter and four meters to reach the maximum spurious emission for both horizontal and vertical polarizations.
5. Taking the record of maximum spurious emission.
6. A Horn antenna was substituted in place of the EUT and was driven by a signal generator.
7. The conducted power at the terminal of the Horn antenna is measured.
8. Repeat step 3 to step 5.

### 4.6.3 Test Setup Layout

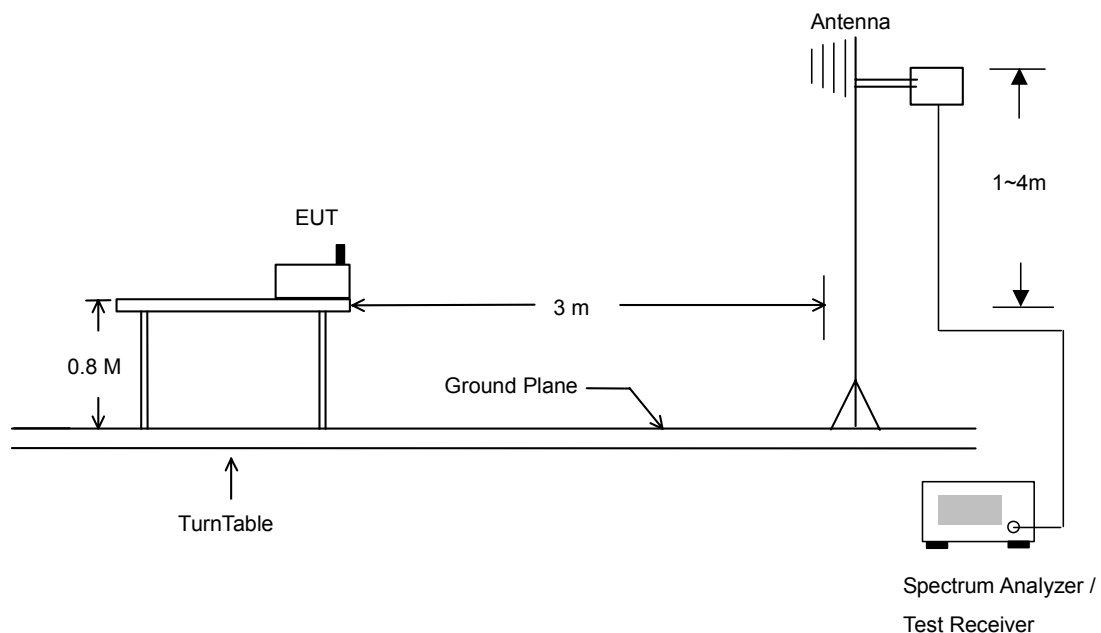





## 4.6.4 Test Result

- Test Mode : PCS 1900 CH 661

<b>PCS1900 Radiated Spurious EIRP</b>							
H Polarization				V Polarization			
Frequency (MHz)	EIRP (dBm)	Limit (dBm)	Margin (dB)	Frequency (MHz)	EIRP (dBm)	Limit (dBm)	Margin (dB)
62.130	-66.590	-13	-53.59	54.840	-53.760	-13	-40.76
93.180	-66.380	-13	-53.38	62.940	-55.490	-13	-42.49
284.340	-63.400	-13	-50.40	265.980	-67.560	-13	-54.56
315.400	-76.730	-13	-63.73	315.400	-75.620	-13	-62.62
376.300	-76.850	-13	-63.85	477.800	-61.500	-13	-48.50
922.300	-71.930	-13	-58.93	805.400	-70.030	-13	-57.03
1688.000	-52.301	-13	-39.30	1688.000	-52.934	-13	-39.93
2068.000	-51.33	-13	-38.33	2068.000	-50.66	-13	-37.66
3758.000	-46.580	-13	-33.58	3758.000	-43.319	-13	-30.32
5638.000	-49.234	-13	-36.23	5638.000	-50.469	-13	-37.47



4.6.5 Test Data

Horizontal Polarization

	Freq	Level	Over Limit	Limit Line	ReadAntenna Level	Antenna Factor	Preamp Factor	Cable Loss	Remark	Ant Pos	Table Pos
	MHz	dBm	dB	dBm	dBm	dB	dB	dB		cm	deg
1 @	62.13	-66.59	-53.59	-13.00	-54.21	-12.39	0.00	0.00	Peak	---	---
2 @	93.18	-66.38	-53.38	-13.00	-54.12	-12.27	0.00	0.00	Peak	---	---
3 @	284.34	-63.40	-50.40	-13.00	-52.92	-10.48	0.00	0.00	Peak	---	---

	Freq	Level	Over Limit	Limit Line	ReadAntenna Level	Antenna Factor	Preamp Factor	Cable Loss	Remark	Ant Pos	Table Pos
	MHz	dBm	dB	dBm	dBm	dB	dB	dB		cm	deg
1	315.40	-76.73	-63.73	-13.00	-67.32	-9.41	0.00	0.00	Peak	---	---
2	376.30	-76.85	-63.85	-13.00	-69.55	-7.30	0.00	0.00	Peak	---	---
3 @	922.30	-71.93	-58.93	-13.00	-71.42	-0.51	0.00	0.00	Peak	---	---

	Freq	Level	Over Limit	Limit Line	ReadAntenna Level	Antenna Factor	Preamp Factor	Cable Loss	Remark	Ant Pos	Table Pos
	MHz	dBm	dB	dBm	dBm	dB	dB	dB		cm	deg
1 @	1688.00	-52.30	-39.30	-13.00	-52.44	0.13	0.00	0.00	Peak	---	---
2 @	1948.00	-49.69			-48.75	-0.94	0.00	0.00	Peak	---	---
3 @	2068.00	-51.33	-38.33	-13.00	-50.82	-0.51	0.00	0.00	Peak	---	---

Remark:

- #2 : BS TCH Signal

	Freq	Level	Over Limit	Limit Line	ReadAntenna Level	Antenna Factor	Preamp Factor	Cable Loss	Remark	Ant Pos	Table Pos
	MHz	dBm	dB	dBm	dBm	dB	dB	dB		cm	deg
1 @	3758.00	-46.58	-33.58	-13.00	-54.50	7.92	0.00	0.00	Peak	---	---

	Freq	Level	Over Limit	Limit Line	ReadAntenna Level	Antenna Factor	Preamp Factor	Cable Loss	Remark	Ant Pos	Table Pos
	MHz	dBm	dB	dBm	dBm	dB	dB	dB		cm	deg
1 @	5638.00	-49.23	-36.23	-13.00	-59.20	9.97	0.00	0.00	Peak	---	---



Vertical Polarization

	Freq	Level	Over Limit	Limit Line	ReadAntenna Level	Antenna Factor	Preamp Factor	Cable Loss	Remark	Ant Pos	Table Pos
	MHz	dBm	dB	dBm	dBm	dB	dB	dB		cm	deg
1 @	54.84	-53.76	-40.76	-13.00	-39.64	-14.12	0.00	0.00	Peak	---	---
2 @	62.94	-55.49	-42.49	-13.00	-42.49	-13.00	0.00	0.00	Peak	---	---
3 @	265.98	-67.56	-54.56	-13.00	-60.37	-7.18	0.00	0.00	Peak	---	---

	Freq	Level	Over Limit	Limit Line	ReadAntenna Level	Antenna Factor	Preamp Factor	Cable Loss	Remark	Ant Pos	Table Pos
	MHz	dBm	dB	dBm	dBm	dB	dB	dB		cm	deg
1	315.40	-75.62	-62.62	-13.00	-69.49	-6.13	0.00	0.00	Peak	---	---
2 @	477.80	-61.50	-48.50	-13.00	-58.10	-3.39	0.00	0.00	Peak	---	---
3 @	805.40	-70.03	-57.03	-13.00	-71.14	1.11	0.00	0.00	Peak	---	---

	Freq	Level	Over Limit	Limit Line	ReadAntenna Level	Antenna Factor	Preamp Factor	Cable Loss	Remark	Ant Pos	Table Pos
	MHz	dBm	dB	dBm	dBm	dB	dB	dB		cm	deg
1 @	1688.00	-52.93	-39.93	-13.00	-52.43	-0.50	0.00	0.00	Peak	---	---
2 @	1943.00	-49.18			-48.69	-0.50	0.00	0.00	Peak	---	---
3 @	2068.00	-50.66	-37.66	-13.00	-50.85	0.19	0.00	0.00	Peak	---	---

Remark:

- #2 : BS TCH Signal

	Freq	Level	Over Limit	Limit Line	ReadAntenna Level	Antenna Factor	Preamp Factor	Cable Loss	Remark	Ant Pos	Table Pos
	MHz	dBm	dB	dBm	dBm	dB	dB	dB		cm	deg
1 @	3758.00	-43.32	-30.32	-13.00	-49.96	6.64	0.00	0.00	Peak	---	---

	Freq	Level	Over Limit	Limit Line	ReadAntenna Level	Antenna Factor	Preamp Factor	Cable Loss	Remark	Ant Pos	Table Pos
	MHz	dBm	dB	dBm	dBm	dB	dB	dB		cm	deg
1 @	5638.00	-50.47	-37.47	-13.00	-59.12	8.65	0.00	0.00	Peak	---	---

### 4.7 Frequency Stability (Temperature Variation)

#### 4.7.1 Measurement Instrument

As described in chapter 5 of this test report.

#### 4.7.2 Test Procedure

1. The EUT and test equipment were set up as shown on the following section.
2. With all power removed, the temperature was decreased to -30°C and permitted to stabilize for three hours. Power was applied and the maximum change in frequency was note within one minute.
3. With power OFF, the temperature was raised in 10°C steps. The sample was permitted to stabilize at each step for at least one-half hour. Power was applied and the maximum frequency change ws noted within one minute.
4. The temperature tests were performed for the worst case.
5. Test data was recorded.

#### 4.7.3 Test Setup Layout

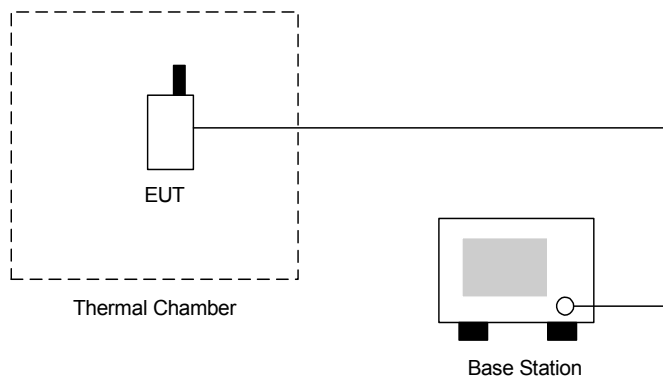

#### 4.7.4 Test Result

- Test Mode : PCS 1900 CH661

Temperature(°C)	Change (Hz)	Change (ppm)	Limit (ppm)	Result
-20	-32	-0.02	2.5	Passed
-10	-34	-0.02		
0	-39	-0.02		
10	-29	-0.02		
20	-27	-0.01		
30	-34	-0.02		
40	-35	-0.02		
50	-21	-0.01		

### 4.8 Frequency Stability (Voltage Variation)

#### 4.8.1 Measurement Instrument

As described in chapter 5 of this test report.

#### 4.8.2 Test Procedure

1. The EUT was placed in a temperature chamber at  $25\pm 5^{\circ}\text{C}$  and connected as the following section.
2. The power supply voltage to the EUT was varied from BEP to 115% of the nominal value measured at the input to the EUT.
3. The variation in frequency was measured for the worst case.

#### 4.8.3 Test Setup Layout

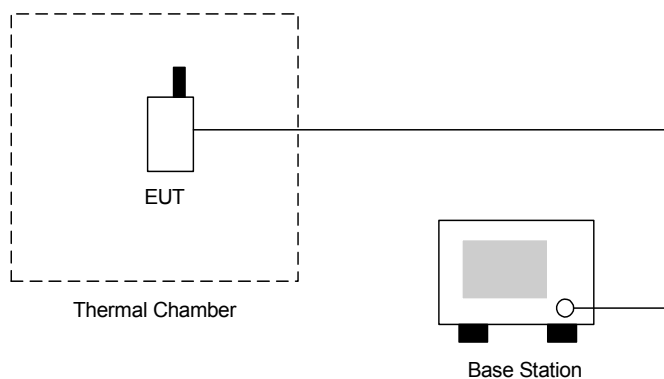

#### 4.8.4 Test Result

- Test Mode : PCS 1900 CH661

Voltage(Volt)	Change (Hz)	Change (ppm)	Limit (ppm)	Result
3.7	-27	-0.01	2.5	Passed
BEP	21	0.01		
4.3	-28	-0.01		

Remark:

1. Normal Voltage=3.7V
2. Battery End Point (BEP)=3.3V

**5. List of Measurement Equipments**

Instrument	Manufacturer	Model No.	Serial No.	Characteristics	Calibration Date	Due Date	Remark
Spectrum analyzer	R&S	FSP40	100057	9KHz-40GHz	Feb. 26, 2004	Feb. 26, 2005	Radiation (03CH06-HY)
Bilog Antenna	SCHAFFNER	CBL6112B	2885	30MHz -2GHz	Dec. 18, 2003	Dec. 18, 2004	Radiation (03CH06-HY)
Horn Antenna	Com-Power	AH118	071025	1G-18G	Feb. 11, 2004	Feb. 11, 2005	Radiation (03CH06-HY)
PreAmplifier	Com-Power	PA-103	161055	1MHz - 1000MHz	Apr. 26, 2004	Apr. 26, 2005	Radiation (03CH06-HY)
HF Amplifier	MITEQ	AFS44	973248	0.1G - 26.5G	May. 20, 2004	May. 20, 2005	Radiation (03CH06-HY)
Base Station Emulator	Agilent	E5515C	GB43460754	N/A	Jan. 12, 2004	Jan. 12, 2005	Base Station
Thermal Chamber	Ten Billion	TTH-D35P	N/A	N/A	NCR	NCR	EMS Chamber



## 6. Uncertainty Evaluation

### Uncertainty of Conducted Emission Evaluation (30kHz ~ 1000MHz)

Contribution	Uncertainty of $x_i$		$u(x_i)$
	dB	Probability Distribution	
Receiver reading	0.41	Normal(k=2)	0.21
Antenna factor calibration	0.83	Normal(k=2)	0.42
Cable loss calibration	0.25	Normal(k=2)	0.13
Pre Amplifier Gain calibration	0.27	Normal(k=2)	0.14
RCV/SPA specification	2.50	Rectangular	0.72
Antenna Factor Interpolation for Frequency	1.00	Rectangular	0.29
Site imperfection	1.43	Rectangular	0.83
Mismatch Receiver VSWR $\Gamma_1 = 0.20$ Antenna VSWR $\Gamma_2 = 0.23$ Uncertainty = $20\log(1-\Gamma_1*\Gamma_2)$	+0.39/-0.41	U-shaped	0.28
<b>combined standard uncertainty Uc(y)</b>	<b>1.27</b>		
<b>Measuring uncertainty for a level of confidence of 95% U=2Uc(y)</b>	<b>2.54</b>		

### Uncertainty of Radiated Emission Evaluation (1GHz ~ 40GHz)

Contribution	Uncertainty of $x_i$		$u(x_i)$	$C_i$	$C_i * u(x_i)$
	dB	Probability Distribution			
Receiver reading	±0.10	Normal(k=1)	0.10	1	0.10
Antenna factor calibration	±1.70	Normal(k=2)	0.85	1	0.85
Cable loss calibration	±0.50	Normal(k=2)	0.25	1	0.25
Receiver Correction	±2.00	Rectangular	1.15	1	1.15
Antenna Factor Directional	±1.50	Rectangular	0.87	1	0.87
Site imperfection	±2.80	Triangular	1.14	1	1.14
Mismatch Receiver VSWR $\Gamma_1 = 0.197$ Antenna VSWR $\Gamma_2 = 0.194$ Uncertainty = $20\log(1-\Gamma_1*\Gamma_2*\Gamma_3)$	+0.34/-0.35	U-shaped	0.244	1	0.244
<b>Combined standard uncertainty Uc(y)</b>	<b>2.36</b>				
<b>Measuring uncertainty for a level of confidence of 95% U=2Ue(y)</b>	<b>4.72</b>				

$$U = \sqrt{\{(1/2)^2 + (0.3/2)^2 + (2^2 + 0.5^2 + 2^2 + 0.25^2 + 2^2)/3 + (0.54)^2/2\}} = 2.2 \text{ for 10m test distance}$$

$$U = \sqrt{\{(1/2)^2 + (0.3/2)^2 + (2^2 + 3^2 + 2^2 + 0.25^2 + 2^2)/3 + (0.54)^2/2\}} = 2.7 \text{ for 3m test distance}$$

END OF TEST REPORT