

FCC TEST REPORT

for

47 CFR Part 24E

Equipment : GSM/GPRS Mobile Phone
Trade Name : Palmax
Model No. : TG7E
FCC ID : GKRTG7E
Tx Frequency Range : 1850.2~1909.8MHz
Max. RF Output Power : 0.40W
Emission Designator : 300 KGXW
Applicant : **Compal Electronics, Inc.**
No. 581, Juikuang Rd., Neihu, Taipei, (114)
Taiwan, R.O.C.

- The test result refers exclusively to the test presented test model / sample.
- Without written approval of SPORTON International Inc., the test report shall not be reproduced except in full.
- **Certificate or Test Report must not be used by the applicant to claim the product in this test report endorsement by NVLAP or any agency of U.S. government.**
- The data shown in this test report were carried out on Dec. 07, 2004 at **Sporton International Inc. LAB.**



Dr. Daniel Lee
EMC/SAR Manager

SPORTON International Inc.

6F, No.106, Sec. 1, Hsin Tai Wu Rd., Hsi Chih, Taipei Hsien, Taiwan, R.O.C.

SPORTON International Inc.

TEL : 886-2-2696-2468

FAX : 886-2-2696-2255



Table of Contents

History of this test report.....ii

1. General Information 1

 1.1. Applicant..... 1

 1.2. Manufacturer..... 1

 1.3. Basic Description of Equipment under Test..... 1

 1.4. Feature of Equipment under Test..... 2

 1.5. Report Date 2

2 Test Configuration of Equipment under Test.....3

 2.1 Test Manner..... 3

 2.2 Test Mode..... 3

 2.3 Connection Diagram of Test System 4

 2.4 Ancillary Equipment List..... 4

3. General Information of Test Site5

 3.1 Test Voltage..... 5

 3.2 Test in Compliance with 5

 3.3 Frequency Range Investigated..... 5

 3.4 Test Distance..... 5

4. Test Data and Test Result.....6

 4.1 List of Measurements and Examinations 6

 4.2 RF Output Power 7

 4.3 ERP / EIRP Measurement..... 8

 4.4 Occupied Bandwidth and Band Edge Measurement..... 10

 4.5 Conducted Emission 15

 4.6 Field Strength of Spurious Radiation 21

 4.7 Frequency Stability (Temperature Variation) 25

 4.8 Frequency Stability (Voltage Variation) 26

5. List of Measurement Equipments27

6. Uncertainty Evaluation.....28

Appendix A. Photographs of EUT External

Appendix B. Photographs of EUT Internal

Appendix C. Photographs of Setup



History of this test report

Original Report Issue Date: Dec. 09, 2004

No additional attachment.

Additional attachment were issued as following record:

Attachment No.	Issue Date	Description



1. General Information

1.1. Applicant

Compal Electronics, Inc.

No. 581, Juikuang Rd., Neihu, Taipei, (114) Taiwan, R.O.C.

1.2 Manufacturer

Compal Electronics, Inc.

No. 581, Juikuang Rd., Neihu, Taipei, (114) Taiwan, R.O.C.

1.3 Basic Description of Equipment under Test

Equipment	: GSM/GPRS Mobile Phone
Trade Name	: Palmax
Model No.	: TG7E
FCC ID	: GKRTG7E

**1.4 Feature of Equipment under Test**

DUT Type :	GSM/GPRS Mobile Phone
Trade Name :	Palmax
Model Name :	TG7E
FCC ID :	GKRTG7E
Tx Frequency :	1850.2-1909.8MHz
Rx Frequency :	1930.2-1989.8MHz
Antenna Type :	Fixed External
Maximum Output Power :	0.724 W (28.6 dBm)
Maximum EIRP	0.40 W (26.042 dBm)
HW Version :	V 10
SW Version :	V 1024
Digital Modulation Emission :	GMSK
Type of Emission :	300 KGXW
DUT Stage :	Production Unit

1.5 Report Date

EUT Received : Dec. 03, 2004

Report Date : Dec. 09, 2004



2 Test Configuration of Equipment under Test

2.1 Test Manner

- a. The spurious emission measurements were carried out in semi-anechoic chamber with 3-meter test range.
- b. During all testings, EUT is in link mode with base station emulator at maximum power level. (PCL=0 for PCS 1900)
- c. Frequency range investigated: radiated emission 30 MHz to 19000MHz.

2.2 Test Mode

Application	PCS 1900
Radiated Emission	<input checked="" type="checkbox"/> Mode 1: CH 661
Conducted Measurement	<input checked="" type="checkbox"/> Mode 1: CH 661

2.3 Connection Diagram of Test System

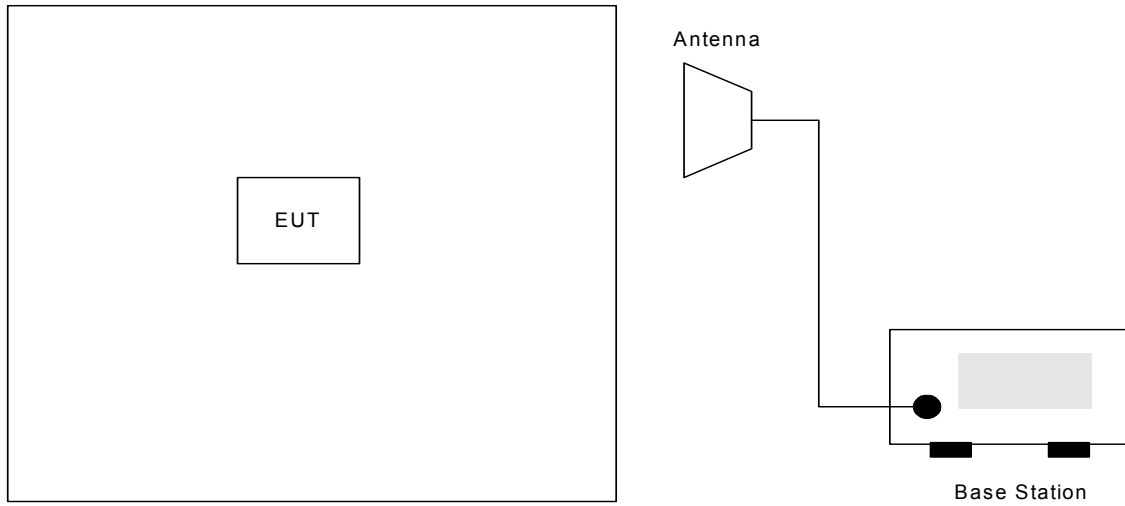

2.4 Ancillary Equipment List

Item	Equipment	Model No.	Serial No.
1.	Base Station	CMU200	105934
2.	Base Station	E5515C	GB43460754



3. General Information of Test Site

Test Site Location : No. 52, Hwa Ya 1st Rd., Hwa Ya Technology Park,
Kwei-Shan Hsiang, Tao Yuan Hsien, Taiwan, R.O.C.
TEL : 886-3-327-3456
FAX : 886-3-318-0055

Test Site No : 03CH06-HY

The chamber meets the characteristics of ANSI C63.4-2003. This site is on file with the FCC. The Industry Canada file number for this site is IC 4088.

3.1 Test Voltage

110V/ 60Hz

3.2 Test in Compliance with

47 CFR Part 24E and Part 2.

3.3 Frequency Range Investigated

a. Radiation: from 30 MHz to 19000 MHz for PCS 1900

3.4 Test Distance

The test distance of radiated emission from antenna to EUT is 3 m.



4. Test Data and Test Result

4.1 List of Measurements and Examinations

FCC Rule	IC RULE	DESCRIPTION OF TEST	Result	Section
§2.1046	RSS-133 §6.2	RF Output Power	Passed	4.2
§24.232	RSS-133 §6.2	EIRP	Passed	4.3
§2.1049, §24.238(b)	RSS-133 §6.3	Occupied Bandwidth & Band Edge Measurement	Passed	4.4
§2.1051	RSS-133 §6.3	Conducted Emission	Passed	4.5
§2.1053	RSS-133 §6.3	Field Strength of Spurious Radiation	Passed	4.6
§2.1055, §24.235	RSS-133 §7	Frequency Stability vs. Temperature	Passed	4.7
§2.1055, §24.235	RSS-133 §7	Frequency Stability vs. Voltage	Passed	4.8

4.2 RF Output Power

4.2.1 Measurement Instruments :

As described in chapter 5 of this test report.

4.2.2 Test Procedure :

1. The transmitter output was connected to power meter and base station through power divider.
2. Set EUT at PCL=0 for PCS 1900 through base station.
3. Select lowest, middle, and highest channels for each band.

4.2.3 Test Setup Layout :

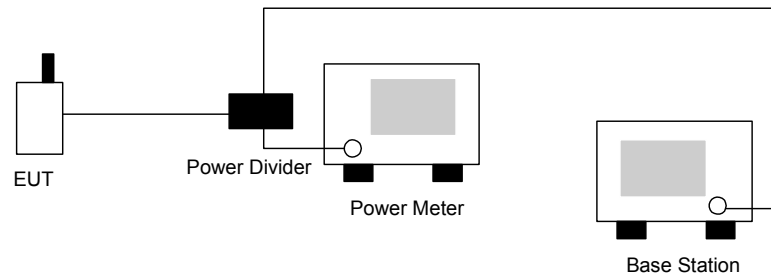

4.2.4 Test Result :

Bands	Channel	Frequency (MHz)	Conducted Power (dBm)	Conducted Power (Watts)
GSM 1900	512	1850.2 (Low)	28.6	0.724
	661	1880.0 (Mid)	28.6	0.724
	810	1909.8 (High)	28.3	0.676

4.3 ERP / EIRP Measurement

Equivalent isotropic radiated power measurements by substitution method according to ANSI/TIA/EIA-603-A.

4.3.1 Measurement Instruments

As described in chapter 5 of this test report.

4.3.2 Test Procedure

1. The EUT was placed on a rotatable wooden table with 0.8 meter about ground.
2. The EUT was set 3 meters from the receiving antenna which was mounted on the antenna tower.
3. The table was rotated 360 degrees to determine the position of the highest radiated power.
4. The height of the receiving antenna is varied between one meter and four meters to reach the maximum radiated power for both horizontal and vertical polarizations.
5. Taking the record of maximum ERP/EIRP.
6. A Horn antenna was substituted in place of the EUT and was driven by a signal generator.
7. The conducted power at the terminal of the Horn antenna is measured.
8. Repeat step 3 to step 5.

4.3.3 Test Setup Layout of ERP/EIRP

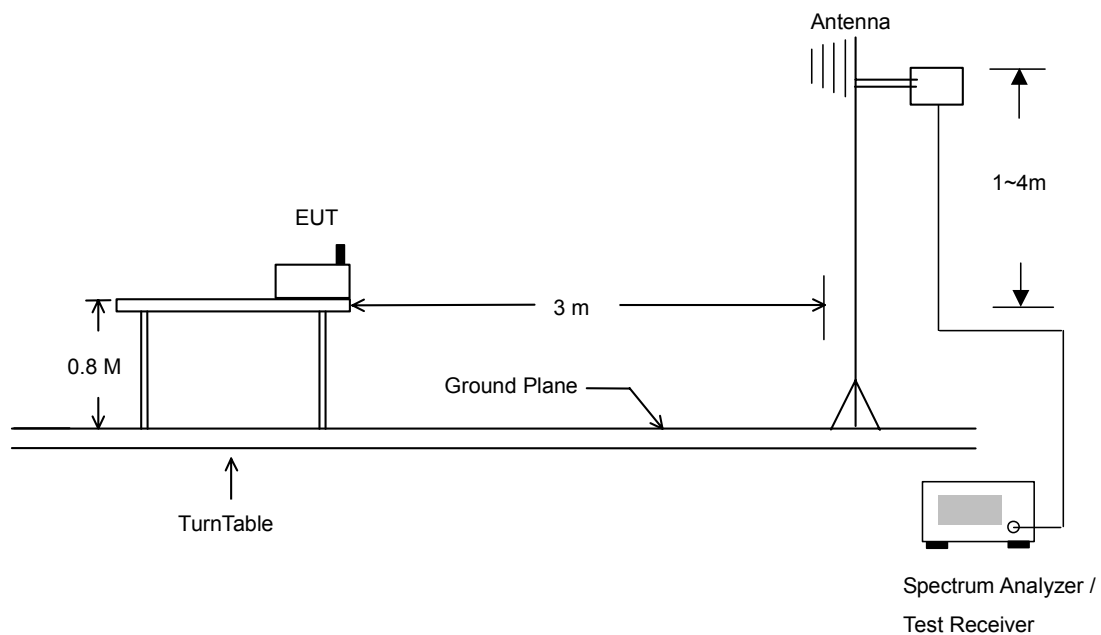



4.3.4 Test Result

PCS1900 Radiated Power EIRP					
H Polarization			V Polarization		
Frequency (MHz)	EIRP (dBm)	EIRP (Watts)	Frequency (MHz)	EIRP (dBm)	EIRP (Watts)
1850.240	17.900	0.06	1850.220	23.468	0.22
1879.970	19.097	0.08	1879.990	26.042	0.40
1909.740	16.080	0.04	1909.820	24.583	0.29

4.4 Occupied Bandwidth and Band Edge Measurement

4.4.1 Measurement Instruments

As described in chapter 5 of this test report.

4.4.2 Test Procedure

1. The EUT was connected to Spectrum Analyzer and Base Station via power divider.
2. The occupied bandwidth of middle channel for the highest and lowest RF powers were measured.
3. The bandedge of low and high channels for the highest RF powers within the transmitting frequency band were measured. Setting RBW as roughly $BW/10$.

4.4.3 Test Setup Layout

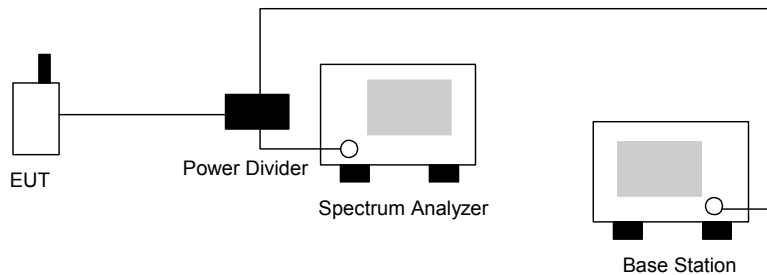



4.4.4 Test Result

- Test Mode : PCS 1900 CH661 Lower Band Edge
- Power State : High

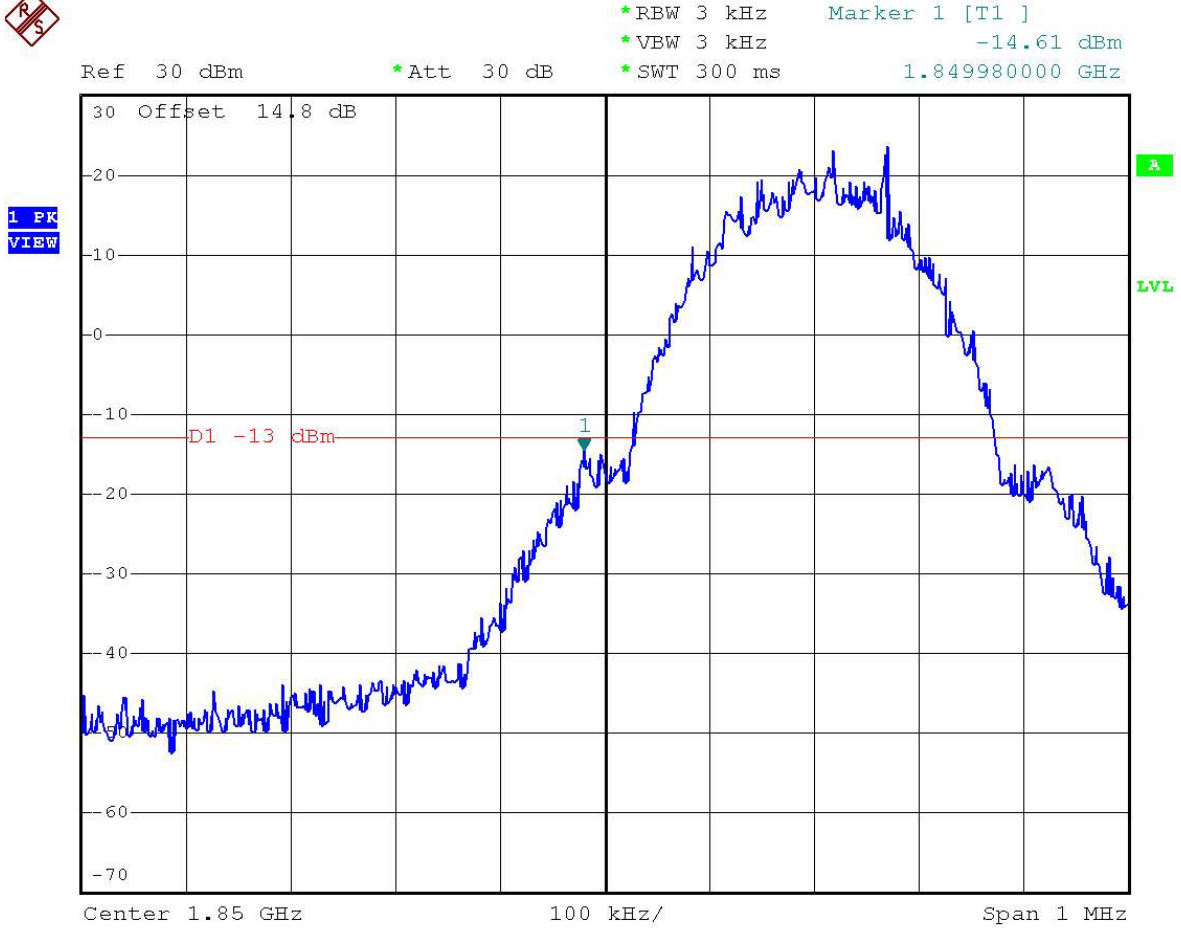



- Test Mode : PCS 1900 CH661 99% Occupied Bandwidth
- Power State : Low

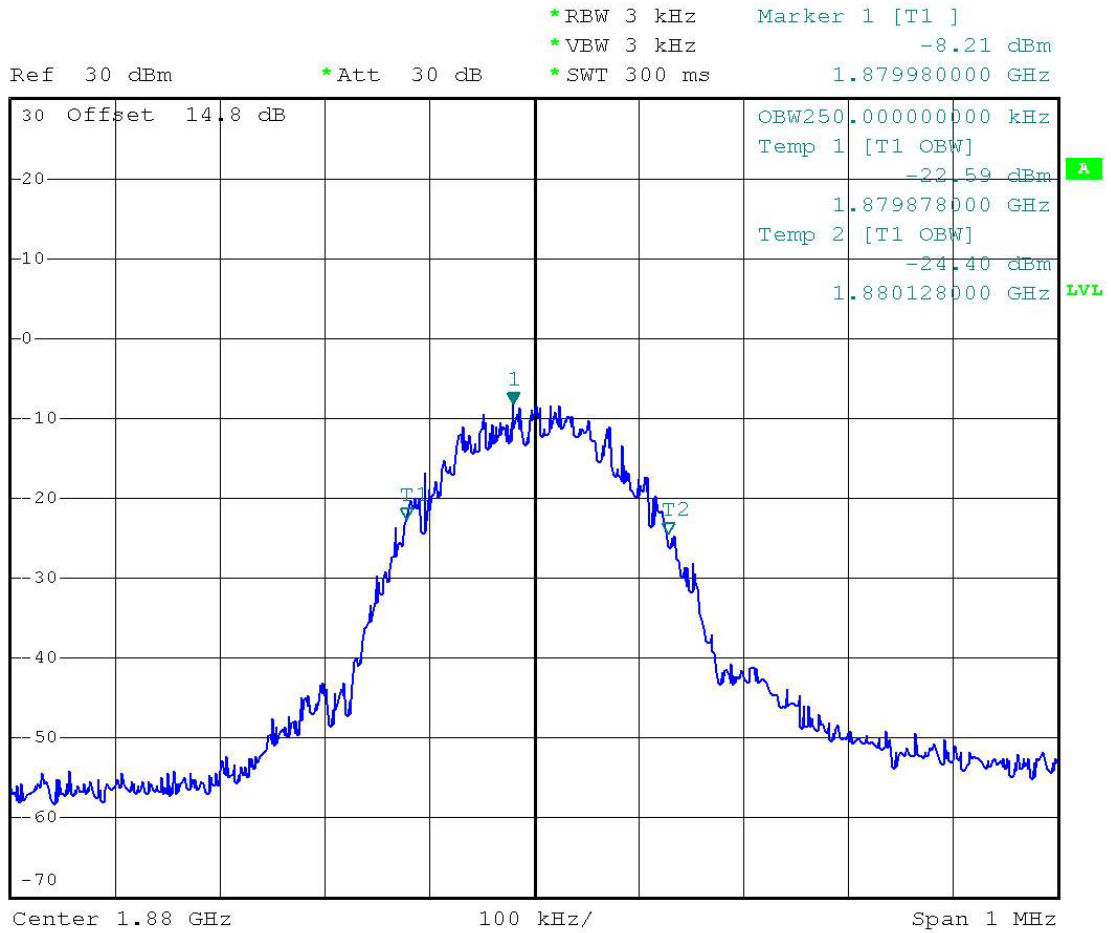



- Test Mode : PCS 1900 CH661 99% Occupied Band Edge
- Power State : High



*RBW 3 kHz Marker 1 [T1]
*VBW 3 kHz -15.47 dBm
*SWT 300 ms 1.910022000 GHz

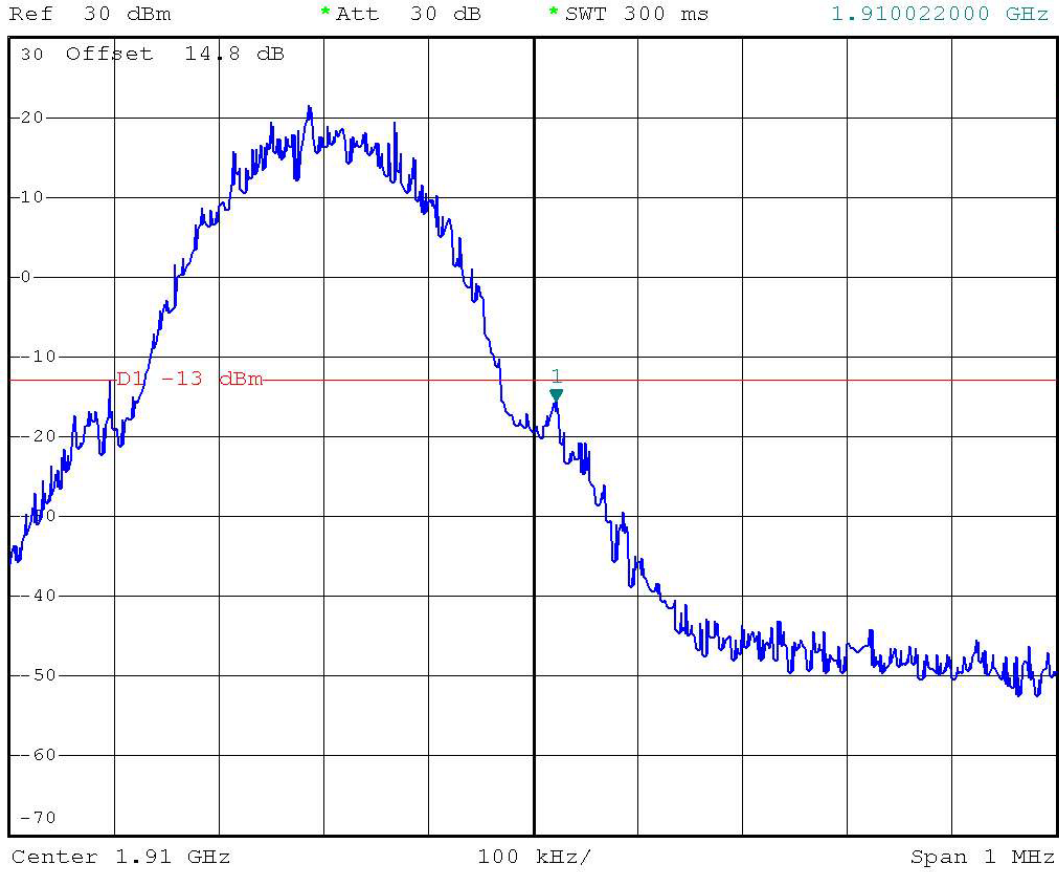

4.5 Conducted Emission

4.5.1 Measurement Instruments

As described in chapter 5 of this test report.

4.5.2 Test Procedure

1. The EUT was connected to Spectrum Analyzer and Base Station via power divider.
2. The middle channel for the highest RF power within the transmitting frequency was measured.
3. The conducted spurious emission for the whole frequency range was taken.

4.5.3 Test Setup Layout

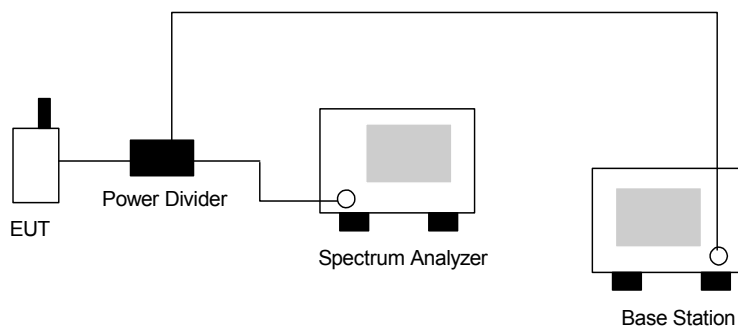



4.5.4 Test Result

- Test Mode : PCS 1900 CH661
- Frequency Range : 30M-1G



Ref 30 dBm *Att 40 dB *RBW 100 kHz Marker 1 [T1] -30.49 dBm
*VBW 300 kHz *SWT 500 ms 140.580000000 MHz

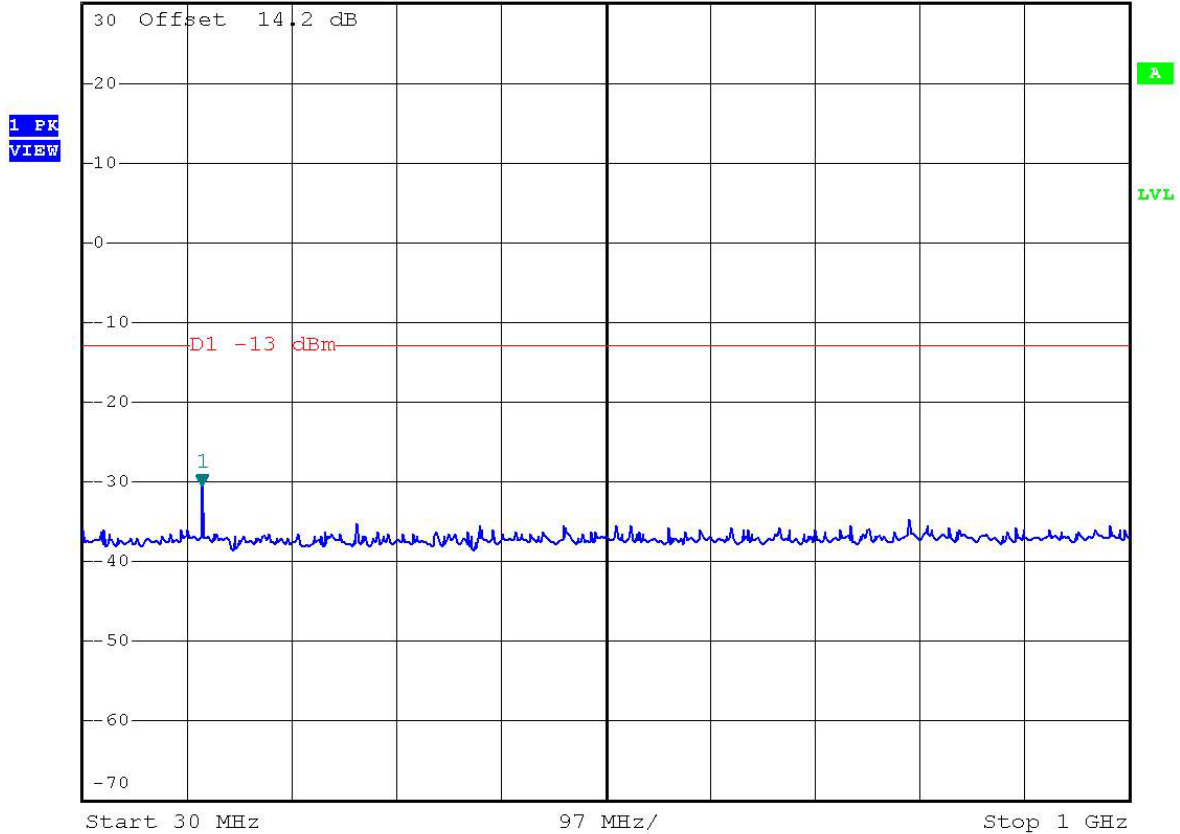



- Test Mode : PCS 1900 CH661
- Frequency Range : 1G-3G

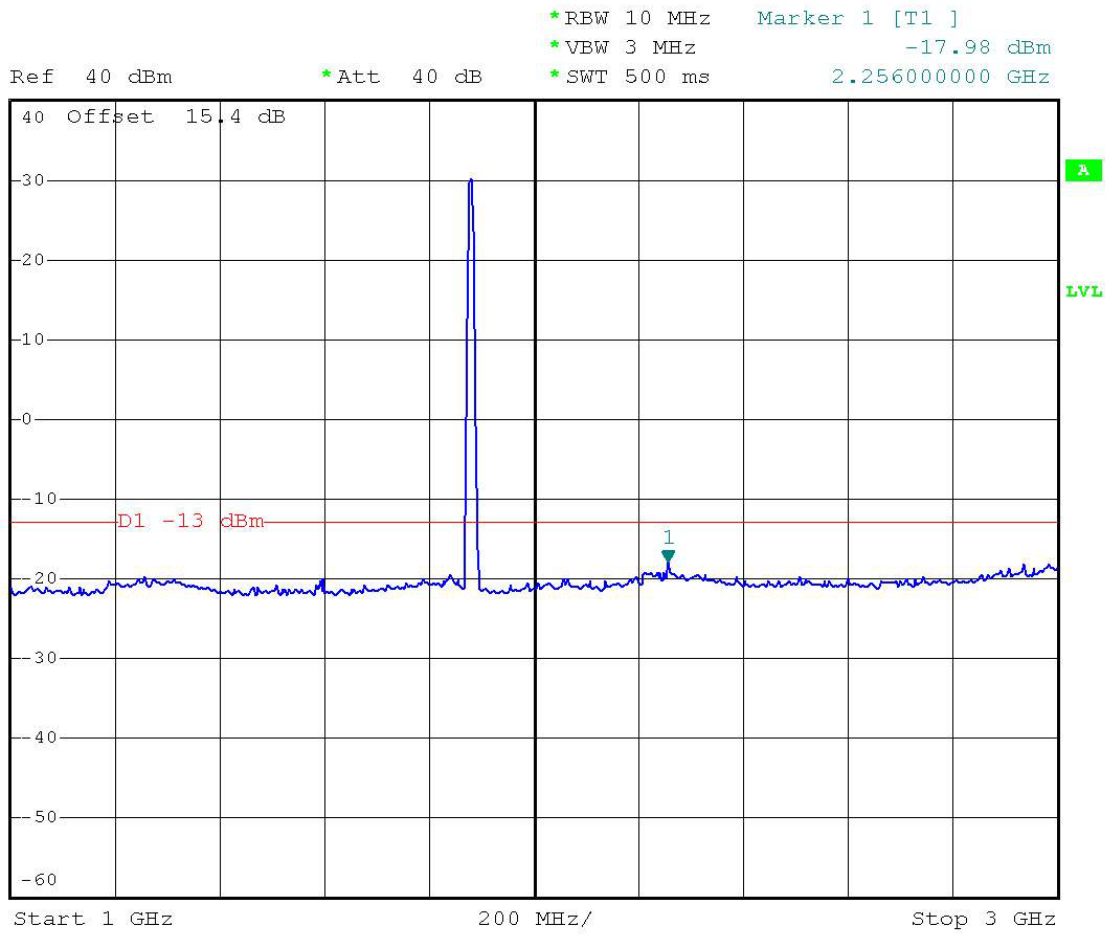



- Test Mode : PCS 1900 CH661
- Frequency Range : 3G-7G



*RBW 1 MHz Marker 1 [T1]
*VBW 3 MHz -46.25 dBm
*SWT 500 ms 3.760000000 GHz

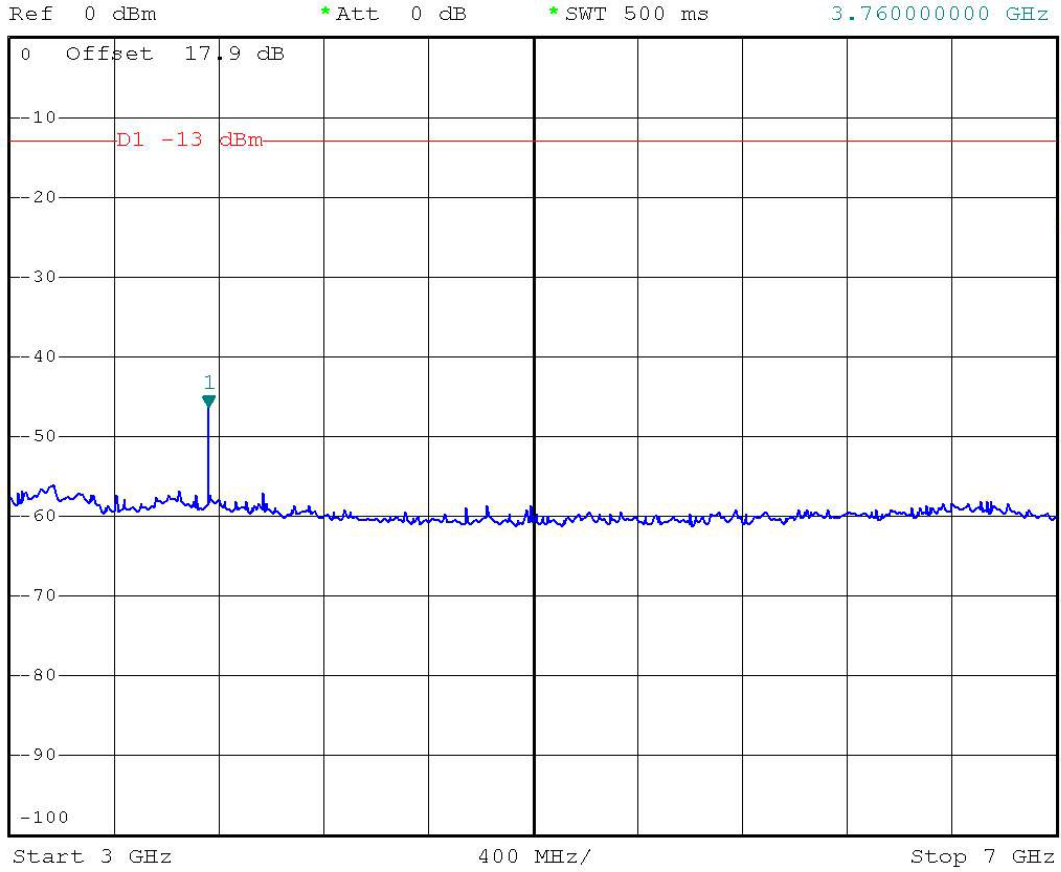



- Test Mode : PCS 1900 CH661
- Frequency Range : 7G-13.6G



*RBW 1 MHz Delta 3 [T1]
*VBW 3 MHz 5.46 dB
*SWT 500 ms 5.649600000 GHz

Ref 0 dBm

*Att 0 dB

1 PK
MAXH

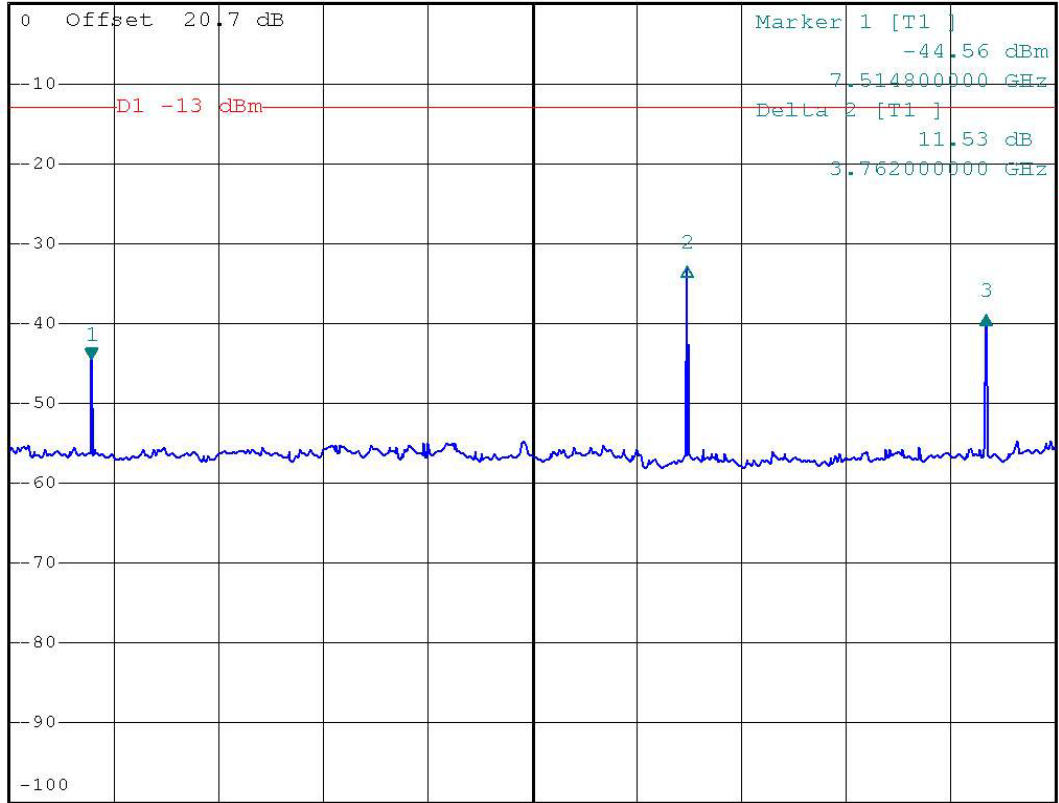

Start 7 GHz

660 MHz/

Stop 13.6 GHz



- Test Mode : PCS 1900 CH661
- Frequency Range : 13.6G-19.1G



*RBW 1 MHz Marker 1 [T1]
*VBW 3 MHz -36.84 dBm
*SWT 500 ms 18.715000000 GHz

Ref 0 dBm

*Att 0 dB

1 PK
VIEW

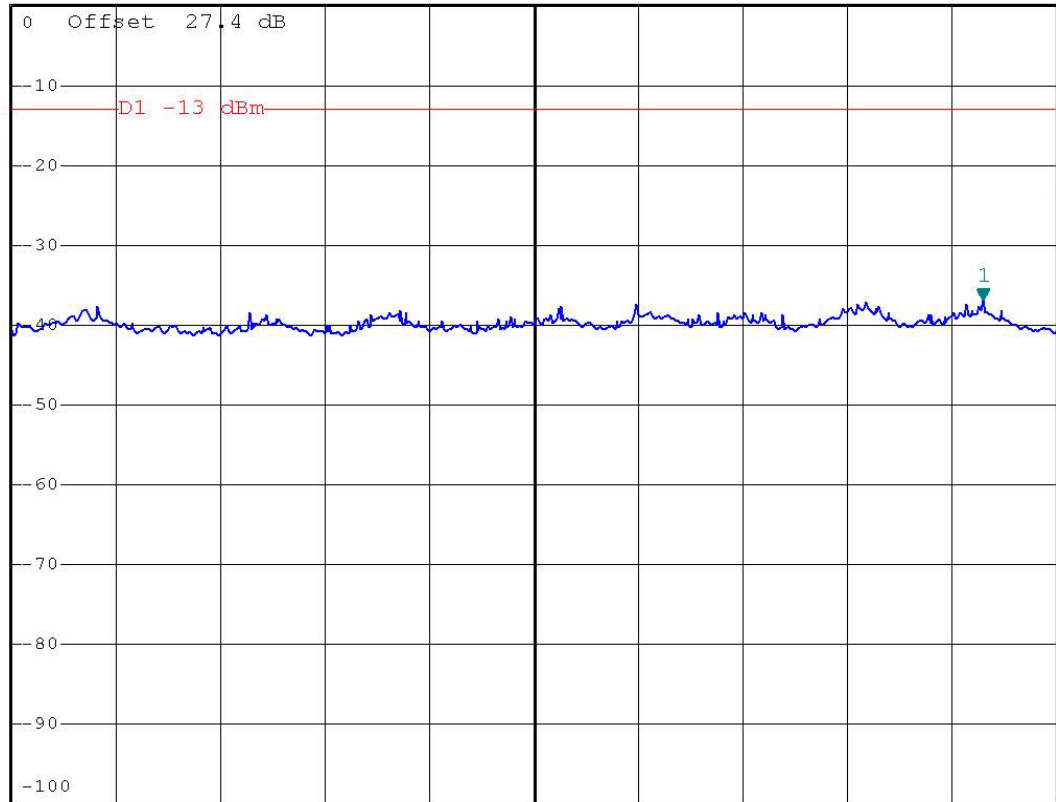

Start 13.6 GHz

550 MHz/

Stop 19.1 GHz

4.6 Field Strength of Spurious Radiation

Equivalent isotropic radiated Power Measurements by substitution method according to ANSI/TIA/EIA-603-A.

4.6.1 Measurement Instruments

As described in chapter 5 of this test report.

4.6.2 Test Procedure

1. The EUT was placed on a rotatable wooden table with 0.8 meter about ground.
2. The EUT was set 3 meters from the receiving antenna which was mounted on the antenna tower.
3. The table was rotated 360 degrees to determine the position of the highest spurious emission.
4. The height of the receiving antenna is varied between one meter and four meters to reach the maximum spurious emission for both horizontal and vertical polarizations.
5. Taking the record of maximum spurious emission.
6. A Horn antenna was substituted in place of the EUT and was driven by a signal generator.
7. The conducted power at the terminal of the Horn antenna is measured.
8. Repeat step 3 to step 5.

4.6.3 Test Setup Layout

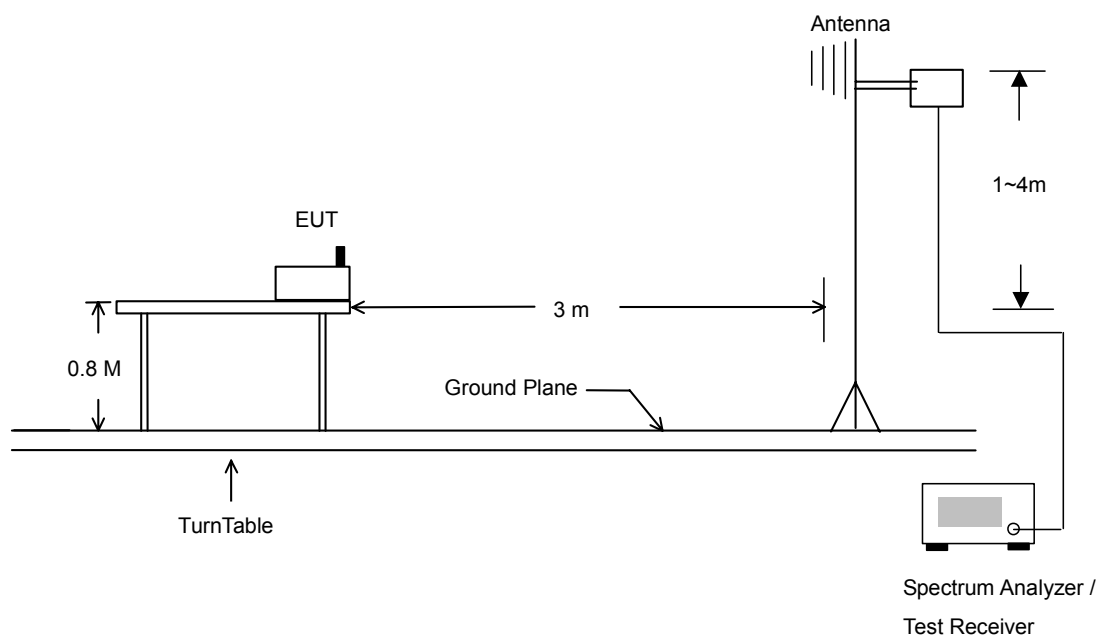



4.6.4 Test Result

- Test Mode : PCS 1900 CH 661

PCS1900 Radiated Spurious EIRP							
H Polarization				V Polarization			
Frequency (MHz)	EIRP (dBm)	Limit (dBm)	Margin (dB)	Frequency (MHz)	EIRP (dBm)	Limit (dBm)	Margin (dB)
30.000	-70.650	-13	-57.65	46.740	-62.580	-13	-49.58
102.630	-74.630	-13	-61.63	58.890	-66.340	-13	-53.34
129.630	-74.490	-13	-61.49	91.290	-70.290	-13	-57.29
381.900	-74.360	-13	-61.35	400.800	-67.480	-13	-54.48
402.900	-76.070	-13	-63.07	449.800	-74.550	-13	-61.55
532.400	-75.800	-13	-62.80	894.300	-69.110	-13	-56.11
3758.000	-36.544	-13	-23.54	1118.000	-51.605	-13	-38.60
7518.000	-38.278	-13	-25.28	3758.000	-29.186	-13	-16.19
9398.000	-35.863	-13	-22.86	7518.000	-41.931	-13	-28.93
11278.000	-35.365	-13	-22.36	9398.000	-38.687	-13	-25.69
				11278.000	-39.045	-13	-26.04



4.6.5 Test Data

Horizontal Polarization

	Freq	Level	Over Limit	Limit Line	ReadAntenna Level	Antenna Factor	Preamp Factor	Cable Loss	Remark	Ant Pos	Table Pos
	MHz	dBm	dB	dBm	dBm	dB	dB	dB		cm	deg
1 @	30.00	-70.65	-57.65	-13.00	-71.01	0.36	0.00	0.00	Peak	---	---
2	102.63	-74.63	-61.63	-13.00	-62.36	-12.27	0.00	0.00	Peak	---	---
3	129.63	-74.49	-61.49	-13.00	-61.91	-12.59	0.00	0.00	Peak	---	---

	Freq	Level	Over Limit	Limit Line	ReadAntenna Level	Antenna Factor	Preamp Factor	Cable Loss	Remark	Ant Pos	Table Pos
	MHz	dBm	dB	dBm	dBm	dB	dB	dB		cm	deg
1	381.90	-74.36	-61.36	-13.00	-67.26	-7.10	0.00	0.00	Peak	---	---
2	402.90	-76.07	-63.07	-13.00	-69.61	-6.46	0.00	0.00	Peak	---	---
3	532.40	-75.80	-62.80	-13.00	-71.13	-4.67	0.00	0.00	Peak	---	---

	Freq	Level	Over Limit	Limit Line	ReadAntenna Level	Antenna Factor	Preamp Factor	Cable Loss	Remark	Ant Pos	Table Pos
	MHz	dBm	dB	dBm	dBm	dB	dB	dB		cm	deg
1 @	1874.00	-53.61	-40.61	-13.00	-53.10	-0.51	0.00	0.00	Peak	---	---
2 @	1958.00	-41.85	-28.85	-13.00	-40.74	-1.11	0.00	0.00	Peak	---	---

Remak:

- #1: MS TCH Signal
- #2: BS TCH Signal

	Freq	Level	Over Limit	Limit Line	ReadAntenna Level	Antenna Factor	Preamp Factor	Cable Loss	Remark	Ant Pos	Table Pos
	MHz	dBm	dB	dBm	dBm	dB	dB	dB		cm	deg
1 @	3758.00	-36.54	-23.54	-13.00	-44.47	7.92	0.00	0.00	Peak	---	---

	Freq	Level	Over Limit	Limit Line	ReadAntenna Level	Antenna Factor	Preamp Factor	Cable Loss	Remark	Ant Pos	Table Pos
	MHz	dBm	dB	dBm	dBm	dB	dB	dB		cm	deg
1 @	7518.00	-38.28	-25.28	-13.00	-54.08	15.80	0.00	0.00	Peak	---	---

	Freq	Level	Over Limit	Limit Line	ReadAntenna Level	Antenna Factor	Preamp Factor	Cable Loss	Remark	Ant Pos	Table Pos
	MHz	dBm	dB	dBm	dBm	dB	dB	dB		cm	deg
1 @	9398.00	-35.86	-22.86	-13.00	-54.09	18.22	0.00	0.00	Peak	---	---

	Freq	Level	Over Limit	Limit Line	ReadAntenna Level	Antenna Factor	Preamp Factor	Cable Loss	Remark	Ant Pos	Table Pos
	MHz	dBm	dB	dBm	dBm	dB	dB	dB		cm	deg
1 @	11278.00	-35.36	-22.36	-13.00	-55.66	20.30	0.00	0.00	Peak	---	---



Vertical Polarization

	Freq	Level	Over Limit	Limit Line	ReadAntenna Level	Antenna Factor	Preamp Factor	Cable Loss	Remark	Ant Pos	Table Pos
	MHz	dBm	dB	dBm	dBm	dB	dB	dB		cm	deg
1 @	46.74	-62.58	-49.58	-13.00	-48.86	-13.72	0.00	0.00	Peak	---	---
2 @	58.89	-66.34	-53.34	-13.00	-52.77	-13.56	0.00	0.00	Peak	---	---
3 @	91.29	-70.29	-57.29	-13.00	-61.35	-8.95	0.00	0.00	Peak	---	---

	Freq	Level	Over Limit	Limit Line	ReadAntenna Level	Antenna Factor	Preamp Factor	Cable Loss	Remark	Ant Pos	Table Pos
	MHz	dBm	dB	dBm	dBm	dB	dB	dB		cm	deg
1 @	400.80	-67.48	-54.48	-13.00	-63.16	-4.32	0.00	0.00	Peak	---	---
2 @	449.80	-74.55	-61.55	-13.00	-70.82	-3.73	0.00	0.00	Peak	---	---
3 @	894.30	-69.11	-56.11	-13.00	-70.93	1.82	0.00	0.00	Peak	---	---

	Freq	Level	Over Limit	Limit Line	ReadAntenna Level	Antenna Factor	Preamp Factor	Cable Loss	Remark	Ant Pos	Table Pos
	MHz	dBm	dB	dBm	dBm	dB	dB	dB		cm	deg
1 @	1118.00	-51.60	-38.60	-13.00	-50.93	-0.68	0.00	0.00	Peak	---	---
2 @	1874.00	-41.58	-28.58	-13.00	-41.18	-0.40	0.00	0.00	Peak	---	---
3 @	1958.00	-42.50	-29.50	-13.00	-41.91	-0.60	0.00	0.00	Peak	---	---

Remak:

- #2: MS TCH Signal
- #3: BS TCH Signal

	Freq	Level	Over Limit	Limit Line	ReadAntenna Level	Antenna Factor	Preamp Factor	Cable Loss	Remark	Ant Pos	Table Pos
	MHz	dBm	dB	dBm	dBm	dB	dB	dB		cm	deg
1 @	3758.00	-29.19	-16.19	-13.00	-35.82	6.64	0.00	0.00	Peak	---	---

	Freq	Level	Over Limit	Limit Line	ReadAntenna Level	Antenna Factor	Preamp Factor	Cable Loss	Remark	Ant Pos	Table Pos
	MHz	dBm	dB	dBm	dBm	dB	dB	dB		cm	deg
1 @	7518.00	-41.93	-28.93	-13.00	-55.30	13.37	0.00	0.00	Peak	---	---

	Freq	Level	Over Limit	Limit Line	ReadAntenna Level	Antenna Factor	Preamp Factor	Cable Loss	Remark	Ant Pos	Table Pos
	MHz	dBm	dB	dBm	dBm	dB	dB	dB		cm	deg
1 @	9398.00	-38.69	-25.69	-13.00	-55.89	17.20	0.00	0.00	Peak	---	---

	Freq	Level	Over Limit	Limit Line	ReadAntenna Level	Antenna Factor	Preamp Factor	Cable Loss	Remark	Ant Pos	Table Pos
	MHz	dBm	dB	dBm	dBm	dB	dB	dB		cm	deg
1 @	11278.00	-39.04	-26.04	-13.00	-57.92	18.87	0.00	0.00	Peak	---	---

4.7 Frequency Stability (Temperature Variation)

4.7.1 Measurement Instrument

As described in chapter 5 of this test report.

4.7.2 Test Procedure

1. The EUT and test equipment were set up as shown on the following section.
2. With all power removed, the temperature was decreased to -30°C and permitted to stabilize for three hours. Power was applied and the maximum change in frequency was noted within one minute.
3. With power OFF, the temperature was raised in 10°C steps. The sample was permitted to stabilize at each step for at least one-half hour. Power was applied and the maximum frequency change was noted within one minute.
4. The temperature tests were performed for the worst case.
5. Test data was recorded.

4.7.3 Test Setup Layout

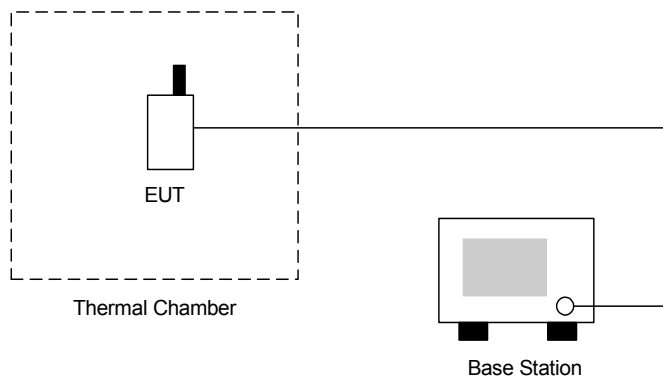

4.7.4 Test Result

- Test Mode : PCS 1900 CH661

Temperature(°C)	Change (Hz)	Change (ppm)	Limit (ppm)	Result
-30	-128	-0.07	2.5	Passed
-20	-125	-0.07		
-10	-100	-0.05		
0	-112	-0.06		
10	-98	-0.05		
20	-106	-0.06		
30	-93	-0.05		
40	-96	-0.05		
50	-41	-0.02		

4.8 Frequency Stability (Voltage Variation)

4.8.1 Measurement Instrument

As described in chapter 5 of this test report.

4.8.2 Test Procedure

1. The EUT was placed in a temperature chamber at $25\pm 5^{\circ}\text{C}$ and connected as the following section.
2. The power supply voltage to the EUT was varied from BEP to 115% of the nominal value measured at the input to the EUT.
3. The variation in frequency was measured for the worst case.

4.8.3 Test Setup Layout

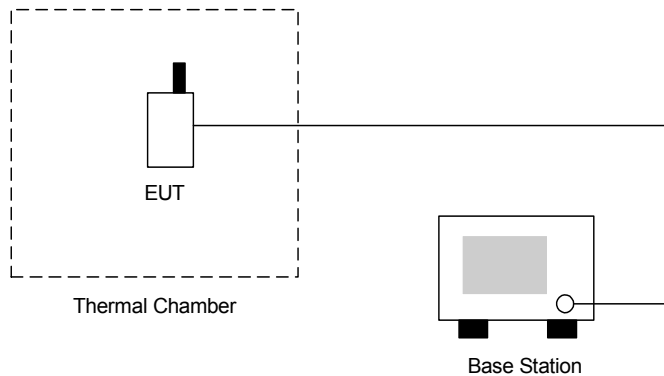

4.8.4 Test Result

- Test Mode : PCS 1900 CH661

Voltage(Volt)	Change (Hz)	Change (ppm)	Limit (ppm)	Result
3.7	-93	-0.05	2.5	Passed
BEP	-65	-0.03		
4.255	-84	-0.04		

Remark:

1. Normal Voltage=3.7V
2. Battery End Point (BEP)=3.4V

**5. List of Measurement Equipments**

Instrument	Manufacturer	Model No.	Serial No.	Characteristics	Calibration Date	Due Date	Remark
Spectrum analyzer	R&S	FSP40	100057	9KHz-40GHz	Feb. 26, 2004	Feb. 26, 2005	Radiation (03CH06-HY)
Bilog Antenna	SCHAFFNER	CBL6112B	2885	30MHz -2GHz	Dec. 18, 2003	Dec. 18, 2004	Radiation (03CH06-HY)
Horn Antenna	Com-Power	AH118	071025	1G-18G	Feb. 11, 2004	Feb. 11, 2005	Radiation (03CH06-HY)
PreAmplifier	Com-Power	PA-103	161055	1MHz - 1000MHz	Apr. 26, 2004	Apr. 26, 2005	Radiation (03CH06-HY)
HF Amplifier	MITEQ	AFS44	973248	0.1G - 26.5G	May. 20, 2004	May. 20, 2005	Radiation (03CH06-HY)
Base Station	Agilent	E5515C	GB43460754	N/A	Jan. 12, 2004	Jan. 12, 2005	Base Station
Radio	R&S	CMU200	105934	N/A	Aug. 24, 2004	Aug. 24, 2005	Base Station
Thermal Chamber	Ten Billion	TTH-D35P	N/A	N/A	NCR	NCR	EMS Chamber



6. Uncertainty Evaluation

Uncertainty of Conducted Emission Evaluation (30kHz ~ 1000MHz)

Contribution	Uncertainty of x_i		$u(x_i)$
	dB	Probability Distribution	
Receiver reading	0.41	Normal(k=2)	0.21
Antenna factor calibration	0.83	Normal(k=2)	0.42
Cable loss calibration	0.25	Normal(k=2)	0.13
Pre Amplifier Gain calibration	0.27	Normal(k=2)	0.14
RCV/SPA specification	2.50	Rectangular	0.72
Antenna Factor Interpolation for Frequency	1.00	Rectangular	0.29
Site imperfection	1.43	Rectangular	0.83
Mismatch Receiver VSWR $\Gamma_1 = 0.20$ Antenna VSWR $\Gamma_2 = 0.23$ Uncertainty = $20\log(1-\Gamma_1*\Gamma_2)$	+0.39/-0.41	U-shaped	0.28
combined standard uncertainty $U_c(y)$	1.27		
Measuring uncertainty for a level of confidence of 95% $U=2U_c(y)$	2.54		

Uncertainty of Radiated Emission Evaluation (1GHz ~ 40GHz)

Contribution	Uncertainty of x_i		$u(x_i)$	C_i	$C_i * u(x_i)$
	dB	Probability Distribution			
Receiver reading	± 0.10	Normal(k=1)	0.10	1	0.10
Antenna factor calibration	± 1.70	Normal(k=2)	0.85	1	0.85
Cable loss calibration	± 0.50	Normal(k=2)	0.25	1	0.25
Receiver Correction	± 2.00	Rectangular	1.15	1	1.15
Antenna Factor Directional	± 1.50	Rectangular	0.87	1	0.87
Site imperfection	± 2.80	Triangular	1.14	1	1.14
Mismatch Receiver VSWR $\Gamma_1 = 0.197$ Antenna VSWR $\Gamma_2 = 0.194$ Uncertainty = $20\log(1-\Gamma_1*\Gamma_2*\Gamma_3)$	+0.34/-0.35	U-shaped	0.244	1	0.244
Combined standard uncertainty $U_c(y)$	2.36				
Measuring uncertainty for a level of confidence of 95% $U=2U_c(y)$	4.72				

$$U = \sqrt{\{(1/2)^2 + (0.3/2)^2 + (2^2 + 0.5^2 + 2^2 + 0.25^2 + 2^2)/3 + (0.54)^2/2\}} = 2.2 \text{ for 10m test distance}$$

$$U = \sqrt{\{(1/2)^2 + (0.3/2)^2 + (2^2 + 3^2 + 2^2 + 0.25^2 + 2^2)/3 + (0.54)^2/2\}} = 2.7 \text{ for 3m test distance}$$

END OF TEST REPORT