

APPENDIX 4

BLOCK DIAGRAM/SCHEMATICS OF EUT

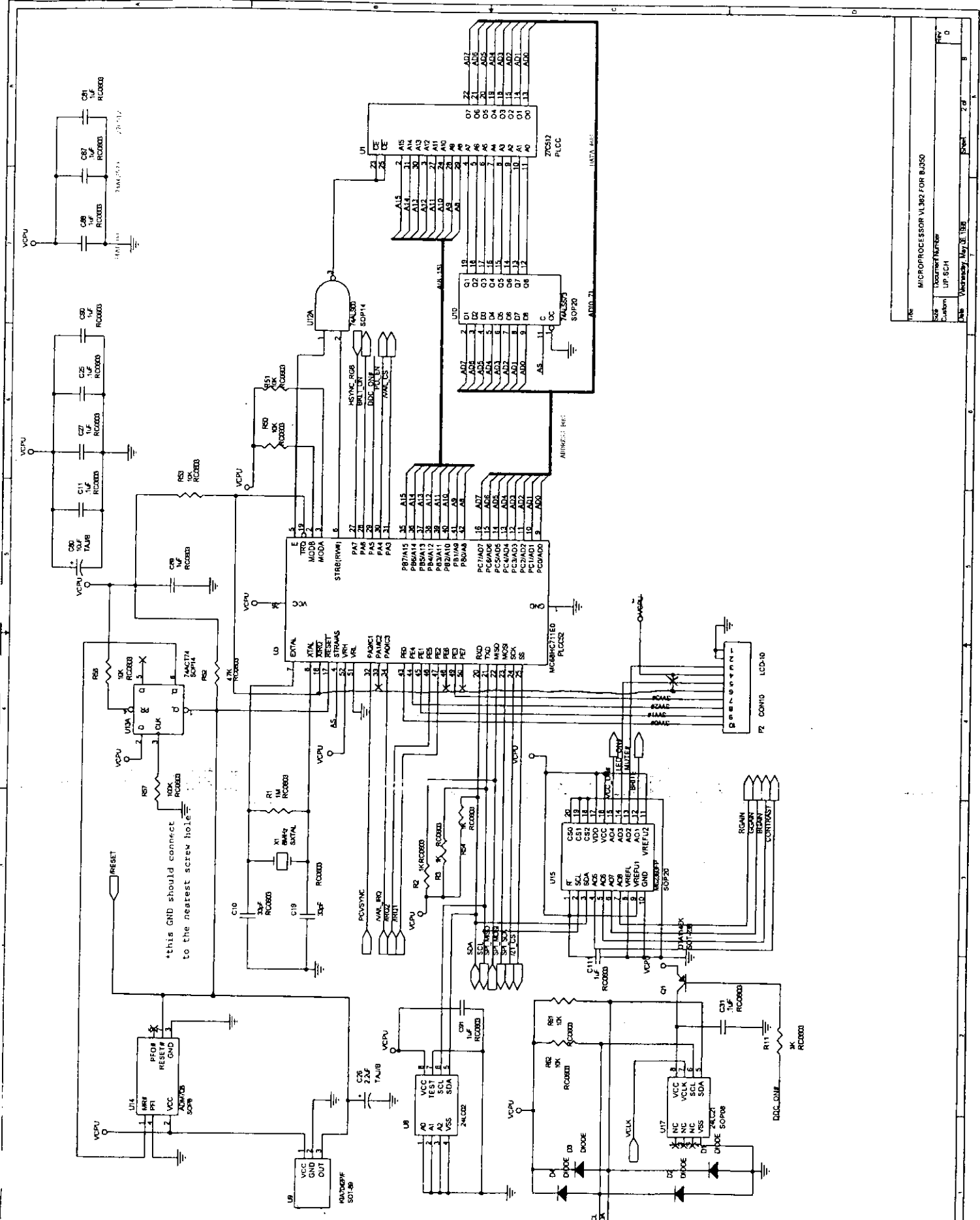

*this GND should connect
to the nearest screw hole

REV	1	DATE	7/88
DOC	MICROPROCESSOR V1.002 FOR BU350		
APP	UP SCH		
DES	Wednesday, May 18, 1988		

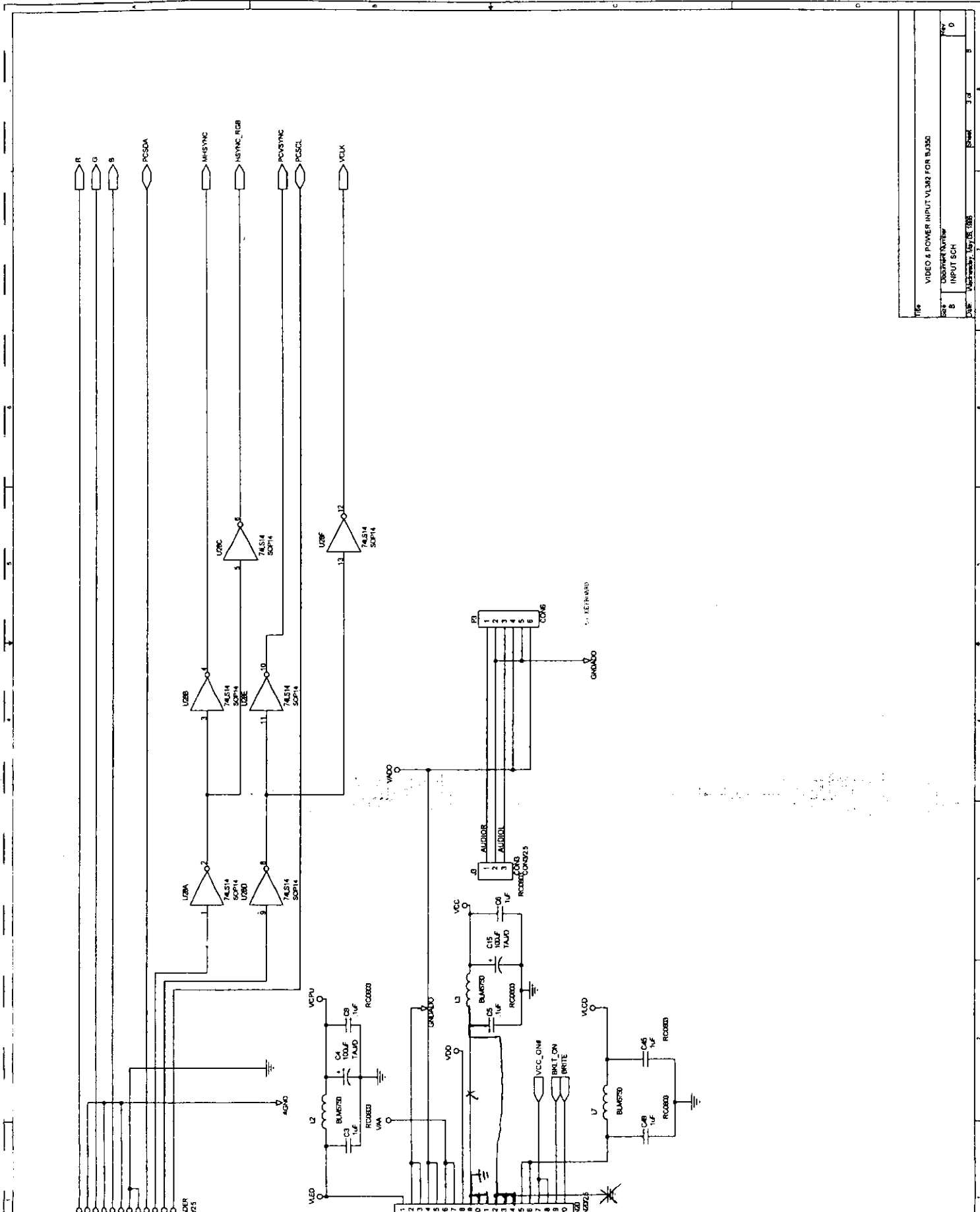

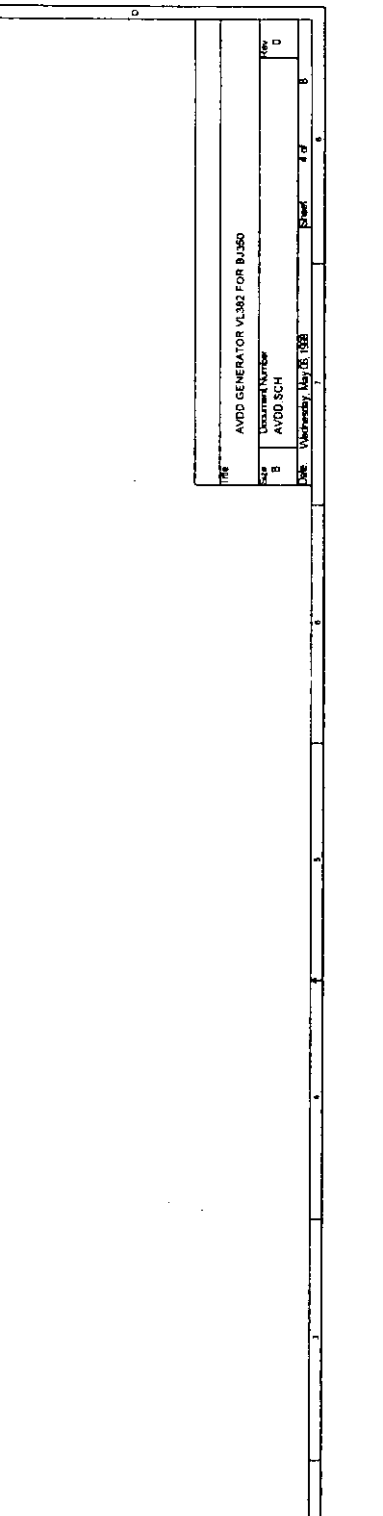
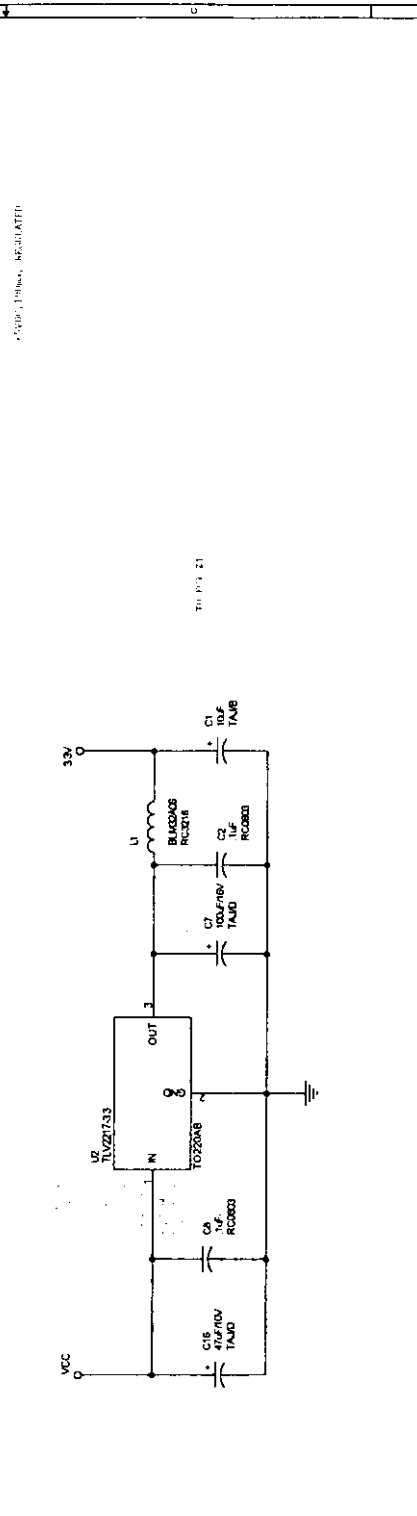
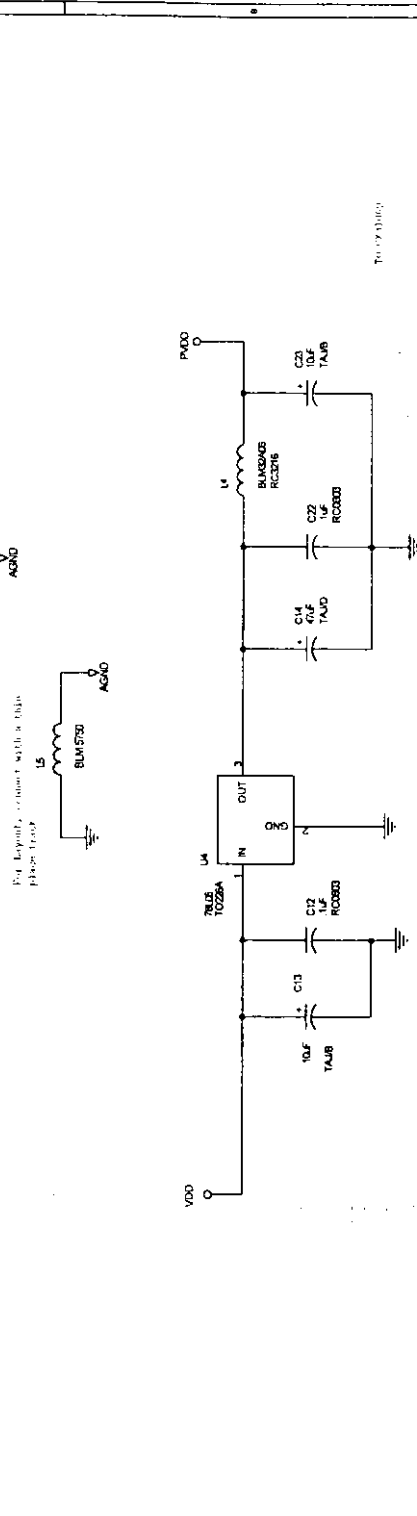
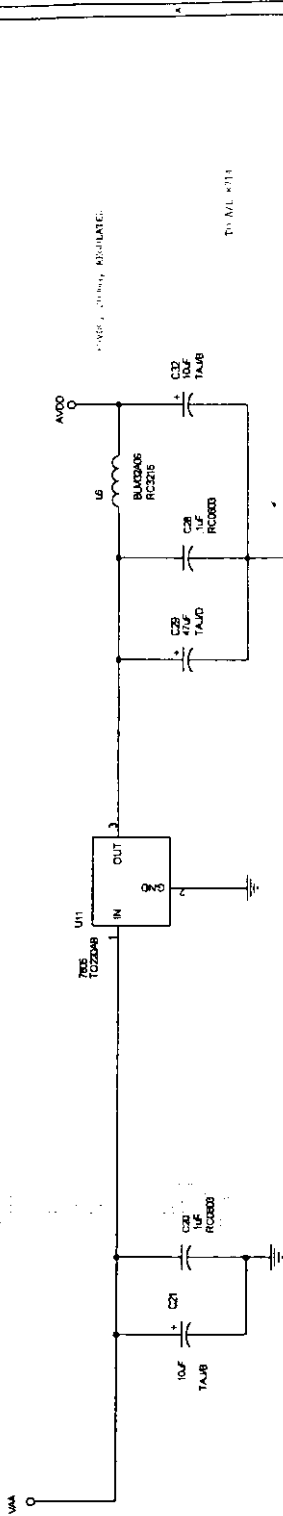

AVDD GENERATOR V1.382 FOR BJ150	
Rev	1
Doc Number	AVDD SCH
Date	Wednesday, May 16, 1990
Sheet	1 of 1

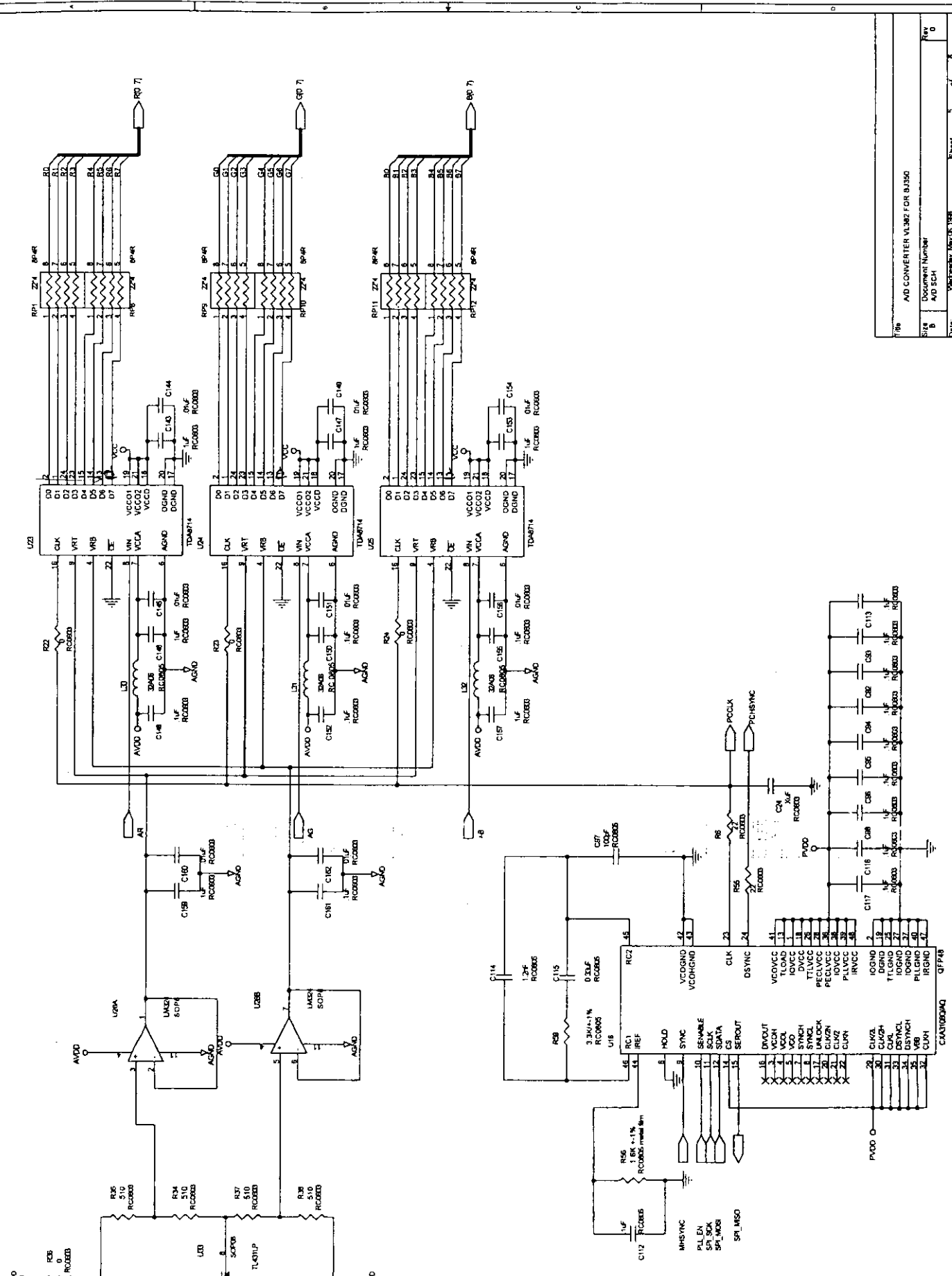

Title		AD CONVERTER V1.302 FOR BJ350	
Size	B	Document Number	
Date	Wednesday, May 15, 1996	Sheet	5 of 8
Rev	0		

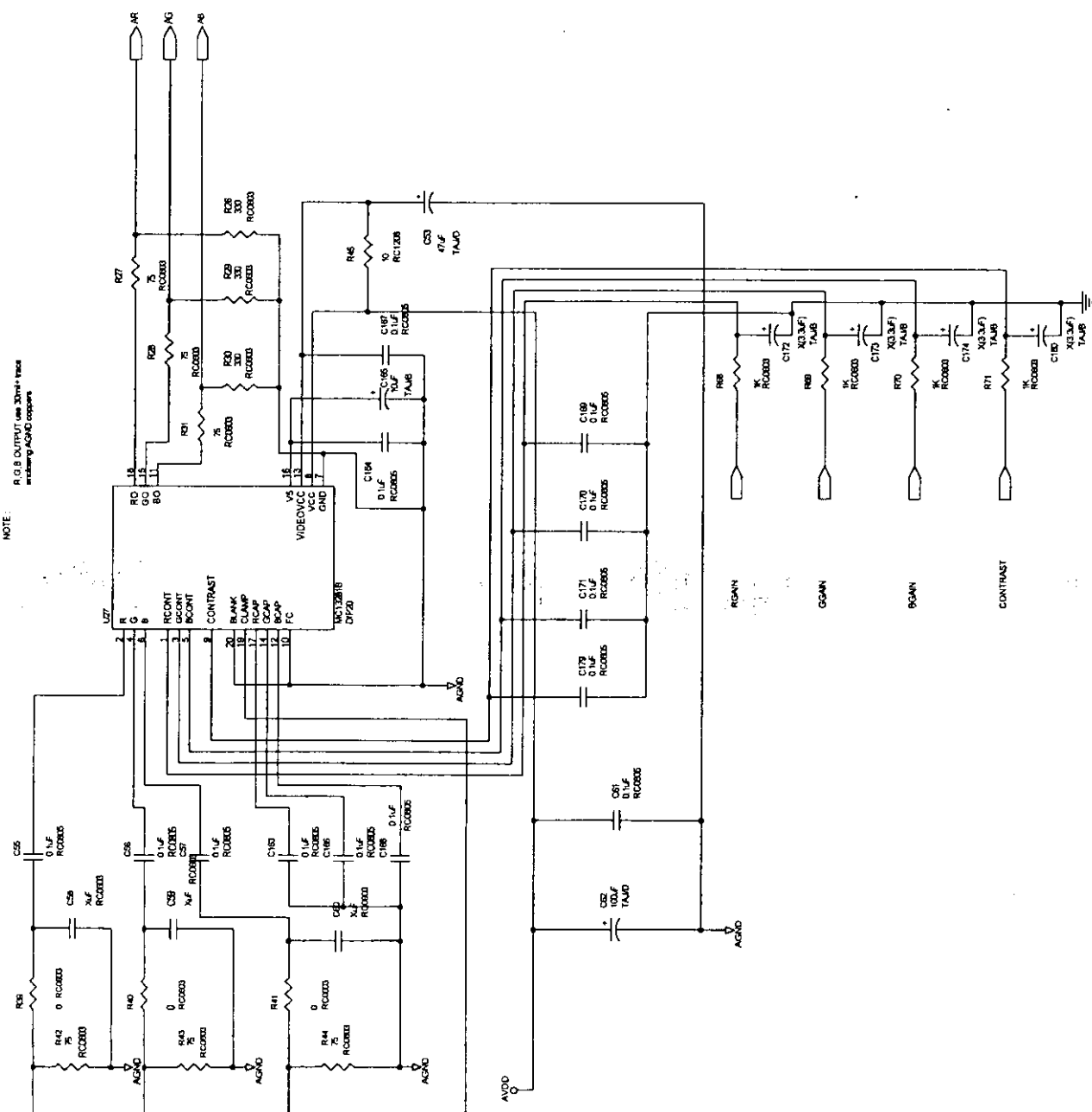

NOTE:
R.G.B. OUTPUT use 30pin+ trace
matching AGND coplanar.

186	PRE_AMP VLSI2 FOR B350
234	Document Number
235	Current
236	PRE_AMP SCH
237	Rev
238	20
239	Sheet
240	5 of 8
241	Tuesday, December 16, 1997

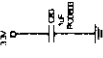

F5A01-11

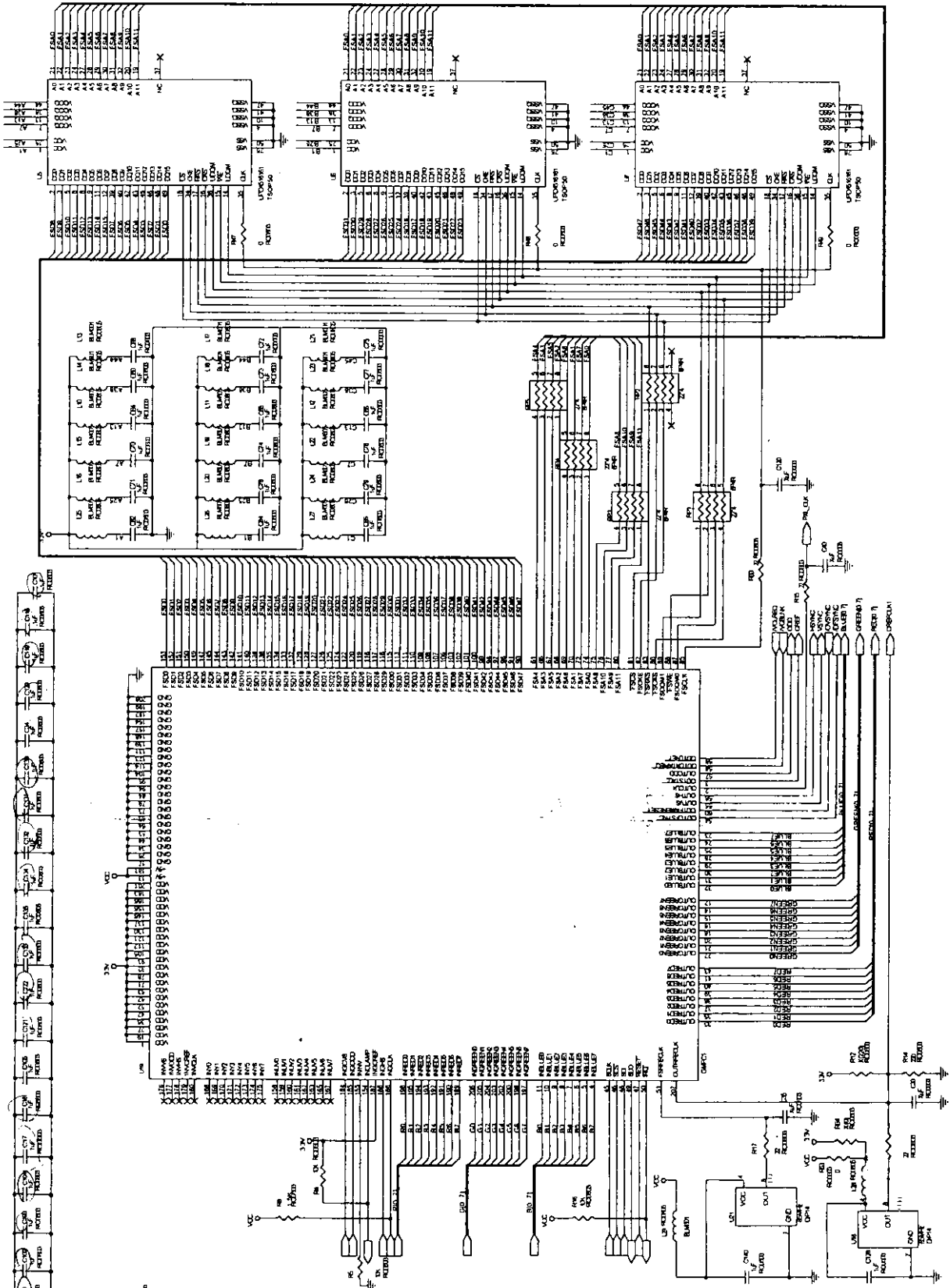
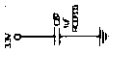
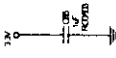

THE FRAME RATE CONVERSION UNIT FOR 6130
 SIZE 1000000000
 PC 504
 DATE 11/11/70

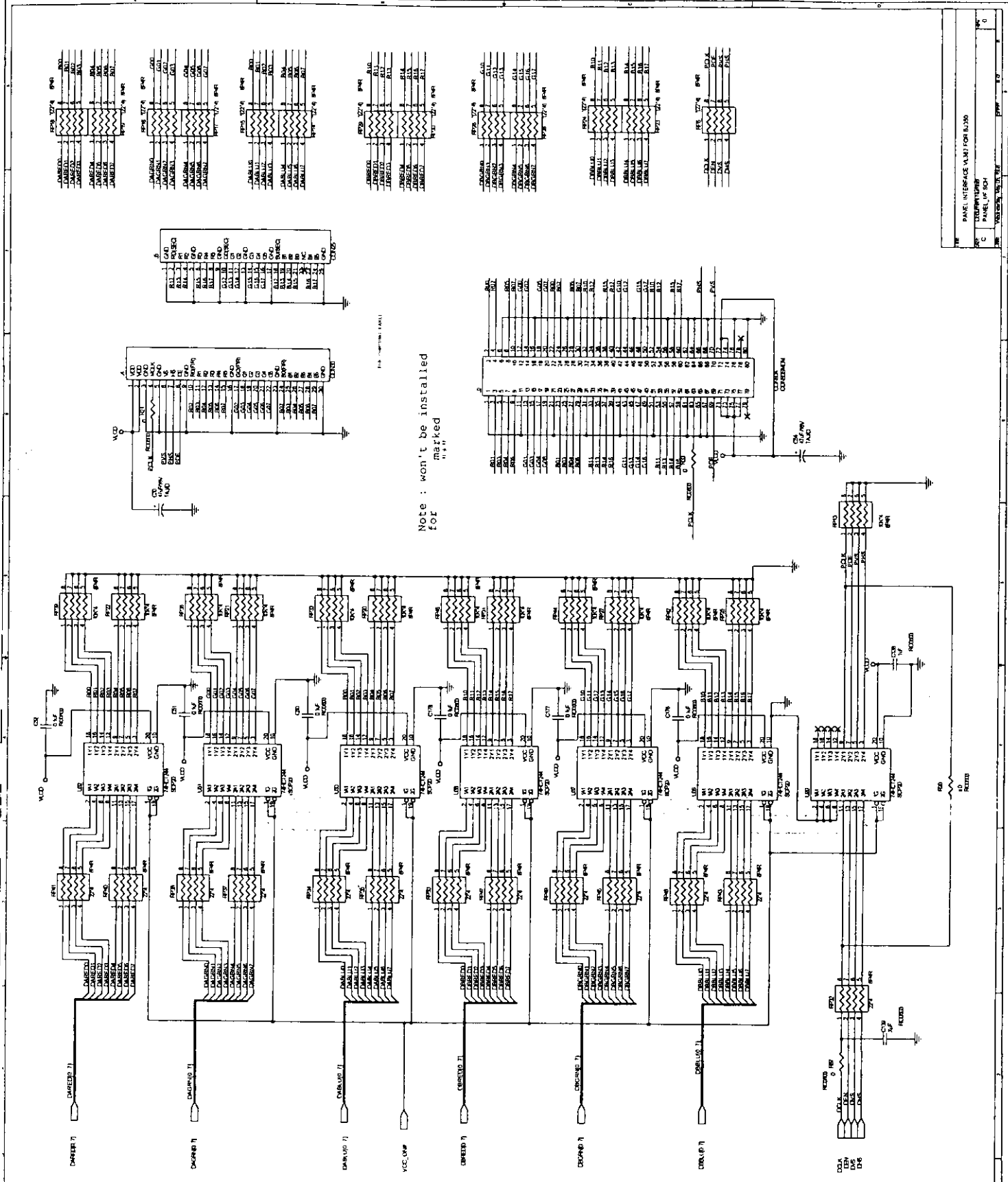

Note: won't be installed for 11, 11A

