

SUPPLEMENTAL “UP LINK CARRIER AGGREGATION” TEST REPORT

OF

Applicant: Compal Electronics, Inc
No.581 & 581-1, Ruiguang Rd., Neihu District, Taipei, (114)
Taiwan

Product Name: 5G M.2 Module

Brand Name: Compal

Model No.: RXM-G1

Model Difference: N/A

Report Number: E2/2019/A0032

FCC ID GKRRXMG1

FCC Rule Part: 2 , 22H & 24E & 27C & 96

Issue Date: Jul. 03, 2020

Date of Test: Feb. 17, 2020 ~ Jun. 23, 2020

Date of EUT Received: Oct. 31, 2019

We hereby certify that:

The above equipment was tested by SGS Taiwan Ltd. Central RF Lab The test data, data evaluation, test procedures, and equipment configurations shown in this report were made in accordance with the procedures given in ANSI C63.26-2015 and the energy emitted by the sample EUT tested as described in this report is in compliance with conducted and radiated emission limits.

The test results of this report relate only to the tested sample identified in this report.

Approved By:**Blue Yang / Asst. Manager**

Unless otherwise stated the results shown in this test report refer only to the sample(s) tested and such sample(s) are retained for 90 days only.

除非另有說明，此報告結果僅對測試之樣品負責，同時此樣品僅保留90天。本報告未經本公司書面許可，不可部份複製。

This document is issued by the Company subject to its General Conditions of Service printed overleaf, available on request or accessible at <http://www.sgs.com.tw/Terms-and-Conditions> and for electronic format documents, subject to Terms and Conditions for Electronic Documents at <http://www.sgs.com.tw/Terms-and-Conditions>. Attention is drawn to the limitation of liability, indemnification and jurisdiction issues defined therein. Any holder of this document is advised that information contained hereon reflects the Company's findings at the time of its intervention only and within the limits of Client's instructions, if any. The Company's sole responsibility is to its Client and this document does not exonerate parties to a transaction from exercising all their rights and obligations under the transaction documents. This document cannot be reproduced except in full, without prior written approval of the Company. Any unauthorized alteration, forgery or falsification of the content or appearance of this document is unlawful and offenders may be prosecuted to the fullest extent of the law.

Revision History

Report Number	Revision	Description	Issue Date	Remark
E2/2019/A0032	Rev.00	Original.	Jul. 03, 2020	Revised By: Karen Huang

Note:

1、Disclaimer

Antenna information is provided by the applicant, test results of this report are applicable to the sample EUT received.

Unless otherwise stated the results shown in this test report refer only to the sample(s) tested and such sample(s) are retained for 90 days only.

除非另有說明，此報告結果僅對測試之樣品負責，同時此樣品僅保留90天。本報告未經本公司書面許可，不可部份複製。

This document is issued by the Company subject to its General Conditions of Service printed overleaf, available on request or accessible at <http://www.sgs.com.tw/Terms-and-Conditions> and for electronic format documents, subject to Terms and Conditions for Electronic Documents at <http://www.sgs.com.tw/Terms-and-Conditions>. Attention is drawn to the limitation of liability, indemnification and jurisdiction issues defined therein. Any holder of this document is advised that information contained hereon reflects the Company's findings at the time of its intervention only and within the limits of Client's instructions, if any. The Company's sole responsibility is to its Client and this document does not exonerate parties to a transaction from exercising all their rights and obligations under the transaction documents. This document cannot be reproduced except in full, without prior written approval of the Company. Any unauthorized alteration, forgery or falsification of the content or appearance of this document is unlawful and offenders may be prosecuted to the fullest extent of the law.

Contents

1	GENERAL PRODUCT INFORMATION.....	4
2	SYSTEM TEST CONFIGURATION.....	8
3	SUMMARY OF TEST RESULTS.....	10
4	DESCRIPTION OF TEST MODES.....	11
5	MEASUREMENT UNCERTAINTY	17
6	MAXMUM OUTPUT POWER.....	18
7	OCCUPIED BANDWIDTH MEASUREMENT.....	25
8	OUT OF BAND EMISSION AT ANTENNA TERMINALS.....	47
9	FIELD STRENGTH OF SPURIOUS RADIATION MEASUREMENT	61
10	FREQUENCY STABILITY MEASUREMENT	156
11	PEAK TO AVERAGE RATIO.....	161

Unless otherwise stated the results shown in this test report refer only to the sample(s) tested and such sample(s) are retained for 90 days only.

除非另有說明，此報告結果僅對測試之樣品負責，同時此樣品僅保留90天。本報告未經本公司書面許可，不可部份複製。

This document is issued by the Company subject to its General Conditions of Service printed overleaf, available on request or accessible at <http://www.sgs.com.tw/Terms-and-Conditions> and for electronic format documents, subject to Terms and Conditions for Electronic Documents at <http://www.sgs.com.tw/Terms-and-Conditions>. Attention is drawn to the limitation of liability, indemnification and jurisdiction issues defined therein. Any holder of this document is advised that information contained hereon reflects the Company's findings at the time of its intervention only and within the limits of Client's instructions, if any. The Company's sole responsibility is to its Client and this document does not exonerate parties to a transaction from exercising all their rights and obligations under the transaction documents. This document cannot be reproduced except in full, without prior written approval of the Company. Any unauthorized alteration, forgery or falsification of the content or appearance of this document is unlawful and offenders may be prosecuted to the fullest extent of the law.

1 GENERAL PRODUCT INFORMATION

1.1 Product Description

General:

Product Name:	5G M.2 Module
Brand Name:	Compal
Model No.:	RXM-G1
Model Difference:	N/A
Hardware Version:	DVT-1
Software Version:	RXMG1.00.00.036
Power Supply:	DC 3.3V
IMEI:	359047100009060

Unless otherwise stated the results shown in this test report refer only to the sample(s) tested and such sample(s) are retained for 90 days only.

除非另有說明，此報告結果僅對測試之樣品負責，同時此樣品僅保留90天。本報告未經本公司書面許可，不可部份複製。

This document is issued by the Company subject to its General Conditions of Service printed overleaf, available on request or accessible at <http://www.sgs.com.tw/Terms-and-Conditions> and for electronic format documents, subject to Terms and Conditions for Electronic Documents at <http://www.sgs.com.tw/Terms-and-Conditions>. Attention is drawn to the limitation of liability, indemnification and jurisdiction issues defined therein. Any holder of this document is advised that information contained hereon reflects the Company's findings at the time of its intervention only and within the limits of Client's instructions, if any. The Company's sole responsibility is to its Client and this document does not exonerate parties to a transaction from exercising all their rights and obligations under the transaction documents. This document cannot be reproduced except in full, without prior written approval of the Company. Any unauthorized alteration, forgery or falsification of the content or appearance of this document is unlawful and offenders may be prosecuted to the fullest extent of the law.

1.2 Operation Frequency Range

LTE Band	BW (MHz)	Operation Frequency (MHz)		LTE Band	BW (MHz)	Operation Frequency (MHz)	
2	1.4	1850.7	- 1909.3	41	5	2498.5	- 2687.5
	3	1851.5	- 1908.5		10	2501.0	- 2685.0
	5	1852.5	- 1907.5		15	2503.5	- 2682.5
	10	1855.0	- 1905.0		20	2506.0	- 2680.0
	15	1857.5	- 1902.5	48	5	3552.5	- 3697.5
20	1860.0	- 1900.0	10		3555.0	- 3695.0	
4	1.4	1710.7	- 1754.3		15	3557.5	- 3692.5
	3	1711.5	- 1753.5	20	3560.0	- 3690.0	
	5	1712.5	- 1752.5	66	1.4	1710.7	- 1779.3
	10	1715.0	- 1750.0		3	1711.5	- 1778.5
	15	1717.5	- 1747.5		5	1712.5	- 1777.5
20	1720.0	- 1745.0	10		1715.0	- 1775.0	
5	1.4	824.7	- 848.3	15	1717.5	- 1772.5	
	3	825.5	- 847.5	20	1720.0	- 1770.0	
	5	826.5	- 846.5	7	5	2502.5	- 2567.5
	10	829.0	- 844.0		10	2505.0	- 2565.0
7	5	2502.5	- 2567.5		15	2507.5	- 2562.5
	10	2505.0	- 2565.0		20	2510.0	- 2560.0
	15	2507.5	- 2562.5	12	1.4	699.7	- 715.3
	20	2510.0	- 2560.0		3	700.5	- 714.5
12	1.4	699.7	- 715.3		5	701.5	- 713.5
	3	700.5	- 714.5		10	704.0	- 711.0
	5	701.5	- 713.5	13	5	779.5	- 784.5
	10	704.0	- 711.0		10	782	-
13	5	779.5	- 784.5				
	10	782	-				

1.3 Antenna Designation

Vendor	Type	Model Name	Modulation	Frequency (MHz)	Peak Antenna Gain (dBi)
Pulse	PIFA	ANT0	LTE Band 2	1850 ~ 1910	4
			LTE Band 4	1710 ~ 1755	4.5
			LTE Band 5	824 ~ 849	2.9
			LTE Band 7	2500 ~ 2570	3.4
			LTE Band 12	699 ~ 716	2.4
			LTE Band 13	777 ~ 787	3
		ANT2	LTE Band 48	3550 ~ 3700	-2
		ANT0	LTE Band 66	1710 ~ 1780	4.5

Unless otherwise stated the results shown in this test report refer only to the sample(s) tested and such sample(s) are retained for 90 days only.

除非另有說明，此報告結果僅對測試之樣品負責，同時此樣品僅保留90天。本報告未經本公司書面許可，不可部份複製。

This document is issued by the Company subject to its General Conditions of Service printed overleaf, available on request or accessible at <http://www.sgs.com.tw/Terms-and-Conditions> and for electronic format documents, subject to Terms and Conditions for Electronic Documents at <http://www.sgs.com.tw/Terms-and-Conditions>. Attention is drawn to the limitation of liability, indemnification and jurisdiction issues defined therein. Any holder of this document is advised that information contained hereon reflects the Company's findings at the time of its intervention only and within the limits of Client's instructions, if any. The Company's sole responsibility is to its Client and this document does not exonerate parties to a transaction from exercising all their rights and obligations under the transaction documents. This document cannot be reproduced except in full, without prior written approval of the Company. Any unauthorized alteration, forgery or falsification of the content or appearance of this document is unlawful and offenders may be prosecuted to the fullest extent of the law.

1.4 Type of Emission & Max ERP/EIRP Power Measurement Result:

LTE Band	BW	Frequency		Modulation	ERP / EIRP (dBm)		(W)	99%	Type of Emission	Frequency Tolerance (Hz)
5B	15	826.5	846.5	QPSK	26.14	ERP	0.411	18.7580	18M76G7D	20
				16QAM	25.82	ERP	0.382	18.6950	18M70D7W	20
				64QAM	25.07	ERP	0.321	18.6440	18M64D7W	20
				256QAM	21.94	ERP	0.156	18.7580	18M76D7W	20
7C	40	2505.0	2565.0	QPSK	24.49	EIRP	0.281	37.438	37M4G7D	20
				16QAM	23.77	EIRP	0.238	37.340	37M3D7W	20
				64QAM	22.68	EIRP	0.185	37.247	37M2D7W	20
				256QAM	23.62	EIRP	0.230	36.984	37M0D7W	20
41C	25	2498.5	2687.5	QPSK	26.49	EIRP	0.446	37.458	37M5G7D	25
				16QAM	25.49	EIRP	0.354	37.427	37M4D7W	25
				64QAM	24.49	EIRP	0.281	37.435	37M4D7W	25
				256QAM	24.56	EIRP	0.286	37.284	37M3D7W	25
48C	25	3552.5	3697.5	QPSK	19.23	EIRP	0.084	37.405	37M4G7D	25
				16QAM	18.15	EIRP	0.065	37.419	37M4D7W	25
				64QAM	17.98	EIRP	0.063	37.432	37M4D7W	25
				256QAM	19.14	EIRP	0.082	37.304	37M3D7W	25
66B	20	1712.5	1777.5	QPSK	26.38	EIRP	0.435	18.316	18M3G7D	29
				16QAM	25.57	EIRP	0.361	18.285	18M3D7W	29
				64QAM	25.02	EIRP	0.318	18.196	18M2D7W	29
				256QAM	24.43	EIRP	0.277	18.133	18M1D7W	29
66C	40	1712.5	1777.5	QPSK	25.84	EIRP	0.384	37.347	37M3G7D	29
				16QAM	23.92	EIRP	0.247	37.538	37M5D7W	29
				64QAM	24.27	EIRP	0.267	37.353	37M4D7W	29
				256QAM	25.20	EIRP	0.331	37.114	37M1D7W	29

Unless otherwise stated the results shown in this test report refer only to the sample(s) tested and such sample(s) are retained for 90 days only.

除非另有說明，此報告結果僅對測試之樣品負責，同時此樣品僅保留90天。本報告未經本公司書面許可，不可部份複製。

This document is issued by the Company subject to its General Conditions of Service printed overleaf, available on request or accessible at <http://www.sgs.com.tw/Terms-and-Conditions> and for electronic format documents, subject to Terms and Conditions for Electronic Documents at <http://www.sgs.com.tw/Terms-and-Conditions>. Attention is drawn to the limitation of liability, indemnification and jurisdiction issues defined therein. Any holder of this document is advised that information contained hereon reflects the Company's findings at the time of its intervention only and within the limits of Client's instructions, if any. The Company's sole responsibility is to its Client and this document does not exonerate parties to a transaction from exercising all their rights and obligations under the transaction documents. This document cannot be reproduced except in full, without prior written approval of the Company. Any unauthorized alteration, forgery or falsification of the content or appearance of this document is unlawful and offenders may be prosecuted to the fullest extent of the law.

1.5 Test Methodology of Applied Standards

FCC 47 CFR Part 2, 22H, 24E, 27C, Part96.

ANSI C63.26-2015

KDB971168 D01 Power Meas license Digital System v03r01

1.6 Test Facility

SGS Taiwan Ltd. Central RF Lab (TAF code 3702)

No.2, Keji 1st Rd., Guishan District, Taoyuan City, Taiwan 333

FCC Designation number: TW0028

1.7 Special Accessories

No special accessories were used during testing.

1.8 Equipment Modifications

There was no modifications incorporated into the EUT.

1.9 Radiated Emission Test Sites for Measurements from 9 kHz to 30 MHz

Radiated emission below 30MHz is measured in a 9m*9m*6m semi-anechoic chamber, the measurements correspond to those obtained at an open-field test site.

There is a comparison data of both open-field test site and semi-Anechoic chamber, and the result came out very similar.

Unless otherwise stated the results shown in this test report refer only to the sample(s) tested and such sample(s) are retained for 90 days only.

除非另有說明，此報告結果僅對測試之樣品負責，同時此樣品僅保留90天。本報告未經本公司書面許可，不可部份複製。

This document is issued by the Company subject to its General Conditions of Service printed overleaf, available on request or accessible at <http://www.sgs.com.tw/Terms-and-Conditions> and for electronic format documents, subject to Terms and Conditions for Electronic Documents at <http://www.sgs.com.tw/Terms-and-Conditions>. Attention is drawn to the limitation of liability, indemnification and jurisdiction issues defined therein. Any holder of this document is advised that information contained hereon reflects the Company's findings at the time of its intervention only and within the limits of Client's instructions, if any. The Company's sole responsibility is to its Client and this document does not exonerate parties to a transaction from exercising all their rights and obligations under the transaction documents. This document cannot be reproduced except in full, without prior written approval of the Company. Any unauthorized alteration, forgery or falsification of the content or appearance of this document is unlawful and offenders may be prosecuted to the fullest extent of the law.

2 SYSTEM TEST CONFIGURATION

2.1 EUT Configuration

The EUT configuration for testing is installed on RF field strength measurement to meet the Commissions requirement and operating in a manner which intends to maximize its emission characteristics in a continuous normal application.

2.2 EUT Exercise

The EUT (Transmitter) was operated in the continuous transmission mode employed with the simulator of the Base Station that fixates at test default channels to fix the Tx frequency which was for the purpose of the measurements.

2.3 Test Procedure

2.3.1 Conducted Measurement at Antenna Port

The EUT is placed on a table which is 0.8 m above ground plane. A low loss of RF cable was used to connect the antenna port of EUT to measurement equipment.

2.3.2 Radiated Emissions (ERP/EIRP)

The EUT is placed on a turn table, for emission measurements below 1 GHz is 0.8 m above ground plane, for emission measurements above 1 GHz, the table height shall be 1.5 m. The turn table shall rotate 360 degrees to determine the position of maximum emission level. EUT is set 3m away from the receiving antenna which varied from 1m to 4m to find out the highest emission. And also, each emission was to be maximized by changing the polarization of receiving antenna both Horizontal and Vertical. In order to find out the max. emission, the relative positions of this hand-held transmitter (EUT) was rotated through three orthogonal axes and measurement procedures for electric field radiated emissions above 1 GHz the EUT measurement is to be made “while keeping the antenna in the ‘cone of radiation’ from that area and pointed at the area both in azimuth and elevation, with polarization oriented for maximum response.” is still within the 3dB illumination BW of the measurement antenna according to the requirements in Section 8 and 13.

2.4 Measurement Results Explanation Example

For all conducted test items:

The offset level is set in the spectrum analyzer to compensate the RF cable loss and attenuation factor between EUT conducted port and spectrum analyzer. With the offset compensation, the spectrum analyzer reading level is exactly EUT RF output level.

Note:

The spectrum analyzer offset is derived from RF cable loss and attenuator factor.

Following shows an offset computation in physical test.

	RF cable loss (dB)	Attenuation factor(dB)	offset(dB)
Low Band (Below 1GHz)	3.6	10	13.6
High Band (Above 1 GHz)	3.8	10	13.8

Unless otherwise stated the results shown in this test report refer only to the sample(s) tested and such sample(s) are retained for 90 days only.

除非另有說明，此報告結果僅對測試之樣品負責，同時此樣品僅保留90天。本報告未經本公司書面許可，不可部份複製。

This document is issued by the Company subject to its General Conditions of Service printed overleaf, available on request or accessible at <http://www.sgs.com.tw/Terms-and-Conditions> and for electronic format documents, subject to Terms and Conditions for Electronic Documents at <http://www.sgs.com.tw/Terms-and-Conditions>. Attention is drawn to the limitation of liability, indemnification and jurisdiction issues defined therein. Any holder of this document is advised that information contained hereon reflects the Company's findings at the time of its intervention only and within the limits of Client's instructions, if any. The Company's sole responsibility is to its Client and this document does not exonerate parties to a transaction from exercising all their rights and obligations under the transaction documents. This document cannot be reproduced except in full, without prior written approval of the Company. Any unauthorized alteration, forgery or falsification of the content or appearance of this document is unlawful and offenders may be prosecuted to the fullest extent of the law.

2.5 Final Amplifier Voltage and Current Information:

Test Mode	DC voltage (V)	DC current (mA)
LTE Band 5B	3.3	490
LTE Band 7C		490
LTE Band 41C		480
LTE Band48C		490
LTE Band66B		490
LTE Band66C		480

2.6 Configuration of Tested System

Fig. 2-1 Configuration of Tested System (Fixed Channel-Conducted)

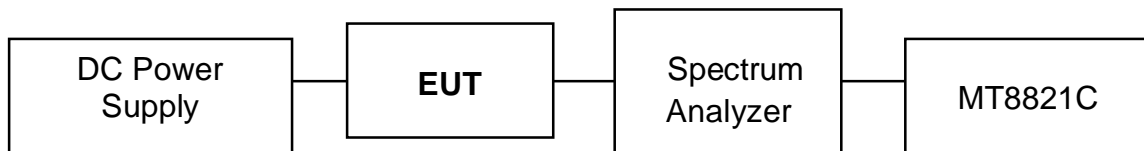

Fig. 2-2 Configuration of Tested System (Fixed Channel-Radiated)

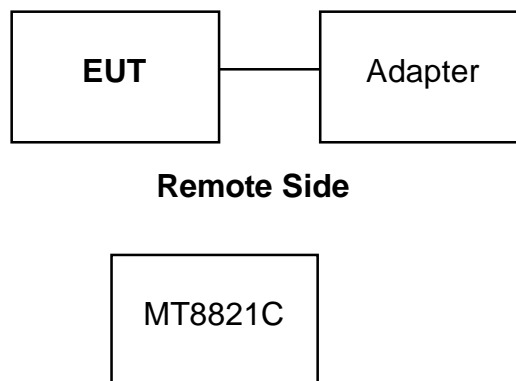

Table 2-1 Equipment Used in

Item	Equipment	Mfr/Brand	Model/ Type No.	Series No.	Data Cable	Power Cord
1.	Radio Communication Analyzer	Anritsu	MT8821C	6261786084	shielded	Un-shielded

Unless otherwise stated the results shown in this test report refer only to the sample(s) tested and such sample(s) are retained for 90 days only.

除非另有說明，此報告結果僅對測試之樣品負責，同時此樣品僅保留90天。本報告未經本公司書面許可，不可部份複製。

This document is issued by the Company subject to its General Conditions of Service printed overleaf, available on request or accessible at <http://www.sgs.com.tw/Terms-and-Conditions> and for electronic format documents, subject to Terms and Conditions for Electronic Documents at <http://www.sgs.com.tw/Terms-and-Conditions>. Attention is drawn to the limitation of liability, indemnification and jurisdiction issues defined therein. Any holder of this document is advised that information contained hereon reflects the Company's findings at the time of its intervention only and within the limits of Client's instructions, if any. The Company's sole responsibility is to its Client and this document does not exonerate parties to a transaction from exercising all their rights and obligations under the transaction documents. This document cannot be reproduced except in full, without prior written approval of the Company. Any unauthorized alteration, forgery or falsification of the content or appearance of this document is unlawful and offenders may be prosecuted to the fullest extent of the law.

3 SUMMARY OF TEST RESULTS

FCC Rules	Description Of Test	Result
§2.1046(a)	RF Power Output	Compliant
§22.913(a)(5) §24.232(c) §27.50(c)(10) §27.50(h)(2) §27.50(d)(4) §27.50(b)(10) §96.41(b)	ERP/ EIRP measurement	Compliant
§2.1049(h)	99% & 26dB Occupied Bandwidth	Compliant
§2.1051 §22.917(a) §24.238(a) §27.53(g) §27.53(c)(2)(4) §27.53(h) §27.53(m)(4)(6) §96.41(e)	Out of Band Emissions at Antenna Terminals and Band Edge / Emission mask requirements	Compliant
§2.1053 §22.917(a) §24.238(a) §27.53(c)(2)(4) §27.53(f) §27.53(h) §96.41(e)	Field Strength of Spurious Radiation	Compliant
§24.232(d) §27.50((B) §96.41(g)	Peak to Average Ratio	Compliant
§2.1055(a)(1) §22.355 §24.235 §27.54	Frequency Stability	Compliant

Unless otherwise stated the results shown in this test report refer only to the sample(s) tested and such sample(s) are retained for 90 days only.

除非另有說明，此報告結果僅對測試之樣品負責，同時此樣品僅保留90天。本報告未經本公司書面許可，不可部份複製。

This document is issued by the Company subject to its General Conditions of Service printed overleaf, available on request or accessible at <http://www.sgs.com.tw/Terms-and-Conditions> and for electronic format documents, subject to Terms and Conditions for Electronic Documents at <http://www.sgs.com.tw/Terms-and-Conditions>. Attention is drawn to the limitation of liability, indemnification and jurisdiction issues defined therein. Any holder of this document is advised that information contained hereon reflects the Company's findings at the time of its intervention only and within the limits of Client's instructions, if any. The Company's sole responsibility is to its Client and this document does not exonerate parties to a transaction from exercising all their rights and obligations under the transaction documents. This document cannot be reproduced except in full, without prior written approval of the Company. Any unauthorized alteration, forgery or falsification of the content or appearance of this document is unlawful and offenders may be prosecuted to the fullest extent of the law.

4 DESCRIPTION OF TEST MODES

4.1 The Test Channel Details

This device is 5G M.2 Module that support with carrier aggregation (two carrier) uplink Intra-Band contiguous and Inter-Band non-contiguous specification as below:

E-UTRA Intra-Band CA configuration / Bandwidth combination set					
E-UTRA CA configuration	Uplink CA configurations	Component carriers in order of increasing carrier frequency		Maximum aggregated bandwidth [MHz]	Bandwidth combination set
		Channel bandwidth for carrier [MHz]	Channel bandwidth for carrier [MHz]		
CA_5B	CA_5B	5,10	10	20	0
		10	5		
CA_7C	CA_7C	15	15	40	0
		20	20		
		10	20		
		15	15,20	40	1
		20	10,15,20		
		15	10,15	40	2
		20	15,20		
CA_41C	CA_41C	10	20	40	0
		15	15,20		
		20	10,15,20		
		5,10	20	40	1
		15	15,20		
		20	5,10,15,20		
		10	15,20	40	2
		15	10,15,20		
		20	10,15,20		
		10	20	40	3
20	20				
CA_48C	CA_48C	5,10,15,20	20	40	0
		20	5,10,15		
CA_66B	CA_66B	5	5,10,15	20	0
		10	5,10		
		15	5		
CA_66C	CA_66C	5	20	40	0
		10	15,20		
		15	10,15,20		
		20	5,10,15,20		

Intra-Band Test Mode	Band	Description
1	5B	CA_PCC Ant0 Band 5_ SCC Ant 0 Band 5
2	7C	CA_PCC Ant0 Band 7_ SCC Ant 0 Band 7
3	41C	CA_PCC Ant0 Band 41_ SCC Ant 0 Band 41
4	48C	CA_PCC Ant0 Band 48_ SCC Ant 0 Band 48
5	66B	CA_PCC Ant0 Band 66_ SCC Ant 0 Band 66
6	66C	CA_PCC Ant0 Band 66_ SCC Ant 0 Band 66

Unless otherwise stated the results shown in this test report refer only to the sample(s) tested and such sample(s) are retained for 90 days only.

除非另有說明，此報告結果僅對測試之樣品負責，同時此樣品僅保留90天。本報告未經本公司書面許可，不可部份複製。

This document is issued by the Company subject to its General Conditions of Service printed overleaf, available on request or accessible at <http://www.sgs.com.tw/Terms-and-Conditions> and for electronic format documents, subject to Terms and Conditions for Electronic Documents at <http://www.sgs.com.tw/Terms-and-Conditions>. Attention is drawn to the limitation of liability, indemnification and jurisdiction issues defined therein. Any holder of this document is advised that information contained hereon reflects the Company's findings at the time of its intervention only and within the limits of Client's instructions, if any. The Company's sole responsibility is to its Client and this document does not exonerate parties to a transaction from exercising all their rights and obligations under the transaction documents. This document cannot be reproduced except in full, without prior written approval of the Company. Any unauthorized alteration, forgery or falsification of the content or appearance of this document is unlawful and offenders may be prosecuted to the fullest extent of the law.

E-UTRA Inter-Band CA configuration / Bandwidth combination set									
Uplink CA configurations (NOTE 4)	E-UTRA Bands	1.4 MHz	3 MHz	5 MHz	10 MHz	15 MHz	20 MHz	Maximum aggregated bandwidth [MHz]	Bandwidth combination set
CA_2A-5A	2			Yes	Yes	Yes	Yes	30	0
	5			Yes	Yes				
	2			Yes	Yes			20	1
	5			Yes	Yes				
CA_2A_12A	2			Yes	Yes	Yes	Yes	30	0
	12			Yes	Yes				
	2			Yes	Yes	Yes	Yes	30	1
	12		Yes	Yes	Yes				
	2			Yes	Yes			20	2
12			Yes	Yes					
CA_2A-13A	2			Yes	Yes	Yes	Yes	30	0
	13				Yes				
	2			Yes	Yes			20	1
	13				Yes				
CA_4A-5A	4			Yes	Yes			20	0
	5			Yes	Yes				
	4			Yes	Yes	Yes	Yes	30	1
	5			Yes	Yes				
CA_4A-12A	4	Yes	Yes	Yes	Yes			20	0
	12			Yes	Yes				
	4	Yes	Yes	Yes	Yes	Yes	Yes	30	1
	12			Yes	Yes				
	4			Yes	Yes	Yes	Yes	30	2
	12		Yes	Yes	Yes				
	4			Yes	Yes			20	3
	12			Yes	Yes				
	4			Yes	Yes	Yes	Yes	30	4
	12			Yes	Yes				
4			Yes	Yes	Yes		20	5	
12			Yes						
CA_4A-13A	4			Yes	Yes	Yes	Yes	30	0
	13				Yes				
	4			Yes	Yes			20	1
	13				Yes				
CA_5A-7A	5	Yes	Yes	Yes	Yes			30	0
	7				Yes	Yes	Yes		
	5			Yes	Yes			30	1
7				Yes	Yes	Yes			
CA_5A-66A	5			Yes	Yes			30	0
	66			Yes	Yes	Yes	Yes		
CA_12A-66A	12			Yes	Yes			20	0
	66	Yes	Yes	Yes	Yes				
	12			Yes	Yes			30	1
	66	Yes	Yes	Yes	Yes	Yes	Yes		
	12		Yes	Yes	Yes			30	2
66			Yes	Yes	Yes	Yes			

Unless otherwise stated the results shown in this test report refer only to the sample(s) tested and such sample(s) are retained for 90 days only.

除非另有說明，此報告結果僅對測試之樣品負責，同時此樣品僅保留90天。本報告未經本公司書面許可，不可部份複製。

This document is issued by the Company subject to its General Conditions of Service printed overleaf, available on request or accessible at <http://www.sgs.com.tw/Terms-and-Conditions> and for electronic format documents, subject to Terms and Conditions for Electronic Documents at <http://www.sgs.com.tw/Terms-and-Conditions>. Attention is drawn to the limitation of liability, indemnification and jurisdiction issues defined therein. Any holder of this document is advised that information contained hereon reflects the Company's findings at the time of its intervention only and within the limits of Client's instructions, if any. The Company's sole responsibility is to its Client and this document does not exonerate parties to a transaction from exercising all their rights and obligations under the transaction documents. This document cannot be reproduced except in full, without prior written approval of the Company. Any unauthorized alteration, forgery or falsification of the content or appearance of this document is unlawful and offenders may be prosecuted to the fullest extent of the law.

12			Yes	Yes			20	3
66			Yes	Yes				
12			Yes	Yes			30	4
66			Yes	Yes	Yes	Yes		
12			Yes				20	5
66			Yes	Yes	Yes			

Inter-Band Test Mode	PCC & SCC Bands
1	CA_PCC Ant0 Band 2_ SCC Ant 0 Band 5
2	CA_PCC Ant0 Band 2_ SCC Ant 0 Band 12
3	CA_PCC Ant0 Band 2_ SCC Ant 0 Band 13
4	CA_PCC Ant0 Band 4_ SCC Ant 0 Band 5
5	CA_PCC Ant0 Band 4_ SCC Ant 0 Band 12
6	CA_PCC Ant0 Band 4_ SCC Ant 0 Band 13
7	CA_PCC Ant0 Band 5_ SCC Ant 0 Band 7
8	CA_PCC Ant0 Band 5_ SCC Ant 0 Band 66
9	CA_PCC Ant0 Band 12_ SCC Ant 0 Band 66

Unless otherwise stated the results shown in this test report refer only to the sample(s) tested and such sample(s) are retained for 90 days only.

除非另有說明，此報告結果僅對測試之樣品負責，同時此樣品僅保留90天。本報告未經本公司書面許可，不可部份複製。

This document is issued by the Company subject to its General Conditions of Service printed overleaf, available on request or accessible at <http://www.sgs.com.tw/Terms-and-Conditions> and for electronic format documents, subject to Terms and Conditions for Electronic Documents at <http://www.sgs.com.tw/Terms-and-Conditions>. Attention is drawn to the limitation of liability, indemnification and jurisdiction issues defined therein. Any holder of this document is advised that information contained hereon reflects the Company's findings at the time of its intervention only and within the limits of Client's instructions, if any. The Company's sole responsibility is to its Client and this document does not exonerate parties to a transaction from exercising all their rights and obligations under the transaction documents. This document cannot be reproduced except in full, without prior written approval of the Company. Any unauthorized alteration, forgery or falsification of the content or appearance of this document is unlawful and offenders may be prosecuted to the fullest extent of the law.

4.2 The Worst-Case Test Modes and Details

1. This EUT is UE LTE 4G 1Tx/2Rx device for single carrier with ANT0 that can support uplink Band 2/4/5/7/12/13/41/48/66 and Intra-Band carrier aggregation (CA) uplink. For operation of uplink CA mode, the transmitter enabled by 2Tx/2Rx mode with ANT0.
2. The worst-case scenario for all measurements is based on the average conducted output power measurement investigation results. Output power measurements were measured on QPSK, 16QAM, 64QAM and 256QAM modulations. It was found that QPSK results the highest, hence all testing was performed using QPSK modulations to represent the worst case.
3. For Band Edge and Emission Mask: The widest and narrowest BW combinations were tested. Combinations of same BW is considered equivalent. The RB combinations were selected as the signal activated closest to the band limit for determining the worst case scenario.
4. For Out of Band Emissions: The widest and narrowest combinations was tested. The RB combination generates the highest power was determined as the worst case scenario.
5. For occupied bandwidth, frequency stability and conducted unwanted emission measurements, due to each single LTE Band standalone transmission generates higher power than the **inter-band** transmissions, the test results are only demonstrated for each single LTE band standalone transmission in test report E2/2019/A0029 as the worst case scenarios. In addition, the radiated unwanted emissions of **inter-band** has been evaluated as no noticeable emissions, therefore, the conducted unwanted emissions was not tested.
6. For peak to average ratio measurements, due to each single LTE Band standalone transmission generates higher power than the **inter-band** transmissions, the test results are only demonstrated for each single LTE band standalone transmission in test report E2/2019/A0029 as the worst case scenarios.

Unless otherwise stated the results shown in this test report refer only to the sample(s) tested and such sample(s) are retained for 90 days only.

除非另有說明，此報告結果僅對測試之樣品負責，同時此樣品僅保留90天。本報告未經本公司書面許可，不可部份複製。

This document is issued by the Company subject to its General Conditions of Service printed overleaf, available on request or accessible at <http://www.sgs.com.tw/Terms-and-Conditions> and for electronic format documents, subject to Terms and Conditions for Electronic Documents at <http://www.sgs.com.tw/Terms-and-Conditions>. Attention is drawn to the limitation of liability, indemnification and jurisdiction issues defined therein. Any holder of this document is advised that information contained hereon reflects the Company's findings at the time of its intervention only and within the limits of Client's instructions, if any. The Company's sole responsibility is to its Client and this document does not exonerate parties to a transaction from exercising all their rights and obligations under the transaction documents. This document cannot be reproduced except in full, without prior written approval of the Company. Any unauthorized alteration, forgery or falsification of the content or appearance of this document is unlawful and offenders may be prosecuted to the fullest extent of the law.

SGS Taiwan Ltd.

No. 134, Wu Kung Road, New Taipei Industrial Park, Wuku District, New Taipei City, Taiwan/新北市五股區新北產業園區五工路 134 號

台灣檢驗科技股份有限公司

t (886-2) 2299-3279

f (886-2) 2298-0488

www.sgs.com.tw

Member of SGS Group

4.2.1 Intra-Band

For uplink Intra-Band CA, evaluation has been done for contiguous and non-contiguous channel and bandwidth, configurations that generates highest output power in standalone transmission have been selected for the final test.

Intra-band Test Mode	Band	Test Item	Modulation	PCC			SCC		
				Band width	Channel	RB Mode	Band width	Channel	RB Mode
1	5B	EIRP & Radiated Emission	QPSK	5 MHz	20428	Full	10MHz	20500	Full
				5 MHz	20478	Full	10MHz	20550	Full
				5 MHz	20528	Full	10MHz	20600	Full
2	7C	EIRP & Radiated Emission	QPSK	20 MHz	20850	Full	20 MHz	21048	Full
				20 MHz	21001	Full	20 MHz	21199	Full
				20 MHz	21152	Full	20 MHz	21350	Full
3	41C	EIRP & Radiated Emission	QPSK	5 MHz	39683	Full	20 MHz	39800	Full
				5 MHz	40528	Full	20 MHz	40645	Full
				5 MHz	41373	Full	20 MHz	41490	Full
4	48C	EIRP & Radiated Emission	QPSK	5 MHz	55273	Full	20 MHz	55390	Full
				5 MHz	55898	Full	20 MHz	56015	Full
				5 MHz	56523	Full	20 MHz	56640	Full
5	66B	EIRP & Radiated Emission	QPSK	15 MHz	132047	Full	5 MHz	132140	Full
				15 MHz	132398	Full	5 MHz	132491	Full
				15 MHz	132549	Full	5 MHz	132642	Full
6	66C	EIRP & Radiated Emission	QPSK	20 MHz	132072	Full	5 MHz	132189	Full
				20 MHz	132397	Full	5 MHz	132514	Full
				20 MHz	132522	Full	5 MHz	132639	Full

Unless otherwise stated the results shown in this test report refer only to the sample(s) tested and such sample(s) are retained for 90 days only.

除非另有說明，此報告結果僅對測試之樣品負責，同時此樣品僅保留90天。本報告未經本公司書面許可，不可部份複製。

This document is issued by the Company subject to its General Conditions of Service printed overleaf, available on request or accessible at <http://www.sgs.com.tw/Terms-and-Conditions> and for electronic format documents, subject to Terms and Conditions for Electronic Documents at <http://www.sgs.com.tw/Terms-and-Conditions>. Attention is drawn to the limitation of liability, indemnification and jurisdiction issues defined therein. Any holder of this document is advised that information contained hereon reflects the Company's findings at the time of its intervention only and within the limits of Client's instructions, if any. The Company's sole responsibility is to its Client and this document does not exonerate parties to a transaction from exercising all their rights and obligations under the transaction documents. This document cannot be reproduced except in full, without prior written approval of the Company. Any unauthorized alteration, forgery or falsification of the content or appearance of this document is unlawful and offenders may be prosecuted to the fullest extent of the law.

4.2.2 Inter-Band

For uplink Inter-Band CA configurations, following configurations have been selected for the final test.

Inter-band Test Mode	Test Item	Modulation	PCC			SCC		
			Band width	Channel	RB Mode	Band width	Channel	RB Mode
1	EIRP & Radiated Emission	QPSK	5 MHz	18625	1 RB / 0 RB	5 MHz	20425	1 RB / 0 RB
			5 MHz	18900	1 RB / 0 RB	5 MHz	20525	1 RB / 0 RB
			5 MHz	19175	1 RB / 0 RB	5 MHz	20625	1 RB / 0 RB
2	EIRP & Radiated Emission	QPSK	20 MHz	18700	1 RB / 0 RB	5 MHz	23035	1 RB / 0 RB
			20 MHz	18900	1 RB / 0 RB	5 MHz	23095	1 RB / 0 RB
			20 MHz	19100	1 RB / 0 RB	5 MHz	23155	1 RB / 0 RB
3	EIRP & Radiated Emission	QPSK	20 MHz	18700	1 RB / 0 RB	10 MHz	23230	1 RB / 0 RB
			20 MHz	18900	1 RB / 0 RB	10 MHz	23230	1 RB / 0 RB
			20 MHz	19100	1 RB / 0 RB	10 MHz	23230	1 RB / 0 RB
4	EIRP & Radiated Emission	QPSK	20 MHz	20050	1 RB / 0 RB	5 MHz	20425	1 RB / 0 RB
			20 MHz	20175	1 RB / 0 RB	5 MHz	20525	1 RB / 0 RB
			20 MHz	20300	1 RB / 0 RB	5 MHz	20625	1 RB / 0 RB
5	EIRP & Radiated Emission	QPSK	20 MHz	20050	1 RB / 0 RB	10 MHz	23060	1 RB / 0 RB
			20 MHz	20175	1 RB / 0 RB	10 MHz	23095	1 RB / 0 RB
			20 MHz	20300	1 RB / 0 RB	10 MHz	23130	1 RB / 0 RB
6	EIRP & Radiated Emission	QPSK	20 MHz	20050	1 RB / 0 RB	10 MHz	23230	1 RB / 0 RB
			20 MHz	20175	1 RB / 0 RB	10 MHz	23230	1 RB / 0 RB
			20 MHz	20300	1 RB / 0 RB	10 MHz	23230	1 RB / 0 RB
7	EIRP & Radiated Emission	QPSK	10 MHz	20450	1 RB / 0 RB	20 MHz	20850	1 RB / 0 RB
			10 MHz	20525	1 RB / 0 RB	20 MHz	21100	1 RB / 0 RB
			10 MHz	20600	1 RB / 0 RB	20 MHz	21350	1 RB / 0 RB
8	EIRP & Radiated Emission	QPSK	10 MHz	20450	1 RB / 0 RB	5 MHz	131997	1 RB / 0 RB
			10 MHz	20525	1 RB / 0 RB	5 MHz	132322	1 RB / 0 RB
			10 MHz	20600	1 RB / 0 RB	5 MHz	132647	1 RB / 0 RB
9	EIRP & Radiated Emission	QPSK	5 MHz	23035	1 RB / 0 RB	20 MHz	132072	1 RB / 0 RB
			5 MHz	23095	1 RB / 0 RB	20 MHz	132322	1 RB / 0 RB
			5 MHz	23155	1 RB / 0 RB	20 MHz	132572	1 RB / 0 RB

Unless otherwise stated the results shown in this test report refer only to the sample(s) tested and such sample(s) are retained for 90 days only.

除非另有說明，此報告結果僅對測試之樣品負責，同時此樣品僅保留90天。本報告未經本公司書面許可，不可部份複製。

This document is issued by the Company subject to its General Conditions of Service printed overleaf, available on request or accessible at <http://www.sgs.com.tw/Terms-and-Conditions> and for electronic format documents, subject to Terms and Conditions for Electronic Documents at <http://www.sgs.com.tw/Terms-and-Conditions>. Attention is drawn to the limitation of liability, indemnification and jurisdiction issues defined therein. Any holder of this document is advised that information contained hereon reflects the Company's findings at the time of its intervention only and within the limits of Client's instructions, if any. The Company's sole responsibility is to its Client and this document does not exonerate parties to a transaction from exercising all their rights and obligations under the transaction documents. This document cannot be reproduced except in full, without prior written approval of the Company. Any unauthorized alteration, forgery or falsification of the content or appearance of this document is unlawful and offenders may be prosecuted to the fullest extent of the law.

5 MEASUREMENT UNCERTAINTY

Test Items	Uncertainty
RF Power Output	+/- 1.10 dB
ERP/ EIRP measurement	Vertical Polarization = +/- 4.74dB Horizontal Polarization = +/- 4.62dB
Temperature	+/- 0.65 °C
Humidity	+/- 4.6 %
DC / AC Power Source	DC= +/- 0.13%, AC= +/- 0.2%

Radiated Spurious Emission:

Measurement uncertainty (Polarization : Vertical)	9kHz – 30MHz: +/- 2.87 dB
	30MHz - 180MHz: +/- 3.37dB
	180MHz -417MHz: +/- 3.19dB
	0.417GHz-1GHz: +/- 3.19dB
	1GHz - 18GHz: +/- 4.04dB
	18GHz - 40GHz: +/- 4.04dB

Measurement uncertainty (Polarization : Horizontal)	9kHz – 30MHz: +/- 2.87 dB
	30MHz - 167MHz: +/- 4.22dB
	167MHz -500MHz: +/- 3.44dB
	0.5GHz-1GHz: +/- 3.39dB
	1GHz - 18GHz: +/- 4.08dB
	18GHz - 40GHz: +/- 4.08dB

This uncertainty represents an expanded uncertainty expressed at approximately the 95% confidence level using a coverage factor of k=2.

Unless otherwise stated the results shown in this test report refer only to the sample(s) tested and such sample(s) are retained for 90 days only.

除非另有說明，此報告結果僅對測試之樣品負責，同時此樣品僅保留90天。本報告未經本公司書面許可，不可部份複製。

This document is issued by the Company subject to its General Conditions of Service printed overleaf, available on request or accessible at <http://www.sgs.com.tw/Terms-and-Conditions> and for electronic format documents, subject to Terms and Conditions for Electronic Documents at <http://www.sgs.com.tw/Terms-and-Conditions>. Attention is drawn to the limitation of liability, indemnification and jurisdiction issues defined therein. Any holder of this document is advised that information contained hereon reflects the Company's findings at the time of its intervention only and within the limits of Client's instructions, if any. The Company's sole responsibility is to its Client and this document does not exonerate parties to a transaction from exercising all their rights and obligations under the transaction documents. This document cannot be reproduced except in full, without prior written approval of the Company. Any unauthorized alteration, forgery or falsification of the content or appearance of this document is unlawful and offenders may be prosecuted to the fullest extent of the law.

6 MAXMUM OUTPUT POWER

6.1 Standard Applicable

A base station simulator was used to establish communication with the EUT. Its parameters were set to transmit the maximum power on the EUT. The measured power in the radio frequency on the transmitter output terminals.

6.1.1 ERP/EIRP LIMIT

According to FCC §2.1046

FCC 22.913(a)

(5) mobile transmitters and auxiliary test transmitters must not exceed 7 watts.

FCC 24.232(c)

Mobile and portable stations are limited to 2 W EIRP.

FCC 27.50 (a)

(3) for mobile and portable stations compliant with 3GPP LTE standards transmitting in the 2305-2315 MHz band or the 2350-2360 MHz band are limited to 250 mW/ 5MHz EIRP but may exceed 50 milliwatts within any 1 megahertz of authorized bandwidth.

FCC 27.50 (b)

(9) Control stations and mobile stations transmitting in the 746-757 MHz, 776-788 MHz, and 805-806 MHz bands are limited to 30 watts ERP.

(10) Portable stations (hand-held devices) transmitting in the 746-757 MHz, 776-788 MHz, and 805-806 MHz bands are limited to 3 watts ERP.

FCC 27.50(c)

(9) Control and mobile stations in the 698-746 MHz band are limited to 30 watts ERP.

(10) Portable stations (hand-held devices) are limited to 3 watts ERP.

FCC 27.50(d)

(4) Mobile, and portable (hand-held) stations operating in the 1710-1755 MHz, 1695-1710 MHz and 1755-1780 MHz bands are limited to 1W EIRP.

(7) Mobile, and portable (hand-held) stations operating in the 1710-1755 MHz band are limited to 2 watts EIRP.

FCC 27, 50(h)

(2) Mobile and other user stations transmitting in the BRS and EBS bands are limited to 2 W EIRP.

FCC 96.41(a)

Digital modulation. Systems operating in the Citizens Broadband Radio Service must use digital modulation techniques.

FCC 96.41(b)

Power limits. Unless otherwise specified in this section, the maximum effective isotropic radiated power (EIRP) of any CBSD and End User Device must comply with the limits shown in the table in this paragraph (b):

Unless otherwise stated the results shown in this test report refer only to the sample(s) tested and such sample(s) are retained for 90 days only.

除非另有說明，此報告結果僅對測試之樣品負責，同時此樣品僅保留90天。本報告未經本公司書面許可，不可部份複製。

This document is issued by the Company subject to its General Conditions of Service printed overleaf, available on request or accessible at <http://www.sgs.com.tw/Terms-and-Conditions> and for electronic format documents, subject to Terms and Conditions for Electronic Documents at <http://www.sgs.com.tw/Terms-and-Conditions>. Attention is drawn to the limitation of liability, indemnification and jurisdiction issues defined therein. Any holder of this document is advised that information contained hereon reflects the Company's findings at the time of its intervention only and within the limits of Client's instructions, if any. The Company's sole responsibility is to its Client and this document does not exonerate parties to a transaction from exercising all their rights and obligations under the transaction documents. This document cannot be reproduced except in full, without prior written approval of the Company. Any unauthorized alteration, forgery or falsification of the content or appearance of this document is unlawful and offenders may be prosecuted to the fullest extent of the law.

Device	Maximum EIRP (dBm/10 megahertz)
End User Device	23
Category A CBSD	30
Category B CBSD ¹	47

Category B CBSDs will only be authorized for use after an ESC is approved and commercially deployed consistent with §§96.15 and 96.67.

6.2 Test Set-up

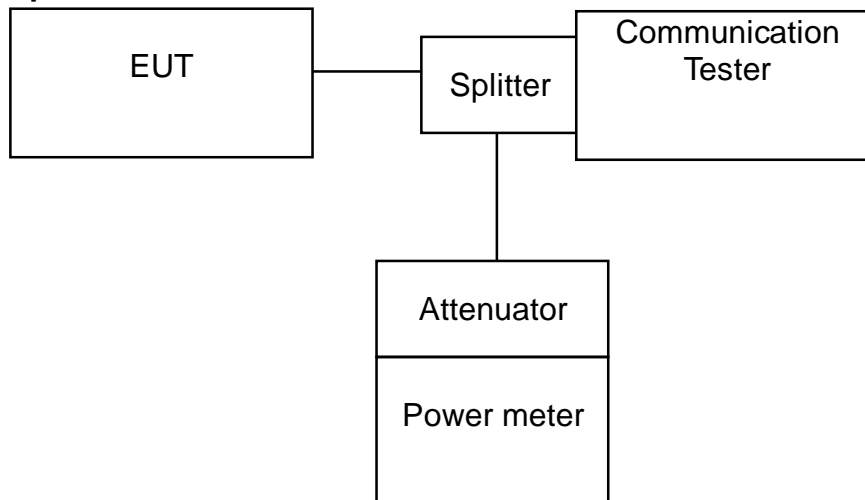

Note: Measurement setup for testing on Antenna connector

Unless otherwise stated the results shown in this test report refer only to the sample(s) tested and such sample(s) are retained for 90 days only.

除非另有說明，此報告結果僅對測試之樣品負責，同時此樣品僅保留90天。本報告未經本公司書面許可，不可部份複製。

This document is issued by the Company subject to its General Conditions of Service printed overleaf, available on request or accessible at <http://www.sgs.com.tw/Terms-and-Conditions> and for electronic format documents, subject to Terms and Conditions for Electronic Documents at <http://www.sgs.com.tw/Terms-and-Conditions>. Attention is drawn to the limitation of liability, indemnification and jurisdiction issues defined therein. Any holder of this document is advised that information contained hereon reflects the Company's findings at the time of its intervention only and within the limits of Client's instructions, if any. The Company's sole responsibility is to its Client and this document does not exonerate parties to a transaction from exercising all their rights and obligations under the transaction documents. This document cannot be reproduced except in full, without prior written approval of the Company. Any unauthorized alteration, forgery or falsification of the content or appearance of this document is unlawful and offenders may be prosecuted to the fullest extent of the law.

SGS Taiwan Ltd.

台灣檢驗科技股份有限公司

No.134,Wu Kung Road, New Taipei Industrial Park, Wuku District, New Taipei City, Taiwan/新北市五股區新北產業園區五工路 134 號

t (886-2) 2299-3279

f (886-2) 2298-0488

www.sgs.com.tw

Member of SGS Group

6.3 Output Power Measurement Applicable Guidance

The transmitter output was connected to a calibrated attenuator, the other end of which was connected to a power meter. Transmitter output was read off the power meter in dBm. The power output at the transmitter antenna port was determined by adding the value of the attenuator to the power meter reading. TS 151 010-1 is reference to conduct the test measurement of output power.

The Procedure of KDB941225 (SAR Measurement Procedures for 3G devices, (WCD-MA/HSPA) was used for EUT and Base station setting. RMC 12.2kps is used for this testing, and KDB 971168 D01 Power Meas License Digital System as the supplemental test methodology to adjust the proper setting obtaining the measurement results.

All LTE bands conducted average power is obtained from the simulator telecommunication test set.

6.4 Determining ERP and/or EIRP from conducted RF output power measurements

$$ERP/EIRP = P_{Meas} + GT-LC$$

Where:

- ERP/EIRP = effective or equivalent radiated power, respectively (expressed in the same units as P_{Meas}, typically dBW or dBm);
- P_{Meas} = measured transmitter output power or PSD, in dBm or dBW;
- GT = gain of the transmitting antenna, in dBd (ERP) or dBi (EIRP)
- LC = signal attenuation in the connecting cable between the transmitter and antenna, in dB.2

For devices utilizing multiple antennas, KDB 662911 provides guidance for determining the effective array transmit antenna gain term to be used in the above equation.

6.5 Measurement Equipment Used

EQUIPMENT TYPE	MFR	MODEL NUMBER	SERIAL NUMBER	LAST CAL.	CAL DUE.
Spectrum Analyzer	KEYSIGHT	N9010A	MY51440113	07/15/2019	07/14/2020
Radio Communication Analyzer	Anritsu	MT8821C	6261786084	01/18/2020	01/17/2021
Attenuator	Marvelous	MVE2213-10	RF30	11/20/2019	11/19/2020
DC Block	PASTERNAK	PE8210	RF32	11/20/2019	11/19/2020
Splitter	Woken	DOM35LW1A2	RF83	11/20/2019	11/19/2020
Coaxial Cables	Woken	00100A1F1A185C	RF229	11/20/2019	11/19/2020

Unless otherwise stated the results shown in this test report refer only to the sample(s) tested and such sample(s) are retained for 90 days only.

除非另有說明，此報告結果僅對測試之樣品負責，同時此樣品僅保留90天。本報告未經本公司書面許可，不可部份複製。

This document is issued by the Company subject to its General Conditions of Service printed overleaf, available on request or accessible at <http://www.sgs.com.tw/Terms-and-Conditions> and for electronic format documents, subject to Terms and Conditions for Electronic Documents at <http://www.sgs.com.tw/Terms-and-Conditions>. Attention is drawn to the limitation of liability, indemnification and jurisdiction issues defined therein. Any holder of this document is advised that information contained hereon reflects the Company's findings at the time of its intervention only and within the limits of Client's instructions, if any. The Company's sole responsibility is to its Client and this document does not exonerate parties to a transaction from exercising all their rights and obligations under the transaction documents. This document cannot be reproduced except in full, without prior written approval of the Company. Any unauthorized alteration, forgery or falsification of the content or appearance of this document is unlawful and offenders may be prosecuted to the fullest extent of the law.

6.6 LTE Measurement Results:

Antenna gain 2.9

Range	First Band						Range	Second Band						Power(dBm)				EIRP Limit	Margin (dBm)
	Modulation	Band width	Channel	Frequency	RB	RB		Modulation	Band width	Channel	Frequency	RB	PCC	SCC	Total	EIRP			
Low	QPSK	5 MHz	20428	826.8	Full	Full	Low	QPSK	10 MHz	20500	834	Full	22.49	15.48	23.24	26.14	38.45	-12.31	
5B	Mid	QPSK	5 MHz	20478	831.8	1	Mid	QPSK	10 MHz	20550	839	1	13.82	6.71	14.59	17.49	38.45	-20.96	
		QPSK	5 MHz	20478	831.8	Full		QPSK	10 MHz	20550	839	Full	22.31	15.33	23.06	25.96	38.45	-12.49	
		16QAM	5 MHz	20478	831.8	1		16QAM	10 MHz	20550	839	1	11.97	11.44	14.72	17.62	38.45	-20.83	
		16QAM	5 MHz	20478	831.8	Full		16QAM	10 MHz	20550	839	Full	21.31	14.54	22.1	25.00	38.45	-13.45	
		64QAM	5 MHz	20478	831.8	1		64QAM	10 MHz	20550	839	1	13.84	7.58	14.76	17.66	38.45	-20.79	
		64QAM	5 MHz	20478	831.8	Full		64QAM	10 MHz	20550	839	Full	21.38	14.54	22.16	25.06	38.45	-13.39	
		256QAM	5 MHz	20478	831.8	1		256QAM	10 MHz	20550	839	1	13.65	6.49	14.12	17.02	38.45	-21.43	
		256QAM	5 MHz	20478	831.8	Full		256QAM	10 MHz	20550	839	Full	18.21	11.54	19.04	21.94	38.45	-16.51	
		QPSK	10 MHz	20500	834	1		QPSK	5 MHz	20572	841.2	1	12.04	4.72	12.59	15.49	38.45	-22.96	
		QPSK	10 MHz	20500	834	Full		QPSK	5 MHz	20572	841.2	Full	22.28	15.05	23.01	25.91	38.45	-12.54	
	16QAM	10 MHz	20500	834	1	16QAM	5 MHz	20572	841.2	1	12.57	4.58	12.99	15.89	38.45	-22.56			
	16QAM	10 MHz	20500	834	Full	16QAM	5 MHz	20572	841.2	Full	21.18	13.97	21.93	24.83	38.45	-13.62			
	64QAM	10 MHz	20500	834	1	64QAM	5 MHz	20572	841.2	1	12.44	4.53	12.91	15.81	38.45	-22.64			
	64QAM	10 MHz	20500	834	Full	64QAM	5 MHz	20572	841.2	Full	21.17	14.04	21.93	24.83	38.45	-13.62			
	256QAM	10 MHz	20500	834	1	256QAM	5 MHz	20572	841.2	1	11.38	4.07	12.12	15.02	38.45	-23.43			
	256QAM	10 MHz	20500	834	Full	256QAM	5 MHz	20572	841.2	Full	18.24	11.12	19.01	21.91	38.45	-16.54			
	QPSK	10 MHz	20476	831.6	1	QPSK	10 MHz	20575	841.5	1	11.88	4.59	12.63	15.53	38.45	-22.92			
	QPSK	10 MHz	20476	831.6	Full	QPSK	10 MHz	20575	841.5	Full	22.25	15.11	23.02	25.92	38.45	-12.53			
	16QAM	10 MHz	20476	831.6	1	16QAM	10 MHz	20575	841.5	1	11.02	8.37	12.9	15.80	38.45	-22.65			
	16QAM	10 MHz	20476	831.6	Full	16QAM	10 MHz	20575	841.5	Full	21.19	18.1	22.92	25.82	38.45	-12.63			
64QAM	10 MHz	20476	831.6	1	64QAM	10 MHz	20575	841.5	1	12.23	4.73	12.94	15.84	38.45	-22.61				
64QAM	10 MHz	20476	831.6	Full	64QAM	10 MHz	20575	841.5	Full	21.41	14.2	22.17	25.07	38.45	-13.38				
256QAM	10 MHz	20476	831.6	1	256QAM	10 MHz	20575	841.5	1	11.47	4.1	12.09	14.99	38.45	-23.46				
256QAM	10 MHz	20476	831.6	Full	256QAM	10 MHz	20575	841.5	Full	17.25	10.45	18.04	20.94	38.45	-17.51				
High	QPSK	5 MHz	20528	836.8	Full	High	QPSK	10 MHz	20600	844	Full	19.9	19.73	22.79	25.69	38.45	-12.76		

Antenna gain 3.4

Range	First Band						Range	Second Band						Power(dBm)				EIRP Limit	Margin (dBm)
	Modulation	Band width	Channel	Frequency	RB	RB		Modulation	Band width	Channel	Frequency	RB	PCC	SCC	Total	EIRP			
Low	QPSK	20 MHz	20850	2510	Full	Full	Low	QPSK	20 MHz	21048	2529.8	Full	18.66	13.46	19.81	23.21	33	-9.79	
7C	Mid	QPSK	10 MHz	21006	2525.6	1	Mid	QPSK	20 MHz	21150	2540	1	16.33	9.89	17.06	20.46	33	-12.54	
		QPSK	10 MHz	21006	2525.6	Full		QPSK	20 MHz	21150	2540	Full	20.05	13.24	20.73	24.13	33	-8.87	
		16QAM	10 MHz	21006	2525.6	1		16QAM	20 MHz	21150	2540	1	17.12	9.61	17.56	20.96	33	-12.04	
		16QAM	10 MHz	21006	2525.6	Full		16QAM	20 MHz	21150	2540	Full	18.01	15.02	19.55	22.95	33	-10.05	
		64QAM	10 MHz	21006	2525.6	1		64QAM	20 MHz	21150	2540	1	15.34	8.56	16.08	19.48	33	-13.52	
		64QAM	10 MHz	21006	2525.6	Full		64QAM	20 MHz	21150	2540	Full	18.13	11.43	18.77	22.17	33	-10.83	
		256QAM	10 MHz	21006	2525.6	1		256QAM	20 MHz	21150	2540	1	17.29	10.59	18.27	21.67	33	-11.33	
		256QAM	10 MHz	21006	2525.6	Full		256QAM	20 MHz	21150	2540	Full	19.33	12.26	20.22	23.62	33	-9.38	
		QPSK	20 MHz	21051	2530.1	1		QPSK	10 MHz	21195	2544.5	1	15.33	11.24	15.67	19.07	33	-13.93	
		QPSK	20 MHz	21051	2530.1	Full		QPSK	10 MHz	21195	2544.5	Full	19.16	12.25	19.92	23.32	33	-9.68	
	16QAM	20 MHz	21051	2530.1	1	16QAM	10 MHz	21195	2544.5	1	15.26	7.88	15.68	19.08	33	-13.92			
	16QAM	20 MHz	21051	2530.1	Full	16QAM	10 MHz	21195	2544.5	Full	17.23	14.54	19.33	22.73	33	-10.27			
	64QAM	20 MHz	21051	2530.1	1	64QAM	10 MHz	21195	2544.5	1	15.28	7.37	15.32	18.72	33	-14.28			
	64QAM	20 MHz	21051	2530.1	Full	64QAM	10 MHz	21195	2544.5	Full	18.28	11.32	19.18	22.58	33	-10.42			
	256QAM	20 MHz	21051	2530.1	1	256QAM	10 MHz	21195	2544.5	1	17.74	9.66	17.83	21.23	33	-11.77			
	256QAM	20 MHz	21051	2530.1	Full	256QAM	10 MHz	21195	2544.5	Full	18.89	11.84	19.56	22.96	33	-10.04			
	QPSK	20 MHz	21001	2525.1	1	QPSK	20 MHz	21199	2544.9	1	15.02	7.87	15.66	19.06	33	-13.94			
	QPSK	20 MHz	21001	2525.1	Full	QPSK	20 MHz	21199	2544.9	Full	20.09	13.33	21.09	24.49	33	-8.51			
	16QAM	20 MHz	21001	2525.1	1	16QAM	20 MHz	21199	2544.9	1	15.68	8.02	16.21	19.61	33	-13.39			
	16QAM	20 MHz	21001	2525.1	Full	16QAM	20 MHz	21199	2544.9	Full	19.34	12.19	20.37	23.77	33	-9.23			
64QAM	20 MHz	21001	2525.1	1	64QAM	20 MHz	21199	2544.9	1	15.31	7.88	16.11	19.51	33	-13.49				
64QAM	20 MHz	21001	2525.1	Full	64QAM	20 MHz	21199	2544.9	Full	18.65	16.22	19.28	22.68	33	-10.32				
256QAM	20 MHz	21001	2525.1	1	256QAM	20 MHz	21199	2544.9	1	17.06	9.83	18.07	21.47	33	-11.53				
256QAM	20 MHz	21001	2525.1	Full	256QAM	20 MHz	21199	2544.9	Full	18.81	11.69	19.55	22.95	33	-10.05				
High	QPSK	20 MHz	21152	2540.2	Full	High	QPSK	20 MHz	21350	2560	Full	19.33	11.13	20.34	23.74	33	-9.26		

Unless otherwise stated the results shown in this test report refer only to the sample(s) tested and such sample(s) are retained for 90 days only.

除非另有說明，此報告結果僅對測試之樣品負責，同時此樣品僅保留90天。本報告未經本公司書面許可，不可部份複製。

This document is issued by the Company subject to its General Conditions of Service printed overleaf, available on request or accessible at <http://www.sgs.com.tw/Terms-and-Conditions> and for electronic format documents, subject to Terms and Conditions for Electronic Documents at <http://www.sgs.com.tw/Terms-and-Conditions>. Attention is drawn to the limitation of liability, indemnification and jurisdiction issues defined therein. Any holder of this document is advised that information contained hereon reflects the Company's findings at the time of its intervention only and within the limits of Client's instructions, if any. The Company's sole responsibility is to its Client and this document does not exonerate parties to a transaction from exercising all their rights and obligations under the transaction documents. This document cannot be reproduced except in full, without prior written approval of the Company. Any unauthorized alteration, forgery or falsification of the content or appearance of this document is unlawful and offenders may be prosecuted to the fullest extent of the law.

SGS Taiwan Ltd.

台灣檢驗科技股份有限公司

No.134,Wu Kung Road, New Taipei Industrial Park, Wuku District, New Taipei City, Taiwan/新北市五股區新北產業園區五工路 134 號

t (886-2) 2299-3279

f (886-2) 2298-0488

www.sgs.com.tw

Member of SGS Group

Antenna gain		First Band						Second Band						Power(dBm)				EIRP	Margin				
Range	Modulation	Band width	Channel	Frequency	RB		Range	Modulation	Band width	Channel	Frequency	RB	PCC	SCC	Total	EIRP	Limit	(dBm)					
41C	Low	QPSK	5 MHz	39683	2499.3	Full	Mid	QPSK	20 MHz	39800	2511	Full	22.95	17.82	23.09	26.49	33	-6.51					
		QPSK	5 MHz	40528	2583.8	1		QPSK	20 MHz	40645	2595.5	1	19.67	12.63	20.41	23.81	33	-9.19					
		QPSK	5 MHz	40528	2583.8	Full		QPSK	20 MHz	40645	2595.5	Full	21.99	17.27	22.83	26.23	33	-6.77					
		16QAM	5 MHz	40528	2583.8	1		16QAM	20 MHz	40645	2595.5	1	20.11	12.54	20.69	24.09	33	-8.91					
		16QAM	5 MHz	40528	2583.8	Full		16QAM	20 MHz	40645	2595.5	Full	21.27	16.34	22.09	25.49	33	-7.51					
		64QAM	5 MHz	40528	2583.8	1		64QAM	20 MHz	40645	2595.5	1	19.72	12.05	20.41	23.81	33	-9.19					
	High	Mid	64QAM	5 MHz	40528	2583.8	Full	Mid	64QAM	20 MHz	40645	2595.5	Full	20.28	15.35	21.09	24.49	33	-8.51				
			256QAM	5 MHz	40528	2583.8	1		256QAM	20 MHz	40645	2595.5	1	19.92	12.42	20.43	23.83	33	-9.17				
			256QAM	5 MHz	40528	2583.8	Full		256QAM	20 MHz	40645	2595.5	Full	20.28	15.27	21.16	24.56	33	-8.44				
			QPSK	20 MHz	40595	2590.5	1		QPSK	5 MHz	40712	2602.2	1	14.47	6.59	14.5	17.9	33	-15.1				
			QPSK	20 MHz	40595	2590.5	Full		QPSK	5 MHz	40712	2602.2	Full	21.89	15.21	22.66	26.06	33	-6.94				
			16QAM	20 MHz	40595	2590.5	1		16QAM	5 MHz	40712	2602.2	1	15.04	6.98	15.08	18.48	33	-14.52				
		High	Mid	16QAM	20 MHz	40595	2590.5	Full	Mid	16QAM	5 MHz	40712	2602.2	Full	21.21	14.34	21.91	25.31	33	-7.69			
				64QAM	20 MHz	40595	2590.5	1		64QAM	5 MHz	40712	2602.2	1	14.88	6.04	14.79	18.19	33	-14.81			
				64QAM	20 MHz	40595	2590.5	Full		64QAM	5 MHz	40712	2602.2	Full	20.14	13.23	20.82	24.22	33	-8.78			
				256QAM	20 MHz	40595	2590.5	1		256QAM	5 MHz	40712	2602.2	1	17.58	9.33	17.85	21.25	33	-11.75			
				256QAM	20 MHz	40595	2590.5	Full		256QAM	5 MHz	40712	2602.2	Full	20.19	13.17	20.88	24.28	33	-8.72			
				QPSK	20 MHz	40521	2583.1	1		QPSK	20 MHz	40719	2602.9	1	13.84	6.66	14.76	18.16	33	-14.84			
			High	Mid	QPSK	20 MHz	40521	2583.1	Full	Mid	QPSK	20 MHz	40719	2602.9	Full	21.88	15.16	22.51	25.91	33	-7.09		
					16QAM	20 MHz	40521	2583.1	1		16QAM	20 MHz	40719	2602.9	1	14.49	6.98	15.21	18.61	33	-14.39		
					16QAM	20 MHz	40521	2583.1	Full		16QAM	20 MHz	40719	2602.9	Full	20.91	14.27	21.78	25.18	33	-7.82		
					64QAM	20 MHz	40521	2583.1	1		64QAM	20 MHz	40719	2602.9	1	14.21	6.89	15.15	18.55	33	-14.45		
					64QAM	20 MHz	40521	2583.1	Full		64QAM	20 MHz	40719	2602.9	Full	20.03	13.19	20.82	24.22	33	-8.78		
					256QAM	20 MHz	40521	2583.1	1		256QAM	20 MHz	40719	2602.9	1	19.62	11.67	20.21	23.61	33	-9.39		
				High	Mid	256QAM	20 MHz	40521	2583.1	Full	Mid	256QAM	20 MHz	40719	2602.9	Full	20.27	13.18	21	24.4	33	-8.6	
						QPSK	5 MHz	41373	2668.3	Full		High	QPSK	20 MHz	41490	2680	Full	21.09	16.14	21.88	25.28	33	-7.72

Antenna gain		First Band						Second Band						Power(dBm)				EIRP	Margin				
Range	Modulation	Band width	Channel	Frequency	RB		Range	Modulation	Band width	Channel	Frequency	RB	PCC	SCC	Total	EIRP	Limit	(dBm)					
48C	Low	QPSK	5 MHz	55273	3553.3	Full	Mid	QPSK	20 MHz	55390	3565	Full	19.11	14.49	19.96	17.96	23	-5.04					
		QPSK	5 MHz	55898	3615.8	1		QPSK	20 MHz	56015	3627.5	1	17.57	10.61	18.37	16.37	23	-6.63					
		QPSK	5 MHz	55898	3615.8	Full		QPSK	20 MHz	56015	3627.5	Full	20.41	10.61	21.18	19.18	23	-3.82					
		16QAM	5 MHz	55898	3615.8	1		16QAM	20 MHz	56015	3627.5	1	18.1	10.68	18.82	16.82	23	-6.18					
		16QAM	5 MHz	55898	3615.8	Full		16QAM	20 MHz	56015	3627.5	Full	19.26	14.27	20.03	18.03	23	-4.97					
		64QAM	5 MHz	55898	3615.8	1		64QAM	20 MHz	56015	3627.5	1	17.9	10.28	18.60	16.60	23	-6.40					
	High	Mid	64QAM	5 MHz	55898	3615.8	Full	Mid	64QAM	20 MHz	56015	3627.5	Full	19.1	14.25	19.90	17.90	23	-5.10				
			256QAM	5 MHz	55898	3615.8	1		256QAM	20 MHz	56015	3627.5	1	20.45	12.97	21.14	19.14	23	-3.86				
			256QAM	5 MHz	55898	3615.8	Full		256QAM	20 MHz	56015	3627.5	Full	20.09	15.07	20.80	18.80	23	-4.20				
			QPSK	20 MHz	55965	3622.5	1		QPSK	5 MHz	56082	3634.2	1	14.53	6.57	14.53	12.53	23	-10.47				
			QPSK	20 MHz	55965	3622.5	Full		QPSK	5 MHz	56082	3634.2	Full	18.33	11.24	19.01	17.01	23	-5.99				
			16QAM	20 MHz	55965	3622.5	1		16QAM	5 MHz	56082	3634.2	1	15.14	6.8	15.14	13.14	23	-9.86				
		High	Mid	16QAM	20 MHz	55965	3622.5	Full	Mid	16QAM	5 MHz	56082	3634.2	Full	18.33	11.14	19.00	17.00	23	-6.00			
				64QAM	20 MHz	55965	3622.5	1		64QAM	5 MHz	56082	3634.2	1	14.58	8.19	14.58	12.58	23	-10.42			
				64QAM	20 MHz	55965	3622.5	Full		64QAM	5 MHz	56082	3634.2	Full	18.27	11.23	18.96	16.96	23	-6.04			
				256QAM	20 MHz	55965	3622.5	1		256QAM	5 MHz	56082	3634.2	1	17.5	9.37	17.42	15.42	23	-7.58			
				256QAM	20 MHz	55965	3622.5	Full		256QAM	5 MHz	56082	3634.2	Full	20.2	13.02	20.86	18.86	23	-4.14			
				QPSK	20 MHz	55891	3615.1	1		QPSK	20 MHz	56089	3634.9	1	14.07	6.93	14.83	12.83	23	-10.17			
			High	Mid	QPSK	20 MHz	55891	3615.1	Full	Mid	QPSK	20 MHz	56089	3634.9	Full	20.46	13.01	21.17	19.17	23	-3.83		
					16QAM	20 MHz	55891	3615.1	1		16QAM	20 MHz	56089	3634.9	1	14.73	7.22	15.40	13.40	23	-9.60		
					16QAM	20 MHz	55891	3615.1	Full		16QAM	20 MHz	56089	3634.9	Full	19.4	12.15	20.15	18.15	23	-4.85		
					64QAM	20 MHz	55891	3615.1	1		64QAM	20 MHz	56089	3634.9	1	14.38	6.76	15.08	13.08	23	-9.92		
					64QAM	20 MHz	55891	3615.1	Full		64QAM	20 MHz	56089	3634.9	Full	19.18	12.28	19.98	17.98	23	-5.02		
					256QAM	20 MHz	55891	3615.1	1		256QAM	20 MHz	56089	3634.9	1	18.22	14.84	19.83	17.83	23	-5.17		
				High	Mid	256QAM	20 MHz	55891	3615.1	Full	Mid	256QAM	20 MHz	56089	3634.9	Full	20.18	13.06	20.83	18.83	23	-4.17	
						QPSK	5 MHz	56523	3678.3	Full		High	QPSK	20 MHz	56640	3690	Full	20.45	15.55	21.23	19.23	23	-3.77

Antenna gain		First Band						Second Band						Power(dBm)				EIRP	Margin		
Range	Modulation	Band width	Channel	Frequency	RB		Range	Modulation	Band width	Channel	Frequency	RB	PCC	SCC	Total	EIRP	Limit	(dBm)			
66B	Low	QPSK	15 MHz	132047	1717.5	Full	Mid	QPSK	5 MHz	132140	1726.8	Full	18.69	15.61	20.37	24.87	30	-5.13			
		QPSK	5 MHz	132398	1752.6	1		QPSK	5 MHz	132446	1757.4	1	10.82	3.83	11.68	16.18	30	-13.82			
		QPSK	5 MHz	132398	1752.6	Full		QPSK	5 MHz	132446	1757.4	Full	21.23	14.26	21.84	26.34	30	-3.66			
		16QAM	5 MHz	132398	1752.6	1		16QAM	5 MHz	132446	1757.4	1	11.39	4.22	12.13	16.63	30	-13.37			
		16QAM	5 MHz	132398	1752.6	Full		16QAM	5 MHz	132446	1757.4	Full	19.29	16.41	21.07	25.57	30	-4.43			
		64QAM	5 MHz	132398	1752.6	1		64QAM	5 MHz	132446	1757.4	1	10.99	4.23	12.08	16.58	30	-13.42			
	High	Mid	64QAM	5 MHz	132398	1752.6	Full	Mid	64QAM	5 MHz	132446	1757.4	Full	18.72	15.79	20.52	25.02	30	-4.98		
			256QAM	5 MHz	132398	1752.6	1		256QAM	5 MHz	132446	1757.4	1	18.02	10.9	18.42	22.92	30	-7.08		
			256QAM	5 MHz	132398	1752.6	Full		256QAM	5 MHz	132446	1757.4	Full	18.76	11.84	19.63	24.13	30	-5.87		
			QPSK	5 MHz	132353	1748.1	1		QPSK	15 MHz	132446	1757.4	1	10.38	3.55	11.09	15.59	30	-14.41		
			QPSK	5 MHz	132353	1748.1	Full		QPSK	15 MHz	132446	1757.4	Full	19.72	14.58	20.13	24.63	30	-5.37		
			16QAM	5 MHz	132353	1748.1	1		16QAM	15 MHz	132446	1757.4	1	11.04	5.39	11.89	16.39	30	-13.61		
		High	Mid	16QAM	5 MHz	132353	1748.1	Full	Mid	16QAM	15 MHz	132446	1757.4	Full	18.25	13.43	19.27	23.77	30	-6.23	
				64QAM	5 MHz	132353	1748.1	1		64QAM	15 MHz	132446	1757.4	1	11.01	4.06	11.74	16.24	30	-13.76	
				64QAM	5 MHz	132353	1748.1	Full		64QAM	15 MHz	132446	1757.4	Full	17.39	12.41	18.48	22.98	30	-7.02	
				256QAM	5 MHz	132353	1748.1	1		256QAM	15 MHz	132446	1757.4	1	17.56	10.15	18.10	22.60	30	-7.40	
				256QAM	5 MHz	132353	1748.1	Full		256QAM	15 MHz	132446	1757.4	Full	18.95	14.14	19.23	23.73	30	-6.27	
				QPSK	15 MHz	132398	1752.6	1		QPSK	5 MHz	132491	1761.9	1	9.74	2.81	9.89	14.39	30	-15.61	
			High	Mid	QPSK	15 MHz	132398	1752.6	Full	Mid	QPSK	5 MHz	132491	1761.9	Full	19.98	18.42	21.88	26.38	30	-3.62
					16QAM	15 MHz	132398	1752.6	1		16QAM	5 MHz	132491	1761.9	1	10.15	2.43	10.76	15.26	30	-14.74
					16QAM</																

Antenna gain 4.5

First Band						Second Band						Power(dBm)							
Range	Modulation	Band width	Channel	Frequency	RB	Range	Modulation	Band width	Channel	Frequency	RB	PCC	SCC	Total	EIRP	EIRP Limit	Margin (dBm)		
Low	QPSK	20 MHz	132072	1720	worst RB	Low	QPSK	5 MHz	132189	1731.7	Full	18.91	11.99	19.56	24.06	30	-5.94		
66C	QPSK	20 MHz	132397	1752.5	1	Mid	QPSK	5 MHz	132514	1764.2	1	10.13	2.31	10.15	14.65	30	-15.35		
	QPSK	20 MHz	132397	1752.5	Full		QPSK	5 MHz	132514	1764.2	Full	19.64	17.6	20.42	24.92	30	-5.08		
	16QAM	20 MHz	132397	1752.5	1		16QAM	5 MHz	132514	1764.2	1	10.66	2.79	10.99	15.49	30	-14.51		
	16QAM	20 MHz	132397	1752.5	Full		16QAM	5 MHz	132514	1764.2	Full	18.46	11.61	19.42	23.92	30	-6.08		
	64QAM	20 MHz	132397	1752.5	1		64QAM	5 MHz	132514	1764.2	1	10.11	2.75	10.33	14.83	30	-15.17		
	64QAM	20 MHz	132397	1752.5	Full		64QAM	5 MHz	132514	1764.2	Full	17.36	10.52	18.15	22.65	30	-7.35		
	256QAM	20 MHz	132397	1752.5	1		256QAM	5 MHz	132514	1764.2	1	17.13	9.47	16.93	21.43	30	-8.57		
	256QAM	20 MHz	132397	1752.5	Full		256QAM	5 MHz	132514	1764.2	Full	19.29	12.11	20.70	25.20	30	-4.80		
	QPSK	5 MHz	132330	1745.8	1		QPSK	20 MHz	132447	1757.5	1	15.36	8.97	16.13	20.63	30	-9.37		
	QPSK	5 MHz	132330	1745.8	Full		QPSK	20 MHz	132447	1757.5	Full	18.46	15.47	19.54	24.04	30	-5.96		
	16QAM	5 MHz	132330	1745.8	1		16QAM	20 MHz	132447	1757.5	1	16.44	8.77	17.19	21.69	30	-8.31		
	16QAM	5 MHz	132330	1745.8	Full		16QAM	20 MHz	132447	1757.5	Full	17.23	13.65	18.56	23.06	30	-6.94		
	64QAM	5 MHz	132330	1745.8	1		64QAM	20 MHz	132447	1757.5	1	15.72	10.98	16.82	21.32	30	-8.68		
	64QAM	5 MHz	132330	1745.8	Full		64QAM	20 MHz	132447	1757.5	Full	18.18	14.81	19.77	24.27	30	-5.73		
	256QAM	5 MHz	132330	1745.8	1		256QAM	20 MHz	132447	1757.5	1	16.39	9.06	16.58	21.08	30	-8.92		
	256QAM	5 MHz	132330	1745.8	Full		256QAM	20 MHz	132447	1757.5	Full	18.12	13.34	19.10	23.60	30	-6.40		
	QPSK	20 MHz	132323	1745.1	1		QPSK	20 MHz	132521	1764.9	1	9.35	2.39	10.16	14.66	30	-15.34		
	QPSK	20 MHz	132323	1745.1	Full		QPSK	20 MHz	132521	1764.9	Full	18.76	13.36	19.33	23.83	30	-6.17		
	16QAM	20 MHz	132323	1745.1	1		16QAM	20 MHz	132521	1764.9	1	9.78	2.74	10.62	15.12	30	-14.88		
	16QAM	20 MHz	132323	1745.1	Full		16QAM	20 MHz	132521	1764.9	Full	17.37	10.71	18.26	22.76	30	-7.24		
	64QAM	20 MHz	132323	1745.1	1		64QAM	20 MHz	132521	1764.9	1	9.87	2.54	10.29	14.79	30	-15.21		
	64QAM	20 MHz	132323	1745.1	Full		64QAM	20 MHz	132521	1764.9	Full	16.29	10.08	17.24	21.74	30	-8.26		
	256QAM	20 MHz	132323	1745.1	1		256QAM	20 MHz	132521	1764.9	1	16.39	9.69	17.66	22.16	30	-7.84		
	256QAM	20 MHz	132323	1745.1	Full		256QAM	20 MHz	132521	1764.9	Full	18.24	14.25	18.39	22.89	30	-7.11		
	High	QPSK	20 MHz	132522	1765		Full	High	QPSK	5 MHz	132639	1776.7	Full	19.95	13.86	21.34	25.84	30	-4.16

Unless otherwise stated the results shown in this test report refer only to the sample(s) tested and such sample(s) are retained for 90 days only.

除非另有說明，此報告結果僅對測試之樣品負責，同時此樣品僅保留90天。本報告未經本公司書面許可，不可部份複製。

This document is issued by the Company subject to its General Conditions of Service printed overleaf, available on request or accessible at <http://www.sgs.com.tw/Terms-and-Conditions> and for electronic format documents, subject to Terms and Conditions for Electronic Documents at <http://www.sgs.com.tw/Terms-and-Conditions>. Attention is drawn to the limitation of liability, indemnification and jurisdiction issues defined therein. Any holder of this document is advised that information contained hereon reflects the Company's findings at the time of its intervention only and within the limits of Client's instructions, if any. The Company's sole responsibility is to its Client and this document does not exonerate parties to a transaction from exercising all their rights and obligations under the transaction documents. This document cannot be reproduced except in full, without prior written approval of the Company. Any unauthorized alteration, forgery or falsification of the content or appearance of this document is unlawful and offenders may be prosecuted to the fullest extent of the law.

SGS Taiwan Ltd.

台灣檢驗科技股份有限公司

No.134,Wu Kung Road, New Taipei Industrial Park, Wuku District, New Taipei City, Taiwan/新北市五股區新北產業園區五工路 134 號

t (886-2) 2299-3279

f (886-2) 2298-0488

www.sgs.com.tw

Member of SGS Group

Antenna gain 4							Second Band							Power(dBm)				EIRP Limit	Margin (dBm)
Band	Range	Modulation	Band width	Channel	Frequency	RB	Band	Range	Modulation	Band width	Channel	Frequency	RB	PCC	SCC	Total	EIRP	Limit	Margin (dBm)
2A	Low	QPSK	5 MHz	18625	1852.5	1	5A	Low	QPSK	5 MHz	20425	826.5	1	22.02	17.54	23.34	27.34	33	-5.66
		QPSK	5 MHz	18900	1880	1			QPSK	5 MHz	20525	836.5	1	22.22	19.88	24.22	28.22	33	-4.78
	Mid	QPSK	5 MHz	18900	1880	1		QPSK	10 MHz	20525	836.5	1	21.24	20.14	23.74	27.74	33	-5.26	
		QPSK	20 MHz	18900	1880	1		QPSK	5 MHz	20525	836.5	1	22.42	18.39	23.87	27.87	33	-5.13	
		QPSK	20 MHz	18900	1880	1		QPSK	10 MHz	20525	836.5	1	22.45	18.56	23.94	27.94	33	-5.06	
High	QPSK	5 MHz	19175	1907.5	1	High	QPSK	5 MHz	20625	846.5	1	22.57	19.82	24.42	28.42	33	-4.58		
Antenna gain 4							Second Band							Power(dBm)				EIRP Limit	Margin (dBm)
2A	Low	QPSK	20 MHz	18700	1860	1	12A	Low	QPSK	5 MHz	23035	701.5	1	22.41	21.82	25.14	29.14	33	-3.86
		QPSK	5 MHz	18900	1880	1			QPSK	5 MHz	23095	707.5	1	22.28	21.99	25.15	29.15	33	-3.85
	Mid	QPSK	5 MHz	18900	1880	1		QPSK	10 MHz	23095	707.5	1	22.23	21.99	25.08	29.08	33	-3.92	
		QPSK	20 MHz	18900	1880	1		QPSK	5 MHz	23095	707.5	1	22.22	22.46	25.35	29.35	33	-3.65	
		QPSK	20 MHz	18900	1880	1		QPSK	10 MHz	23095	707.5	1	22.51	21.92	25.24	29.24	33	-3.76	
High	QPSK	20 MHz	19100	1900	1	High	QPSK	5 MHz	23155	713.5	1	22.27	23.07	25.7	29.70	33	-3.3		
Antenna gain 4							Second Band							Power(dBm)				EIRP Limit	Margin (dBm)
2A	Low	QPSK	20 MHz	18700	1860 MHz	1	13A	Low	QPSK	10 MHz	23230	782 MHz	1	22.3	21.64	24.99	28.99	33	-4.01
		QPSK	5 MHz	18900	1880 MHz	1			QPSK	10 MHz	23230	782 MHz	1	22.28	21.69	25.01	29.01	33	-3.99
	Mid	QPSK	20 MHz	18900	1880 MHz	1		QPSK	10 MHz	23230	782 MHz	1	22.57	22.55	25.57	29.57	33	-3.43	
		QPSK	20 MHz	19100	1900 MHz	1		High	QPSK	10 MHz	23230	782 MHz	1	22.02	21.5	24.78	28.78	33	-4.22
Antenna gain 4.5							Second Band							Power(dBm)				EIRP Limit	Margin (dBm)
4A	Low	QPSK	20 MHz	20050	1720 MHz	1	5A	Low	QPSK	5 MHz	20425	826.5 MHz	1	21.67	19.12	23.59	28.09	30	-1.91
		QPSK	5 MHz	20175	1732.5 MHz	1			QPSK	5 MHz	20525	836.5 MHz	1	22.94	18.48	24.27	28.77	30	-1.23
	Mid	QPSK	5 MHz	20175	1732.5 MHz	1		QPSK	10 MHz	20525	836.5 MHz	1	22.76	17.73	23.95	28.45	30	-1.55	
		QPSK	20 MHz	20175	1732.5 MHz	1		QPSK	5 MHz	20525	836.5 MHz	1	23.05	18.51	24.36	28.86	30	-1.14	
		QPSK	20 MHz	20175	1732.5 MHz	1		QPSK	10 MHz	20525	836.5 MHz	1	22.08	18.51	23.66	28.16	30	-1.84	
High	QPSK	20 MHz	20300	1745 MHz	1	High	QPSK	5 MHz	20625	846.5 MHz	1	22.05	20.03	24.45	28.95	30	-1.05		
Antenna gain 4.5							Second Band							Power(dBm)				EIRP Limit	Margin (dBm)
4A	Low	QPSK	20 MHz	20050	1720 MHz	1	12A	Low	QPSK	10 MHz	23060	704 MHz	1	21.78	22.7	25.27	29.77	30	-0.23
		QPSK	1.4 MHz	20175	1732.5 MHz	1			QPSK	5 MHz	23095	707.5 MHz	1	22.89	21.92	25.44	29.94	30	-0.06
	Mid	QPSK	1.4 MHz	20175	1732.5 MHz	1		QPSK	10 MHz	23095	707.5 MHz	1	22.82	20.43	24.80	29.30	30	-0.70	
		QPSK	20 MHz	20175	1732.5 MHz	1		QPSK	5 MHz	23095	707.5 MHz	1	22.19	22.2	25.11	29.61	30	-0.39	
		QPSK	20 MHz	20175	1732.5 MHz	1		QPSK	10 MHz	23095	707.5 MHz	1	22.51	22.45	25.43	29.93	30	-0.07	
High	QPSK	20 MHz	20300	1745 MHz	1	High	QPSK	10 MHz	23130	711 MHz	1	22.71	21.89	25.33	29.83	30	-0.17		
Antenna gain 4.5							Second Band							Power(dBm)				EIRP Limit	Margin (dBm)
4A	Low	QPSK	20 MHz	20050	1720 MHz	1	13A	Low	QPSK	10 MHz	23230	782 MHz	1	21.87	21.63	24.76	29.26	30	-0.74
		QPSK	5 MHz	20175	1732.5 MHz	1			QPSK	10 MHz	23230	782 MHz	1	23.06	21.5	25.36	29.86	30	-0.14
	Mid	QPSK	20 MHz	20175	1732.5 MHz	1		QPSK	10 MHz	23230	782 MHz	1	23.22	21.55	25.48	29.98	30	-0.02	
		QPSK	20 MHz	20300	1745 MHz	1		High	QPSK	10 MHz	23230	782 MHz	1	22.6	19.31	24.27	28.77	30	-1.23
Antenna gain 3.4							Second Band							Power(dBm)				EIRP Limit	Margin (dBm)
5A	Low	QPSK	10 MHz	20450	829 MHz	1	7A	Low	QPSK	20 MHz	20850	2510 MHz	1	20.67	20.91	23.80	27.20	33	-5.80
		QPSK	1.4 MHz	20525	836.5 MHz	1			QPSK	10 MHz	21100	2535 MHz	1	21.54	19.91	23.81	27.21	33	-5.79
	Mid	QPSK	1.4 MHz	20525	836.5 MHz	1		QPSK	20 MHz	21100	2535 MHz	1	21.42	21.06	24.25	27.65	33	-5.35	
		QPSK	10 MHz	20525	836.5 MHz	1		QPSK	10 MHz	21100	2535 MHz	1	21.47	20.85	24.18	27.58	33	-5.42	
		QPSK	10 MHz	20525	836.5 MHz	1		QPSK	20 MHz	21100	2535 MHz	1	21.49	21.23	24.37	27.77	33	-5.23	
High	QPSK	10 MHz	20600	844 MHz	1	High	QPSK	20 MHz	21350	2560 MHz	1	21.73	20.77	24.29	27.69	33	-5.31		
Antenna gain 4.5							Second Band							Power(dBm)				EIRP Limit	Margin (dBm)
5A	Low	QPSK	10 MHz	20450	829 MHz	1	66A	Low	QPSK	5 MHz	131997	1712.5 MHz	1	19.77	21.3	23.61	28.11	30	-1.89
		QPSK	5 MHz	20525	836.5 MHz	1			QPSK	5 MHz	132322	1745 MHz	1	21.3	20.27	23.83	28.33	30	-1.67
	Mid	QPSK	5 MHz	20525	836.5 MHz	1		QPSK	20 MHz	132322	1745 MHz	1	21.32	20.35	23.87	28.37	30	-1.63	
		QPSK	10 MHz	20525	836.5 MHz	1		QPSK	5 MHz	132322	1745 MHz	1	22.46	20.11	24.45	28.95	30	-1.05	
		QPSK	10 MHz	20525	836.5 MHz	1		QPSK	20 MHz	132322	1745 MHz	1	20.48	21.8	24.20	28.70	30	-1.30	
High	QPSK	10 MHz	20600	844 MHz	1	High	QPSK	5 MHz	132647	1777.5 MHz	1	22.49	20.41	24.58	29.08	30	-0.92		
Antenna gain 4.5							Second Band							Power(dBm)				EIRP Limit	Margin (dBm)
12A	Low	QPSK	5 MHz	23035	701.5 MHz	1	66A	Low	QPSK	20 MHz	132072	1720 MHz	1	22.97	18.34	24.26	28.76	30	-1.24
		QPSK	5 MHz	23095	707.5 MHz	1			QPSK	1.4 MHz	132322	1745 MHz	1	22.96	17.92	24.15	28.65	30	-1.35
	Mid	QPSK	5 MHz	23095	707.5 MHz	1		QPSK	20 MHz	132322	1745 MHz	1	23.97	15.64	24.56	29.06	30	-0.94	
		QPSK	10 MHz	23095	707.5 MHz	1		QPSK	1.4 MHz	132322	1745 MHz	1	23.05	18	24.23	28.73	30	-1.27	
		QPSK	10 MHz	23095	707.5 MHz	1		QPSK	20 MHz	132322	1745 MHz	1	22.54	18.25	23.91	28.41	30	-1.59	
High	QPSK	5 MHz	23155	713.5 MHz	1	High	QPSK	20 MHz	132572	1770 MHz	1	23.99	15.72	24.59	29.09	30	-0.91		

Unless otherwise stated the results shown in this test report refer only to the sample(s) tested and such sample(s) are retained for 90 days only.

除非另有說明，此報告結果僅對測試之樣品負責，同時此樣品僅保留90天。本報告未經本公司書面許可，不可部份複製。

This document is issued by the Company subject to its General Conditions of Service printed overleaf, available on request or accessible at <http://www.sgs.com.tw/Terms-and-Conditions> and for electronic format documents, subject to Terms and Conditions for Electronic Documents at <http://www.sgs.com.tw/Terms-and-Conditions>. Attention is drawn to the limitation of liability, indemnification and jurisdiction issues defined therein. Any holder of this document is advised that information contained hereon reflects the Company's findings at the time of its intervention only and within the limits of Client's instructions, if any. The Company's sole responsibility is to its Client and this document does not exonerate parties to a transaction from exercising all their rights and obligations under the transaction documents. This document cannot be reproduced except in full, without prior written approval of the Company. Any unauthorized alteration, forgery or falsification of the content or appearance of this document is unlawful and offenders may be prosecuted to the fullest extent of the law.

7 OCCUPIED BANDWIDTH MEASUREMENT

7.1 Standard Applicable

The occupied bandwidth is the frequency bandwidth such that, below its lower and above its upper frequency limits, the mean powers radiated are each equal to 0.5 percent of the total mean power.

7.2 Test Set-up

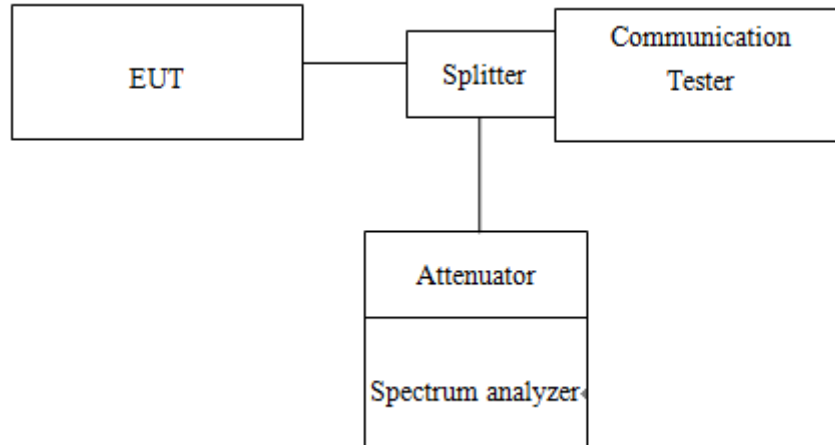

7.3 Measurement Procedure

99% & 26dB Bandwidth with detector peak

The EUT's output RF connector was connected with a short cable to the spectrum analyzer, RBW was set to about 1% of emission BW, VBW= 3 times RBW, -26dBc display line was placed on the screen (or 26dB bandwidth), the occupied bandwidth is the delta frequency between the two points where the display line intersects the signal trace. Then set RBW to 99% bandwidth, RBW= 1%, VBW= 3 RBW, with span > 2 * Signal BW, set % Power = 99%.

Unless otherwise stated the results shown in this test report refer only to the sample(s) tested and such sample(s) are retained for 90 days only.

除非另有說明，此報告結果僅對測試之樣品負責，同時此樣品僅保留90天。本報告未經本公司書面許可，不可部份複製。

This document is issued by the Company subject to its General Conditions of Service printed overleaf, available on request or accessible at <http://www.sgs.com.tw/Terms-and-Conditions> and for electronic format documents, subject to Terms and Conditions for Electronic Documents at <http://www.sgs.com.tw/Terms-and-Conditions>. Attention is drawn to the limitation of liability, indemnification and jurisdiction issues defined therein. Any holder of this document is advised that information contained hereon reflects the Company's findings at the time of its intervention only and within the limits of Client's instructions, if any. The Company's sole responsibility is to its Client and this document does not exonerate parties to a transaction from exercising all their rights and obligations under the transaction documents. This document cannot be reproduced except in full, without prior written approval of the Company. Any unauthorized alteration, forgery or falsification of the content or appearance of this document is unlawful and offenders may be prosecuted to the fullest extent of the law.

7.4 Measurement Equipment Used

Conducted Emission (measured at antenna port) Test Site					
EQUIPMENT TYPE	MFR	MODEL NUMBER	SERIAL NUMBER	LAST CAL.	CAL DUE.
Spectrum Analyzer	KEYSIGHT	N9010A	MY51440113	07/15/2019	07/14/2020
Radio Communication Analyer	Anritsu	MT8821C	6261786084	01/18/2020	01/17/2021
Attenuator	Marvelous	MVE2213-10	RF30	11/20/2019	11/19/2020
DC Block	PASTERNAK	PE8210	RF32	11/20/2019	11/19/2020
Splitter	Woken	DOM35LW1 A2	RF83	11/20/2019	11/19/2020
Coaxial Cables	Woken	00100A1F1A 185C	RF229	11/20/2019	11/19/2020

7.5 Measurement Result

	First Band			Freq. (MHz)	+	Second Band			Freq. (MHz)	OBW	
	Modulation	Band width	Channel			Modulation	Band width	Channel		26dB(MHz)	99%(MHz)
5B	QPSK	5 MHz	20428	826.8	+	QPSK	10 MHz	20500	834	14.73	13.911
	QPSK	5 MHz	20478	831.8		QPSK	10 MHz	20550	839	14.81	13.904
	16QAM	5 MHz	20478	831.8		16QAM	10 MHz	20550	839	14.62	13.845
	64QAM	5 MHz	20478	831.8		64QAM	10 MHz	20550	839	14.61	13.837
	256QAM	5 MHz	20478	831.8		256QAM	10 MHz	20550	839	14.55	13.737
	QPSK	10 MHz	20500	834		QPSK	5 MHz	20572	841.2	14.79	13.928
	16QAM	10 MHz	20500	834		16QAM	5 MHz	20572	841.2	14.77	13.867
	64QAM	10 MHz	20500	834		64QAM	5 MHz	20572	841.2	14.81	13.906
	256QAM	10 MHz	20500	834		256QAM	5 MHz	20572	841.2	14.61	13.805
	QPSK	10 MHz	20476	831.6		QPSK	10 MHz	20575	841.5	19.8	18.758
	16QAM	10 MHz	20476	831.6		16QAM	10 MHz	20575	841.5	19.83	18.695
	64QAM	10 MHz	20476	831.6		64QAM	10 MHz	20575	841.5	19.89	18.644
	256QAM	10 MHz	20476	831.6		256QAM	10 MHz	20575	841.5	19.8	18.758
	QPSK	5 MHz	20528	836.8		QPSK	10 MHz	20600	844	14.58	13.872
7C	First Band			Freq. (MHz)	+	Second Band			Freq. (MHz)	OBW	
	Modulation	Band width	Channel			Modulation	Band width	Channel		26dB(MHz)	99%(MHz)
	QPSK	20 MHz	20850	2510		QPSK	20 MHz	21048	2529.8	39.27	37.438
	QPSK	10 MHz	21006	2525.6		QPSK	20 MHz	21150	2540	29.17	27.698
	16QAM	10 MHz	21006	2525.6		16QAM	20 MHz	21150	2540	29.12	27.605
	64QAM	10 MHz	21006	2525.6		64QAM	20 MHz	21150	2540	33.15	27.575
	QPSK	20 MHz	21051	2530.1		QPSK	10 MHz	21195	2544.5	31.31	27.695
	16QAM	20 MHz	21051	2530.1		16QAM	10 MHz	21195	2544.5	29.43	27.699
	64QAM	20 MHz	21051	2530.1		64QAM	10 MHz	21195	2544.5	30.68	27.656
	256QAM	20 MHz	21051	2530.1		256QAM	10 MHz	21195	2544.5	30.68	27.656
	QPSK	20 MHz	21001	2525.1		QPSK	20 MHz	21199	2544.9	39.46	37.286
	16QAM	20 MHz	21001	2525.1		16QAM	20 MHz	21199	2544.9	39.3	37.34
	64QAM	20 MHz	21001	2525.1		64QAM	20 MHz	21199	2544.9	39.25	37.247
	256QAM	20 MHz	21001	2525.1		256QAM	20 MHz	21199	2544.9	38.92	36.984
QPSK	20 MHz	21152	2540.2	QPSK	20 MHz	21350	2560	38.97	37.017		

Unless otherwise stated the results shown in this test report refer only to the sample(s) tested and such sample(s) are retained for 90 days only.

除非另有說明，此報告結果僅對測試之樣品負責，同時此樣品僅保留90天。本報告未經本公司書面許可，不可部份複製。

This document is issued by the Company subject to its General Conditions of Service printed overleaf, available on request or accessible at <http://www.sgs.com.tw/Terms-and-Conditions> and for electronic format documents, subject to Terms and Conditions for Electronic Documents at <http://www.sgs.com.tw/Terms-and-Conditions>. Attention is drawn to the limitation of liability, indemnification and jurisdiction issues defined therein. Any holder of this document is advised that information contained hereon reflects the Company's findings at the time of its intervention only and within the limits of Client's instructions, if any. The Company's sole responsibility is to its Client and this document does not exonerate parties to a transaction from exercising all their rights and obligations under the transaction documents. This document cannot be reproduced except in full, without prior written approval of the Company. Any unauthorized alteration, forgery or falsification of the content or appearance of this document is unlawful and offenders may be prosecuted to the fullest extent of the law.

	First Band			Freq. (MHz)	+	Second Band			Freq. (MHz)	OBW	
	Modulation	Band width	Channel			Modulation	Band width	Channel		26dB(MHz)	99%(MHz)
41C	QPSK	5 MHz	39683	2499.3	+	QPSK	20 MHz	39800	2511	24.05	22.836
	QPSK	5 MHz	40528	2583.8		QPSK	20 MHz	40645	2595.5	24.23	22.897
	16QAM	5 MHz	40528	2583.8		16QAM	20 MHz	40645	2595.5	23.91	22.807
	64QAM	5 MHz	40528	2583.8		64QAM	20 MHz	40645	2595.5	23.95	22.882
	256QAM	5 MHz	40528	2583.8		256QAM	20 MHz	40645	2595.5	24	22.698
	QPSK	20 MHz	40595	2590.5		QPSK	5 MHz	40712	2602.2	24.37	22.996
	16QAM	20 MHz	40595	2590.5		16QAM	5 MHz	40712	2602.2	24.34	22.989
	64QAM	20 MHz	40595	2590.5		64QAM	5 MHz	40712	2602.2	24.31	22.835
	256QAM	20 MHz	40595	2590.5		256QAM	5 MHz	40712	2602.2	24.04	22.853
	QPSK	20 MHz	40521	2583.1		QPSK	20 MHz	40719	2602.9	39.35	37.458
	16QAM	20 MHz	40521	2583.1		16QAM	20 MHz	40719	2602.9	39.44	37.427
	64QAM	20 MHz	40521	2583.1		64QAM	20 MHz	40719	2602.9	39.33	37.435
	256QAM	20 MHz	40521	2583.1		256QAM	20 MHz	40719	2602.9	39.17	37.284
	QPSK	5 MHz	41373	2668.3		QPSK	20 MHz	41490	2680	24.03	22.878
48C	QPSK	5 MHz	55273	3553.3	+	QPSK	20 MHz	55390	3565	24.03	22.865
	QPSK	5 MHz	55898	3615.8		QPSK	20 MHz	56015	3627.5	23.97	22.829
	16QAM	5 MHz	55898	3615.8		16QAM	20 MHz	56015	3627.5	23.97	22.802
	64QAM	5 MHz	55898	3615.8		64QAM	20 MHz	56015	3627.5	23.9	22.728
	256QAM	5 MHz	55898	3615.8		256QAM	20 MHz	56015	3627.5	24	22.765
	QPSK	20 MHz	55965	3622.5		QPSK	5 MHz	56082	3634.2	24.1	22.913
	16QAM	20 MHz	55965	3622.5		16QAM	5 MHz	56082	3634.2	23.95	22.87
	64QAM	20 MHz	55965	3622.5		64QAM	5 MHz	56082	3634.2	24.15	22.829
	256QAM	20 MHz	55965	3622.5		256QAM	5 MHz	56082	3634.2	24.01	22.849
	QPSK	20 MHz	55891	3615.1		QPSK	20 MHz	56089	3634.9	38.99	37.405
	16QAM	20 MHz	55891	3615.1		16QAM	20 MHz	56089	3634.9	39.28	37.419
	64QAM	20 MHz	55891	3615.1		64QAM	20 MHz	56089	3634.9	39.4	37.432
	256QAM	20 MHz	55891	3615.1		256QAM	20 MHz	56089	3634.9	38.92	37.304
	QPSK	5 MHz	56523	3678.3		QPSK	20 MHz	56640	3690	23.89	22.878
66B	QPSK	15 MHz	132047	1717.5	+	QPSK	5 MHz	132140	1726.8	19.37	18.223
	QPSK	5 MHz	132398	1752.6		QPSK	5 MHz	132446	1757.4	9.913	9.2748
	16QAM	5 MHz	132398	1752.6		16QAM	5 MHz	132446	1757.4	9.851	9.247
	64QAM	5 MHz	132398	1752.6		64QAM	5 MHz	132446	1757.4	9.838	9.2797
	256QAM	5 MHz	132398	1752.6		256QAM	5 MHz	132446	1757.4	9.716	9.1884
	QPSK	5 MHz	132353	1748.1		QPSK	15 MHz	132446	1757.4	19.33	18.316
	16QAM	5 MHz	132353	1748.1		16QAM	15 MHz	132446	1757.4	19.19	18.285
	64QAM	5 MHz	132353	1748.1		64QAM	15 MHz	132446	1757.4	19.16	18.196
	256QAM	5 MHz	132353	1748.1		256QAM	15 MHz	132446	1757.4	19.04	18.04
	QPSK	15 MHz	132398	1752.6		QPSK	5 MHz	132491	1761.9	19.37	18.207
	16QAM	15 MHz	132398	1752.6		16QAM	5 MHz	132491	1761.9	19.35	18.206
	64QAM	15 MHz	132398	1752.6		64QAM	5 MHz	132491	1761.9	19.39	18.186
	256QAM	15 MHz	132398	1752.6		256QAM	5 MHz	132491	1761.9	19.19	18.133
	QPSK	15 MHz	132549	1767.7		QPSK	5 MHz	132642	1777	19.47	18.22

Unless otherwise stated the results shown in this test report refer only to the sample(s) tested and such sample(s) are retained for 90 days only.

除非另有說明，此報告結果僅對測試之樣品負責，同時此樣品僅保留90天。本報告未經本公司書面許可，不可部份複製。

This document is issued by the Company subject to its General Conditions of Service printed overleaf, available on request or accessible at <http://www.sgs.com.tw/Terms-and-Conditions> and for electronic format documents, subject to Terms and Conditions for Electronic Documents at <http://www.sgs.com.tw/Terms-and-Conditions>. Attention is drawn to the limitation of liability, indemnification and jurisdiction issues defined therein. Any holder of this document is advised that information contained hereon reflects the Company's findings at the time of its intervention only and within the limits of Client's instructions, if any. The Company's sole responsibility is to its Client and this document does not exonerate parties to a transaction from exercising all their rights and obligations under the transaction documents. This document cannot be reproduced except in full, without prior written approval of the Company. Any unauthorized alteration, forgery or falsification of the content or appearance of this document is unlawful and offenders may be prosecuted to the fullest extent of the law.

	First Band			Freq. (MHz)	+	Second Band			Freq. (MHz)	OBW	
	Modulation	Band width	Channel			Modulation	Band width	Channel		26dB(MHz)	99%(MHz)
66C	QPSK	20 MHz	132072	1720		QPSK	5 MHz	132189	1731.7	24.16	22.865
	QPSK	20 MHz	132397	1752.5		QPSK	5 MHz	132514	1764.2	24.22	22.833
	16QAM	20 MHz	132397	1752.5		16QAM	5 MHz	132514	1764.2	24.16	22.836
	64QAM	20 MHz	132397	1752.5		64QAM	5 MHz	132514	1764.2	24.03	22.817
	256QAM	20 MHz	132397	1752.5		256QAM	5 MHz	132514	1764.2	24.24	22.822
	QPSK	5 MHz	132330	1745.8		QPSK	20 MHz	132447	1757.5	23.93	22.984
	16QAM	5 MHz	132330	1745.8		16QAM	20 MHz	132447	1757.5	23.86	22.82
	64QAM	5 MHz	132330	1745.8		64QAM	20 MHz	132447	1757.5	23.74	22.744
	256QAM	5 MHz	132330	1745.8		256QAM	20 MHz	132447	1757.5	23.66	22.527
	QPSK	20 MHz	132323	1745.1		QPSK	20 MHz	132521	1764.9	39.25	37.347
	16QAM	20 MHz	132323	1745.1		16QAM	20 MHz	132521	1764.9	39.09	37.538
	64QAM	20 MHz	132323	1745.1		64QAM	20 MHz	132521	1764.9	42.99	37.353
	256QAM	20 MHz	132323	1745.1		256QAM	20 MHz	132521	1764.9	39.14	37.114
	QPSK	20 MHz	132522	1765		QPSK	5 MHz	132639	1776.7	24.1	22.784

Unless otherwise stated the results shown in this test report refer only to the sample(s) tested and such sample(s) are retained for 90 days only.

除非另有說明，此報告結果僅對測試之樣品負責，同時此樣品僅保留90天。本報告未經本公司書面許可，不可部份複製。

This document is issued by the Company subject to its General Conditions of Service printed overleaf, available on request or accessible at <http://www.sgs.com.tw/Terms-and-Conditions> and for electronic format documents, subject to Terms and Conditions for Electronic Documents at <http://www.sgs.com.tw/Terms-and-Conditions>. Attention is drawn to the limitation of liability, indemnification and jurisdiction issues defined therein. Any holder of this document is advised that information contained hereon reflects the Company's findings at the time of its intervention only and within the limits of Client's instructions, if any. The Company's sole responsibility is to its Client and this document does not exonerate parties to a transaction from exercising all their rights and obligations under the transaction documents. This document cannot be reproduced except in full, without prior written approval of the Company. Any unauthorized alteration, forgery or falsification of the content or appearance of this document is unlawful and offenders may be prosecuted to the fullest extent of the law.

SGS Taiwan Ltd.

台灣檢驗科技股份有限公司

No.134,Wu Kung Road, New Taipei Industrial Park, Wuku District, New Taipei City, Taiwan/新北市五股區新北產業園區五工路 134 號

t (886-2) 2299-3279

f (886-2) 2298-0488

www.sgs.com.tw

Member of SGS Group

QPSK_B5B(826.8+834)

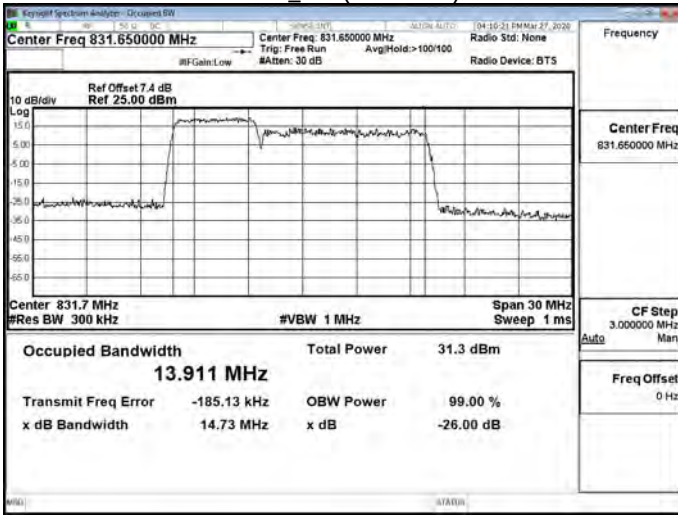

QPSK_B5B(834+841.2)

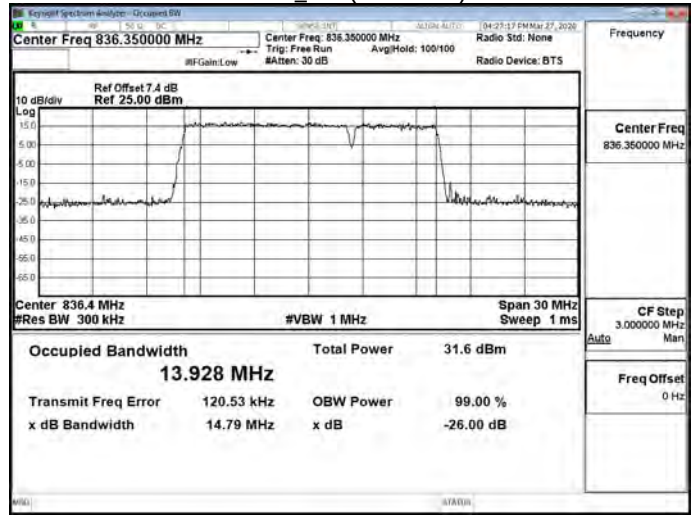

QPSK_B5B(831.6+841.5)

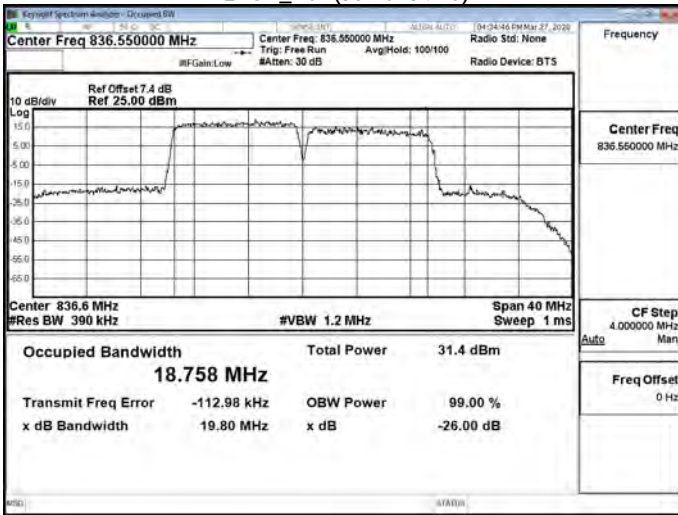

QPSK_B5B(836.8+844)

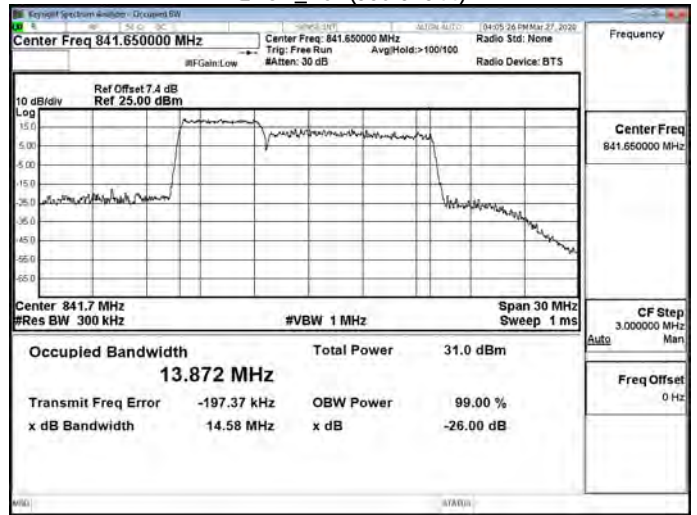

QPSK_B5B(831.8+839)

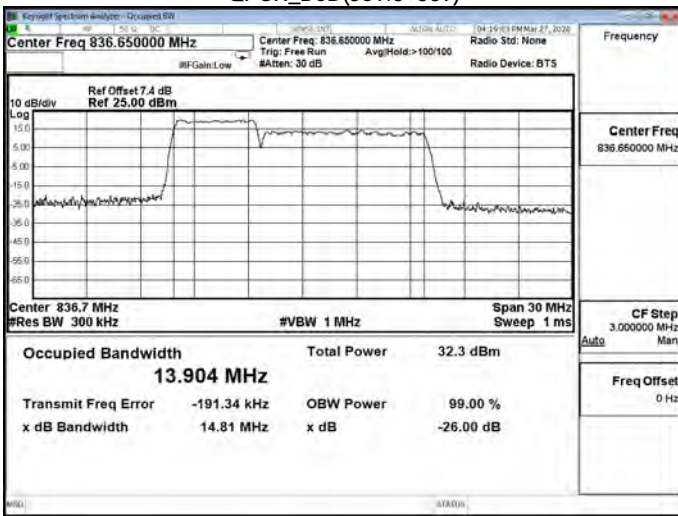

16QAM_B5B(826.8+834)

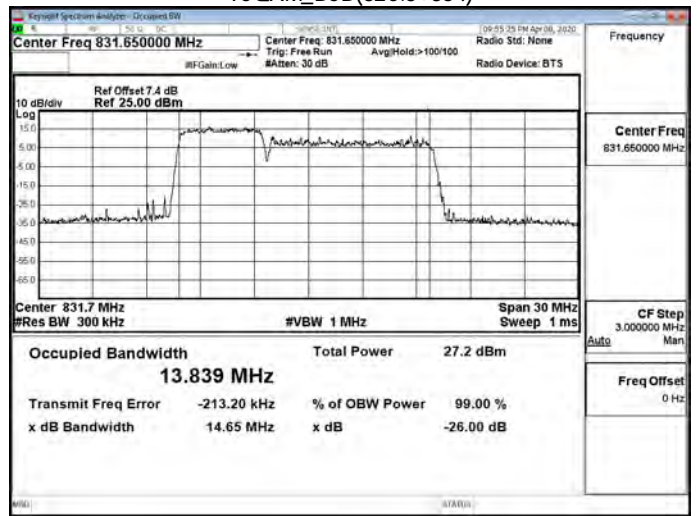

Unless otherwise stated the results shown in this test report refer only to the sample(s) tested and such sample(s) are retained for 90 days only.

除非另有說明，此報告結果僅對測試之樣品負責，同時此樣品僅保留90天。本報告未經本公司書面許可，不可部份複製。

This document is issued by the Company subject to its General Conditions of Service printed overleaf, available on request or accessible at <http://www.sgs.com.tw/Terms-and-Conditions> and for electronic format documents, subject to Terms and Conditions for Electronic Documents at <http://www.sgs.com.tw/Terms-and-Conditions>. Attention is drawn to the limitation of liability, indemnification and jurisdiction issues defined therein. Any holder of this document is advised that information contained hereon reflects the Company's findings at the time of its intervention only and within the limits of Client's instructions, if any. The Company's sole responsibility is to its Client and this document does not exonerate parties to a transaction from exercising all their rights and obligations under the transaction documents. This document cannot be reproduced except in full, without prior written approval of the Company. Any unauthorized alteration, forgery or falsification of the content or appearance of this document is unlawful and offenders may be prosecuted to the fullest extent of the law.

16QAM_B5B(831.6+841.5)

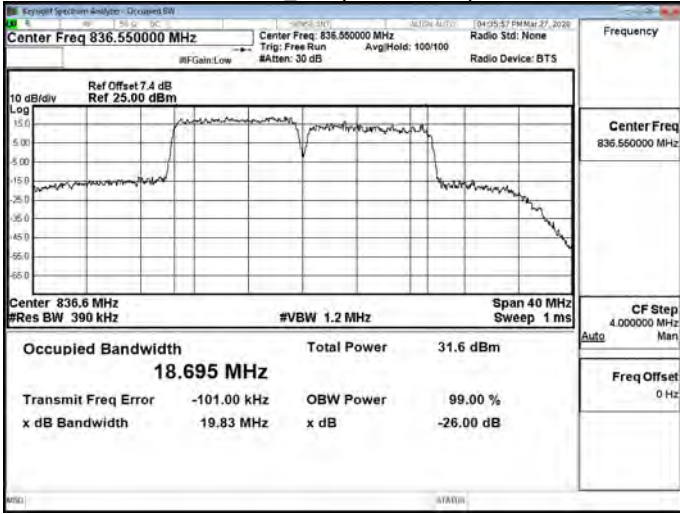

16QAM_B5B(836.8+844)

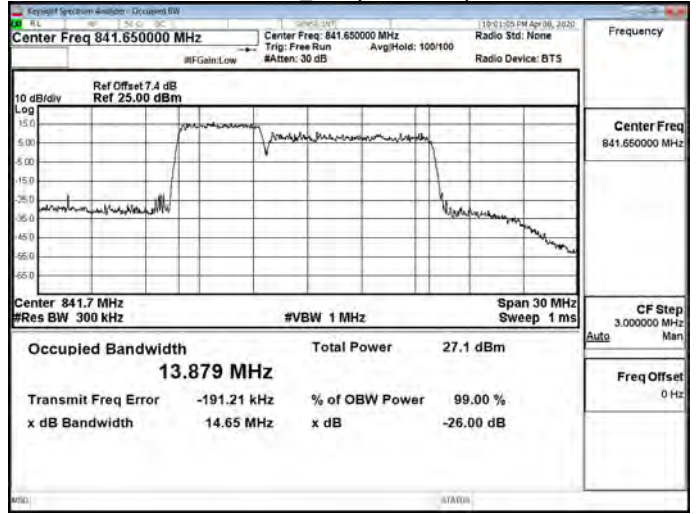

16QAM_B5B(831.8+839)

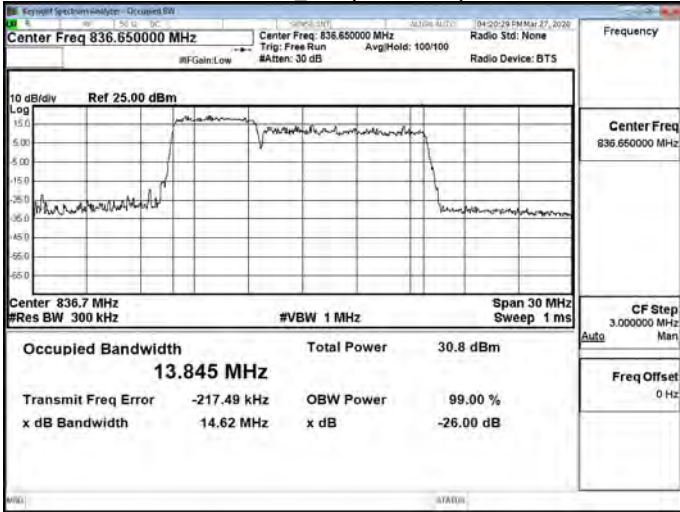

64QAM_B5B(826.8+834)

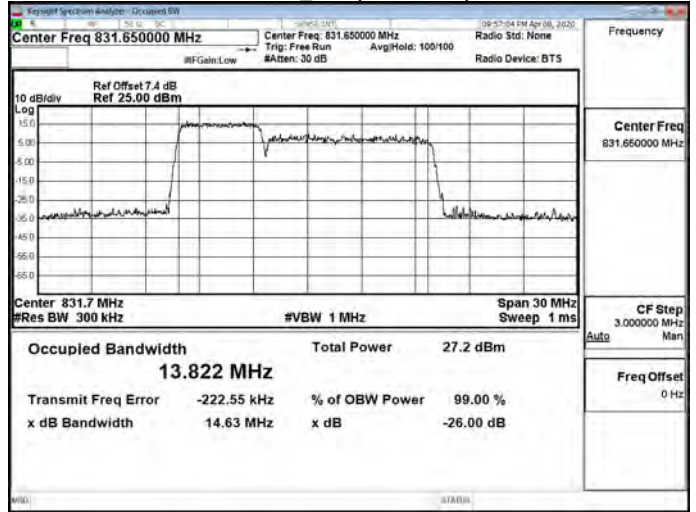

16QAM_B5B(834+841.2)

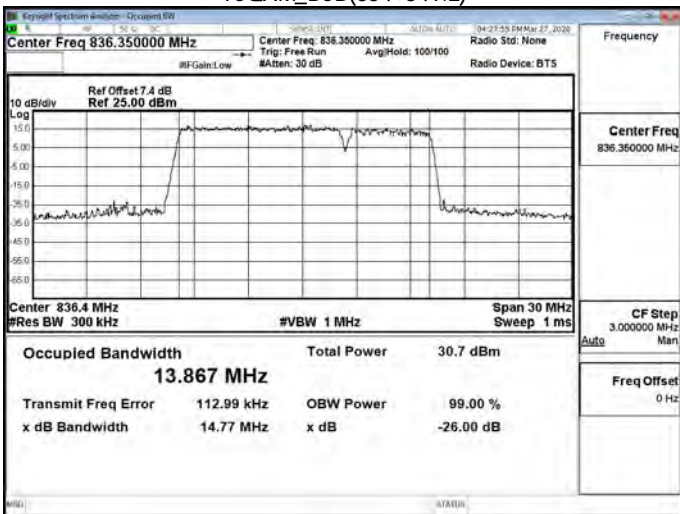

64QAM_B5B(831.6+841.5)

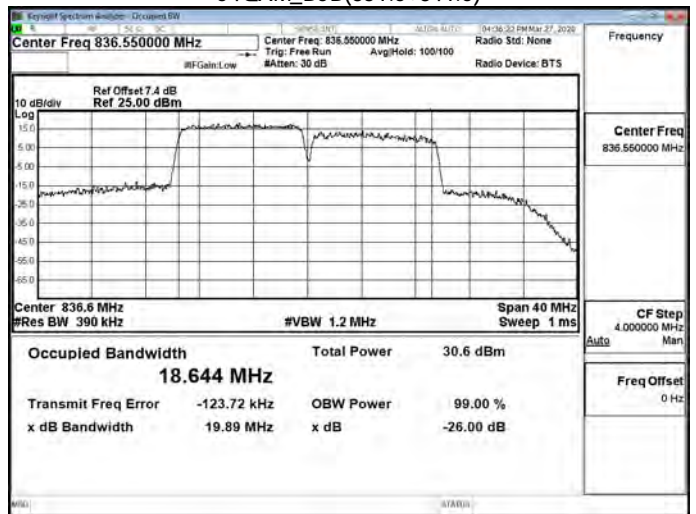

Unless otherwise stated the results shown in this test report refer only to the sample(s) tested and such sample(s) are retained for 90 days only.

除非另有說明，此報告結果僅對測試之樣品負責，同時此樣品僅保留90天。本報告未經本公司書面許可，不可部份複製。

This document is issued by the Company subject to its General Conditions of Service printed overleaf, available on request or accessible at <http://www.sgs.com.tw/Terms-and-Conditions> and for electronic format documents, subject to Terms and Conditions for Electronic Documents at <http://www.sgs.com.tw/Terms-and-Conditions>. Attention is drawn to the limitation of liability, indemnification and jurisdiction issues defined therein. Any holder of this document is advised that information contained hereon reflects the Company's findings at the time of its intervention only and within the limits of Client's instructions, if any. The Company's sole responsibility is to its Client and this document does not exonerate parties to a transaction from exercising all their rights and obligations under the transaction documents. This document cannot be reproduced except in full, without prior written approval of the Company. Any unauthorized alteration, forgery or falsification of the content or appearance of this document is unlawful and offenders may be prosecuted to the fullest extent of the law.

64QAM_B5B(831.8+839)

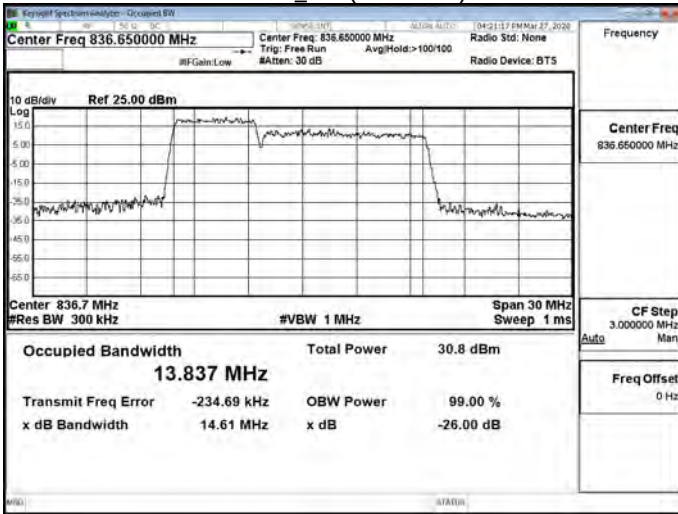

256QAM_B5(826.8+834)

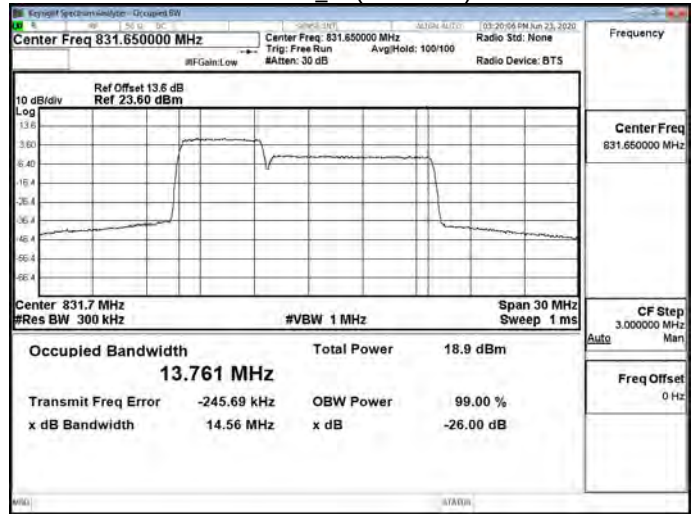

64QAM_B5B(834+841.2)

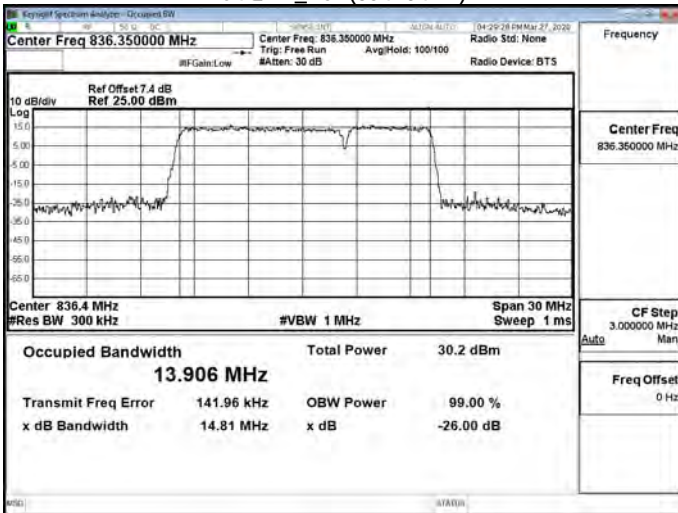

256QAM_B5(831.6+841.5)

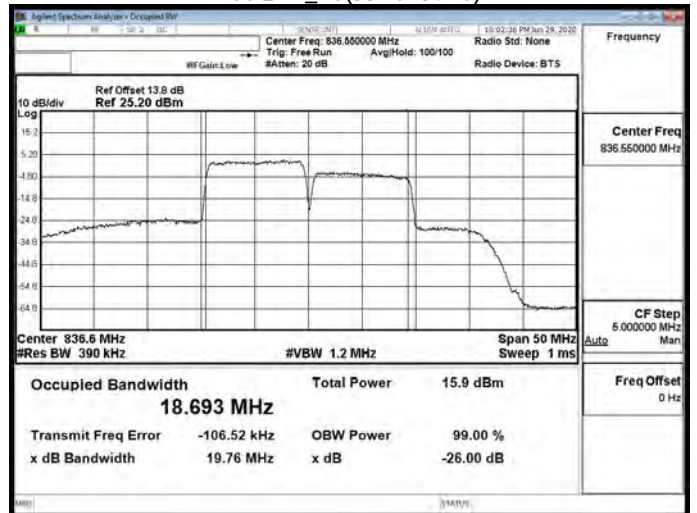

64QAM_B5B(836.8+844)

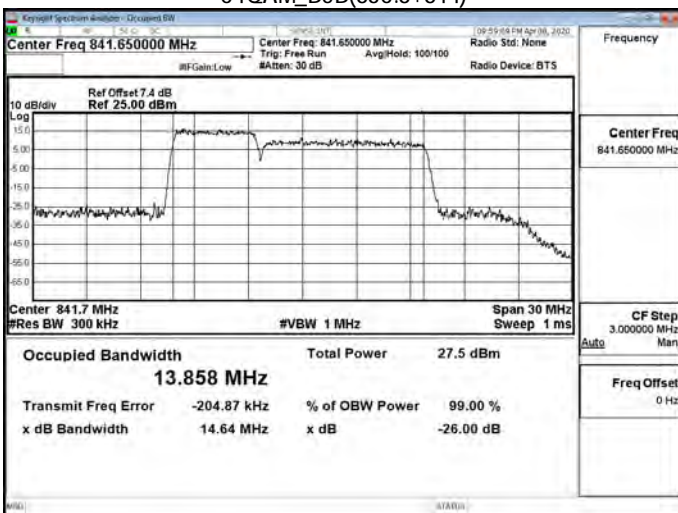

256QAM_B5(831.8+839)

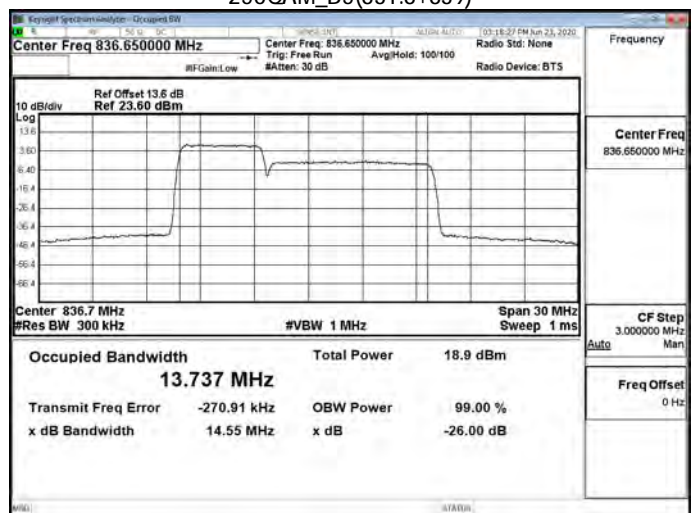

Unless otherwise stated the results shown in this test report refer only to the sample(s) tested and such sample(s) are retained for 90 days only.

除非另有說明，此報告結果僅對測試之樣品負責，同時此樣品僅保留90天，本報告未經本公司書面許可，不可部份複製。

This document is issued by the Company subject to its General Conditions of Service printed overleaf, available on request or accessible at <http://www.sgs.com.tw/Terms-and-Conditions> and for electronic format documents, subject to Terms and Conditions for Electronic Documents at <http://www.sgs.com.tw/Terms-and-Conditions>. Attention is drawn to the limitation of liability, indemnification and jurisdiction issues defined therein. Any holder of this document is advised that information contained hereon reflects the Company's findings at the time of its intervention only and within the limits of Client's instructions, if any. The Company's sole responsibility is to its Client and this document does not exonerate parties to a transaction from exercising all their rights and obligations under the transaction documents. This document cannot be reproduced except in full, without prior written approval of the Company. Any unauthorized alteration, forgery or falsification of the content or appearance of this document is unlawful and offenders may be prosecuted to the fullest extent of the law.

256QAM_B5(834+841.2)

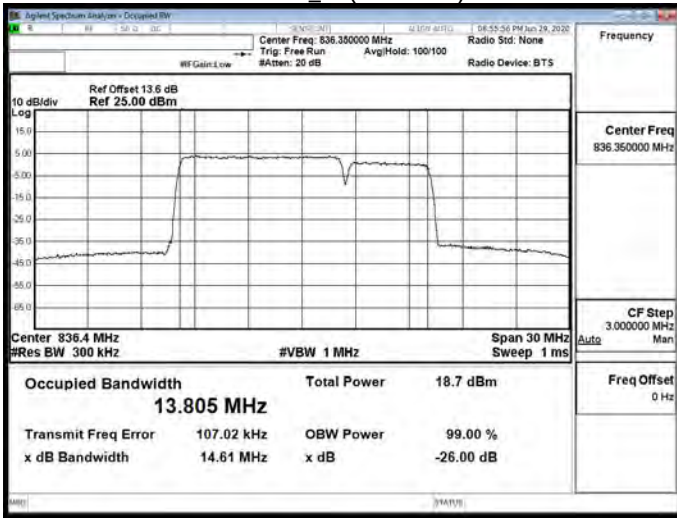

QPSK_B7C(2525.1+2544.9)

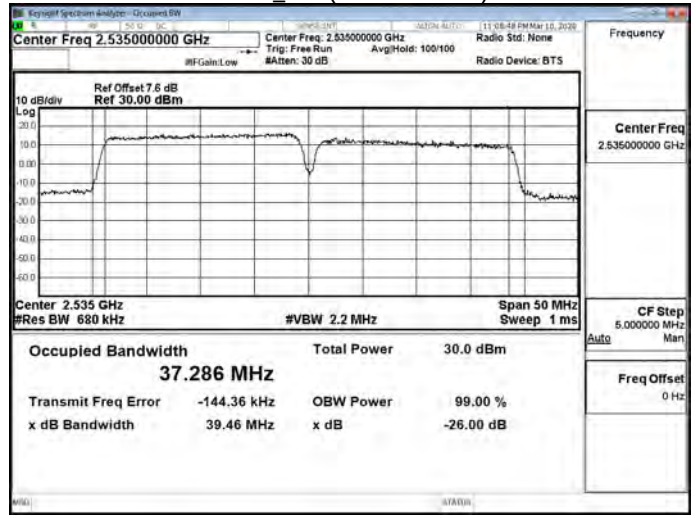

256QAM_B5(836.8+844)

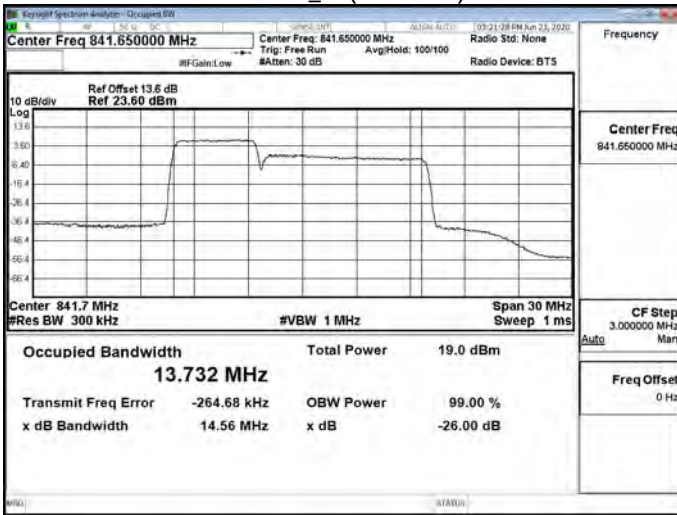

QPSK_B7C(2525.6+2540)

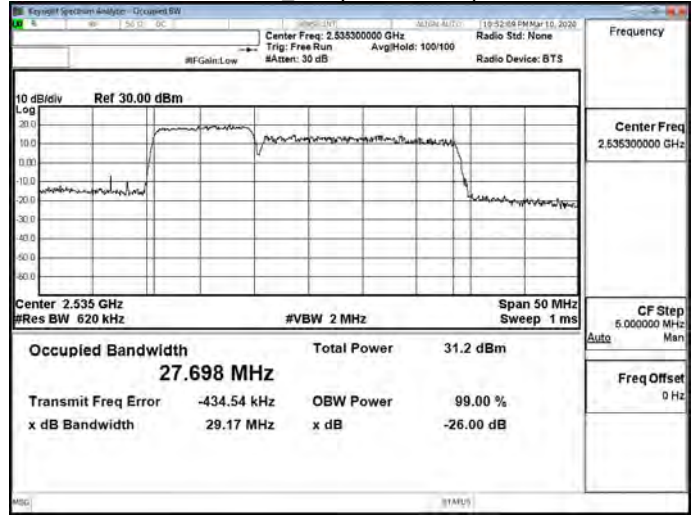

QPSK_B7C(2510+2529.8)

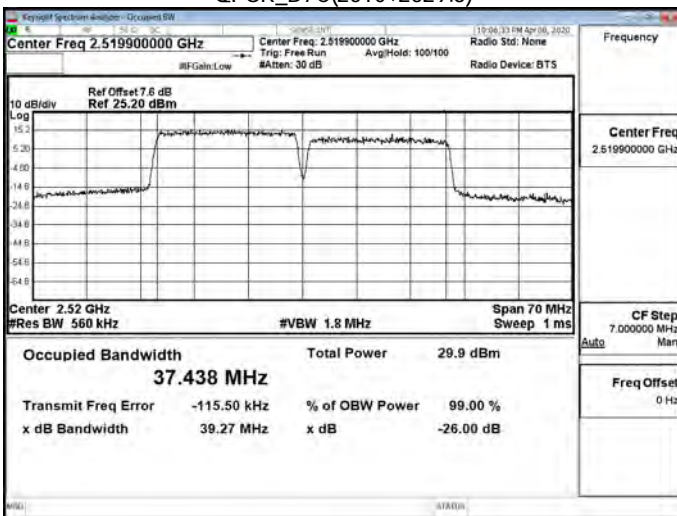

QPSK_B7C(2530.1+2544.5)

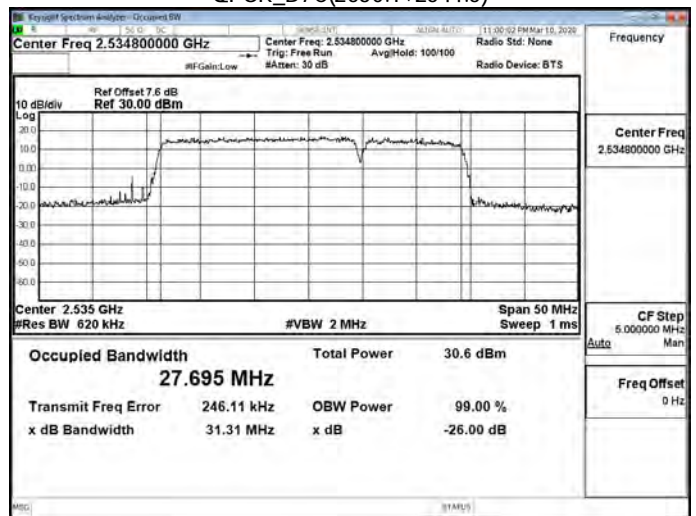

Unless otherwise stated the results shown in this test report refer only to the sample(s) tested and such sample(s) are retained for 90 days only.

除非另有說明，此報告結果僅對測試之樣品負責，同時此樣品僅保留90天。本報告未經本公司書面許可，不可部份複製。

This document is issued by the Company subject to its General Conditions of Service printed overleaf, available on request or accessible at <http://www.sgs.com.tw/Terms-and-Conditions> and for electronic format documents, subject to Terms and Conditions for Electronic Documents at <http://www.sgs.com.tw/Terms-and-Conditions>. Attention is drawn to the limitation of liability, indemnification and jurisdiction issues defined therein. Any holder of this document is advised that information contained hereon reflects the Company's findings at the time of its intervention only and within the limits of Client's instructions, if any. The Company's sole responsibility is to its Client and this document does not exonerate parties to a transaction from exercising all their rights and obligations under the transaction documents. This document cannot be reproduced except in full, without prior written approval of the Company. Any unauthorized alteration, forgery or falsification of the content or appearance of this document is unlawful and offenders may be prosecuted to the fullest extent of the law.

QPSK_B7C(2540.2+2560)

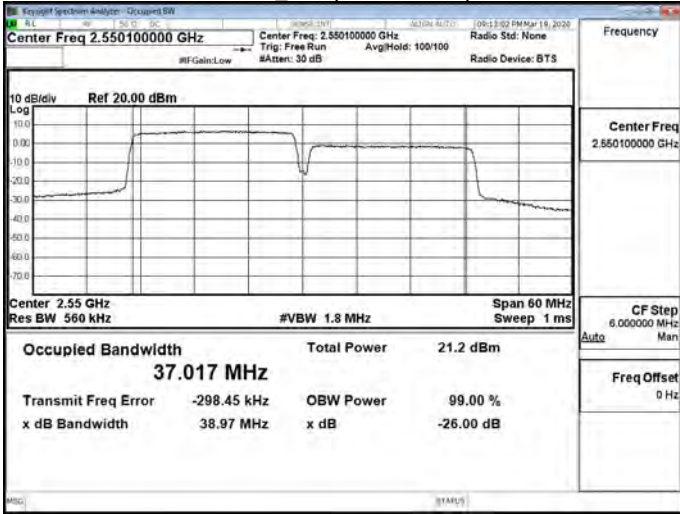

16QAM_B7C(2525.6+2540)

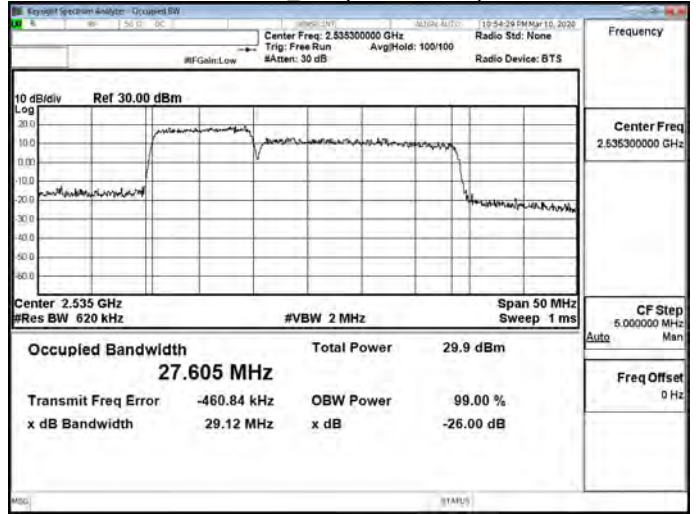

16QAM_B7C(2510+2529.8)

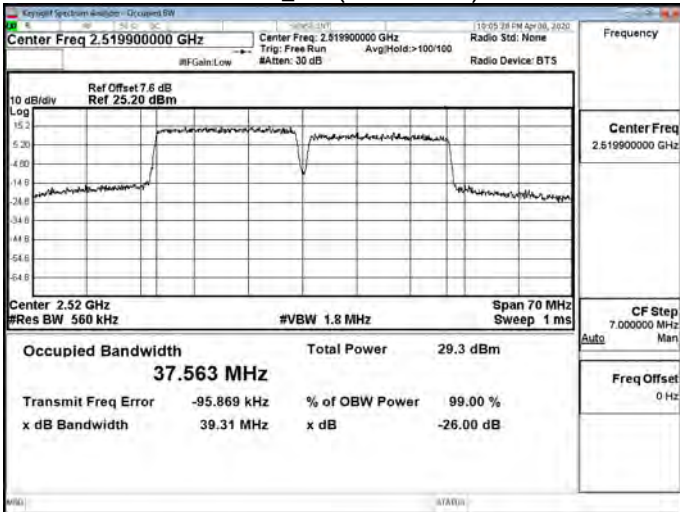

16QAM_B7C(2530.1+2544.5)

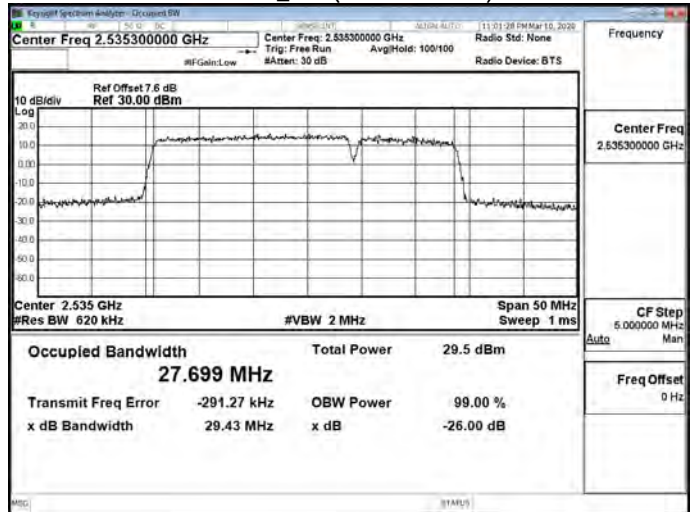

16QAM_B7C(2525.1+2544.9)

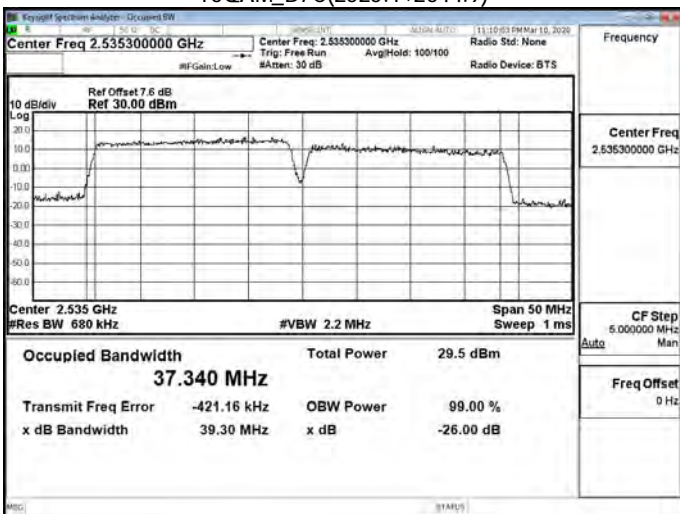

64QAM_B7C(2510+2529.8)

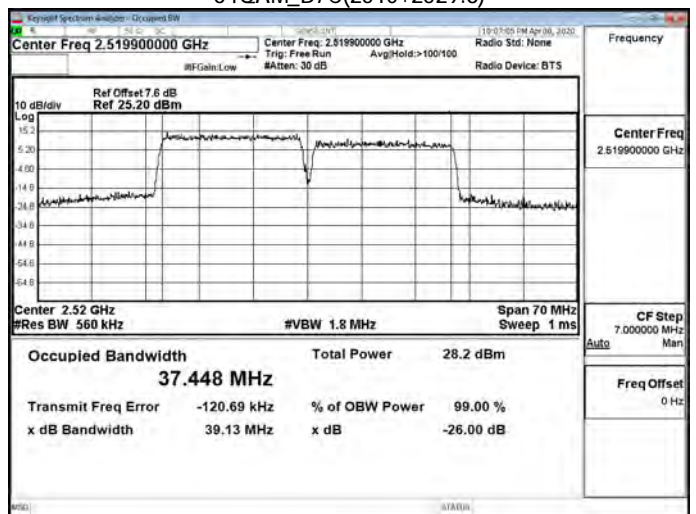

Unless otherwise stated the results shown in this test report refer only to the sample(s) tested and such sample(s) are retained for 90 days only.

除非另有說明，此報告結果僅對測試之樣品負責。同時此樣品僅保留90天。本報告未經本公司書面許可，不可部份複製。

This document is issued by the Company subject to its General Conditions of Service printed overleaf, available on request or accessible at <http://www.sgs.com.tw/Terms-and-Conditions> and for electronic format documents, subject to Terms and Conditions for Electronic Documents at <http://www.sgs.com.tw/Terms-and-Conditions>. Attention is drawn to the limitation of liability, indemnification and jurisdiction issues defined therein. Any holder of this document is advised that information contained hereon reflects the Company's findings at the time of its intervention only and within the limits of Client's instructions, if any. The Company's sole responsibility is to its Client and this document does not exonerate parties to a transaction from exercising all their rights and obligations under the transaction documents. This document cannot be reproduced except in full, without prior written approval of the Company. Any unauthorized alteration, forgery or falsification of the content or appearance of this document is unlawful and offenders may be prosecuted to the fullest extent of the law.

64QAM_B7C(2525.1+2544.9)

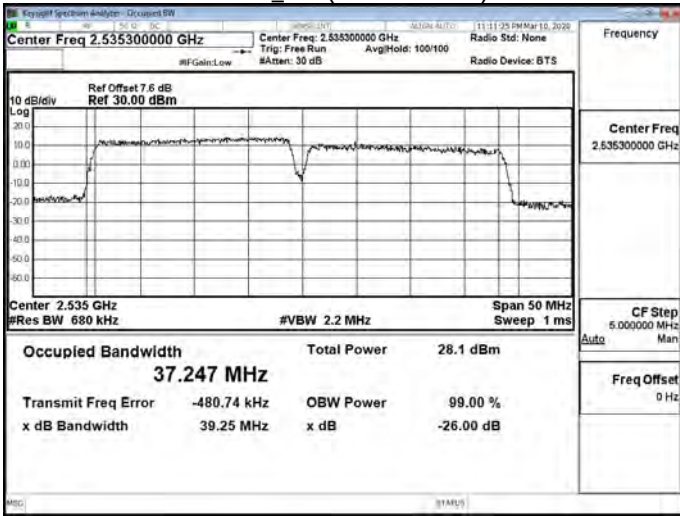

256QAM_B7(2510+2529.8)

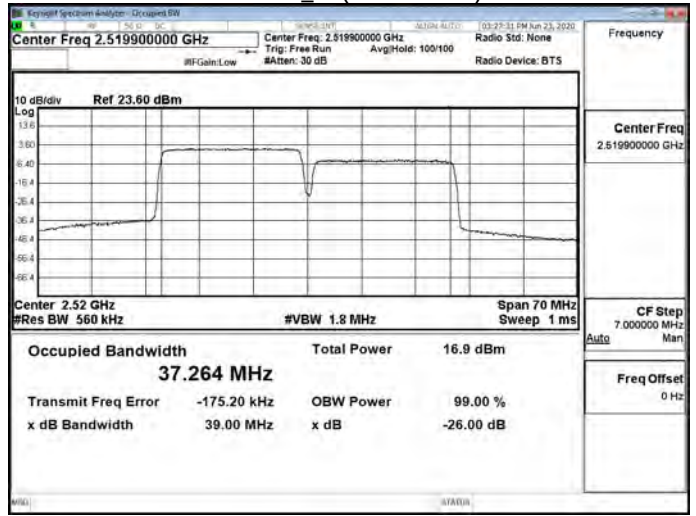

64QAM_B7C(2525.6+2540)

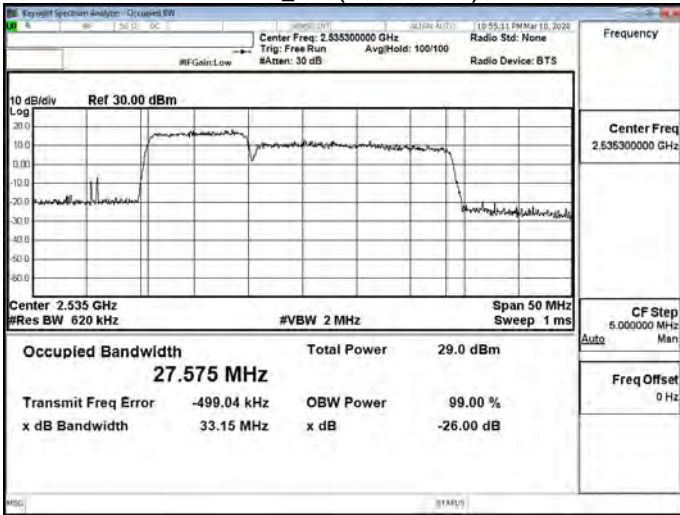

256QAM_B7(2525.1+2544.9)

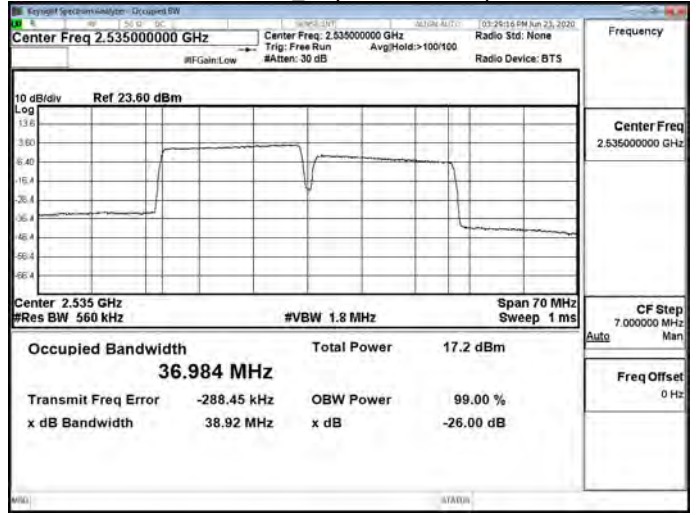

64QAM_B7C(2530.1+2544.5)

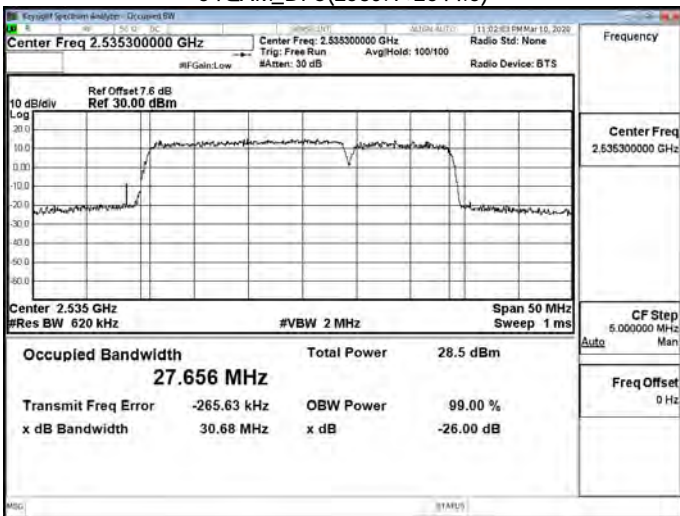

256QAM_B7(2525.6+2540)

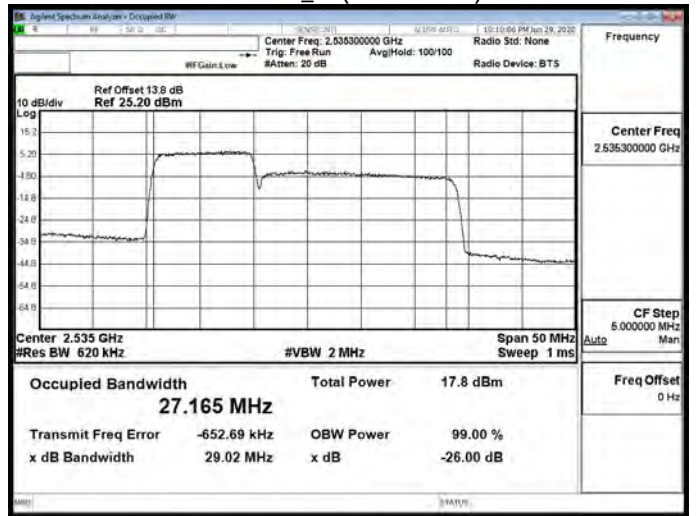

Unless otherwise stated the results shown in this test report refer only to the sample(s) tested and such sample(s) are retained for 90 days only.

除非另有說明，此報告結果僅對測試之樣品負責。同時此樣品僅保留90天。本報告未經本公司書面許可，不可部份複製。

This document is issued by the Company subject to its General Conditions of Service printed overleaf, available on request or accessible at <http://www.sgs.com.tw/Terms-and-Conditions> and for electronic format documents, subject to Terms and Conditions for Electronic Documents at <http://www.sgs.com.tw/Terms-and-Conditions>. Attention is drawn to the limitation of liability, indemnification and jurisdiction issues defined therein. Any holder of this document is advised that information contained hereon reflects the Company's findings at the time of its intervention only and within the limits of Client's instructions, if any. The Company's sole responsibility is to its Client and this document does not exonerate parties to a transaction from exercising all their rights and obligations under the transaction documents. This document cannot be reproduced except in full, without prior written approval of the Company. Any unauthorized alteration, forgery or falsification of the content or appearance of this document is unlawful and offenders may be prosecuted to the fullest extent of the law.

256QAM_B7(2530.1+2544.5)

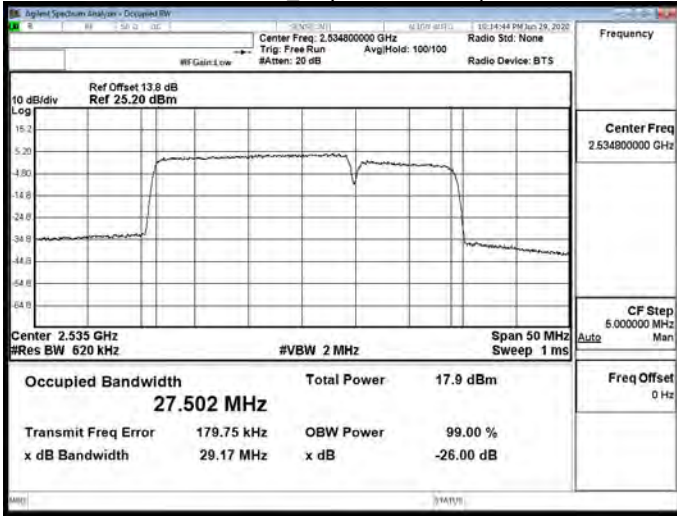

QPSK_B41C(2583.1+2602.9)

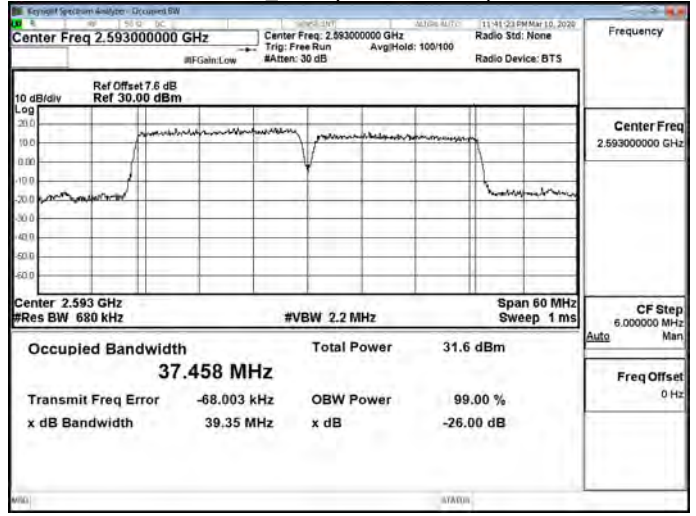

256QAM_B7(2540.2+2560)

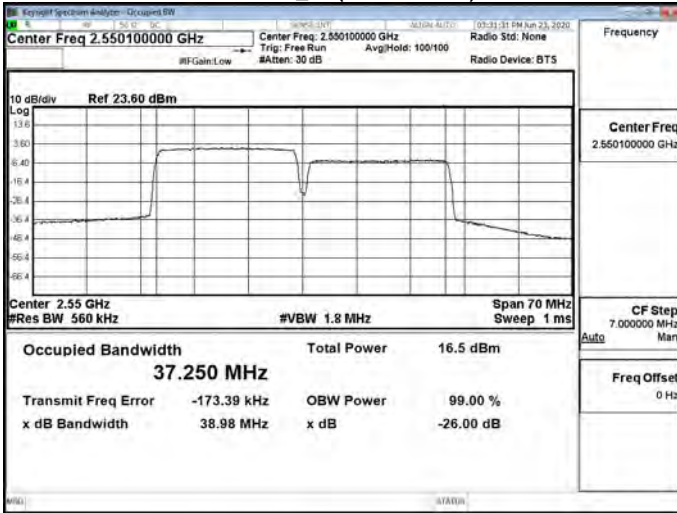

QPSK_B41C(2583.8+2595.5)

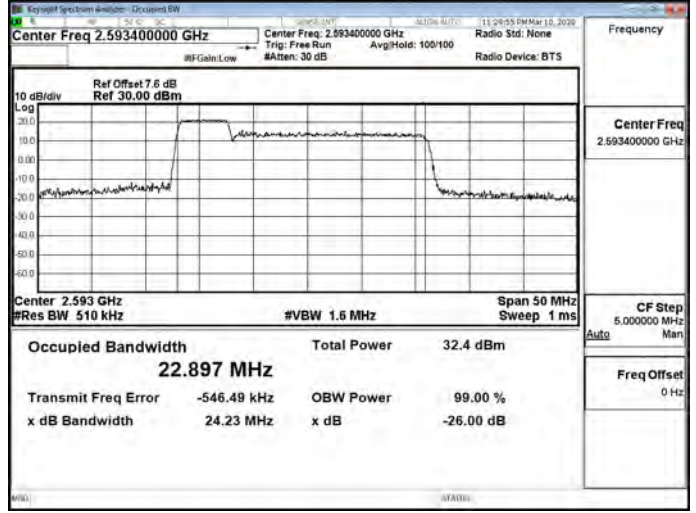

QPSK_B41C(2499.3+2511)

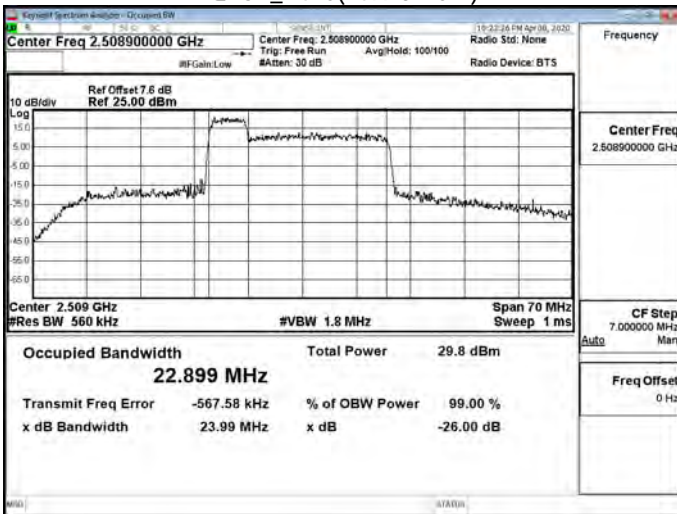

QPSK_B41C(2590.5+2602.2)

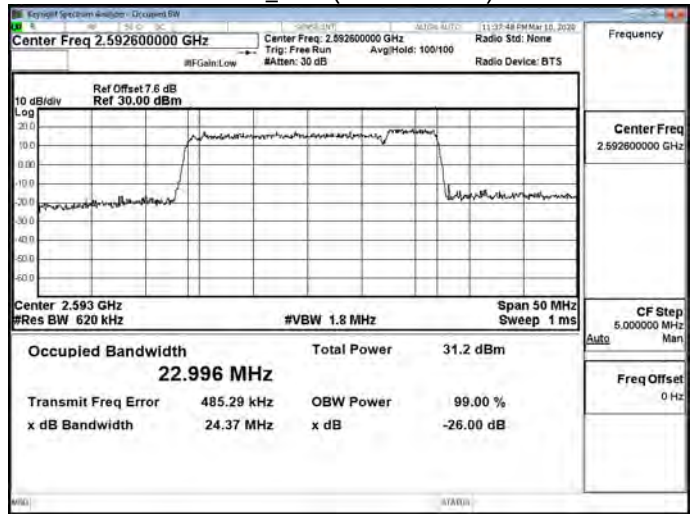

Unless otherwise stated the results shown in this test report refer only to the sample(s) tested and such sample(s) are retained for 90 days only.

除非另有說明，此報告結果僅對測試之樣品負責，同時此樣品僅保留90天。本報告未經本公司書面許可，不可部份複製。

This document is issued by the Company subject to its General Conditions of Service printed overleaf, available on request or accessible at <http://www.sgs.com.tw/Terms-and-Conditions> and for electronic format documents, subject to Terms and Conditions for Electronic Documents at <http://www.sgs.com.tw/Terms-and-Conditions>. Attention is drawn to the limitation of liability, indemnification and jurisdiction issues defined therein. Any holder of this document is advised that information contained hereon reflects the Company's findings at the time of its intervention only and within the limits of Client's instructions, if any. The Company's sole responsibility is to its Client and this document does not exonerate parties to a transaction from exercising all their rights and obligations under the transaction documents. This document cannot be reproduced except in full, without prior written approval of the Company. Any unauthorized alteration, forgery or falsification of the content or appearance of this document is unlawful and offenders may be prosecuted to the fullest extent of the law.

QPSK_B41C(2668.3+2680)

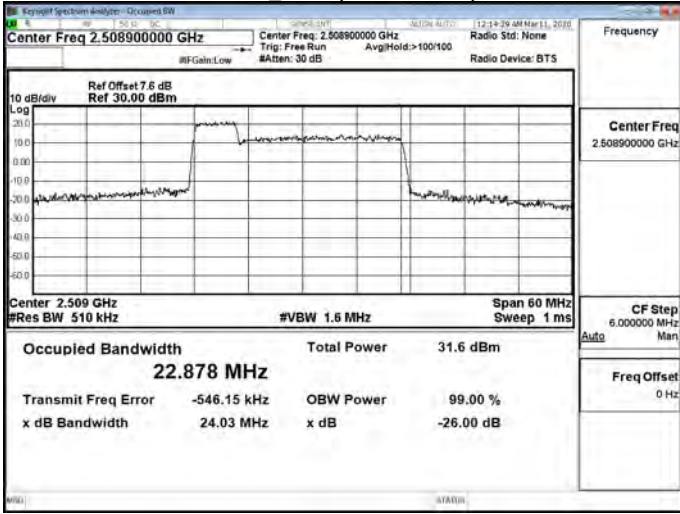

16QAM_B41C(2583.8+2595.5)

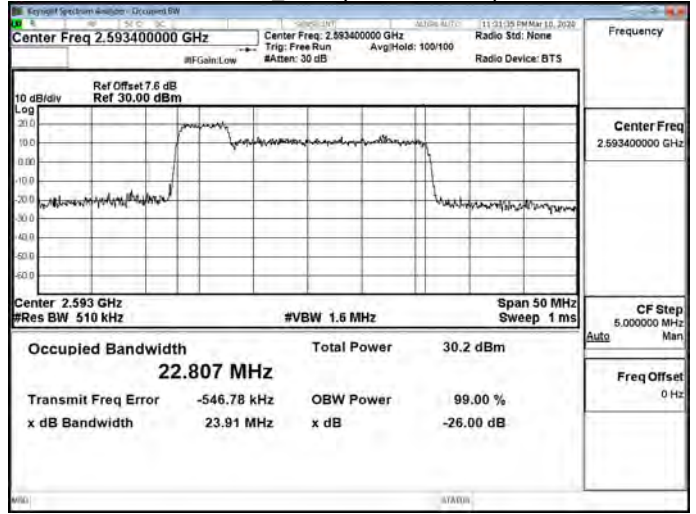

16QAM_B41C(2499.3+2511)

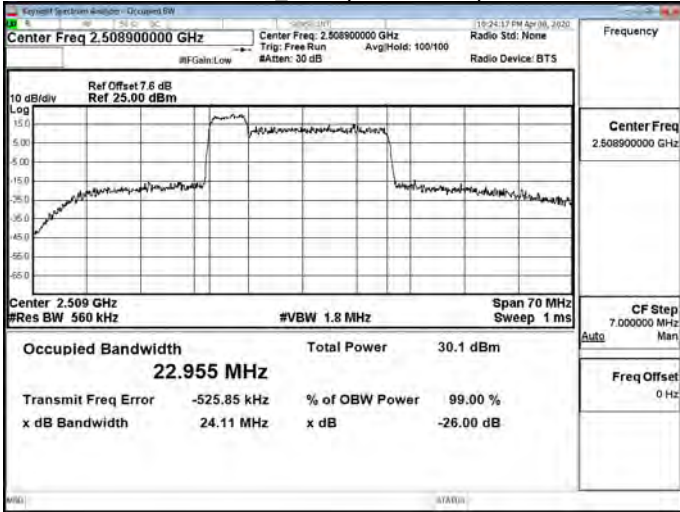

16QAM_B41C(2590.5+2602.2)

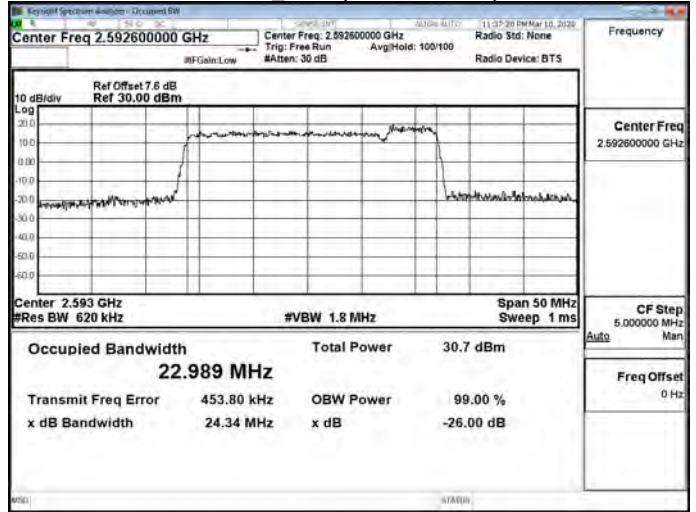

16QAM_B41C(2583.1+2602.9)

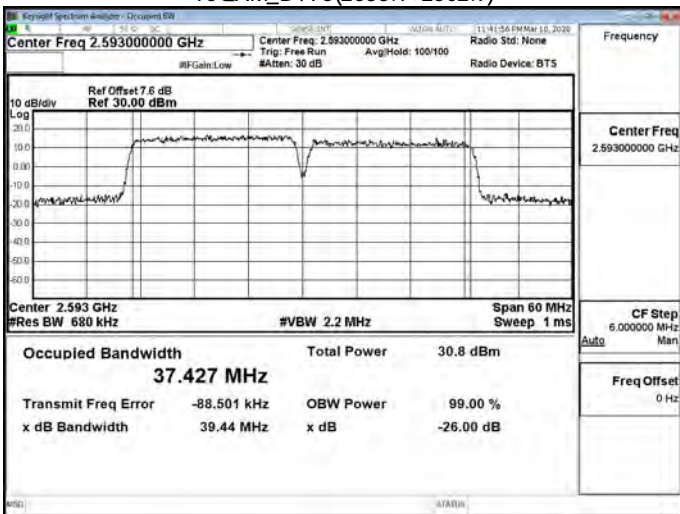

64QAM_B41C(2499.3+2511)

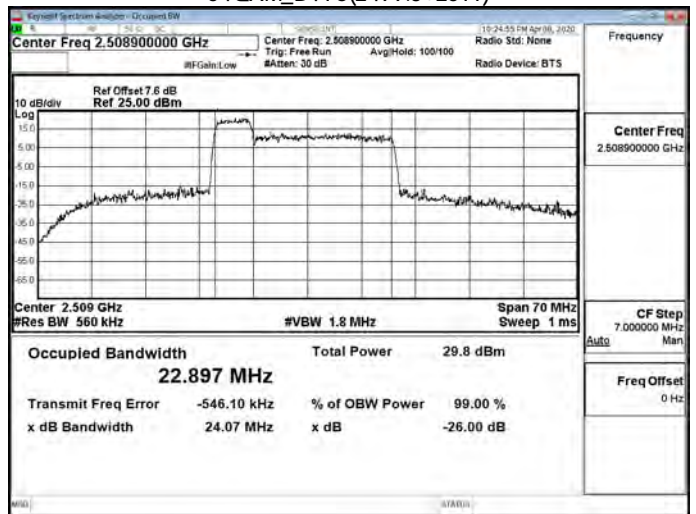

Unless otherwise stated the results shown in this test report refer only to the sample(s) tested and such sample(s) are retained for 90 days only.

除非另有說明，此報告結果僅對測試之樣品負責。同時此樣品僅保留90天。本報告未經本公司書面許可，不可部份複製。

This document is issued by the Company subject to its General Conditions of Service printed overleaf, available on request or accessible at <http://www.sgs.com.tw/Terms-and-Conditions> and for electronic format documents, subject to Terms and Conditions for Electronic Documents at <http://www.sgs.com.tw/Terms-and-Conditions>. Attention is drawn to the limitation of liability, indemnification and jurisdiction issues defined therein. Any holder of this document is advised that information contained hereon reflects the Company's findings at the time of its intervention only and within the limits of Client's instructions, if any. The Company's sole responsibility is to its Client and this document does not exonerate parties to a transaction from exercising all their rights and obligations under the transaction documents. This document cannot be reproduced except in full, without prior written approval of the Company. Any unauthorized alteration, forgery or falsification of the content or appearance of this document is unlawful and offenders may be prosecuted to the fullest extent of the law.

64QAM_B41C(2583.1+2602.9)

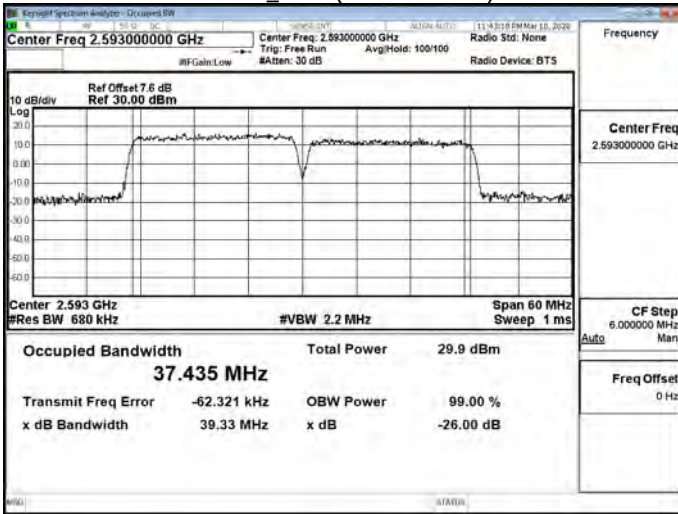

256QAM_B41(2499.3+2511)

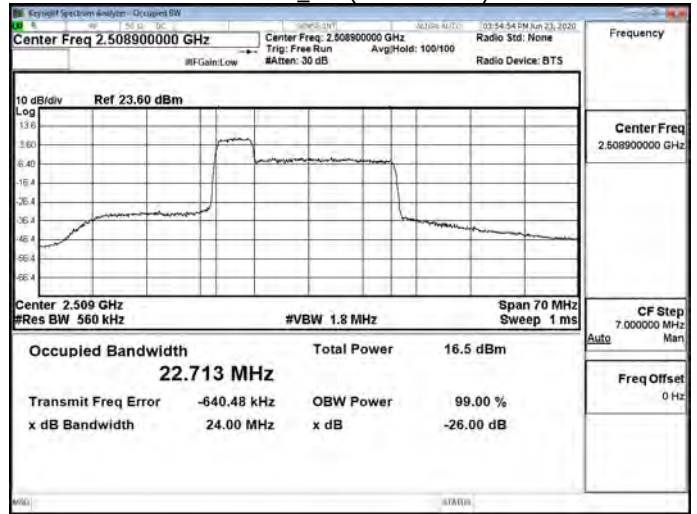

64QAM_B41C(2583.8+2595.5)

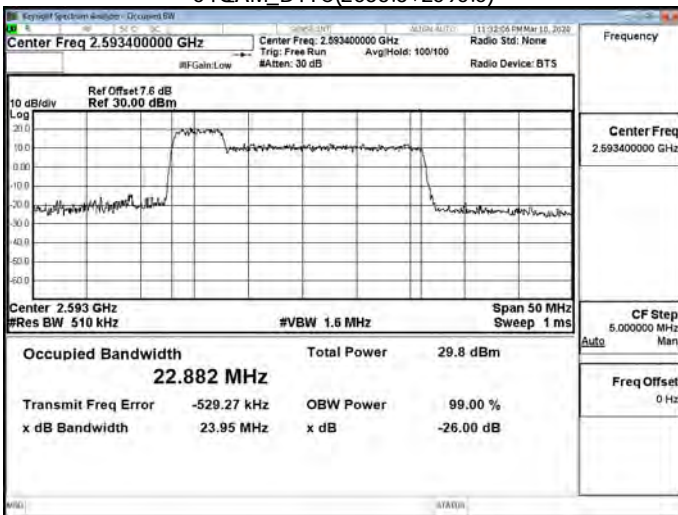

256QAM_B41(2583.1+2602.9)

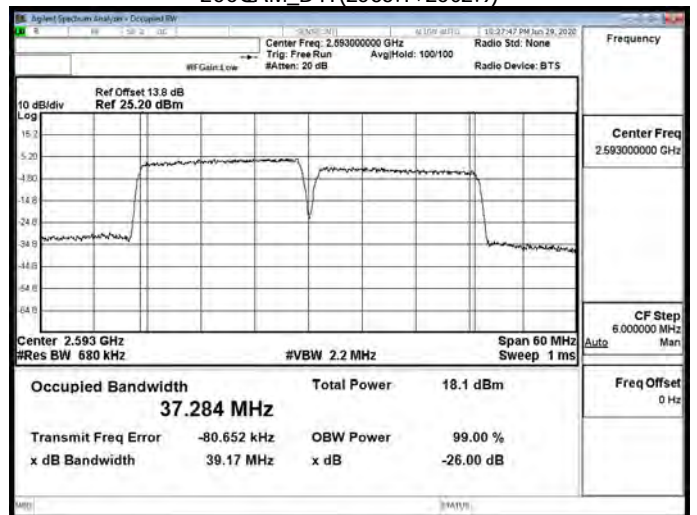

64QAM_B41C(2590.5+2602.2)

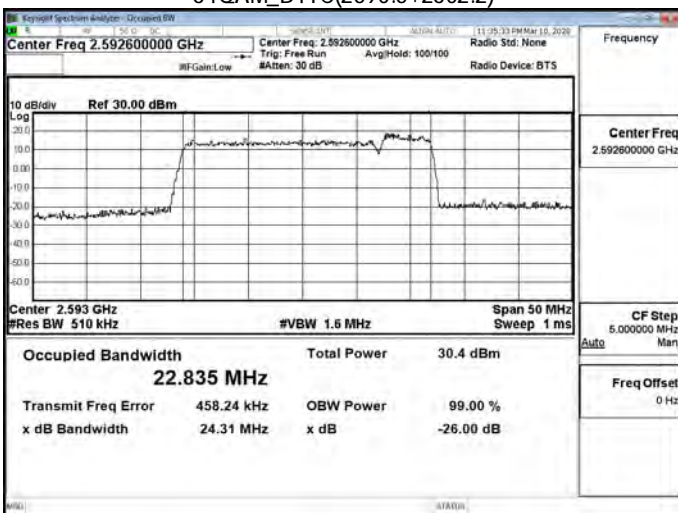

256QAM_B41(2583.8+2595.5)

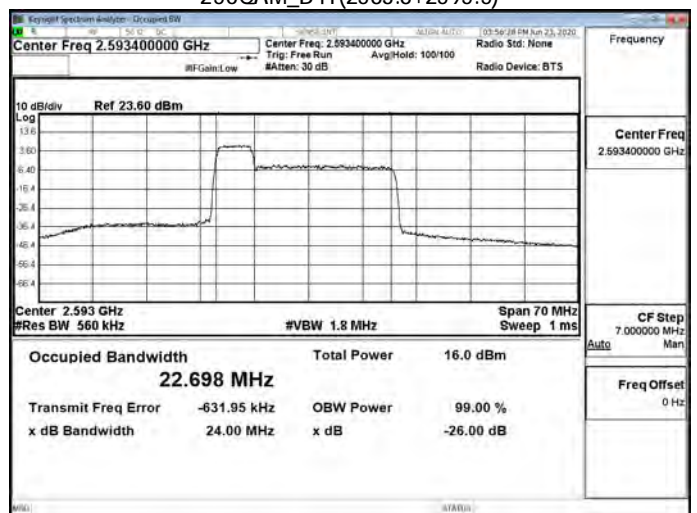

Unless otherwise stated the results shown in this test report refer only to the sample(s) tested and such sample(s) are retained for 90 days only.

除非另有說明，此報告結果僅對測試之樣品負責。同時此樣品僅保留90天。本報告未經本公司書面許可，不可部份複製。

This document is issued by the Company subject to its General Conditions of Service printed overleaf, available on request or accessible at <http://www.sgs.com.tw/Terms-and-Conditions> and for electronic format documents, subject to Terms and Conditions for Electronic Documents at <http://www.sgs.com.tw/Terms-and-Conditions>. Attention is drawn to the limitation of liability, indemnification and jurisdiction issues defined therein. Any holder of this document is advised that information contained hereon reflects the Company's findings at the time of its intervention only and within the limits of Client's instructions, if any. The Company's sole responsibility is to its Client and this document does not exonerate parties to a transaction from exercising all their rights and obligations under the transaction documents. This document cannot be reproduced except in full, without prior written approval of the Company. Any unauthorized alteration, forgery or falsification of the content or appearance of this document is unlawful and offenders may be prosecuted to the fullest extent of the law.

256QAM_B41(2590.5+2602.2)

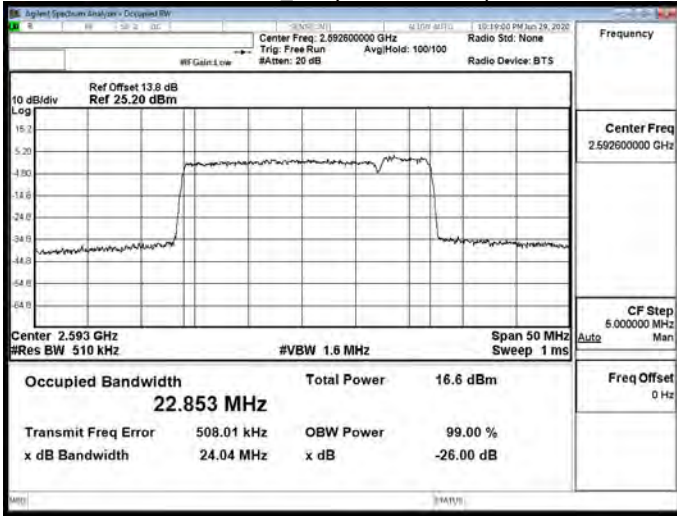

QPSK_B48C(3615.1+3634.9)

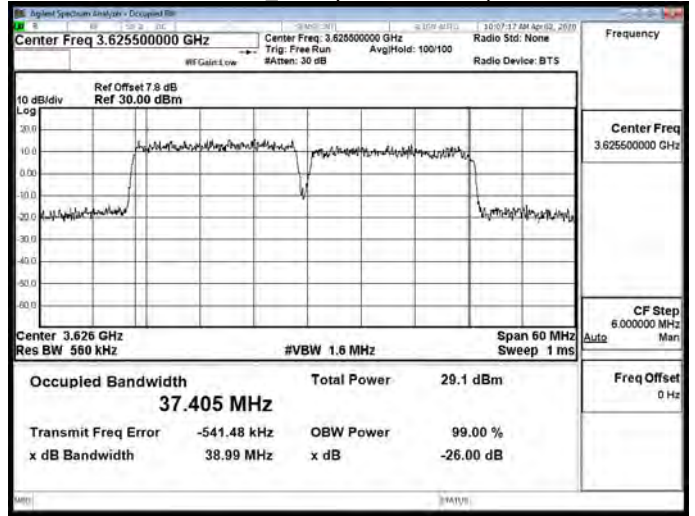

256QAM_B41(2668.3+2680)

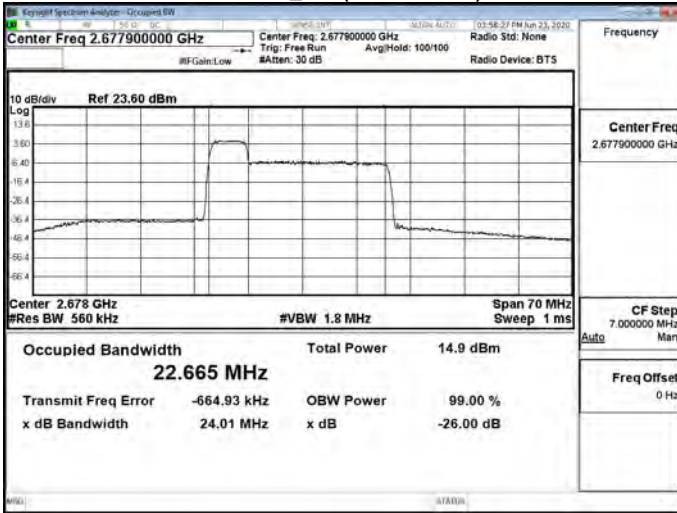

QPSK_B48C(3615.8+33627.5)

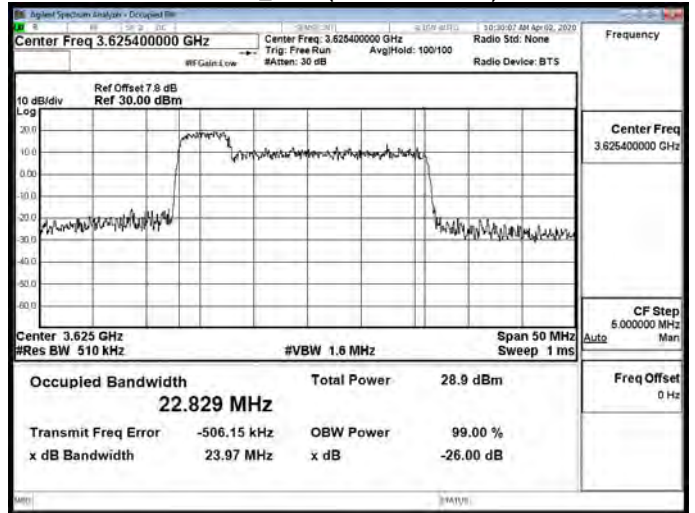

QPSK_B48C(3553.3+3565)

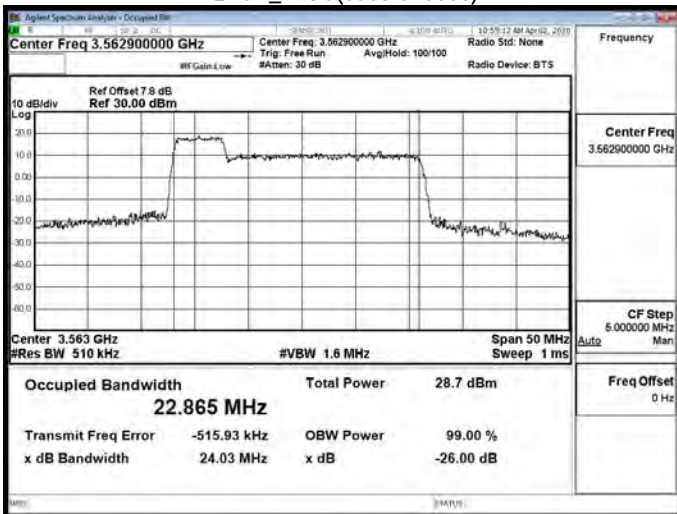

QPSK_B48C(3622.5+3634.2)

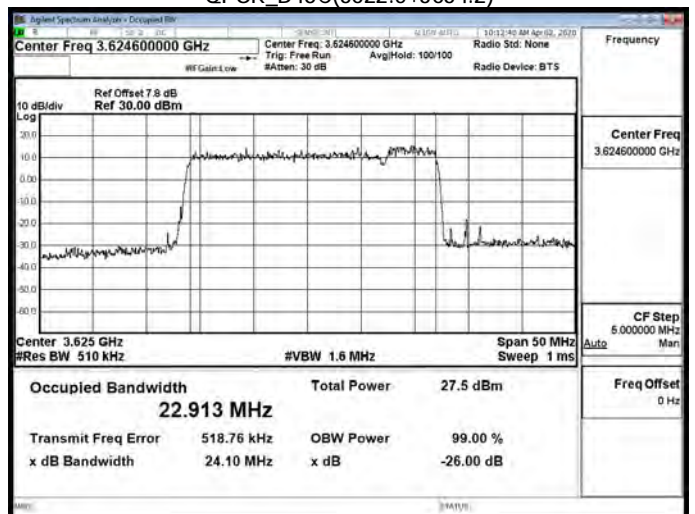

Unless otherwise stated the results shown in this test report refer only to the sample(s) tested and such sample(s) are retained for 90 days only.

除非另有說明，此報告結果僅對測試之樣品負責，同時此樣品僅保留90天。本報告未經本公司書面許可，不可部份複製。

This document is issued by the Company subject to its General Conditions of Service printed overleaf, available on request or accessible at <http://www.sgs.com.tw/Terms-and-Conditions> and for electronic format documents, subject to Terms and Conditions for Electronic Documents at <http://www.sgs.com.tw/Terms-and-Conditions>. Attention is drawn to the limitation of liability, indemnification and jurisdiction issues defined therein. Any holder of this document is advised that information contained hereon reflects the Company's findings at the time of its intervention only and within the limits of Client's instructions, if any. The Company's sole responsibility is to its Client and this document does not exonerate parties to a transaction from exercising all their rights and obligations under the transaction documents. This document cannot be reproduced except in full, without prior written approval of the Company. Any unauthorized alteration, forgery or falsification of the content or appearance of this document is unlawful and offenders may be prosecuted to the fullest extent of the law.

QPSK_B48C(3678.3+3690)

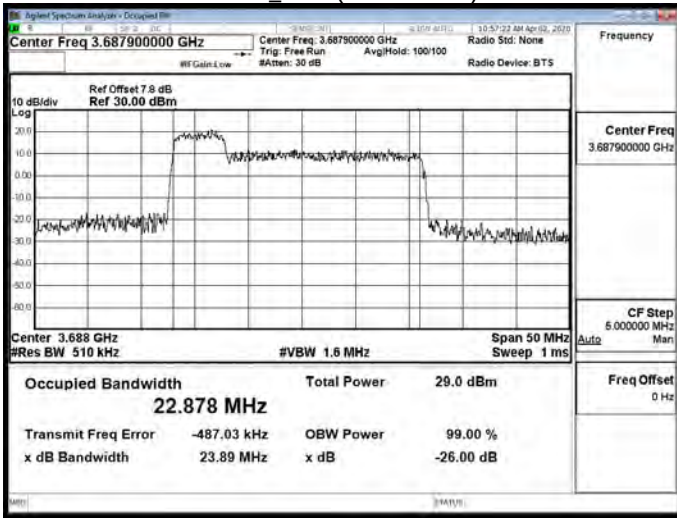

16QAM_B48C(3622.5+3634.2)

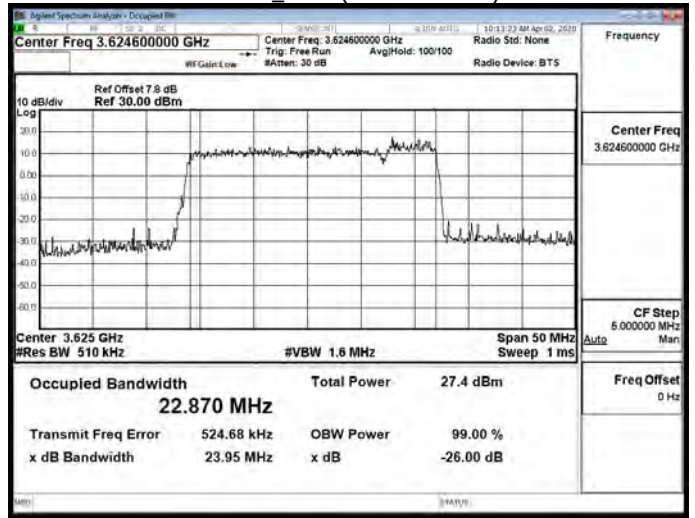

16QAM_B48C(3615.1+3634.9)

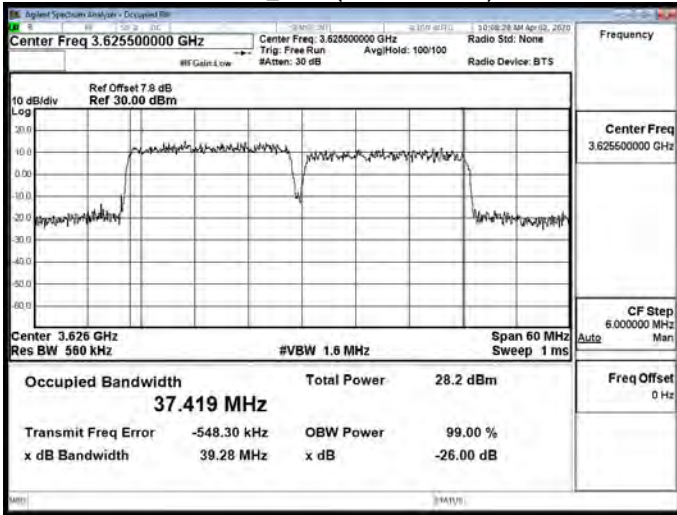

64QAM_B48C(3615.1+3634.9)

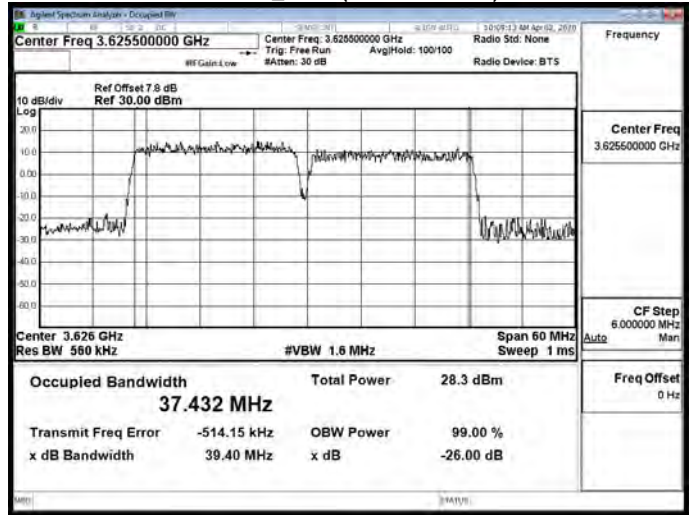

16QAM_B48C(3615.8+33627.5)

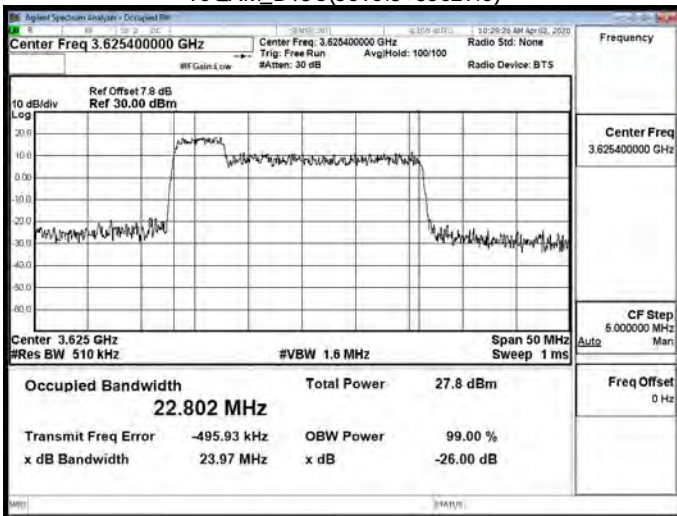

64QAM_B48C(3615.8+33627.5)

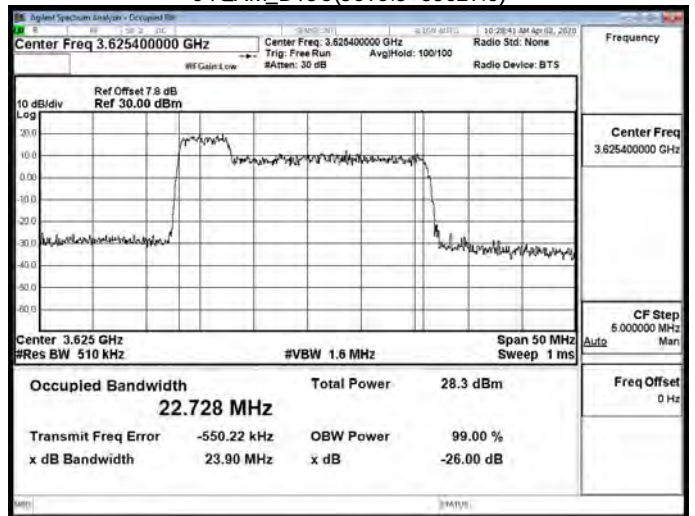

Unless otherwise stated the results shown in this test report refer only to the sample(s) tested and such sample(s) are retained for 90 days only.

除非另有說明，此報告結果僅對測試之樣品負責，同時此樣品僅保留90天。本報告未經本公司書面許可，不可部份複製。

This document is issued by the Company subject to its General Conditions of Service printed overleaf, available on request or accessible at <http://www.sgs.com.tw/Terms-and-Conditions> and for electronic format documents, subject to Terms and Conditions for Electronic Documents at <http://www.sgs.com.tw/Terms-and-Conditions>. Attention is drawn to the limitation of liability, indemnification and jurisdiction issues defined therein. Any holder of this document is advised that information contained hereon reflects the Company's findings at the time of its intervention only and within the limits of Client's instructions, if any. The Company's sole responsibility is to its Client and this document does not exonerate parties to a transaction from exercising all their rights and obligations under the transaction documents. This document cannot be reproduced except in full, without prior written approval of the Company. Any unauthorized alteration, forgery or falsification of the content or appearance of this document is unlawful and offenders may be prosecuted to the fullest extent of the law.

64QAM_B48C(3622.5+3634.2)

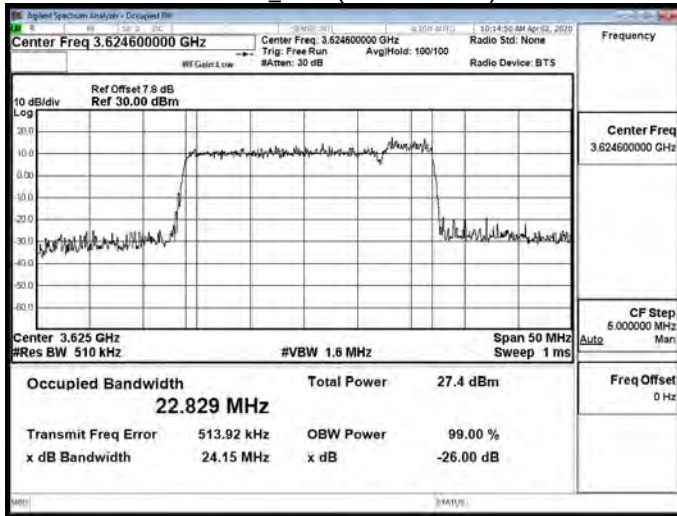

256QAM_B48(3615.8+3627.5)

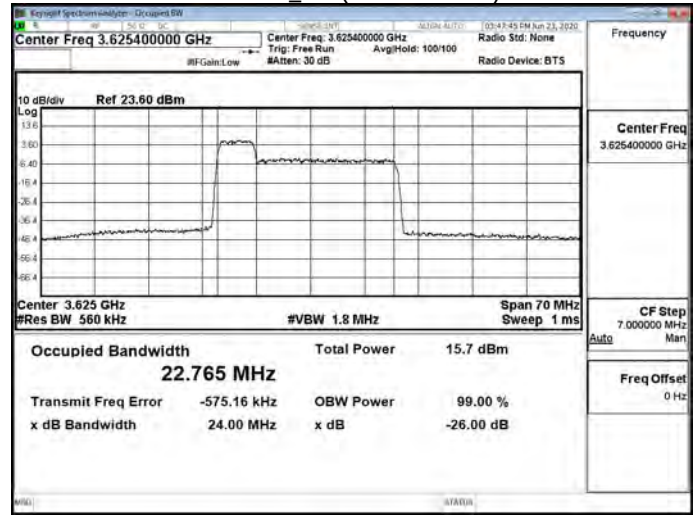

256QAM_B48(3553.3+3565)

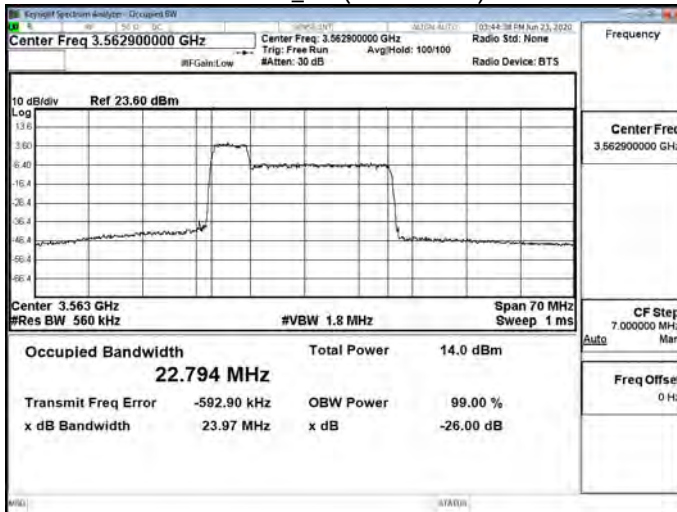

256QAM_B48(3622.5+3634.2)

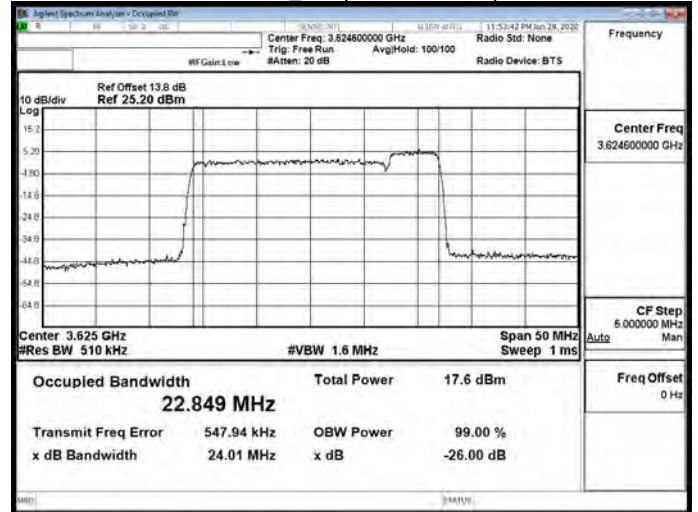

256QAM_B48(3615.1+3634.9)

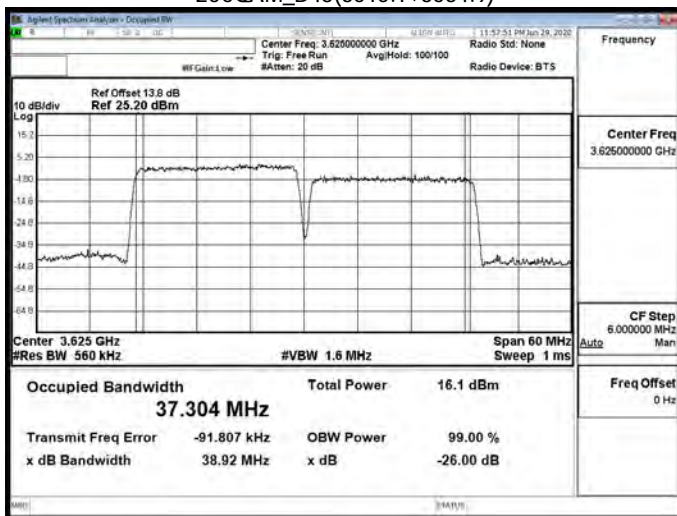

256QAM_B48(3678.3+3690)

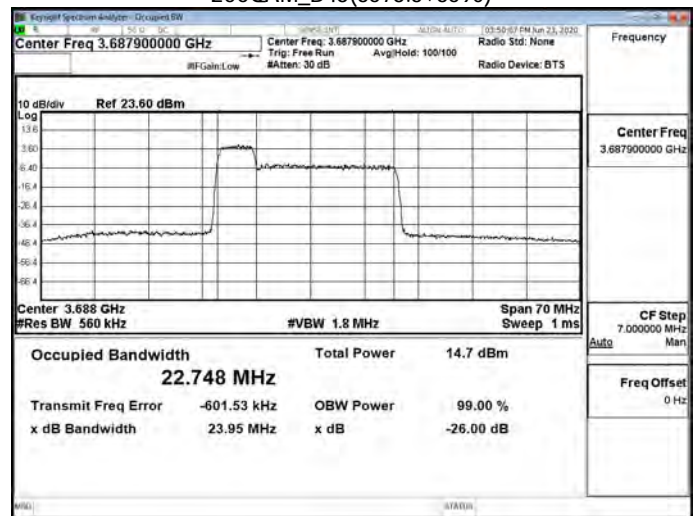

Unless otherwise stated the results shown in this test report refer only to the sample(s) tested and such sample(s) are retained for 90 days only.

除非另有說明，此報告結果僅對測試之樣品負責，同時此樣品僅保留90天。本報告未經本公司書面許可，不可部份複製。

This document is issued by the Company subject to its General Conditions of Service printed overleaf, available on request or accessible at <http://www.sgs.com.tw/Terms-and-Conditions> and for electronic format documents, subject to Terms and Conditions for Electronic Documents at <http://www.sgs.com.tw/Terms-and-Conditions>. Attention is drawn to the limitation of liability, indemnification and jurisdiction issues defined therein. Any holder of this document is advised that information contained hereon reflects the Company's findings at the time of its intervention only and within the limits of Client's instructions, if any. The Company's sole responsibility is to its Client and this document does not exonerate parties to a transaction from exercising all their rights and obligations under the transaction documents. This document cannot be reproduced except in full, without prior written approval of the Company. Any unauthorized alteration, forgery or falsification of the content or appearance of this document is unlawful and offenders may be prosecuted to the fullest extent of the law.

QPSK_B66B(1717.5+1726.8)

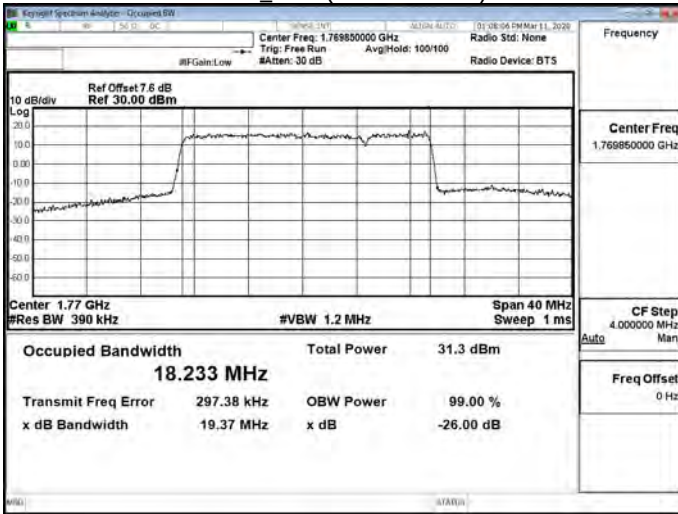

QPSK_B66B(1752.6+1761.9)

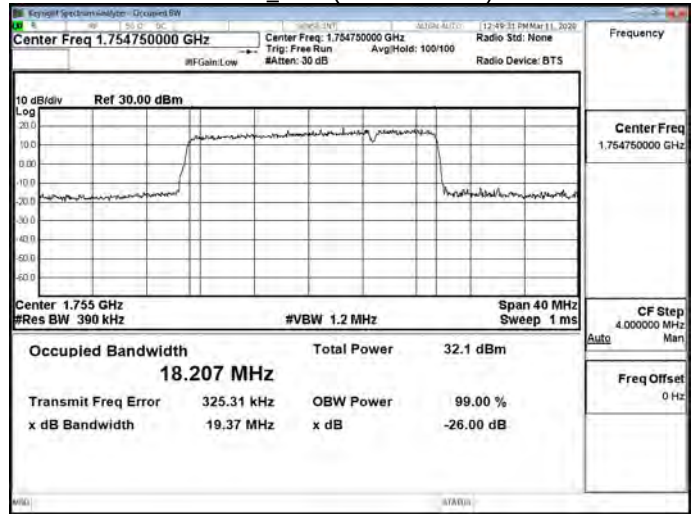

QPSK_B66B(1748.1+1757.4)

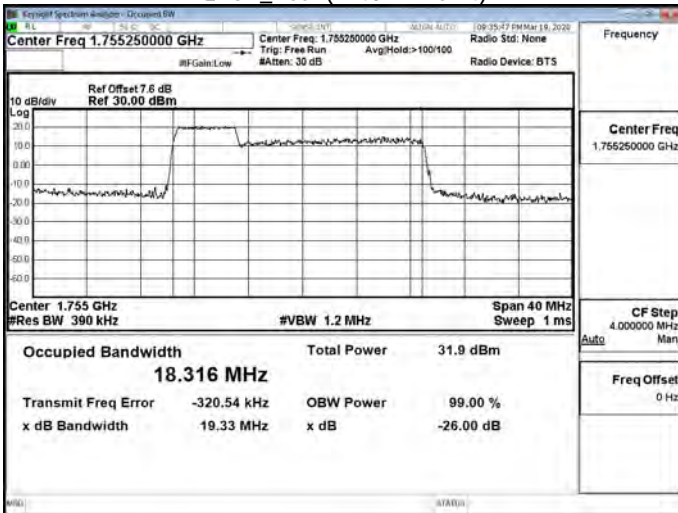

QPSK_B66B(1767.7+1777).PNG

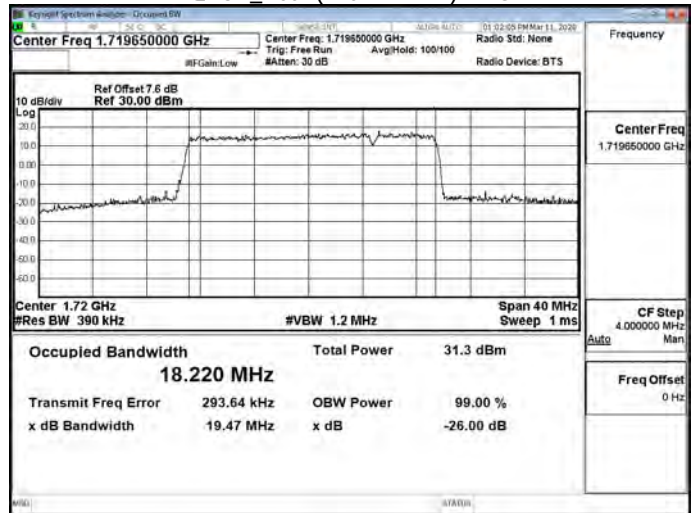

QPSK_B66B(1752.6+1757.4)

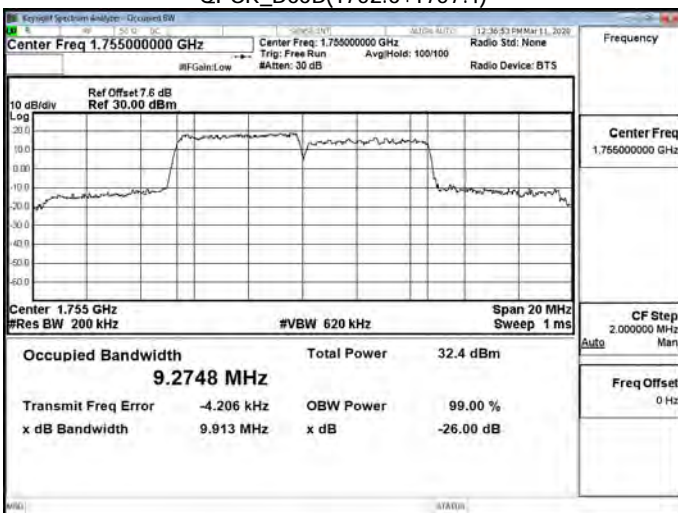

16QAM_B66B(1748.1+1757.4)

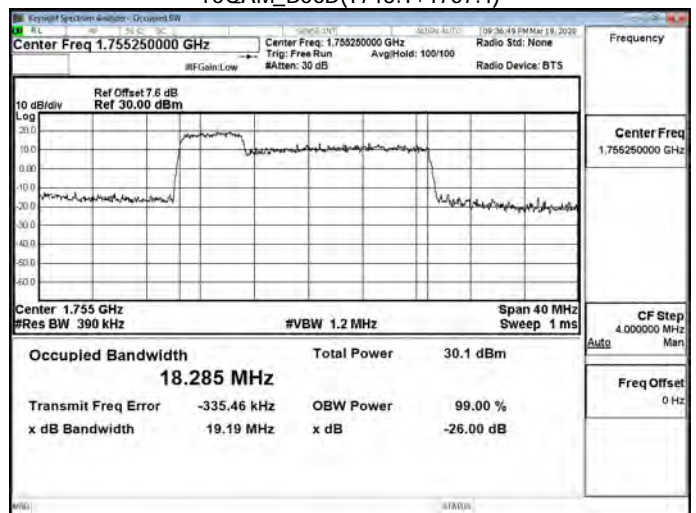

Unless otherwise stated the results shown in this test report refer only to the sample(s) tested and such sample(s) are retained for 90 days only.

除非另有說明，此報告結果僅對測試之樣品負責。同時此樣品僅保留90天。本報告未經本公司書面許可，不可部份複製。

This document is issued by the Company subject to its General Conditions of Service printed overleaf, available on request or accessible at <http://www.sgs.com.tw/Terms-and-Conditions> and for electronic format documents, subject to Terms and Conditions for Electronic Documents at <http://www.sgs.com.tw/Terms-and-Conditions>. Attention is drawn to the limitation of liability, indemnification and jurisdiction issues defined therein. Any holder of this document is advised that information contained hereon reflects the Company's findings at the time of its intervention only and within the limits of Client's instructions, if any. The Company's sole responsibility is to its Client and this document does not exonerate parties to a transaction from exercising all their rights and obligations under the transaction documents. This document cannot be reproduced except in full, without prior written approval of the Company. Any unauthorized alteration, forgery or falsification of the content or appearance of this document is unlawful and offenders may be prosecuted to the fullest extent of the law.

16QAM_B66B(1752.6+1757.4)

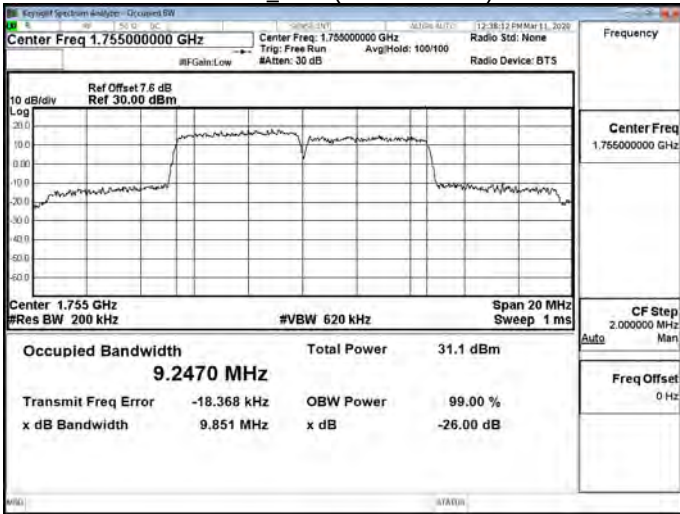

64QAM_B66B(1752.6+1757.4)

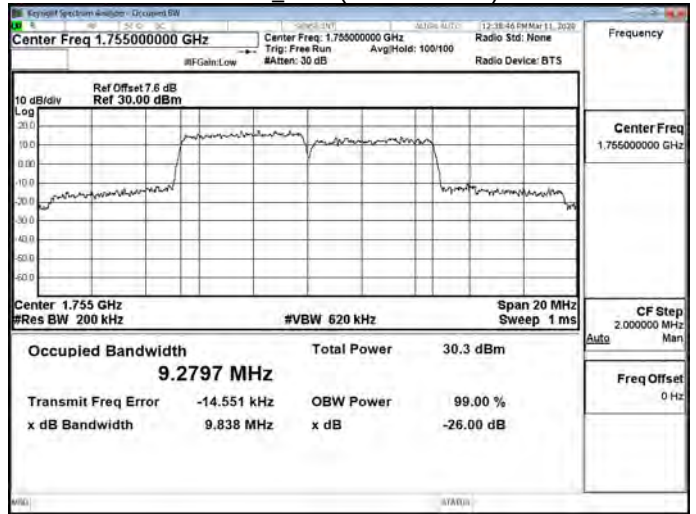

16QAM_B66B(1752.6+1761.9)

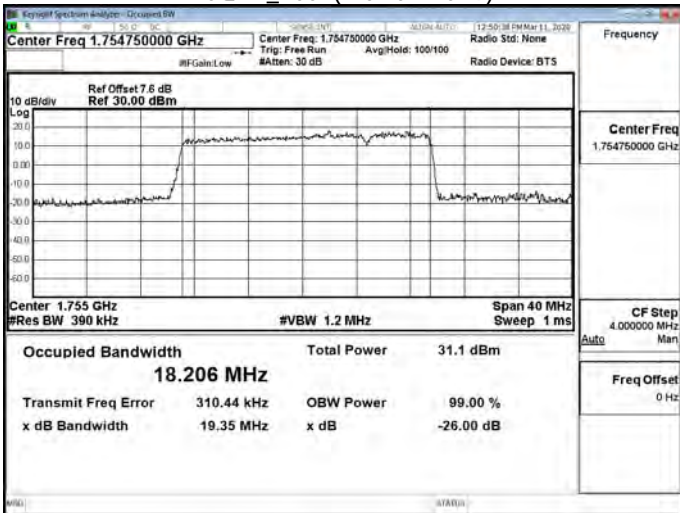

64QAM_B66B(1752.6+1761.9)

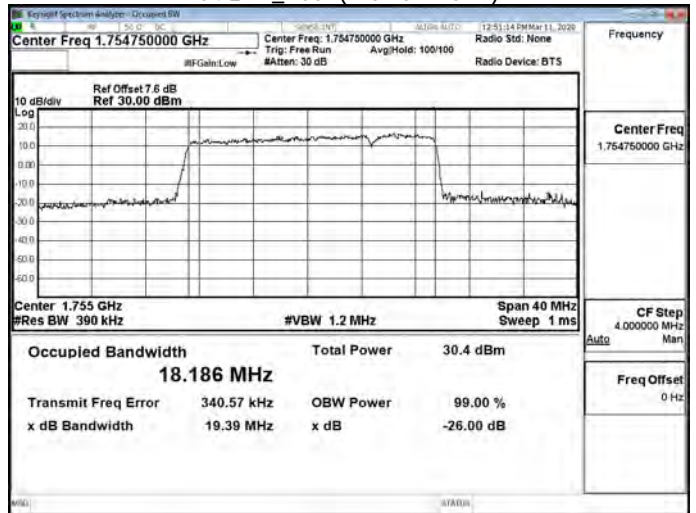

64QAM_B66B(1748.1+1757.4)

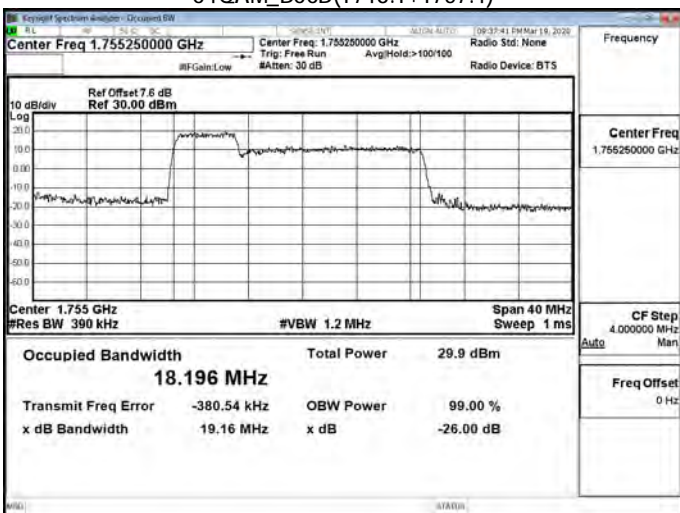

256QAM_B66(1717.5+1726.8)

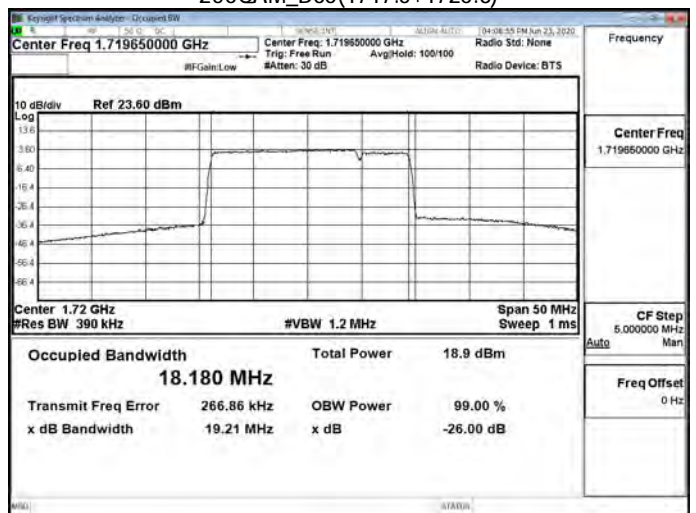

Unless otherwise stated the results shown in this test report refer only to the sample(s) tested and such sample(s) are retained for 90 days only.

除非另有說明，此報告結果僅對測試之樣品負責。同時此樣品僅保留90天。本報告未經本公司書面許可，不可部份複製。

This document is issued by the Company subject to its General Conditions of Service printed overleaf, available on request or accessible at <http://www.sgs.com.tw/Terms-and-Conditions> and for electronic format documents, subject to Terms and Conditions for Electronic Documents at <http://www.sgs.com.tw/Terms-and-Conditions>. Attention is drawn to the limitation of liability, indemnification and jurisdiction issues defined therein. Any holder of this document is advised that information contained hereon reflects the Company's findings at the time of its intervention only and within the limits of Client's instructions, if any. The Company's sole responsibility is to its Client and this document does not exonerate parties to a transaction from exercising all their rights and obligations under the transaction documents. This document cannot be reproduced except in full, without prior written approval of the Company. Any unauthorized alteration, forgery or falsification of the content or appearance of this document is unlawful and offenders may be prosecuted to the fullest extent of the law.

256QAM_B66(1748.1+1757.4)

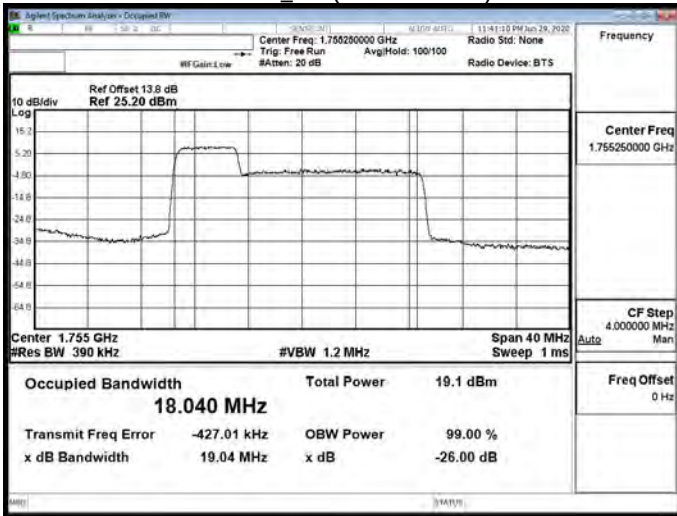

256QAM_B66(1767.7+1777)

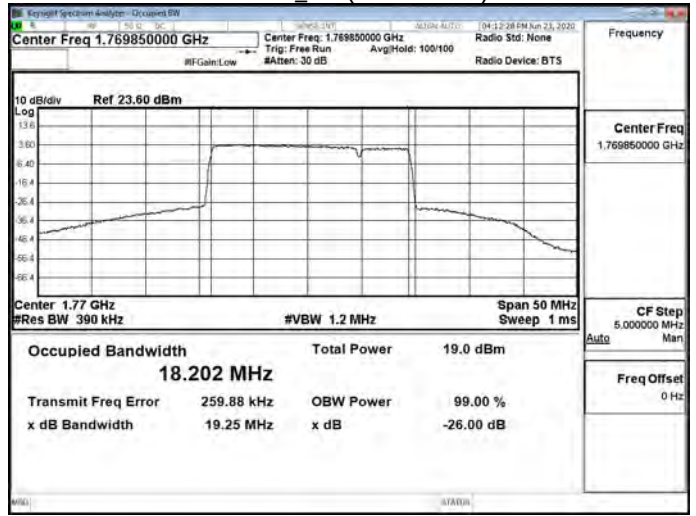

256QAM_B66(1752.6+1757.4)

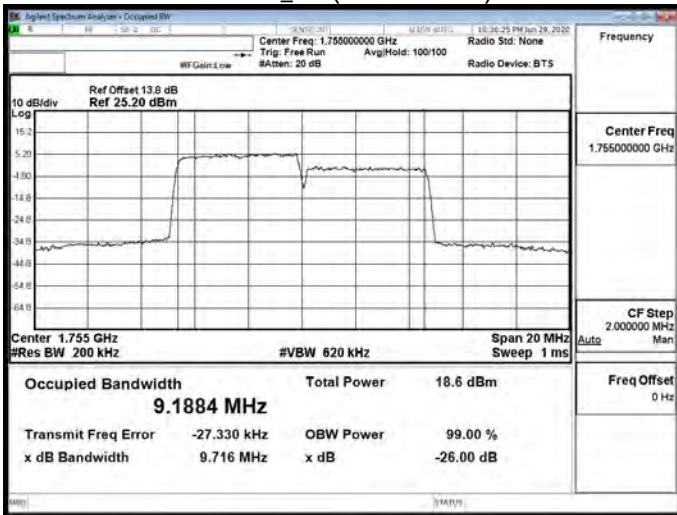

QPSK_B66C(1720+1731.7)

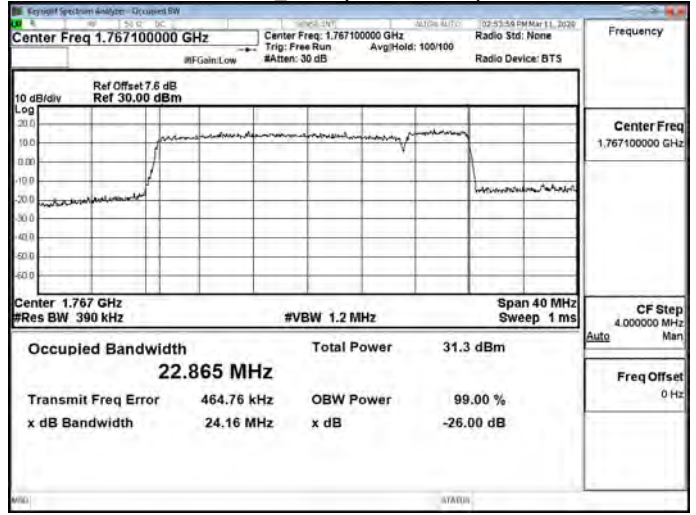

256QAM_B66(1752.6+1761.9)

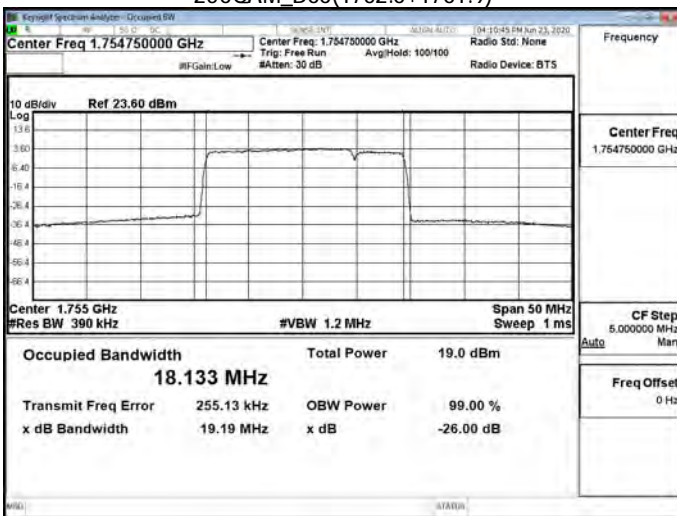

QPSK_B66C(1745.1+1764.9)

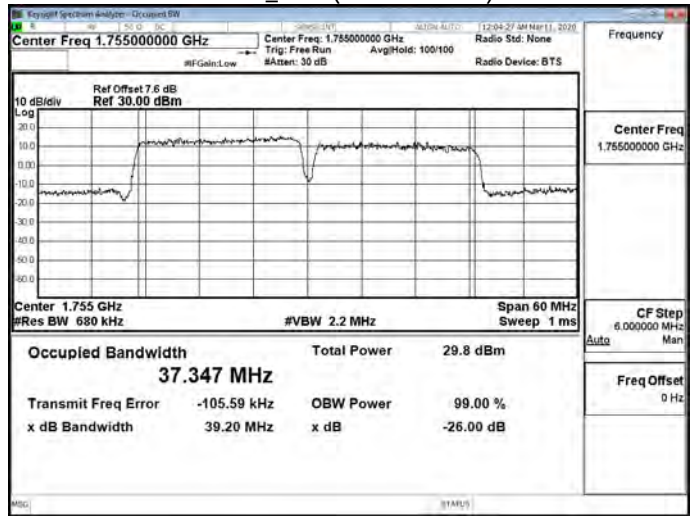

Unless otherwise stated the results shown in this test report refer only to the sample(s) tested and such sample(s) are retained for 90 days only.

除非另有說明，此報告結果僅對測試之樣品負責，同時此樣品僅保留90天。本報告未經本公司書面許可，不可部份複製。

This document is issued by the Company subject to its General Conditions of Service printed overleaf, available on request or accessible at <http://www.sgs.com.tw/Terms-and-Conditions> and for electronic format documents, subject to Terms and Conditions for Electronic Documents at <http://www.sgs.com.tw/Terms-and-Conditions>. Attention is drawn to the limitation of liability, indemnification and jurisdiction issues defined therein. Any holder of this document is advised that information contained hereon reflects the Company's findings at the time of its intervention only and within the limits of Client's instructions, if any. The Company's sole responsibility is to its Client and this document does not exonerate parties to a transaction from exercising all their rights and obligations under the transaction documents. This document cannot be reproduced except in full, without prior written approval of the Company. Any unauthorized alteration, forgery or falsification of the content or appearance of this document is unlawful and offenders may be prosecuted to the fullest extent of the law.

QPSK_B66C(1745.8+1757.5)

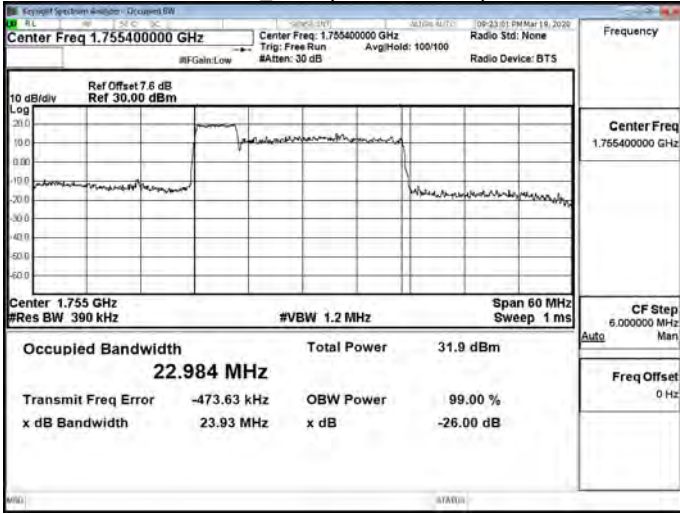

16QAM_B66C(1745.1+1764.9)

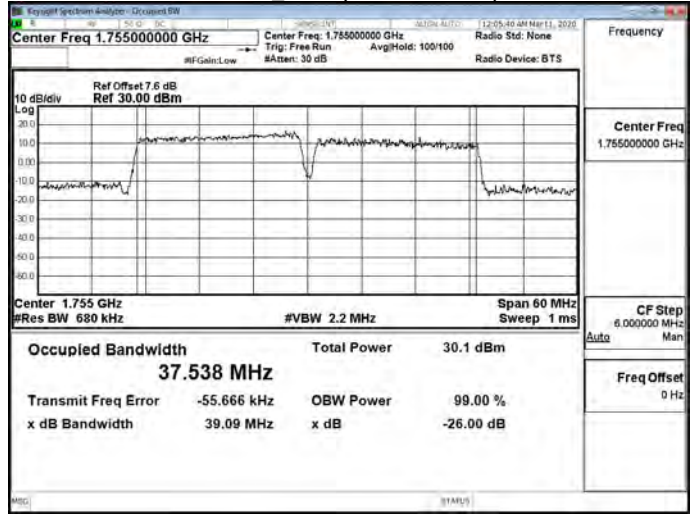

QPSK_B66C(1752.5+1764.2)

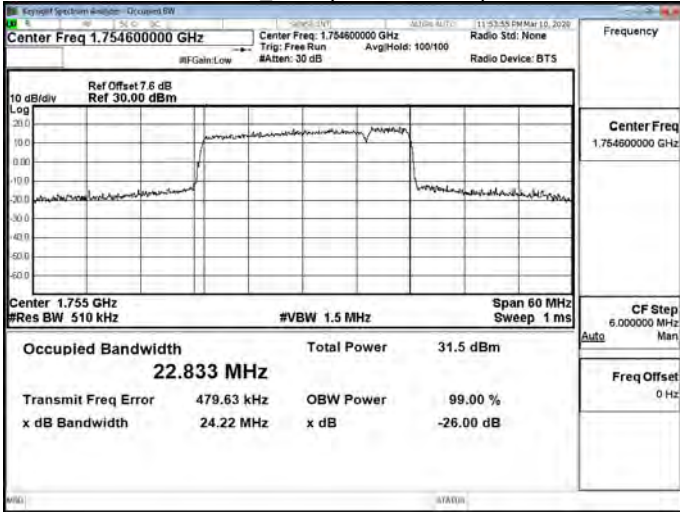

16QAM_B66C(1745.8+1757.5)

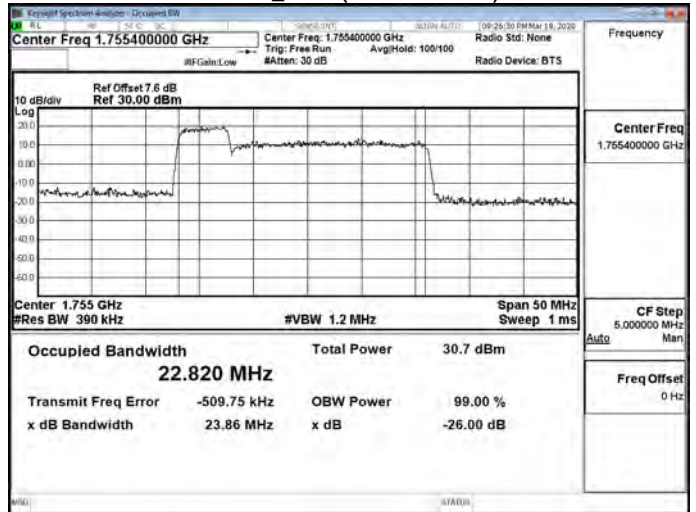

QPSK_B66C(1765+1776.7)

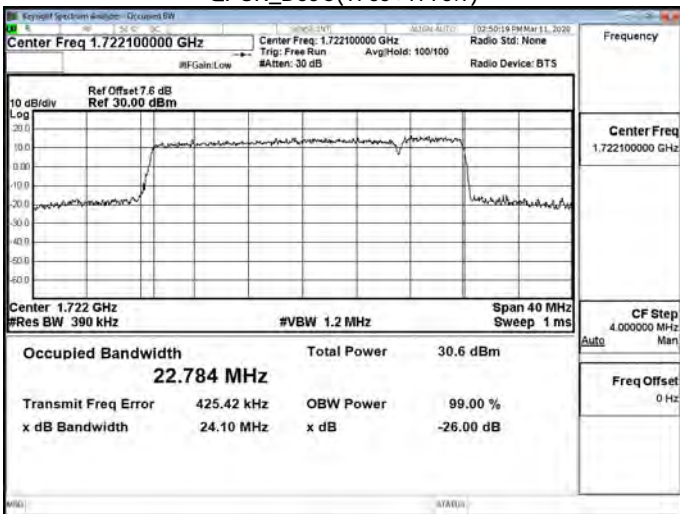

16QAM_B66C(1752.5+1764.2)

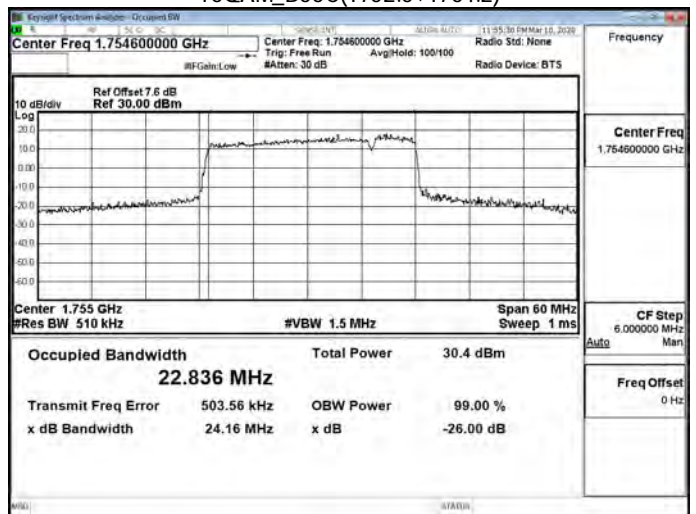

Unless otherwise stated the results shown in this test report refer only to the sample(s) tested and such sample(s) are retained for 90 days only.

除非另有說明，此報告結果僅對測試之樣品負責。同時此樣品僅保留90天。本報告未經本公司書面許可，不可部份複製。

This document is issued by the Company subject to its General Conditions of Service printed overleaf, available on request or accessible at <http://www.sgs.com.tw/Terms-and-Conditions> and for electronic format documents, subject to Terms and Conditions for Electronic Documents at <http://www.sgs.com.tw/Terms-and-Conditions>. Attention is drawn to the limitation of liability, indemnification and jurisdiction issues defined therein. Any holder of this document is advised that information contained hereon reflects the Company's findings at the time of its intervention only and within the limits of Client's instructions, if any. The Company's sole responsibility is to its Client and this document does not exonerate parties to a transaction from exercising all their rights and obligations under the transaction documents. This document cannot be reproduced except in full, without prior written approval of the Company. Any unauthorized alteration, forgery or falsification of the content or appearance of this document is unlawful and offenders may be prosecuted to the fullest extent of the law.

64QAM_B66C(1745.1+1764.9)

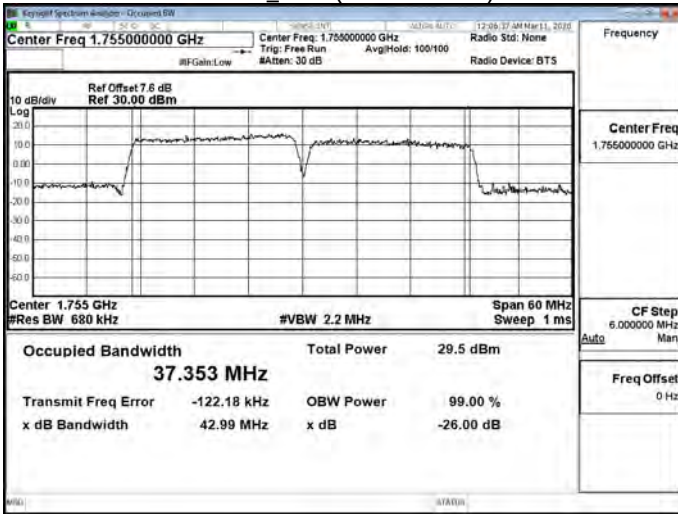

256QAM_B66(1720+1731.7)

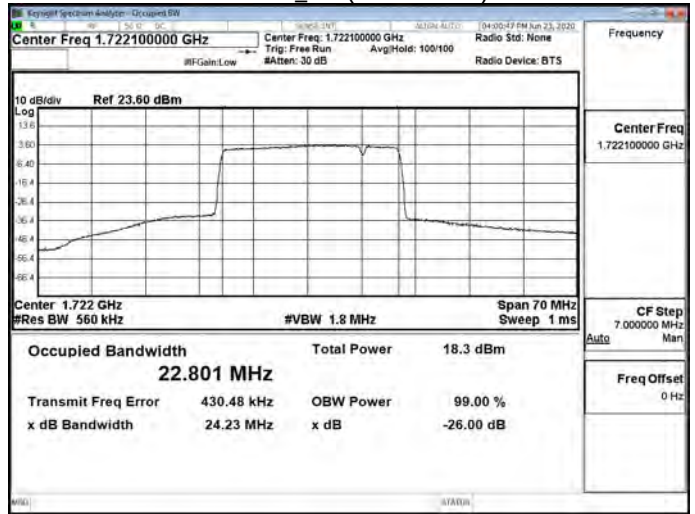

64QAM_B66C(1745.8+1757.5)

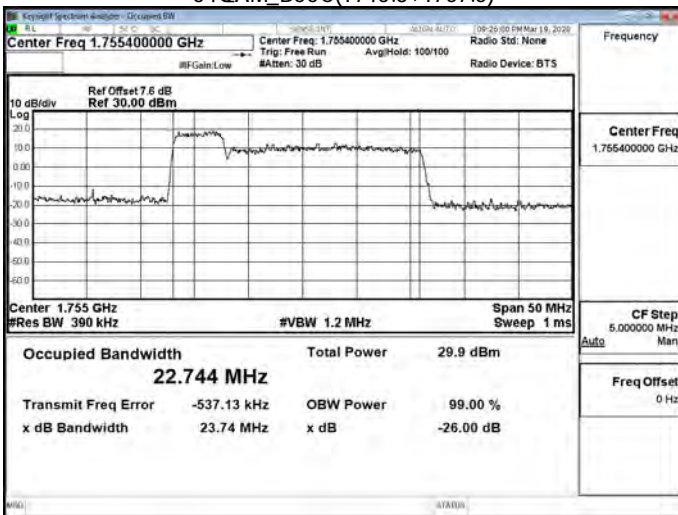

256QAM_B66(1745.1+1764.9)

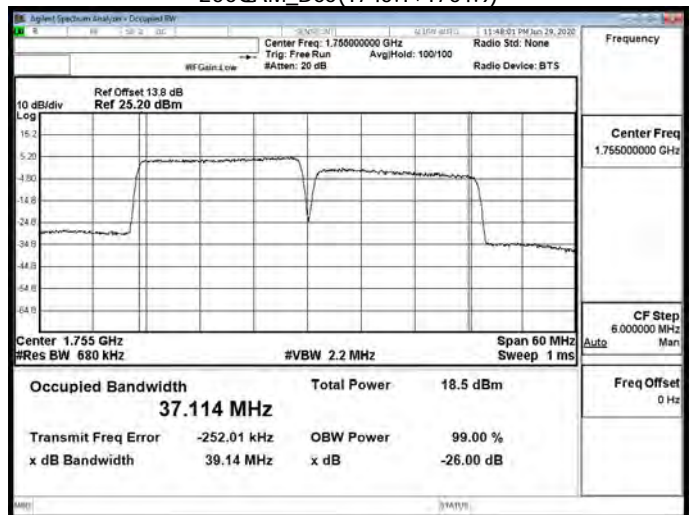

64QAM_B66C(1752.5+1764.2)

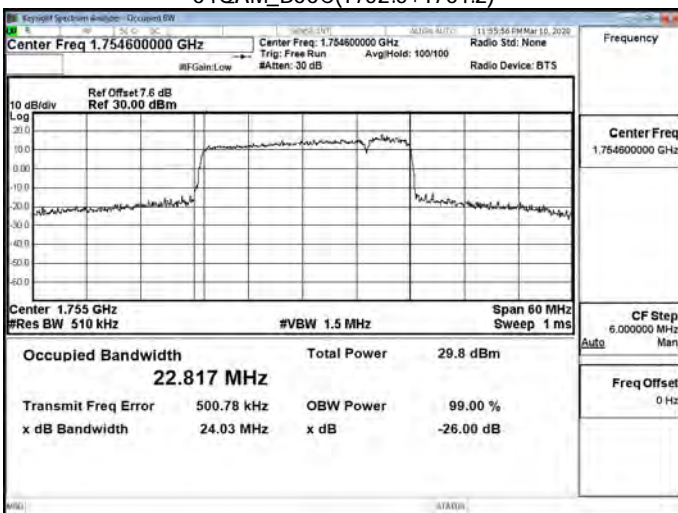

256QAM_B66(1745.8+1757.5)

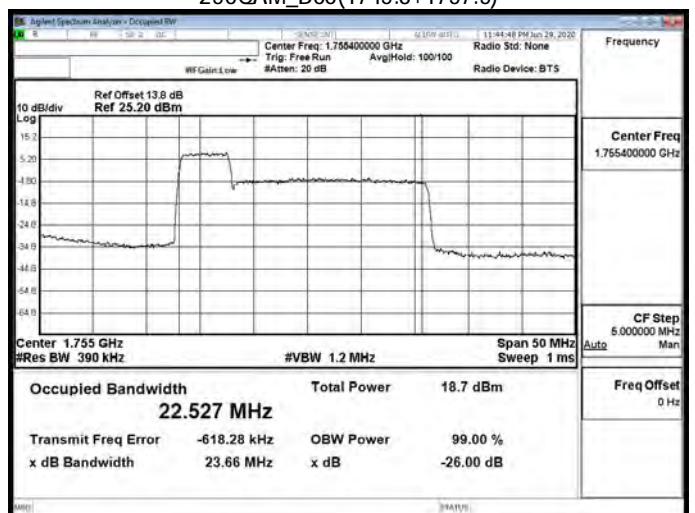

Unless otherwise stated the results shown in this test report refer only to the sample(s) tested and such sample(s) are retained for 90 days only.

除非另有說明，此報告結果僅對測試之樣品負責。同時此樣品僅保留90天。本報告未經本公司書面許可，不可部份複製。

This document is issued by the Company subject to its General Conditions of Service printed overleaf, available on request or accessible at <http://www.sgs.com.tw/Terms-and-Conditions> and for electronic format documents, subject to Terms and Conditions for Electronic Documents at <http://www.sgs.com.tw/Terms-and-Conditions>. Attention is drawn to the limitation of liability, indemnification and jurisdiction issues defined therein. Any holder of this document is advised that information contained herein reflects the Company's findings at the time of its intervention only and within the limits of Client's instructions, if any. The Company's sole responsibility is to its Client and this document does not exonerate parties to a transaction from exercising all their rights and obligations under the transaction documents. This document cannot be reproduced except in full, without prior written approval of the Company. Any unauthorized alteration, forgery or falsification of the content or appearance of this document is unlawful and offenders may be prosecuted to the fullest extent of the law.

256QAM_B66(1752.5+1764.2)

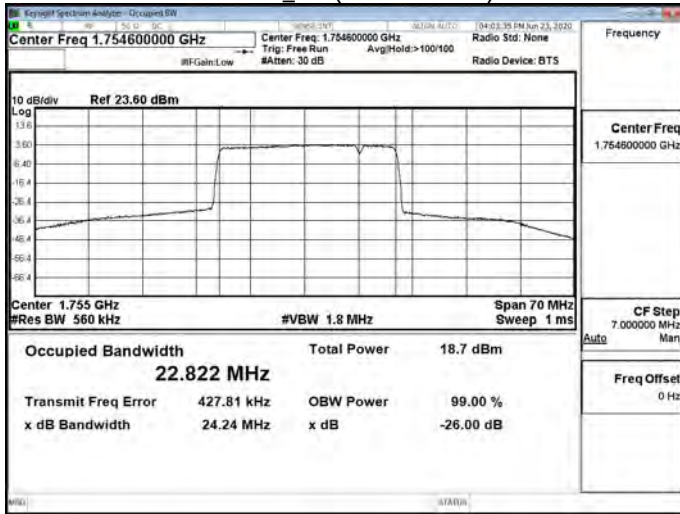

256QAM_B66(1765+1776.7)

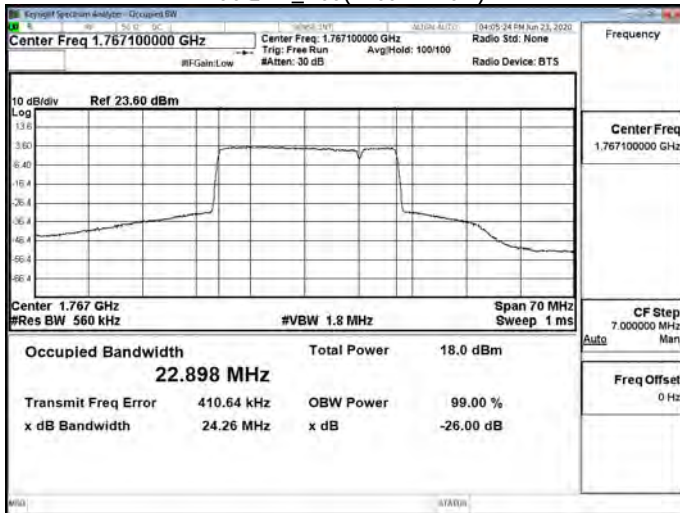

Unless otherwise stated the results shown in this test report refer only to the sample(s) tested and such sample(s) are retained for 90 days only.

除非另有說明，此報告結果僅對測試之樣品負責，同時此樣品僅保留90天。本報告未經本公司書面許可，不可部份複製。

This document is issued by the Company subject to its General Conditions of Service printed overleaf, available on request or accessible at <http://www.sgs.com.tw/Terms-and-Conditions> and for electronic format documents, subject to Terms and Conditions for Electronic Documents at <http://www.sgs.com.tw/Terms-and-Conditions>. Attention is drawn to the limitation of liability, indemnification and jurisdiction issues defined therein. Any holder of this document is advised that information contained hereon reflects the Company's findings at the time of its intervention only and within the limits of Client's instructions, if any. The Company's sole responsibility is to its Client and this document does not exonerate parties to a transaction from exercising all their rights and obligations under the transaction documents. This document cannot be reproduced except in full, without prior written approval of the Company. Any unauthorized alteration, forgery or falsification of the content or appearance of this document is unlawful and offenders may be prosecuted to the fullest extent of the law.

8 OUT OF BAND EMISSION AT ANTENNA TERMINALS

8.1 Standard Applicable

FCC §22.917(a), §24.238(a), §27.53(h)

Out of band emissions. The power of any emission outside of the authorized operating frequency ranges must be attenuated below the transmitting power (P) by a factor of at least $43 + 10 \log(P)$ dB.

FCC §27.53(c) for LTE B13

For operations in the 746–758 MHz band and the 776–788 MHz band, the power of any emission outside the licensee's frequency band(s) of operation shall be attenuated below the transmitter power (P) within the licensed band(s) of operation, measured in watts, in accordance with the following:

(2) On any frequency outside the 776–788 MHz band, the power of any emission shall be attenuated outside the band below the transmitter power (P) by at least $43 + 10 \log(P)$ dB (-13dBm)

(4) On all frequencies between 763-775 MHz and 793-805 MHz, by a factor not less than $65 + 10 \log(P)$ dB in a 6.25 kHz band segment, for mobile and portable stations;

FCC §27.53(g) for LTE B12, 13

Compliance for operations in the 600 MHz, 698-746 MHz, 746-758 MHz and the 776-788 MHz band with this provision is based on the use of measurement instrumentation employing a resolution bandwidth of 100 kilohertz or greater. However, in the 100 kilohertz bands immediately outside and adjacent to a licensee's frequency block, a resolution bandwidth of at least 30 kHz may be employed.

FCC §27.53(h)(3) for LTE B4, 66

Compliance with this provision is based on the use of measurement instrumentation employing a resolution bandwidth of 1 megahertz or greater. However, in the 1 megahertz bands immediately outside and adjacent to the licensee's frequency block, a resolution bandwidth of at least one percent of the emission bandwidth of the fundamental emission of the transmitter may be employed. The emission bandwidth is defined as the width of the signal between two points, one below the carrier center frequency and one above the carrier center frequency, outside of which all emissions are attenuated at least 26 dB below the transmitter power.

FCC §27.53(m) (4) (6) for LTE B7, B41

For mobile digital stations, the attenuation factor shall be not less than $40 + 10 \log(P)$ dB on all frequencies between the channel edge and 5 megahertz from the channel edge, $43 + 10 \log(P)$ dB on all frequencies between 5 megahertz and X megahertz from the channel edge, and $55 + 10 \log(P)$ dB on all frequencies more than X megahertz from the channel edge, where X is the greater of 6 megahertz or the actual emission bandwidth as defined in paragraph (m)(6) of this section. In addition, the attenuation factor shall not be less than $43 + 10 \log(P)$ dB on all frequencies between 2490.5 MHz and 2496 MHz and $55 + 10 \log(P)$ dB at or below 2490.5 MHz. Mobile Satellite Service licensees operating on frequencies below 2495 MHz may also submit a documented interference complaint against BRS licensees operating on channel BRS Channel 1 on the same terms and conditions as adjacent channel BRS or EBS licensees.

Measurement procedure. Compliance with these rules is based on the use of measurement instrumentation employing a resolution bandwidth of 1 megahertz or greater. However, in the 1 MHz bands immediately outside and adjacent to the frequency block a resolution bandwidth of at least one percent of the emission bandwidth of the fundamental emission of the transmitter may be employed; for mobile digital stations, in the 1 megahertz bands immediately outside and adjacent to the frequency block a resolution bandwidth of at least two percent may be employed, except when the 1 megahertz band is 2495-2496 MHz, in which case a resolution bandwidth of at least one percent may be employed. A narrower resolution bandwidth is permitted in all cases to improve measurement accuracy provided the measured power is integrated over the full required measurement bandwidth (i.e. 1 megahertz or 1 percent of emission bandwidth, as specified; or 1 megahertz or 2 percent for mobile digital stations, except in the band 2495-2496 MHz). The emission bandwidth is defined as the width of the signal between two points, one below the carrier center frequency

Unless otherwise stated the results shown in this test report refer only to the sample(s) tested and such sample(s) are retained for 90 days only.

除非另有說明，此報告結果僅對測試之樣品負責，同時此樣品僅保留90天。本報告未經本公司書面許可，不可部份複製。

This document is issued by the Company subject to its General Conditions of Service printed overleaf, available on request or accessible at <http://www.sgs.com.tw/Terms-and-Conditions> and for electronic format documents, subject to Terms and Conditions for Electronic Documents at <http://www.sgs.com.tw/Terms-and-Conditions>. Attention is drawn to the limitation of liability, indemnification and jurisdiction issues defined therein. Any holder of this document is advised that information contained herein reflects the Company's findings at the time of its intervention only and within the limits of Client's instructions, if any. The Company's sole responsibility is to its Client and this document does not exonerate parties to a transaction from exercising all their rights and obligations under the transaction documents. This document cannot be reproduced except in full, without prior written approval of the Company. Any unauthorized alteration, forgery or falsification of the content or appearance of this document is unlawful and offenders may be prosecuted to the fullest extent of the law.

and one above the carrier center frequency, outside of which all emissions are attenuated at least 26 dB below the transmitter power. With respect to television operations, measurements must be made of the separate visual and aural operating powers at sufficiently frequent intervals to ensure compliance with the rules.

FCC §96.41 , C63.26 Clause 5.7.

For channel and frequency assignments made by the SAS to CBSDs, the conducted power of any CBSD emission outside the fundamental emission bandwidth as specified in paragraph (e)(3) of this section (whether the emission is inside or outside of the authorized band) shall not exceed -13 dBm/MHz within 0-10 megahertz above the upper SAS-assigned channel edge and within 0-10 megahertz below the lower SAS-assigned channel edge. At all frequencies greater than 10 megahertz above the upper SAS assigned channel edge and less than 10 MHz below the lower SAS assigned channel edge, the conducted power of any CBSD emission shall not exceed -25 dBm/MHz. The upper and lower SAS assigned channel edges are the upper and lower limits of any channel assigned to a CBSD by an SAS, or in the case of multiple contiguous channels, the upper and lower limits of the combined contiguous channels.

For CBSDs and End User Devices, the conducted power of emissions below 3540 MHz or above 3710 MHz shall not exceed -25 dBm/MHz, and the conducted power of emissions below 3530 MHz or above 3720 MHz shall not exceed -40dBm/MHz.

8.2 Test SET-UP

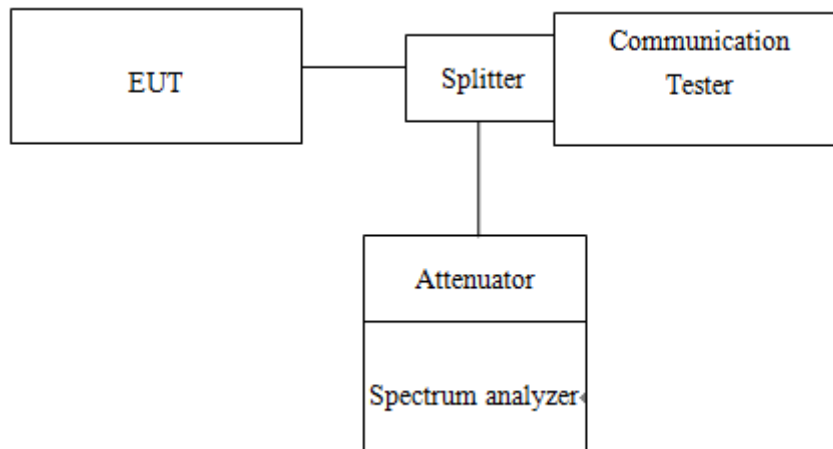

Unless otherwise stated the results shown in this test report refer only to the sample(s) tested and such sample(s) are retained for 90 days only.

除非另有說明，此報告結果僅對測試之樣品負責，同時此樣品僅保留90天。本報告未經本公司書面許可，不可部份複製。

This document is issued by the Company subject to its General Conditions of Service printed overleaf, available on request or accessible at <http://www.sgs.com.tw/Terms-and-Conditions> and for electronic format documents, subject to Terms and Conditions for Electronic Documents at <http://www.sgs.com.tw/Terms-and-Conditions>. Attention is drawn to the limitation of liability, indemnification and jurisdiction issues defined therein. Any holder of this document is advised that information contained hereon reflects the Company's findings at the time of its intervention only and within the limits of Client's instructions, if any. The Company's sole responsibility is to its Client and this document does not exonerate parties to a transaction from exercising all their rights and obligations under the transaction documents. This document cannot be reproduced except in full, without prior written approval of the Company. Any unauthorized alteration, forgery or falsification of the content or appearance of this document is unlawful and offenders may be prosecuted to the fullest extent of the law.

8.3 Measurement Procedure

8.3.1 Conducted Emission

The RF output of the transceiver was connected to a spectrum analyzer through appropriate attenuation. The resolution bandwidth of the spectrum analyzer was set at 1MHz, sufficient scans were taken to show the out of band Emissions if any up to 10th harmonic.

1. To connect Antenna Port of EUT to Spectrum.
2. Set RBW = 1MHz & VBW = 1MHz on Spectrum.
3. Allow trace to fully stabilize
4. Repeat above procedures until all default test channel measured were complete.

8.3.2 Band Edge

1. To connect Antenna Port of EUT to Spectrum.
2. The band edge of low and high channels for the highest RF powers was measured. Setting RBW \geq 1% EBW.
3. Allow trace to fully stabilize
4. Repeat above procedures until all default test channel measured were complete.

8.4 Measurement Equipment Used

Conducted Emission (measured at antenna port) Test Site					
EQUIPMENT TYPE	MFR	MODEL NUMBER	SERIAL NUMBER	LAST CAL.	CAL DUE.
Spectrum Analyzer	KEYSIGHT	N9010A	MY51440113	07/15/2019	07/14/2020
Radio Communication Analyer	Anritsu	MT8821C	6261786084	01/18/2020	01/17/2021
Attenuator	Marvelous	MVE2213-10	RF30	11/20/2019	11/19/2020
DC Block	PASTERNAK	PE8210	RF32	11/20/2019	11/19/2020
Splitter	Woken	DOM35LW1 A2	RF83	11/20/2019	11/19/2020
Coaxial Cables	Woken	00100A1F1A 185C	RF229	11/20/2019	11/19/2020

8.5 Measurement Result:

Refer to next pages.

Note:

Mask measurements of B41C is used for demonstrating the compliance of both B41C and B7C due to the B41C operates in frequency 2498.8~2687.5 MHz can fully cover the B7C which is operating in 2502.5~2567.5MHz

Unless otherwise stated the results shown in this test report refer only to the sample(s) tested and such sample(s) are retained for 90 days only.

除非另有說明，此報告結果僅對測試之樣品負責，同時此樣品僅保留90天。本報告未經本公司書面許可，不可部份複製。

This document is issued by the Company subject to its General Conditions of Service printed overleaf, available on request or accessible at <http://www.sgs.com.tw/Terms-and-Conditions> and for electronic format documents, subject to Terms and Conditions for Electronic Documents at <http://www.sgs.com.tw/Terms-and-Conditions>. Attention is drawn to the limitation of liability, indemnification and jurisdiction issues defined therein. Any holder of this document is advised that information contained hereon reflects the Company's findings at the time of its intervention only and within the limits of Client's instructions, if any. The Company's sole responsibility is to its Client and this document does not exonerate parties to a transaction from exercising all their rights and obligations under the transaction documents. This document cannot be reproduced except in full, without prior written approval of the Company. Any unauthorized alteration, forgery or falsification of the content or appearance of this document is unlawful and offenders may be prosecuted to the fullest extent of the law.

Emission_B5B_30MHz-3GHz_Low_CH

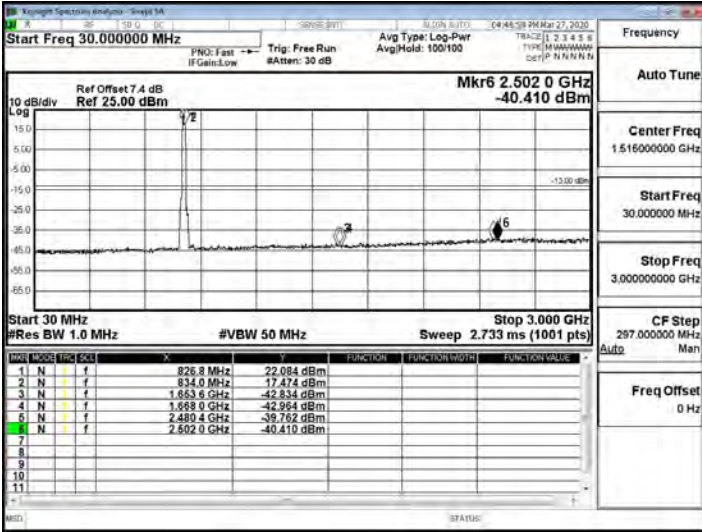

Emission_B5B_3GHz-26GHz_Low_CH

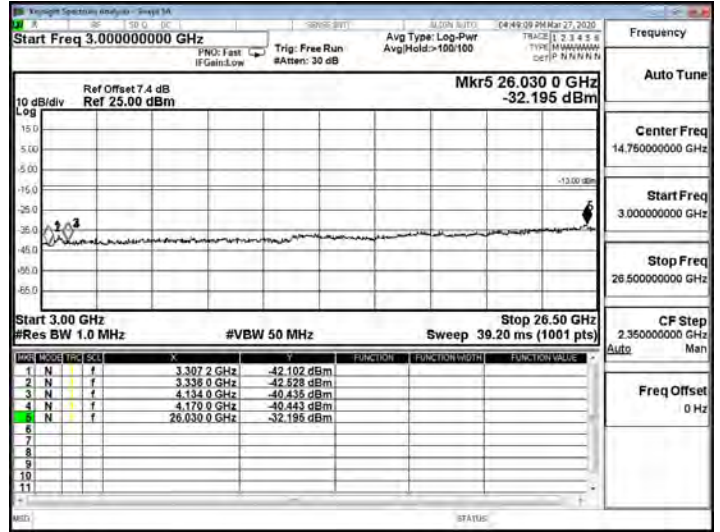

Emission_B5B_30MHz-3GHz_Mid_CH

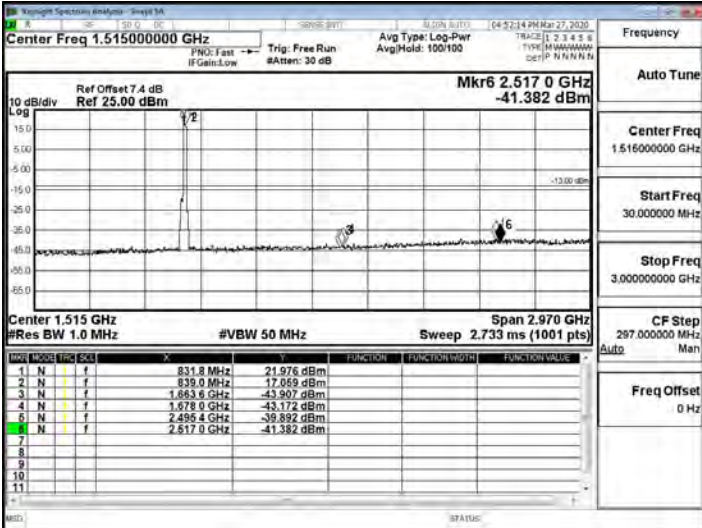

Emission_B5B_3GHz-26GHz_Mid_CH

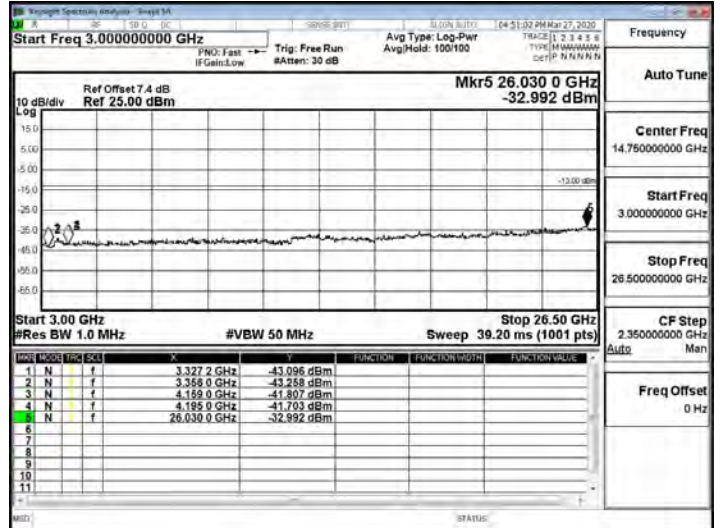

Emission_B5B_30MHz-3GHz_High_CH

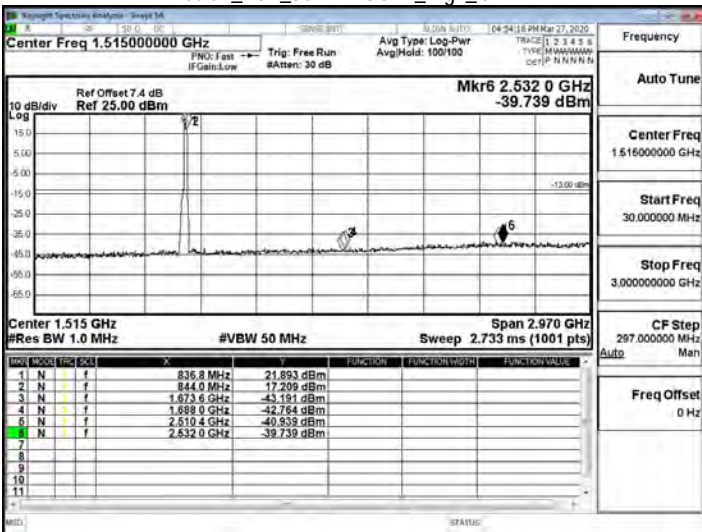

Emission_B5B_3GHz-26GHz_High_CH

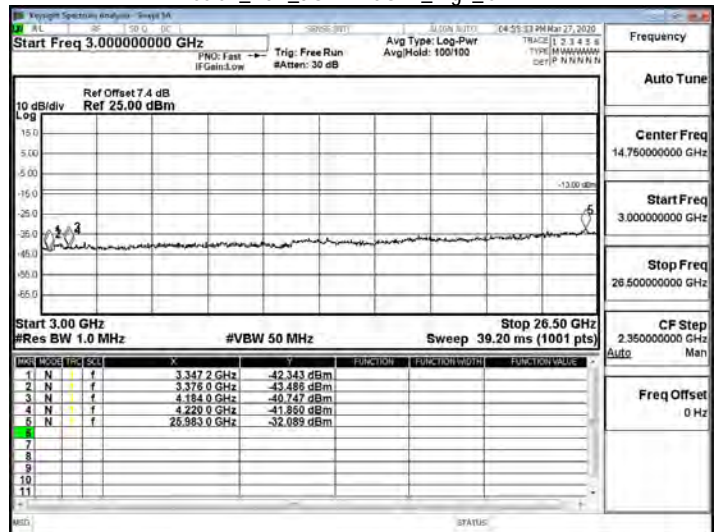

Unless otherwise stated the results shown in this test report refer only to the sample(s) tested and such sample(s) are retained for 90 days only.

除非另有說明，此報告結果僅對測試之樣品負責，同時此樣品僅保留90天。本報告未經本公司書面許可，不可部份複製。

This document is issued by the Company subject to its General Conditions of Service printed overleaf, available on request or accessible at <http://www.sgs.com.tw/Terms-and-Conditions> and for electronic format documents, subject to Terms and Conditions for Electronic Documents at <http://www.sgs.com.tw/Terms-and-Conditions>. Attention is drawn to the limitation of liability, indemnification and jurisdiction issues defined therein. Any holder of this document is advised that information contained hereon reflects the Company's findings at the time of its intervention only and within the limits of Client's instructions, if any. The Company's sole responsibility is to its Client and this document does not exonerate parties to a transaction from exercising all their rights and obligations under the transaction documents. This document cannot be reproduced except in full, without prior written approval of the Company. Any unauthorized alteration, forgery or falsification of the content or appearance of this document is unlawful and offenders may be prosecuted to the fullest extent of the law.

Emission_B7C_30MHz-3GHz_Low_CH

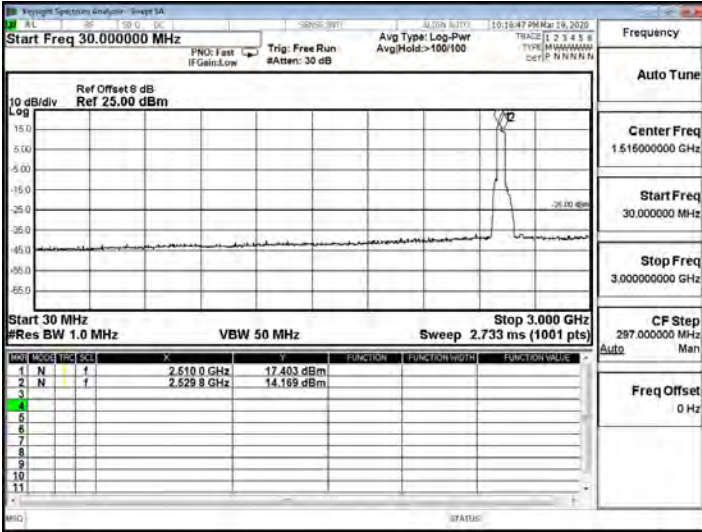

Emission_B7C_3GHz-26GHz_Low_CH

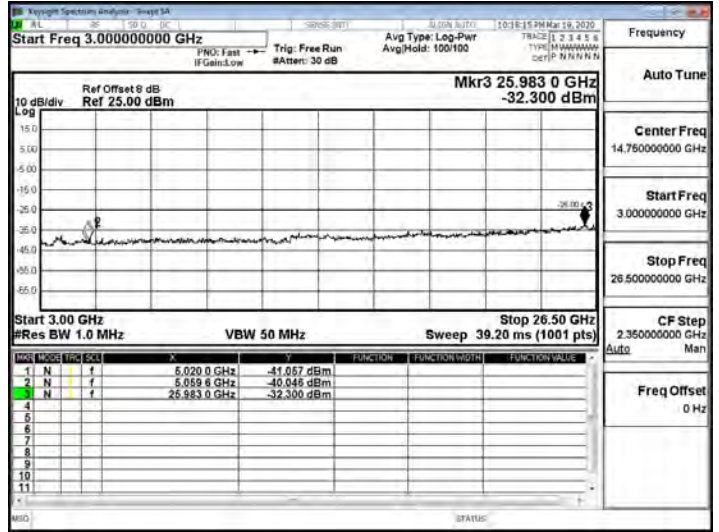

Emission_B7C_30MHz-3GHz_Mid_CH

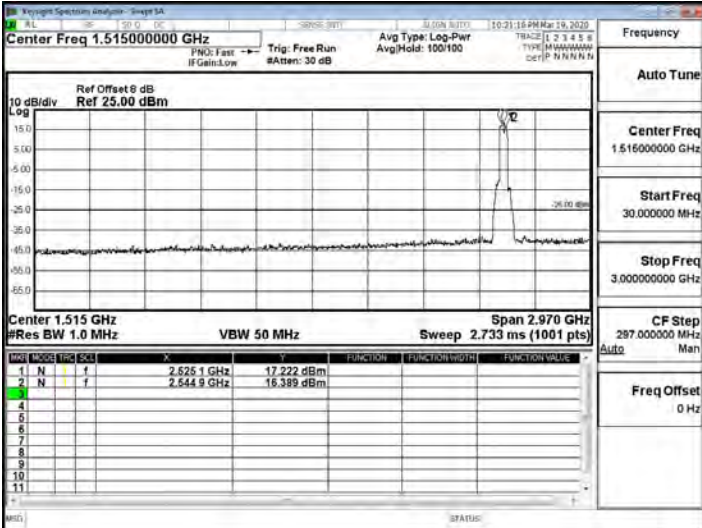

Emission_B7C_3GHz-26GHz_Mid_CH

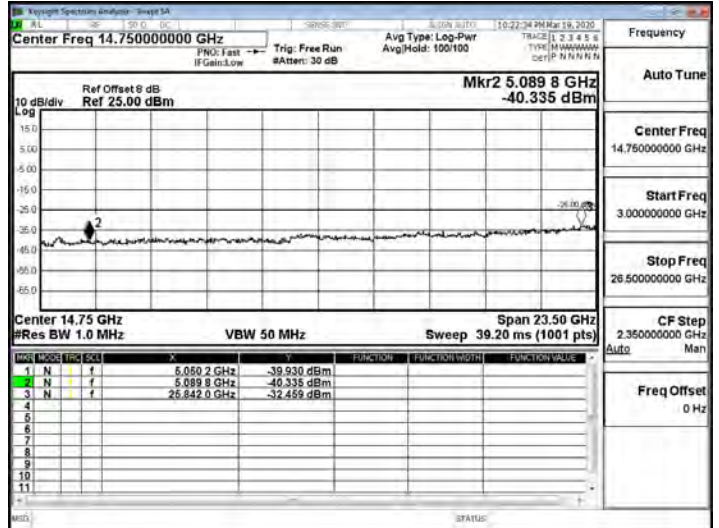

Emission_B7C_30MHz-3GHz_High_CH

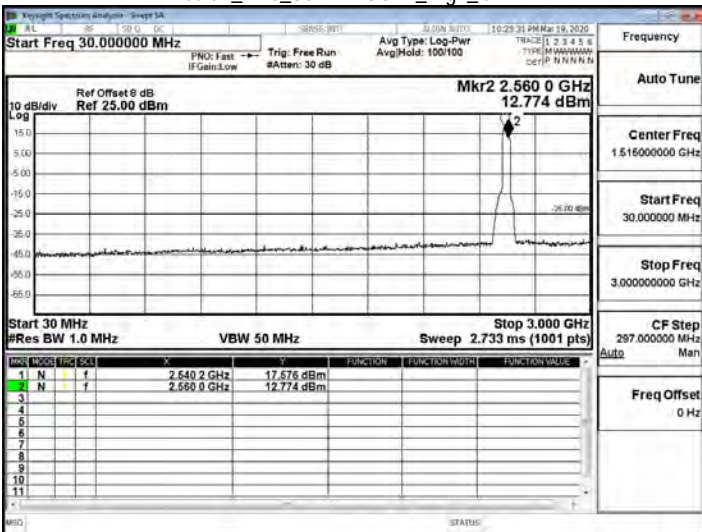

Emission_B7C_3GHz-26GHz_High_CH

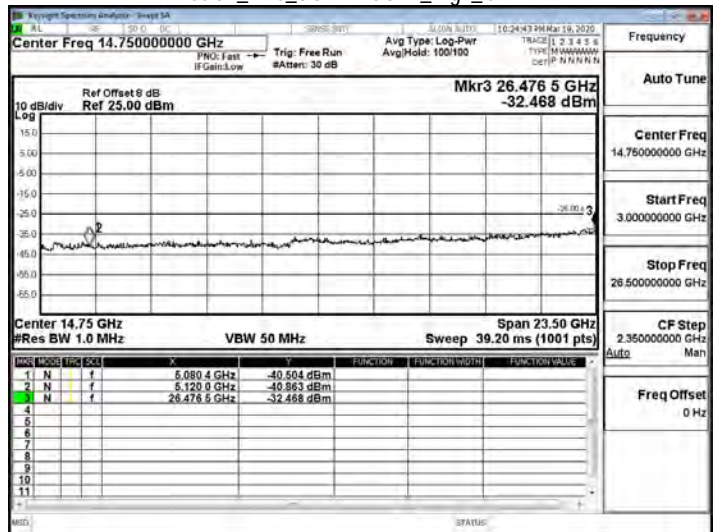

Unless otherwise stated the results shown in this test report refer only to the sample(s) tested and such sample(s) are retained for 90 days only.

除非另有說明，此報告結果僅對測試之樣品負責，同時此樣品僅保留90天。本報告未經本公司書面許可，不可部份複製。

This document is issued by the Company subject to its General Conditions of Service printed overleaf, available on request or accessible at <http://www.sgs.com.tw/Terms-and-Conditions> and for electronic format documents, subject to Terms and Conditions for Electronic Documents at <http://www.sgs.com.tw/Terms-and-Conditions>. Attention is drawn to the limitation of liability, indemnification and jurisdiction issues defined therein. Any holder of this document is advised that information contained hereon reflects the Company's findings at the time of its intervention only and within the limits of Client's instructions, if any. The Company's sole responsibility is to its Client and this document does not exonerate parties to a transaction from exercising all their rights and obligations under the transaction documents. This document cannot be reproduced except in full, without prior written approval of the Company. Any unauthorized alteration, forgery or falsification of the content or appearance of this document is unlawful and offenders may be prosecuted to the fullest extent of the law.

Emission_B41C_30MHz-3GHz_Low_CH

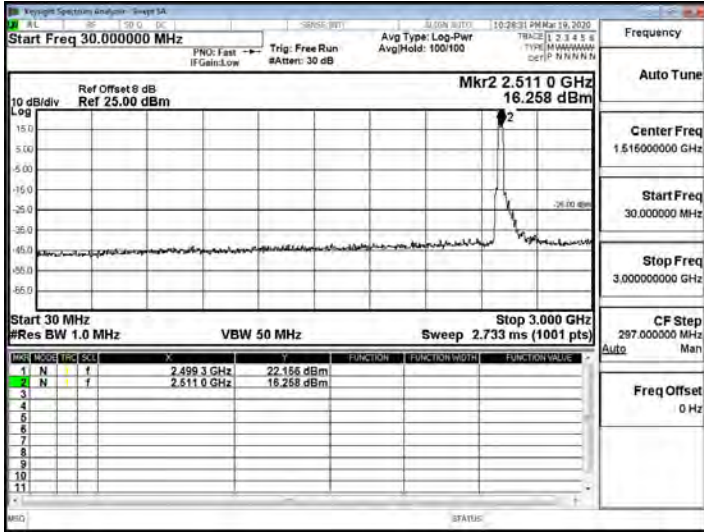

Emission_B41C_3GHz-26GHz_Low_CH

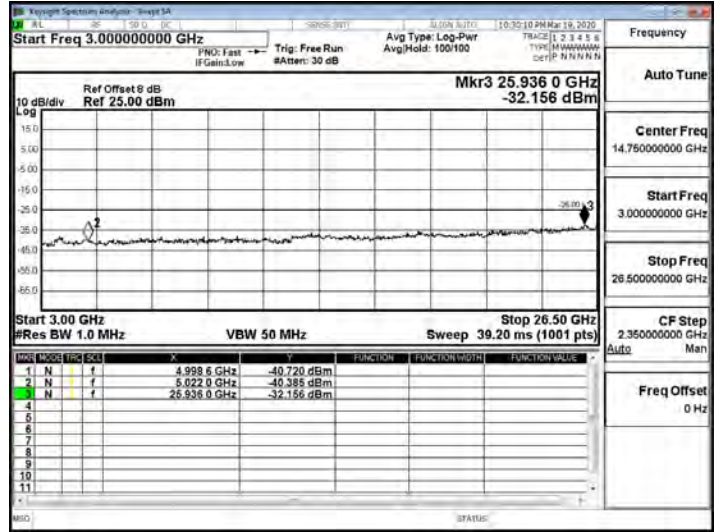

Emission_B41C_30MHz-3GHz_Mid_CH

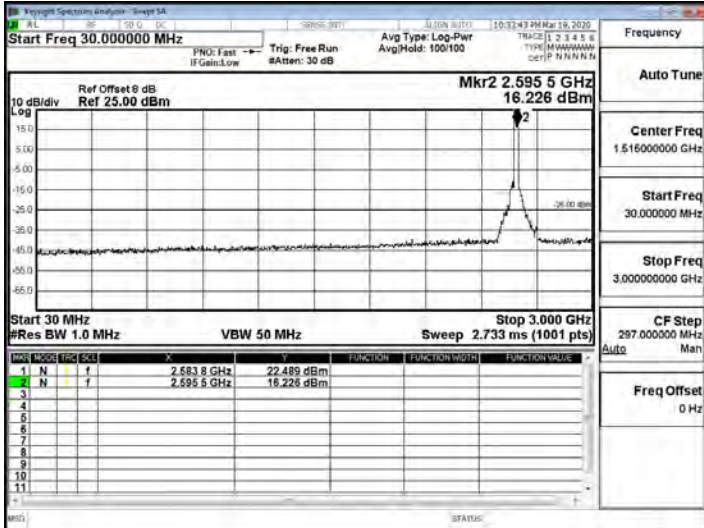

Emission_B41C_3GHz-26GHz_Mid_CH

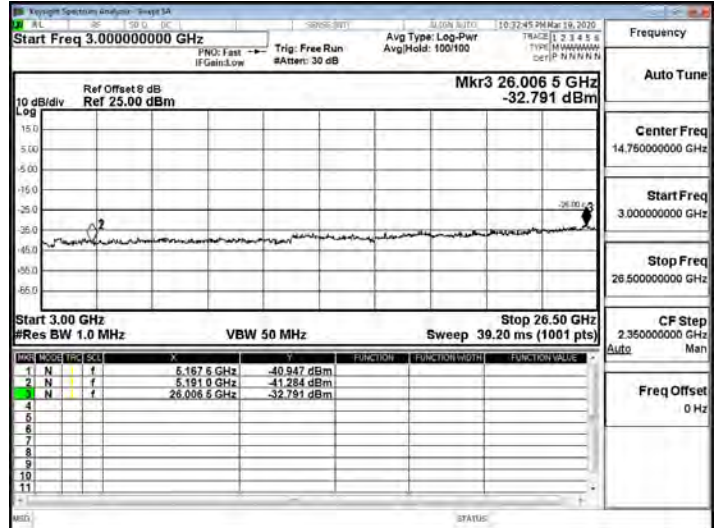

Emission_B41C_30MHz-3GHz_High_CH

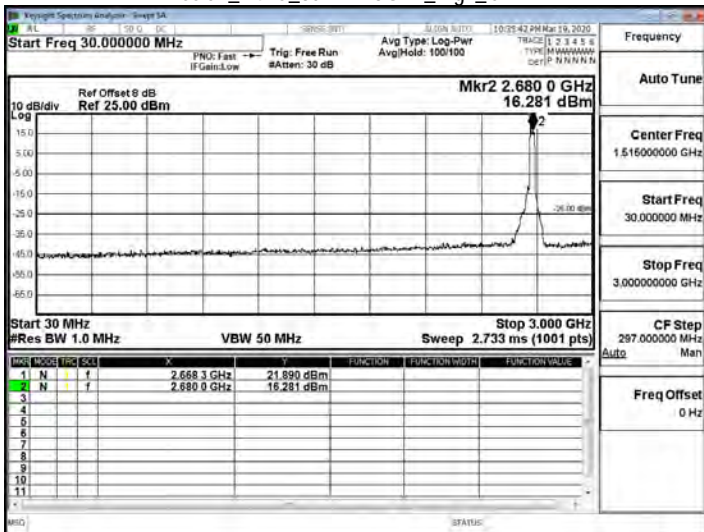

Emission_B41C_3GHz-26GHz_High_CH

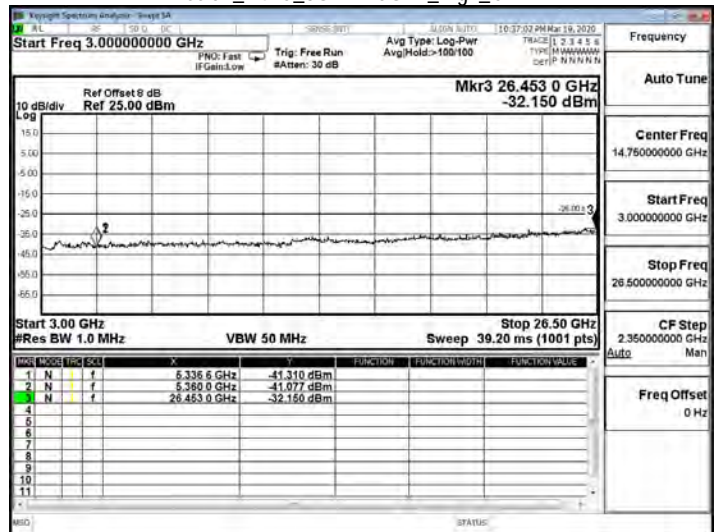

Unless otherwise stated the results shown in this test report refer only to the sample(s) tested and such sample(s) are retained for 90 days only.

除非另有說明，此報告結果僅對測試之樣品負責，同時此樣品僅保留90天。本報告未經本公司書面許可，不可部份複製。

This document is issued by the Company subject to its General Conditions of Service printed overleaf, available on request or accessible at <http://www.sgs.com.tw/Terms-and-Conditions>, and for electronic format documents, subject to Terms and Conditions for Electronic Documents at <http://www.sgs.com.tw/Terms-and-Conditions>. Attention is drawn to the limitation of liability, indemnification and jurisdiction issues defined therein. Any holder of this document is advised that information contained hereon reflects the Company's findings at the time of its intervention only and within the limits of Client's instructions, if any. The Company's sole responsibility is to its Client and this document does not exonerate parties to a transaction from exercising all their rights and obligations under the transaction documents. This document cannot be reproduced except in full, without prior written approval of the Company. Any unauthorized alteration, forgery or falsification of the content or appearance of this document is unlawful and offenders may be prosecuted to the fullest extent of the law.

Emission_B48C_30MHz-3GHz_Low_CH

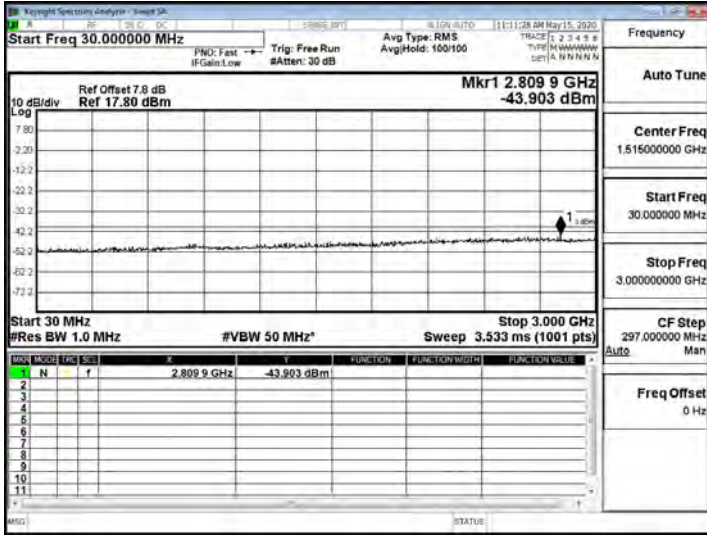

Emission_B48C_3GHz-26GHz_Low_CH

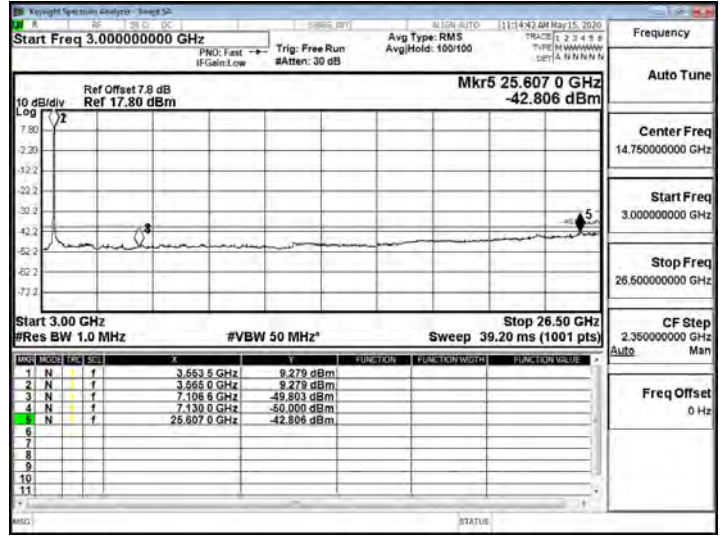

Emission_B48C_30MHz-3GHz_Mid_CH

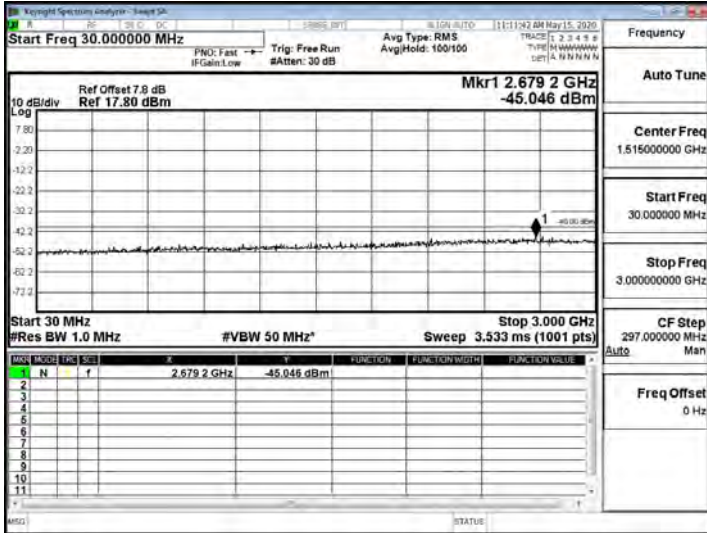

Emission_B48C_3GHz-26GHz_Mid_CH

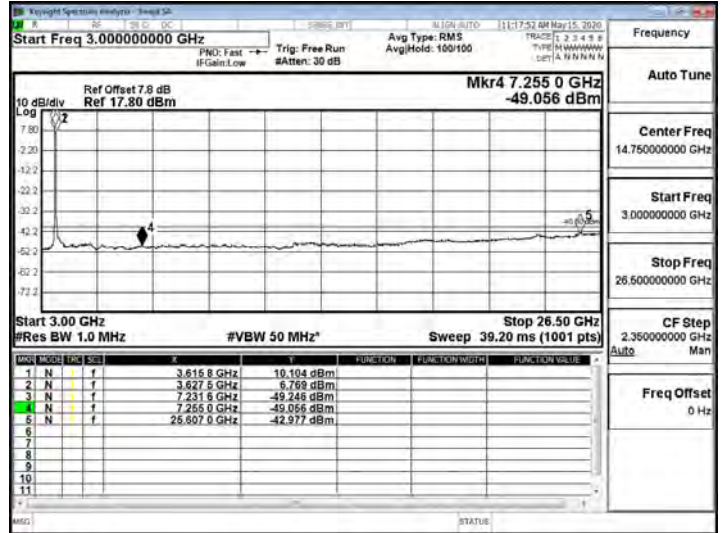

Emission_B48C_30MHz-3GHz_High_CH

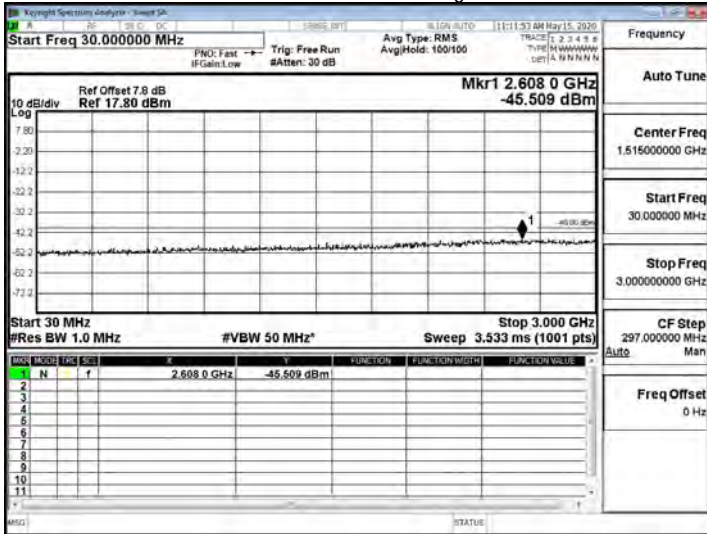

Emission_B48C_3GHz-26GHz_High_CH

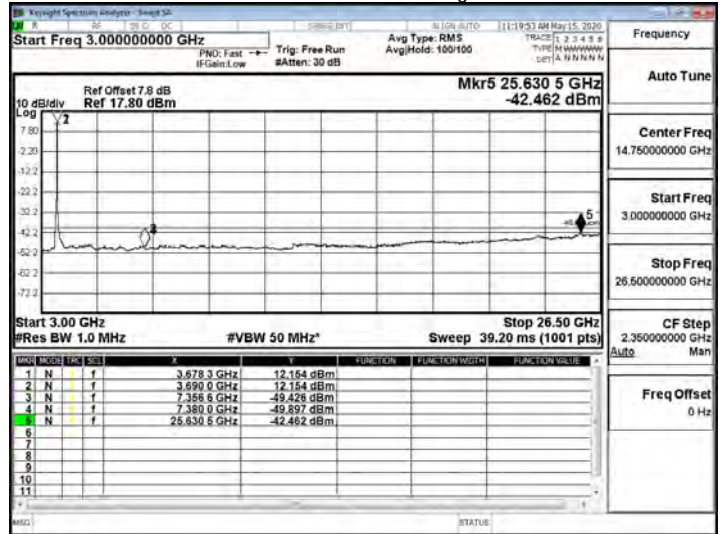

Unless otherwise stated the results shown in this test report refer only to the sample(s) tested and such sample(s) are retained for 90 days only.

除非另有說明，此報告結果僅對測試之樣品負責。同時此樣品僅保留90天。本報告未經本公司書面許可，不可部份複製。

This document is issued by the Company subject to its General Conditions of Service printed overleaf, available on request or accessible at <http://www.sgs.com.tw/Terms-and-Conditions>, and for electronic format documents, subject to Terms and Conditions for Electronic Documents at <http://www.sgs.com.tw/Terms-and-Conditions>. Attention is drawn to the limitation of liability, indemnification and jurisdiction issues defined therein. Any holder of this document is advised that information contained hereon reflects the Company's findings at the time of its intervention only and within the limits of Client's instructions, if any. The Company's sole responsibility is to its Client and this document does not exonerate parties to a transaction from exercising all their rights and obligations under the transaction documents. This document cannot be reproduced except in full, without prior written approval of the Company. Any unauthorized alteration, forgery or falsification of the content or appearance of this document is unlawful and offenders may be prosecuted to the fullest extent of the law.

Emission_B66B_30MHz-3GHz_Low_CH

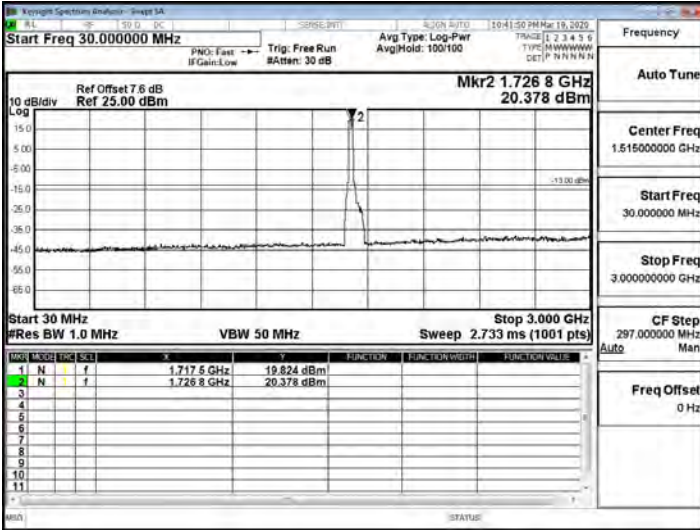

Emission_B66B_3GHz-26GHz_Low_CH

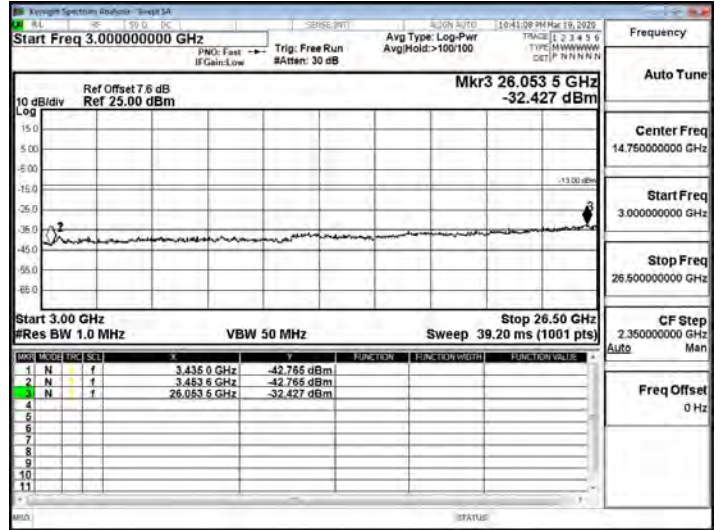

Emission_B66B_30MHz-3GHz_Mid_CH

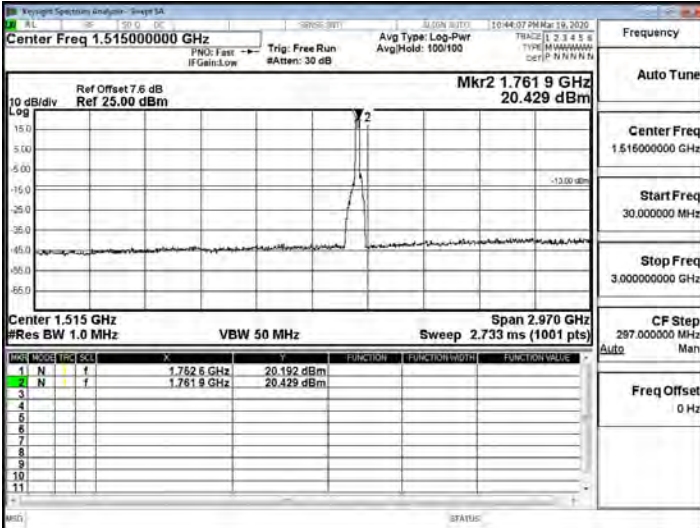

Emission_B66B_3GHz-26GHz_Mid_CH

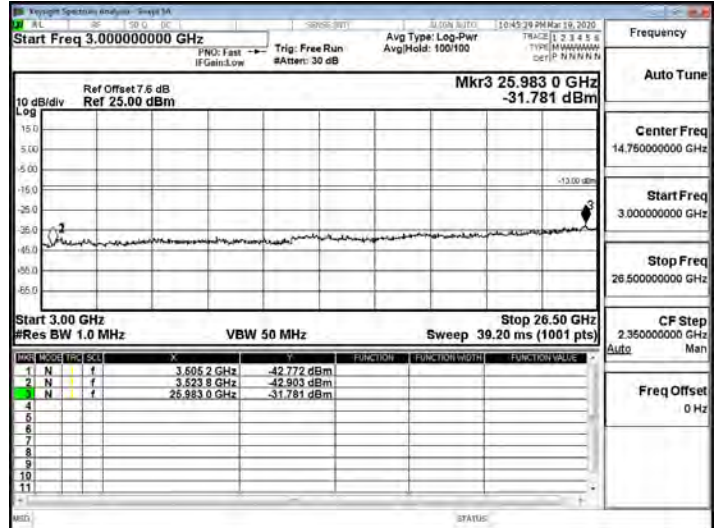

Emission_B66B_30MHz-3GHz_High_CH

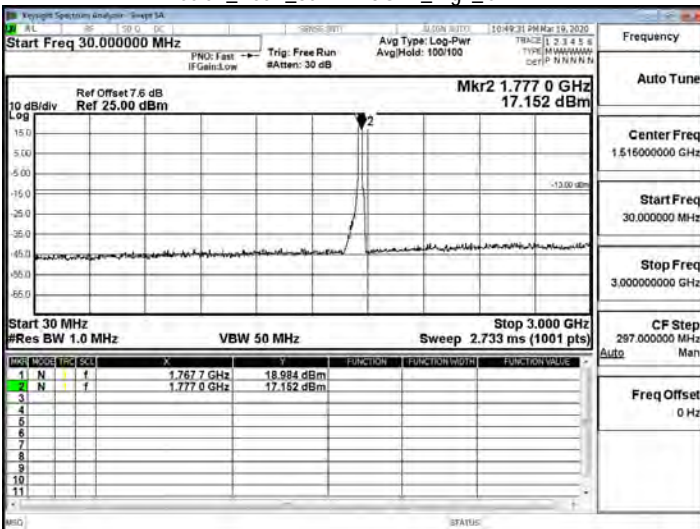

Emission_B66B_3GHz-26GHz_High_CH

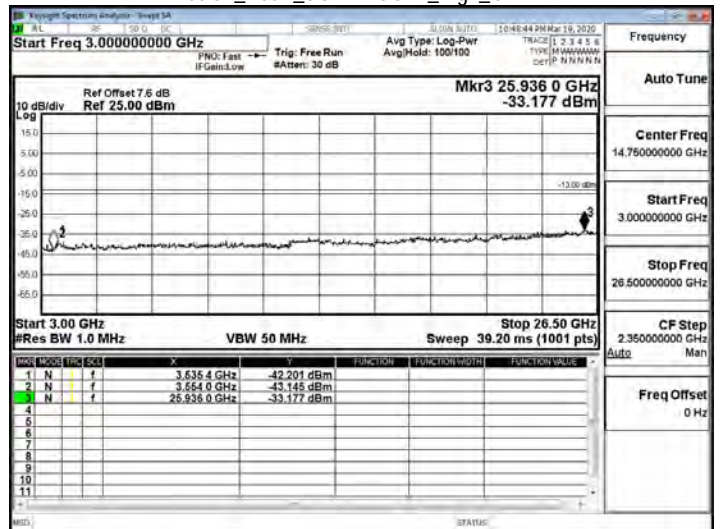

Unless otherwise stated the results shown in this test report refer only to the sample(s) tested and such sample(s) are retained for 90 days only.

除非另有說明，此報告結果僅對測試之樣品負責。同時此樣品僅保留90天。本報告未經本公司書面許可，不可部份複製。

This document is issued by the Company subject to its General Conditions of Service printed overleaf, available on request or accessible at <http://www.sgs.com.tw/Terms-and-Conditions> and for electronic format documents, subject to Terms and Conditions for Electronic Documents at <http://www.sgs.com.tw/Terms-and-Conditions>. Attention is drawn to the limitation of liability, indemnification and jurisdiction issues defined therein. Any holder of this document is advised that information contained herein reflects the Company's findings at the time of its intervention only and within the limits of Client's instructions, if any. The Company's sole responsibility is to its Client and this document does not exonerate parties to a transaction from exercising all their rights and obligations under the transaction documents. This document cannot be reproduced except in full, without prior written approval of the Company. Any unauthorized alteration, forgery or falsification of the content or appearance of this document is unlawful and offenders may be prosecuted to the fullest extent of the law.

Emission_B66C_30MHz-3GHz_Low_CH

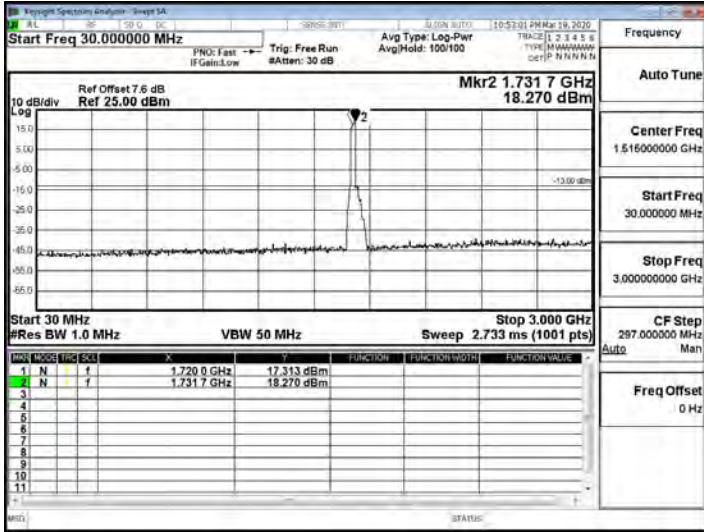

Emission_B66C_3GHz-26GHz_Low_CH

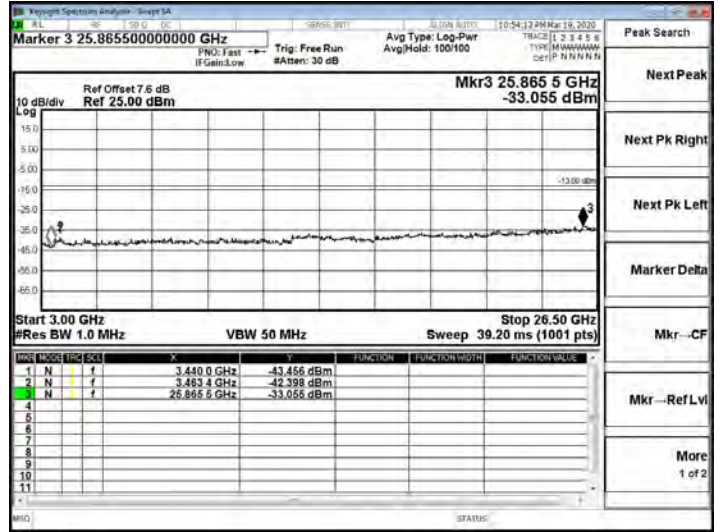

Emission_B66C_30MHz-3GHz_Mid_CH

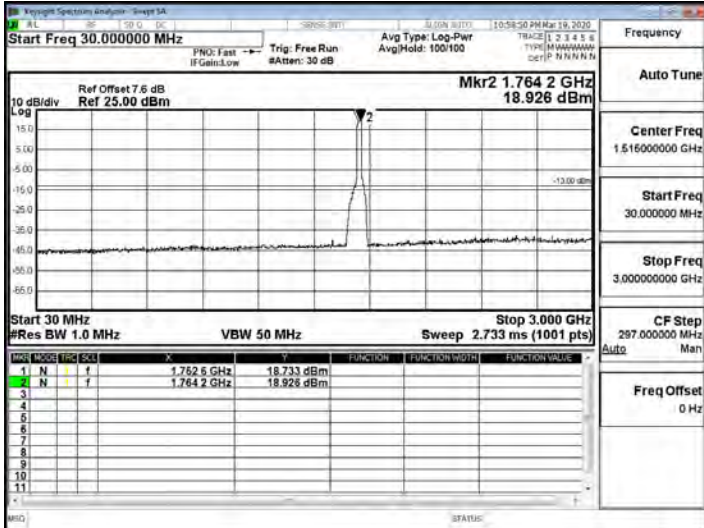

Emission_B66C_3GHz-26GHz_Mid_CH

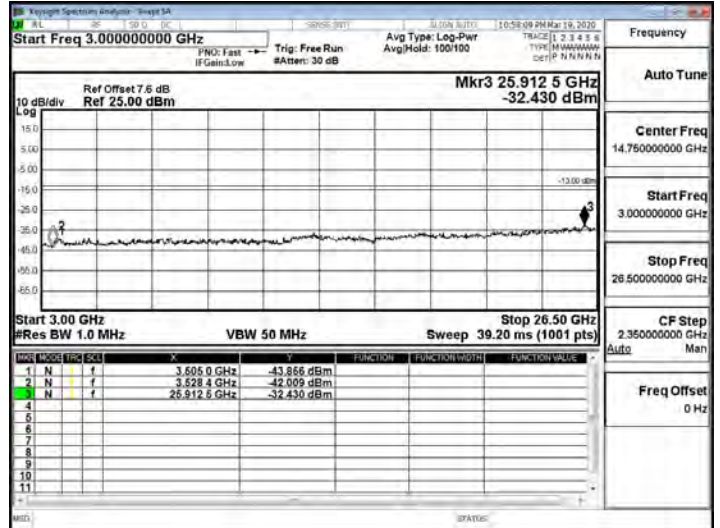

Emission_B66C_30MHz-3GHz_High_CH

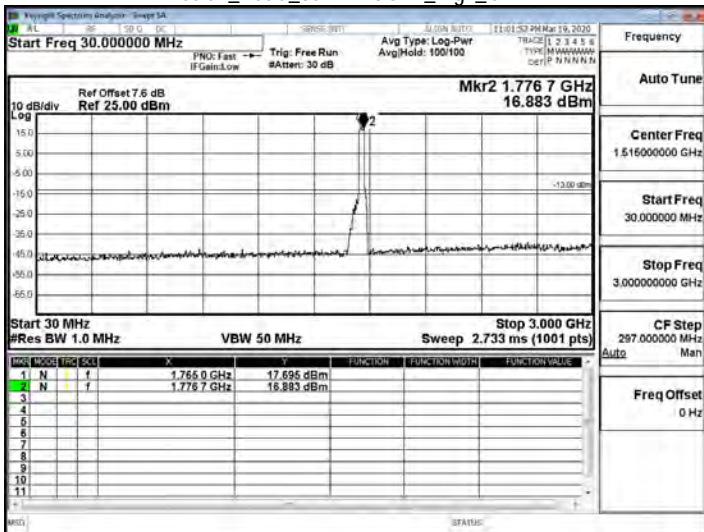

Emission_B66C_3GHz-26GHz_High_CH

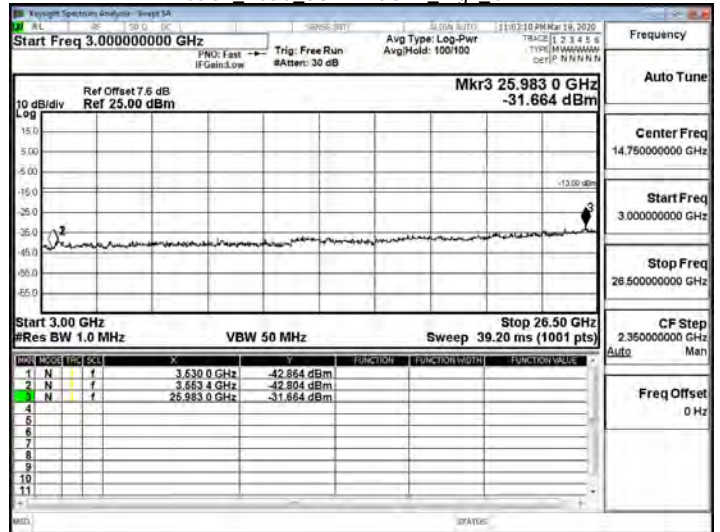

Unless otherwise stated the results shown in this test report refer only to the sample(s) tested and such sample(s) are retained for 90 days only.

除非另有說明，此報告結果僅對測試之樣品負責，同時此樣品僅保留90天。本報告未經本公司書面許可，不可部份複製。

This document is issued by the Company subject to its General Conditions of Service printed overleaf, available on request or accessible at <http://www.sgs.com.tw/Terms-and-Conditions>, and for electronic format documents, subject to Terms and Conditions for Electronic Documents at <http://www.sgs.com.tw/Terms-and-Conditions>. Attention is drawn to the limitation of liability, indemnification and jurisdiction issues defined therein. Any holder of this document is advised that information contained hereon reflects the Company's findings at the time of its intervention only and within the limits of Client's instructions, if any. The Company's sole responsibility is to its Client and this document does not exonerate parties to a transaction from exercising all their rights and obligations under the transaction documents. This document cannot be reproduced except in full, without prior written approval of the Company. Any unauthorized alteration, forgery or falsification of the content or appearance of this document is unlawful and offenders may be prosecuted to the fullest extent of the law.

Mask_B41C_CH_Low_1RB0

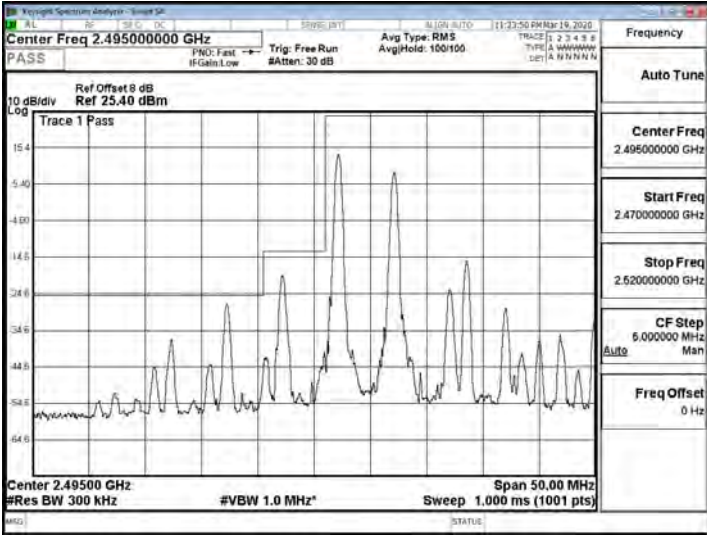

Mask_B41C_CH_High_Full

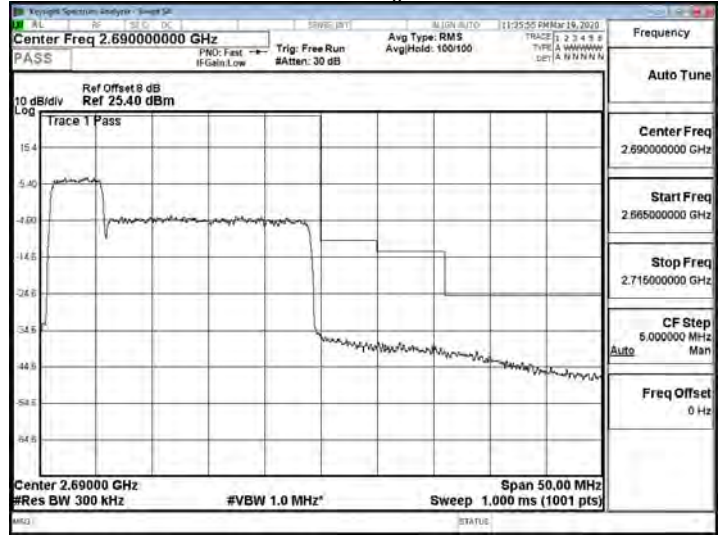

Mask_B41C_CH_Low_Full

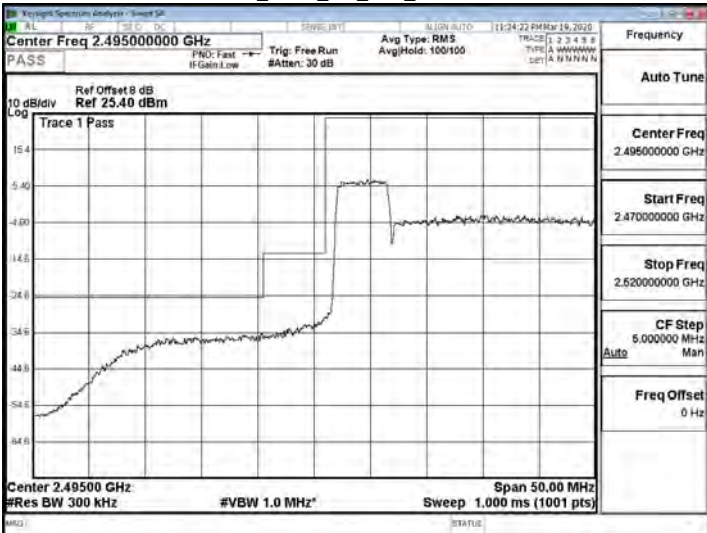

Mask_B48C_CH_Low_1RB0-1

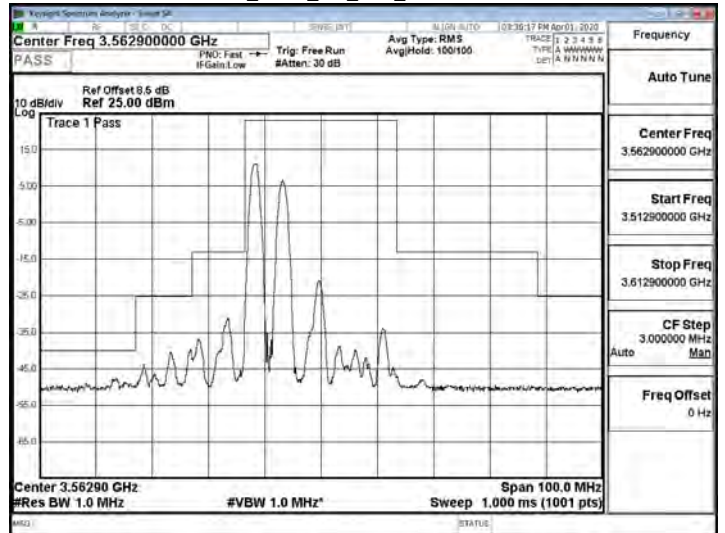

Mask_B41C_CH_High_1RBMax

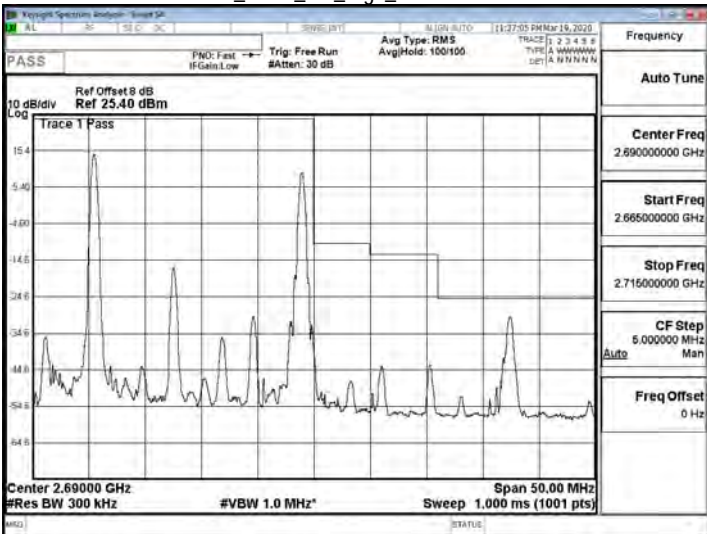

Mask_B48C_CH_Low_1RB0-3

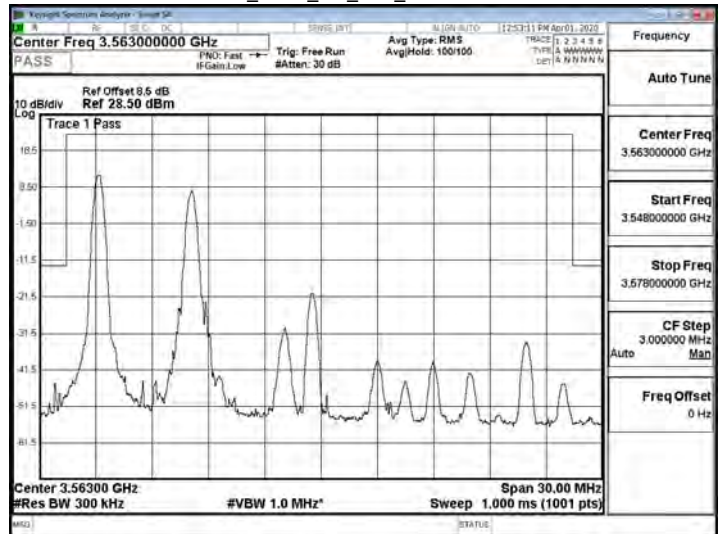

Unless otherwise stated the results shown in this test report refer only to the sample(s) tested and such sample(s) are retained for 90 days only.

除非另有說明，此報告結果僅對測試之樣品負責，同時此樣品僅保留90天。本報告未經本公司書面許可，不可部份複製。

This document is issued by the Company subject to its General Conditions of Service printed overleaf, available on request or accessible at <http://www.sgs.com.tw/Terms-and-Conditions> and for electronic format documents, subject to Terms and Conditions for Electronic Documents at <http://www.sgs.com.tw/Terms-and-Conditions>. Attention is drawn to the limitation of liability, indemnification and jurisdiction issues defined therein. Any holder of this document is advised that information contained hereon reflects the Company's findings at the time of its intervention only and within the limits of Client's instructions, if any. The Company's sole responsibility is to its Client and this document does not exonerate parties to a transaction from exercising all their rights and obligations under the transaction documents. This document cannot be reproduced except in full, without prior written approval of the Company. Any unauthorized alteration, forgery or falsification of the content or appearance of this document is unlawful and offenders may be prosecuted to the fullest extent of the law.

Mask_B48C_CH_Low_Full-1

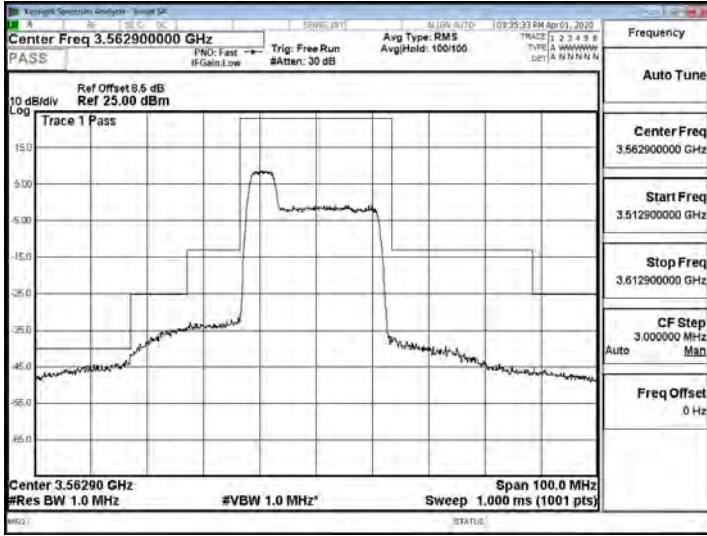

Mask_B48C_CH_Mid_1RB0-3

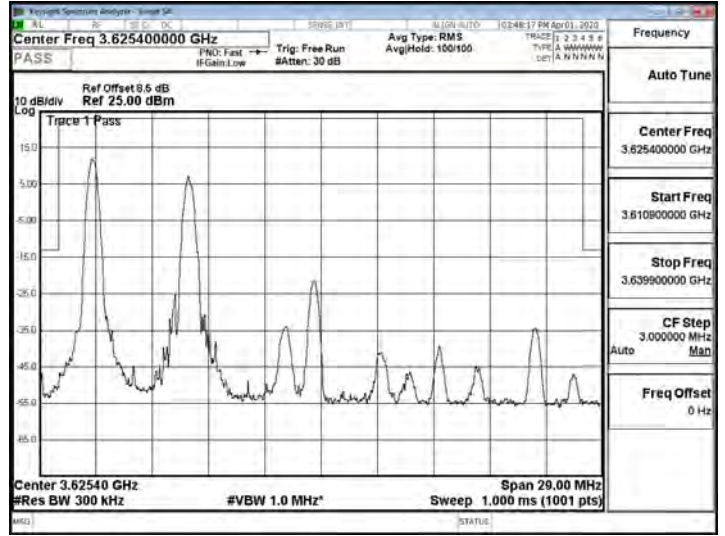

Mask_B48C_CH_Low_Full-3

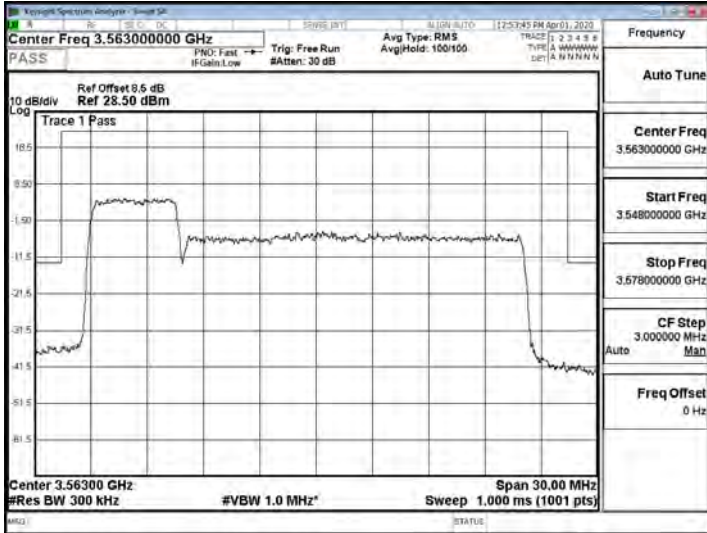

Mask_B48C_CH_Mid_Full-1

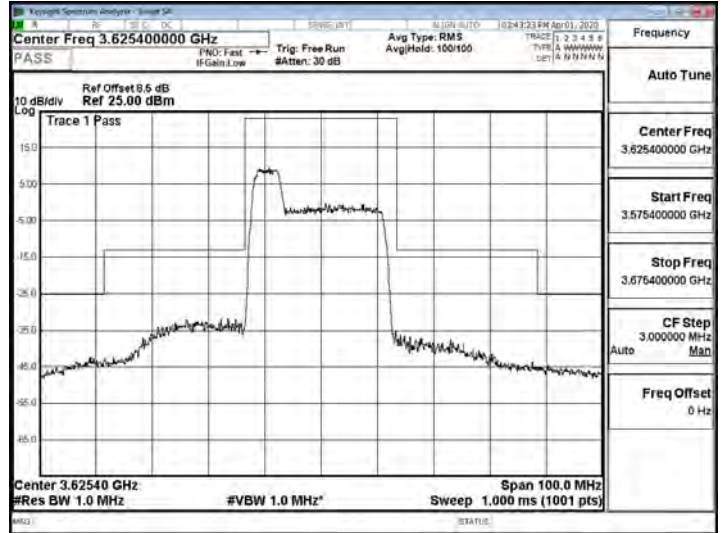

Mask_B48C_CH_Mid_1RB0-1

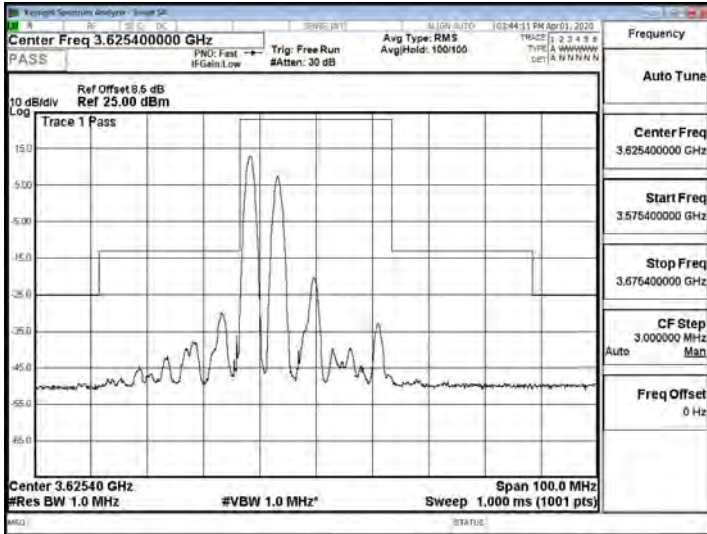

Mask_B48C_CH_Mid_Full-3

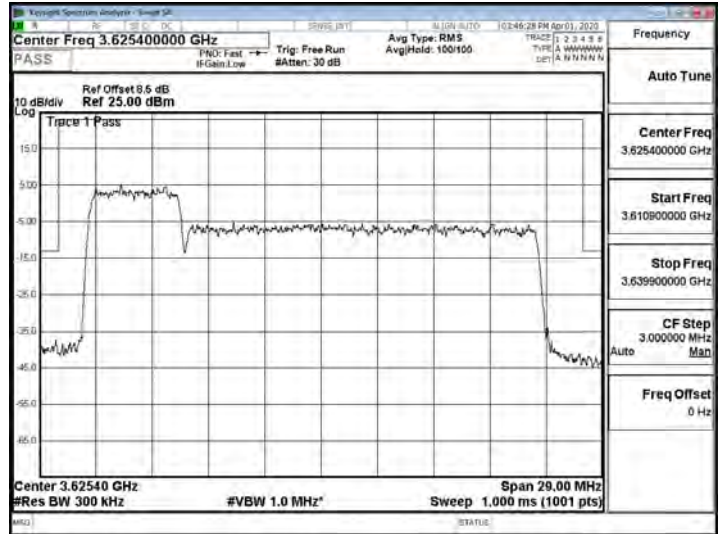

Unless otherwise stated the results shown in this test report refer only to the sample(s) tested and such sample(s) are retained for 90 days only.

除非另有說明，此報告結果僅對測試之樣品負責，同時此樣品僅保留90天。本報告未經本公司書面許可，不可部份複製。

This document is issued by the Company subject to its General Conditions of Service printed overleaf, available on request or accessible at <http://www.sgs.com.tw/Terms-and-Conditions> and for electronic format documents, subject to Terms and Conditions for Electronic Documents at <http://www.sgs.com.tw/Terms-and-Conditions>. Attention is drawn to the limitation of liability, indemnification and jurisdiction issues defined therein. Any holder of this document is advised that information contained hereon reflects the Company's findings at the time of its intervention only and within the limits of Client's instructions, if any. The Company's sole responsibility is to its Client and this document does not exonerate parties to a transaction from exercising all their rights and obligations under the transaction documents. This document cannot be reproduced except in full, without prior written approval of the Company. Any unauthorized alteration, forgery or falsification of the content or appearance of this document is unlawful and offenders may be prosecuted to the fullest extent of the law.

Mask_B48C_CH_High_1RB0-1

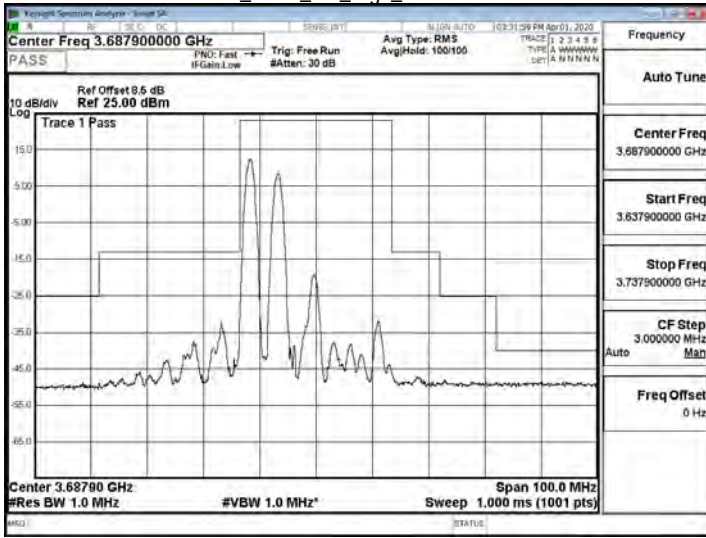

Mask_B48C_CH_High_Full-3

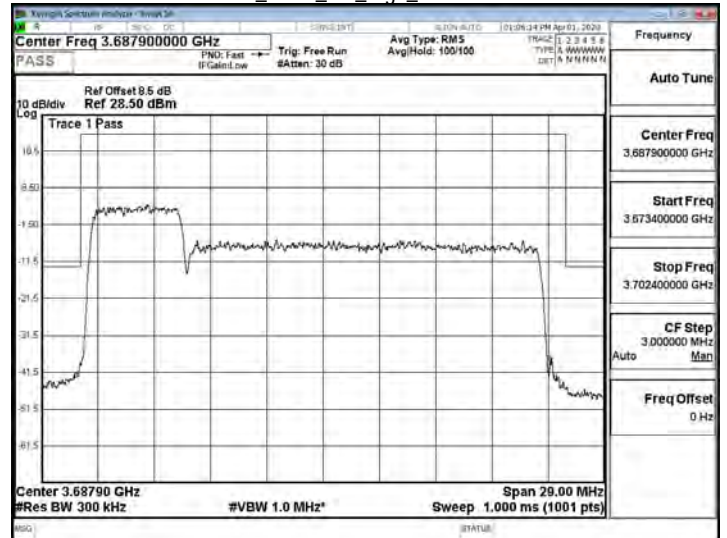

Mask_B48C_CH_High_1RB0-3

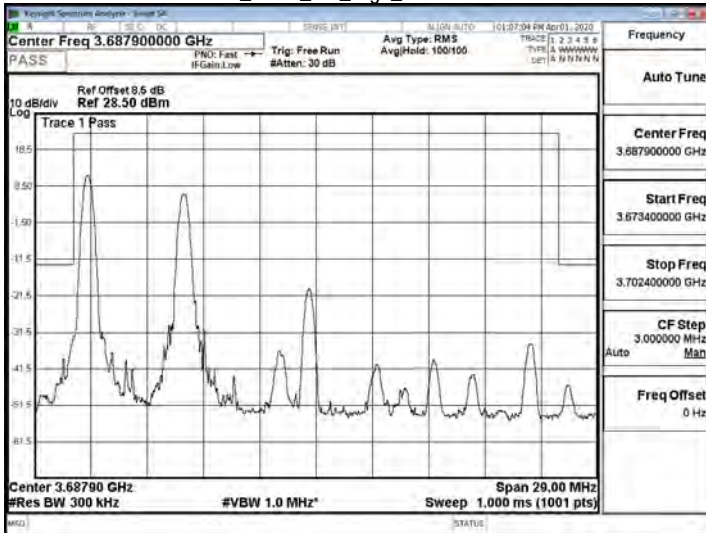

Mask_B48C_CH_High_Full-1

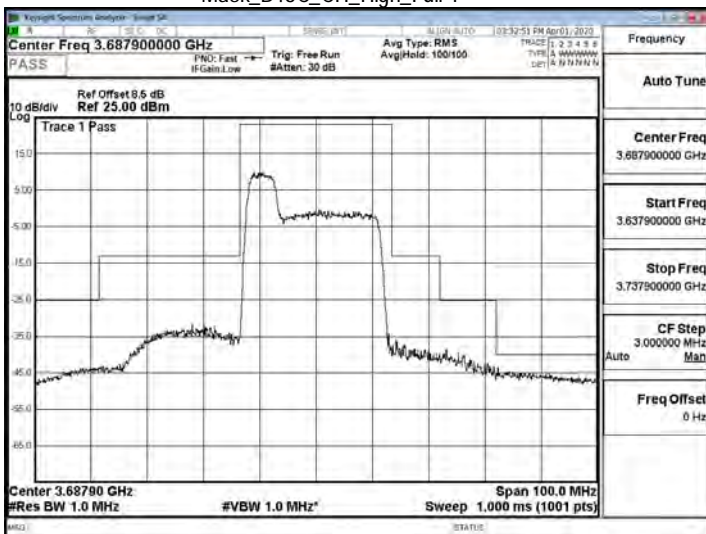

Unless otherwise stated the results shown in this test report refer only to the sample(s) tested and such sample(s) are retained for 90 days only.

除非另有說明，此報告結果僅對測試之樣品負責，同時此樣品僅保留90天，本報告未經本公司書面許可，不可部份複製。

This document is issued by the Company subject to its General Conditions of Service printed overleaf, available on request or accessible at <http://www.sgs.com.tw/Terms-and-Conditions> and for electronic format documents, subject to Terms and Conditions for Electronic Documents at <http://www.sgs.com.tw/Terms-and-Conditions>. Attention is drawn to the limitation of liability, indemnification and jurisdiction issues defined therein. Any holder of this document is advised that information contained hereon reflects the Company's findings at the time of its intervention only and within the limits of Client's instructions, if any. The Company's sole responsibility is to its Client and this document does not exonerate parties to a transaction from exercising all their rights and obligations under the transaction documents. This document cannot be reproduced except in full, without prior written approval of the Company. Any unauthorized alteration, forgery or falsification of the content or appearance of this document is unlawful and offenders may be prosecuted to the fullest extent of the law.

Band edge_B5B_CH_Low_1RB0

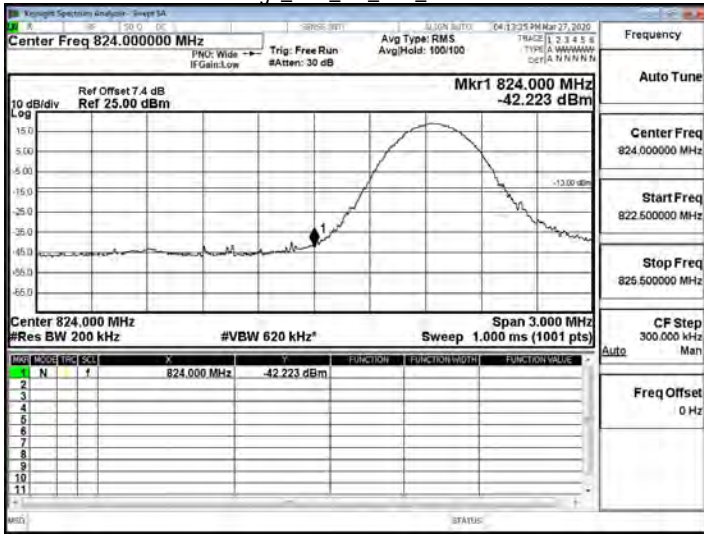

Band edge_B5B_CH_High_Full

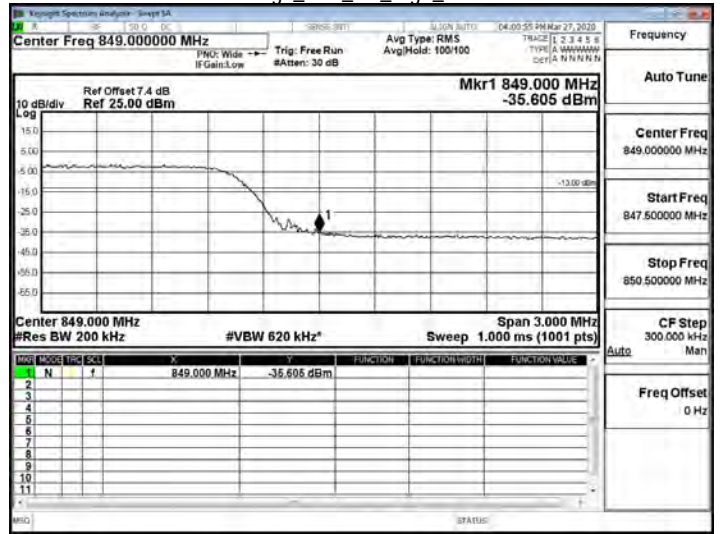

Band edge_B5B_CH_Low_Full

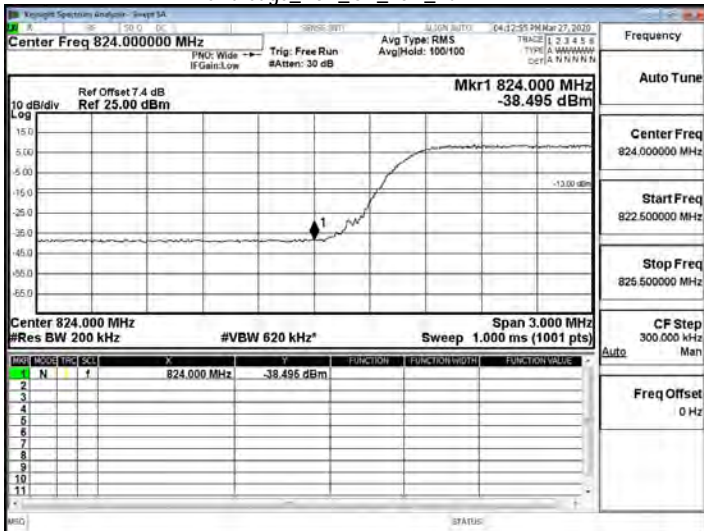

Band edge_B66B_CH_Low_1RB0



Band edge_B5B_CH_High_1RBMax

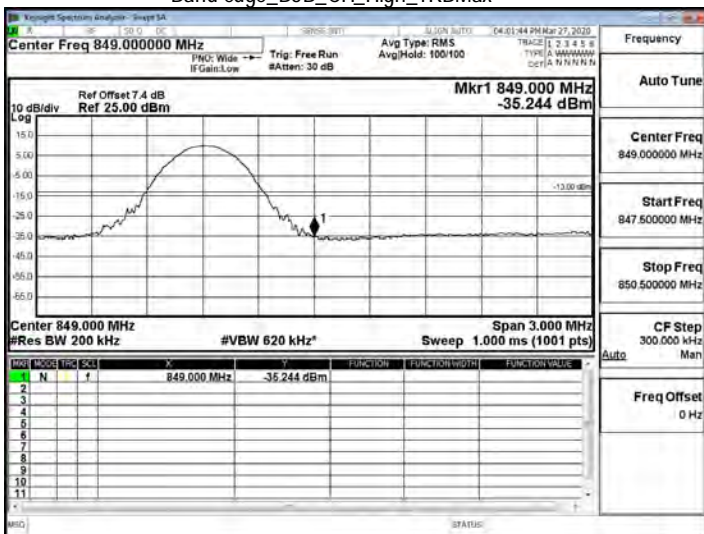

Band edge_B66B_CH_Low_Full

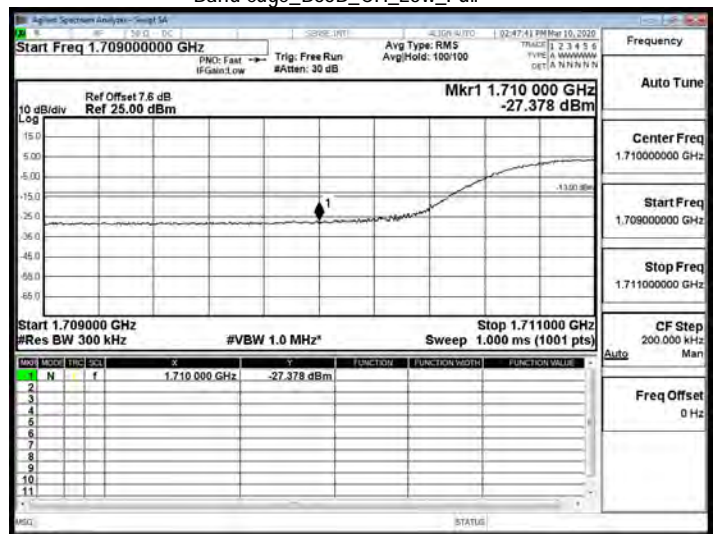

Unless otherwise stated the results shown in this test report refer only to the sample(s) tested and such sample(s) are retained for 90 days only.

除非另有說明，此報告結果僅對測試之樣品負責，同時此樣品僅保留90天。本報告未經本公司書面許可，不可部份複製。

This document is issued by the Company subject to its General Conditions of Service printed overleaf, available on request or accessible at <http://www.sgs.com.tw/Terms-and-Conditions> and for electronic format documents, subject to Terms and Conditions for Electronic Documents at <http://www.sgs.com.tw/Terms-and-Conditions>. Attention is drawn to the limitation of liability, indemnification and jurisdiction issues defined therein. Any holder of this document is advised that information contained hereon reflects the Company's findings at the time of its intervention only and within the limits of Client's instructions, if any. The Company's sole responsibility is to its Client and this document does not exonerate parties to a transaction from exercising all their rights and obligations under the transaction documents. This document cannot be reproduced except in full, without prior written approval of the Company. Any unauthorized alteration, forgery or falsification of the content or appearance of this document is unlawful and offenders may be prosecuted to the fullest extent of the law.

SGS Taiwan Ltd.

No.134,Wu Kung Road, New Taipei Industrial Park, Wuku District, New Taipei City, Taiwan/新北市五股區新北產業園區五工路 134 號

台灣檢驗科技股份有限公司

t (886-2) 2299-3279

f (886-2) 2298-0488

www.sgs.com.tw

Member of SGS Group

Band edge_B66B_CH_High_1RBmax

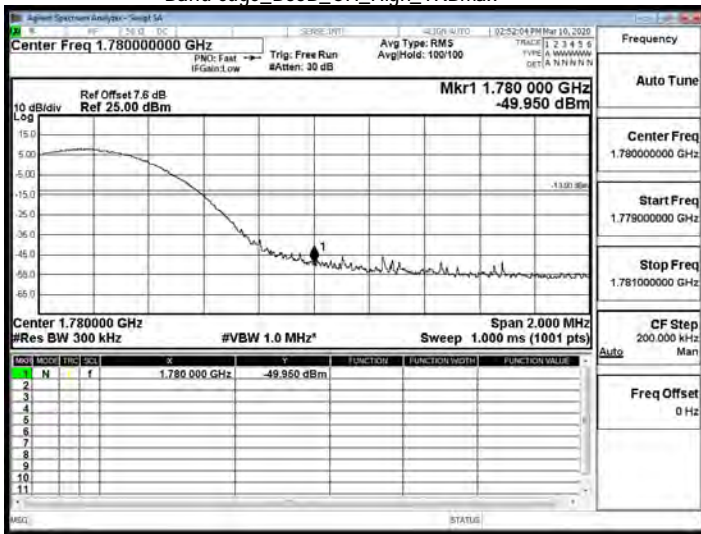

Band edge_B66C_CH_Low_Full

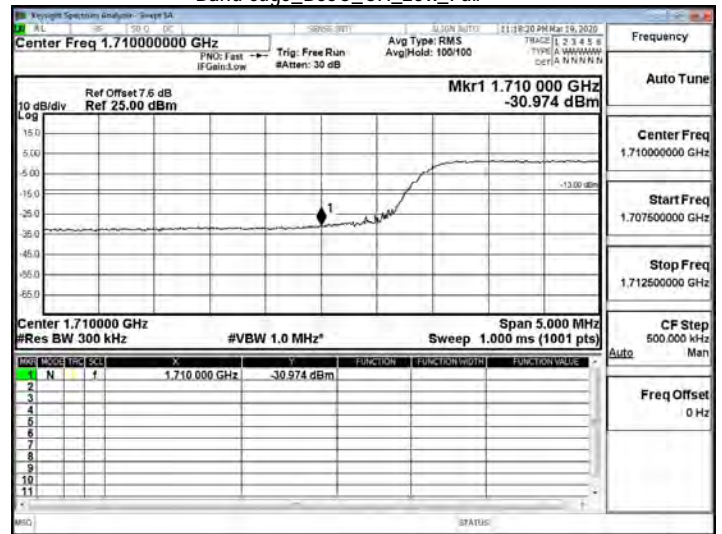

Band edge_B66B_CH_High_Full

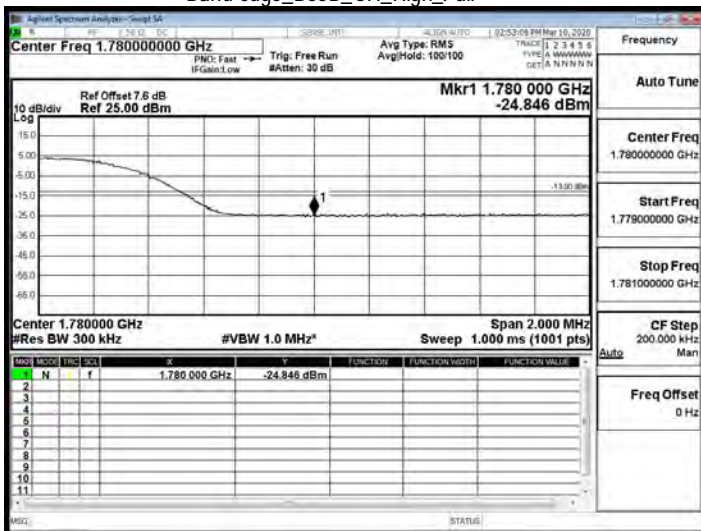

Band edge_B66C_CH_High_1RBMax

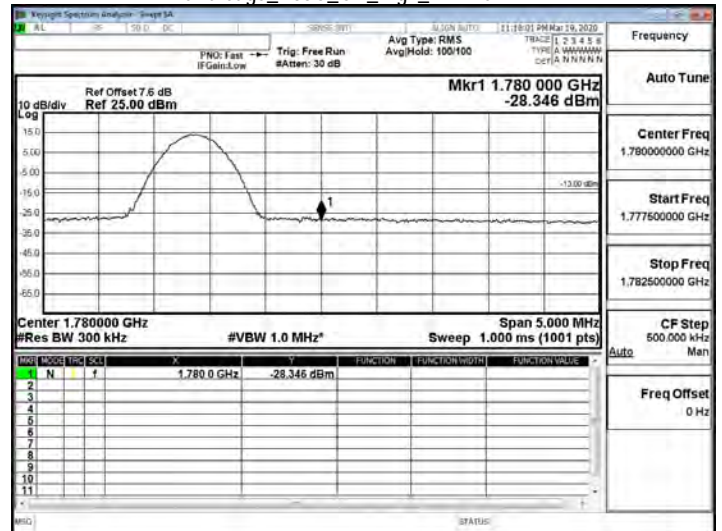

Band edge_B66C_CH_Low_1RB0

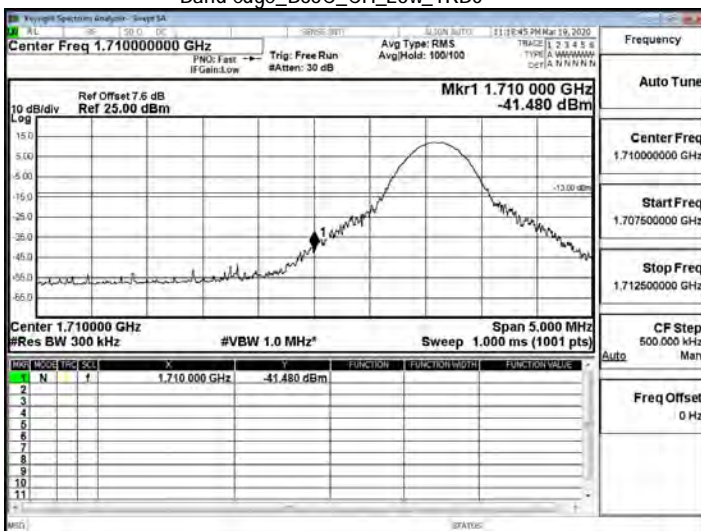

Band edge_B66C_CH_High_Full

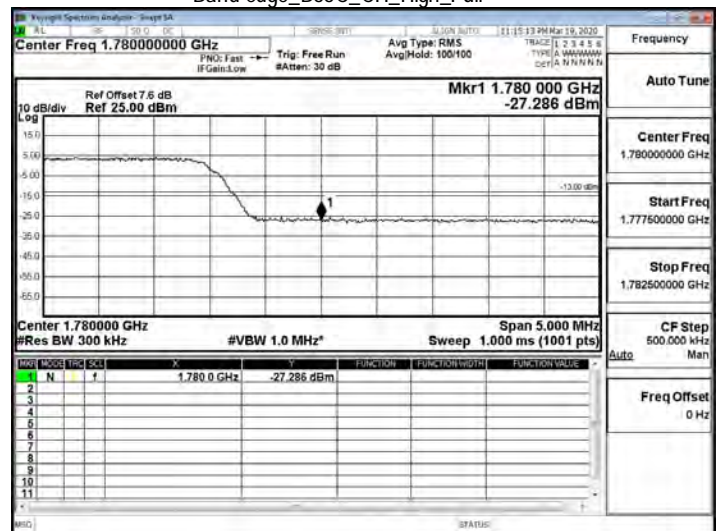

Unless otherwise stated the results shown in this test report refer only to the sample(s) tested and such sample(s) are retained for 90 days only.

除非另有說明，此報告結果僅對測試之樣品負責，同時此樣品僅保留90天。本報告未經本公司書面許可，不可部份複製。

This document is issued by the Company subject to its General Conditions of Service printed overleaf, available on request or accessible at <http://www.sgs.com.tw/Terms-and-Conditions> and for electronic format documents, subject to Terms and Conditions for Electronic Documents at <http://www.sgs.com.tw/Terms-and-Conditions>. Attention is drawn to the limitation of liability, indemnification and jurisdiction issues defined therein. Any holder of this document is advised that information contained hereon reflects the Company's findings at the time of its intervention only and within the limits of Client's instructions, if any. The Company's sole responsibility is to its Client and this document does not exonerate parties to a transaction from exercising all their rights and obligations under the transaction documents. This document cannot be reproduced except in full, without prior written approval of the Company. Any unauthorized alteration, forgery or falsification of the content or appearance of this document is unlawful and offenders may be prosecuted to the fullest extent of the law.

9 FIELD STRENGTH OF SPURIOUS RADIATION MEASUREMENT

9.1 Standard Applicable

According to FCC §2.1053,
FCC §22.917(a), §24.238(a), §27.53(h)

Out of band emissions. The power of any emission outside of the authorized operating frequency ranges must be attenuated below the transmitting power (P) by a factor of at least $43 + 10 \log(P)$ dB.

FCC §27.53(c) for LTE B13

For operations in the 746–758 MHz band and the 776–788 MHz band, the power of any emission outside the licensee's frequency band(s) of operation shall be attenuated below the transmitter power (P) within the licensed band(s) of operation, measured in watts, in accordance with the following:

(2) On any frequency outside the 776–788 MHz band, the power of any emission shall be attenuated outside the band below the transmitter power (P) by at least $43 + 10 \log(P)$ dB (-13dBm)

FCC §27.53 (f) for LTE B13

For operations in the 746-758 MHz, 775-788 MHz, and 805-806 MHz bands, emissions in the band 1559-1610 MHz shall be limited to -70 dBW/MHz equivalent isotropically radiated power (EIRP) for wide-band signals, and -80 dBW EIRP for discrete emissions of less than 700 Hz bandwidth. For the purpose of equipment authorization, a transmitter shall be tested with an antenna that is representative of the type that will be used with the equipment in normal operation.

FCC §27.53(c) (5) & FCC §27.53(g) for LTE B12, 13

Compliance for operations in the 600 MHz, 698-746 MHz, 746-758 MHz and the 776-788 MHz band with this provision is based on the use of measurement instrumentation employing a resolution bandwidth of 100 kilohertz or greater. However, in the 100 kilohertz bands immediately outside and adjacent to a licensee's frequency block, a resolution bandwidth of at least 30 kHz may be employed.

FCC §27.53(h)(3) for LTE B4, 66

Compliance with this provision is based on the use of measurement instrumentation employing a resolution bandwidth of 1 megahertz or greater. However, in the 1 megahertz bands immediately outside and adjacent to the licensee's frequency block, a resolution bandwidth of at least one percent of the emission bandwidth of the fundamental emission of the transmitter may be employed. The emission bandwidth is defined as the width of the signal between two points, one below the carrier center frequency and one above the carrier center frequency, outside of which all emissions are attenuated at least 26 dB below the transmitter power.

FCC §27.53(m) (4) (6) for LTE B7, 41

For mobile digital stations, the attenuation factor shall be not less than $40 + 10 \log(P)$ dB on all frequencies between the channel edge and 5 megahertz from the channel edge, $43 + 10 \log(P)$ dB on all frequencies between 5 megahertz and X megahertz from the channel edge, and $55 + 10 \log(P)$ dB on all frequencies more than X megahertz from the channel edge, where X is the greater of 6 megahertz or the actual emission bandwidth as defined in paragraph (m)(6) of this section. In addition, the attenuation factor shall not be less than $43 + 10 \log(P)$ dB on all frequencies between 2490.5 MHz and 2496 MHz and $55 + 10 \log(P)$ dB at or below 2490.5 MHz. Mobile Satellite Service licensees operating on frequencies below 2495 MHz may also submit a documented interference complaint against BRS licensees operating on channel BRS Channel 1 on the same terms and conditions as adjacent channel BRS or EBS licensees.

Measurement procedure. Compliance with these rules is based on the use of measurement instrumentation employing a resolution bandwidth of 1 megahertz or greater. However, in the 1 MHz bands immediately outside and adjacent to the frequency block a resolution bandwidth of at least one percent of the emission bandwidth of the fundamental emission of the transmitter may be employed; for mobile digital stations, in the 1 megahertz bands immediately outside and adjacent to the frequency block a resolution bandwidth of at

Unless otherwise stated the results shown in this test report refer only to the sample(s) tested and such sample(s) are retained for 90 days only.

除非另有說明，此報告結果僅對測試之樣品負責。同時此樣品僅保留90天。本報告未經本公司書面許可，不可部份複製。

This document is issued by the Company subject to its General Conditions of Service printed overleaf, available on request or accessible at <http://www.sgs.com.tw/Terms-and-Conditions> and for electronic format documents, subject to Terms and Conditions for Electronic Documents at <http://www.sgs.com.tw/Terms-and-Conditions>. Attention is drawn to the limitation of liability, indemnification and jurisdiction issues defined therein. Any holder of this document is advised that information contained hereon reflects the Company's findings at the time of its intervention only and within the limits of Client's instructions, if any. The Company's sole responsibility is to its Client and this document does not exonerate parties to a transaction from exercising all their rights and obligations under the transaction documents. This document cannot be reproduced except in full, without prior written approval of the Company. Any unauthorized alteration, forgery or falsification of the content or appearance of this document is unlawful and offenders may be prosecuted to the fullest extent of the law.

least two percent may be employed, except when the 1 megahertz band is 2495-2496 MHz, in which case a resolution bandwidth of at least one percent may be employed. A narrower resolution bandwidth is permitted in all cases to improve measurement accuracy provided the measured power is integrated over the full required measurement bandwidth (i.e. 1 megahertz or 1 percent of emission bandwidth, as specified; or 1 megahertz or 2 percent for mobile digital stations, except in the band 2495-2496 MHz). The emission bandwidth is defined as the width of the signal between two points, one below the carrier center frequency and one above the carrier center frequency, outside of which all emissions are attenuated at least 26 dB below the transmitter power. With respect to television operations, measurements must be made of the separate visual and aural operating powers at sufficiently frequent intervals to ensure compliance with the rules.

FCC § 96.41, C63.26 Clause 5.7 for LTE B48

1. within 0 MHz to 10 MHz above and below the **assigned channel** ≤ -13 dBm/MHz
 2. greater than 10 MHz above and below the **assigned channel** ≤ -25 dBm/MHz
- any emission below 3530 MHz and above 3720 MHz ≤ -40 dBm/MHz

Unless otherwise stated the results shown in this test report refer only to the sample(s) tested and such sample(s) are retained for 90 days only.

除非另有說明，此報告結果僅對測試之樣品負責，同時此樣品僅保留90天。本報告未經本公司書面許可，不可部份複製。

This document is issued by the Company subject to its General Conditions of Service printed overleaf, available on request or accessible at <http://www.sgs.com.tw/Terms-and-Conditions> and for electronic format documents, subject to Terms and Conditions for Electronic Documents at <http://www.sgs.com.tw/Terms-and-Conditions>. Attention is drawn to the limitation of liability, indemnification and jurisdiction issues defined therein. Any holder of this document is advised that information contained hereon reflects the Company's findings at the time of its intervention only and within the limits of Client's instructions, if any. The Company's sole responsibility is to its Client and this document does not exonerate parties to a transaction from exercising all their rights and obligations under the transaction documents. This document cannot be reproduced except in full, without prior written approval of the Company. Any unauthorized alteration, forgery or falsification of the content or appearance of this document is unlawful and offenders may be prosecuted to the fullest extent of the law.

SGS Taiwan Ltd.

台灣檢驗科技股份有限公司

No.134,Wu Kung Road, New Taipei Industrial Park, Wuku District, New Taipei City, Taiwan/新北市五股區新北產業園區五工路 134 號

t (886-2) 2299-3279

f (886-2) 2298-0488

www.sgs.com.tw

Member of SGS Group

Table 2 — Unwanted Emissions for Mobile, Portable and Low-Power Fixed Subscriber Equipment

Frequency (MHz)	Attenuation (dB)
<2200	$43 + 10 \log_{10}(p)$
2200 - 2288	$70 + 10 \log_{10}(p)$
2288 - 2292	$67 + 10 \log_{10}(p)$
2292 - 2296	$61 + 10 \log_{10}(p)$
2296 - 2300	$55 + 10 \log_{10}(p)$
2300 - 2305	$43 + 10 \log_{10}(p)$
2305 - 2320	$43 + 10 \log_{10}(p)$ ^{Note}
2320 - 2324	$55 + 10 \log_{10}(p)$
2324 - 2328	$61 + 10 \log_{10}(p)$
2328 - 2337	$67 + 10 \log_{10}(p)$
2337 - 2341	$61 + 10 \log_{10}(p)$
2341 - 2345	$55 + 10 \log_{10}(p)$
2345 - 2360	$43 + 10 \log_{10}(p)$ ^{Note}
2360 - 2365	$43 + 10 \log_{10}(p)$
2365 - 2395	$70 + 10 \log_{10}(p)$
>2395	$43 + 10 \log_{10}(p)$

Note: Measured at the edges of the highest and lowest frequency range(s) in which the equipment is designed to operate. See Section 1.2 for the permitted frequency ranges for various equipment types.

9.2 EUT Setup

Radiated Emission Test Set-Up, Frequency Below 1000MHz

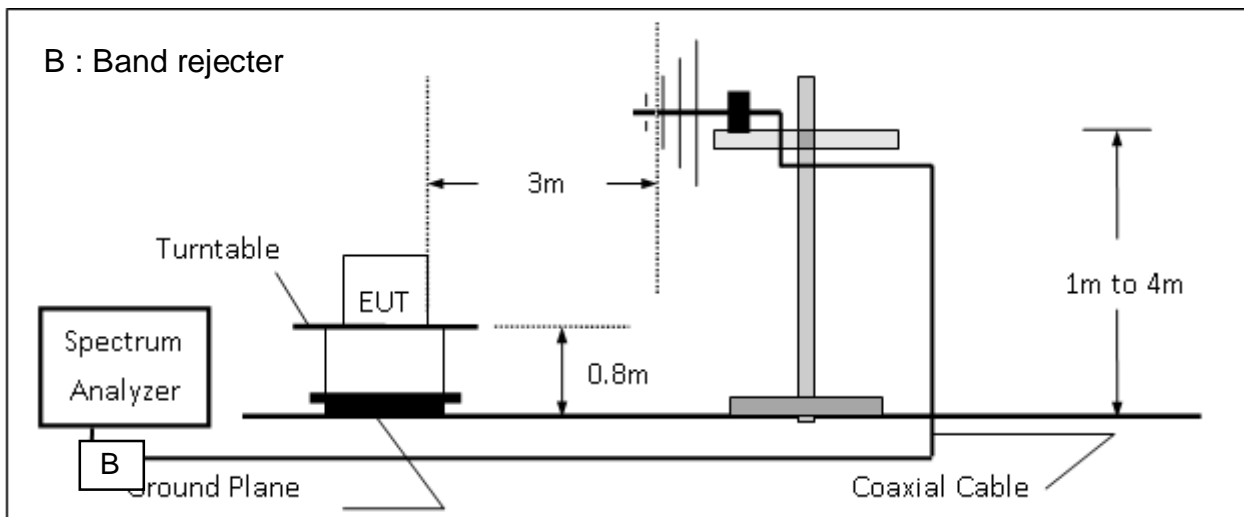

Unless otherwise stated the results shown in this test report refer only to the sample(s) tested and such sample(s) are retained for 90 days only.

除非另有說明，此報告結果僅對測試之樣品負責，同時此樣品僅保留90天。本報告未經本公司書面許可，不可部份複製。

This document is issued by the Company subject to its General Conditions of Service printed overleaf, available on request or accessible at <http://www.sgs.com.tw/Terms-and-Conditions> and for electronic format documents, subject to Terms and Conditions for Electronic Documents at <http://www.sgs.com.tw/Terms-and-Conditions>. Attention is drawn to the limitation of liability, indemnification and jurisdiction issues defined therein. Any holder of this document is advised that information contained hereon reflects the Company's findings at the time of its intervention only and within the limits of Client's instructions, if any. The Company's sole responsibility is to its Client and this document does not exonerate parties to a transaction from exercising all their rights and obligations under the transaction documents. This document cannot be reproduced except in full, without prior written approval of the Company. Any unauthorized alteration, forgery or falsification of the content or appearance of this document is unlawful and offenders may be prosecuted to the fullest extent of the law.

Radiated Emission Test Set-UP Frequency Over 1 GHz

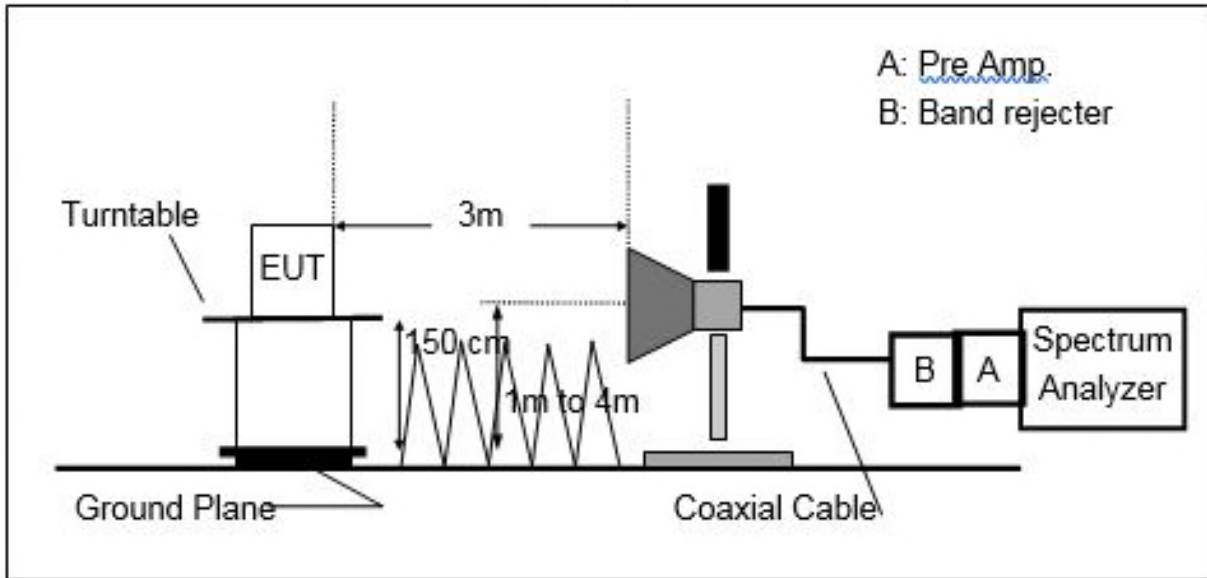

9.3 Measurement Procedure:

The EUT was placed on a non-conductive; the measurement antenna was placed at a distance of 3 meters from the EUT. During the tests, the antenna height and the EUT azimuth were varied in order to identify the maximum level of emissions from the EUT. This maximization process was repeated with the EUT positioned in each of its three orthogonal orientations.

The frequency range up to tenth harmonic was investigated for each of three fundamental frequencies (low, middle and high channels). Once spurious emission was identified, the power of the emission was determined using the substitution method.

The spurious emissions attenuation was calculated as the difference between radiated power at the fundamental frequency and the spurious emissions frequency.

$$\text{ERP (dBm)} = \text{SG Level(dBm)} + \text{Antenna Gain(dBd)} + \text{Cable Loss(dB)}$$

$$\text{EIRP (dBm)} = \text{SG Level(dBm)} + \text{Antenna Gain(dBi)} + \text{Cable Loss(dB)}$$

Unless otherwise stated the results shown in this test report refer only to the sample(s) tested and such sample(s) are retained for 90 days only.

除非另有說明，此報告結果僅對測試之樣品負責，同時此樣品僅保留90天。本報告未經本公司書面許可，不可部份複製。

This document is issued by the Company subject to its General Conditions of Service printed overleaf, available on request or accessible at <http://www.sgs.com.tw/Terms-and-Conditions> and for electronic format documents, subject to Terms and Conditions for Electronic Documents at <http://www.sgs.com.tw/Terms-and-Conditions>. Attention is drawn to the limitation of liability, indemnification and jurisdiction issues defined therein. Any holder of this document is advised that information contained hereon reflects the Company's findings at the time of its intervention only and within the limits of Client's instructions, if any. The Company's sole responsibility is to its Client and this document does not exonerate parties to a transaction from exercising all their rights and obligations under the transaction documents. This document cannot be reproduced except in full, without prior written approval of the Company. Any unauthorized alteration, forgery or falsification of the content or appearance of this document is unlawful and offenders may be prosecuted to the fullest extent of the law.

9.4 Measurement Equipment Used:

EQUIPMENT TYPE	MFR	MODEL NUMBER	SERIAL NUMBER	LAST CAL.	CAL DUE.
Broadband Antenna	TESEQ	CBL 6112D	35240	09/09/2019	09/08/2020
Horn Antenna	Schwarzbeck	BBHA9120D	1187	01/10/2020	01/09/2021
Horn Antenna	SCHWAZBECK	BBHA9170	185	08/07/2019	08/06/2020
EMI Test Receiver	R&S	ESU 40	100363	04/15/2019	04/14/2020
Radio Communication Analyzer	Anritsu	MT8821C	6261786084	01/18/2020	01/17/2021
Pre-Amplifier	EMC Instruments	EMC330	980096	11/20/2019	11/19/2020
Pre-Amplifier	EMC Instruments	EMC0011830	980199	11/20/2019	11/19/2020
Pre-Amplifier	EMC Instruments	EMC184045B	980135	11/20/2019	11/19/2020
Notch Filter	Woken	EWT-54-0037	RF54	11/20/2019	11/19/2020
Notch Filter	Woken	EWT-54-0038	RF55	11/20/2019	11/19/2020
Coaxial Cable	Huber Suhner	SUCOFLEX 104	MY17388/4	11/20/2019	11/19/2020
Coaxial Cable	Huber Suhner	RG 214/U	W22.03	11/20/2019	11/19/2020
Coaxial Cable	Huber Suhner	SUCOFLEX 104	MY17413/4	11/20/2019	11/19/2020

Unless otherwise stated the results shown in this test report refer only to the sample(s) tested and such sample(s) are retained for 90 days only.

除非另有說明，此報告結果僅對測試之樣品負責，同時此樣品僅保留90天。本報告未經本公司書面許可，不可部份複製。

This document is issued by the Company subject to its General Conditions of Service printed overleaf, available on request or accessible at <http://www.sgs.com.tw/Terms-and-Conditions> and for electronic format documents, subject to Terms and Conditions for Electronic Documents at <http://www.sgs.com.tw/Terms-and-Conditions>. Attention is drawn to the limitation of liability, indemnification and jurisdiction issues defined therein. Any holder of this document is advised that information contained hereon reflects the Company's findings at the time of its intervention only and within the limits of Client's instructions, if any. The Company's sole responsibility is to its Client and this document does not exonerate parties to a transaction from exercising all their rights and obligations under the transaction documents. This document cannot be reproduced except in full, without prior written approval of the Company. Any unauthorized alteration, forgery or falsification of the content or appearance of this document is unlawful and offenders may be prosecuted to the fullest extent of the law.

SGS Taiwan Ltd.

台灣檢驗科技股份有限公司

No.134,Wu Kung Road, New Taipei Industrial Park, Wuku District, New Taipei City, Taiwan/新北市五股區新北產業園區五工路 134 號

t (886-2) 2299-3279

f (886-2) 2298-0488

www.sgs.com.tw

Member of SGS Group

9.5 Measurement Result:
Radiated Spurious Emission Measurement Result: LTE Band 5B Mode

Report Number	:E2/2019/A0032	Test Date	:2020-04-13
Operation Mode	:LTE B5B	Temp./Humi.	:24.3/58
Test Mode	:TX CH LOW	Antenna Pol.	:VERTICAL
EUT Pol	:E2 Plan	Engineer	:Enzo
Test Frequency	:826.8+834 MHz		

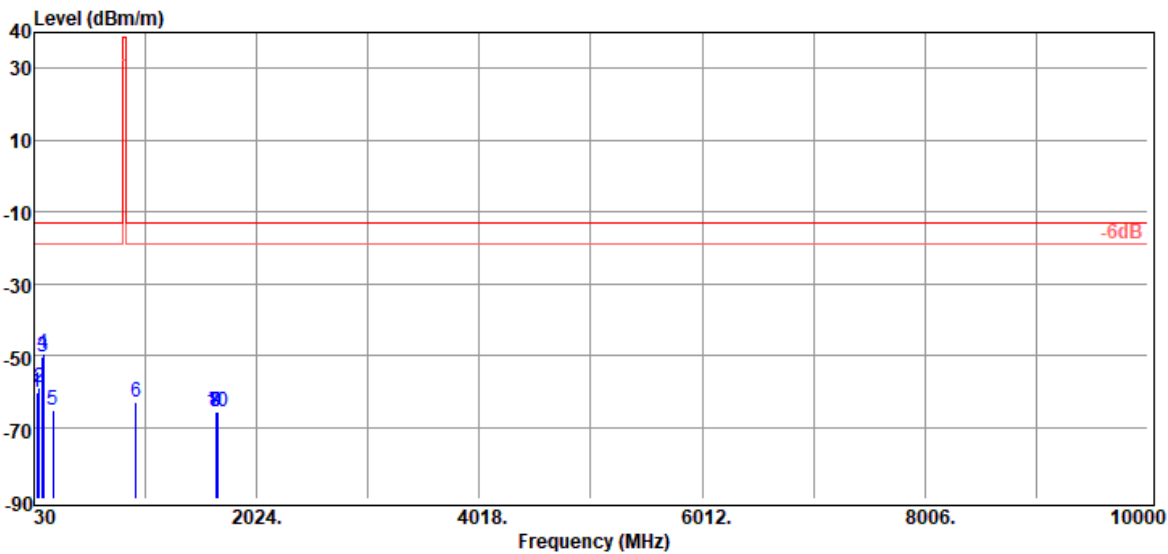

Freq. MHz	EIRP/ERP dBm	SG Output Level dBm	Antenna Gain dBi/dBd	Cable Loss dB	Limit dBm	Margin dB
56.19	-60.45	-43.25	-16.25	-0.95	-13.00	-47.45
76.56	-59.05	-48.46	-9.49	-1.10	-13.00	-46.05
105.66	-50.28	-42.05	-6.83	-1.40	-13.00	-37.28
112.45	-49.64	-41.02	-7.17	-1.45	-13.00	-36.64
202.66	-65.25	-61.17	-2.00	-2.08	-13.00	-52.25
939.86	-63.01	-56.53	-1.68	-4.80	-13.00	-50.01
1653.60	-65.74	-67.53	9.34	-7.55	-13.00	-52.74
1653.60	-65.74	-67.53	9.34	-7.55	-13.00	-52.74
1668.00	-65.53	-67.36	9.48	-7.65	-13.00	-52.53
1668.00	-65.53	-67.36	9.48	-7.65	-13.00	-52.53

Unless otherwise stated the results shown in this test report refer only to the sample(s) tested and such sample(s) are retained for 90 days only.

除非另有說明，此報告結果僅對測試之樣品負責，同時此樣品僅保留90天。本報告未經本公司書面許可，不可部份複製。

This document is issued by the Company subject to its General Conditions of Service printed overleaf, available on request or accessible at <http://www.sgs.com.tw/Terms-and-Conditions> and for electronic format documents, subject to Terms and Conditions for Electronic Documents at <http://www.sgs.com.tw/Terms-and-Conditions>. Attention is drawn to the limitation of liability, indemnification and jurisdiction issues defined therein. Any holder of this document is advised that information contained hereon reflects the Company's findings at the time of its intervention only and within the limits of Client's instructions, if any. The Company's sole responsibility is to its Client and this document does not exonerate parties to a transaction from exercising all their rights and obligations under the transaction documents. This document cannot be reproduced except in full, without prior written approval of the Company. Any unauthorized alteration, forgery or falsification of the content or appearance of this document is unlawful and offenders may be prosecuted to the fullest extent of the law.

Report Number :E2/2019/A0032
 Operation Mode :LTE B5B
 Test Mode :TX CH LOW
 EUT Pol :E2 Plan
 Test Frequency :826.8+834 MHz

Test Date :2020-04-13
 Temp./Humi. :24.3/58
 Antenna Pol. :HORIZONTAL
 Engineer :Enzo

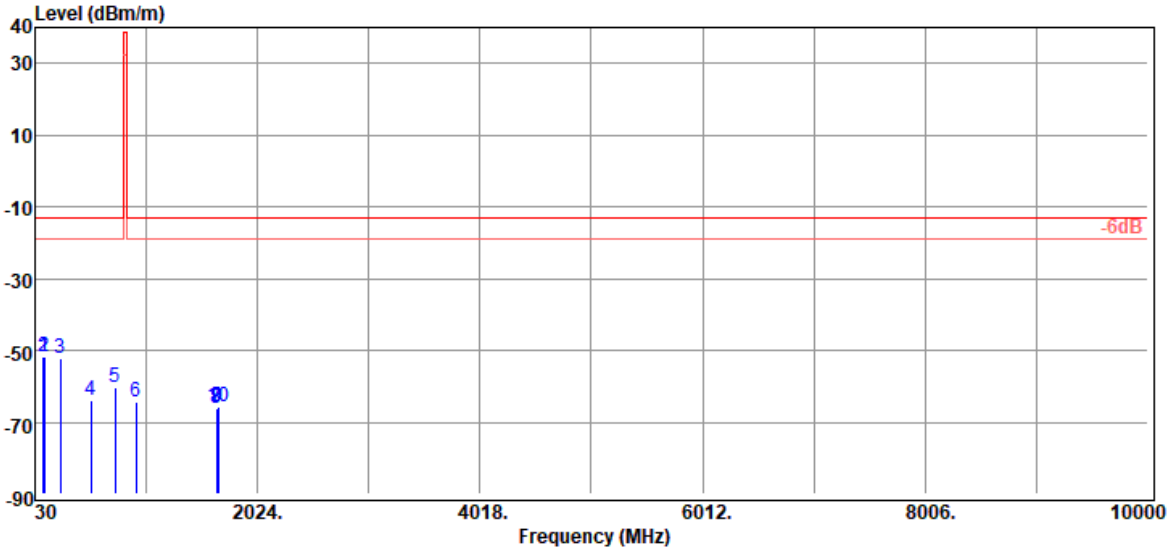

Freq. MHz	EIRP/ERP dBm	SG Output Level dBm	Antenna Gain dBi/dBd	Cable Loss dB	Limit dBm	Margin dB
105.66	-51.86	-43.63	-6.83	-1.40	-13.00	-38.86
115.36	-51.86	-43.27	-7.14	-1.45	-13.00	-38.86
257.95	-52.17	-48.38	-1.53	-2.26	-13.00	-39.17
532.46	-63.87	-59.42	-1.21	-3.24	-13.00	-50.87
747.80	-60.16	-54.35	-1.62	-4.19	-13.00	-47.16
937.92	-64.47	-57.95	-1.70	-4.82	-13.00	-51.47
1653.60	-65.94	-67.73	9.34	-7.55	-13.00	-52.94
1653.60	-65.94	-67.73	9.34	-7.55	-13.00	-52.94
1668.00	-65.82	-67.65	9.48	-7.65	-13.00	-52.82
1668.00	-65.82	-67.65	9.48	-7.65	-13.00	-52.82

Unless otherwise stated the results shown in this test report refer only to the sample(s) tested and such sample(s) are retained for 90 days only.

除非另有說明，此報告結果僅對測試之樣品負責，同時此樣品僅保留90天。本報告未經本公司書面許可，不可部份複製。

This document is issued by the Company subject to its General Conditions of Service printed overleaf, available on request or accessible at <http://www.sgs.com.tw/Terms-and-Conditions> and for electronic format documents, subject to Terms and Conditions for Electronic Documents at <http://www.sgs.com.tw/Terms-and-Conditions>. Attention is drawn to the limitation of liability, indemnification and jurisdiction issues defined therein. Any holder of this document is advised that information contained hereon reflects the Company's findings at the time of its intervention only and within the limits of Client's instructions, if any. The Company's sole responsibility is to its Client and this document does not exonerate parties to a transaction from exercising all their rights and obligations under the transaction documents. This document cannot be reproduced except in full, without prior written approval of the Company. Any unauthorized alteration, forgery or falsification of the content or appearance of this document is unlawful and offenders may be prosecuted to the fullest extent of the law.

Report Number :E2/2019/A0032
Operation Mode :LTE B5B
Test Mode :TX CH MID
EUT Pol :E2 Plan
Test Frequency :831.8+839 MHz

Test Date :2020-04-13
Temp./Humi. :24.3/58
Antenna Pol. :VERTICAL
Engineer :Enzo

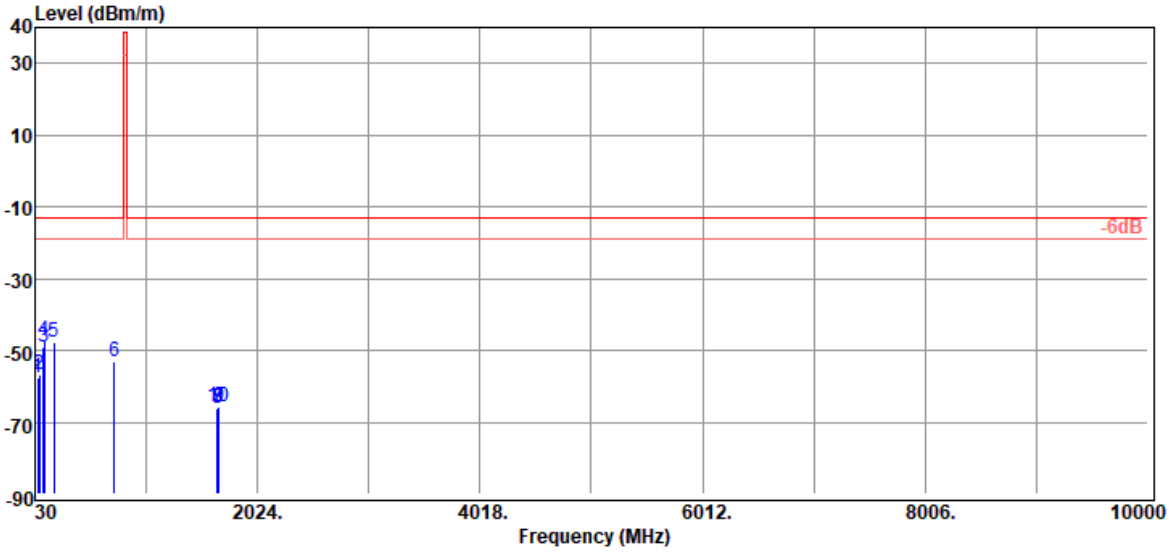

Freq. MHz	EIRP/ERP dBm	SG Output Level dBm	Antenna Gain dBi/dBd	Cable Loss dB	Limit dBm	Margin dB
56.19	-57.58	-40.38	-16.25	-0.95	-13.00	-44.58
72.68	-56.80	-44.82	-10.94	-1.04	-13.00	-43.80
105.66	-49.01	-40.78	-6.83	-1.40	-13.00	-36.01
116.33	-47.43	-38.85	-7.13	-1.45	-13.00	-34.43
202.66	-47.92	-43.84	-2.00	-2.08	-13.00	-34.92
742.95	-53.29	-47.52	-1.58	-4.19	-13.00	-40.29
1663.60	-65.94	-67.76	9.44	-7.62	-13.00	-52.94
1663.60	-65.94	-67.76	9.44	-7.62	-13.00	-52.94
1678.00	-65.76	-67.63	9.58	-7.71	-13.00	-52.76
1678.00	-65.76	-67.63	9.58	-7.71	-13.00	-52.76

Unless otherwise stated the results shown in this test report refer only to the sample(s) tested and such sample(s) are retained for 90 days only.

除非另有說明，此報告結果僅對測試之樣品負責，同時此樣品僅保留90天。本報告未經本公司書面許可，不可部份複製。

This document is issued by the Company subject to its General Conditions of Service printed overleaf, available on request or accessible at <http://www.sgs.com.tw/Terms-and-Conditions> and for electronic format documents, subject to Terms and Conditions for Electronic Documents at <http://www.sgs.com.tw/Terms-and-Conditions>. Attention is drawn to the limitation of liability, indemnification and jurisdiction issues defined therein. Any holder of this document is advised that information contained hereon reflects the Company's findings at the time of its intervention only and within the limits of Client's instructions, if any. The Company's sole responsibility is to its Client and this document does not exonerate parties to a transaction from exercising all their rights and obligations under the transaction documents. This document cannot be reproduced except in full, without prior written approval of the Company. Any unauthorized alteration, forgery or falsification of the content or appearance of this document is unlawful and offenders may be prosecuted to the fullest extent of the law.

Report Number :E2/2019/A0032
 Operation Mode :LTE B5B
 Test Mode :TX CH MID
 EUT Pol :E2 Plan
 Test Frequency :831.8+839 MHz

Test Date :2020-04-13
 Temp./Humi. :24.3/58
 Antenna Pol. :HORIZONTAL
 Engineer :Enzo

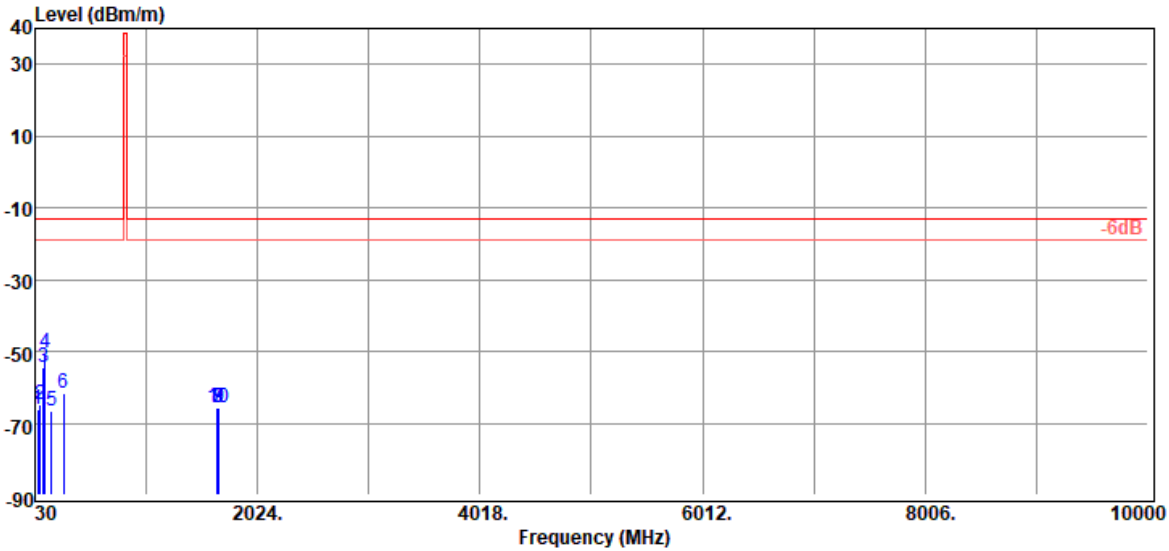

Freq. MHz	EIRP/ERP dBm	SG Output Level dBm	Antenna Gain dBi/dBd	Cable Loss dB	Limit dBm	Margin dB
55.22	-66.28	-48.87	-16.48	-0.93	-13.00	-53.28
74.62	-64.78	-53.55	-10.16	-1.07	-13.00	-51.78
105.66	-54.37	-46.14	-6.83	-1.40	-13.00	-41.37
117.30	-50.62	-42.08	-7.09	-1.45	-13.00	-37.62
174.53	-66.47	-59.28	-5.45	-1.74	-13.00	-53.47
284.14	-61.59	-57.49	-1.65	-2.45	-13.00	-48.59
1663.60	-65.73	-67.55	9.44	-7.62	-13.00	-52.73
1663.60	-65.73	-67.55	9.44	-7.62	-13.00	-52.73
1678.00	-65.79	-67.66	9.58	-7.71	-13.00	-52.79
1678.00	-65.79	-67.66	9.58	-7.71	-13.00	-52.79

Unless otherwise stated the results shown in this test report refer only to the sample(s) tested and such sample(s) are retained for 90 days only.

除非另有說明，此報告結果僅對測試之樣品負責，同時此樣品僅保留90天。本報告未經本公司書面許可，不可部份複製。

This document is issued by the Company subject to its General Conditions of Service printed overleaf, available on request or accessible at <http://www.sgs.com.tw/Terms-and-Conditions> and for electronic format documents, subject to Terms and Conditions for Electronic Documents at <http://www.sgs.com.tw/Terms-and-Conditions>. Attention is drawn to the limitation of liability, indemnification and jurisdiction issues defined therein. Any holder of this document is advised that information contained hereon reflects the Company's findings at the time of its intervention only and within the limits of Client's instructions, if any. The Company's sole responsibility is to its Client and this document does not exonerate parties to a transaction from exercising all their rights and obligations under the transaction documents. This document cannot be reproduced except in full, without prior written approval of the Company. Any unauthorized alteration, forgery or falsification of the content or appearance of this document is unlawful and offenders may be prosecuted to the fullest extent of the law.

Report Number :E2/2019/A0032
 Operation Mode :LTE B5B
 Test Mode :TX CH HIGH
 EUT Pol :E2 Plan
 Test Frequency :836.8+844 MHz

Test Date :2020-04-13
 Temp./Humi. :24.3/58
 Antenna Pol. :VERTICAL
 Engineer :Enzo

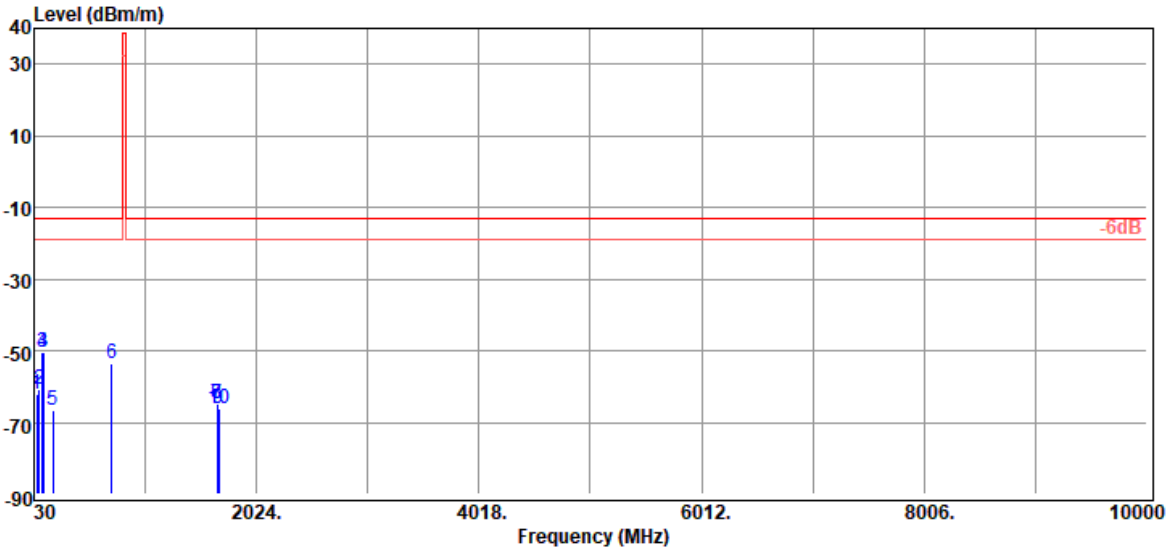

Freq. MHz	EIRP/ERP dBm	SG Output Level dBm	Antenna Gain dBi/dBd	Cable Loss dB	Limit dBm	Margin dB
54.25	-61.93	-44.28	-16.73	-0.92	-13.00	-48.93
77.53	-60.55	-50.28	-9.15	-1.12	-13.00	-47.55
105.66	-50.42	-42.19	-6.83	-1.40	-13.00	-37.42
112.45	-50.43	-41.81	-7.17	-1.45	-13.00	-37.43
197.81	-66.58	-62.31	-2.24	-2.03	-13.00	-53.58
729.37	-53.68	-47.94	-1.46	-4.28	-13.00	-40.68
1673.60	-64.82	-66.68	9.54	-7.68	-13.00	-51.82
1673.60	-64.82	-66.68	9.54	-7.68	-13.00	-51.82
1688.00	-65.97	-67.88	9.68	-7.77	-13.00	-52.97
1688.00	-65.97	-67.88	9.68	-7.77	-13.00	-52.97

Unless otherwise stated the results shown in this test report refer only to the sample(s) tested and such sample(s) are retained for 90 days only.

除非另有說明，此報告結果僅對測試之樣品負責，同時此樣品僅保留90天。本報告未經本公司書面許可，不可部份複製。

This document is issued by the Company subject to its General Conditions of Service printed overleaf, available on request or accessible at <http://www.sgs.com.tw/Terms-and-Conditions> and for electronic format documents, subject to Terms and Conditions for Electronic Documents at <http://www.sgs.com.tw/Terms-and-Conditions>. Attention is drawn to the limitation of liability, indemnification and jurisdiction issues defined therein. Any holder of this document is advised that information contained hereon reflects the Company's findings at the time of its intervention only and within the limits of Client's instructions, if any. The Company's sole responsibility is to its Client and this document does not exonerate parties to a transaction from exercising all their rights and obligations under the transaction documents. This document cannot be reproduced except in full, without prior written approval of the Company. Any unauthorized alteration, forgery or falsification of the content or appearance of this document is unlawful and offenders may be prosecuted to the fullest extent of the law.

Report Number :E2/2019/A0032
 Operation Mode :LTE B5B
 Test Mode :TX CH HIGH
 EUT Pol :E2 Plan
 Test Frequency :836.8+844 MHz

Test Date :2020-04-13
 Temp./Humi. :24.3/58
 Antenna Pol. :HORIZONTAL
 Engineer :Enzo

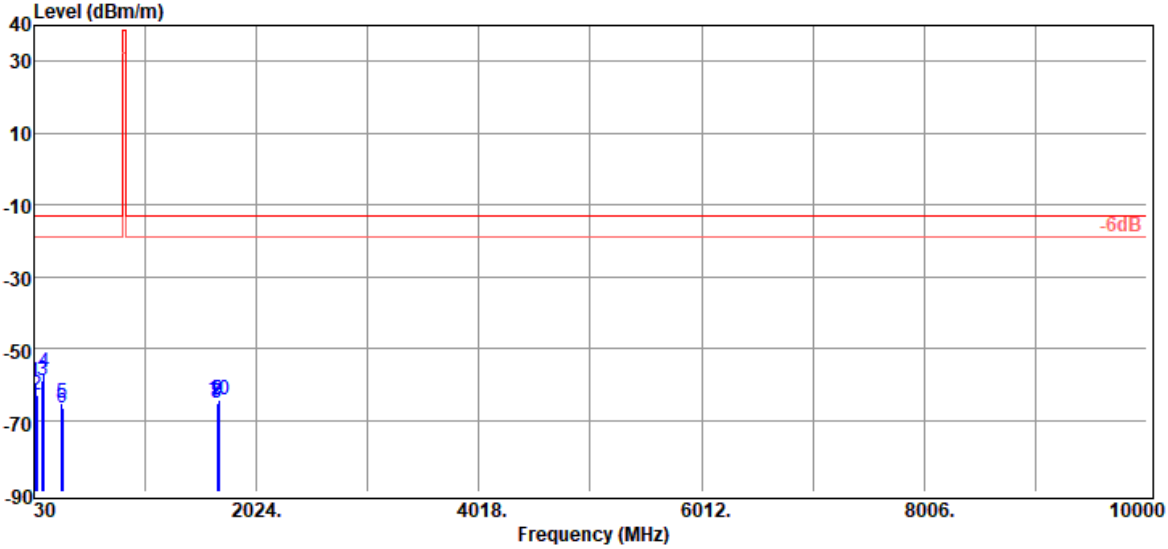

Freq. MHz	EIRP/ERP dBm	SG Output Level dBm	Antenna Gain dBi/dBd	Cable Loss dB	Limit dBm	Margin dB
39.70	-59.59	-39.60	-19.14	-0.85	-13.00	-46.59
56.19	-63.10	-45.90	-16.25	-0.95	-13.00	-50.10
105.66	-58.91	-50.68	-6.83	-1.40	-13.00	-45.91
118.27	-56.84	-48.31	-7.08	-1.45	-13.00	-43.84
277.35	-65.30	-61.26	-1.67	-2.37	-13.00	-52.30
286.08	-66.64	-62.52	-1.65	-2.47	-13.00	-53.64
1673.60	-65.38	-67.24	9.54	-7.68	-13.00	-52.38
1673.60	-65.38	-67.24	9.54	-7.68	-13.00	-52.38
1688.00	-64.36	-66.27	9.68	-7.77	-13.00	-51.36
1688.00	-64.36	-66.27	9.68	-7.77	-13.00	-51.36

Unless otherwise stated the results shown in this test report refer only to the sample(s) tested and such sample(s) are retained for 90 days only.

除非另有說明，此報告結果僅對測試之樣品負責，同時此樣品僅保留90天。本報告未經本公司書面許可，不可部份複製。

This document is issued by the Company subject to its General Conditions of Service printed overleaf, available on request or accessible at <http://www.sgs.com.tw/Terms-and-Conditions> and for electronic format documents, subject to Terms and Conditions for Electronic Documents at <http://www.sgs.com.tw/Terms-and-Conditions>. Attention is drawn to the limitation of liability, indemnification and jurisdiction issues defined therein. Any holder of this document is advised that information contained hereon reflects the Company's findings at the time of its intervention only and within the limits of Client's instructions, if any. The Company's sole responsibility is to its Client and this document does not exonerate parties to a transaction from exercising all their rights and obligations under the transaction documents. This document cannot be reproduced except in full, without prior written approval of the Company. Any unauthorized alteration, forgery or falsification of the content or appearance of this document is unlawful and offenders may be prosecuted to the fullest extent of the law.

Radiated Spurious Emission Measurement Result: LTE Band 7C Mode

Report Number	:E2/2019/A0032	Test Date	:2020-03-18
Operation Mode	:LTE B7C	Temp./Humi.	:23.7/58
Test Mode	:TX CH LOW	Antenna Pol.	:VERTICAL
EUT Pol	:E2 Plan	Engineer	:Enzo
Test Frequency	:2510+2529.8 MHz		

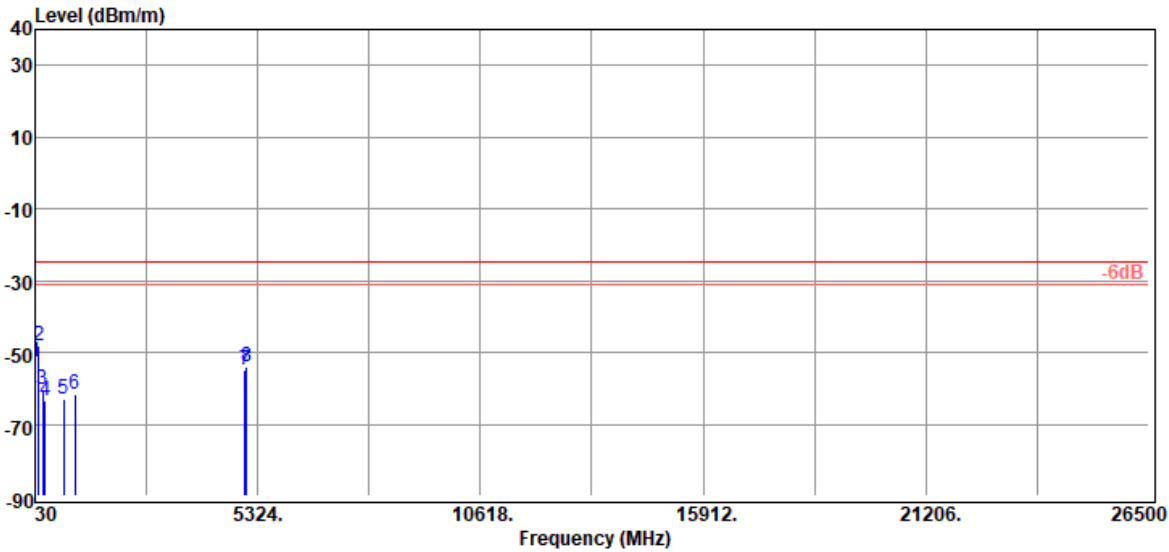

Freq. MHz	EIRP/ERP dBm	SG Output Level dBm	Antenna Gain dBi/dBd	Cable Loss dB	Limit dBm	Margin dB
48.43	-52.50	-33.75	-17.89	-0.86	-25.00	-27.50
118.27	-48.25	-39.72	-7.08	-1.45	-25.00	-23.25
205.57	-60.11	-56.16	-1.87	-2.08	-25.00	-35.11
272.50	-63.48	-59.54	-1.63	-2.31	-25.00	-38.48
716.76	-63.03	-57.77	-1.36	-3.90	-25.00	-38.03
973.81	-61.72	-55.01	-1.59	-5.12	-25.00	-36.72
5020.00	-54.88	-55.88	12.46	-11.46	-25.00	-29.88
5059.60	-54.02	-54.85	12.40	-11.57	-25.00	-29.02

Unless otherwise stated the results shown in this test report refer only to the sample(s) tested and such sample(s) are retained for 90 days only.

除非另有說明，此報告結果僅對測試之樣品負責，同時此樣品僅保留90天。本報告未經本公司書面許可，不可部份複製。

This document is issued by the Company subject to its General Conditions of Service printed overleaf, available on request or accessible at <http://www.sgs.com.tw/Terms-and-Conditions> and for electronic format documents, subject to Terms and Conditions for Electronic Documents at <http://www.sgs.com.tw/Terms-and-Conditions>. Attention is drawn to the limitation of liability, indemnification and jurisdiction issues defined therein. Any holder of this document is advised that information contained hereon reflects the Company's findings at the time of its intervention only and within the limits of Client's instructions, if any. The Company's sole responsibility is to its Client and this document does not exonerate parties to a transaction from exercising all their rights and obligations under the transaction documents. This document cannot be reproduced except in full, without prior written approval of the Company. Any unauthorized alteration, forgery or falsification of the content or appearance of this document is unlawful and offenders may be prosecuted to the fullest extent of the law.

Report Number :E2/2019/A0032
 Operation Mode :LTE B7C
 Test Mode :TX CH LOW
 EUT Pol :E2 Plan
 Test Frequency :2510+2529.8 MHz

Test Date :2020-03-18
 Temp./Humi. :23.7/58
 Antenna Pol. :HORIZONTAL
 Engineer :Enzo

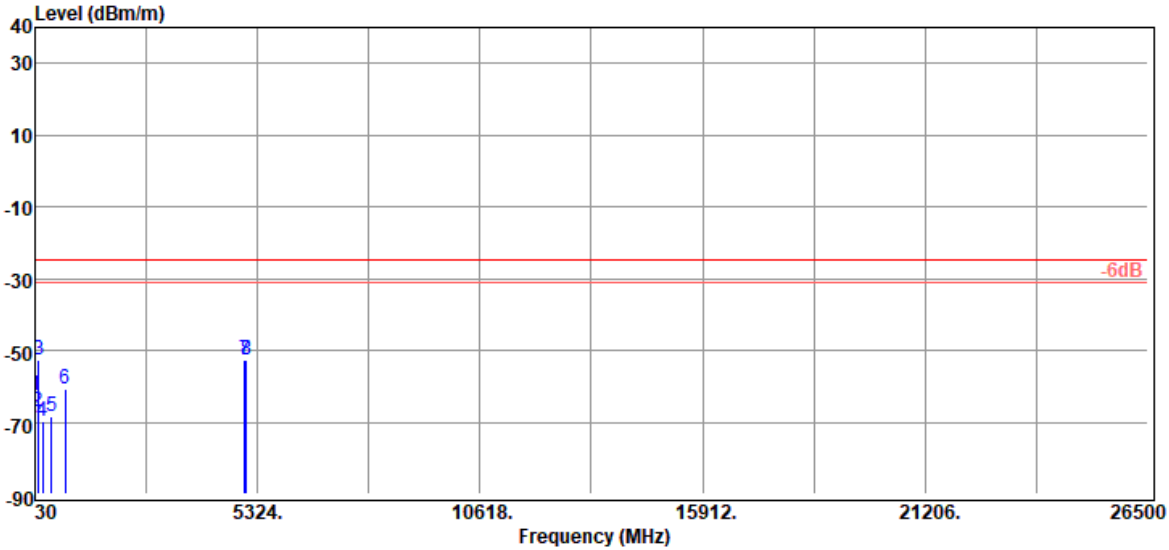

Freq. MHz	EIRP/ERP dBm	SG Output Level dBm	Antenna Gain dBi/dBd	Cable Loss dB	Limit dBm	Margin dB
31.94	-62.46	-41.44	-20.36	-0.66	-25.00	-37.46
91.11	-66.88	-59.85	-5.85	-1.18	-25.00	-41.88
119.24	-52.79	-44.30	-7.04	-1.45	-25.00	-27.79
204.60	-69.64	-65.64	-1.92	-2.08	-25.00	-44.64
417.03	-68.23	-63.79	-1.28	-3.16	-25.00	-43.23
747.80	-60.58	-54.77	-1.62	-4.19	-25.00	-35.58
5020.00	-52.56	-53.56	12.46	-11.46	-25.00	-27.56
5059.60	-52.76	-53.59	12.40	-11.57	-25.00	-27.76

Unless otherwise stated the results shown in this test report refer only to the sample(s) tested and such sample(s) are retained for 90 days only.

除非另有說明，此報告結果僅對測試之樣品負責，同時此樣品僅保留90天。本報告未經本公司書面許可，不可部份複製。

This document is issued by the Company subject to its General Conditions of Service printed overleaf, available on request or accessible at <http://www.sgs.com.tw/Terms-and-Conditions> and for electronic format documents, subject to Terms and Conditions for Electronic Documents at <http://www.sgs.com.tw/Terms-and-Conditions>. Attention is drawn to the limitation of liability, indemnification and jurisdiction issues defined therein. Any holder of this document is advised that information contained hereon reflects the Company's findings at the time of its intervention only and within the limits of Client's instructions, if any. The Company's sole responsibility is to its Client and this document does not exonerate parties to a transaction from exercising all their rights and obligations under the transaction documents. This document cannot be reproduced except in full, without prior written approval of the Company. Any unauthorized alteration, forgery or falsification of the content or appearance of this document is unlawful and offenders may be prosecuted to the fullest extent of the law.

SGS Taiwan Ltd.

台灣檢驗科技股份有限公司

No.134,Wu Kung Road, New Taipei Industrial Park, Wuku District, New Taipei City, Taiwan/新北市五股區新北產業園區五工路 134 號

t (886-2) 2299-3279

f (886-2) 2298-0488

www.sgs.com.tw

Member of SGS Group

Report Number :E2/2019/A0032
 Operation Mode :LTE B7C
 Test Mode :TX CH MID
 EUT Pol :E2 Plan
 Test Frequency :2525.1+2544.9 MHz

Test Date :2020-03-18
 Temp./Humi. :23.7/58
 Antenna Pol. :VERTICAL
 Engineer :Enzo

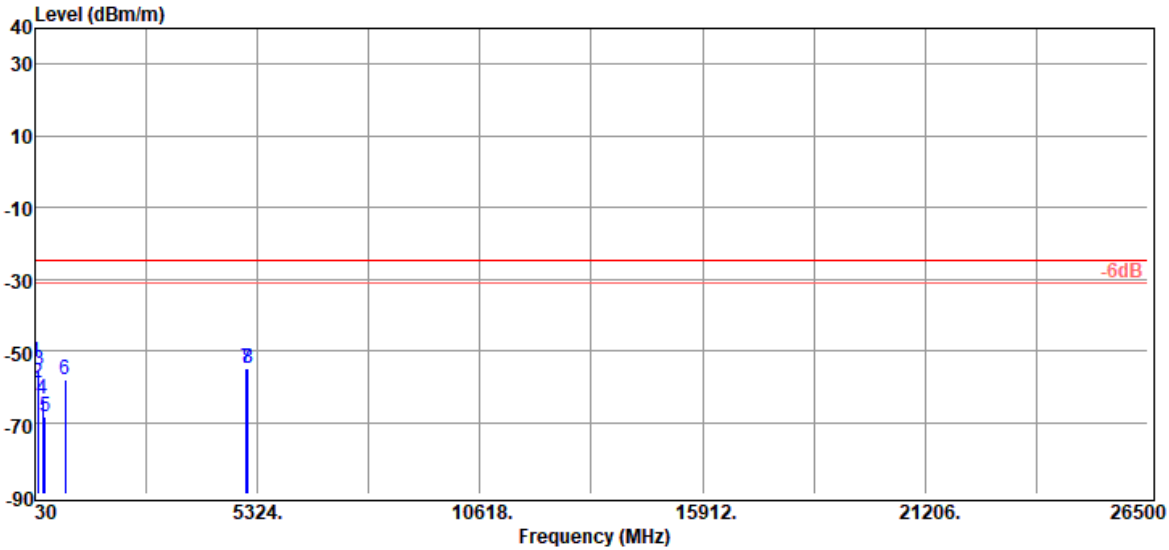

Freq. MHz	EIRP/ERP dBm	SG Output Level dBm	Antenna Gain dBi/dBd	Cable Loss dB	Limit dBm	Margin dB
46.49	-53.08	-33.93	-18.29	-0.86	-25.00	-28.08
101.78	-58.79	-51.00	-6.44	-1.35	-25.00	-33.79
118.27	-55.49	-46.96	-7.08	-1.45	-25.00	-30.49
207.51	-63.28	-59.45	-1.75	-2.08	-25.00	-38.28
274.44	-68.29	-64.31	-1.65	-2.33	-25.00	-43.29
747.80	-57.88	-52.07	-1.62	-4.19	-25.00	-32.88
5050.20	-54.73	-55.59	12.40	-11.54	-25.00	-29.73
5089.80	-54.76	-55.51	12.40	-11.65	-25.00	-29.76

Unless otherwise stated the results shown in this test report refer only to the sample(s) tested and such sample(s) are retained for 90 days only.

除非另有說明，此報告結果僅對測試之樣品負責，同時此樣品僅保留90天。本報告未經本公司書面許可，不可部份複製。

This document is issued by the Company subject to its General Conditions of Service printed overleaf, available on request or accessible at <http://www.sgs.com.tw/Terms-and-Conditions> and for electronic format documents, subject to Terms and Conditions for Electronic Documents at <http://www.sgs.com.tw/Terms-and-Conditions>. Attention is drawn to the limitation of liability, indemnification and jurisdiction issues defined therein. Any holder of this document is advised that information contained hereon reflects the Company's findings at the time of its intervention only and within the limits of Client's instructions, if any. The Company's sole responsibility is to its Client and this document does not exonerate parties to a transaction from exercising all their rights and obligations under the transaction documents. This document cannot be reproduced except in full, without prior written approval of the Company. Any unauthorized alteration, forgery or falsification of the content or appearance of this document is unlawful and offenders may be prosecuted to the fullest extent of the law.

Report Number :E2/2019/A0032
 Operation Mode :LTE B7C
 Test Mode :TX CH MID
 EUT Pol :E2 Plan
 Test Frequency :2525.1+2544.9 MHz

Test Date :2020-03-18
 Temp./Humi. :23.7/58
 Antenna Pol. :HORIZONTAL
 Engineer :Enzo

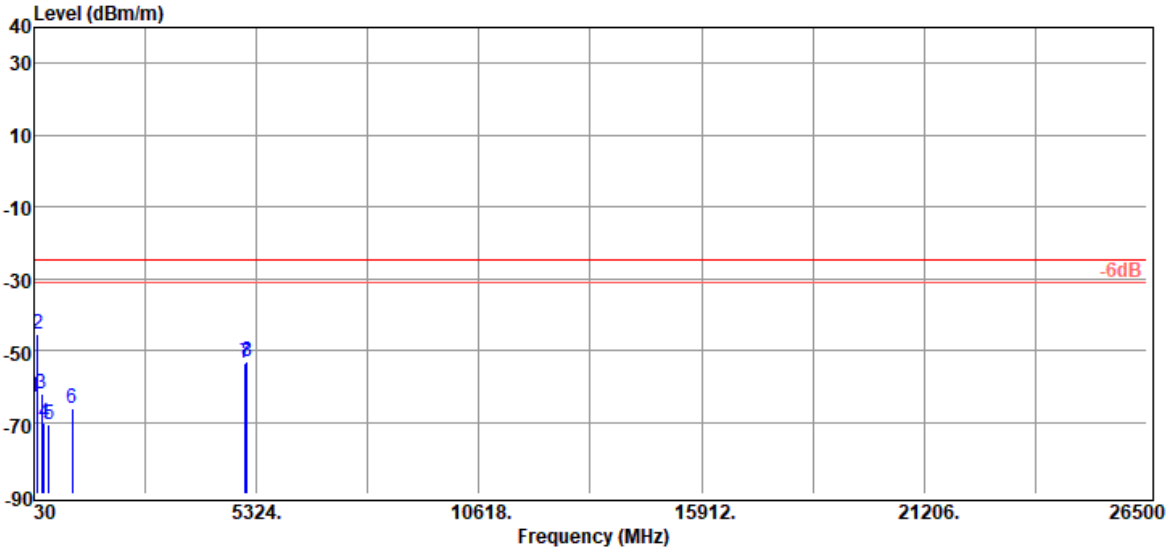

Freq. MHz	EIRP/ERP dBm	SG Output Level dBm	Antenna Gain dBi/dBd	Cable Loss dB	Limit dBm	Margin dB
37.76	-63.14	-42.99	-19.35	-0.80	-25.00	-38.14
119.24	-45.57	-37.08	-7.04	-1.45	-25.00	-20.57
206.54	-62.29	-58.40	-1.81	-2.08	-25.00	-37.29
274.44	-69.99	-66.01	-1.65	-2.33	-25.00	-44.99
375.32	-70.45	-66.02	-1.56	-2.87	-25.00	-45.45
935.98	-65.96	-59.41	-1.71	-4.84	-25.00	-40.96
5050.20	-53.46	-54.32	12.40	-11.54	-25.00	-28.46
5089.80	-53.13	-53.88	12.40	-11.65	-25.00	-28.13

Unless otherwise stated the results shown in this test report refer only to the sample(s) tested and such sample(s) are retained for 90 days only.

除非另有說明，此報告結果僅對測試之樣品負責，同時此樣品僅保留90天。本報告未經本公司書面許可，不可部份複製。

This document is issued by the Company subject to its General Conditions of Service printed overleaf, available on request or accessible at <http://www.sgs.com.tw/Terms-and-Conditions> and for electronic format documents, subject to Terms and Conditions for Electronic Documents at <http://www.sgs.com.tw/Terms-and-Conditions>. Attention is drawn to the limitation of liability, indemnification and jurisdiction issues defined therein. Any holder of this document is advised that information contained hereon reflects the Company's findings at the time of its intervention only and within the limits of Client's instructions, if any. The Company's sole responsibility is to its Client and this document does not exonerate parties to a transaction from exercising all their rights and obligations under the transaction documents. This document cannot be reproduced except in full, without prior written approval of the Company. Any unauthorized alteration, forgery or falsification of the content or appearance of this document is unlawful and offenders may be prosecuted to the fullest extent of the law.

Report Number :E2/2019/A0032
 Operation Mode :LTE B7C
 Test Mode :TX CH HIGH
 EUT Pol :E2 Plan
 Test Frequency :2540.2+2560 MHz

Test Date :2020-03-18
 Temp./Humi. :23.7/58
 Antenna Pol. :VERTICAL
 Engineer :Enzo

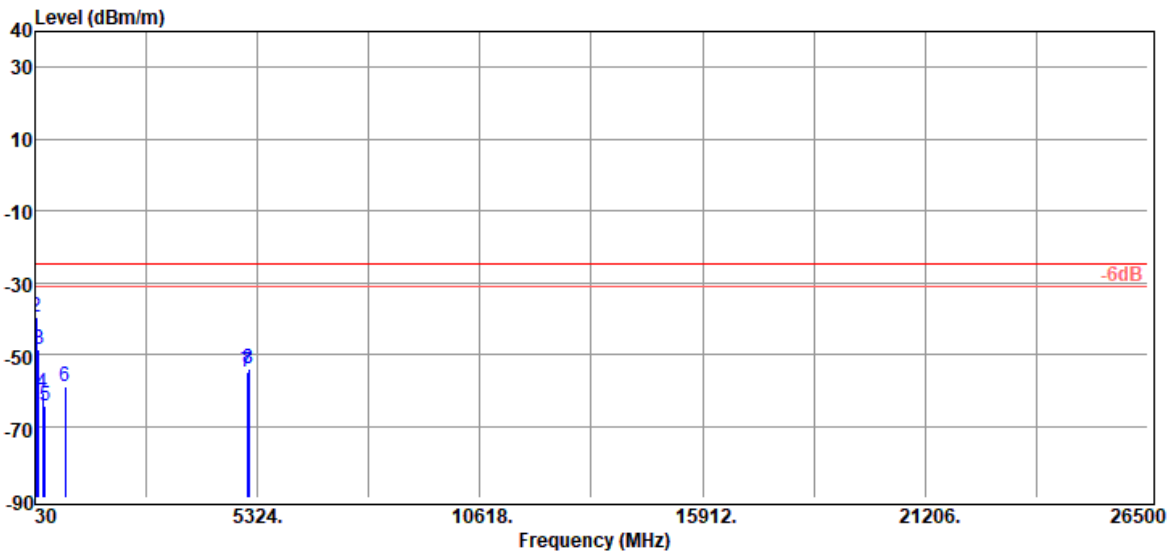

Freq. MHz	EIRP/ERP dBm	SG Output Level dBm	Antenna Gain dBi/dBd	Cable Loss dB	Limit dBm	Margin dB
36.79	-54.58	-34.37	-19.43	-0.78	-25.00	-29.58
49.40	-39.79	-21.20	-17.73	-0.86	-25.00	-14.79
118.27	-48.72	-40.19	-7.08	-1.45	-25.00	-23.72
206.54	-60.60	-56.71	-1.81	-2.08	-25.00	-35.60
274.44	-64.49	-60.51	-1.65	-2.33	-25.00	-39.49
746.83	-58.88	-53.08	-1.61	-4.19	-25.00	-33.88
5080.40	-54.92	-55.69	12.40	-11.63	-25.00	-29.92
5120.00	-54.17	-54.87	12.44	-11.74	-25.00	-29.17

Unless otherwise stated the results shown in this test report refer only to the sample(s) tested and such sample(s) are retained for 90 days only.

除非另有說明，此報告結果僅對測試之樣品負責，同時此樣品僅保留90天。本報告未經本公司書面許可，不可部份複製。

This document is issued by the Company subject to its General Conditions of Service printed overleaf, available on request or accessible at <http://www.sgs.com.tw/Terms-and-Conditions> and for electronic format documents, subject to Terms and Conditions for Electronic Documents at <http://www.sgs.com.tw/Terms-and-Conditions>. Attention is drawn to the limitation of liability, indemnification and jurisdiction issues defined therein. Any holder of this document is advised that information contained hereon reflects the Company's findings at the time of its intervention only and within the limits of Client's instructions, if any. The Company's sole responsibility is to its Client and this document does not exonerate parties to a transaction from exercising all their rights and obligations under the transaction documents. This document cannot be reproduced except in full, without prior written approval of the Company. Any unauthorized alteration, forgery or falsification of the content or appearance of this document is unlawful and offenders may be prosecuted to the fullest extent of the law.

SGS Taiwan Ltd.

台灣檢驗科技股份有限公司

No.134,Wu Kung Road, New Taipei Industrial Park, Wuku District, New Taipei City, Taiwan/新北市五股區新北產業園區五工路 134 號

t (886-2) 2299-3279

f (886-2) 2298-0488

www.sgs.com.tw

Member of SGS Group

Report Number :E2/2019/A0032
 Operation Mode :LTE B7C
 Test Mode :TX CH HIGH
 EUT Pol :E2 Plan
 Test Frequency :2540.2+2560 MHz

Test Date :2020-03-18
 Temp./Humi. :23.7/58
 Antenna Pol. :HORIZONTAL
 Engineer :Enzo

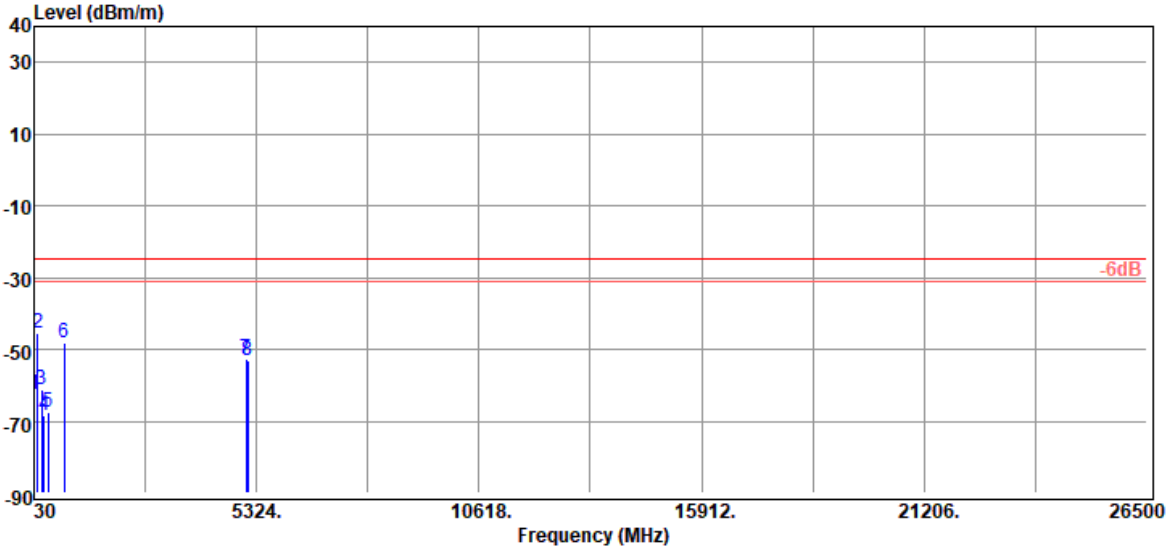

Freq. MHz	EIRP/ERP dBm	SG Output Level dBm	Antenna Gain dBi/dBd	Cable Loss dB	Limit dBm	Margin dB
46.49	-62.43	-43.28	-18.29	-0.86	-25.00	-37.43
119.24	-45.27	-36.78	-7.04	-1.45	-25.00	-20.27
206.54	-61.02	-57.13	-1.81	-2.08	-25.00	-36.02
273.47	-68.18	-64.22	-1.64	-2.32	-25.00	-43.18
365.62	-67.46	-63.20	-1.49	-2.77	-25.00	-42.46
741.01	-48.32	-42.56	-1.57	-4.19	-25.00	-23.32
5080.40	-52.57	-53.34	12.40	-11.63	-25.00	-27.57
5120.00	-53.21	-53.91	12.44	-11.74	-25.00	-28.21

Unless otherwise stated the results shown in this test report refer only to the sample(s) tested and such sample(s) are retained for 90 days only.

除非另有說明，此報告結果僅對測試之樣品負責，同時此樣品僅保留90天。本報告未經本公司書面許可，不可部份複製。

This document is issued by the Company subject to its General Conditions of Service printed overleaf, available on request or accessible at <http://www.sgs.com.tw/Terms-and-Conditions> and for electronic format documents, subject to Terms and Conditions for Electronic Documents at <http://www.sgs.com.tw/Terms-and-Conditions>. Attention is drawn to the limitation of liability, indemnification and jurisdiction issues defined therein. Any holder of this document is advised that information contained hereon reflects the Company's findings at the time of its intervention only and within the limits of Client's instructions, if any. The Company's sole responsibility is to its Client and this document does not exonerate parties to a transaction from exercising all their rights and obligations under the transaction documents. This document cannot be reproduced except in full, without prior written approval of the Company. Any unauthorized alteration, forgery or falsification of the content or appearance of this document is unlawful and offenders may be prosecuted to the fullest extent of the law.

Radiated Spurious Emission Measurement Result: LTE Band 41C Mode

Report Number	:E2/2019/A0032	Test Date	:2020-03-17
Operation Mode	:LTE B41C	Temp./Humi.	:23.5/57
Test Mode	:TX CH LOW	Antenna Pol.	:VERTICAL
EUT Pol	:E2 Plan	Engineer	:Enzo
Test Frequency	:2499.3+2511 MHz		

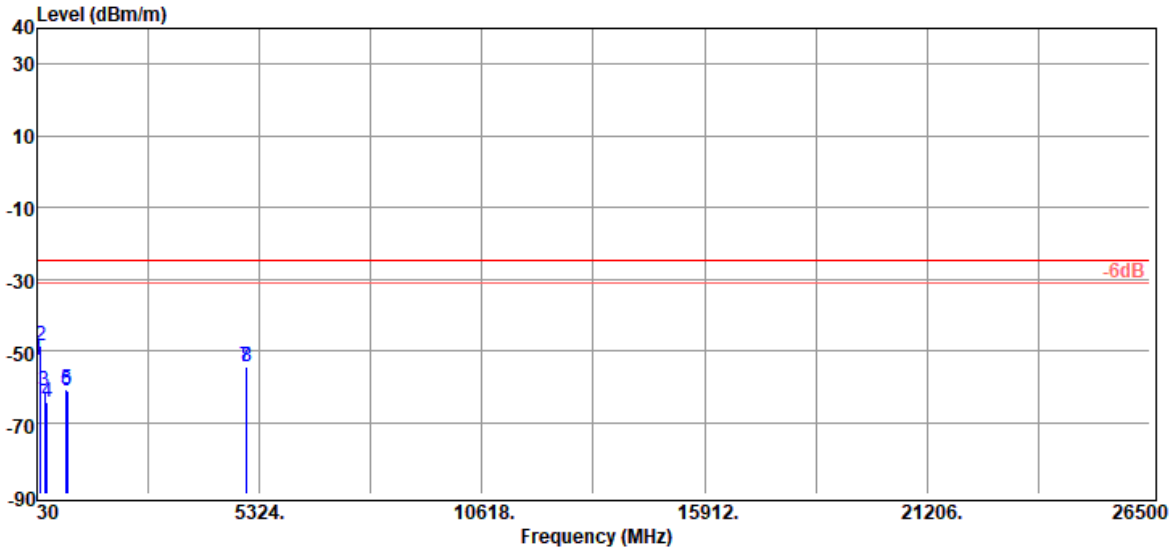

Freq. MHz	EIRP/ERP dBm	SG Output Level dBm	Antenna Gain dBi/dBd	Cable Loss dB	Limit dBm	Margin dB
48.43	-52.70	-33.95	-17.89	-0.86	-25.00	-27.70
118.27	-48.76	-40.23	-7.08	-1.45	-25.00	-23.76
206.54	-61.13	-57.24	-1.81	-2.08	-25.00	-36.13
273.47	-64.25	-60.29	-1.64	-2.32	-25.00	-39.25
734.22	-60.74	-55.06	-1.42	-4.26	-25.00	-35.74
747.80	-61.34	-55.53	-1.62	-4.19	-25.00	-36.34
4998.60	-54.28	-55.38	12.51	-11.41	-25.00	-29.28
5022.00	-54.44	-55.44	12.46	-11.46	-25.00	-29.44

Unless otherwise stated the results shown in this test report refer only to the sample(s) tested and such sample(s) are retained for 90 days only.

除非另有說明，此報告結果僅對測試之樣品負責，同時此樣品僅保留90天。本報告未經本公司書面許可，不可部份複製。

This document is issued by the Company subject to its General Conditions of Service printed overleaf, available on request or accessible at <http://www.sgs.com.tw/Terms-and-Conditions> and for electronic format documents, subject to Terms and Conditions for Electronic Documents at <http://www.sgs.com.tw/Terms-and-Conditions>. Attention is drawn to the limitation of liability, indemnification and jurisdiction issues defined therein. Any holder of this document is advised that information contained hereon reflects the Company's findings at the time of its intervention only and within the limits of Client's instructions, if any. The Company's sole responsibility is to its Client and this document does not exonerate parties to a transaction from exercising all their rights and obligations under the transaction documents. This document cannot be reproduced except in full, without prior written approval of the Company. Any unauthorized alteration, forgery or falsification of the content or appearance of this document is unlawful and offenders may be prosecuted to the fullest extent of the law.

SGS Taiwan Ltd.

台灣檢驗科技股份有限公司

No.134,Wu Kung Road, New Taipei Industrial Park, Wuku District, New Taipei City, Taiwan/新北市五股區新北產業園區五工路 134 號

t (886-2) 2299-3279

f (886-2) 2298-0488

www.sgs.com.tw

Member of SGS Group

Report Number :E2/2019/A0032
 Operation Mode :LTE B41C
 Test Mode :TX CH LOW
 EUT Pol :E2 Plan
 Test Frequency :2499.3+2511 MHz

Test Date :2020-03-17
 Temp./Humi. :23.5/57
 Antenna Pol. :HORIZONTAL
 Engineer :Enzo

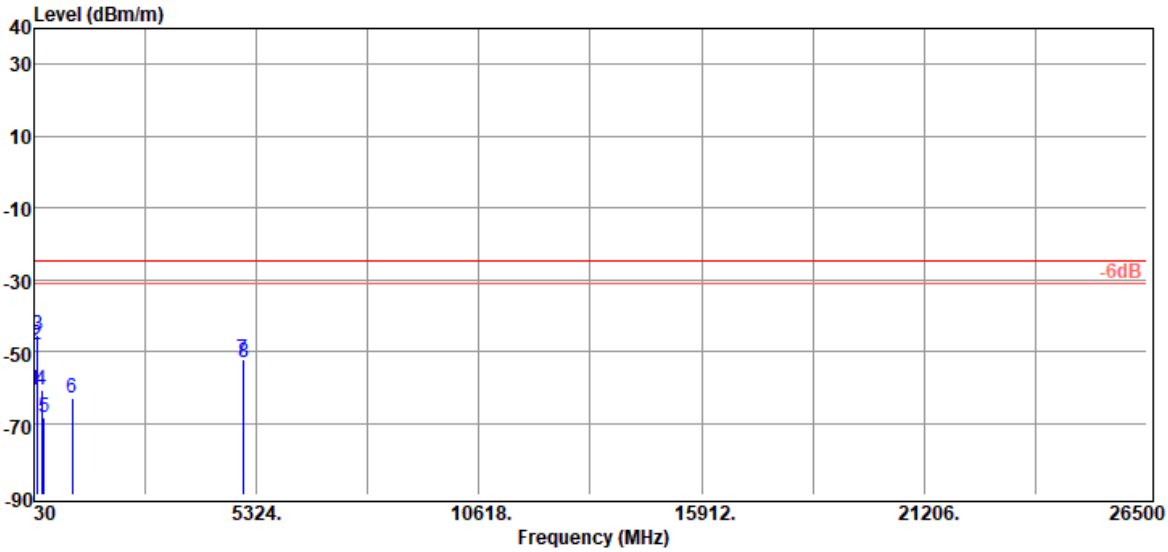

Freq. MHz	EIRP/ERP dBm	SG Output Level dBm	Antenna Gain dBi/dBd	Cable Loss dB	Limit dBm	Margin dB
44.55	-60.56	-41.19	-18.51	-0.86	-25.00	-35.56
99.84	-48.22	-40.67	-6.22	-1.33	-25.00	-23.22
119.24	-45.25	-36.76	-7.04	-1.45	-25.00	-20.25
205.57	-60.98	-57.03	-1.87	-2.08	-25.00	-35.98
274.44	-68.49	-64.51	-1.65	-2.33	-25.00	-43.49
947.62	-63.21	-56.75	-1.66	-4.80	-25.00	-38.21
4998.60	-52.28	-53.38	12.51	-11.41	-25.00	-27.28
5022.00	-52.89	-53.89	12.46	-11.46	-25.00	-27.89

Unless otherwise stated the results shown in this test report refer only to the sample(s) tested and such sample(s) are retained for 90 days only.

除非另有說明，此報告結果僅對測試之樣品負責，同時此樣品僅保留90天。本報告未經本公司書面許可，不可部份複製。

This document is issued by the Company subject to its General Conditions of Service printed overleaf, available on request or accessible at <http://www.sgs.com.tw/Terms-and-Conditions> and for electronic format documents, subject to Terms and Conditions for Electronic Documents at <http://www.sgs.com.tw/Terms-and-Conditions>. Attention is drawn to the limitation of liability, indemnification and jurisdiction issues defined therein. Any holder of this document is advised that information contained hereon reflects the Company's findings at the time of its intervention only and within the limits of Client's instructions, if any. The Company's sole responsibility is to its Client and this document does not exonerate parties to a transaction from exercising all their rights and obligations under the transaction documents. This document cannot be reproduced except in full, without prior written approval of the Company. Any unauthorized alteration, forgery or falsification of the content or appearance of this document is unlawful and offenders may be prosecuted to the fullest extent of the law.

Report Number :E2/2019/A0032
 Operation Mode :LTE B41C
 Test Mode :TX CH MID
 EUT Pol :E2 Plan
 Test Frequency :2583.8+2595.5 MHz

Test Date :2020-03-17
 Temp./Humi. :23.5/57
 Antenna Pol. :VERTICAL
 Engineer :Enzo

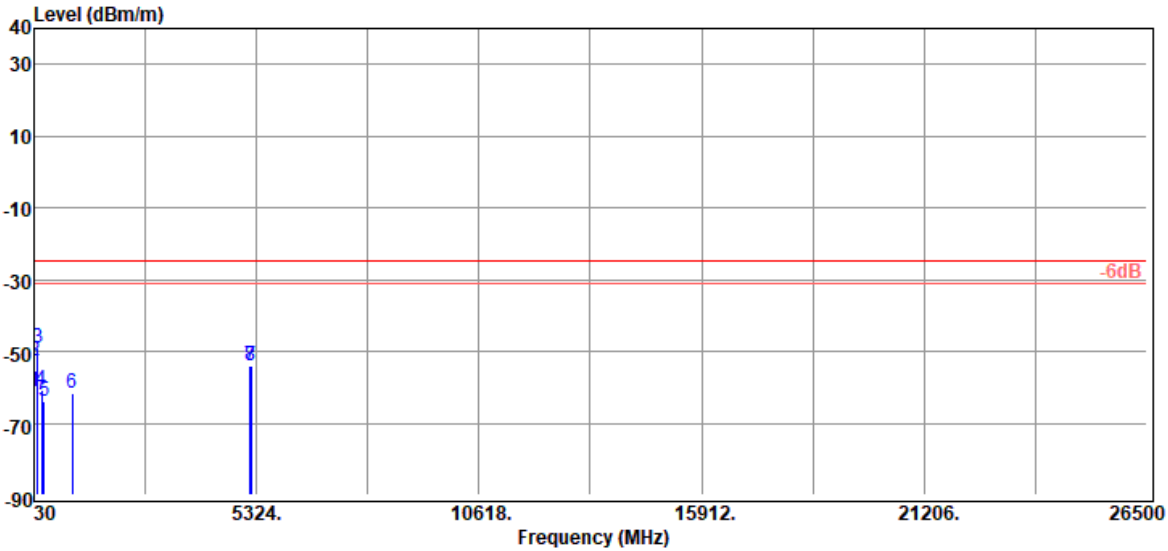

Freq. MHz	EIRP/ERP dBm	SG Output Level dBm	Antenna Gain dBi/dBd	Cable Loss dB	Limit dBm	Margin dB
36.79	-61.28	-41.07	-19.43	-0.78	-25.00	-36.28
48.43	-52.72	-33.97	-17.89	-0.86	-25.00	-27.72
118.27	-49.07	-40.54	-7.08	-1.45	-25.00	-24.07
206.54	-60.65	-56.76	-1.81	-2.08	-25.00	-35.65
276.38	-63.89	-59.87	-1.66	-2.36	-25.00	-38.89
946.65	-61.86	-55.41	-1.65	-4.80	-25.00	-36.86
5167.60	-54.14	-54.81	12.57	-11.90	-25.00	-29.14
5191.00	-53.84	-54.53	12.66	-11.97	-25.00	-28.84

Unless otherwise stated the results shown in this test report refer only to the sample(s) tested and such sample(s) are retained for 90 days only.

除非另有說明，此報告結果僅對測試之樣品負責，同時此樣品僅保留90天。本報告未經本公司書面許可，不可部份複製。

This document is issued by the Company subject to its General Conditions of Service printed overleaf, available on request or accessible at <http://www.sgs.com.tw/Terms-and-Conditions> and for electronic format documents, subject to Terms and Conditions for Electronic Documents at <http://www.sgs.com.tw/Terms-and-Conditions>. Attention is drawn to the limitation of liability, indemnification and jurisdiction issues defined therein. Any holder of this document is advised that information contained hereon reflects the Company's findings at the time of its intervention only and within the limits of Client's instructions, if any. The Company's sole responsibility is to its Client and this document does not exonerate parties to a transaction from exercising all their rights and obligations under the transaction documents. This document cannot be reproduced except in full, without prior written approval of the Company. Any unauthorized alteration, forgery or falsification of the content or appearance of this document is unlawful and offenders may be prosecuted to the fullest extent of the law.

Report Number :E2/2019/A0032
 Operation Mode :LTE B41C
 Test Mode :TX CH MID
 EUT Pol :E2 Plan
 Test Frequency :2583.8+2595.5 MHz

Test Date :2020-03-17
 Temp./Humi. :23.5/57
 Antenna Pol. :HORIZONTAL
 Engineer :Enzo

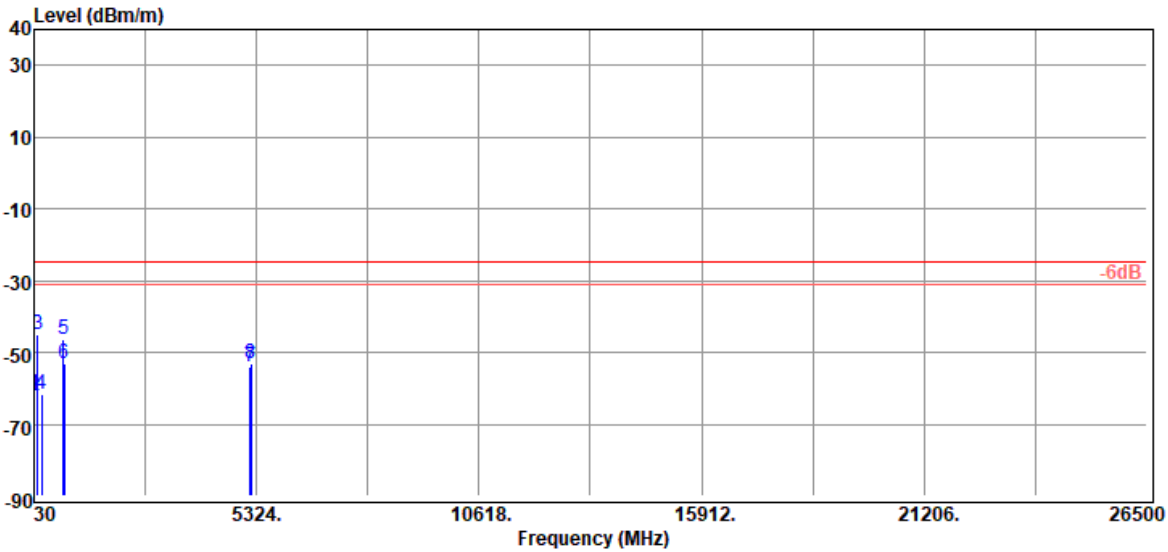

Freq. MHz	EIRP/ERP dBm	SG Output Level dBm	Antenna Gain dBi/dBd	Cable Loss dB	Limit dBm	Margin dB
32.91	-61.81	-41.04	-20.09	-0.68	-25.00	-36.81
45.52	-62.22	-42.98	-18.38	-0.86	-25.00	-37.22
118.27	-45.22	-36.69	-7.08	-1.45	-25.00	-20.22
206.54	-61.55	-57.66	-1.81	-2.08	-25.00	-36.55
734.22	-46.14	-40.46	-1.42	-4.26	-25.00	-21.14
746.83	-53.13	-47.33	-1.61	-4.19	-25.00	-28.13
5167.60	-54.08	-54.75	12.57	-11.90	-25.00	-29.08
5191.00	-53.22	-53.91	12.66	-11.97	-25.00	-28.22

Unless otherwise stated the results shown in this test report refer only to the sample(s) tested and such sample(s) are retained for 90 days only.

除非另有說明，此報告結果僅對測試之樣品負責，同時此樣品僅保留90天。本報告未經本公司書面許可，不可部份複製。

This document is issued by the Company subject to its General Conditions of Service printed overleaf, available on request or accessible at <http://www.sgs.com.tw/Terms-and-Conditions> and for electronic format documents, subject to Terms and Conditions for Electronic Documents at <http://www.sgs.com.tw/Terms-and-Conditions>. Attention is drawn to the limitation of liability, indemnification and jurisdiction issues defined therein. Any holder of this document is advised that information contained hereon reflects the Company's findings at the time of its intervention only and within the limits of Client's instructions, if any. The Company's sole responsibility is to its Client and this document does not exonerate parties to a transaction from exercising all their rights and obligations under the transaction documents. This document cannot be reproduced except in full, without prior written approval of the Company. Any unauthorized alteration, forgery or falsification of the content or appearance of this document is unlawful and offenders may be prosecuted to the fullest extent of the law.

SGS Taiwan Ltd.

台灣檢驗科技股份有限公司

No.134,Wu Kung Road, New Taipei Industrial Park, Wuku District, New Taipei City, Taiwan/新北市五股區新北產業園區五工路 134 號

t (886-2) 2299-3279

f (886-2) 2298-0488

www.sgs.com.tw

Member of SGS Group

Report Number :E2/2019/A0032
 Operation Mode :LTE B41C
 Test Mode :TX CH HIGH
 EUT Pol :E2 Plan
 Test Frequency :2668.3+2680 MHz

Test Date :2020-03-17
 Temp./Humi. :23.5/57
 Antenna Pol. :VERTICAL
 Engineer :Enzo

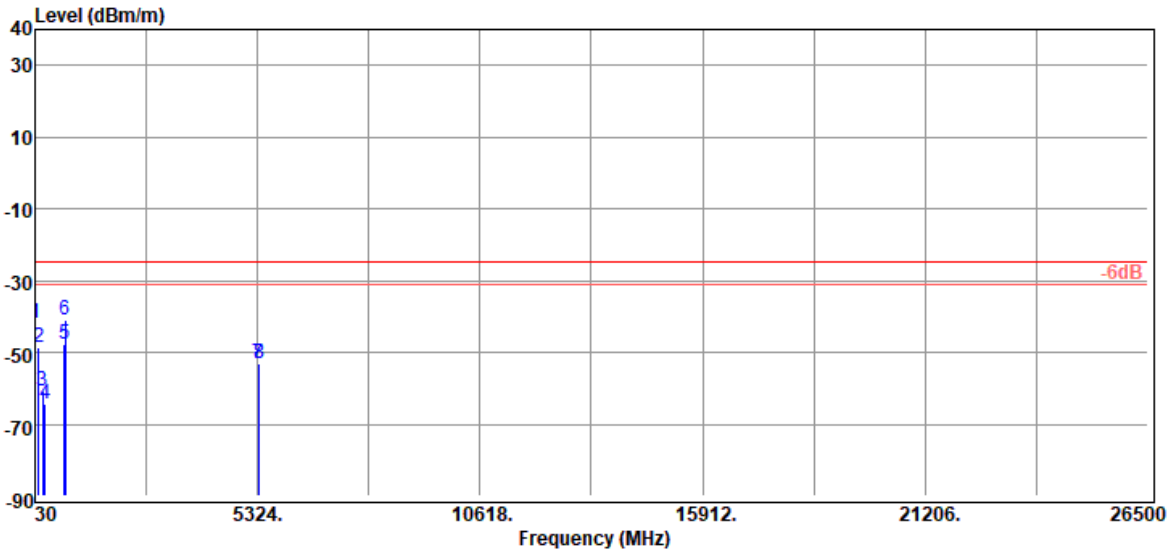

Freq. MHz	EIRP/ERP dBm	SG Output Level dBm	Antenna Gain dBi/dBd	Cable Loss dB	Limit dBm	Margin dB
47.46	-41.78	-22.85	-18.07	-0.86	-25.00	-16.78
118.27	-48.59	-40.06	-7.08	-1.45	-25.00	-23.59
204.60	-60.90	-56.90	-1.92	-2.08	-25.00	-35.90
278.32	-64.33	-60.26	-1.68	-2.39	-25.00	-39.33
734.22	-47.70	-42.02	-1.42	-4.26	-25.00	-22.70
745.86	-40.90	-35.10	-1.61	-4.19	-25.00	-15.90
5336.60	-53.22	-55.09	13.45	-11.58	-25.00	-28.22
5360.00	-53.21	-55.19	13.46	-11.48	-25.00	-28.21

Unless otherwise stated the results shown in this test report refer only to the sample(s) tested and such sample(s) are retained for 90 days only.

除非另有說明，此報告結果僅對測試之樣品負責，同時此樣品僅保留90天。本報告未經本公司書面許可，不可部份複製。

This document is issued by the Company subject to its General Conditions of Service printed overleaf, available on request or accessible at <http://www.sgs.com.tw/Terms-and-Conditions> and for electronic format documents, subject to Terms and Conditions for Electronic Documents at <http://www.sgs.com.tw/Terms-and-Conditions>. Attention is drawn to the limitation of liability, indemnification and jurisdiction issues defined therein. Any holder of this document is advised that information contained hereon reflects the Company's findings at the time of its intervention only and within the limits of Client's instructions, if any. The Company's sole responsibility is to its Client and this document does not exonerate parties to a transaction from exercising all their rights and obligations under the transaction documents. This document cannot be reproduced except in full, without prior written approval of the Company. Any unauthorized alteration, forgery or falsification of the content or appearance of this document is unlawful and offenders may be prosecuted to the fullest extent of the law.

Report Number :E2/2019/A0032
 Operation Mode :LTE B41C
 Test Mode :TX CH HIGH
 EUT Pol :E2 Plan
 Test Frequency :2668.3+2680 MHz

Test Date :2020-03-17
 Temp./Humi. :23.5/57
 Antenna Pol. :HORIZONTAL
 Engineer :Enzo

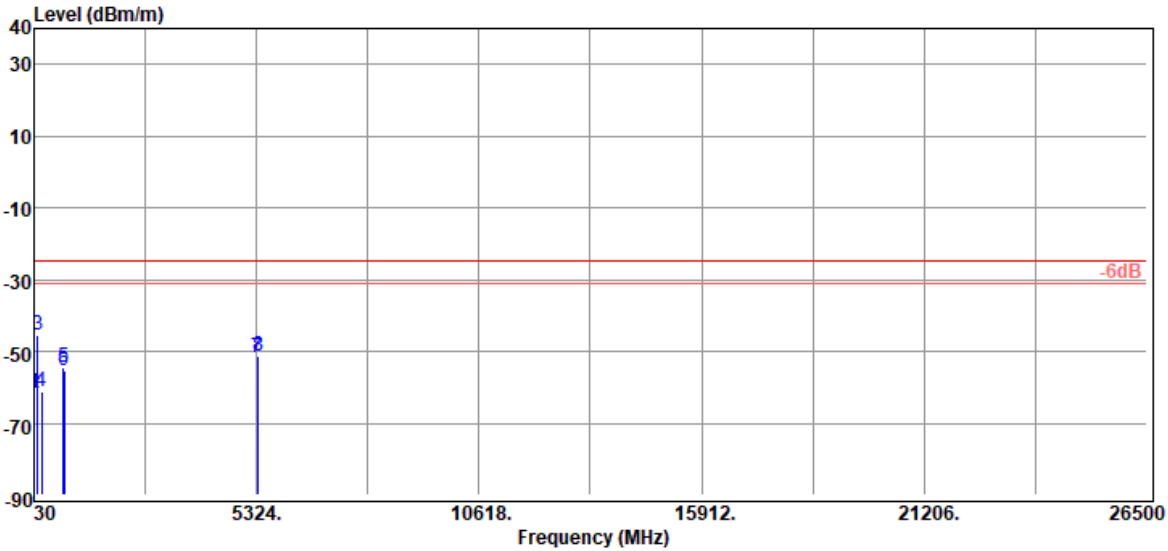

Freq. MHz	EIRP/ERP dBm	SG Output Level dBm	Antenna Gain dBi/dBd	Cable Loss dB	Limit dBm	Margin dB
33.88	-61.70	-41.15	-19.84	-0.71	-25.00	-36.70
45.52	-61.88	-42.64	-18.38	-0.86	-25.00	-36.88
119.24	-45.24	-36.75	-7.04	-1.45	-25.00	-20.24
207.51	-61.14	-57.31	-1.75	-2.08	-25.00	-36.14
732.28	-54.56	-48.84	-1.44	-4.28	-25.00	-29.56
746.83	-55.26	-49.46	-1.61	-4.19	-25.00	-30.26
5336.60	-51.80	-53.67	13.45	-11.58	-25.00	-26.80
5360.00	-51.30	-53.28	13.46	-11.48	-25.00	-26.30

Unless otherwise stated the results shown in this test report refer only to the sample(s) tested and such sample(s) are retained for 90 days only.

除非另有說明，此報告結果僅對測試之樣品負責，同時此樣品僅保留90天。本報告未經本公司書面許可，不可部份複製。

This document is issued by the Company subject to its General Conditions of Service printed overleaf, available on request or accessible at <http://www.sgs.com.tw/Terms-and-Conditions> and for electronic format documents, subject to Terms and Conditions for Electronic Documents at <http://www.sgs.com.tw/Terms-and-Conditions>. Attention is drawn to the limitation of liability, indemnification and jurisdiction issues defined therein. Any holder of this document is advised that information contained hereon reflects the Company's findings at the time of its intervention only and within the limits of Client's instructions, if any. The Company's sole responsibility is to its Client and this document does not exonerate parties to a transaction from exercising all their rights and obligations under the transaction documents. This document cannot be reproduced except in full, without prior written approval of the Company. Any unauthorized alteration, forgery or falsification of the content or appearance of this document is unlawful and offenders may be prosecuted to the fullest extent of the law.

Radiated Spurious Emission Measurement Result: LTE Band 48C Mode

Report Number	:E2/2019/A0032	Test Date	:2020-04-07
Operation Mode	:LTE B48C	Temp./Humi.	:22.3/54
Test Mode	:TX CH LOW	Antenna Pol.	:VERTICAL
EUT Pol	:E2 Plan	Engineer	:Enzo
Test Frequency	:3553.3+3565 MHz		

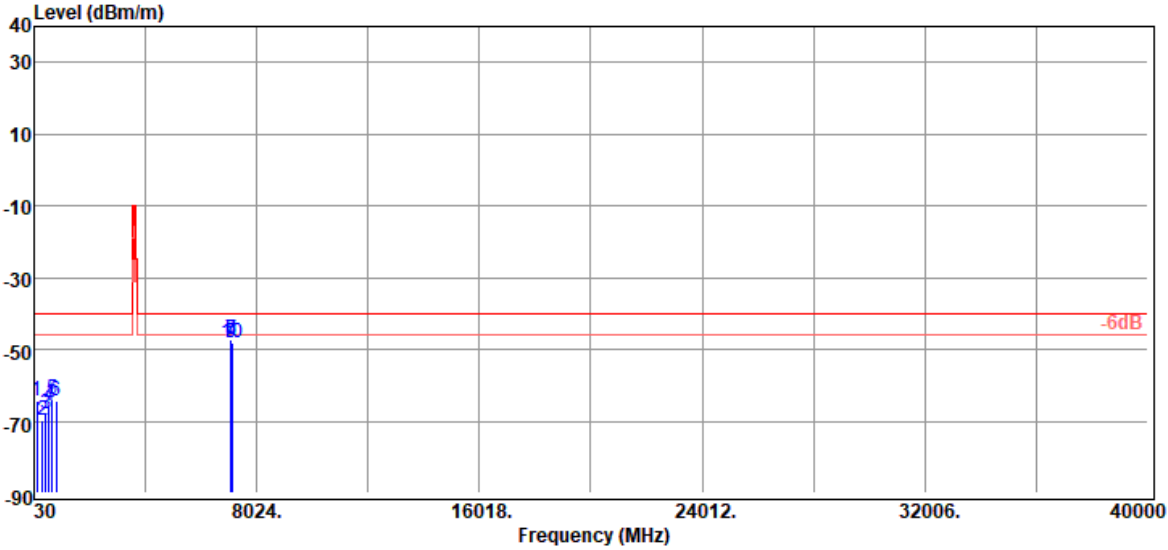

Freq. MHz	EIRP/ERP dBm	SG Output Level dBm	Antenna Gain dBi/dBd	Cable Loss dB	Limit dBm	Margin dB
129.91	-64.58	-55.66	-7.26	-1.66	-40.00	-24.58
343.31	-69.63	-65.51	-1.49	-2.63	-40.00	-29.63
459.71	-67.92	-63.24	-1.29	-3.39	-40.00	-27.92
565.44	-65.51	-60.75	-1.31	-3.45	-40.00	-25.51
675.05	-63.77	-58.56	-1.25	-3.96	-40.00	-23.77
829.28	-64.23	-58.21	-1.48	-4.54	-40.00	-24.23
7106.60	-47.41	-46.50	11.30	-12.21	-40.00	-7.41
7106.60	-47.41	-46.50	11.30	-12.21	-40.00	-7.41
7130.00	-48.38	-47.45	11.30	-12.23	-40.00	-8.38
7130.00	-48.38	-47.45	11.30	-12.23	-40.00	-8.38

Unless otherwise stated the results shown in this test report refer only to the sample(s) tested and such sample(s) are retained for 90 days only.

除非另有說明，此報告結果僅對測試之樣品負責，同時此樣品僅保留90天。本報告未經本公司書面許可，不可部份複製。

This document is issued by the Company subject to its General Conditions of Service printed overleaf, available on request or accessible at <http://www.sgs.com.tw/Terms-and-Conditions> and for electronic format documents, subject to Terms and Conditions for Electronic Documents at <http://www.sgs.com.tw/Terms-and-Conditions>. Attention is drawn to the limitation of liability, indemnification and jurisdiction issues defined therein. Any holder of this document is advised that information contained hereon reflects the Company's findings at the time of its intervention only and within the limits of Client's instructions, if any. The Company's sole responsibility is to its Client and this document does not exonerate parties to a transaction from exercising all their rights and obligations under the transaction documents. This document cannot be reproduced except in full, without prior written approval of the Company. Any unauthorized alteration, forgery or falsification of the content or appearance of this document is unlawful and offenders may be prosecuted to the fullest extent of the law.

Report Number :E2/2019/A0032
 Operation Mode :LTE B48C
 Test Mode :TX CH LOW
 EUT Pol :E2 Plan
 Test Frequency :3553.3+3565 MHz

Test Date :2020-04-07
 Temp./Humi. :22.3/54
 Antenna Pol. :HORIZONTAL
 Engineer :Enzo

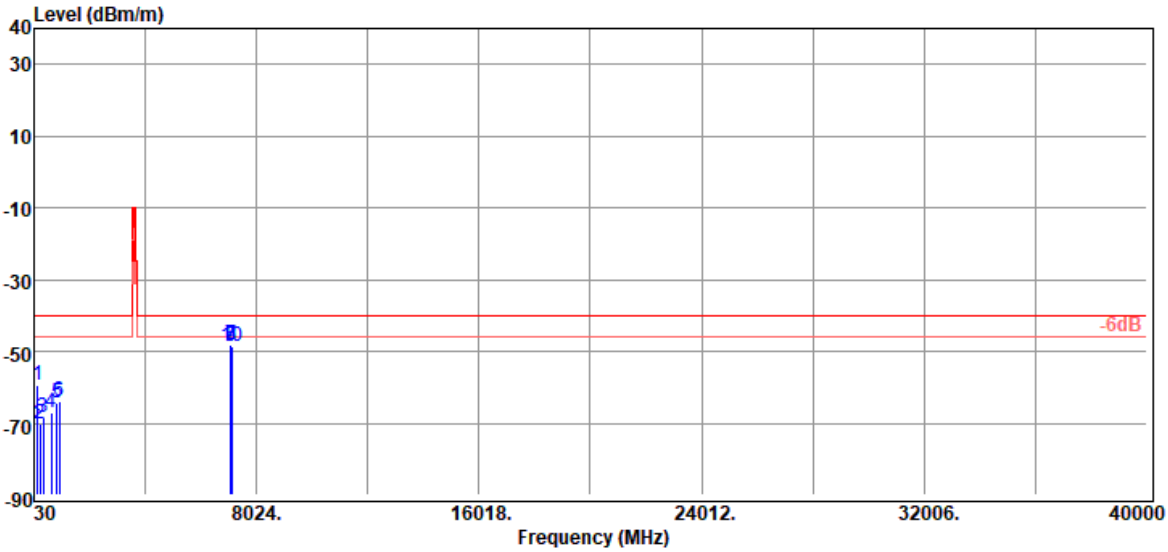

Freq. MHz	EIRP/ERP dBm	SG Output Level dBm	Antenna Gain dBi/dBd	Cable Loss dB	Limit dBm	Margin dB
159.98	-59.56	-50.92	-6.96	-1.68	-40.00	-19.56
248.25	-70.28	-66.41	-1.64	-2.23	-40.00	-30.28
355.92	-68.59	-64.66	-1.35	-2.58	-40.00	-28.59
649.83	-67.20	-62.12	-1.28	-3.80	-40.00	-27.20
849.65	-64.32	-58.46	-1.35	-4.51	-40.00	-24.32
935.98	-63.96	-57.41	-1.71	-4.84	-40.00	-23.96
7106.60	-48.16	-47.25	11.30	-12.21	-40.00	-8.16
7106.60	-48.16	-47.25	11.30	-12.21	-40.00	-8.16
7130.00	-48.44	-47.51	11.30	-12.23	-40.00	-8.44
7130.00	-48.44	-47.51	11.30	-12.23	-40.00	-8.44

Unless otherwise stated the results shown in this test report refer only to the sample(s) tested and such sample(s) are retained for 90 days only.

除非另有說明，此報告結果僅對測試之樣品負責，同時此樣品僅保留90天。本報告未經本公司書面許可，不可部份複製。

This document is issued by the Company subject to its General Conditions of Service printed overleaf, available on request or accessible at <http://www.sgs.com.tw/Terms-and-Conditions> and for electronic format documents, subject to Terms and Conditions for Electronic Documents at <http://www.sgs.com.tw/Terms-and-Conditions>. Attention is drawn to the limitation of liability, indemnification and jurisdiction issues defined therein. Any holder of this document is advised that information contained hereon reflects the Company's findings at the time of its intervention only and within the limits of Client's instructions, if any. The Company's sole responsibility is to its Client and this document does not exonerate parties to a transaction from exercising all their rights and obligations under the transaction documents. This document cannot be reproduced except in full, without prior written approval of the Company. Any unauthorized alteration, forgery or falsification of the content or appearance of this document is unlawful and offenders may be prosecuted to the fullest extent of the law.

Report Number :E2/2019/A0032
 Operation Mode :LTE B48C
 Test Mode :TX CH MID
 EUT Pol :E2 Plan
 Test Frequency :3615.8+3627.5 MHz

Test Date :2020-04-07
 Temp./Humi. :22.3/54
 Antenna Pol. :VERTICAL
 Engineer :Enzo

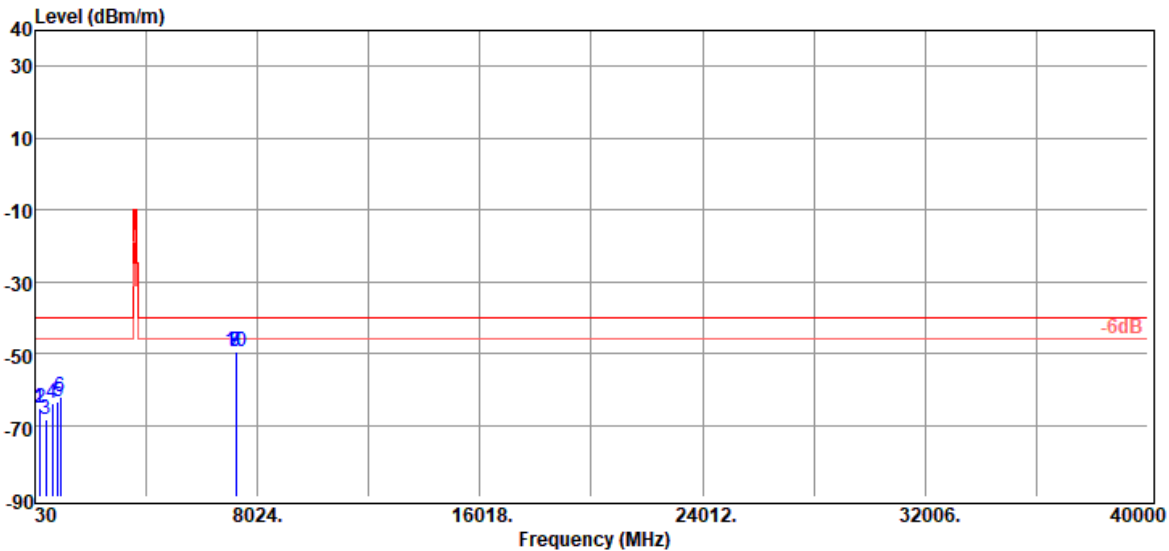

Freq. MHz	EIRP/ERP dBm	SG Output Level dBm	Antenna Gain dBi/dBd	Cable Loss dB	Limit dBm	Margin dB
183.26	-65.15	-59.52	-3.85	-1.78	-40.00	-25.15
227.88	-65.45	-61.94	-1.32	-2.19	-40.00	-25.45
414.12	-68.41	-63.93	-1.30	-3.18	-40.00	-28.41
646.92	-63.86	-58.65	-1.32	-3.89	-40.00	-23.86
841.89	-63.52	-57.62	-1.37	-4.53	-40.00	-23.52
936.95	-62.28	-55.75	-1.70	-4.83	-40.00	-22.28
7231.60	-49.30	-48.19	11.24	-12.35	-40.00	-9.30
7231.60	-49.30	-48.19	11.24	-12.35	-40.00	-9.30
7255.00	-49.53	-48.31	11.19	-12.41	-40.00	-9.53
7255.00	-49.53	-48.31	11.19	-12.41	-40.00	-9.53

Unless otherwise stated the results shown in this test report refer only to the sample(s) tested and such sample(s) are retained for 90 days only.

除非另有說明，此報告結果僅對測試之樣品負責，同時此樣品僅保留90天。本報告未經本公司書面許可，不可部份複製。

This document is issued by the Company subject to its General Conditions of Service printed overleaf, available on request or accessible at <http://www.sgs.com.tw/Terms-and-Conditions> and for electronic format documents, subject to Terms and Conditions for Electronic Documents at <http://www.sgs.com.tw/Terms-and-Conditions>. Attention is drawn to the limitation of liability, indemnification and jurisdiction issues defined therein. Any holder of this document is advised that information contained hereon reflects the Company's findings at the time of its intervention only and within the limits of Client's instructions, if any. The Company's sole responsibility is to its Client and this document does not exonerate parties to a transaction from exercising all their rights and obligations under the transaction documents. This document cannot be reproduced except in full, without prior written approval of the Company. Any unauthorized alteration, forgery or falsification of the content or appearance of this document is unlawful and offenders may be prosecuted to the fullest extent of the law.

Report Number :E2/2019/A0032
 Operation Mode :LTE B48C
 Test Mode :TX CH MID
 EUT Pol :E2 Plan
 Test Frequency :3615.8+3627.5 MHz

Test Date :2020-04-07
 Temp./Humi. :22.3/54
 Antenna Pol. :HORIZONTAL
 Engineer :Enzo

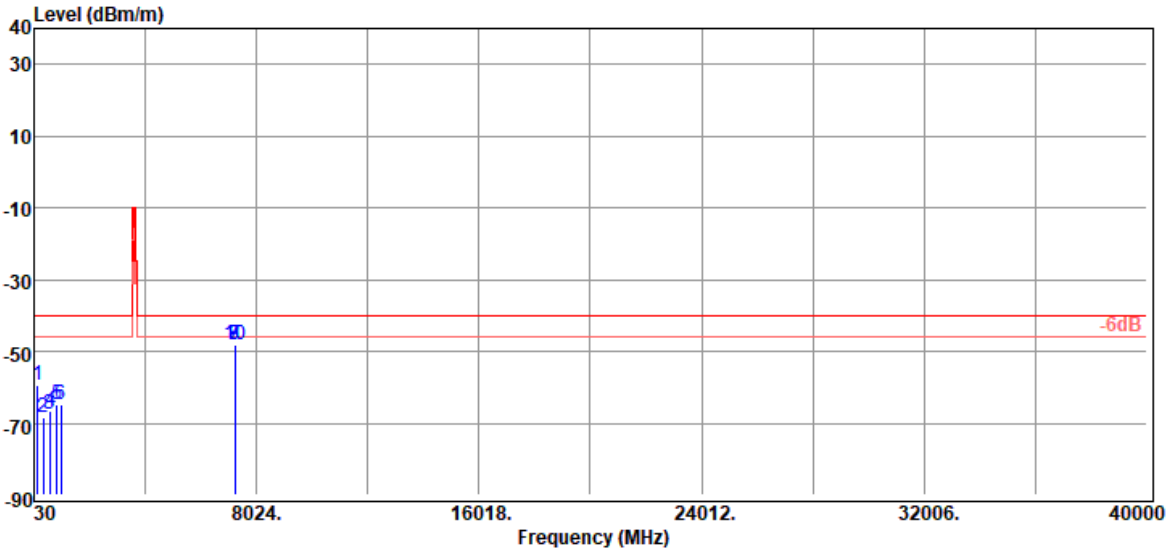

Freq. MHz	EIRP/ERP dBm	SG Output Level dBm	Antenna Gain dBi/dBd	Cable Loss dB	Limit dBm	Margin dB
163.86	-59.40	-51.04	-6.66	-1.70	-40.00	-19.40
358.83	-68.44	-64.47	-1.39	-2.58	-40.00	-28.44
591.63	-67.68	-62.43	-1.46	-3.79	-40.00	-27.68
635.28	-66.53	-61.19	-1.48	-3.86	-40.00	-26.53
854.50	-64.93	-59.03	-1.39	-4.51	-40.00	-24.93
991.27	-64.68	-58.23	-1.52	-4.93	-40.00	-24.68
7231.60	-48.10	-46.99	11.24	-12.35	-40.00	-8.10
7231.60	-48.10	-46.99	11.24	-12.35	-40.00	-8.10
7255.00	-48.05	-46.83	11.19	-12.41	-40.00	-8.05
7255.00	-48.05	-46.83	11.19	-12.41	-40.00	-8.05

Unless otherwise stated the results shown in this test report refer only to the sample(s) tested and such sample(s) are retained for 90 days only.

除非另有說明，此報告結果僅對測試之樣品負責，同時此樣品僅保留90天。本報告未經本公司書面許可，不可部份複製。

This document is issued by the Company subject to its General Conditions of Service printed overleaf, available on request or accessible at <http://www.sgs.com.tw/Terms-and-Conditions> and for electronic format documents, subject to Terms and Conditions for Electronic Documents at <http://www.sgs.com.tw/Terms-and-Conditions>. Attention is drawn to the limitation of liability, indemnification and jurisdiction issues defined therein. Any holder of this document is advised that information contained hereon reflects the Company's findings at the time of its intervention only and within the limits of Client's instructions, if any. The Company's sole responsibility is to its Client and this document does not exonerate parties to a transaction from exercising all their rights and obligations under the transaction documents. This document cannot be reproduced except in full, without prior written approval of the Company. Any unauthorized alteration, forgery or falsification of the content or appearance of this document is unlawful and offenders may be prosecuted to the fullest extent of the law.

Report Number :E2/2019/A0032
 Operation Mode :LTE B48C
 Test Mode :TX CH HIGH
 EUT Pol :E2 Plan
 Test Frequency :3678.3+3690 MHz

Test Date :2020-04-07
 Temp./Humi. :22.3/54
 Antenna Pol. :VERTICAL
 Engineer :Enzo

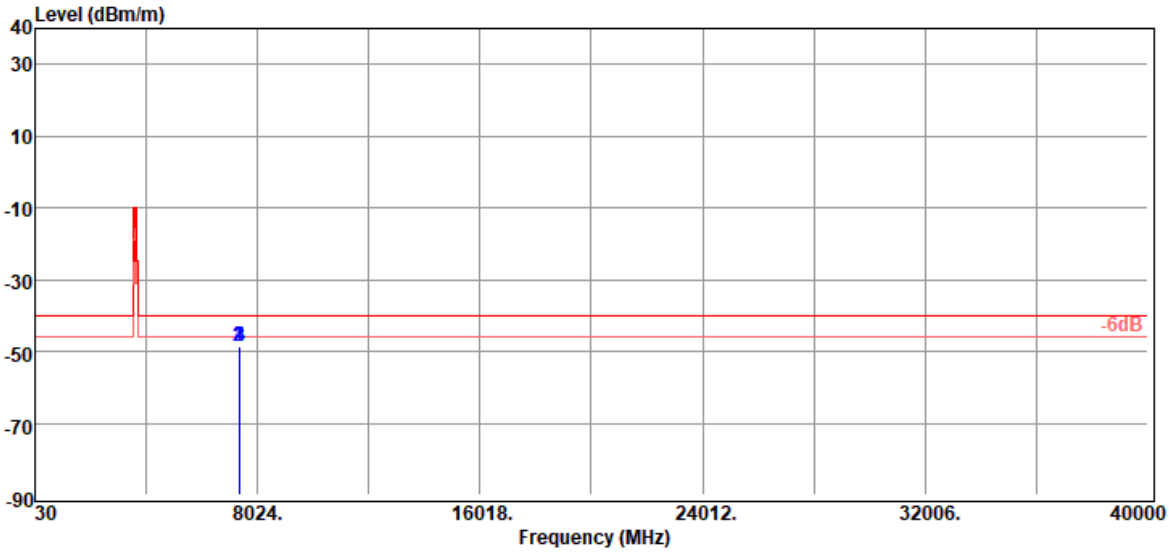

Freq. MHz	EIRP/ERP dBm	SG Output Level dBm	Antenna Gain dBi/dBd	Cable Loss dB	Limit dBm	Margin dB
7356.60	-48.49	-46.93	11.11	-12.67	-40.00	-8.49
7356.60	-48.49	-46.93	11.11	-12.67	-40.00	-8.49
7380.00	-48.71	-47.15	11.16	-12.72	-40.00	-8.71
7380.00	-48.71	-47.15	11.16	-12.72	-40.00	-8.71

Unless otherwise stated the results shown in this test report refer only to the sample(s) tested and such sample(s) are retained for 90 days only.

除非另有說明，此報告結果僅對測試之樣品負責，同時此樣品僅保留90天。本報告未經本公司書面許可，不可部份複製。

This document is issued by the Company subject to its General Conditions of Service printed overleaf, available on request or accessible at <http://www.sgs.com.tw/Terms-and-Conditions> and for electronic format documents, subject to Terms and Conditions for Electronic Documents at <http://www.sgs.com.tw/Terms-and-Conditions>. Attention is drawn to the limitation of liability, indemnification and jurisdiction issues defined therein. Any holder of this document is advised that information contained hereon reflects the Company's findings at the time of its intervention only and within the limits of Client's instructions, if any. The Company's sole responsibility is to its Client and this document does not exonerate parties to a transaction from exercising all their rights and obligations under the transaction documents. This document cannot be reproduced except in full, without prior written approval of the Company. Any unauthorized alteration, forgery or falsification of the content or appearance of this document is unlawful and offenders may be prosecuted to the fullest extent of the law.

Report Number :E2/2019/A0032
 Operation Mode :LTE B48C
 Test Mode :TX CH HIGH
 EUT Pol :E2 Plan
 Test Frequency :3678.3+3690 MHz

Test Date :2020-04-07
 Temp./Humi. :22.3/54
 Antenna Pol. :HORIZONTAL
 Engineer :Enzo

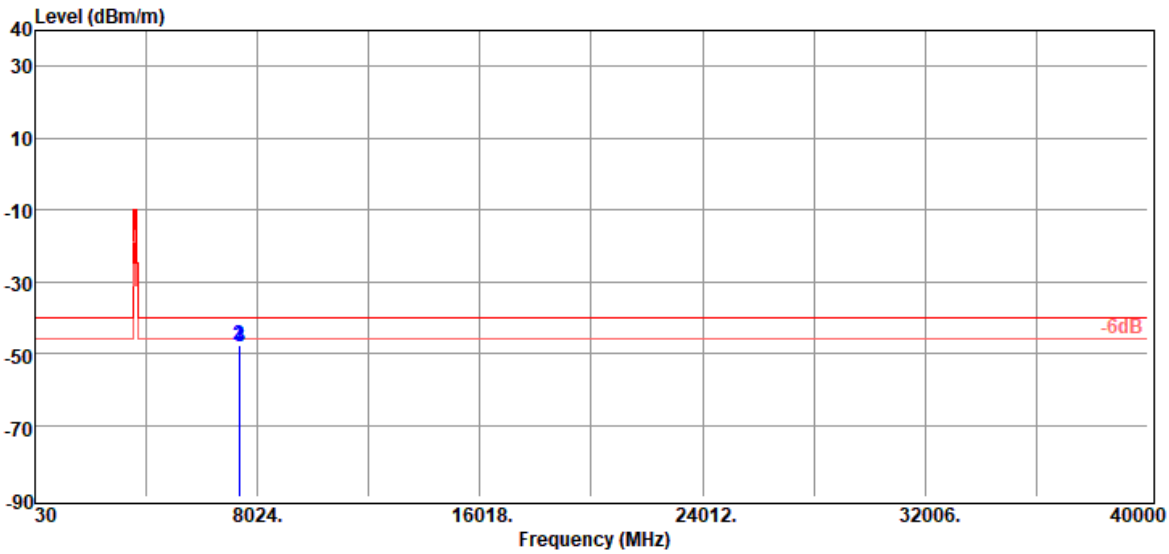

Freq. MHz	EIRP/ERP dBm	SG Output Level dBm	Antenna Gain dBi/dBd	Cable Loss dB	Limit dBm	Margin dB
7356.60	-47.72	-46.16	11.11	-12.67	-40.00	-7.72
7356.60	-47.72	-46.16	11.11	-12.67	-40.00	-7.72
7380.00	-48.31	-46.75	11.16	-12.72	-40.00	-8.31
7380.00	-48.31	-46.75	11.16	-12.72	-40.00	-8.31

Unless otherwise stated the results shown in this test report refer only to the sample(s) tested and such sample(s) are retained for 90 days only.

除非另有說明，此報告結果僅對測試之樣品負責，同時此樣品僅保留90天。本報告未經本公司書面許可，不可部份複製。

This document is issued by the Company subject to its General Conditions of Service printed overleaf, available on request or accessible at <http://www.sgs.com.tw/Terms-and-Conditions> and for electronic format documents, subject to Terms and Conditions for Electronic Documents at <http://www.sgs.com.tw/Terms-and-Conditions>. Attention is drawn to the limitation of liability, indemnification and jurisdiction issues defined therein. Any holder of this document is advised that information contained hereon reflects the Company's findings at the time of its intervention only and within the limits of Client's instructions, if any. The Company's sole responsibility is to its Client and this document does not exonerate parties to a transaction from exercising all their rights and obligations under the transaction documents. This document cannot be reproduced except in full, without prior written approval of the Company. Any unauthorized alteration, forgery or falsification of the content or appearance of this document is unlawful and offenders may be prosecuted to the fullest extent of the law.

Radiated Spurious Emission Measurement Result: LTE Band 66B Mode

Report Number	:E2/2019/A0032	Test Date	:2020-03-17
Operation Mode	:LTE B66B	Temp./Humi.	:23.5/57
Test Mode	:TX CH LOW	Antenna Pol.	:VERTICAL
EUT Pol	:E2 Plan	Engineer	:Enzo
Test Frequency	:1717.5+1726.8 MHz		

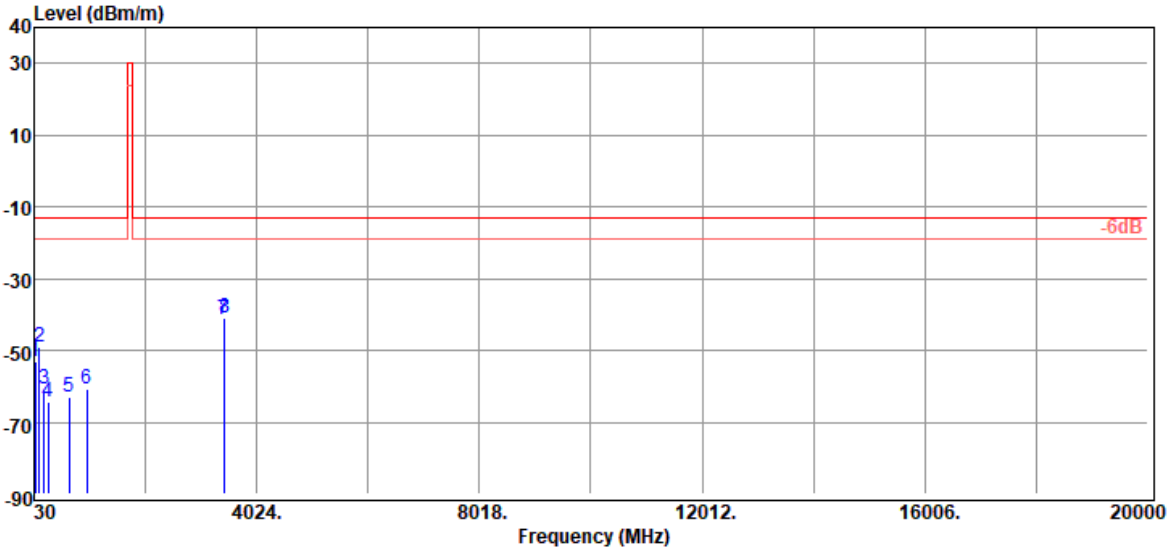

Freq. MHz	EIRP/ERP dBm	SG Output Level dBm	Antenna Gain dBi/dBd	Cable Loss dB	Limit dBm	Margin dB
48.43	-52.93	-34.18	-17.89	-0.86	-13.00	-39.93
118.27	-48.86	-40.33	-7.08	-1.45	-13.00	-35.86
206.54	-60.67	-56.78	-1.81	-2.08	-13.00	-47.67
276.38	-64.21	-60.19	-1.66	-2.36	-13.00	-51.21
663.41	-63.18	-58.13	-1.20	-3.85	-13.00	-50.18
979.63	-60.73	-54.29	-1.52	-4.92	-13.00	-47.73
3435.00	-41.33	-42.73	12.63	-11.23	-13.00	-28.33
3453.60	-41.17	-42.64	12.58	-11.11	-13.00	-28.17

Unless otherwise stated the results shown in this test report refer only to the sample(s) tested and such sample(s) are retained for 90 days only.

除非另有說明，此報告結果僅對測試之樣品負責，同時此樣品僅保留90天。本報告未經本公司書面許可，不可部份複製。

This document is issued by the Company subject to its General Conditions of Service printed overleaf, available on request or accessible at <http://www.sgs.com.tw/Terms-and-Conditions> and for electronic format documents, subject to Terms and Conditions for Electronic Documents at <http://www.sgs.com.tw/Terms-and-Conditions>. Attention is drawn to the limitation of liability, indemnification and jurisdiction issues defined therein. Any holder of this document is advised that information contained hereon reflects the Company's findings at the time of its intervention only and within the limits of Client's instructions, if any. The Company's sole responsibility is to its Client and this document does not exonerate parties to a transaction from exercising all their rights and obligations under the transaction documents. This document cannot be reproduced except in full, without prior written approval of the Company. Any unauthorized alteration, forgery or falsification of the content or appearance of this document is unlawful and offenders may be prosecuted to the fullest extent of the law.

Report Number :E2/2019/A0032
 Operation Mode :LTE B66B
 Test Mode :TX CH LOW
 EUT Pol :E2 Plan
 Test Frequency :1717.5+1726.8 MHz

Test Date :2020-03-17
 Temp./Humi. :23.5/57
 Antenna Pol. :HORIZONTAL
 Engineer :Enzo

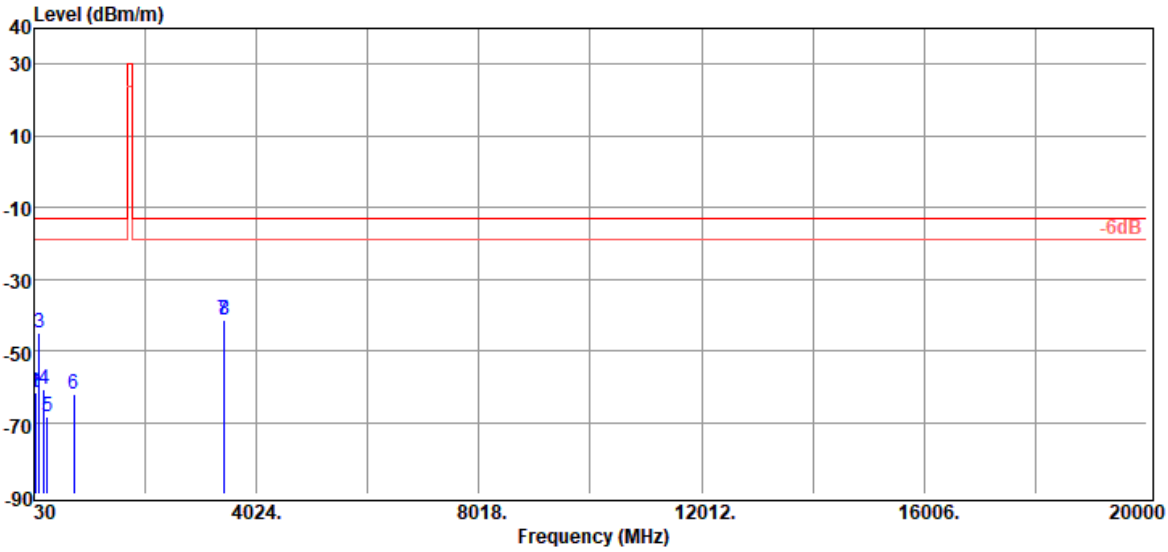

Freq. MHz	EIRP/ERP dBm	SG Output Level dBm	Antenna Gain dBi/dBd	Cable Loss dB	Limit dBm	Margin dB
30.00	-61.44	-39.93	-20.90	-0.61	-13.00	-48.44
45.52	-61.86	-42.62	-18.38	-0.86	-13.00	-48.86
119.24	-45.18	-36.69	-7.04	-1.45	-13.00	-32.18
206.54	-60.88	-56.99	-1.81	-2.08	-13.00	-47.88
273.47	-68.46	-64.50	-1.64	-2.32	-13.00	-55.46
746.83	-62.32	-56.52	-1.61	-4.19	-13.00	-49.32
3435.00	-41.50	-42.90	12.63	-11.23	-13.00	-28.50
3453.60	-41.38	-42.85	12.58	-11.11	-13.00	-28.38

Unless otherwise stated the results shown in this test report refer only to the sample(s) tested and such sample(s) are retained for 90 days only.

除非另有說明，此報告結果僅對測試之樣品負責，同時此樣品僅保留90天。本報告未經本公司書面許可，不可部份複製。

This document is issued by the Company subject to its General Conditions of Service printed overleaf, available on request or accessible at <http://www.sgs.com.tw/Terms-and-Conditions> and for electronic format documents, subject to Terms and Conditions for Electronic Documents at <http://www.sgs.com.tw/Terms-and-Conditions>. Attention is drawn to the limitation of liability, indemnification and jurisdiction issues defined therein. Any holder of this document is advised that information contained hereon reflects the Company's findings at the time of its intervention only and within the limits of Client's instructions, if any. The Company's sole responsibility is to its Client and this document does not exonerate parties to a transaction from exercising all their rights and obligations under the transaction documents. This document cannot be reproduced except in full, without prior written approval of the Company. Any unauthorized alteration, forgery or falsification of the content or appearance of this document is unlawful and offenders may be prosecuted to the fullest extent of the law.

SGS Taiwan Ltd.

台灣檢驗科技股份有限公司

No.134,Wu Kung Road, New Taipei Industrial Park, Wuku District, New Taipei City, Taiwan/新北市五股區新北產業園區五工路 134 號

t (886-2) 2299-3279

f (886-2) 2298-0488

www.sgs.com.tw

Member of SGS Group

Report Number :E2/2019/A0032
 Operation Mode :LTE B66B
 Test Mode :TX CH MID
 EUT Pol :E2 Plan
 Test Frequency :1752.6+1761.9 MHz

Test Date :2020-03-17
 Temp./Humi. :23.5/57
 Antenna Pol. :VERTICAL
 Engineer :Enzo

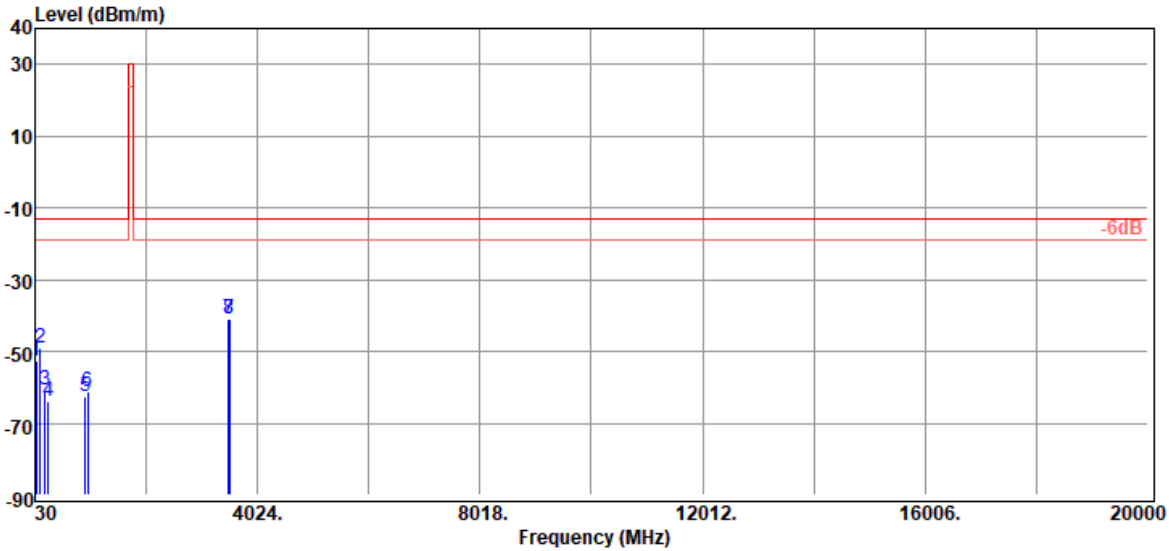

Freq. MHz	EIRP/ERP dBm	SG Output Level dBm	Antenna Gain dBi/dBd	Cable Loss dB	Limit dBm	Margin dB
48.43	-52.71	-33.96	-17.89	-0.86	-13.00	-39.71
118.27	-48.90	-40.37	-7.08	-1.45	-13.00	-35.90
205.57	-60.93	-56.98	-1.87	-2.08	-13.00	-47.93
274.44	-63.92	-59.94	-1.65	-2.33	-13.00	-50.92
936.95	-62.71	-56.18	-1.70	-4.83	-13.00	-49.71
980.60	-61.12	-54.70	-1.51	-4.91	-13.00	-48.12
3505.20	-40.84	-42.31	12.30	-10.83	-13.00	-27.84
3523.80	-40.86	-42.25	12.30	-10.91	-13.00	-27.86

Unless otherwise stated the results shown in this test report refer only to the sample(s) tested and such sample(s) are retained for 90 days only.

除非另有說明，此報告結果僅對測試之樣品負責，同時此樣品僅保留90天。本報告未經本公司書面許可，不可部份複製。

This document is issued by the Company subject to its General Conditions of Service printed overleaf, available on request or accessible at <http://www.sgs.com.tw/Terms-and-Conditions> and for electronic format documents, subject to Terms and Conditions for Electronic Documents at <http://www.sgs.com.tw/Terms-and-Conditions>. Attention is drawn to the limitation of liability, indemnification and jurisdiction issues defined therein. Any holder of this document is advised that information contained hereon reflects the Company's findings at the time of its intervention only and within the limits of Client's instructions, if any. The Company's sole responsibility is to its Client and this document does not exonerate parties to a transaction from exercising all their rights and obligations under the transaction documents. This document cannot be reproduced except in full, without prior written approval of the Company. Any unauthorized alteration, forgery or falsification of the content or appearance of this document is unlawful and offenders may be prosecuted to the fullest extent of the law.

SGS Taiwan Ltd.

台灣檢驗科技股份有限公司

No.134,Wu Kung Road, New Taipei Industrial Park, Wuku District, New Taipei City, Taiwan/新北市五股區新北產業園區五工路 134 號

t (886-2) 2299-3279

f (886-2) 2298-0488

www.sgs.com.tw

Member of SGS Group

Report Number :E2/2019/A0032
 Operation Mode :LTE B66B
 Test Mode :TX CH MID
 EUT Pol :E2 Plan
 Test Frequency :1752.6+1761.9 MHz

Test Date :2020-03-17
 Temp./Humi. :23.5/57
 Antenna Pol. :HORIZONTAL
 Engineer :Enzo

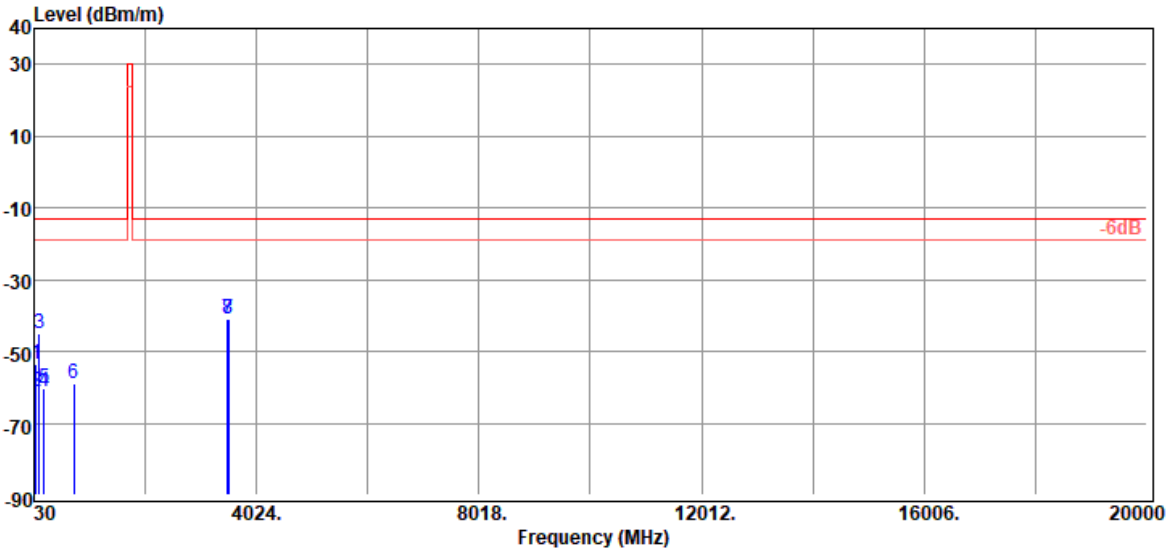

Freq. MHz	EIRP/ERP dBm	SG Output Level dBm	Antenna Gain dBi/dBd	Cable Loss dB	Limit dBm	Margin dB
61.04	-53.57	-37.65	-14.92	-1.00	-13.00	-40.57
68.80	-61.41	-47.96	-12.45	-1.00	-13.00	-48.41
119.24	-45.22	-36.73	-7.04	-1.45	-13.00	-32.22
205.57	-61.24	-57.29	-1.87	-2.08	-13.00	-48.24
214.30	-60.24	-56.69	-1.42	-2.13	-13.00	-47.24
746.83	-58.74	-52.94	-1.61	-4.19	-13.00	-45.74
3505.20	-41.05	-42.52	12.30	-10.83	-13.00	-28.05
3523.80	-41.12	-42.51	12.30	-10.91	-13.00	-28.12

Unless otherwise stated the results shown in this test report refer only to the sample(s) tested and such sample(s) are retained for 90 days only.

除非另有說明，此報告結果僅對測試之樣品負責，同時此樣品僅保留90天。本報告未經本公司書面許可，不可部份複製。

This document is issued by the Company subject to its General Conditions of Service printed overleaf, available on request or accessible at <http://www.sgs.com.tw/Terms-and-Conditions> and for electronic format documents, subject to Terms and Conditions for Electronic Documents at <http://www.sgs.com.tw/Terms-and-Conditions>. Attention is drawn to the limitation of liability, indemnification and jurisdiction issues defined therein. Any holder of this document is advised that information contained hereon reflects the Company's findings at the time of its intervention only and within the limits of Client's instructions, if any. The Company's sole responsibility is to its Client and this document does not exonerate parties to a transaction from exercising all their rights and obligations under the transaction documents. This document cannot be reproduced except in full, without prior written approval of the Company. Any unauthorized alteration, forgery or falsification of the content or appearance of this document is unlawful and offenders may be prosecuted to the fullest extent of the law.

Report Number :E2/2019/A0032
 Operation Mode :LTE B66B
 Test Mode :TX CH HIGH
 EUT Pol :E2 Plan
 Test Frequency :1767.7+1777 MHz

Test Date :2020-03-17
 Temp./Humi. :23.5/57
 Antenna Pol. :VERTICAL
 Engineer :Enzo

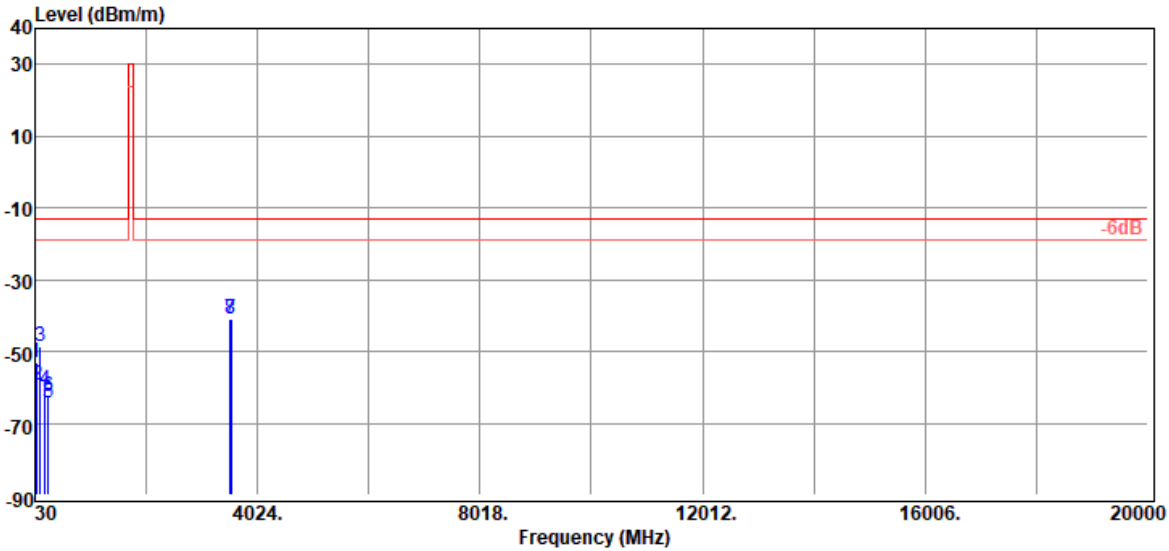

Freq. MHz	EIRP/ERP dBm	SG Output Level dBm	Antenna Gain dBi/dBd	Cable Loss dB	Limit dBm	Margin dB
47.46	-52.94	-34.01	-18.07	-0.86	-13.00	-39.94
64.92	-59.54	-44.83	-13.71	-1.00	-13.00	-46.54
118.27	-48.84	-40.31	-7.08	-1.45	-13.00	-35.84
205.57	-60.83	-56.88	-1.87	-2.08	-13.00	-47.83
262.80	-64.32	-60.49	-1.56	-2.27	-13.00	-51.32
274.44	-62.62	-58.64	-1.65	-2.33	-13.00	-49.62
3535.40	-40.95	-42.28	12.30	-10.97	-13.00	-27.95
3554.00	-40.98	-42.22	12.29	-11.05	-13.00	-27.98

Unless otherwise stated the results shown in this test report refer only to the sample(s) tested and such sample(s) are retained for 90 days only.

除非另有說明，此報告結果僅對測試之樣品負責，同時此樣品僅保留90天。本報告未經本公司書面許可，不可部份複製。

This document is issued by the Company subject to its General Conditions of Service printed overleaf, available on request or accessible at <http://www.sgs.com.tw/Terms-and-Conditions> and for electronic format documents, subject to Terms and Conditions for Electronic Documents at <http://www.sgs.com.tw/Terms-and-Conditions>. Attention is drawn to the limitation of liability, indemnification and jurisdiction issues defined therein. Any holder of this document is advised that information contained hereon reflects the Company's findings at the time of its intervention only and within the limits of Client's instructions, if any. The Company's sole responsibility is to its Client and this document does not exonerate parties to a transaction from exercising all their rights and obligations under the transaction documents. This document cannot be reproduced except in full, without prior written approval of the Company. Any unauthorized alteration, forgery or falsification of the content or appearance of this document is unlawful and offenders may be prosecuted to the fullest extent of the law.

SGS Taiwan Ltd.

台灣檢驗科技股份有限公司

No.134,Wu Kung Road, New Taipei Industrial Park, Wuku District, New Taipei City, Taiwan/新北市五股區新北產業園區五工路 134 號

t (886-2) 2299-3279

f (886-2) 2298-0488

www.sgs.com.tw

Member of SGS Group

Report Number :E2/2019/A0032
 Operation Mode :LTE B66B
 Test Mode :TX CH HIGH
 EUT Pol :E2 Plan
 Test Frequency :1767.7+1777 MHz

Test Date :2020-03-17
 Temp./Humi. :23.5/57
 Antenna Pol. :HORIZONTAL
 Engineer :Enzo

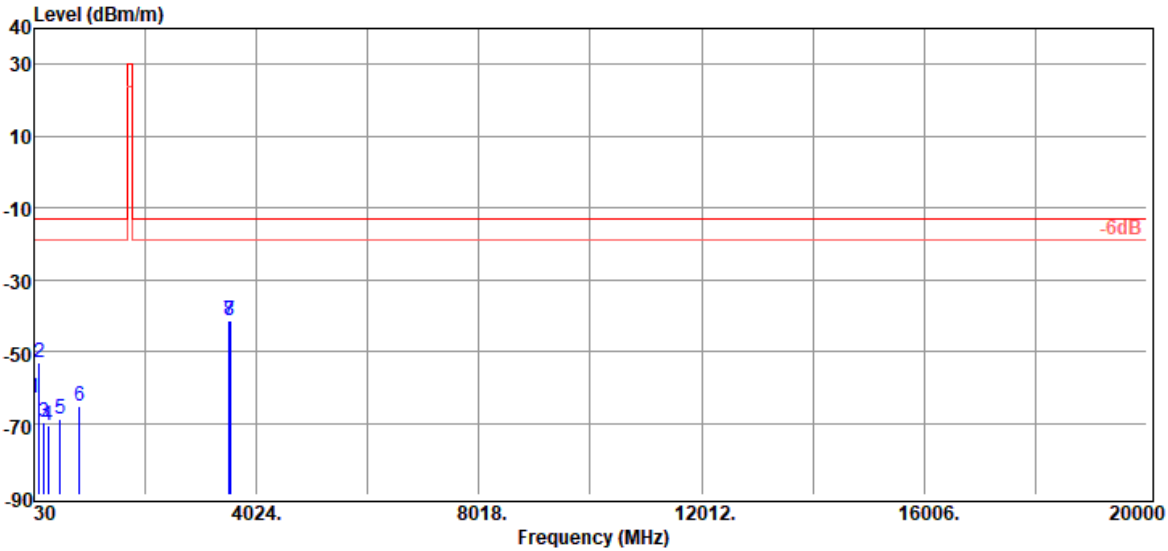

Freq. MHz	EIRP/ERP dBm	SG Output Level dBm	Antenna Gain dBi/dBd	Cable Loss dB	Limit dBm	Margin dB
37.76	-62.88	-42.73	-19.35	-0.80	-13.00	-49.88
119.24	-53.01	-44.52	-7.04	-1.45	-13.00	-40.01
205.57	-69.86	-65.91	-1.87	-2.08	-13.00	-56.86
276.38	-70.54	-66.52	-1.66	-2.36	-13.00	-57.54
494.63	-68.67	-64.13	-1.05	-3.49	-13.00	-55.67
852.56	-65.20	-59.31	-1.38	-4.51	-13.00	-52.20
3535.40	-41.20	-42.53	12.30	-10.97	-13.00	-28.20
3554.00	-41.22	-42.46	12.29	-11.05	-13.00	-28.22

Unless otherwise stated the results shown in this test report refer only to the sample(s) tested and such sample(s) are retained for 90 days only.

除非另有說明，此報告結果僅對測試之樣品負責，同時此樣品僅保留90天。本報告未經本公司書面許可，不可部份複製。

This document is issued by the Company subject to its General Conditions of Service printed overleaf, available on request or accessible at <http://www.sgs.com.tw/Terms-and-Conditions> and for electronic format documents, subject to Terms and Conditions for Electronic Documents at <http://www.sgs.com.tw/Terms-and-Conditions>. Attention is drawn to the limitation of liability, indemnification and jurisdiction issues defined therein. Any holder of this document is advised that information contained hereon reflects the Company's findings at the time of its intervention only and within the limits of Client's instructions, if any. The Company's sole responsibility is to its Client and this document does not exonerate parties to a transaction from exercising all their rights and obligations under the transaction documents. This document cannot be reproduced except in full, without prior written approval of the Company. Any unauthorized alteration, forgery or falsification of the content or appearance of this document is unlawful and offenders may be prosecuted to the fullest extent of the law.

Radiated Spurious Emission Measurement Result: LTE Band 66C Mode

Report Number	:E2/2019/A0032	Test Date	:2020-03-17
Operation Mode	:LTE B66C	Temp./Humi.	:23.5/57
Test Mode	:TX CH LOW	Antenna Pol.	:VERTICAL
EUT Pol	:E2 Plan	Engineer	:Enzo
Test Frequency	:1720+1731.7 MHz		

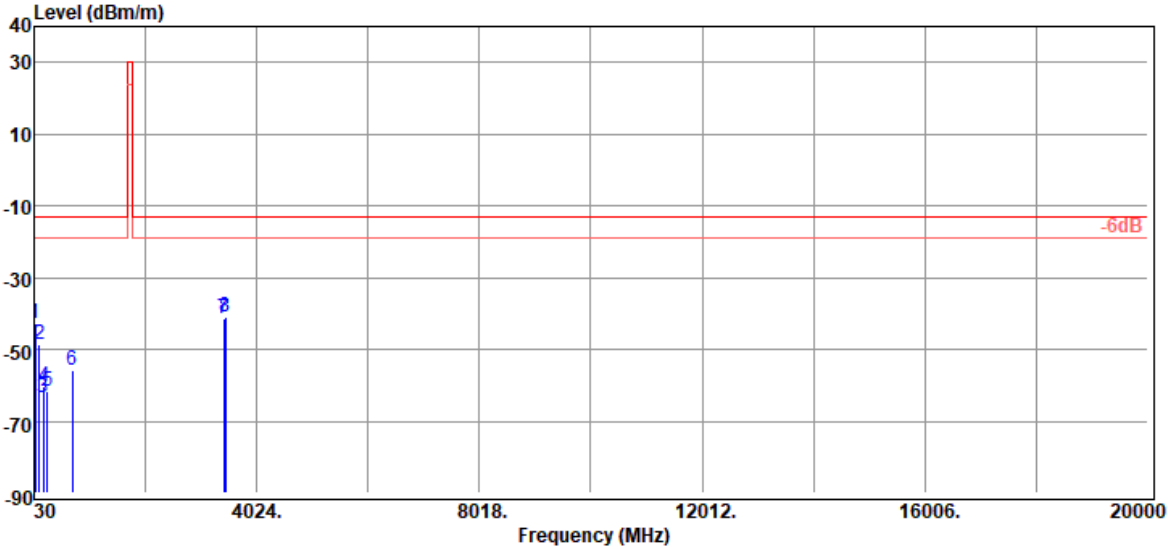

Freq. MHz	EIRP/ERP dBm	SG Output Level dBm	Antenna Gain dBi/dBd	Cable Loss dB	Limit dBm	Margin dB
49.40	-42.65	-24.06	-17.73	-0.86	-13.00	-29.65
118.27	-48.78	-40.25	-7.08	-1.45	-13.00	-35.78
197.81	-63.43	-59.16	-2.24	-2.03	-13.00	-50.43
205.57	-60.21	-56.26	-1.87	-2.08	-13.00	-47.21
271.53	-61.68	-57.77	-1.62	-2.29	-13.00	-48.68
711.91	-55.61	-50.38	-1.33	-3.90	-13.00	-42.61
3440.00	-41.22	-42.65	12.62	-11.19	-13.00	-28.22
3463.40	-41.09	-42.57	12.52	-11.04	-13.00	-28.09

Unless otherwise stated the results shown in this test report refer only to the sample(s) tested and such sample(s) are retained for 90 days only.

除非另有說明，此報告結果僅對測試之樣品負責，同時此樣品僅保留90天。本報告未經本公司書面許可，不可部份複製。

This document is issued by the Company subject to its General Conditions of Service printed overleaf, available on request or accessible at <http://www.sgs.com.tw/Terms-and-Conditions> and for electronic format documents, subject to Terms and Conditions for Electronic Documents at <http://www.sgs.com.tw/Terms-and-Conditions>. Attention is drawn to the limitation of liability, indemnification and jurisdiction issues defined therein. Any holder of this document is advised that information contained hereon reflects the Company's findings at the time of its intervention only and within the limits of Client's instructions, if any. The Company's sole responsibility is to its Client and this document does not exonerate parties to a transaction from exercising all their rights and obligations under the transaction documents. This document cannot be reproduced except in full, without prior written approval of the Company. Any unauthorized alteration, forgery or falsification of the content or appearance of this document is unlawful and offenders may be prosecuted to the fullest extent of the law.

Report Number :E2/2019/A0032
 Operation Mode :LTE B66C
 Test Mode :TX CH LOW
 EUT Pol :E2 Plan
 Test Frequency :1720+1731.7 MHz

Test Date :2020-03-17
 Temp./Humi. :23.5/57
 Antenna Pol. :HORIZONTAL
 Engineer :Enzo

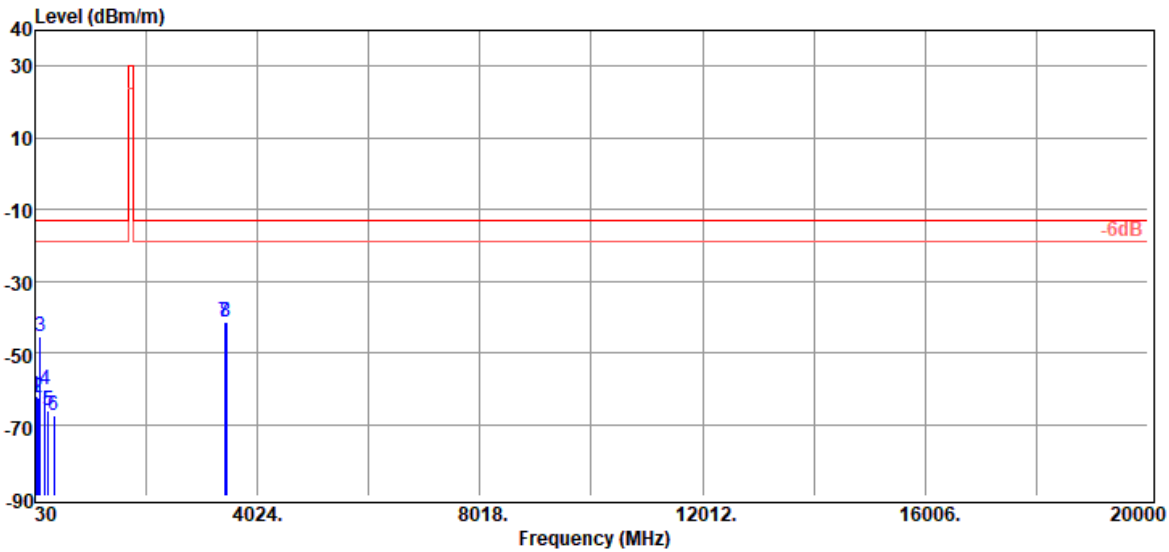

Freq. MHz	EIRP/ERP dBm	SG Output Level dBm	Antenna Gain dBi/dBd	Cable Loss dB	Limit dBm	Margin dB
45.52	-61.95	-42.71	-18.38	-0.86	-13.00	-48.95
86.26	-62.35	-54.52	-6.67	-1.16	-13.00	-49.35
119.24	-45.25	-36.76	-7.04	-1.45	-13.00	-32.25
206.54	-60.17	-56.28	-1.81	-2.08	-13.00	-47.17
272.50	-66.20	-62.26	-1.63	-2.31	-13.00	-53.20
369.50	-67.52	-63.15	-1.48	-2.89	-13.00	-54.52
3440.00	-41.49	-42.92	12.62	-11.19	-13.00	-28.49
3463.40	-41.37	-42.85	12.52	-11.04	-13.00	-28.37

Unless otherwise stated the results shown in this test report refer only to the sample(s) tested and such sample(s) are retained for 90 days only.

除非另有說明，此報告結果僅對測試之樣品負責，同時此樣品僅保留90天。本報告未經本公司書面許可，不可部份複製。

This document is issued by the Company subject to its General Conditions of Service printed overleaf, available on request or accessible at <http://www.sgs.com.tw/Terms-and-Conditions> and for electronic format documents, subject to Terms and Conditions for Electronic Documents at <http://www.sgs.com.tw/Terms-and-Conditions>. Attention is drawn to the limitation of liability, indemnification and jurisdiction issues defined therein. Any holder of this document is advised that information contained hereon reflects the Company's findings at the time of its intervention only and within the limits of Client's instructions, if any. The Company's sole responsibility is to its Client and this document does not exonerate parties to a transaction from exercising all their rights and obligations under the transaction documents. This document cannot be reproduced except in full, without prior written approval of the Company. Any unauthorized alteration, forgery or falsification of the content or appearance of this document is unlawful and offenders may be prosecuted to the fullest extent of the law.

Report Number :E2/2019/A0032
 Operation Mode :LTE B66C
 Test Mode :TX CH MID
 EUT Pol :E2 Plan
 Test Frequency :1752.5+1764.2 MHz

Test Date :2020-03-17
 Temp./Humi. :23.5/57
 Antenna Pol. :VERTICAL
 Engineer :Enzo

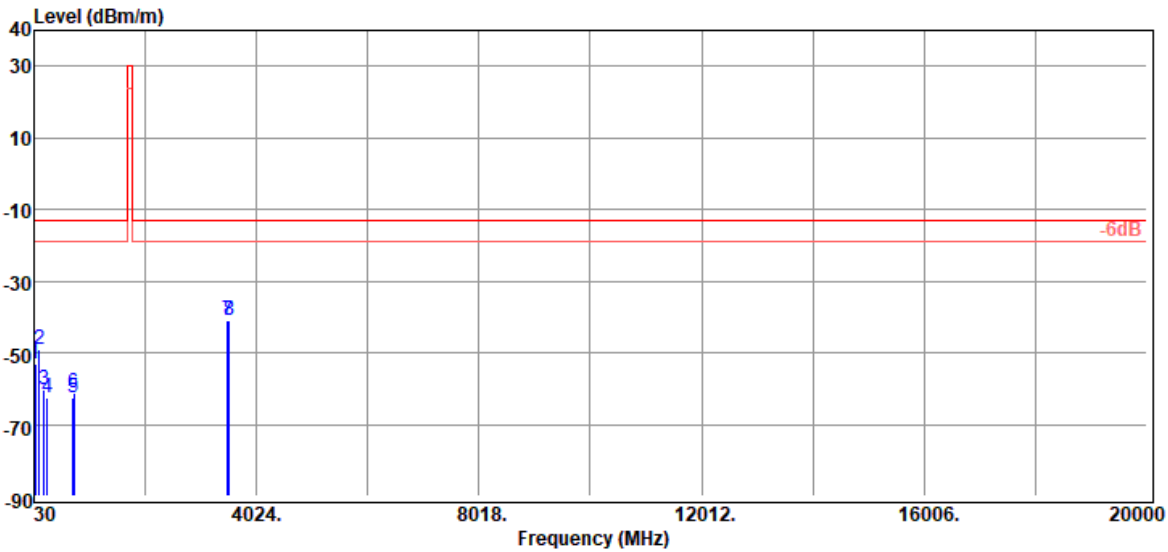

Freq. MHz	EIRP/ERP dBm	SG Output Level dBm	Antenna Gain dBi/dBd	Cable Loss dB	Limit dBm	Margin dB
47.46	-52.96	-34.03	-18.07	-0.86	-13.00	-39.96
118.27	-48.87	-40.34	-7.08	-1.45	-13.00	-35.87
205.57	-60.28	-56.33	-1.87	-2.08	-13.00	-47.28
274.44	-62.38	-58.40	-1.65	-2.33	-13.00	-49.38
734.22	-62.35	-56.67	-1.42	-4.26	-13.00	-49.35
745.86	-61.16	-55.36	-1.61	-4.19	-13.00	-48.16
3505.00	-40.84	-42.31	12.30	-10.83	-13.00	-27.84
3528.40	-40.93	-42.30	12.30	-10.93	-13.00	-27.93

Unless otherwise stated the results shown in this test report refer only to the sample(s) tested and such sample(s) are retained for 90 days only.

除非另有說明，此報告結果僅對測試之樣品負責，同時此樣品僅保留90天。本報告未經本公司書面許可，不可部份複製。

This document is issued by the Company subject to its General Conditions of Service printed overleaf, available on request or accessible at <http://www.sgs.com.tw/Terms-and-Conditions> and for electronic format documents, subject to Terms and Conditions for Electronic Documents at <http://www.sgs.com.tw/Terms-and-Conditions>. Attention is drawn to the limitation of liability, indemnification and jurisdiction issues defined therein. Any holder of this document is advised that information contained hereon reflects the Company's findings at the time of its intervention only and within the limits of Client's instructions, if any. The Company's sole responsibility is to its Client and this document does not exonerate parties to a transaction from exercising all their rights and obligations under the transaction documents. This document cannot be reproduced except in full, without prior written approval of the Company. Any unauthorized alteration, forgery or falsification of the content or appearance of this document is unlawful and offenders may be prosecuted to the fullest extent of the law.

Report Number :E2/2019/A0032
 Operation Mode :LTE B66C
 Test Mode :TX CH MID
 EUT Pol :E2 Plan
 Test Frequency :1752.5+1764.2 MHz

Test Date :2020-03-17
 Temp./Humi. :23.5/57
 Antenna Pol. :HORIZONTAL
 Engineer :Enzo

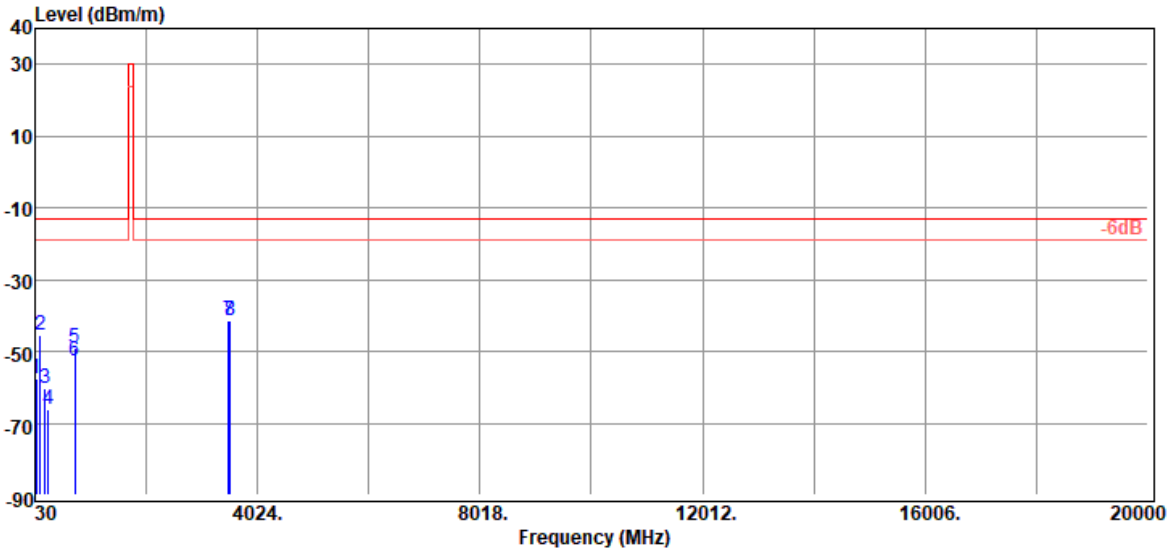

Freq. MHz	EIRP/ERP dBm	SG Output Level dBm	Antenna Gain dBi/dBd	Cable Loss dB	Limit dBm	Margin dB
45.52	-57.78	-38.54	-18.38	-0.86	-13.00	-44.78
118.27	-45.27	-36.74	-7.08	-1.45	-13.00	-32.27
205.57	-60.33	-56.38	-1.87	-2.08	-13.00	-47.33
275.41	-66.13	-62.13	-1.65	-2.35	-13.00	-53.13
738.10	-49.24	-43.53	-1.50	-4.21	-13.00	-36.24
747.80	-52.72	-46.91	-1.62	-4.19	-13.00	-39.72
3505.00	-41.20	-42.67	12.30	-10.83	-13.00	-28.20
3528.40	-41.22	-42.59	12.30	-10.93	-13.00	-28.22

Unless otherwise stated the results shown in this test report refer only to the sample(s) tested and such sample(s) are retained for 90 days only.

除非另有說明，此報告結果僅對測試之樣品負責，同時此樣品僅保留90天。本報告未經本公司書面許可，不可部份複製。

This document is issued by the Company subject to its General Conditions of Service printed overleaf, available on request or accessible at <http://www.sgs.com.tw/Terms-and-Conditions> and for electronic format documents, subject to Terms and Conditions for Electronic Documents at <http://www.sgs.com.tw/Terms-and-Conditions>. Attention is drawn to the limitation of liability, indemnification and jurisdiction issues defined therein. Any holder of this document is advised that information contained hereon reflects the Company's findings at the time of its intervention only and within the limits of Client's instructions, if any. The Company's sole responsibility is to its Client and this document does not exonerate parties to a transaction from exercising all their rights and obligations under the transaction documents. This document cannot be reproduced except in full, without prior written approval of the Company. Any unauthorized alteration, forgery or falsification of the content or appearance of this document is unlawful and offenders may be prosecuted to the fullest extent of the law.

Report Number :E2/2019/A0032
 Operation Mode :LTE B66C
 Test Mode :TX CH HIGH
 EUT Pol :E2 Plan
 Test Frequency :1765+1776.7 MHz

Test Date :2020-03-17
 Temp./Humi. :23.5/57
 Antenna Pol. :VERTICAL
 Engineer :Enzo

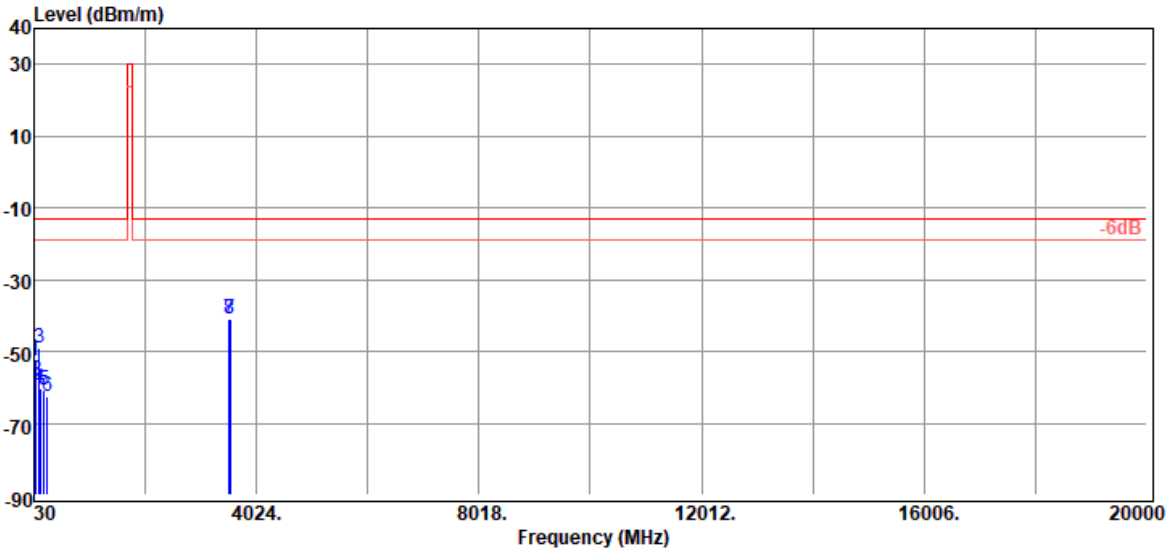

Freq. MHz	EIRP/ERP dBm	SG Output Level dBm	Antenna Gain dBi/dBd	Cable Loss dB	Limit dBm	Margin dB
48.43	-52.64	-33.89	-17.89	-0.86	-13.00	-39.64
64.92	-57.85	-43.14	-13.71	-1.00	-13.00	-44.85
118.27	-48.89	-40.36	-7.08	-1.45	-13.00	-35.89
142.52	-60.47	-51.14	-7.66	-1.67	-13.00	-47.47
205.57	-60.96	-57.01	-1.87	-2.08	-13.00	-47.96
272.50	-62.56	-58.62	-1.63	-2.31	-13.00	-49.56
3530.00	-40.98	-42.34	12.30	-10.94	-13.00	-27.98
3553.40	-41.07	-42.32	12.29	-11.04	-13.00	-28.07

Unless otherwise stated the results shown in this test report refer only to the sample(s) tested and such sample(s) are retained for 90 days only.

除非另有說明，此報告結果僅對測試之樣品負責，同時此樣品僅保留90天。本報告未經本公司書面許可，不可部份複製。

This document is issued by the Company subject to its General Conditions of Service printed overleaf, available on request or accessible at <http://www.sgs.com.tw/Terms-and-Conditions> and for electronic format documents, subject to Terms and Conditions for Electronic Documents at <http://www.sgs.com.tw/Terms-and-Conditions>. Attention is drawn to the limitation of liability, indemnification and jurisdiction issues defined therein. Any holder of this document is advised that information contained hereon reflects the Company's findings at the time of its intervention only and within the limits of Client's instructions, if any. The Company's sole responsibility is to its Client and this document does not exonerate parties to a transaction from exercising all their rights and obligations under the transaction documents. This document cannot be reproduced except in full, without prior written approval of the Company. Any unauthorized alteration, forgery or falsification of the content or appearance of this document is unlawful and offenders may be prosecuted to the fullest extent of the law.

Report Number :E2/2019/A0032
 Operation Mode :LTE B66C
 Test Mode :TX CH HIGH
 EUT Pol :E2 Plan
 Test Frequency :1765+1776.7 MHz

Test Date :2020-03-17
 Temp./Humi. :23.5/57
 Antenna Pol. :HORIZONTAL
 Engineer :Enzo

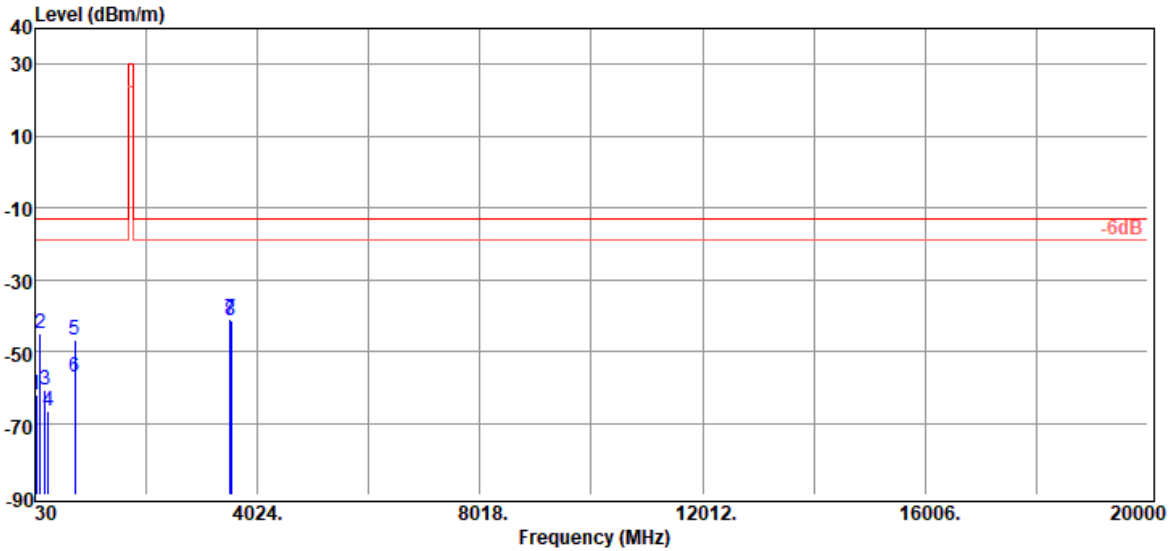

Freq. MHz	EIRP/ERP dBm	SG Output Level dBm	Antenna Gain dBi/dBd	Cable Loss dB	Limit dBm	Margin dB
45.52	-62.12	-42.88	-18.38	-0.86	-13.00	-49.12
119.24	-45.11	-36.62	-7.04	-1.45	-13.00	-32.11
205.57	-60.57	-56.62	-1.87	-2.08	-13.00	-47.57
270.56	-66.79	-62.90	-1.61	-2.28	-13.00	-53.79
739.07	-46.69	-40.96	-1.53	-4.20	-13.00	-33.69
747.80	-57.09	-51.28	-1.62	-4.19	-13.00	-44.09
3530.00	-41.18	-42.54	12.30	-10.94	-13.00	-28.18
3553.40	-41.31	-42.56	12.29	-11.04	-13.00	-28.31

Unless otherwise stated the results shown in this test report refer only to the sample(s) tested and such sample(s) are retained for 90 days only.

除非另有說明，此報告結果僅對測試之樣品負責，同時此樣品僅保留90天。本報告未經本公司書面許可，不可部份複製。

This document is issued by the Company subject to its General Conditions of Service printed overleaf, available on request or accessible at <http://www.sgs.com.tw/Terms-and-Conditions> and for electronic format documents, subject to Terms and Conditions for Electronic Documents at <http://www.sgs.com.tw/Terms-and-Conditions>. Attention is drawn to the limitation of liability, indemnification and jurisdiction issues defined therein. Any holder of this document is advised that information contained hereon reflects the Company's findings at the time of its intervention only and within the limits of Client's instructions, if any. The Company's sole responsibility is to its Client and this document does not exonerate parties to a transaction from exercising all their rights and obligations under the transaction documents. This document cannot be reproduced except in full, without prior written approval of the Company. Any unauthorized alteration, forgery or falsification of the content or appearance of this document is unlawful and offenders may be prosecuted to the fullest extent of the law.

Radiated Spurious Emission Measurement Result: LTE Band 2 + LTE Band 5 Mode

Report Number	:E2/2019/A0032	Test Date	:2020-02-17
Operation Mode	:LTE B2+B5	Temp./Humi.	:21.8/41
Test Mode	:TX CH LOW	Antenna Pol.	:VERTICAL
EUT Pol	:E2 Plan	Engineer	:Enzo
Test Frequency	:1852.5 MHz +826.5 MHz		

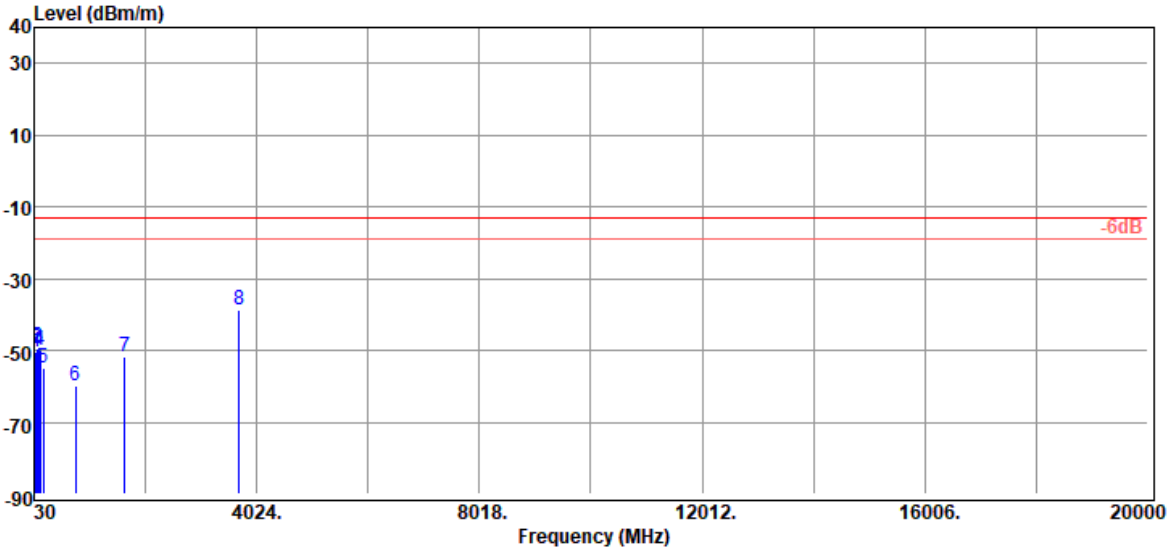

Freq. MHz	EIRP/ERP dBm	SG Output Level dBm	Antenna Gain dBi/dBd	Cable Loss dB	Limit dBm	Margin dB
59.10	-50.55	-34.06	-15.50	-0.99	-13.00	-37.55
77.53	-49.70	-39.43	-9.15	-1.12	-13.00	-36.70
116.33	-48.99	-40.41	-7.13	-1.45	-13.00	-35.99
145.43	-50.07	-40.77	-7.63	-1.67	-13.00	-37.07
200.72	-54.75	-50.58	-2.09	-2.08	-13.00	-41.75
772.05	-59.66	-53.72	-1.59	-4.35	-13.00	-46.66
1653.00	-51.57	-53.35	9.33	-7.55	-13.00	-38.57
3705.00	-38.92	-39.92	12.31	-11.31	-13.00	-25.92

Unless otherwise stated the results shown in this test report refer only to the sample(s) tested and such sample(s) are retained for 90 days only.

除非另有說明，此報告結果僅對測試之樣品負責，同時此樣品僅保留90天。本報告未經本公司書面許可，不可部份複製。

This document is issued by the Company subject to its General Conditions of Service printed overleaf, available on request or accessible at <http://www.sgs.com.tw/Terms-and-Conditions> and for electronic format documents, subject to Terms and Conditions for Electronic Documents at <http://www.sgs.com.tw/Terms-and-Conditions>. Attention is drawn to the limitation of liability, indemnification and jurisdiction issues defined therein. Any holder of this document is advised that information contained hereon reflects the Company's findings at the time of its intervention only and within the limits of Client's instructions, if any. The Company's sole responsibility is to its Client and this document does not exonerate parties to a transaction from exercising all their rights and obligations under the transaction documents. This document cannot be reproduced except in full, without prior written approval of the Company. Any unauthorized alteration, forgery or falsification of the content or appearance of this document is unlawful and offenders may be prosecuted to the fullest extent of the law.

Report Number :E2/2019/A0032
 Operation Mode :LTE B2+B5
 Test Mode :TX CH LOW
 EUT Pol :E2 Plan
 Test Frequency :1852.5 MHz +826.5 MHz

Test Date :2020-02-17
 Temp./Humi. :21.8/41
 Antenna Pol. :HORIZONTAL
 Engineer :Enzo

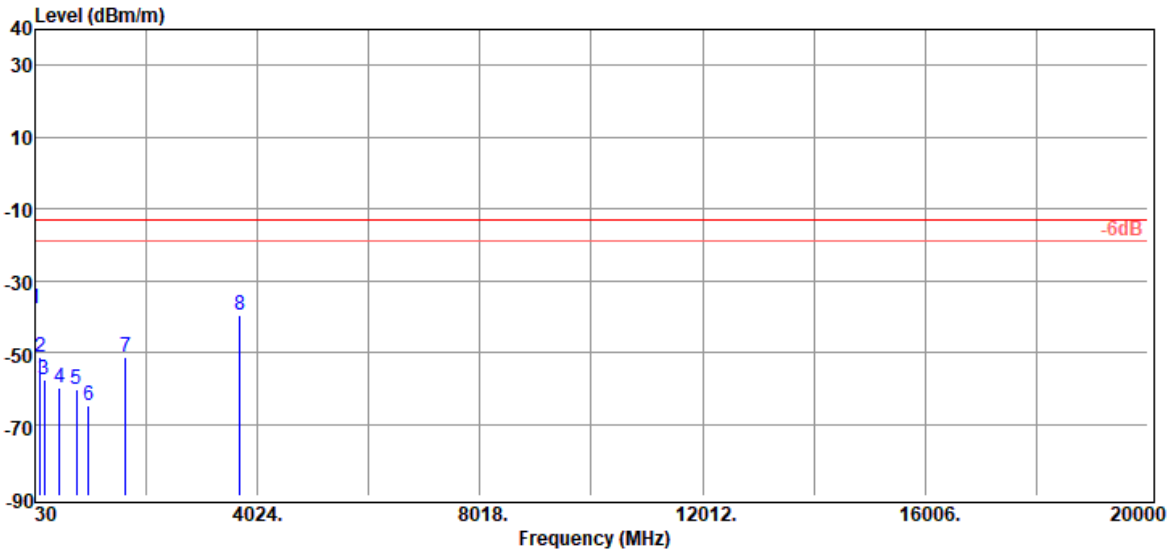

Freq. MHz	EIRP/ERP dBm	SG Output Level dBm	Antenna Gain dBi/dBd	Cable Loss dB	Limit dBm	Margin dB
35.82	-37.89	-17.49	-19.64	-0.76	-13.00	-24.89
117.30	-51.53	-42.99	-7.09	-1.45	-13.00	-38.53
190.05	-57.52	-52.70	-2.95	-1.87	-13.00	-44.52
464.56	-60.06	-55.50	-1.29	-3.27	-13.00	-47.06
772.05	-60.53	-54.59	-1.59	-4.35	-13.00	-47.53
987.39	-65.01	-58.60	-1.50	-4.91	-13.00	-52.01
1653.00	-51.43	-53.21	9.33	-7.55	-13.00	-38.43
3705.00	-39.67	-40.67	12.31	-11.31	-13.00	-26.67

Unless otherwise stated the results shown in this test report refer only to the sample(s) tested and such sample(s) are retained for 90 days only.

除非另有說明，此報告結果僅對測試之樣品負責，同時此樣品僅保留90天。本報告未經本公司書面許可，不可部份複製。

This document is issued by the Company subject to its General Conditions of Service printed overleaf, available on request or accessible at <http://www.sgs.com.tw/Terms-and-Conditions> and for electronic format documents, subject to Terms and Conditions for Electronic Documents at <http://www.sgs.com.tw/Terms-and-Conditions>. Attention is drawn to the limitation of liability, indemnification and jurisdiction issues defined therein. Any holder of this document is advised that information contained hereon reflects the Company's findings at the time of its intervention only and within the limits of Client's instructions, if any. The Company's sole responsibility is to its Client and this document does not exonerate parties to a transaction from exercising all their rights and obligations under the transaction documents. This document cannot be reproduced except in full, without prior written approval of the Company. Any unauthorized alteration, forgery or falsification of the content or appearance of this document is unlawful and offenders may be prosecuted to the fullest extent of the law.

Report Number	:E2/2019/A0032	Test Date	:2020-02-17
Operation Mode	:LTE B2+B5	Temp./Humi.	:21.8/41
Test Mode	:TX CH MID	Antenna Pol.	:VERTICAL
EUT Pol	:E2 Plan	Engineer	:Enzo
Test Frequency	:1880 MHz +836.5 MHz		

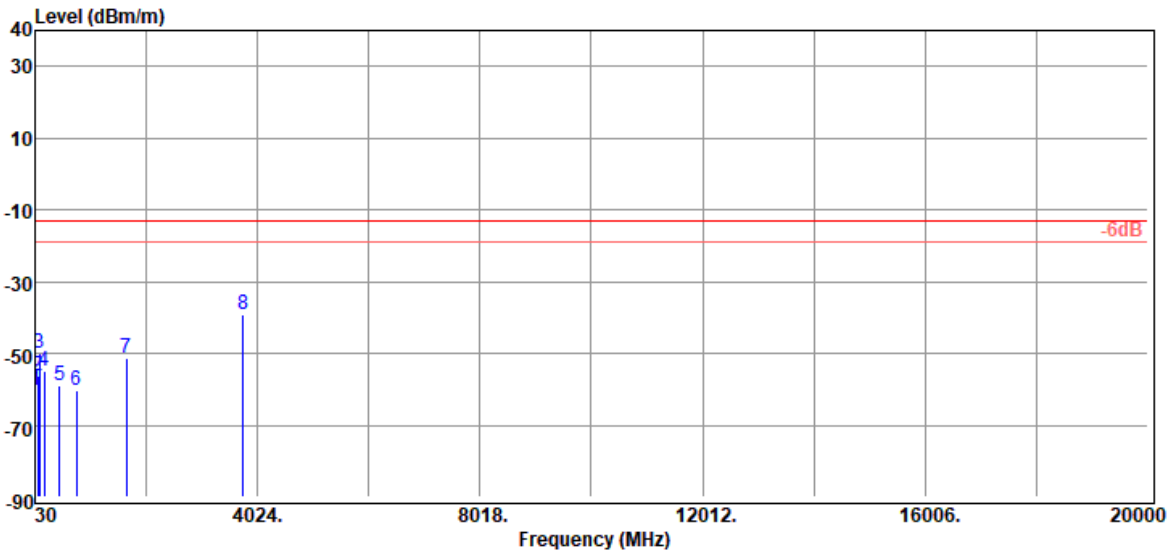

Freq. MHz	EIRP/ERP dBm	SG Output Level dBm	Antenna Gain dBi/dBd	Cable Loss dB	Limit dBm	Margin dB
38.73	-60.40	-40.32	-19.25	-0.83	-13.00	-47.40
81.41	-56.08	-46.98	-7.94	-1.16	-13.00	-43.08
115.36	-49.76	-41.17	-7.14	-1.45	-13.00	-36.76
200.72	-55.02	-50.85	-2.09	-2.08	-13.00	-42.02
476.20	-59.05	-54.65	-1.29	-3.11	-13.00	-46.05
773.02	-60.22	-54.27	-1.57	-4.38	-13.00	-47.22
1673.00	-51.29	-53.14	9.53	-7.68	-13.00	-38.29
3760.00	-39.01	-40.35	12.42	-11.08	-13.00	-26.01

Unless otherwise stated the results shown in this test report refer only to the sample(s) tested and such sample(s) are retained for 90 days only.

除非另有說明，此報告結果僅對測試之樣品負責，同時此樣品僅保留90天。本報告未經本公司書面許可，不可部份複製。

This document is issued by the Company subject to its General Conditions of Service printed overleaf, available on request or accessible at <http://www.sgs.com.tw/Terms-and-Conditions> and for electronic format documents, subject to Terms and Conditions for Electronic Documents at <http://www.sgs.com.tw/Terms-and-Conditions>. Attention is drawn to the limitation of liability, indemnification and jurisdiction issues defined therein. Any holder of this document is advised that information contained hereon reflects the Company's findings at the time of its intervention only and within the limits of Client's instructions, if any. The Company's sole responsibility is to its Client and this document does not exonerate parties to a transaction from exercising all their rights and obligations under the transaction documents. This document cannot be reproduced except in full, without prior written approval of the Company. Any unauthorized alteration, forgery or falsification of the content or appearance of this document is unlawful and offenders may be prosecuted to the fullest extent of the law.

SGS Taiwan Ltd.

台灣檢驗科技股份有限公司

No.134,Wu Kung Road, New Taipei Industrial Park, Wuku District, New Taipei City, Taiwan/新北市五股區新北產業園區五工路 134 號

t (886-2) 2299-3279

f (886-2) 2298-0488

www.sgs.com.tw

Member of SGS Group

Report Number :E2/2019/A0032
 Operation Mode :LTE B2+B5
 Test Mode :TX CH MID
 EUT Pol :E2 Plan
 Test Frequency :1880 MHz +836.5 MHz

Test Date :2020-02-17
 Temp./Humi. :21.8/41
 Antenna Pol. :HORIZONTAL
 Engineer :Enzo

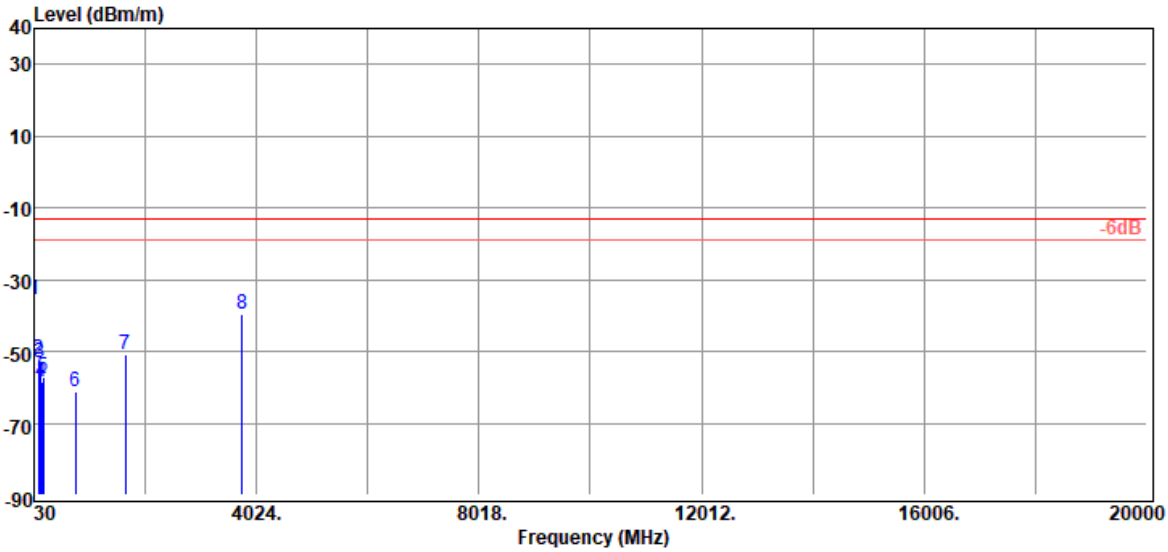

Freq. MHz	EIRP/ERP dBm	SG Output Level dBm	Antenna Gain dBi/dBd	Cable Loss dB	Limit dBm	Margin dB
34.85	-35.71	-15.21	-19.77	-0.73	-13.00	-22.71
116.33	-52.20	-43.62	-7.13	-1.45	-13.00	-39.20
139.61	-53.13	-43.83	-7.64	-1.66	-13.00	-40.13
163.86	-58.56	-50.20	-6.66	-1.70	-13.00	-45.56
191.02	-57.15	-52.44	-2.82	-1.89	-13.00	-44.15
773.02	-61.40	-55.45	-1.57	-4.38	-13.00	-48.40
1673.00	-50.98	-52.83	9.53	-7.68	-13.00	-37.98
3760.00	-39.64	-40.98	12.42	-11.08	-13.00	-26.64

Unless otherwise stated the results shown in this test report refer only to the sample(s) tested and such sample(s) are retained for 90 days only.

除非另有說明，此報告結果僅對測試之樣品負責，同時此樣品僅保留90天。本報告未經本公司書面許可，不可部份複製。

This document is issued by the Company subject to its General Conditions of Service printed overleaf, available on request or accessible at <http://www.sgs.com.tw/Terms-and-Conditions> and for electronic format documents, subject to Terms and Conditions for Electronic Documents at <http://www.sgs.com.tw/Terms-and-Conditions>. Attention is drawn to the limitation of liability, indemnification and jurisdiction issues defined therein. Any holder of this document is advised that information contained hereon reflects the Company's findings at the time of its intervention only and within the limits of Client's instructions, if any. The Company's sole responsibility is to its Client and this document does not exonerate parties to a transaction from exercising all their rights and obligations under the transaction documents. This document cannot be reproduced except in full, without prior written approval of the Company. Any unauthorized alteration, forgery or falsification of the content or appearance of this document is unlawful and offenders may be prosecuted to the fullest extent of the law.

Report Number	:E2/2019/A0032	Test Date	:2020-02-17
Operation Mode	:LTE B2+B5	Temp./Humi.	:21.8/41
Test Mode	:TX CH HIGH	Antenna Pol.	:VERTICAL
EUT Pol	:E2 Plan	Engineer	:Enzo
Test Frequency	:1907.5 MHz + 846.5 MHz		

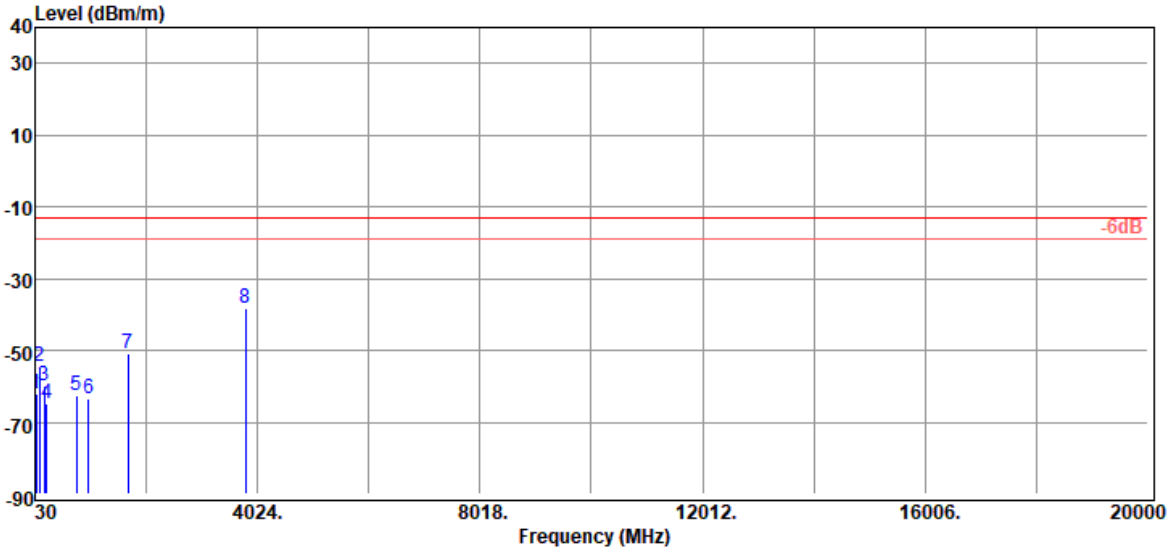

Freq. MHz	EIRP/ERP dBm	SG Output Level dBm	Antenna Gain dBi/dBd	Cable Loss dB	Limit dBm	Margin dB
55.22	-62.07	-44.66	-16.48	-0.93	-13.00	-49.07
116.33	-54.34	-45.76	-7.13	-1.45	-13.00	-41.34
199.75	-59.81	-55.61	-2.13	-2.07	-13.00	-46.81
242.43	-64.89	-60.86	-1.80	-2.23	-13.00	-51.89
772.05	-62.37	-56.43	-1.59	-4.35	-13.00	-49.37
988.36	-63.60	-57.18	-1.51	-4.91	-13.00	-50.60
1693.00	-51.05	-52.97	9.73	-7.81	-13.00	-38.05
3815.00	-38.32	-39.93	12.50	-10.89	-13.00	-25.32

Unless otherwise stated the results shown in this test report refer only to the sample(s) tested and such sample(s) are retained for 90 days only.

除非另有說明，此報告結果僅對測試之樣品負責，同時此樣品僅保留90天。本報告未經本公司書面許可，不可部份複製。

This document is issued by the Company subject to its General Conditions of Service printed overleaf, available on request or accessible at <http://www.sgs.com.tw/Terms-and-Conditions> and for electronic format documents, subject to Terms and Conditions for Electronic Documents at <http://www.sgs.com.tw/Terms-and-Conditions>. Attention is drawn to the limitation of liability, indemnification and jurisdiction issues defined therein. Any holder of this document is advised that information contained hereon reflects the Company's findings at the time of its intervention only and within the limits of Client's instructions, if any. The Company's sole responsibility is to its Client and this document does not exonerate parties to a transaction from exercising all their rights and obligations under the transaction documents. This document cannot be reproduced except in full, without prior written approval of the Company. Any unauthorized alteration, forgery or falsification of the content or appearance of this document is unlawful and offenders may be prosecuted to the fullest extent of the law.

Report Number :E2/2019/A0032
 Operation Mode :LTE B2+B5
 Test Mode :TX CH HIGH
 EUT Pol :E2 Plan
 Test Frequency :1907.5 MHz + 846.5 MHz

Test Date :2020-02-17
 Temp./Humi. :21.8/41
 Antenna Pol. :HORIZONTAL
 Engineer :Enzo

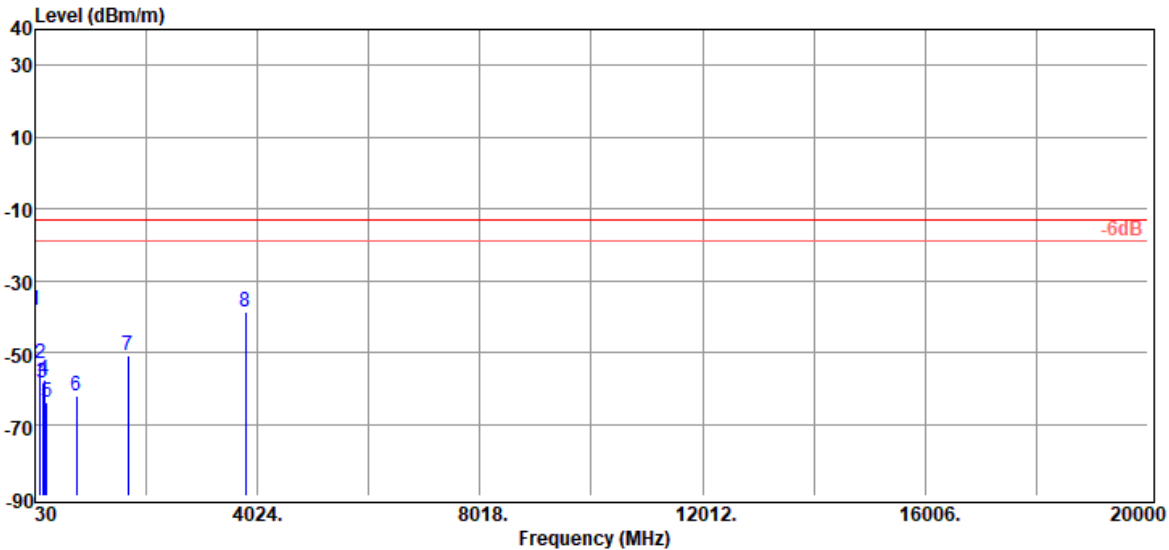

Freq. MHz	EIRP/ERP dBm	SG Output Level dBm	Antenna Gain dBi/dBd	Cable Loss dB	Limit dBm	Margin dB
33.88	-38.27	-17.72	-19.84	-0.71	-13.00	-25.27
117.30	-53.17	-44.63	-7.09	-1.45	-13.00	-40.17
166.77	-58.46	-50.24	-6.50	-1.72	-13.00	-45.46
190.05	-57.70	-52.88	-2.95	-1.87	-13.00	-44.70
242.43	-63.75	-59.72	-1.80	-2.23	-13.00	-50.75
772.05	-62.15	-56.21	-1.59	-4.35	-13.00	-49.15
1693.00	-50.86	-52.78	9.73	-7.81	-13.00	-37.86
3815.00	-38.64	-40.25	12.50	-10.89	-13.00	-25.64

Unless otherwise stated the results shown in this test report refer only to the sample(s) tested and such sample(s) are retained for 90 days only.

除非另有說明，此報告結果僅對測試之樣品負責，同時此樣品僅保留90天。本報告未經本公司書面許可，不可部份複製。

This document is issued by the Company subject to its General Conditions of Service printed overleaf, available on request or accessible at <http://www.sgs.com.tw/Terms-and-Conditions> and for electronic format documents, subject to Terms and Conditions for Electronic Documents at <http://www.sgs.com.tw/Terms-and-Conditions>. Attention is drawn to the limitation of liability, indemnification and jurisdiction issues defined therein. Any holder of this document is advised that information contained hereon reflects the Company's findings at the time of its intervention only and within the limits of Client's instructions, if any. The Company's sole responsibility is to its Client and this document does not exonerate parties to a transaction from exercising all their rights and obligations under the transaction documents. This document cannot be reproduced except in full, without prior written approval of the Company. Any unauthorized alteration, forgery or falsification of the content or appearance of this document is unlawful and offenders may be prosecuted to the fullest extent of the law.

Radiated Spurious Emission Measurement Result: LTE Band 2 + LTE Band 12 Mode

Report Number	:E2/2019/A0032	Test Date	:2020-02-17
Operation Mode	:LTE B2+B12	Temp./Humi.	:21.8/41
Test Mode	:TX CH LOW	Antenna Pol.	:VERTICAL
EUT Pol	:E2 Plan	Engineer	:Enzo
Test Frequency	:1860 MHz+701.5 MHz		

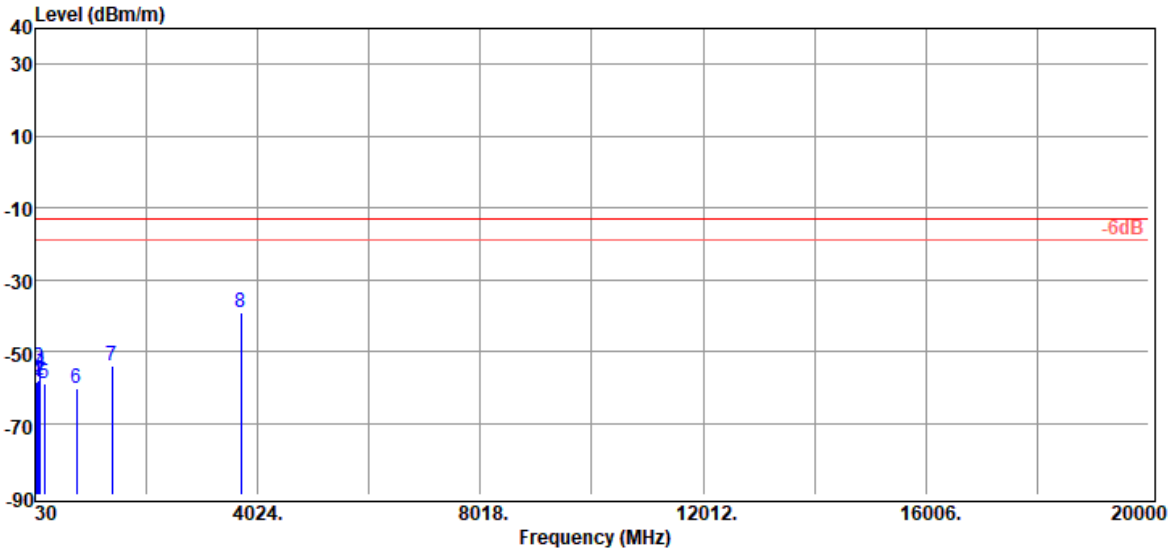

Freq. MHz	EIRP/ERP dBm	SG Output Level dBm	Antenna Gain dBi/dBd	Cable Loss dB	Limit dBm	Margin dB
60.07	-58.67	-42.41	-15.26	-1.00	-13.00	-45.67
96.93	-58.24	-51.07	-5.89	-1.28	-13.00	-45.24
104.69	-54.59	-46.42	-6.78	-1.39	-13.00	-41.59
119.24	-55.63	-47.14	-7.04	-1.45	-13.00	-42.63
193.93	-59.14	-54.61	-2.58	-1.95	-13.00	-46.14
771.08	-60.21	-54.30	-1.60	-4.31	-13.00	-47.21
1403.00	-53.87	-54.36	7.02	-6.53	-13.00	-40.87
3720.00	-39.24	-40.33	12.34	-11.25	-13.00	-26.24

Unless otherwise stated the results shown in this test report refer only to the sample(s) tested and such sample(s) are retained for 90 days only.

除非另有說明，此報告結果僅對測試之樣品負責，同時此樣品僅保留90天。本報告未經本公司書面許可，不可部份複製。

This document is issued by the Company subject to its General Conditions of Service printed overleaf, available on request or accessible at <http://www.sgs.com.tw/Terms-and-Conditions> and for electronic format documents, subject to Terms and Conditions for Electronic Documents at <http://www.sgs.com.tw/Terms-and-Conditions>. Attention is drawn to the limitation of liability, indemnification and jurisdiction issues defined therein. Any holder of this document is advised that information contained hereon reflects the Company's findings at the time of its intervention only and within the limits of Client's instructions, if any. The Company's sole responsibility is to its Client and this document does not exonerate parties to a transaction from exercising all their rights and obligations under the transaction documents. This document cannot be reproduced except in full, without prior written approval of the Company. Any unauthorized alteration, forgery or falsification of the content or appearance of this document is unlawful and offenders may be prosecuted to the fullest extent of the law.

Report Number :E2/2019/A0032
 Operation Mode :LTE B2+B12
 Test Mode :TX CH LOW
 EUT Pol :E2 Plan
 Test Frequency :1860 MHz+701.5 MHz

Test Date :2020-02-17
 Temp./Humi. :21.8/41
 Antenna Pol. :HORIZONTAL
 Engineer :Enzo

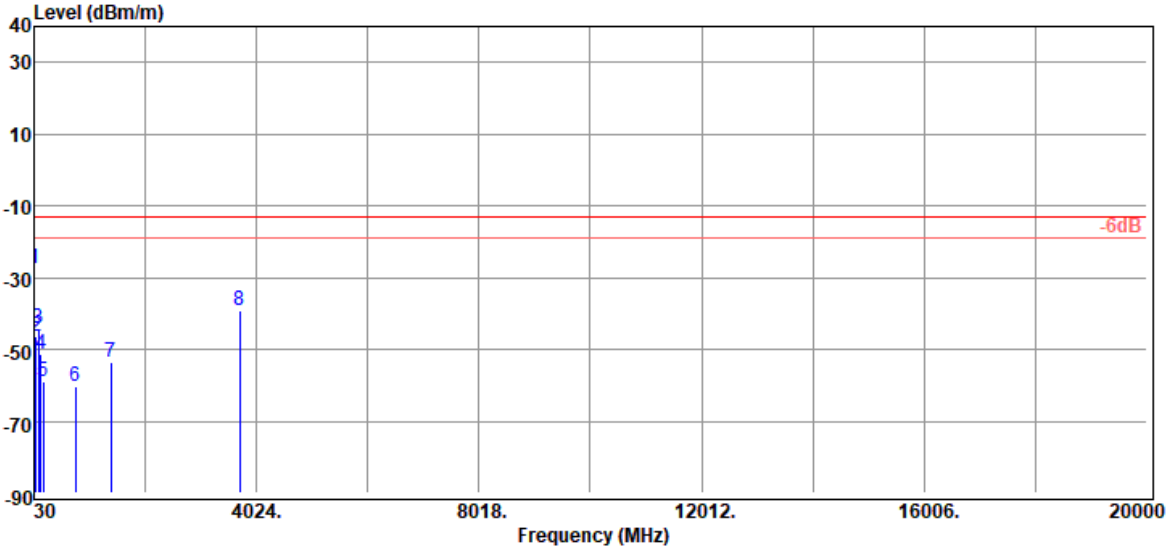

Freq. MHz	EIRP/ERP dBm	SG Output Level dBm	Antenna Gain dBi/dBd	Cable Loss dB	Limit dBm	Margin dB
32.91	-27.58	-6.81	-20.09	-0.68	-13.00	-14.58
68.80	-46.31	-32.86	-12.45	-1.00	-13.00	-33.31
111.48	-44.13	-35.59	-7.09	-1.45	-13.00	-31.13
148.34	-51.11	-41.92	-7.51	-1.68	-13.00	-38.11
195.87	-58.93	-54.54	-2.40	-1.99	-13.00	-45.93
772.05	-60.31	-54.37	-1.59	-4.35	-13.00	-47.31
1403.00	-53.76	-54.25	7.02	-6.53	-13.00	-40.76
3720.00	-39.07	-40.16	12.34	-11.25	-13.00	-26.07

Unless otherwise stated the results shown in this test report refer only to the sample(s) tested and such sample(s) are retained for 90 days only.

除非另有說明，此報告結果僅對測試之樣品負責，同時此樣品僅保留90天。本報告未經本公司書面許可，不可部份複製。

This document is issued by the Company subject to its General Conditions of Service printed overleaf, available on request or accessible at <http://www.sgs.com.tw/Terms-and-Conditions> and for electronic format documents, subject to Terms and Conditions for Electronic Documents at <http://www.sgs.com.tw/Terms-and-Conditions>. Attention is drawn to the limitation of liability, indemnification and jurisdiction issues defined therein. Any holder of this document is advised that information contained hereon reflects the Company's findings at the time of its intervention only and within the limits of Client's instructions, if any. The Company's sole responsibility is to its Client and this document does not exonerate parties to a transaction from exercising all their rights and obligations under the transaction documents. This document cannot be reproduced except in full, without prior written approval of the Company. Any unauthorized alteration, forgery or falsification of the content or appearance of this document is unlawful and offenders may be prosecuted to the fullest extent of the law.

Report Number :E2/2019/A0032
 Operation Mode :LTE B2+B12
 Test Mode :TX CH MID
 EUT Pol :E2 Plan
 Test Frequency :1880 MHz +707.5 MHz

Test Date :2020-02-17
 Temp./Humi. :21.8/41
 Antenna Pol. :VERTICAL
 Engineer :Enzo

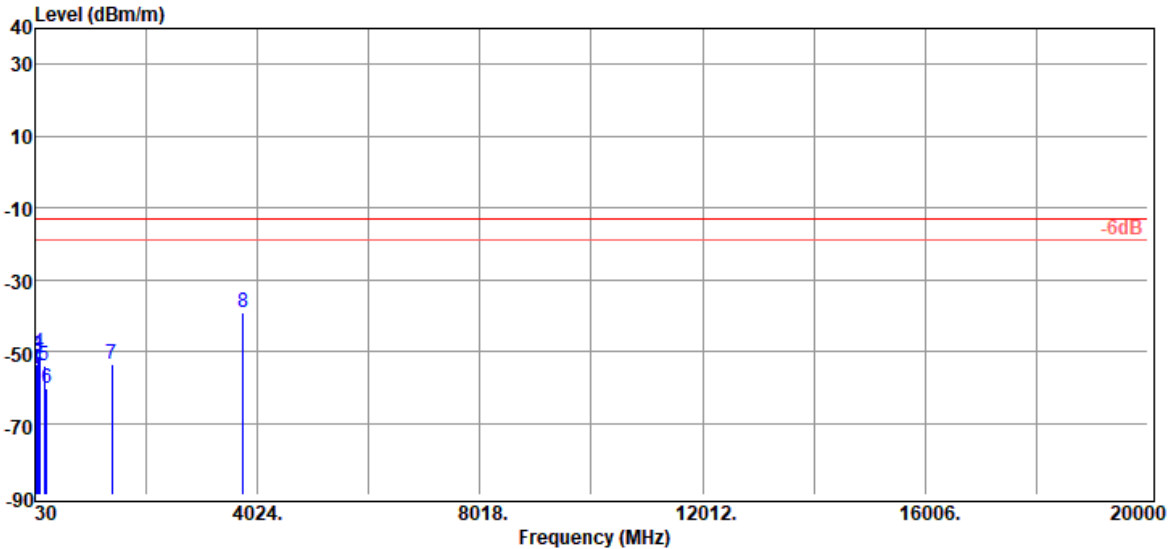

Freq. MHz	EIRP/ERP dBm	SG Output Level dBm	Antenna Gain dBi/dBd	Cable Loss dB	Limit dBm	Margin dB
35.82	-54.95	-34.55	-19.64	-0.76	-13.00	-41.95
59.10	-53.36	-36.87	-15.50	-0.99	-13.00	-40.36
81.41	-51.47	-42.37	-7.94	-1.16	-13.00	-38.47
114.39	-50.35	-41.79	-7.11	-1.45	-13.00	-37.35
202.66	-54.11	-50.03	-2.00	-2.08	-13.00	-41.11
236.61	-60.29	-56.31	-1.76	-2.22	-13.00	-47.29
1415.00	-53.76	-54.33	7.12	-6.55	-13.00	-40.76
3760.00	-39.04	-40.38	12.42	-11.08	-13.00	-26.04

Unless otherwise stated the results shown in this test report refer only to the sample(s) tested and such sample(s) are retained for 90 days only.

除非另有說明，此報告結果僅對測試之樣品負責，同時此樣品僅保留90天。本報告未經本公司書面許可，不可部份複製。

This document is issued by the Company subject to its General Conditions of Service printed overleaf, available on request or accessible at <http://www.sgs.com.tw/Terms-and-Conditions> and for electronic format documents, subject to Terms and Conditions for Electronic Documents at <http://www.sgs.com.tw/Terms-and-Conditions>. Attention is drawn to the limitation of liability, indemnification and jurisdiction issues defined therein. Any holder of this document is advised that information contained hereon reflects the Company's findings at the time of its intervention only and within the limits of Client's instructions, if any. The Company's sole responsibility is to its Client and this document does not exonerate parties to a transaction from exercising all their rights and obligations under the transaction documents. This document cannot be reproduced except in full, without prior written approval of the Company. Any unauthorized alteration, forgery or falsification of the content or appearance of this document is unlawful and offenders may be prosecuted to the fullest extent of the law.

Report Number :E2/2019/A0032
 Operation Mode :LTE B2+B12
 Test Mode :TX CH MID
 EUT Pol :E2 Plan
 Test Frequency :1880 MHz +707.5 MHz

Test Date :2020-02-17
 Temp./Humi. :21.8/41
 Antenna Pol. :HORIZONTAL
 Engineer :Enzo

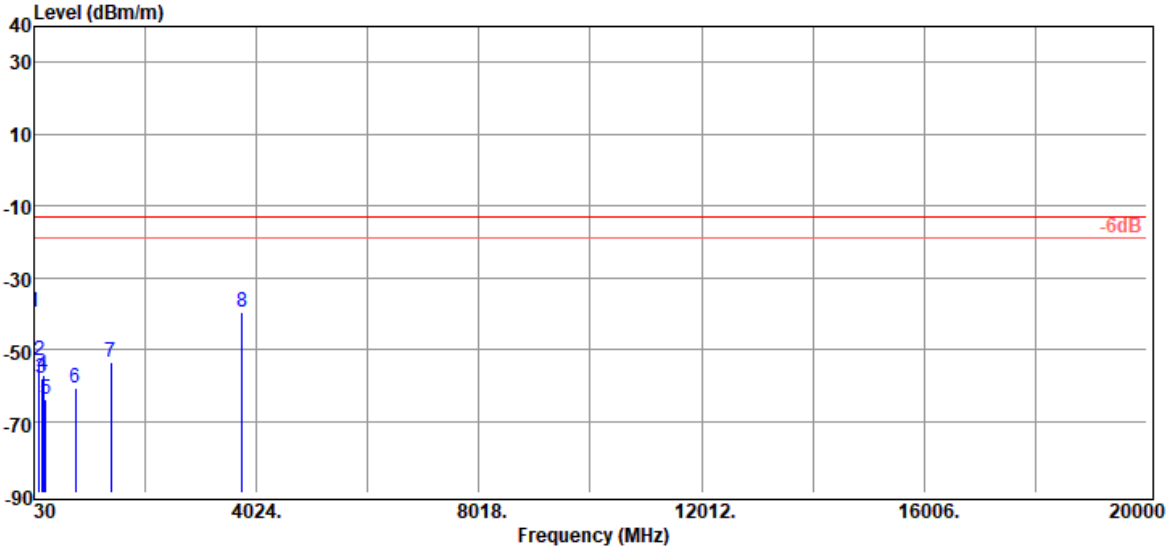

Freq. MHz	EIRP/ERP dBm	SG Output Level dBm	Antenna Gain dBi/dBd	Cable Loss dB	Limit dBm	Margin dB
35.82	-39.45	-19.05	-19.64	-0.76	-13.00	-26.45
117.30	-53.25	-44.71	-7.09	-1.45	-13.00	-40.25
163.86	-58.11	-49.75	-6.66	-1.70	-13.00	-45.11
191.99	-57.11	-52.43	-2.77	-1.91	-13.00	-44.11
242.43	-63.86	-59.83	-1.80	-2.23	-13.00	-50.86
772.05	-60.66	-54.72	-1.59	-4.35	-13.00	-47.66
1415.00	-53.74	-54.31	7.12	-6.55	-13.00	-40.74
3760.00	-39.72	-41.06	12.42	-11.08	-13.00	-26.72

Unless otherwise stated the results shown in this test report refer only to the sample(s) tested and such sample(s) are retained for 90 days only.

除非另有說明，此報告結果僅對測試之樣品負責，同時此樣品僅保留90天。本報告未經本公司書面許可，不可部份複製。

This document is issued by the Company subject to its General Conditions of Service printed overleaf, available on request or accessible at <http://www.sgs.com.tw/Terms-and-Conditions> and for electronic format documents, subject to Terms and Conditions for Electronic Documents at <http://www.sgs.com.tw/Terms-and-Conditions>. Attention is drawn to the limitation of liability, indemnification and jurisdiction issues defined therein. Any holder of this document is advised that information contained hereon reflects the Company's findings at the time of its intervention only and within the limits of Client's instructions, if any. The Company's sole responsibility is to its Client and this document does not exonerate parties to a transaction from exercising all their rights and obligations under the transaction documents. This document cannot be reproduced except in full, without prior written approval of the Company. Any unauthorized alteration, forgery or falsification of the content or appearance of this document is unlawful and offenders may be prosecuted to the fullest extent of the law.

Report Number	:E2/2019/A0032	Test Date	:2020-02-17
Operation Mode	:LTE B2+B12	Temp./Humi.	:21.8/41
Test Mode	:TX CH HIGH	Antenna Pol.	:VERTICAL
EUT Pol	:E2 Plan	Engineer	:Enzo
Test Frequency	:1900 MHz +713.5 MHz		

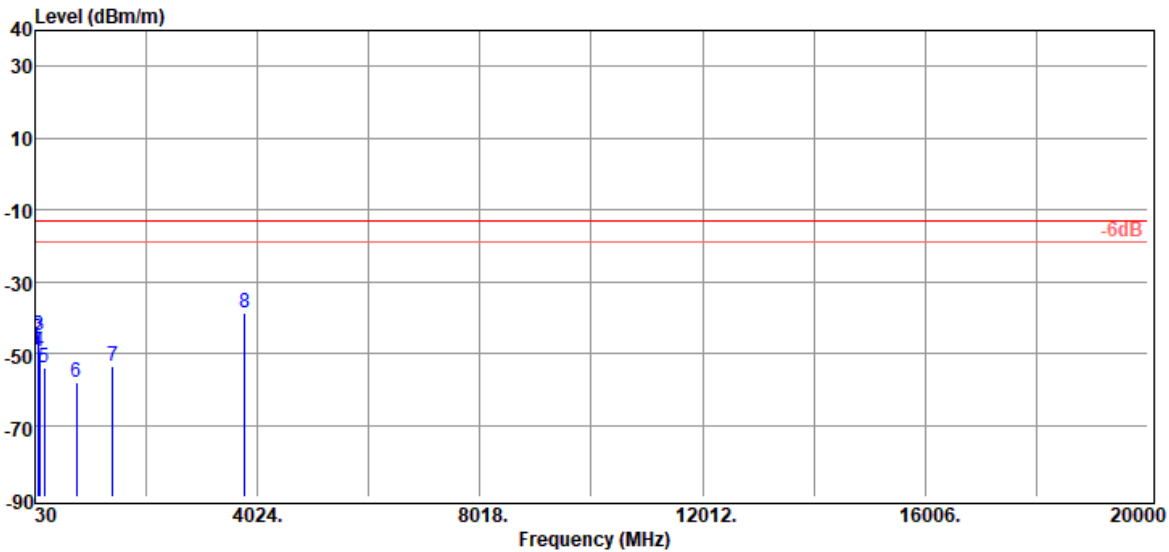

Freq. MHz	EIRP/ERP dBm	SG Output Level dBm	Antenna Gain dBi/dBd	Cable Loss dB	Limit dBm	Margin dB
35.82	-49.06	-28.66	-19.64	-0.76	-13.00	-36.06
85.29	-46.01	-37.89	-6.96	-1.16	-13.00	-33.01
94.02	-44.82	-37.81	-5.78	-1.23	-13.00	-31.82
115.36	-49.67	-41.08	-7.14	-1.45	-13.00	-36.67
199.75	-54.21	-50.01	-2.13	-2.07	-13.00	-41.21
772.05	-58.21	-52.27	-1.59	-4.35	-13.00	-45.21
1427.00	-53.67	-54.32	7.22	-6.57	-13.00	-40.67
3800.00	-38.77	-40.35	12.50	-10.92	-13.00	-25.77

Unless otherwise stated the results shown in this test report refer only to the sample(s) tested and such sample(s) are retained for 90 days only.

除非另有說明，此報告結果僅對測試之樣品負責，同時此樣品僅保留90天。本報告未經本公司書面許可，不可部份複製。

This document is issued by the Company subject to its General Conditions of Service printed overleaf, available on request or accessible at <http://www.sgs.com.tw/Terms-and-Conditions> and for electronic format documents, subject to Terms and Conditions for Electronic Documents at <http://www.sgs.com.tw/Terms-and-Conditions>. Attention is drawn to the limitation of liability, indemnification and jurisdiction issues defined therein. Any holder of this document is advised that information contained hereon reflects the Company's findings at the time of its intervention only and within the limits of Client's instructions, if any. The Company's sole responsibility is to its Client and this document does not exonerate parties to a transaction from exercising all their rights and obligations under the transaction documents. This document cannot be reproduced except in full, without prior written approval of the Company. Any unauthorized alteration, forgery or falsification of the content or appearance of this document is unlawful and offenders may be prosecuted to the fullest extent of the law.

SGS Taiwan Ltd.

台灣檢驗科技股份有限公司

No.134,Wu Kung Road, New Taipei Industrial Park, Wuku District, New Taipei City, Taiwan/新北市五股區新北產業園區五工路 134 號

t (886-2) 2299-3279

f (886-2) 2298-0488

www.sgs.com.tw

Member of SGS Group

Report Number :E2/2019/A0032
 Operation Mode :LTE B2+B12
 Test Mode :TX CH HIGH
 EUT Pol :E2 Plan
 Test Frequency :1900 MHz +713.5 MHz

Test Date :2020-02-17
 Temp./Humi. :21.8/41
 Antenna Pol. :HORIZONTAL
 Engineer :Enzo

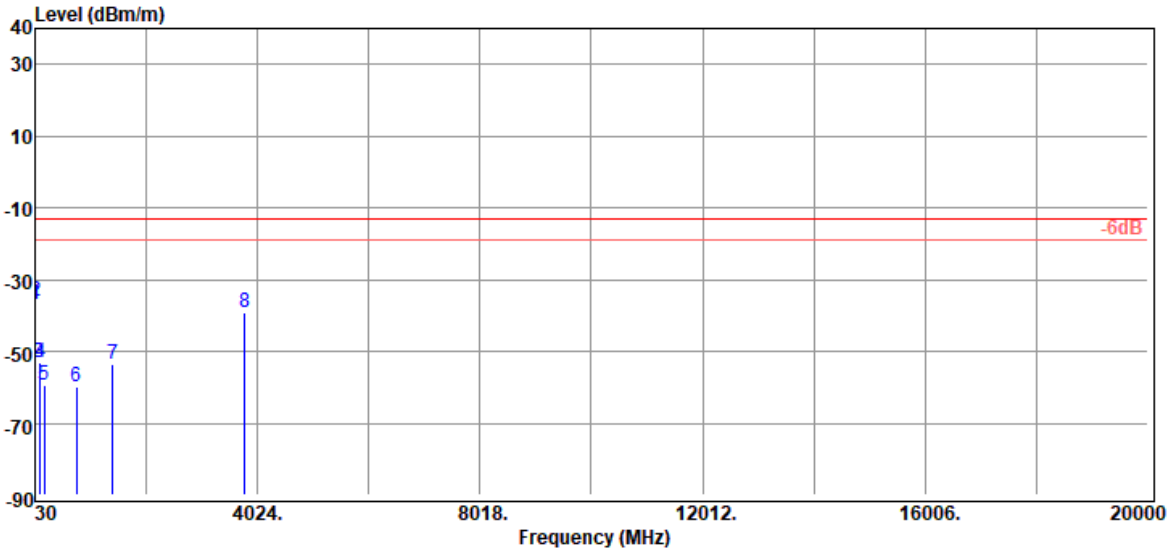

Freq. MHz	EIRP/ERP dBm	SG Output Level dBm	Antenna Gain dBi/dBd	Cable Loss dB	Limit dBm	Margin dB
33.88	-37.13	-16.58	-19.84	-0.71	-13.00	-24.13
42.61	-36.21	-16.54	-18.81	-0.86	-13.00	-23.21
103.72	-53.07	-45.06	-6.64	-1.37	-13.00	-40.07
117.30	-53.15	-44.61	-7.09	-1.45	-13.00	-40.15
197.81	-59.58	-55.31	-2.24	-2.03	-13.00	-46.58
772.05	-60.02	-54.08	-1.59	-4.35	-13.00	-47.02
1427.00	-53.61	-54.26	7.22	-6.57	-13.00	-40.61
3800.00	-39.22	-40.80	12.50	-10.92	-13.00	-26.22

Unless otherwise stated the results shown in this test report refer only to the sample(s) tested and such sample(s) are retained for 90 days only.

除非另有說明，此報告結果僅對測試之樣品負責，同時此樣品僅保留90天。本報告未經本公司書面許可，不可部份複製。

This document is issued by the Company subject to its General Conditions of Service printed overleaf, available on request or accessible at <http://www.sgs.com.tw/Terms-and-Conditions> and for electronic format documents, subject to Terms and Conditions for Electronic Documents at <http://www.sgs.com.tw/Terms-and-Conditions>. Attention is drawn to the limitation of liability, indemnification and jurisdiction issues defined therein. Any holder of this document is advised that information contained hereon reflects the Company's findings at the time of its intervention only and within the limits of Client's instructions, if any. The Company's sole responsibility is to its Client and this document does not exonerate parties to a transaction from exercising all their rights and obligations under the transaction documents. This document cannot be reproduced except in full, without prior written approval of the Company. Any unauthorized alteration, forgery or falsification of the content or appearance of this document is unlawful and offenders may be prosecuted to the fullest extent of the law.

Radiated Spurious Emission Measurement Result: LTE Band 2 + LTE Band 13 Mode

Report Number	:E2/2019/A0032	Test Date	:2020-02-17
Operation Mode	:LTE B2+B13	Temp./Humi.	:21.8/41
Test Mode	:TX CH LOW + MID	Antenna Pol.	:VERTICAL
EUT Pol	:E2 Plan	Engineer	:Enzo
Test Frequency	:1860 MHz +782 MHz		

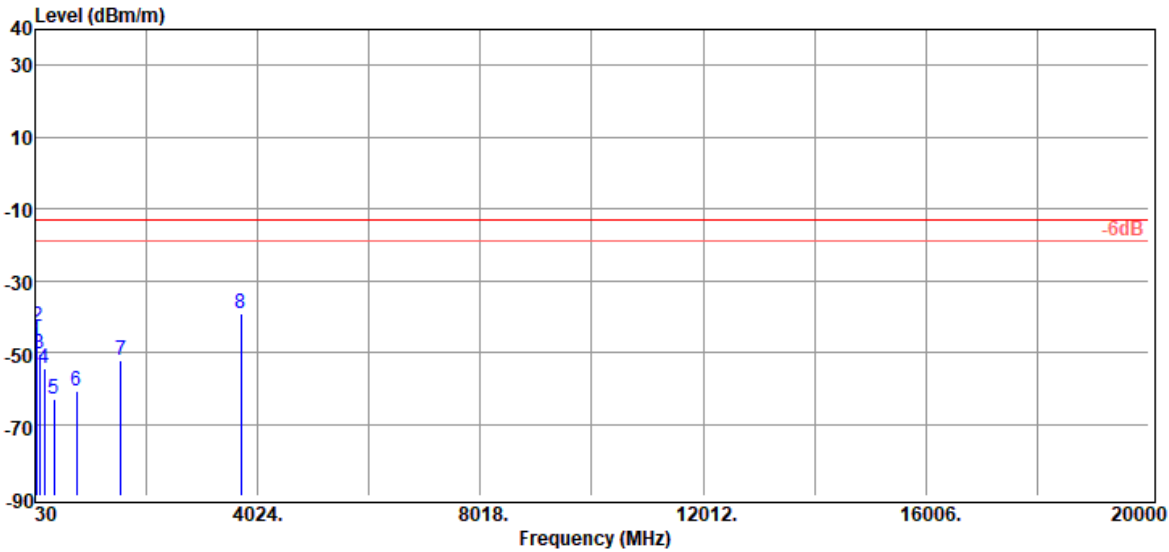

Freq. MHz	EIRP/ERP dBm	SG Output Level dBm	Antenna Gain dBi/dBd	Cable Loss dB	Limit dBm	Margin dB
35.82	-46.78	-26.38	-19.64	-0.76	-13.00	-33.78
60.07	-42.87	-26.61	-15.26	-1.00	-13.00	-29.87
115.36	-50.42	-41.83	-7.14	-1.45	-13.00	-37.42
202.66	-54.24	-50.16	-2.00	-2.08	-13.00	-41.24
375.32	-63.06	-58.63	-1.56	-2.87	-13.00	-50.06
772.05	-60.54	-54.60	-1.59	-4.35	-13.00	-47.54
1564.00	-52.24	-53.95	8.74	-7.03	-13.00	-39.24
3720.00	-39.03	-40.12	12.34	-11.25	-13.00	-26.03

Unless otherwise stated the results shown in this test report refer only to the sample(s) tested and such sample(s) are retained for 90 days only.

除非另有說明，此報告結果僅對測試之樣品負責，同時此樣品僅保留90天。本報告未經本公司書面許可，不可部份複製。

This document is issued by the Company subject to its General Conditions of Service printed overleaf, available on request or accessible at <http://www.sgs.com.tw/Terms-and-Conditions> and for electronic format documents, subject to Terms and Conditions for Electronic Documents at <http://www.sgs.com.tw/Terms-and-Conditions>. Attention is drawn to the limitation of liability, indemnification and jurisdiction issues defined therein. Any holder of this document is advised that information contained hereon reflects the Company's findings at the time of its intervention only and within the limits of Client's instructions, if any. The Company's sole responsibility is to its Client and this document does not exonerate parties to a transaction from exercising all their rights and obligations under the transaction documents. This document cannot be reproduced except in full, without prior written approval of the Company. Any unauthorized alteration, forgery or falsification of the content or appearance of this document is unlawful and offenders may be prosecuted to the fullest extent of the law.

Report Number :E2/2019/A0032
 Operation Mode :LTE B2+B13
 Test Mode :TX CH LOW + MID
 EUT Pol :E2 Plan
 Test Frequency :1860 MHz +782 MHz

Test Date :2020-02-17
 Temp./Humi. :21.8/41
 Antenna Pol. :HORIZONTAL
 Engineer :Enzo

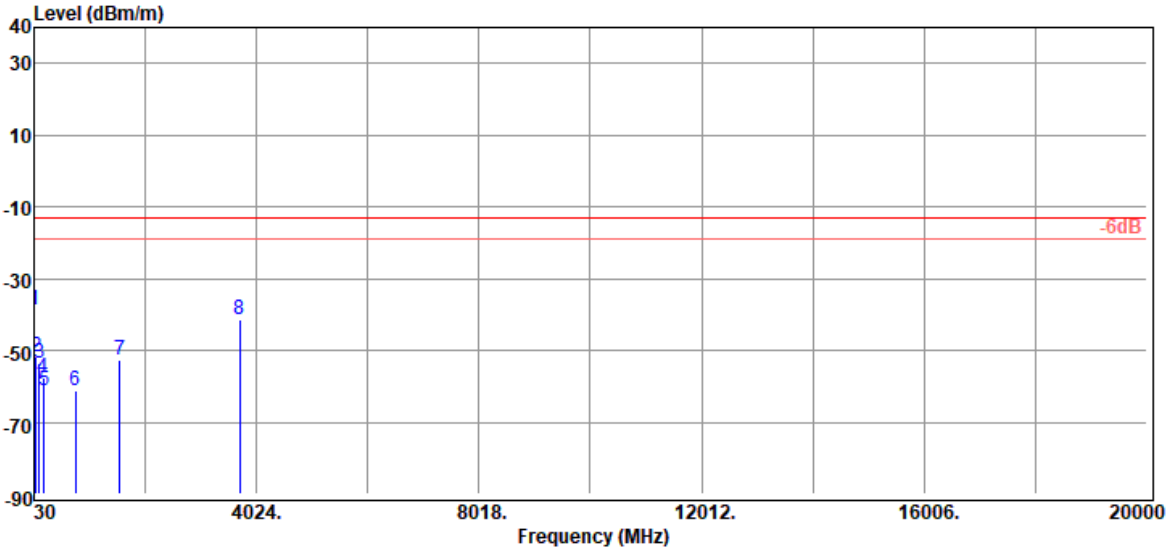

Freq. MHz	EIRP/ERP dBm	SG Output Level dBm	Antenna Gain dBi/dBd	Cable Loss dB	Limit dBm	Margin dB
33.88	-38.83	-18.28	-19.84	-0.71	-13.00	-25.83
61.04	-51.71	-35.79	-14.92	-1.00	-13.00	-38.71
117.30	-53.49	-44.95	-7.09	-1.45	-13.00	-40.49
195.87	-57.76	-53.37	-2.40	-1.99	-13.00	-44.76
215.27	-61.25	-57.73	-1.38	-2.14	-13.00	-48.25
772.05	-61.21	-55.27	-1.59	-4.35	-13.00	-48.21
1564.00	-52.56	-54.27	8.74	-7.03	-13.00	-39.56
3720.00	-41.21	-42.30	12.34	-11.25	-13.00	-28.21

Unless otherwise stated the results shown in this test report refer only to the sample(s) tested and such sample(s) are retained for 90 days only.

除非另有說明，此報告結果僅對測試之樣品負責，同時此樣品僅保留90天。本報告未經本公司書面許可，不可部份複製。

This document is issued by the Company subject to its General Conditions of Service printed overleaf, available on request or accessible at <http://www.sgs.com.tw/Terms-and-Conditions> and for electronic format documents, subject to Terms and Conditions for Electronic Documents at <http://www.sgs.com.tw/Terms-and-Conditions>. Attention is drawn to the limitation of liability, indemnification and jurisdiction issues defined therein. Any holder of this document is advised that information contained hereon reflects the Company's findings at the time of its intervention only and within the limits of Client's instructions, if any. The Company's sole responsibility is to its Client and this document does not exonerate parties to a transaction from exercising all their rights and obligations under the transaction documents. This document cannot be reproduced except in full, without prior written approval of the Company. Any unauthorized alteration, forgery or falsification of the content or appearance of this document is unlawful and offenders may be prosecuted to the fullest extent of the law.

Report Number :E2/2019/A0032
 Operation Mode :LTE B2+B13
 Test Mode :TX CH MID + MID
 EUT Pol :E2 Plan
 Test Frequency :1880 MHz +782 MHz

Test Date :2020-02-17
 Temp./Humi. :21.8/41
 Antenna Pol. :VERTICAL
 Engineer :Enzo

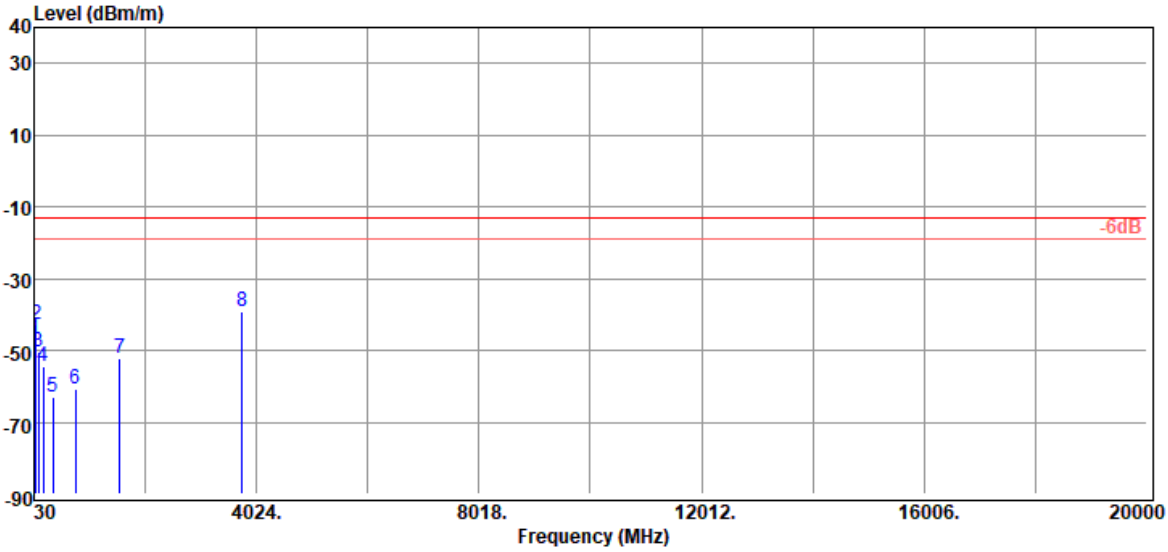

Freq. MHz	EIRP/ERP dBm	SG Output Level dBm	Antenna Gain dBi/dBd	Cable Loss dB	Limit dBm	Margin dB
35.82	-46.78	-26.38	-19.64	-0.76	-13.00	-33.78
60.07	-42.87	-26.61	-15.26	-1.00	-13.00	-29.87
115.36	-50.42	-41.83	-7.14	-1.45	-13.00	-37.42
202.66	-54.24	-50.16	-2.00	-2.08	-13.00	-41.24
375.32	-63.06	-58.63	-1.56	-2.87	-13.00	-50.06
772.05	-60.54	-54.60	-1.59	-4.35	-13.00	-47.54
1564.00	-52.21	-53.92	8.74	-7.03	-13.00	-39.21
3760.00	-39.16	-40.50	12.42	-11.08	-13.00	-26.16

Unless otherwise stated the results shown in this test report refer only to the sample(s) tested and such sample(s) are retained for 90 days only.

除非另有說明，此報告結果僅對測試之樣品負責，同時此樣品僅保留90天。本報告未經本公司書面許可，不可部份複製。

This document is issued by the Company subject to its General Conditions of Service printed overleaf, available on request or accessible at <http://www.sgs.com.tw/Terms-and-Conditions> and for electronic format documents, subject to Terms and Conditions for Electronic Documents at <http://www.sgs.com.tw/Terms-and-Conditions>. Attention is drawn to the limitation of liability, indemnification and jurisdiction issues defined therein. Any holder of this document is advised that information contained hereon reflects the Company's findings at the time of its intervention only and within the limits of Client's instructions, if any. The Company's sole responsibility is to its Client and this document does not exonerate parties to a transaction from exercising all their rights and obligations under the transaction documents. This document cannot be reproduced except in full, without prior written approval of the Company. Any unauthorized alteration, forgery or falsification of the content or appearance of this document is unlawful and offenders may be prosecuted to the fullest extent of the law.

Report Number :E2/2019/A0032
 Operation Mode :LTE B2+B13
 Test Mode :TX CH MID + MID
 EUT Pol :E2 Plan
 Test Frequency :1880 MHz +782 MHz

Test Date :2020-02-17
 Temp./Humi. :21.8/41
 Antenna Pol. :HORIZONTAL
 Engineer :Enzo

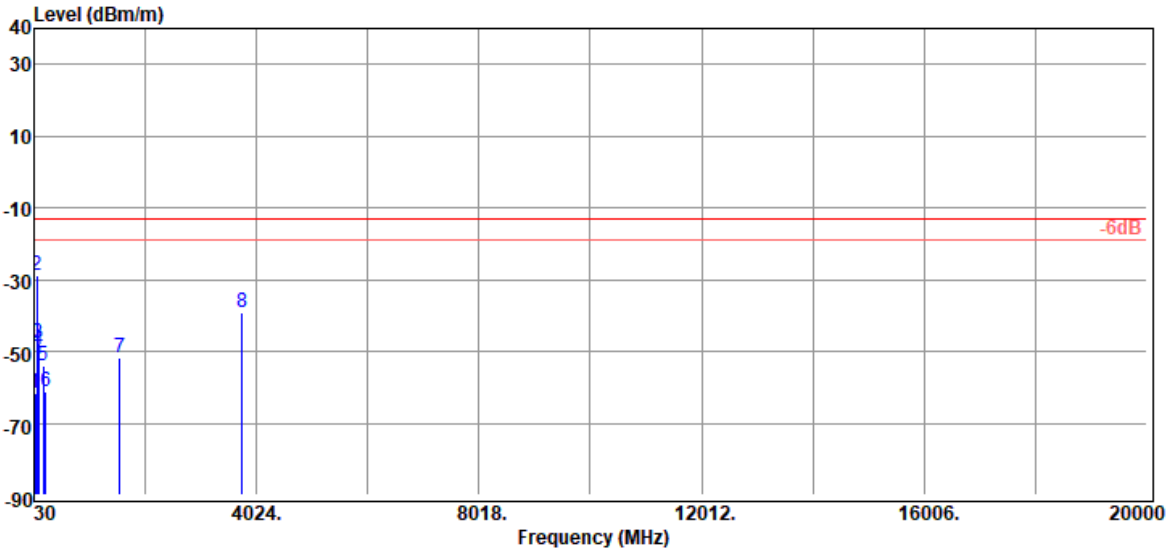

Freq. MHz	EIRP/ERP dBm	SG Output Level dBm	Antenna Gain dBi/dBd	Cable Loss dB	Limit dBm	Margin dB
55.22	-61.75	-44.34	-16.48	-0.93	-13.00	-48.75
80.44	-28.60	-19.20	-8.24	-1.16	-13.00	-15.60
106.63	-47.72	-39.40	-6.91	-1.41	-13.00	-34.72
116.33	-49.69	-41.11	-7.13	-1.45	-13.00	-36.69
201.69	-54.11	-49.98	-2.05	-2.08	-13.00	-41.11
235.64	-61.35	-57.40	-1.74	-2.21	-13.00	-48.35
1564.00	-51.77	-53.48	8.74	-7.03	-13.00	-38.77
3760.00	-39.13	-40.47	12.42	-11.08	-13.00	-26.13

Unless otherwise stated the results shown in this test report refer only to the sample(s) tested and such sample(s) are retained for 90 days only.

除非另有說明，此報告結果僅對測試之樣品負責，同時此樣品僅保留90天。本報告未經本公司書面許可，不可部份複製。

This document is issued by the Company subject to its General Conditions of Service printed overleaf, available on request or accessible at <http://www.sgs.com.tw/Terms-and-Conditions> and for electronic format documents, subject to Terms and Conditions for Electronic Documents at <http://www.sgs.com.tw/Terms-and-Conditions>. Attention is drawn to the limitation of liability, indemnification and jurisdiction issues defined therein. Any holder of this document is advised that information contained hereon reflects the Company's findings at the time of its intervention only and within the limits of Client's instructions, if any. The Company's sole responsibility is to its Client and this document does not exonerate parties to a transaction from exercising all their rights and obligations under the transaction documents. This document cannot be reproduced except in full, without prior written approval of the Company. Any unauthorized alteration, forgery or falsification of the content or appearance of this document is unlawful and offenders may be prosecuted to the fullest extent of the law.

SGS Taiwan Ltd.

台灣檢驗科技股份有限公司

No.134,Wu Kung Road, New Taipei Industrial Park, Wuku District, New Taipei City, Taiwan/新北市五股區新北產業園區五工路 134 號

t (886-2) 2299-3279

f (886-2) 2298-0488

www.sgs.com.tw

Member of SGS Group

Report Number :E2/2019/A0032
 Operation Mode :LTE B2+B13
 Test Mode :TX CH HIGH + MID
 EUT Pol :E2 Plan
 Test Frequency :1900 MHz +782 MHz

Test Date :2020-02-17
 Temp./Humi. :21.8/41
 Antenna Pol. :VERTICAL
 Engineer :Enzo

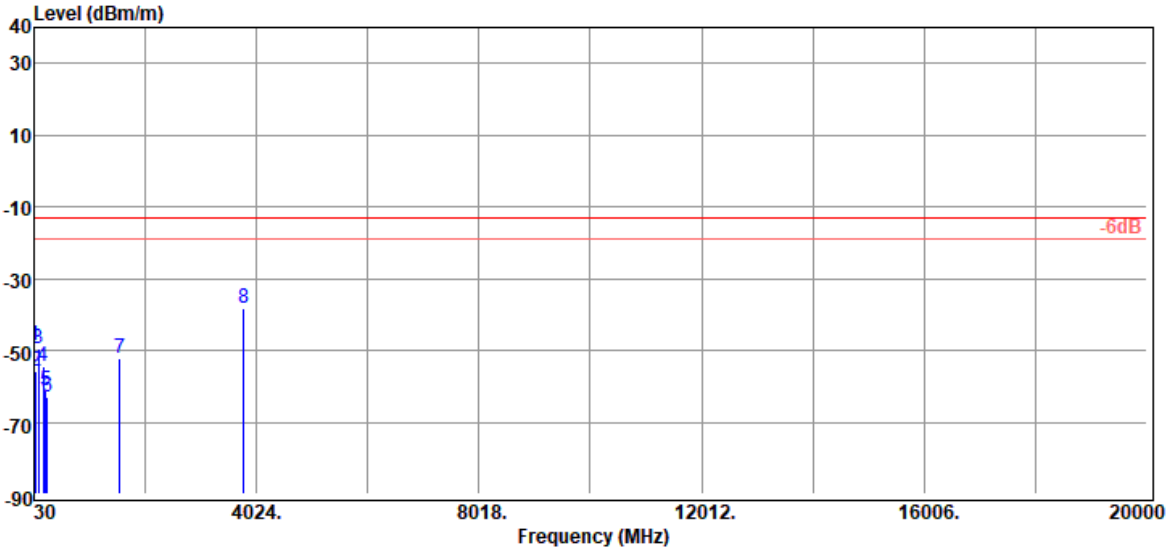

Freq. MHz	EIRP/ERP dBm	SG Output Level dBm	Antenna Gain dBi/dBd	Cable Loss dB	Limit dBm	Margin dB
35.82	-48.55	-28.15	-19.64	-0.76	-13.00	-35.55
66.86	-56.02	-41.97	-13.05	-1.00	-13.00	-43.02
116.33	-49.50	-40.92	-7.13	-1.45	-13.00	-36.50
200.72	-54.55	-50.38	-2.09	-2.08	-13.00	-41.55
242.43	-61.16	-57.13	-1.80	-2.23	-13.00	-48.16
273.47	-63.00	-59.04	-1.64	-2.32	-13.00	-50.00
1564.00	-52.24	-53.95	8.74	-7.03	-13.00	-39.24
3800.00	-38.45	-40.03	12.50	-10.92	-13.00	-25.45

Unless otherwise stated the results shown in this test report refer only to the sample(s) tested and such sample(s) are retained for 90 days only.

除非另有說明，此報告結果僅對測試之樣品負責，同時此樣品僅保留90天。本報告未經本公司書面許可，不可部份複製。

This document is issued by the Company subject to its General Conditions of Service printed overleaf, available on request or accessible at <http://www.sgs.com.tw/Terms-and-Conditions> and for electronic format documents, subject to Terms and Conditions for Electronic Documents at <http://www.sgs.com.tw/Terms-and-Conditions>. Attention is drawn to the limitation of liability, indemnification and jurisdiction issues defined therein. Any holder of this document is advised that information contained hereon reflects the Company's findings at the time of its intervention only and within the limits of Client's instructions, if any. The Company's sole responsibility is to its Client and this document does not exonerate parties to a transaction from exercising all their rights and obligations under the transaction documents. This document cannot be reproduced except in full, without prior written approval of the Company. Any unauthorized alteration, forgery or falsification of the content or appearance of this document is unlawful and offenders may be prosecuted to the fullest extent of the law.

Report Number :E2/2019/A0032
 Operation Mode :LTE B2+B13
 Test Mode :TX CH HIGH + MID
 EUT Pol :E2 Plan
 Test Frequency :1900 MHz +782 MHz

Test Date :2020-02-17
 Temp./Humi. :21.8/41
 Antenna Pol. :HORIZONTAL
 Engineer :Enzo

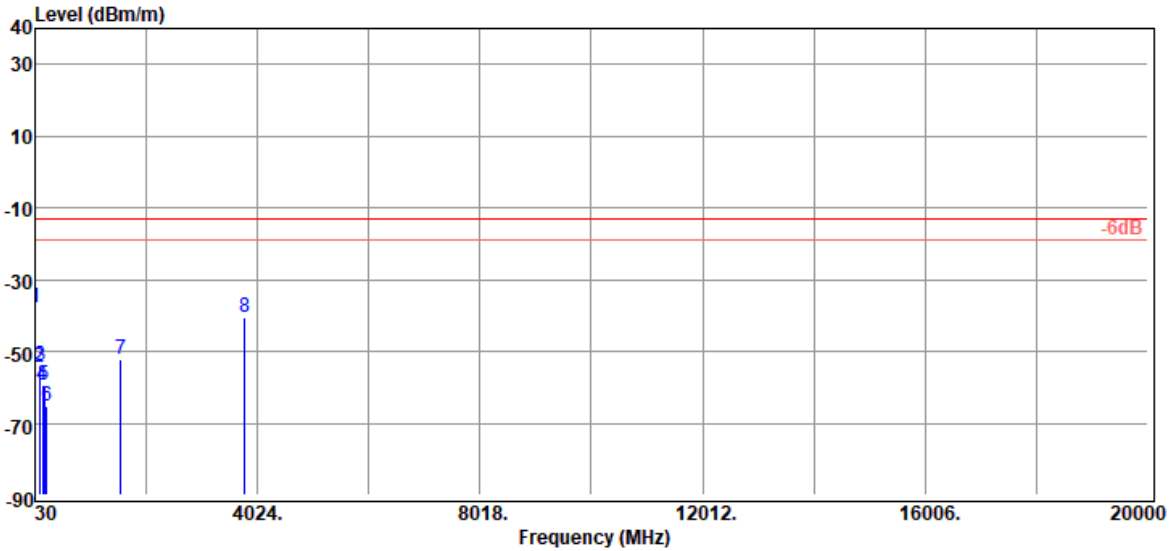

Freq. MHz	EIRP/ERP dBm	SG Output Level dBm	Antenna Gain dBi/dBd	Cable Loss dB	Limit dBm	Margin dB
35.82	-37.80	-17.40	-19.64	-0.76	-13.00	-24.80
111.48	-54.57	-46.03	-7.09	-1.45	-13.00	-41.57
118.27	-53.85	-45.32	-7.08	-1.45	-13.00	-40.85
165.80	-59.60	-51.34	-6.55	-1.71	-13.00	-46.60
191.02	-59.35	-54.64	-2.82	-1.89	-13.00	-46.35
240.49	-65.32	-61.26	-1.83	-2.23	-13.00	-52.32
1564.00	-52.37	-54.08	8.74	-7.03	-13.00	-39.37
3800.00	-40.50	-42.08	12.50	-10.92	-13.00	-27.50

Unless otherwise stated the results shown in this test report refer only to the sample(s) tested and such sample(s) are retained for 90 days only.

除非另有說明，此報告結果僅對測試之樣品負責，同時此樣品僅保留90天。本報告未經本公司書面許可，不可部份複製。

This document is issued by the Company subject to its General Conditions of Service printed overleaf, available on request or accessible at <http://www.sgs.com.tw/Terms-and-Conditions> and for electronic format documents, subject to Terms and Conditions for Electronic Documents at <http://www.sgs.com.tw/Terms-and-Conditions>. Attention is drawn to the limitation of liability, indemnification and jurisdiction issues defined therein. Any holder of this document is advised that information contained hereon reflects the Company's findings at the time of its intervention only and within the limits of Client's instructions, if any. The Company's sole responsibility is to its Client and this document does not exonerate parties to a transaction from exercising all their rights and obligations under the transaction documents. This document cannot be reproduced except in full, without prior written approval of the Company. Any unauthorized alteration, forgery or falsification of the content or appearance of this document is unlawful and offenders may be prosecuted to the fullest extent of the law.

SGS Taiwan Ltd.

台灣檢驗科技股份有限公司

No.134,Wu Kung Road, New Taipei Industrial Park, Wuku District, New Taipei City, Taiwan/新北市五股區新北產業園區五工路 134 號

t (886-2) 2299-3279

f (886-2) 2298-0488

www.sgs.com.tw

Member of SGS Group

Radiated Spurious Emission Measurement Result: LTE Band 4 + LTE Band 5 Mode

Report Number	:E2/2019/A0032	Test Date	:2020-02-17
Operation Mode	:LTE B4+B5	Temp./Humi.	:21.8/41
Test Mode	:TX CH LOW	Antenna Pol.	:VERTICAL
EUT Pol	:E2 Plan	Engineer	:Enzo
Test Frequency	:1720 MHz +826.5 MHz		

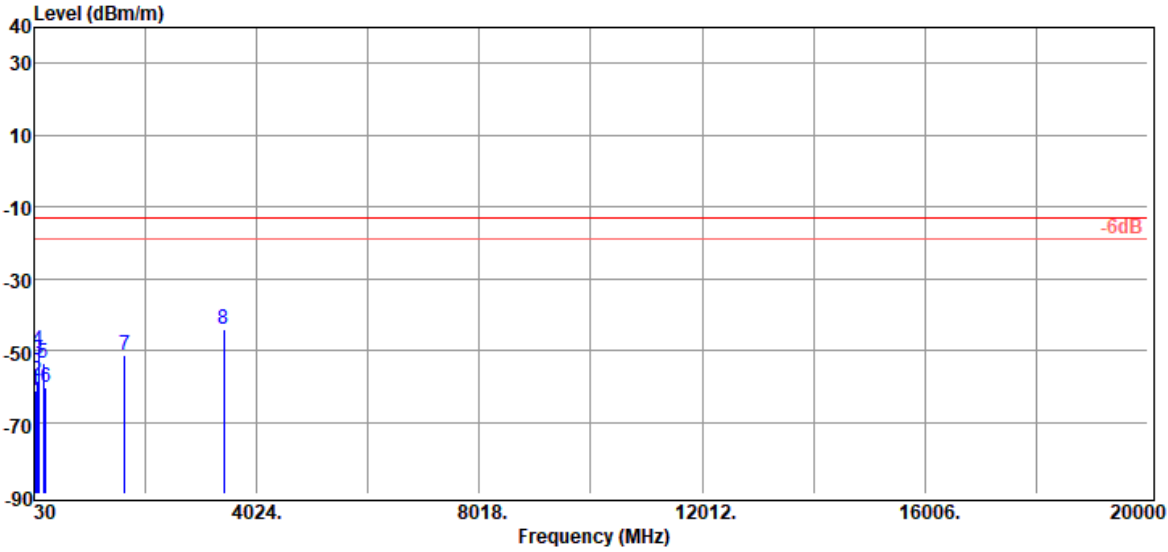

Freq. MHz	EIRP/ERP dBm	SG Output Level dBm	Antenna Gain dBi/dBd	Cable Loss dB	Limit dBm	Margin dB
49.40	-61.30	-42.71	-17.73	-0.86	-13.00	-48.30
76.56	-58.58	-47.99	-9.49	-1.10	-13.00	-45.58
104.69	-52.50	-44.33	-6.78	-1.39	-13.00	-39.50
116.33	-49.93	-41.35	-7.13	-1.45	-13.00	-36.93
202.66	-53.59	-49.51	-2.00	-2.08	-13.00	-40.59
240.49	-60.53	-56.47	-1.83	-2.23	-13.00	-47.53
1653.00	-51.50	-53.28	9.33	-7.55	-13.00	-38.50
3440.00	-44.29	-45.72	12.62	-11.19	-13.00	-31.29

Unless otherwise stated the results shown in this test report refer only to the sample(s) tested and such sample(s) are retained for 90 days only.

除非另有說明，此報告結果僅對測試之樣品負責，同時此樣品僅保留90天。本報告未經本公司書面許可，不可部份複製。

This document is issued by the Company subject to its General Conditions of Service printed overleaf, available on request or accessible at <http://www.sgs.com.tw/Terms-and-Conditions> and for electronic format documents, subject to Terms and Conditions for Electronic Documents at <http://www.sgs.com.tw/Terms-and-Conditions>. Attention is drawn to the limitation of liability, indemnification and jurisdiction issues defined therein. Any holder of this document is advised that information contained hereon reflects the Company's findings at the time of its intervention only and within the limits of Client's instructions, if any. The Company's sole responsibility is to its Client and this document does not exonerate parties to a transaction from exercising all their rights and obligations under the transaction documents. This document cannot be reproduced except in full, without prior written approval of the Company. Any unauthorized alteration, forgery or falsification of the content or appearance of this document is unlawful and offenders may be prosecuted to the fullest extent of the law.

Report Number :E2/2019/A0032
 Operation Mode :LTE B4+B5
 Test Mode :TX CH LOW
 EUT Pol :E2 Plan
 Test Frequency :1720 MHz +826.5 MHz

Test Date :2020-02-17
 Temp./Humi. :21.8/41
 Antenna Pol. :HORIZONTAL
 Engineer :Enzo

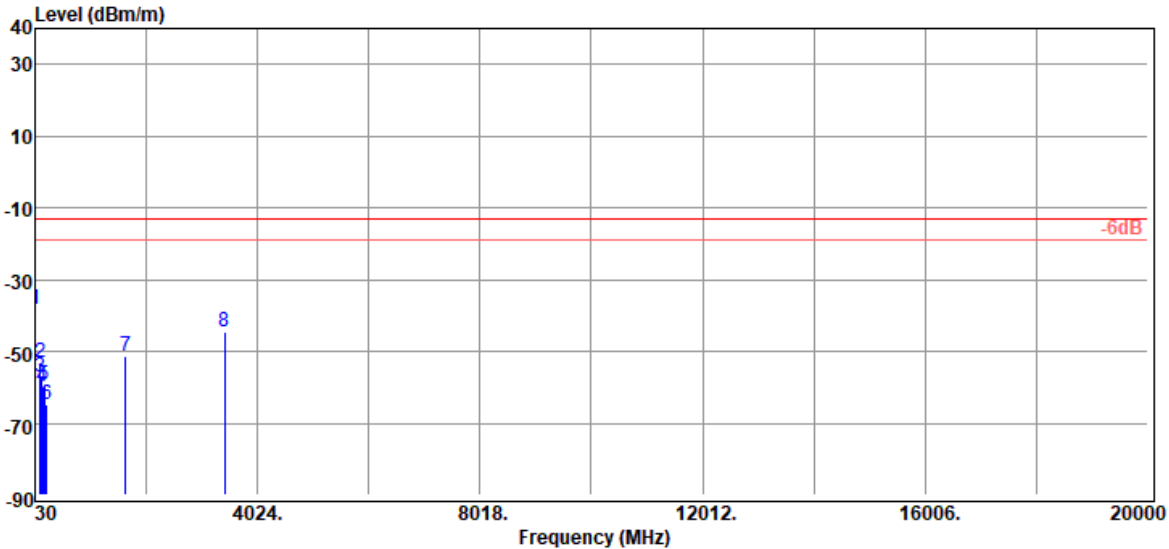

Freq. MHz	EIRP/ERP dBm	SG Output Level dBm	Antenna Gain dBi/dBd	Cable Loss dB	Limit dBm	Margin dB
31.94	-38.24	-17.22	-20.36	-0.66	-13.00	-25.24
117.30	-53.31	-44.77	-7.09	-1.45	-13.00	-40.31
139.61	-57.24	-47.94	-7.64	-1.66	-13.00	-44.24
162.89	-59.68	-51.17	-6.81	-1.70	-13.00	-46.68
190.05	-59.24	-54.42	-2.95	-1.87	-13.00	-46.24
241.46	-64.81	-60.76	-1.82	-2.23	-13.00	-51.81
1653.00	-51.12	-52.90	9.33	-7.55	-13.00	-38.12
3440.00	-44.44	-45.87	12.62	-11.19	-13.00	-31.44

Unless otherwise stated the results shown in this test report refer only to the sample(s) tested and such sample(s) are retained for 90 days only.

除非另有說明，此報告結果僅對測試之樣品負責，同時此樣品僅保留90天。本報告未經本公司書面許可，不可部份複製。

This document is issued by the Company subject to its General Conditions of Service printed overleaf, available on request or accessible at <http://www.sgs.com.tw/Terms-and-Conditions> and for electronic format documents, subject to Terms and Conditions for Electronic Documents at <http://www.sgs.com.tw/Terms-and-Conditions>. Attention is drawn to the limitation of liability, indemnification and jurisdiction issues defined therein. Any holder of this document is advised that information contained hereon reflects the Company's findings at the time of its intervention only and within the limits of Client's instructions, if any. The Company's sole responsibility is to its Client and this document does not exonerate parties to a transaction from exercising all their rights and obligations under the transaction documents. This document cannot be reproduced except in full, without prior written approval of the Company. Any unauthorized alteration, forgery or falsification of the content or appearance of this document is unlawful and offenders may be prosecuted to the fullest extent of the law.

Report Number :E2/2019/A0032
 Operation Mode :LTE B4+B5
 Test Mode :TX CH MID
 EUT Pol :E2 Plan
 Test Frequency :1732.5 MHz +836.5 MHz

Test Date :2020-02-17
 Temp./Humi. :21.8/41
 Antenna Pol. :VERTICAL
 Engineer :Enzo

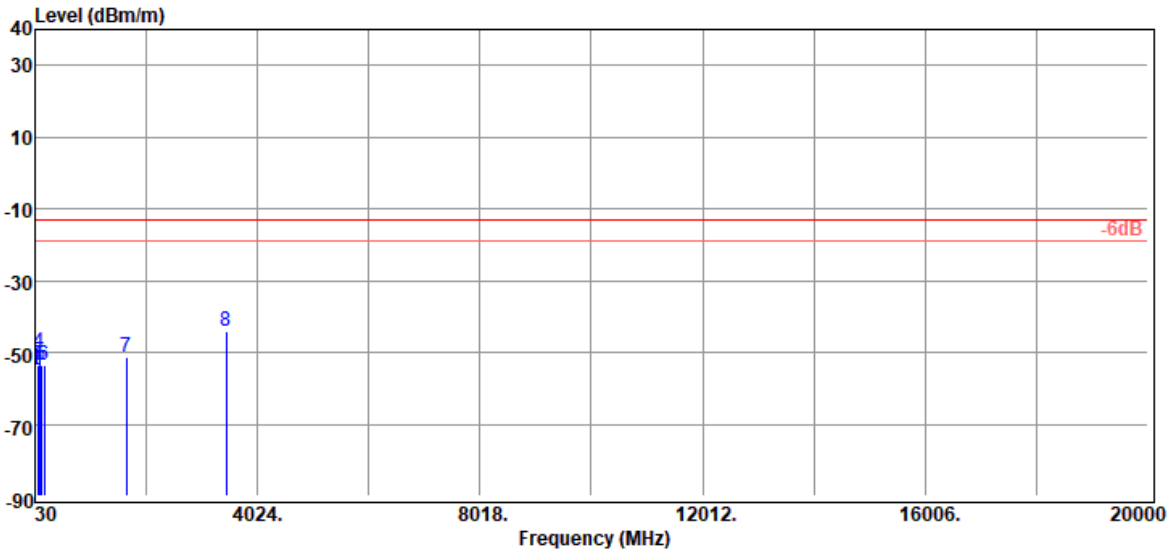

Freq. MHz	EIRP/ERP dBm	SG Output Level dBm	Antenna Gain dBi/dBd	Cable Loss dB	Limit dBm	Margin dB
37.76	-54.25	-34.10	-19.35	-0.80	-13.00	-41.25
42.61	-55.09	-35.42	-18.81	-0.86	-13.00	-42.09
80.44	-53.46	-44.06	-8.24	-1.16	-13.00	-40.46
116.33	-50.19	-41.61	-7.13	-1.45	-13.00	-37.19
141.55	-53.78	-44.44	-7.68	-1.66	-13.00	-40.78
202.66	-53.76	-49.68	-2.00	-2.08	-13.00	-40.76
1673.00	-51.14	-52.99	9.53	-7.68	-13.00	-38.14
3465.00	-44.02	-45.50	12.51	-11.03	-13.00	-31.02

Unless otherwise stated the results shown in this test report refer only to the sample(s) tested and such sample(s) are retained for 90 days only.

除非另有說明，此報告結果僅對測試之樣品負責，同時此樣品僅保留90天。本報告未經本公司書面許可，不可部份複製。

This document is issued by the Company subject to its General Conditions of Service printed overleaf, available on request or accessible at <http://www.sgs.com.tw/Terms-and-Conditions> and for electronic format documents, subject to Terms and Conditions for Electronic Documents at <http://www.sgs.com.tw/Terms-and-Conditions>. Attention is drawn to the limitation of liability, indemnification and jurisdiction issues defined therein. Any holder of this document is advised that information contained hereon reflects the Company's findings at the time of its intervention only and within the limits of Client's instructions, if any. The Company's sole responsibility is to its Client and this document does not exonerate parties to a transaction from exercising all their rights and obligations under the transaction documents. This document cannot be reproduced except in full, without prior written approval of the Company. Any unauthorized alteration, forgery or falsification of the content or appearance of this document is unlawful and offenders may be prosecuted to the fullest extent of the law.

Report Number :E2/2019/A0032
 Operation Mode :LTE B4+B5
 Test Mode :TX CH MID
 EUT Pol :E2 Plan
 Test Frequency :1732.5 MHz +836.5 MHz

Test Date :2020-02-17
 Temp./Humi. :21.8/41
 Antenna Pol. :HORIZONTAL
 Engineer :Enzo

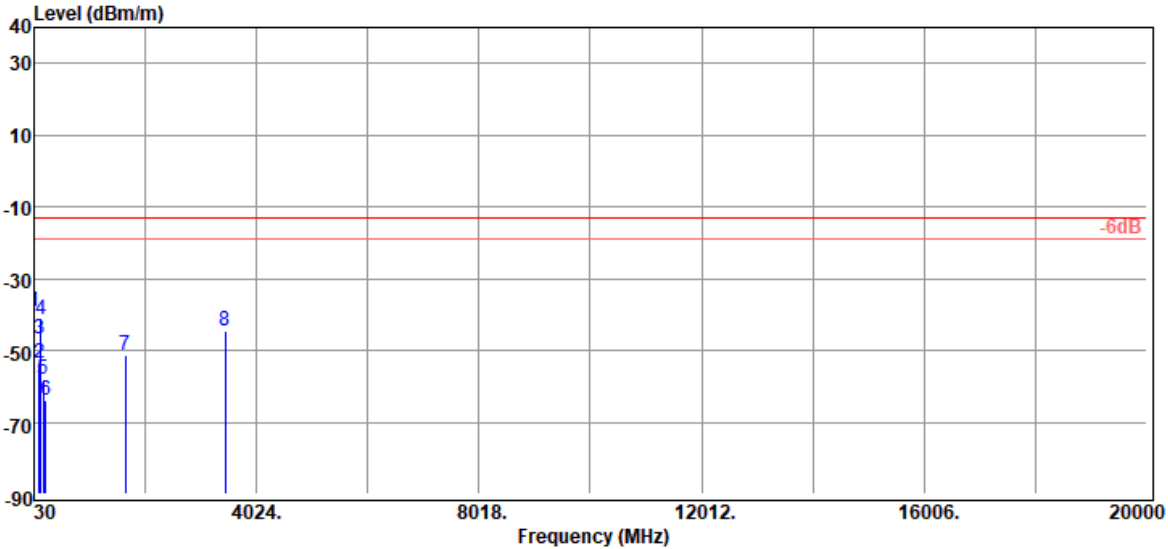

Freq. MHz	EIRP/ERP dBm	SG Output Level dBm	Antenna Gain dBi/dBd	Cable Loss dB	Limit dBm	Margin dB
31.94	-39.07	-18.05	-20.36	-0.66	-13.00	-26.07
117.30	-53.45	-44.91	-7.09	-1.45	-13.00	-40.45
139.61	-47.02	-37.72	-7.64	-1.66	-13.00	-34.02
152.22	-41.48	-32.51	-7.29	-1.68	-13.00	-28.48
195.87	-58.17	-53.78	-2.40	-1.99	-13.00	-45.17
241.46	-63.93	-59.88	-1.82	-2.23	-13.00	-50.93
1673.00	-51.32	-53.17	9.53	-7.68	-13.00	-38.32
3465.00	-44.68	-46.16	12.51	-11.03	-13.00	-31.68

Unless otherwise stated the results shown in this test report refer only to the sample(s) tested and such sample(s) are retained for 90 days only.

除非另有說明，此報告結果僅對測試之樣品負責，同時此樣品僅保留90天。本報告未經本公司書面許可，不可部份複製。

This document is issued by the Company subject to its General Conditions of Service printed overleaf, available on request or accessible at <http://www.sgs.com.tw/Terms-and-Conditions> and for electronic format documents, subject to Terms and Conditions for Electronic Documents at <http://www.sgs.com.tw/Terms-and-Conditions>. Attention is drawn to the limitation of liability, indemnification and jurisdiction issues defined therein. Any holder of this document is advised that information contained hereon reflects the Company's findings at the time of its intervention only and within the limits of Client's instructions, if any. The Company's sole responsibility is to its Client and this document does not exonerate parties to a transaction from exercising all their rights and obligations under the transaction documents. This document cannot be reproduced except in full, without prior written approval of the Company. Any unauthorized alteration, forgery or falsification of the content or appearance of this document is unlawful and offenders may be prosecuted to the fullest extent of the law.

Report Number	:E2/2019/A0032	Test Date	:2020-02-17
Operation Mode	:LTE B4+B5	Temp./Humi.	:21.8/41
Test Mode	:TX CH HIGH	Antenna Pol.	:VERTICAL
EUT Pol	:E2 Plan	Engineer	:Enzo
Test Frequency	:1745 MHz +846.5 MHz		

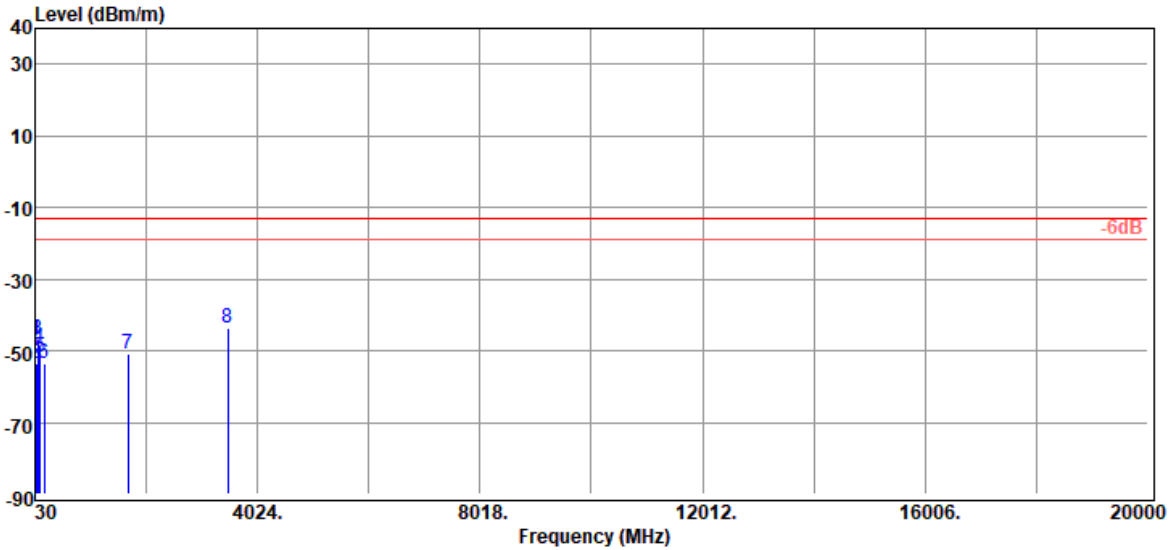

Freq. MHz	EIRP/ERP dBm	SG Output Level dBm	Antenna Gain dBi/dBd	Cable Loss dB	Limit dBm	Margin dB
36.79	-46.94	-26.73	-19.43	-0.78	-13.00	-33.94
50.37	-53.72	-35.35	-17.50	-0.87	-13.00	-40.72
86.26	-46.71	-38.88	-6.67	-1.16	-13.00	-33.71
116.33	-49.20	-40.62	-7.13	-1.45	-13.00	-36.20
130.88	-51.90	-42.95	-7.29	-1.66	-13.00	-38.90
202.66	-53.41	-49.33	-2.00	-2.08	-13.00	-40.41
1693.00	-50.86	-52.78	9.73	-7.81	-13.00	-37.86
3490.00	-43.62	-45.11	12.36	-10.87	-13.00	-30.62

Unless otherwise stated the results shown in this test report refer only to the sample(s) tested and such sample(s) are retained for 90 days only.

除非另有說明，此報告結果僅對測試之樣品負責，同時此樣品僅保留90天。本報告未經本公司書面許可，不可部份複製。

This document is issued by the Company subject to its General Conditions of Service printed overleaf, available on request or accessible at <http://www.sgs.com.tw/Terms-and-Conditions> and for electronic format documents, subject to Terms and Conditions for Electronic Documents at <http://www.sgs.com.tw/Terms-and-Conditions>. Attention is drawn to the limitation of liability, indemnification and jurisdiction issues defined therein. Any holder of this document is advised that information contained hereon reflects the Company's findings at the time of its intervention only and within the limits of Client's instructions, if any. The Company's sole responsibility is to its Client and this document does not exonerate parties to a transaction from exercising all their rights and obligations under the transaction documents. This document cannot be reproduced except in full, without prior written approval of the Company. Any unauthorized alteration, forgery or falsification of the content or appearance of this document is unlawful and offenders may be prosecuted to the fullest extent of the law.

Report Number :E2/2019/A0032
 Operation Mode :LTE B4+B5
 Test Mode :TX CH HIGH
 EUT Pol :E2 Plan
 Test Frequency :1745 MHz +846.5 MHz

Test Date :2020-02-17
 Temp./Humi. :21.8/41
 Antenna Pol. :HORIZONTAL
 Engineer :Enzo

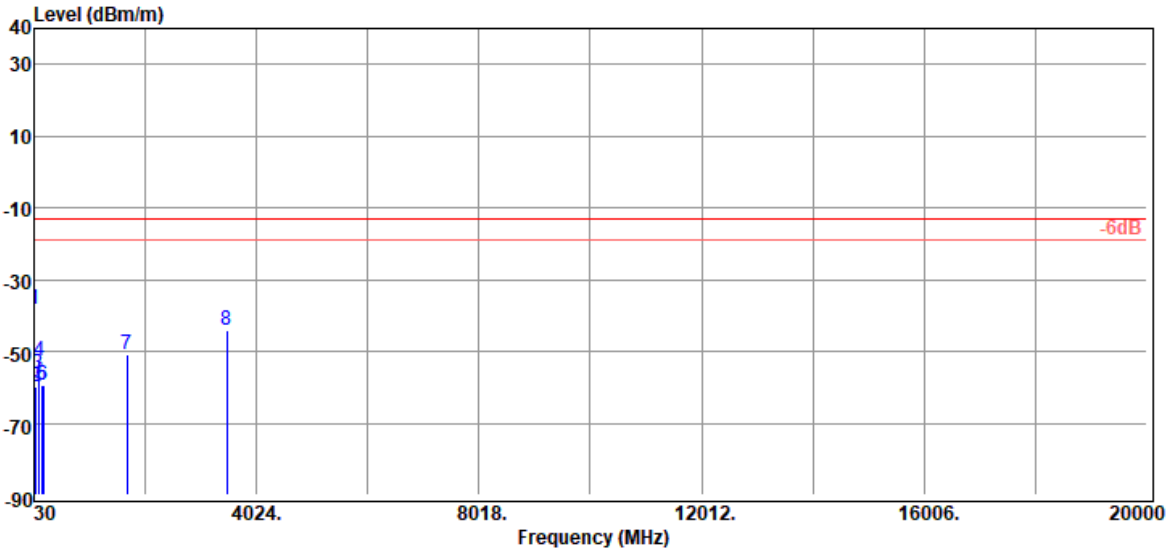

Freq. MHz	EIRP/ERP dBm	SG Output Level dBm	Antenna Gain dBi/dBd	Cable Loss dB	Limit dBm	Margin dB
33.88	-38.36	-17.81	-19.84	-0.71	-13.00	-25.36
62.01	-59.90	-44.31	-14.59	-1.00	-13.00	-46.90
103.72	-56.14	-48.13	-6.64	-1.37	-13.00	-43.14
117.30	-52.81	-44.27	-7.09	-1.45	-13.00	-39.81
162.89	-59.33	-50.82	-6.81	-1.70	-13.00	-46.33
190.05	-59.53	-54.71	-2.95	-1.87	-13.00	-46.53
1693.00	-50.82	-52.74	9.73	-7.81	-13.00	-37.82
3490.00	-44.01	-45.50	12.36	-10.87	-13.00	-31.01

Unless otherwise stated the results shown in this test report refer only to the sample(s) tested and such sample(s) are retained for 90 days only.

除非另有說明，此報告結果僅對測試之樣品負責，同時此樣品僅保留90天。本報告未經本公司書面許可，不可部份複製。

This document is issued by the Company subject to its General Conditions of Service printed overleaf, available on request or accessible at <http://www.sgs.com.tw/Terms-and-Conditions> and for electronic format documents, subject to Terms and Conditions for Electronic Documents at <http://www.sgs.com.tw/Terms-and-Conditions>. Attention is drawn to the limitation of liability, indemnification and jurisdiction issues defined therein. Any holder of this document is advised that information contained hereon reflects the Company's findings at the time of its intervention only and within the limits of Client's instructions, if any. The Company's sole responsibility is to its Client and this document does not exonerate parties to a transaction from exercising all their rights and obligations under the transaction documents. This document cannot be reproduced except in full, without prior written approval of the Company. Any unauthorized alteration, forgery or falsification of the content or appearance of this document is unlawful and offenders may be prosecuted to the fullest extent of the law.

Radiated Spurious Emission Measurement Result: LTE Band 4 + LTE Band 12 Mode

Report Number	:E2/2019/A0032	Test Date	:2020-02-17
Operation Mode	:LTE B4+B12	Temp./Humi.	:21.8/41
Test Mode	:TX CH LOW	Antenna Pol.	:VERTICAL
EUT Pol	:E2 Plan	Engineer	:Enzo
Test Frequency	:1720 MHz+704 MHz		

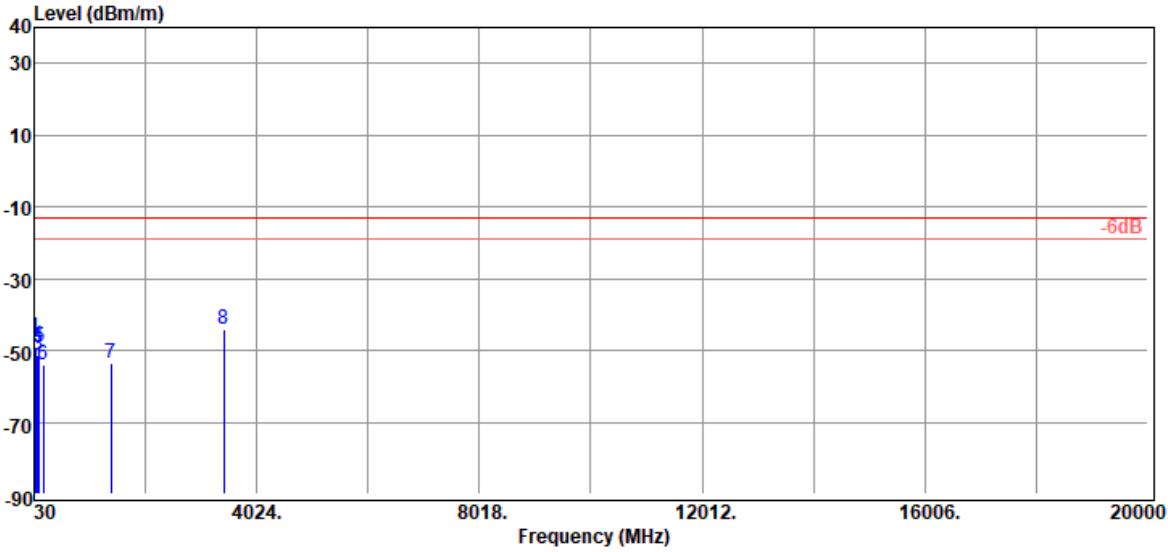

Freq. MHz	EIRP/ERP dBm	SG Output Level dBm	Antenna Gain dBi/dBd	Cable Loss dB	Limit dBm	Margin dB
36.79	-46.31	-26.10	-19.43	-0.78	-13.00	-33.31
57.16	-49.20	-32.18	-16.06	-0.96	-13.00	-36.20
88.20	-51.36	-43.89	-6.31	-1.16	-13.00	-38.36
116.33	-48.81	-40.23	-7.13	-1.45	-13.00	-35.81
123.12	-49.26	-40.70	-7.04	-1.52	-13.00	-36.26
202.66	-54.12	-50.04	-2.00	-2.08	-13.00	-41.12
1408.00	-53.76	-54.29	7.06	-6.53	-13.00	-40.76
3440.00	-44.19	-45.62	12.62	-11.19	-13.00	-31.19

Unless otherwise stated the results shown in this test report refer only to the sample(s) tested and such sample(s) are retained for 90 days only.

除非另有說明，此報告結果僅對測試之樣品負責，同時此樣品僅保留90天。本報告未經本公司書面許可，不可部份複製。

This document is issued by the Company subject to its General Conditions of Service printed overleaf, available on request or accessible at <http://www.sgs.com.tw/Terms-and-Conditions> and for electronic format documents, subject to Terms and Conditions for Electronic Documents at <http://www.sgs.com.tw/Terms-and-Conditions>. Attention is drawn to the limitation of liability, indemnification and jurisdiction issues defined therein. Any holder of this document is advised that information contained hereon reflects the Company's findings at the time of its intervention only and within the limits of Client's instructions, if any. The Company's sole responsibility is to its Client and this document does not exonerate parties to a transaction from exercising all their rights and obligations under the transaction documents. This document cannot be reproduced except in full, without prior written approval of the Company. Any unauthorized alteration, forgery or falsification of the content or appearance of this document is unlawful and offenders may be prosecuted to the fullest extent of the law.

Report Number :E2/2019/A0032
 Operation Mode :LTE B4+B12
 Test Mode :TX CH LOW
 EUT Pol :E2 Plan
 Test Frequency :1720 MHz+704 MHz

Test Date :2020-02-17
 Temp./Humi. :21.8/41
 Antenna Pol. :HORIZONTAL
 Engineer :Enzo

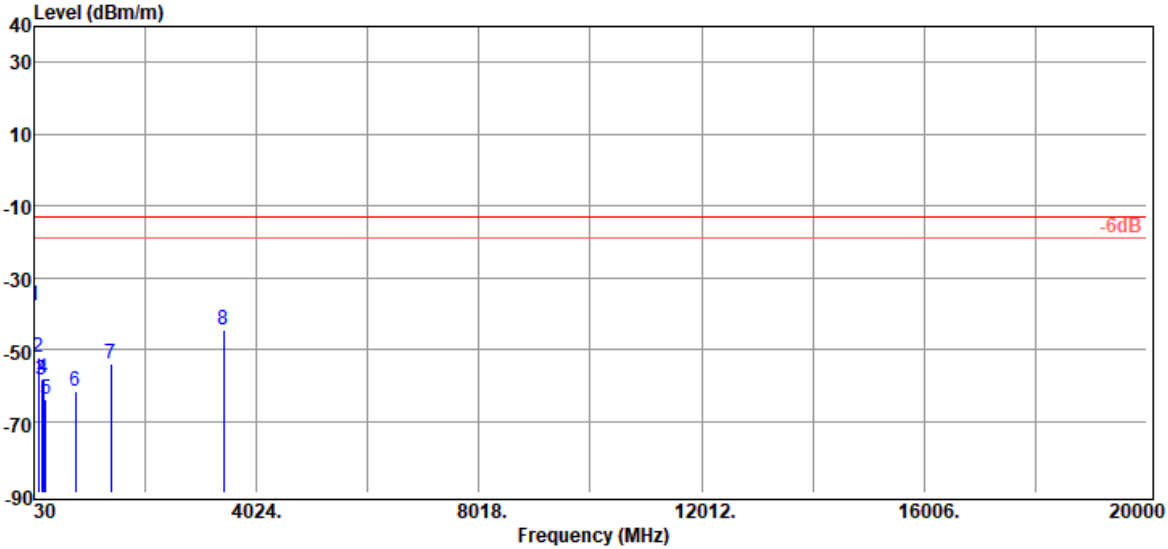

Freq. MHz	EIRP/ERP dBm	SG Output Level dBm	Antenna Gain dBi/dBd	Cable Loss dB	Limit dBm	Margin dB
33.88	-37.79	-17.24	-19.84	-0.71	-13.00	-24.79
116.33	-52.35	-43.77	-7.13	-1.45	-13.00	-39.35
162.89	-58.33	-49.82	-6.81	-1.70	-13.00	-45.33
191.02	-58.06	-53.35	-2.82	-1.89	-13.00	-45.06
239.52	-63.78	-59.72	-1.83	-2.23	-13.00	-50.78
773.02	-61.66	-55.71	-1.57	-4.38	-13.00	-48.66
1408.00	-53.81	-54.34	7.06	-6.53	-13.00	-40.81
3440.00	-44.45	-45.88	12.62	-11.19	-13.00	-31.45

Unless otherwise stated the results shown in this test report refer only to the sample(s) tested and such sample(s) are retained for 90 days only.

除非另有說明，此報告結果僅對測試之樣品負責，同時此樣品僅保留90天。本報告未經本公司書面許可，不可部份複製。

This document is issued by the Company subject to its General Conditions of Service printed overleaf, available on request or accessible at <http://www.sgs.com.tw/Terms-and-Conditions> and for electronic format documents, subject to Terms and Conditions for Electronic Documents at <http://www.sgs.com.tw/Terms-and-Conditions>. Attention is drawn to the limitation of liability, indemnification and jurisdiction issues defined therein. Any holder of this document is advised that information contained hereon reflects the Company's findings at the time of its intervention only and within the limits of Client's instructions, if any. The Company's sole responsibility is to its Client and this document does not exonerate parties to a transaction from exercising all their rights and obligations under the transaction documents. This document cannot be reproduced except in full, without prior written approval of the Company. Any unauthorized alteration, forgery or falsification of the content or appearance of this document is unlawful and offenders may be prosecuted to the fullest extent of the law.

Report Number	:E2/2019/A0032	Test Date	:2020-02-17
Operation Mode	:LTE B4+B12	Temp./Humi.	:21.8/41
Test Mode	:TX CH MID	Antenna Pol.	:VERTICAL
EUT Pol	:E2 Plan	Engineer	:Enzo
Test Frequency	:1732.5 MHz +707.5 MHz		

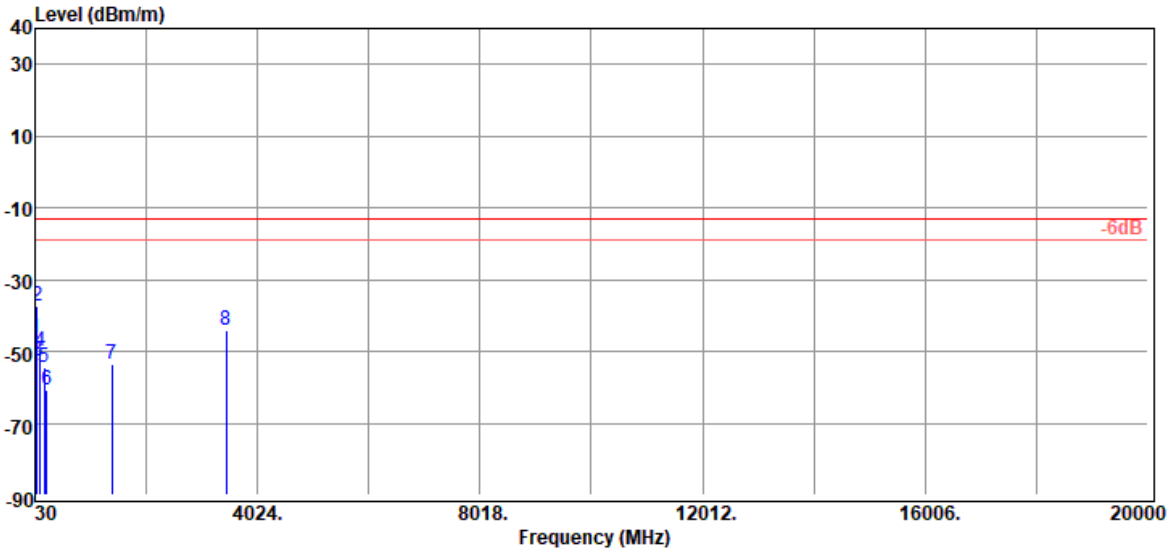

Freq. MHz	EIRP/ERP dBm	SG Output Level dBm	Antenna Gain dBi/dBd	Cable Loss dB	Limit dBm	Margin dB
48.43	-46.44	-27.69	-17.89	-0.86	-13.00	-33.44
62.01	-37.32	-21.73	-14.59	-1.00	-13.00	-24.32
69.77	-52.88	-39.77	-12.11	-1.00	-13.00	-39.88
117.30	-49.84	-41.30	-7.09	-1.45	-13.00	-36.84
202.66	-54.49	-50.41	-2.00	-2.08	-13.00	-41.49
240.49	-60.75	-56.69	-1.83	-2.23	-13.00	-47.75
1415.00	-53.60	-54.17	7.12	-6.55	-13.00	-40.60
3465.00	-44.01	-45.49	12.51	-11.03	-13.00	-31.01

Unless otherwise stated the results shown in this test report refer only to the sample(s) tested and such sample(s) are retained for 90 days only.

除非另有說明，此報告結果僅對測試之樣品負責，同時此樣品僅保留90天。本報告未經本公司書面許可，不可部份複製。

This document is issued by the Company subject to its General Conditions of Service printed overleaf, available on request or accessible at <http://www.sgs.com.tw/Terms-and-Conditions> and for electronic format documents, subject to Terms and Conditions for Electronic Documents at <http://www.sgs.com.tw/Terms-and-Conditions>. Attention is drawn to the limitation of liability, indemnification and jurisdiction issues defined therein. Any holder of this document is advised that information contained hereon reflects the Company's findings at the time of its intervention only and within the limits of Client's instructions, if any. The Company's sole responsibility is to its Client and this document does not exonerate parties to a transaction from exercising all their rights and obligations under the transaction documents. This document cannot be reproduced except in full, without prior written approval of the Company. Any unauthorized alteration, forgery or falsification of the content or appearance of this document is unlawful and offenders may be prosecuted to the fullest extent of the law.

Report Number :E2/2019/A0032
 Operation Mode :LTE B4+B12
 Test Mode :TX CH MID
 EUT Pol :E2 Plan
 Test Frequency :1732.5 MHz +707.5 MHz

Test Date :2020-02-17
 Temp./Humi. :21.8/41
 Antenna Pol. :HORIZONTAL
 Engineer :Enzo

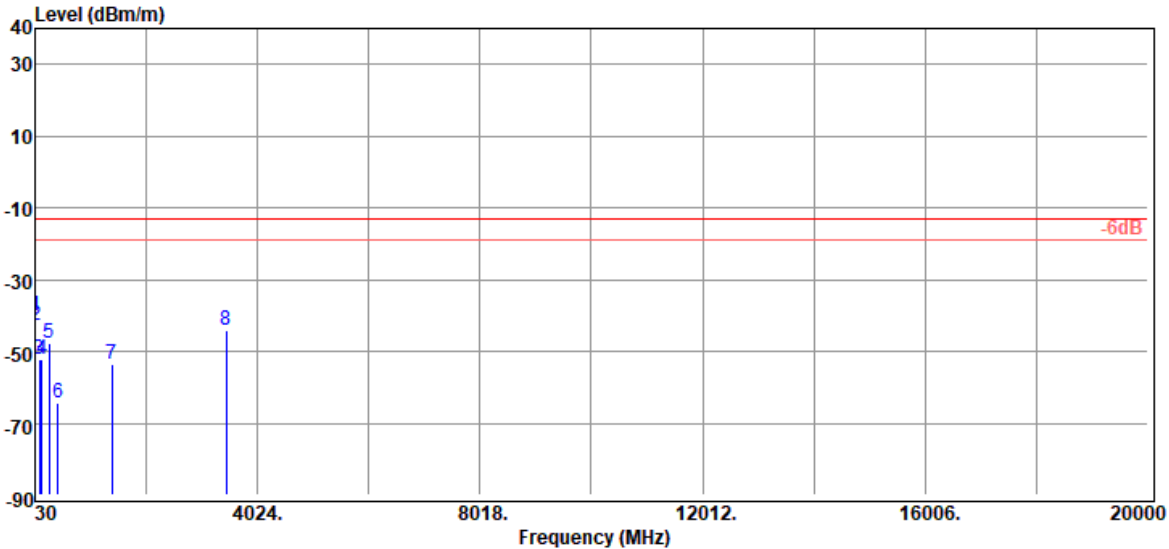

Freq. MHz	EIRP/ERP dBm	SG Output Level dBm	Antenna Gain dBi/dBd	Cable Loss dB	Limit dBm	Margin dB
35.82	-39.92	-19.52	-19.64	-0.76	-13.00	-26.92
41.64	-42.88	-23.10	-18.92	-0.86	-13.00	-29.88
116.33	-52.40	-43.82	-7.13	-1.45	-13.00	-39.40
147.37	-52.17	-42.93	-7.57	-1.67	-13.00	-39.17
287.05	-47.87	-43.73	-1.66	-2.48	-13.00	-34.87
445.16	-64.17	-59.88	-1.37	-2.92	-13.00	-51.17
1415.00	-53.59	-54.16	7.12	-6.55	-13.00	-40.59
3465.00	-44.14	-45.62	12.51	-11.03	-13.00	-31.14

Unless otherwise stated the results shown in this test report refer only to the sample(s) tested and such sample(s) are retained for 90 days only.

除非另有說明，此報告結果僅對測試之樣品負責，同時此樣品僅保留90天。本報告未經本公司書面許可，不可部份複製。

This document is issued by the Company subject to its General Conditions of Service printed overleaf, available on request or accessible at <http://www.sgs.com.tw/Terms-and-Conditions> and for electronic format documents, subject to Terms and Conditions for Electronic Documents at <http://www.sgs.com.tw/Terms-and-Conditions>. Attention is drawn to the limitation of liability, indemnification and jurisdiction issues defined therein. Any holder of this document is advised that information contained hereon reflects the Company's findings at the time of its intervention only and within the limits of Client's instructions, if any. The Company's sole responsibility is to its Client and this document does not exonerate parties to a transaction from exercising all their rights and obligations under the transaction documents. This document cannot be reproduced except in full, without prior written approval of the Company. Any unauthorized alteration, forgery or falsification of the content or appearance of this document is unlawful and offenders may be prosecuted to the fullest extent of the law.

Report Number	:E2/2019/A0032	Test Date	:2020-02-17
Operation Mode	:LTE B4+B12	Temp./Humi.	:21.8/41
Test Mode	:TX CH HIGH	Antenna Pol.	:VERTICAL
EUT Pol	:E2 Plan	Engineer	:Enzo
Test Frequency	:1745 MHz +711 MHz		

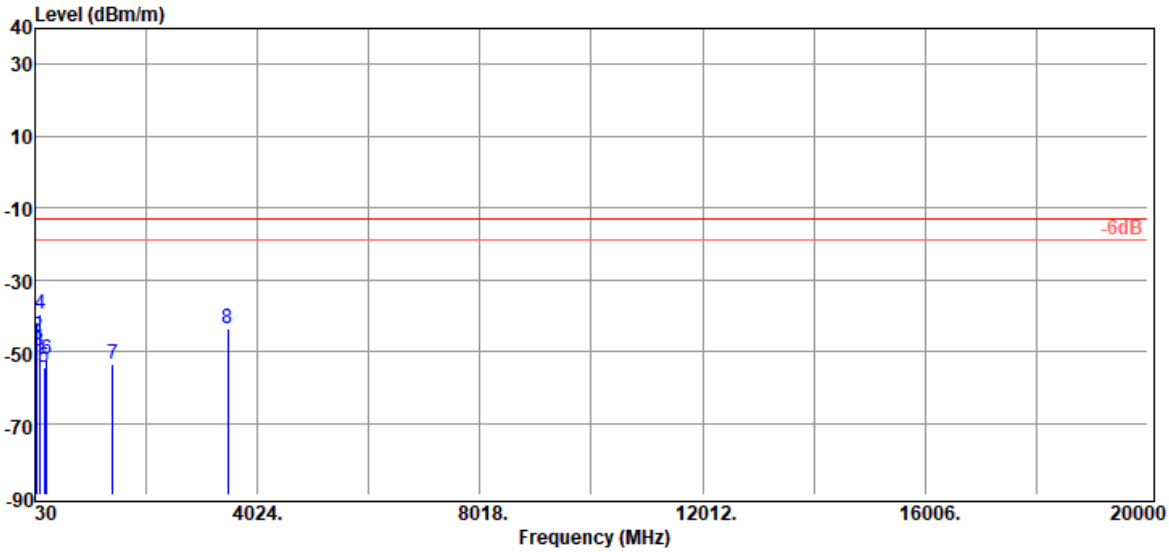

Freq. MHz	EIRP/ERP dBm	SG Output Level dBm	Antenna Gain dBi/dBd	Cable Loss dB	Limit dBm	Margin dB
58.13	-47.58	-30.87	-15.74	-0.97	-13.00	-34.58
70.74	-45.98	-33.25	-11.72	-1.01	-13.00	-32.98
116.33	-50.14	-41.56	-7.13	-1.45	-13.00	-37.14
128.94	-39.66	-30.79	-7.23	-1.64	-13.00	-26.66
201.69	-54.59	-50.46	-2.05	-2.08	-13.00	-41.59
236.61	-52.36	-48.38	-1.76	-2.22	-13.00	-39.36
1422.00	-53.50	-54.12	7.18	-6.56	-13.00	-40.50
3490.00	-43.67	-45.16	12.36	-10.87	-13.00	-30.67

Unless otherwise stated the results shown in this test report refer only to the sample(s) tested and such sample(s) are retained for 90 days only.

除非另有說明，此報告結果僅對測試之樣品負責，同時此樣品僅保留90天。本報告未經本公司書面許可，不可部份複製。

This document is issued by the Company subject to its General Conditions of Service printed overleaf, available on request or accessible at <http://www.sgs.com.tw/Terms-and-Conditions> and for electronic format documents, subject to Terms and Conditions for Electronic Documents at <http://www.sgs.com.tw/Terms-and-Conditions>. Attention is drawn to the limitation of liability, indemnification and jurisdiction issues defined therein. Any holder of this document is advised that information contained hereon reflects the Company's findings at the time of its intervention only and within the limits of Client's instructions, if any. The Company's sole responsibility is to its Client and this document does not exonerate parties to a transaction from exercising all their rights and obligations under the transaction documents. This document cannot be reproduced except in full, without prior written approval of the Company. Any unauthorized alteration, forgery or falsification of the content or appearance of this document is unlawful and offenders may be prosecuted to the fullest extent of the law.

Report Number :E2/2019/A0032
 Operation Mode :LTE B4+B12
 Test Mode :TX CH HIGH
 EUT Pol :E2 Plan
 Test Frequency :1745 MHz +711 MHz

Test Date :2020-02-17
 Temp./Humi. :21.8/41
 Antenna Pol. :HORIZONTAL
 Engineer :Enzo

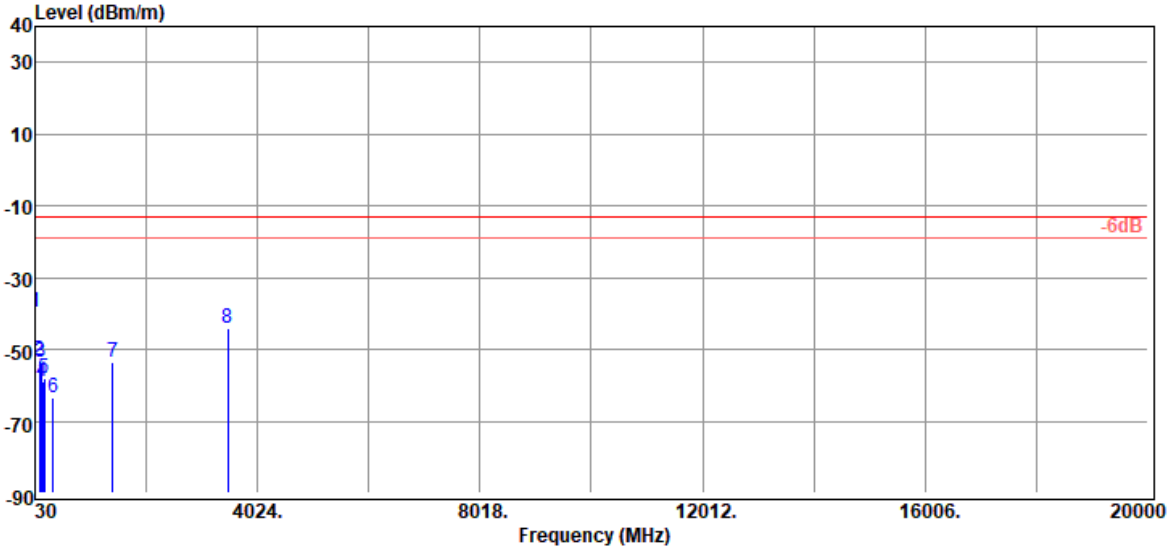

Freq. MHz	EIRP/ERP dBm	SG Output Level dBm	Antenna Gain dBi/dBd	Cable Loss dB	Limit dBm	Margin dB
35.82	-39.44	-19.04	-19.64	-0.76	-13.00	-26.44
111.48	-53.13	-44.59	-7.09	-1.45	-13.00	-40.13
136.70	-53.70	-44.44	-7.60	-1.66	-13.00	-40.70
162.89	-58.82	-50.31	-6.81	-1.70	-13.00	-45.82
196.84	-57.88	-53.51	-2.36	-2.01	-13.00	-44.88
352.04	-63.43	-59.50	-1.35	-2.58	-13.00	-50.43
1422.00	-53.59	-54.21	7.18	-6.56	-13.00	-40.59
3490.00	-44.04	-45.53	12.36	-10.87	-13.00	-31.04

Unless otherwise stated the results shown in this test report refer only to the sample(s) tested and such sample(s) are retained for 90 days only.

除非另有說明，此報告結果僅對測試之樣品負責，同時此樣品僅保留90天。本報告未經本公司書面許可，不可部份複製。

This document is issued by the Company subject to its General Conditions of Service printed overleaf, available on request or accessible at <http://www.sgs.com.tw/Terms-and-Conditions> and for electronic format documents, subject to Terms and Conditions for Electronic Documents at <http://www.sgs.com.tw/Terms-and-Conditions>. Attention is drawn to the limitation of liability, indemnification and jurisdiction issues defined therein. Any holder of this document is advised that information contained hereon reflects the Company's findings at the time of its intervention only and within the limits of Client's instructions, if any. The Company's sole responsibility is to its Client and this document does not exonerate parties to a transaction from exercising all their rights and obligations under the transaction documents. This document cannot be reproduced except in full, without prior written approval of the Company. Any unauthorized alteration, forgery or falsification of the content or appearance of this document is unlawful and offenders may be prosecuted to the fullest extent of the law.

SGS Taiwan Ltd.

台灣檢驗科技股份有限公司

No.134,Wu Kung Road, New Taipei Industrial Park, Wuku District, New Taipei City, Taiwan/新北市五股區新北產業園區五工路 134 號

t (886-2) 2299-3279

f (886-2) 2298-0488

www.sgs.com.tw

Member of SGS Group

Radiated Spurious Emission Measurement Result: LTE Band 4 + LTE Band 13 Mode

Report Number	:E2/2019/A0032	Test Date	:2020-02-17
Operation Mode	:LTE B4+B13	Temp./Humi.	:21.8/41
Test Mode	:TX CH LOW+MID	Antenna Pol.	:VERTICAL
EUT Pol	:E2 Plan	Engineer	:Enzo
Test Frequency	:1720 MHz + 782 MHz		

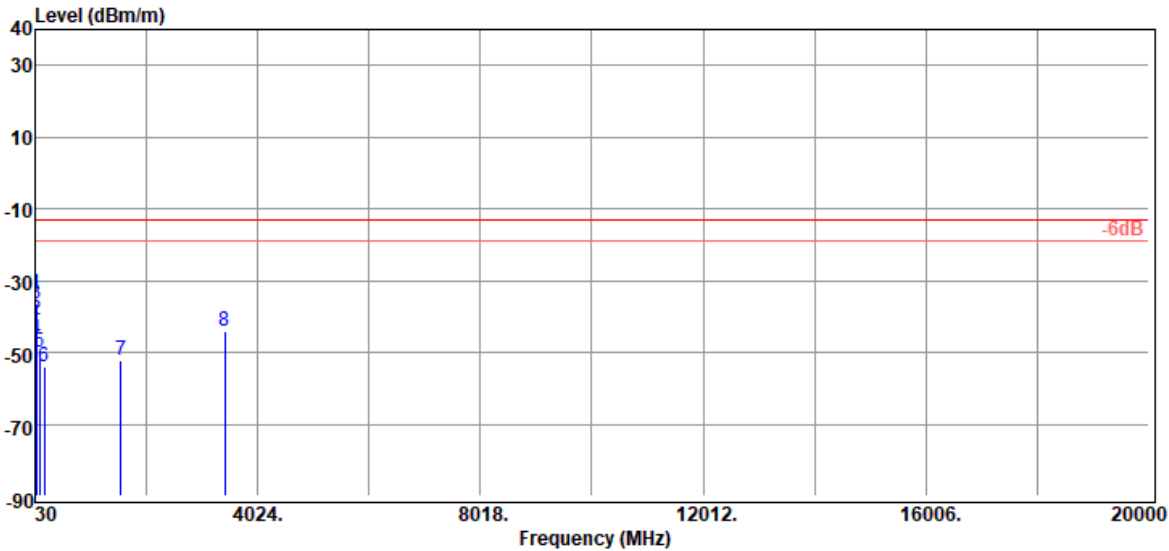

Freq. MHz	EIRP/ERP dBm	SG Output Level dBm	Antenna Gain dBi/dBd	Cable Loss dB	Limit dBm	Margin dB
35.82	-33.88	-13.48	-19.64	-0.76	-13.00	-20.88
42.61	-41.03	-21.36	-18.81	-0.86	-13.00	-28.03
48.43	-36.33	-17.58	-17.89	-0.86	-13.00	-23.33
56.19	-46.46	-29.26	-16.25	-0.95	-13.00	-33.46
116.33	-49.78	-41.20	-7.13	-1.45	-13.00	-36.78
202.66	-54.15	-50.07	-2.00	-2.08	-13.00	-41.15
1564.00	-52.15	-53.86	8.74	-7.03	-13.00	-39.15
3440.00	-44.22	-45.65	12.62	-11.19	-13.00	-31.22

Unless otherwise stated the results shown in this test report refer only to the sample(s) tested and such sample(s) are retained for 90 days only.

除非另有說明，此報告結果僅對測試之樣品負責，同時此樣品僅保留90天。本報告未經本公司書面許可，不可部份複製。

This document is issued by the Company subject to its General Conditions of Service printed overleaf, available on request or accessible at <http://www.sgs.com.tw/Terms-and-Conditions> and for electronic format documents, subject to Terms and Conditions for Electronic Documents at <http://www.sgs.com.tw/Terms-and-Conditions>. Attention is drawn to the limitation of liability, indemnification and jurisdiction issues defined therein. Any holder of this document is advised that information contained hereon reflects the Company's findings at the time of its intervention only and within the limits of Client's instructions, if any. The Company's sole responsibility is to its Client and this document does not exonerate parties to a transaction from exercising all their rights and obligations under the transaction documents. This document cannot be reproduced except in full, without prior written approval of the Company. Any unauthorized alteration, forgery or falsification of the content or appearance of this document is unlawful and offenders may be prosecuted to the fullest extent of the law.

Report Number :E2/2019/A0032
 Operation Mode :LTE B4+B13
 Test Mode :TX CH LOW+MID
 EUT Pol :E2 Plan
 Test Frequency :1720 MHz + 782 MHz

Test Date :2020-02-17
 Temp./Humi. :21.8/41
 Antenna Pol. :HORIZONTAL
 Engineer :Enzo

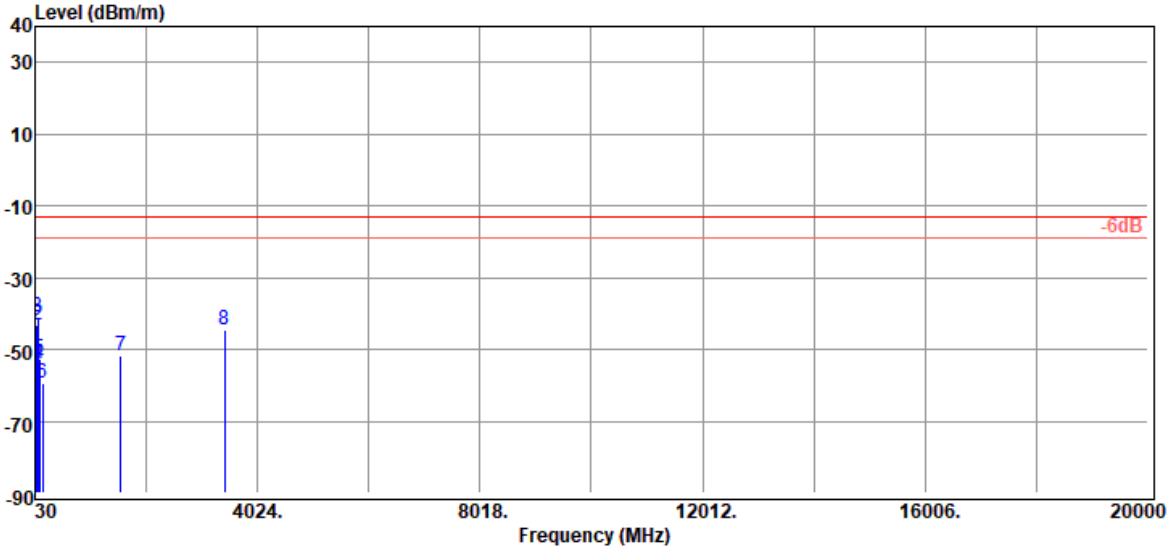

Freq. MHz	EIRP/ERP dBm	SG Output Level dBm	Antenna Gain dBi/dBd	Cable Loss dB	Limit dBm	Margin dB
36.79	-51.07	-30.86	-19.43	-0.78	-13.00	-38.07
68.80	-43.08	-29.63	-12.45	-1.00	-13.00	-30.08
83.35	-41.09	-32.48	-7.45	-1.16	-13.00	-28.09
104.69	-53.87	-45.70	-6.78	-1.39	-13.00	-40.87
114.39	-52.62	-44.06	-7.11	-1.45	-13.00	-39.62
166.77	-59.27	-51.05	-6.50	-1.72	-13.00	-46.27
1564.00	-51.89	-53.60	8.74	-7.03	-13.00	-38.89
3440.00	-44.37	-45.80	12.62	-11.19	-13.00	-31.37

Unless otherwise stated the results shown in this test report refer only to the sample(s) tested and such sample(s) are retained for 90 days only.

除非另有說明，此報告結果僅對測試之樣品負責，同時此樣品僅保留90天。本報告未經本公司書面許可，不可部份複製。

This document is issued by the Company subject to its General Conditions of Service printed overleaf, available on request or accessible at <http://www.sgs.com.tw/Terms-and-Conditions> and for electronic format documents, subject to Terms and Conditions for Electronic Documents at <http://www.sgs.com.tw/Terms-and-Conditions>. Attention is drawn to the limitation of liability, indemnification and jurisdiction issues defined therein. Any holder of this document is advised that information contained hereon reflects the Company's findings at the time of its intervention only and within the limits of Client's instructions, if any. The Company's sole responsibility is to its Client and this document does not exonerate parties to a transaction from exercising all their rights and obligations under the transaction documents. This document cannot be reproduced except in full, without prior written approval of the Company. Any unauthorized alteration, forgery or falsification of the content or appearance of this document is unlawful and offenders may be prosecuted to the fullest extent of the law.

Report Number :E2/2019/A0032
 Operation Mode :LTE B4+B13
 Test Mode :TX CH MID
 EUT Pol :E2 Plan
 Test Frequency :1732.5 MHz + 782 MHz

Test Date :2020-02-17
 Temp./Humi. :21.8/41
 Antenna Pol. :VERTICAL
 Engineer :Enzo

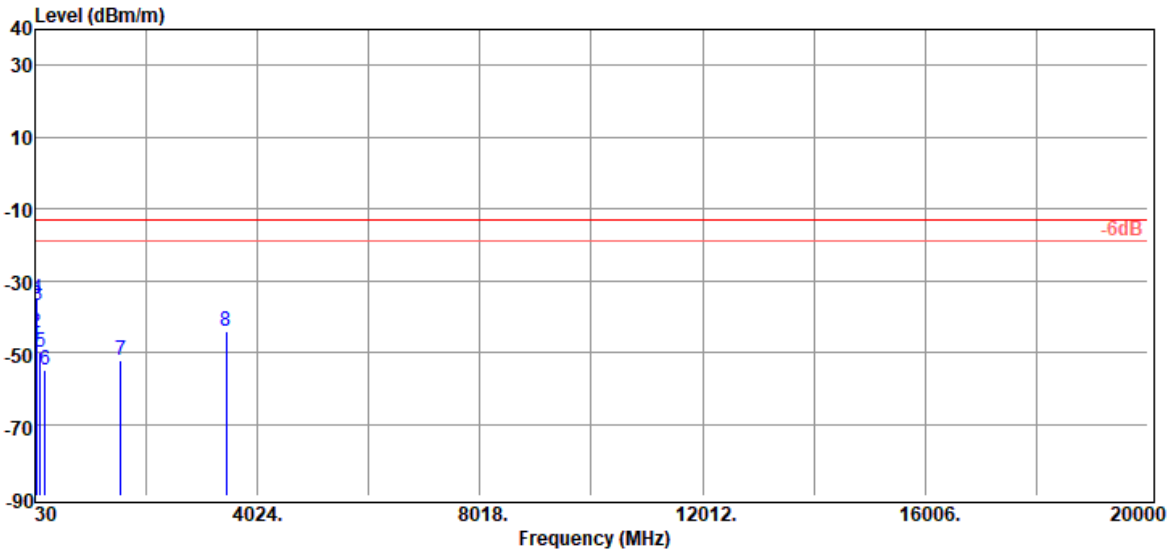

Freq. MHz	EIRP/ERP dBm	SG Output Level dBm	Antenna Gain dBi/dBd	Cable Loss dB	Limit dBm	Margin dB
36.79	-48.68	-28.47	-19.43	-0.78	-13.00	-35.68
46.49	-44.65	-25.50	-18.29	-0.86	-13.00	-31.65
59.10	-36.78	-20.29	-15.50	-0.99	-13.00	-23.78
65.89	-35.16	-20.86	-13.30	-1.00	-13.00	-22.16
117.30	-50.01	-41.47	-7.09	-1.45	-13.00	-37.01
203.63	-54.74	-50.70	-1.96	-2.08	-13.00	-41.74
1564.00	-52.20	-53.91	8.74	-7.03	-13.00	-39.20
3465.00	-44.00	-45.48	12.51	-11.03	-13.00	-31.00

Unless otherwise stated the results shown in this test report refer only to the sample(s) tested and such sample(s) are retained for 90 days only.

除非另有說明，此報告結果僅對測試之樣品負責，同時此樣品僅保留90天。本報告未經本公司書面許可，不可部份複製。

This document is issued by the Company subject to its General Conditions of Service printed overleaf, available on request or accessible at <http://www.sgs.com.tw/Terms-and-Conditions> and for electronic format documents, subject to Terms and Conditions for Electronic Documents at <http://www.sgs.com.tw/Terms-and-Conditions>. Attention is drawn to the limitation of liability, indemnification and jurisdiction issues defined therein. Any holder of this document is advised that information contained hereon reflects the Company's findings at the time of its intervention only and within the limits of Client's instructions, if any. The Company's sole responsibility is to its Client and this document does not exonerate parties to a transaction from exercising all their rights and obligations under the transaction documents. This document cannot be reproduced except in full, without prior written approval of the Company. Any unauthorized alteration, forgery or falsification of the content or appearance of this document is unlawful and offenders may be prosecuted to the fullest extent of the law.

Report Number :E2/2019/A0032
 Operation Mode :LTE B4+B13
 Test Mode :TX CH MID
 EUT Pol :E2 Plan
 Test Frequency :1732.5 MHz + 782 MHz

Test Date :2020-02-17
 Temp./Humi. :21.8/41
 Antenna Pol. :HORIZONTAL
 Engineer :Enzo

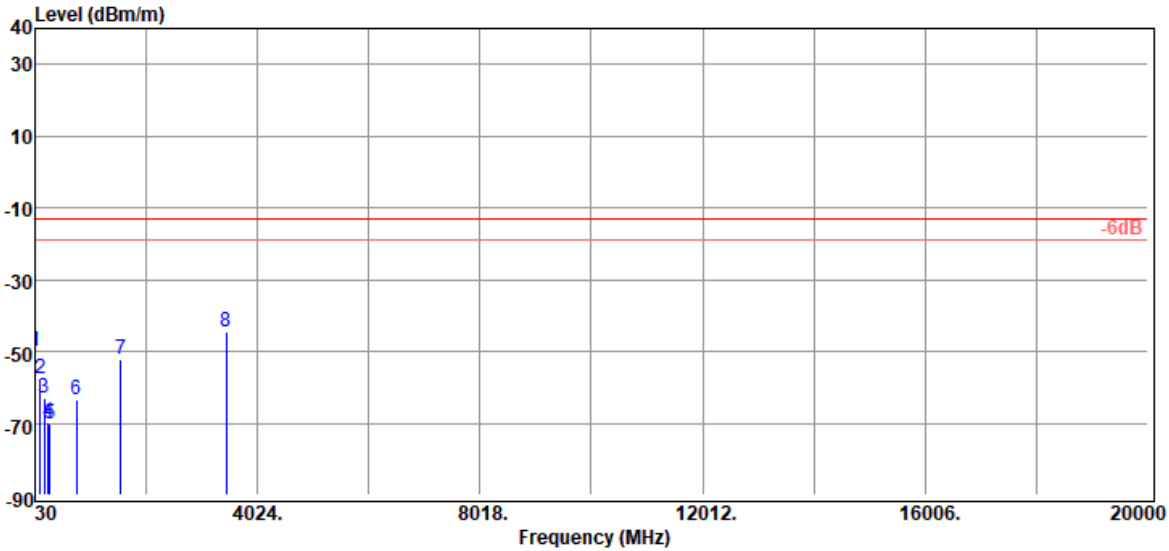

Freq. MHz	EIRP/ERP dBm	SG Output Level dBm	Antenna Gain dBi/dBd	Cable Loss dB	Limit dBm	Margin dB
30.97	-49.98	-28.73	-20.62	-0.63	-13.00	-36.98
119.24	-57.67	-49.18	-7.04	-1.45	-13.00	-44.67
201.69	-62.80	-58.67	-2.05	-2.08	-13.00	-49.80
272.50	-69.69	-65.75	-1.63	-2.31	-13.00	-56.69
295.78	-70.08	-66.04	-1.53	-2.51	-13.00	-57.08
773.02	-63.48	-57.53	-1.57	-4.38	-13.00	-50.48
1564.00	-52.40	-54.11	8.74	-7.03	-13.00	-39.40
3465.00	-44.54	-46.02	12.51	-11.03	-13.00	-31.54

Unless otherwise stated the results shown in this test report refer only to the sample(s) tested and such sample(s) are retained for 90 days only.

除非另有說明，此報告結果僅對測試之樣品負責，同時此樣品僅保留90天。本報告未經本公司書面許可，不可部份複製。

This document is issued by the Company subject to its General Conditions of Service printed overleaf, available on request or accessible at <http://www.sgs.com.tw/Terms-and-Conditions> and for electronic format documents, subject to Terms and Conditions for Electronic Documents at <http://www.sgs.com.tw/Terms-and-Conditions>. Attention is drawn to the limitation of liability, indemnification and jurisdiction issues defined therein. Any holder of this document is advised that information contained hereon reflects the Company's findings at the time of its intervention only and within the limits of Client's instructions, if any. The Company's sole responsibility is to its Client and this document does not exonerate parties to a transaction from exercising all their rights and obligations under the transaction documents. This document cannot be reproduced except in full, without prior written approval of the Company. Any unauthorized alteration, forgery or falsification of the content or appearance of this document is unlawful and offenders may be prosecuted to the fullest extent of the law.

SGS Taiwan Ltd.

台灣檢驗科技股份有限公司

No.134,Wu Kung Road, New Taipei Industrial Park, Wuku District, New Taipei City, Taiwan/新北市五股區新北產業園區五工路 134 號

t (886-2) 2299-3279

f (886-2) 2298-0488

www.sgs.com.tw

Member of SGS Group

Report Number	:E2/2019/A0032	Test Date	:2020-02-17
Operation Mode	:LTE B4+B13	Temp./Humi.	:21.8/41
Test Mode	:TX CH HIGH+MID	Antenna Pol.	:VERTICAL
EUT Pol	:E2 Plan	Engineer	:Enzo
Test Frequency	:1745 MHz + 782 MHz		

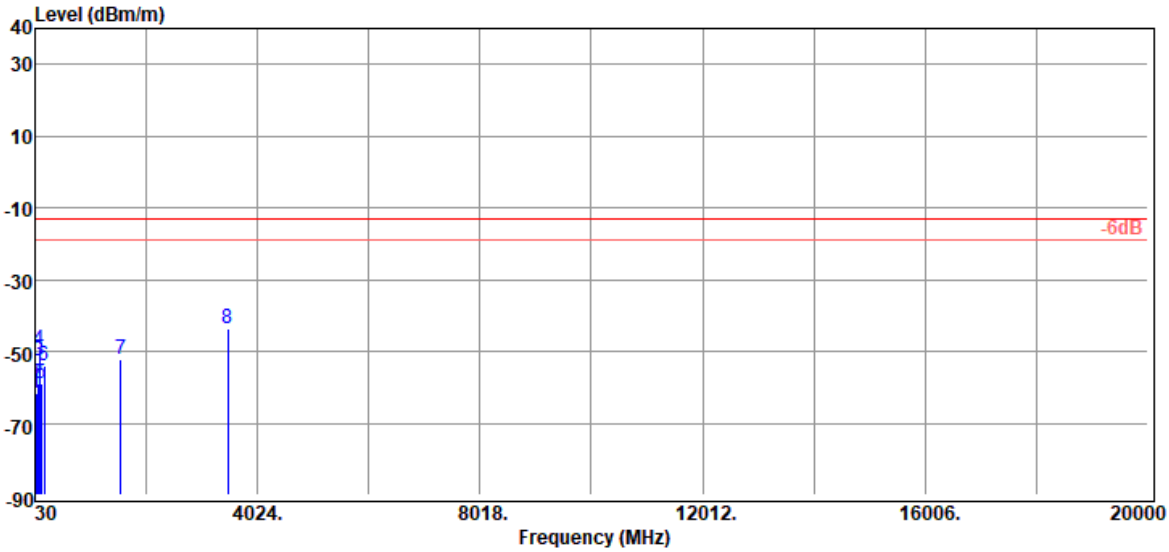

Freq. MHz	EIRP/ERP dBm	SG Output Level dBm	Antenna Gain dBi/dBd	Cable Loss dB	Limit dBm	Margin dB
55.22	-61.75	-44.34	-16.48	-0.93	-13.00	-48.75
84.32	-58.77	-50.42	-7.19	-1.16	-13.00	-45.77
103.72	-52.57	-44.56	-6.64	-1.37	-13.00	-39.57
116.33	-49.56	-40.98	-7.13	-1.45	-13.00	-36.56
139.61	-59.12	-49.82	-7.64	-1.66	-13.00	-46.12
200.72	-54.06	-49.89	-2.09	-2.08	-13.00	-41.06
1564.00	-52.15	-53.86	8.74	-7.03	-13.00	-39.15
3490.00	-43.75	-45.24	12.36	-10.87	-13.00	-30.75

Unless otherwise stated the results shown in this test report refer only to the sample(s) tested and such sample(s) are retained for 90 days only.

除非另有說明，此報告結果僅對測試之樣品負責，同時此樣品僅保留90天。本報告未經本公司書面許可，不可部份複製。

This document is issued by the Company subject to its General Conditions of Service printed overleaf, available on request or accessible at <http://www.sgs.com.tw/Terms-and-Conditions> and for electronic format documents, subject to Terms and Conditions for Electronic Documents at <http://www.sgs.com.tw/Terms-and-Conditions>. Attention is drawn to the limitation of liability, indemnification and jurisdiction issues defined therein. Any holder of this document is advised that information contained hereon reflects the Company's findings at the time of its intervention only and within the limits of Client's instructions, if any. The Company's sole responsibility is to its Client and this document does not exonerate parties to a transaction from exercising all their rights and obligations under the transaction documents. This document cannot be reproduced except in full, without prior written approval of the Company. Any unauthorized alteration, forgery or falsification of the content or appearance of this document is unlawful and offenders may be prosecuted to the fullest extent of the law.

Report Number :E2/2019/A0032
 Operation Mode :LTE B4+B13
 Test Mode :TX CH HIGH+MID
 EUT Pol :E2 Plan
 Test Frequency :1745 MHz + 782 MHz

Test Date :2020-02-17
 Temp./Humi. :21.8/41
 Antenna Pol. :HORIZONTAL
 Engineer :Enzo

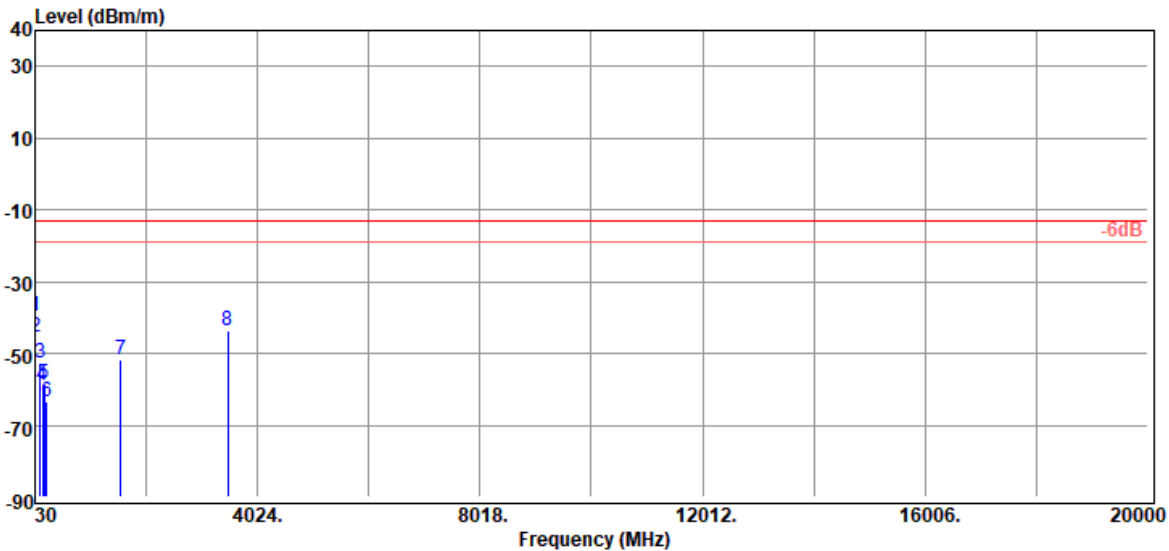

Freq. MHz	EIRP/ERP dBm	SG Output Level dBm	Antenna Gain dBi/dBd	Cable Loss dB	Limit dBm	Margin dB
32.91	-39.46	-18.69	-20.09	-0.68	-13.00	-26.46
41.64	-45.36	-25.58	-18.92	-0.86	-13.00	-32.36
117.30	-52.75	-44.21	-7.09	-1.45	-13.00	-39.75
163.86	-58.75	-50.39	-6.66	-1.70	-13.00	-45.75
191.99	-58.74	-54.06	-2.77	-1.91	-13.00	-45.74
239.52	-63.51	-59.45	-1.83	-2.23	-13.00	-50.51
1564.00	-51.92	-53.63	8.74	-7.03	-13.00	-38.92
3490.00	-43.86	-45.35	12.36	-10.87	-13.00	-30.86

Unless otherwise stated the results shown in this test report refer only to the sample(s) tested and such sample(s) are retained for 90 days only.

除非另有說明，此報告結果僅對測試之樣品負責，同時此樣品僅保留90天。本報告未經本公司書面許可，不可部份複製。

This document is issued by the Company subject to its General Conditions of Service printed overleaf, available on request or accessible at <http://www.sgs.com.tw/Terms-and-Conditions> and for electronic format documents, subject to Terms and Conditions for Electronic Documents at <http://www.sgs.com.tw/Terms-and-Conditions>. Attention is drawn to the limitation of liability, indemnification and jurisdiction issues defined therein. Any holder of this document is advised that information contained hereon reflects the Company's findings at the time of its intervention only and within the limits of Client's instructions, if any. The Company's sole responsibility is to its Client and this document does not exonerate parties to a transaction from exercising all their rights and obligations under the transaction documents. This document cannot be reproduced except in full, without prior written approval of the Company. Any unauthorized alteration, forgery or falsification of the content or appearance of this document is unlawful and offenders may be prosecuted to the fullest extent of the law.

Radiated Spurious Emission Measurement Result: LTE Band 5 + LTE Band 7 Mode

Report Number	:E2/2019/A0032	Test Date	:2020-02-17
Operation Mode	:LTE B5+B7	Temp./Humi.	:21.8/41
Test Mode	:TX CH LOW	Antenna Pol.	:VERTICAL
EUT Pol	:E2 Plan	Engineer	:Enzo
Test Frequency	:829 MHz + 2510 MHz		

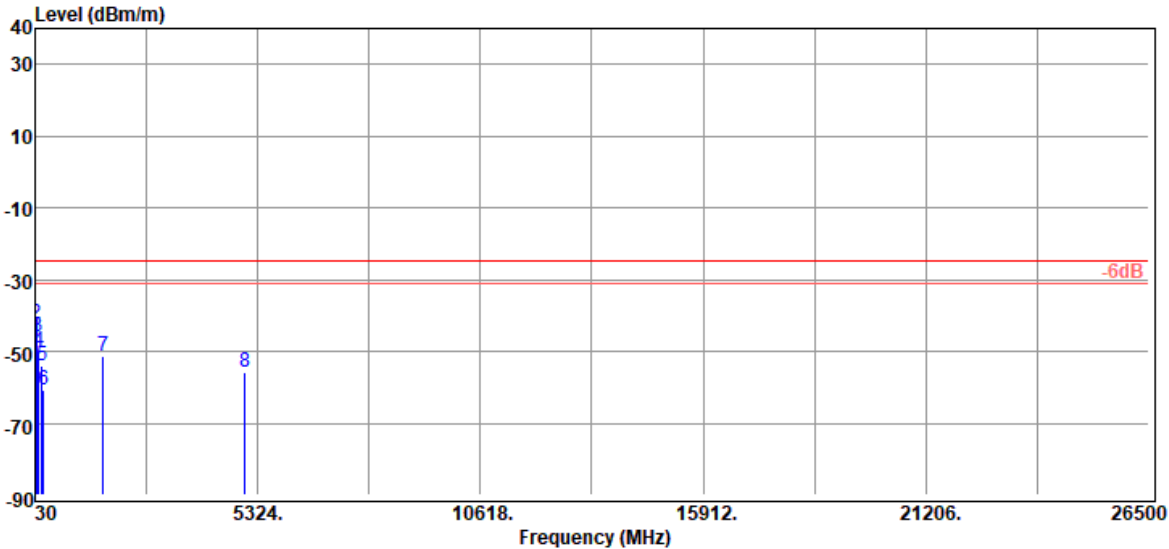

Freq. MHz	EIRP/ERP dBm	SG Output Level dBm	Antenna Gain dBi/dBd	Cable Loss dB	Limit dBm	Margin dB
36.79	-46.51	-26.30	-19.43	-0.78	-25.00	-21.51
59.10	-42.16	-25.67	-15.50	-0.99	-25.00	-17.16
82.38	-45.72	-36.88	-7.68	-1.16	-25.00	-20.72
115.36	-50.12	-41.53	-7.14	-1.45	-25.00	-25.12
197.81	-54.20	-49.93	-2.24	-2.03	-25.00	-29.20
240.49	-60.67	-56.61	-1.83	-2.23	-25.00	-35.67
1658.00	-51.48	-53.28	9.38	-7.58	-25.00	-26.48
5020.00	-55.72	-56.72	12.46	-11.46	-25.00	-30.72

Unless otherwise stated the results shown in this test report refer only to the sample(s) tested and such sample(s) are retained for 90 days only.

除非另有說明，此報告結果僅對測試之樣品負責，同時此樣品僅保留90天。本報告未經本公司書面許可，不可部份複製。

This document is issued by the Company subject to its General Conditions of Service printed overleaf, available on request or accessible at <http://www.sgs.com.tw/Terms-and-Conditions> and for electronic format documents, subject to Terms and Conditions for Electronic Documents at <http://www.sgs.com.tw/Terms-and-Conditions>. Attention is drawn to the limitation of liability, indemnification and jurisdiction issues defined therein. Any holder of this document is advised that information contained hereon reflects the Company's findings at the time of its intervention only and within the limits of Client's instructions, if any. The Company's sole responsibility is to its Client and this document does not exonerate parties to a transaction from exercising all their rights and obligations under the transaction documents. This document cannot be reproduced except in full, without prior written approval of the Company. Any unauthorized alteration, forgery or falsification of the content or appearance of this document is unlawful and offenders may be prosecuted to the fullest extent of the law.

Report Number :E2/2019/A0032
 Operation Mode :LTE B5+B7
 Test Mode :TX CH LOW
 EUT Pol :E2 Plan
 Test Frequency :829 MHz + 2510 MHz

Test Date :2020-02-17
 Temp./Humi. :21.8/41
 Antenna Pol. :HORIZONTAL
 Engineer :Enzo

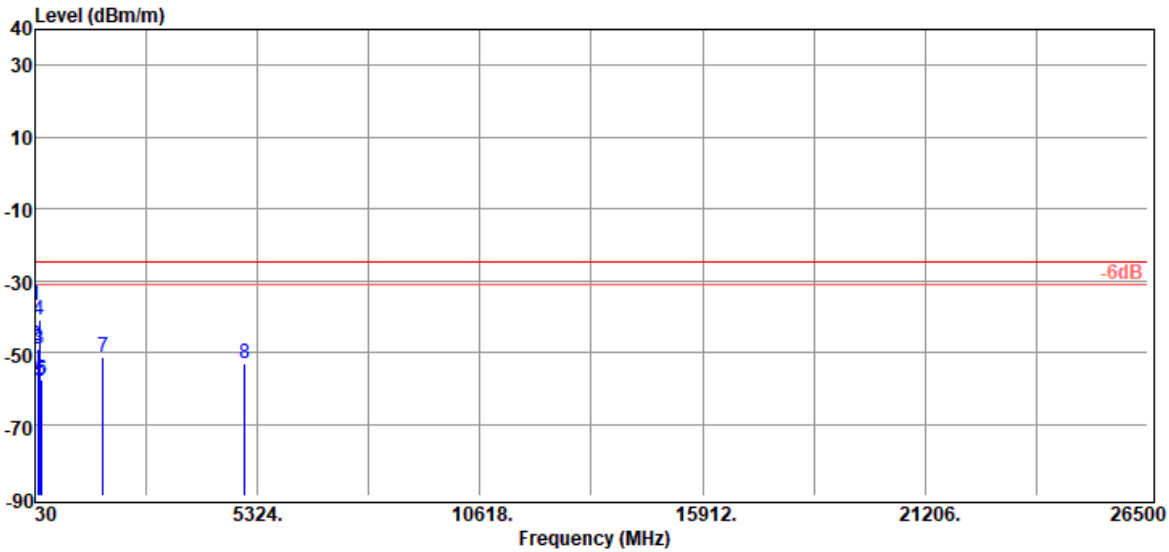

Freq. MHz	EIRP/ERP dBm	SG Output Level dBm	Antenna Gain dBi/dBd	Cable Loss dB	Limit dBm	Margin dB
36.79	-37.11	-16.90	-19.43	-0.78	-25.00	-12.11
43.58	-48.22	-28.65	-18.71	-0.86	-25.00	-23.22
114.39	-49.01	-40.45	-7.11	-1.45	-25.00	-24.01
141.55	-40.90	-31.56	-7.68	-1.66	-25.00	-15.90
161.92	-58.14	-49.60	-6.85	-1.69	-25.00	-33.14
191.02	-57.71	-53.00	-2.82	-1.89	-25.00	-32.71
1658.00	-51.30	-53.10	9.38	-7.58	-25.00	-26.30
5020.00	-52.98	-53.98	12.46	-11.46	-25.00	-27.98

Unless otherwise stated the results shown in this test report refer only to the sample(s) tested and such sample(s) are retained for 90 days only.

除非另有說明，此報告結果僅對測試之樣品負責，同時此樣品僅保留90天。本報告未經本公司書面許可，不可部份複製。

This document is issued by the Company subject to its General Conditions of Service printed overleaf, available on request or accessible at <http://www.sgs.com.tw/Terms-and-Conditions> and for electronic format documents, subject to Terms and Conditions for Electronic Documents at <http://www.sgs.com.tw/Terms-and-Conditions>. Attention is drawn to the limitation of liability, indemnification and jurisdiction issues defined therein. Any holder of this document is advised that information contained hereon reflects the Company's findings at the time of its intervention only and within the limits of Client's instructions, if any. The Company's sole responsibility is to its Client and this document does not exonerate parties to a transaction from exercising all their rights and obligations under the transaction documents. This document cannot be reproduced except in full, without prior written approval of the Company. Any unauthorized alteration, forgery or falsification of the content or appearance of this document is unlawful and offenders may be prosecuted to the fullest extent of the law.

Report Number :E2/2019/A0032
 Operation Mode :LTE B5+B7
 Test Mode :TX CH MID
 EUT Pol :E2 Plan
 Test Frequency :836.5 MHz + 2535 MHz

Test Date :2020-02-17
 Temp./Humi. :21.8/41
 Antenna Pol. :VERTICAL
 Engineer :Enzo

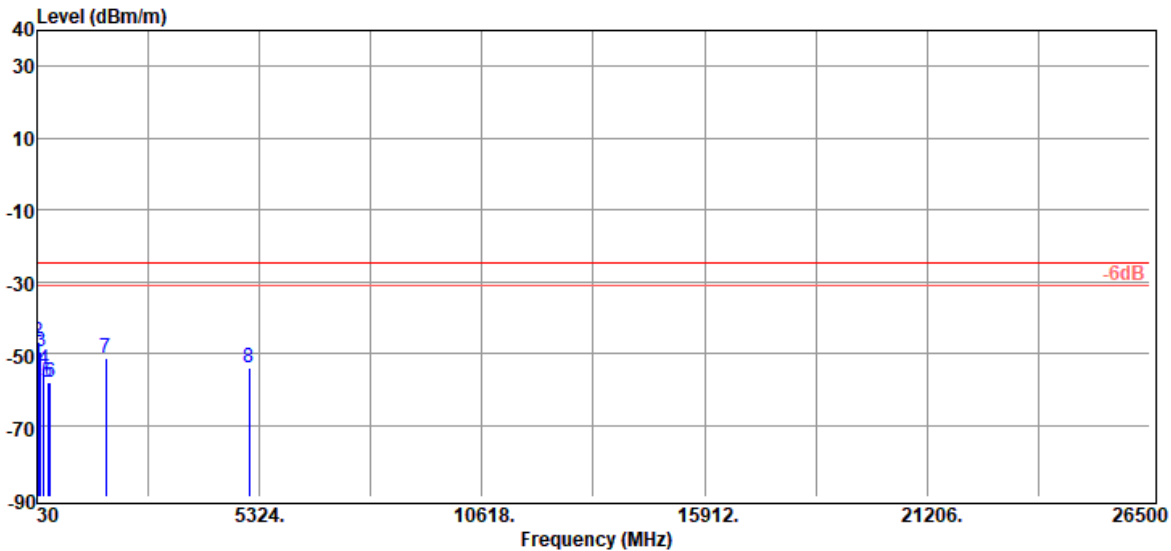

Freq. MHz	EIRP/ERP dBm	SG Output Level dBm	Antenna Gain dBi/dBd	Cable Loss dB	Limit dBm	Margin dB
60.07	-52.87	-36.61	-15.26	-1.00	-25.00	-27.87
65.89	-46.64	-32.34	-13.30	-1.00	-25.00	-21.64
117.30	-49.43	-40.89	-7.09	-1.45	-25.00	-24.43
200.72	-54.32	-50.15	-2.09	-2.08	-25.00	-29.32
294.81	-58.16	-54.10	-1.55	-2.51	-25.00	-33.16
350.10	-58.04	-54.10	-1.36	-2.58	-25.00	-33.04
1673.00	-51.14	-52.99	9.53	-7.68	-25.00	-26.14
5070.00	-53.92	-54.72	12.40	-11.60	-25.00	-28.92

Unless otherwise stated the results shown in this test report refer only to the sample(s) tested and such sample(s) are retained for 90 days only.

除非另有說明，此報告結果僅對測試之樣品負責，同時此樣品僅保留90天。本報告未經本公司書面許可，不可部份複製。

This document is issued by the Company subject to its General Conditions of Service printed overleaf, available on request or accessible at <http://www.sgs.com.tw/Terms-and-Conditions> and for electronic format documents, subject to Terms and Conditions for Electronic Documents at <http://www.sgs.com.tw/Terms-and-Conditions>. Attention is drawn to the limitation of liability, indemnification and jurisdiction issues defined therein. Any holder of this document is advised that information contained hereon reflects the Company's findings at the time of its intervention only and within the limits of Client's instructions, if any. The Company's sole responsibility is to its Client and this document does not exonerate parties to a transaction from exercising all their rights and obligations under the transaction documents. This document cannot be reproduced except in full, without prior written approval of the Company. Any unauthorized alteration, forgery or falsification of the content or appearance of this document is unlawful and offenders may be prosecuted to the fullest extent of the law.

Report Number :E2/2019/A0032
 Operation Mode :LTE B5+B7
 Test Mode :TX CH MID
 EUT Pol :E2 Plan
 Test Frequency :836.5 MHz + 2535 MHz

Test Date :2020-02-17
 Temp./Humi. :21.8/41
 Antenna Pol. :HORIZONTAL
 Engineer :Enzo

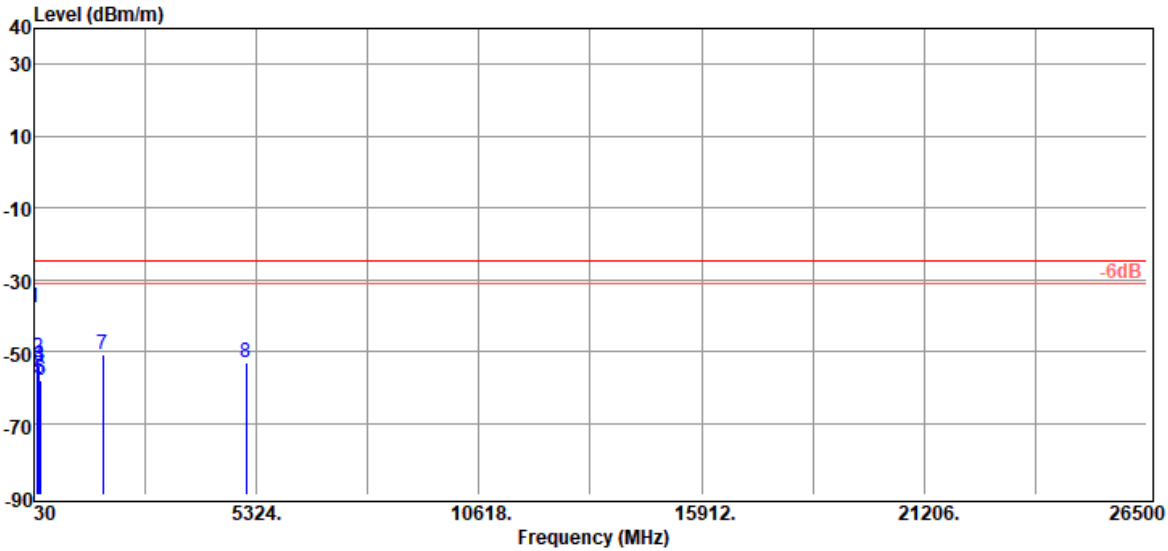

Freq. MHz	EIRP/ERP dBm	SG Output Level dBm	Antenna Gain dBi/dBd	Cable Loss dB	Limit dBm	Margin dB
33.88	-37.77	-17.22	-19.84	-0.71	-25.00	-12.77
116.33	-51.63	-43.05	-7.13	-1.45	-25.00	-26.63
146.40	-53.93	-44.63	-7.63	-1.67	-25.00	-28.93
149.31	-54.00	-44.86	-7.46	-1.68	-25.00	-29.00
162.89	-57.78	-49.27	-6.81	-1.70	-25.00	-32.78
195.87	-58.10	-53.71	-2.40	-1.99	-25.00	-33.10
1673.00	-50.98	-52.83	9.53	-7.68	-25.00	-25.98
5070.00	-53.05	-53.85	12.40	-11.60	-25.00	-28.05

Unless otherwise stated the results shown in this test report refer only to the sample(s) tested and such sample(s) are retained for 90 days only.

除非另有說明，此報告結果僅對測試之樣品負責，同時此樣品僅保留90天。本報告未經本公司書面許可，不可部份複製。

This document is issued by the Company subject to its General Conditions of Service printed overleaf, available on request or accessible at <http://www.sgs.com.tw/Terms-and-Conditions> and for electronic format documents, subject to Terms and Conditions for Electronic Documents at <http://www.sgs.com.tw/Terms-and-Conditions>. Attention is drawn to the limitation of liability, indemnification and jurisdiction issues defined therein. Any holder of this document is advised that information contained hereon reflects the Company's findings at the time of its intervention only and within the limits of Client's instructions, if any. The Company's sole responsibility is to its Client and this document does not exonerate parties to a transaction from exercising all their rights and obligations under the transaction documents. This document cannot be reproduced except in full, without prior written approval of the Company. Any unauthorized alteration, forgery or falsification of the content or appearance of this document is unlawful and offenders may be prosecuted to the fullest extent of the law.

Report Number :E2/2019/A0032
 Operation Mode :LTE B5+B7
 Test Mode :TX CH HIGH
 EUT Pol :E2 Plan
 Test Frequency :844 MHz + 2560 MHz

Test Date :2020-02-17
 Temp./Humi. :21.8/41
 Antenna Pol. :VERTICAL
 Engineer :Enzo

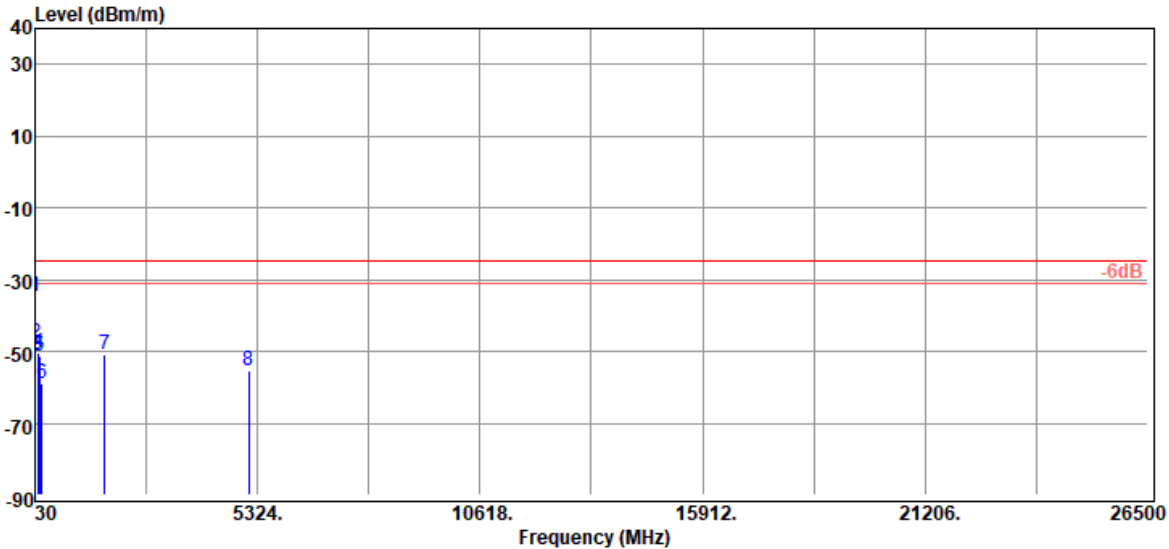

Freq. MHz	EIRP/ERP dBm	SG Output Level dBm	Antenna Gain dBi/dBd	Cable Loss dB	Limit dBm	Margin dB
38.73	-34.50	-14.42	-19.25	-0.83	-25.00	-9.50
45.52	-47.59	-28.35	-18.38	-0.86	-25.00	-22.59
99.84	-51.02	-43.47	-6.22	-1.33	-25.00	-26.02
117.30	-50.45	-41.91	-7.09	-1.45	-25.00	-25.45
139.61	-51.47	-42.17	-7.64	-1.66	-25.00	-26.47
201.69	-58.74	-54.61	-2.05	-2.08	-25.00	-33.74
1688.00	-51.01	-52.92	9.68	-7.77	-25.00	-26.01
5120.00	-55.19	-55.89	12.44	-11.74	-25.00	-30.19

Unless otherwise stated the results shown in this test report refer only to the sample(s) tested and such sample(s) are retained for 90 days only.

除非另有說明，此報告結果僅對測試之樣品負責，同時此樣品僅保留90天。本報告未經本公司書面許可，不可部份複製。

This document is issued by the Company subject to its General Conditions of Service printed overleaf, available on request or accessible at <http://www.sgs.com.tw/Terms-and-Conditions> and for electronic format documents, subject to Terms and Conditions for Electronic Documents at <http://www.sgs.com.tw/Terms-and-Conditions>. Attention is drawn to the limitation of liability, indemnification and jurisdiction issues defined therein. Any holder of this document is advised that information contained hereon reflects the Company's findings at the time of its intervention only and within the limits of Client's instructions, if any. The Company's sole responsibility is to its Client and this document does not exonerate parties to a transaction from exercising all their rights and obligations under the transaction documents. This document cannot be reproduced except in full, without prior written approval of the Company. Any unauthorized alteration, forgery or falsification of the content or appearance of this document is unlawful and offenders may be prosecuted to the fullest extent of the law.

Report Number :E2/2019/A0032
 Operation Mode :LTE B5+B7
 Test Mode :TX CH HIGH
 EUT Pol :E2 Plan
 Test Frequency :844 MHz + 2560 MHz

Test Date :2020-02-17
 Temp./Humi. :21.8/41
 Antenna Pol. :HORIZONTAL
 Engineer :Enzo

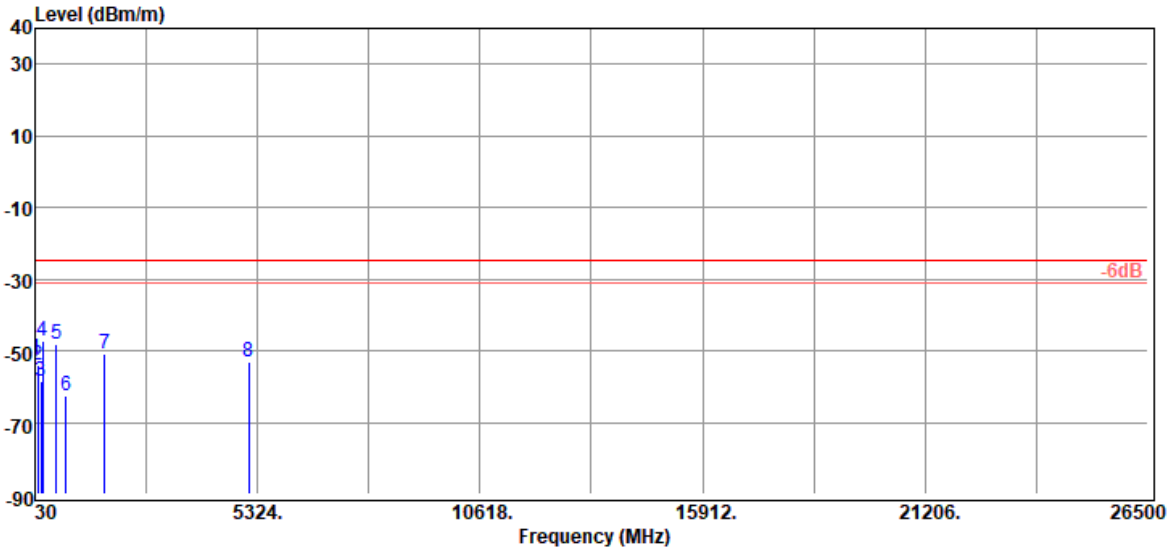

Freq. MHz	EIRP/ERP dBm	SG Output Level dBm	Antenna Gain dBi/dBd	Cable Loss dB	Limit dBm	Margin dB
34.85	-52.35	-31.85	-19.77	-0.73	-25.00	-27.35
104.69	-54.06	-45.89	-6.78	-1.39	-25.00	-29.06
166.77	-58.69	-50.47	-6.50	-1.72	-25.00	-33.69
210.42	-47.36	-43.70	-1.58	-2.08	-25.00	-22.36
546.04	-48.24	-43.37	-1.29	-3.58	-25.00	-23.24
773.02	-62.67	-56.72	-1.57	-4.38	-25.00	-37.67
1688.00	-50.84	-52.75	9.68	-7.77	-25.00	-25.84
5120.00	-53.32	-54.02	12.44	-11.74	-25.00	-28.32

Unless otherwise stated the results shown in this test report refer only to the sample(s) tested and such sample(s) are retained for 90 days only.

除非另有說明，此報告結果僅對測試之樣品負責，同時此樣品僅保留90天。本報告未經本公司書面許可，不可部份複製。

This document is issued by the Company subject to its General Conditions of Service printed overleaf, available on request or accessible at <http://www.sgs.com.tw/Terms-and-Conditions> and for electronic format documents, subject to Terms and Conditions for Electronic Documents at <http://www.sgs.com.tw/Terms-and-Conditions>. Attention is drawn to the limitation of liability, indemnification and jurisdiction issues defined therein. Any holder of this document is advised that information contained hereon reflects the Company's findings at the time of its intervention only and within the limits of Client's instructions, if any. The Company's sole responsibility is to its Client and this document does not exonerate parties to a transaction from exercising all their rights and obligations under the transaction documents. This document cannot be reproduced except in full, without prior written approval of the Company. Any unauthorized alteration, forgery or falsification of the content or appearance of this document is unlawful and offenders may be prosecuted to the fullest extent of the law.

Radiated Spurious Emission Measurement Result: LTE Band 5 + LTE Band 66 Mode

Report Number	:E2/2019/A0032	Test Date	:2020-02-17
Operation Mode	:LTE B5+B66	Temp./Humi.	:21.8/41
Test Mode	:TX CH LOW	Antenna Pol.	:VERTICAL
EUT Pol	:E2 Plan	Engineer	:Enzo
Test Frequency	:829 MHz + 1745 MHz		

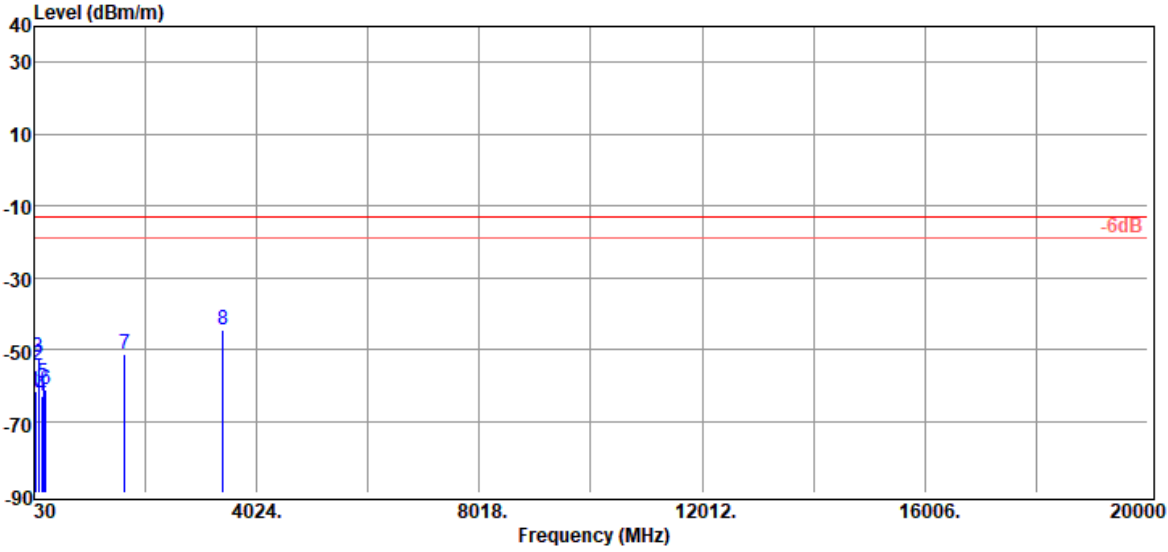

Freq. MHz	EIRP/ERP dBm	SG Output Level dBm	Antenna Gain dBi/dBd	Cable Loss dB	Limit dBm	Margin dB
55.22	-61.72	-44.31	-16.48	-0.93	-13.00	-48.72
104.69	-54.56	-46.39	-6.78	-1.39	-13.00	-41.56
115.36	-52.12	-43.53	-7.14	-1.45	-13.00	-39.12
161.92	-62.82	-54.28	-6.85	-1.69	-13.00	-49.82
201.69	-59.57	-55.44	-2.05	-2.08	-13.00	-46.57
237.58	-61.44	-57.44	-1.78	-2.22	-13.00	-48.44
1658.00	-51.39	-53.19	9.38	-7.58	-13.00	-38.39
3425.00	-44.56	-45.92	12.65	-11.29	-13.00	-31.56

Unless otherwise stated the results shown in this test report refer only to the sample(s) tested and such sample(s) are retained for 90 days only.

除非另有說明，此報告結果僅對測試之樣品負責，同時此樣品僅保留90天。本報告未經本公司書面許可，不可部份複製。

This document is issued by the Company subject to its General Conditions of Service printed overleaf, available on request or accessible at <http://www.sgs.com.tw/Terms-and-Conditions> and for electronic format documents, subject to Terms and Conditions for Electronic Documents at <http://www.sgs.com.tw/Terms-and-Conditions>. Attention is drawn to the limitation of liability, indemnification and jurisdiction issues defined therein. Any holder of this document is advised that information contained hereon reflects the Company's findings at the time of its intervention only and within the limits of Client's instructions, if any. The Company's sole responsibility is to its Client and this document does not exonerate parties to a transaction from exercising all their rights and obligations under the transaction documents. This document cannot be reproduced except in full, without prior written approval of the Company. Any unauthorized alteration, forgery or falsification of the content or appearance of this document is unlawful and offenders may be prosecuted to the fullest extent of the law.

Report Number :E2/2019/A0032
 Operation Mode :LTE B5+B66
 Test Mode :TX CH LOW
 EUT Pol :E2 Plan
 Test Frequency :829 MHz + 1745 MHz

Test Date :2020-02-17
 Temp./Humi. :21.8/41
 Antenna Pol. :HORIZONTAL
 Engineer :Enzo

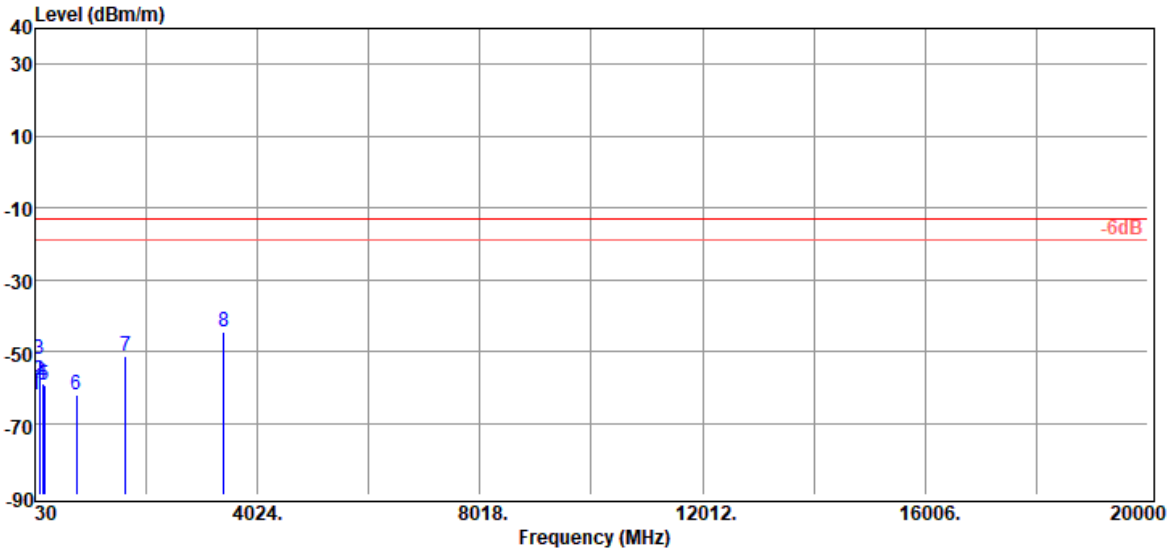

Freq. MHz	EIRP/ERP dBm	SG Output Level dBm	Antenna Gain dBi/dBd	Cable Loss dB	Limit dBm	Margin dB
39.70	-61.97	-41.98	-19.14	-0.85	-13.00	-48.97
104.69	-58.05	-49.88	-6.78	-1.39	-13.00	-45.05
116.33	-52.07	-43.49	-7.13	-1.45	-13.00	-39.07
165.80	-58.82	-50.56	-6.55	-1.71	-13.00	-45.82
193.93	-59.57	-55.04	-2.58	-1.95	-13.00	-46.57
773.02	-62.27	-56.32	-1.57	-4.38	-13.00	-49.27
1658.00	-51.12	-52.92	9.38	-7.58	-13.00	-38.12
3425.00	-44.56	-45.92	12.65	-11.29	-13.00	-31.56

Unless otherwise stated the results shown in this test report refer only to the sample(s) tested and such sample(s) are retained for 90 days only.

除非另有說明，此報告結果僅對測試之樣品負責，同時此樣品僅保留90天。本報告未經本公司書面許可，不可部份複製。

This document is issued by the Company subject to its General Conditions of Service printed overleaf, available on request or accessible at <http://www.sgs.com.tw/Terms-and-Conditions> and for electronic format documents, subject to Terms and Conditions for Electronic Documents at <http://www.sgs.com.tw/Terms-and-Conditions>. Attention is drawn to the limitation of liability, indemnification and jurisdiction issues defined therein. Any holder of this document is advised that information contained hereon reflects the Company's findings at the time of its intervention only and within the limits of Client's instructions, if any. The Company's sole responsibility is to its Client and this document does not exonerate parties to a transaction from exercising all their rights and obligations under the transaction documents. This document cannot be reproduced except in full, without prior written approval of the Company. Any unauthorized alteration, forgery or falsification of the content or appearance of this document is unlawful and offenders may be prosecuted to the fullest extent of the law.

Report Number :E2/2019/A0032
 Operation Mode :LTE B5+B66
 Test Mode :TX CH MID
 EUT Pol :E2 Plan
 Test Frequency :836.5 MHz + 1745 MHz

Test Date :2020-02-17
 Temp./Humi. :21.8/41
 Antenna Pol. :VERTICAL
 Engineer :Enzo

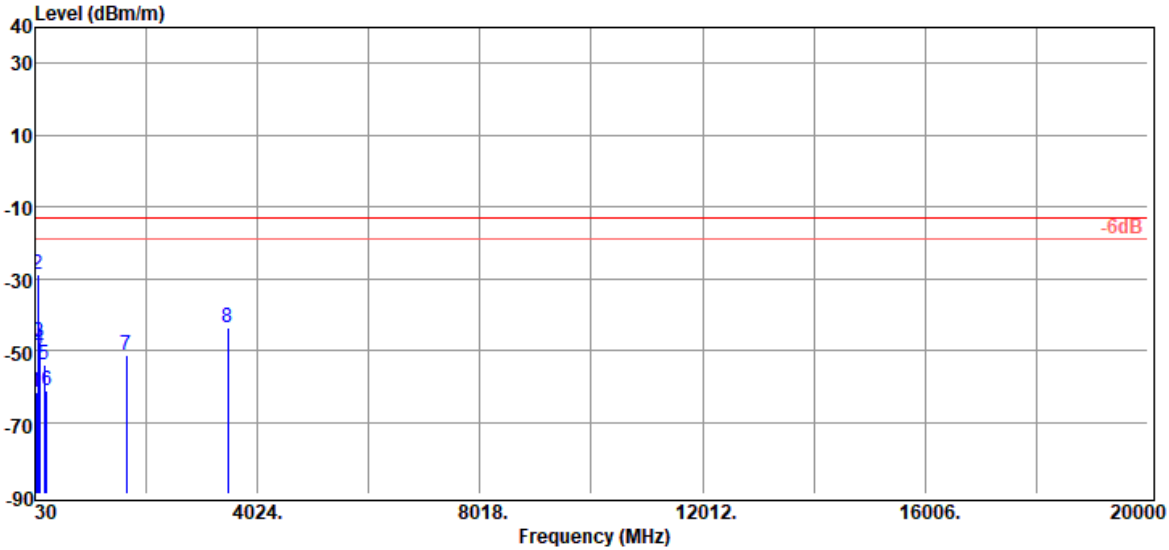

Freq. MHz	EIRP/ERP dBm	SG Output Level dBm	Antenna Gain dBi/dBd	Cable Loss dB	Limit dBm	Margin dB
55.22	-61.75	-44.34	-16.48	-0.93	-13.00	-48.75
80.44	-28.60	-19.20	-8.24	-1.16	-13.00	-15.60
106.63	-47.72	-39.40	-6.91	-1.41	-13.00	-34.72
116.33	-49.69	-41.11	-7.13	-1.45	-13.00	-36.69
201.69	-54.11	-49.98	-2.05	-2.08	-13.00	-41.11
235.64	-61.35	-57.40	-1.74	-2.21	-13.00	-48.35
1673.00	-51.20	-53.05	9.53	-7.68	-13.00	-38.20
3490.00	-43.56	-45.05	12.36	-10.87	-13.00	-30.56

Unless otherwise stated the results shown in this test report refer only to the sample(s) tested and such sample(s) are retained for 90 days only.

除非另有說明，此報告結果僅對測試之樣品負責，同時此樣品僅保留90天。本報告未經本公司書面許可，不可部份複製。

This document is issued by the Company subject to its General Conditions of Service printed overleaf, available on request or accessible at <http://www.sgs.com.tw/Terms-and-Conditions> and for electronic format documents, subject to Terms and Conditions for Electronic Documents at <http://www.sgs.com.tw/Terms-and-Conditions>. Attention is drawn to the limitation of liability, indemnification and jurisdiction issues defined therein. Any holder of this document is advised that information contained hereon reflects the Company's findings at the time of its intervention only and within the limits of Client's instructions, if any. The Company's sole responsibility is to its Client and this document does not exonerate parties to a transaction from exercising all their rights and obligations under the transaction documents. This document cannot be reproduced except in full, without prior written approval of the Company. Any unauthorized alteration, forgery or falsification of the content or appearance of this document is unlawful and offenders may be prosecuted to the fullest extent of the law.

Report Number :E2/2019/A0032
 Operation Mode :LTE B5+B66
 Test Mode :TX CH MID
 EUT Pol :E2 Plan
 Test Frequency :836.5 MHz + 1745 MHz

Test Date :2020-02-17
 Temp./Humi. :21.8/41
 Antenna Pol. :HORIZONTAL
 Engineer :Enzo

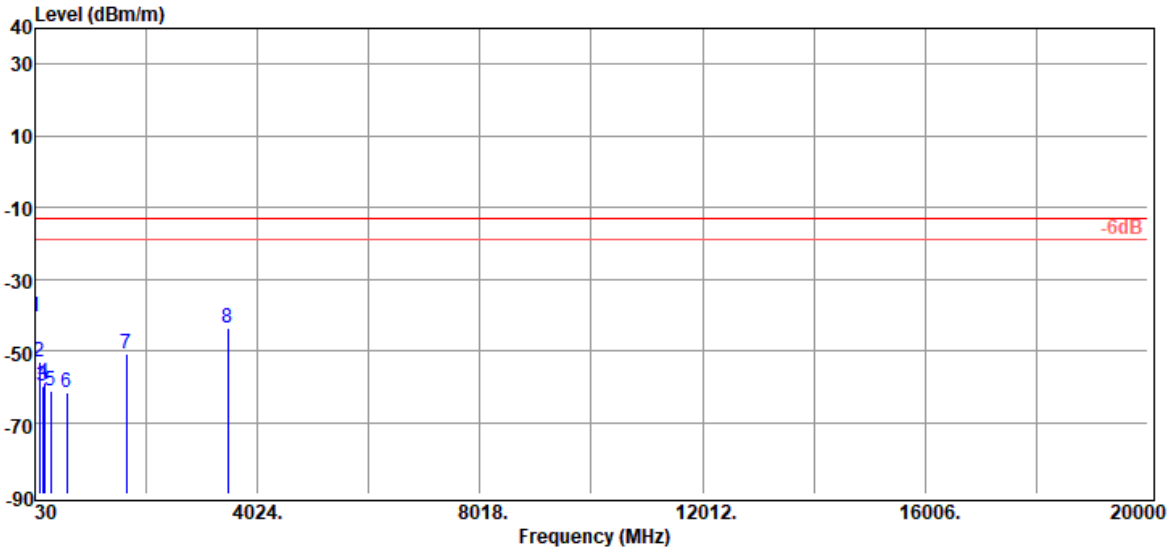

Freq. MHz	EIRP/ERP dBm	SG Output Level dBm	Antenna Gain dBi/dBd	Cable Loss dB	Limit dBm	Margin dB
32.91	-40.37	-19.60	-20.09	-0.68	-13.00	-27.37
116.33	-53.01	-44.43	-7.13	-1.45	-13.00	-40.01
166.77	-59.85	-51.63	-6.50	-1.72	-13.00	-46.85
194.90	-58.76	-54.34	-2.45	-1.97	-13.00	-45.76
305.48	-61.19	-57.09	-1.46	-2.64	-13.00	-48.19
604.24	-61.46	-55.70	-1.78	-3.98	-13.00	-48.46
1673.00	-50.98	-52.83	9.53	-7.68	-13.00	-37.98
3490.00	-43.77	-45.26	12.36	-10.87	-13.00	-30.77

Unless otherwise stated the results shown in this test report refer only to the sample(s) tested and such sample(s) are retained for 90 days only.

除非另有說明，此報告結果僅對測試之樣品負責，同時此樣品僅保留90天。本報告未經本公司書面許可，不可部份複製。

This document is issued by the Company subject to its General Conditions of Service printed overleaf, available on request or accessible at <http://www.sgs.com.tw/Terms-and-Conditions> and for electronic format documents, subject to Terms and Conditions for Electronic Documents at <http://www.sgs.com.tw/Terms-and-Conditions>. Attention is drawn to the limitation of liability, indemnification and jurisdiction issues defined therein. Any holder of this document is advised that information contained hereon reflects the Company's findings at the time of its intervention only and within the limits of Client's instructions, if any. The Company's sole responsibility is to its Client and this document does not exonerate parties to a transaction from exercising all their rights and obligations under the transaction documents. This document cannot be reproduced except in full, without prior written approval of the Company. Any unauthorized alteration, forgery or falsification of the content or appearance of this document is unlawful and offenders may be prosecuted to the fullest extent of the law.

Report Number	:E2/2019/A0032	Test Date	:2020-02-17
Operation Mode	:LTE B5+B66	Temp./Humi.	:21.8/41
Test Mode	:TX CH HIGH	Antenna Pol.	:VERTICAL
EUT Pol	:E2 Plan	Engineer	:Enzo
Test Frequency	:844 MHz + 1777.5 MHz		

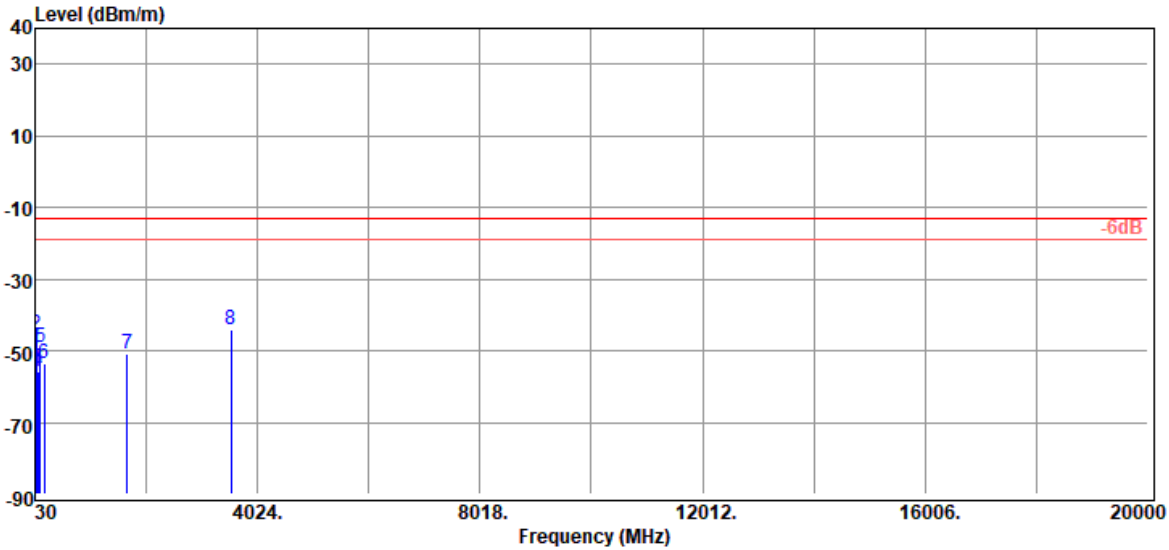

Freq. MHz	EIRP/ERP dBm	SG Output Level dBm	Antenna Gain dBi/dBd	Cable Loss dB	Limit dBm	Margin dB
33.88	-49.56	-29.01	-19.84	-0.71	-13.00	-36.56
54.25	-45.26	-27.61	-16.73	-0.92	-13.00	-32.26
69.77	-55.09	-41.98	-12.11	-1.00	-13.00	-42.09
82.38	-55.65	-46.81	-7.68	-1.16	-13.00	-42.65
119.24	-49.25	-40.76	-7.04	-1.45	-13.00	-36.25
202.66	-53.76	-49.68	-2.00	-2.08	-13.00	-40.76
1688.00	-51.09	-53.00	9.68	-7.77	-13.00	-38.09
3555.00	-43.98	-45.22	12.29	-11.05	-13.00	-30.98

Unless otherwise stated the results shown in this test report refer only to the sample(s) tested and such sample(s) are retained for 90 days only.

除非另有說明，此報告結果僅對測試之樣品負責，同時此樣品僅保留90天。本報告未經本公司書面許可，不可部份複製。

This document is issued by the Company subject to its General Conditions of Service printed overleaf, available on request or accessible at <http://www.sgs.com.tw/Terms-and-Conditions> and for electronic format documents, subject to Terms and Conditions for Electronic Documents at <http://www.sgs.com.tw/Terms-and-Conditions>. Attention is drawn to the limitation of liability, indemnification and jurisdiction issues defined therein. Any holder of this document is advised that information contained hereon reflects the Company's findings at the time of its intervention only and within the limits of Client's instructions, if any. The Company's sole responsibility is to its Client and this document does not exonerate parties to a transaction from exercising all their rights and obligations under the transaction documents. This document cannot be reproduced except in full, without prior written approval of the Company. Any unauthorized alteration, forgery or falsification of the content or appearance of this document is unlawful and offenders may be prosecuted to the fullest extent of the law.

Report Number :E2/2019/A0032
 Operation Mode :LTE B5+B66
 Test Mode :TX CH HIGH
 EUT Pol :E2 Plan
 Test Frequency :844 MHz + 1777.5 MHz

Test Date :2020-02-17
 Temp./Humi. :21.8/41
 Antenna Pol. :HORIZONTAL
 Engineer :Enzo

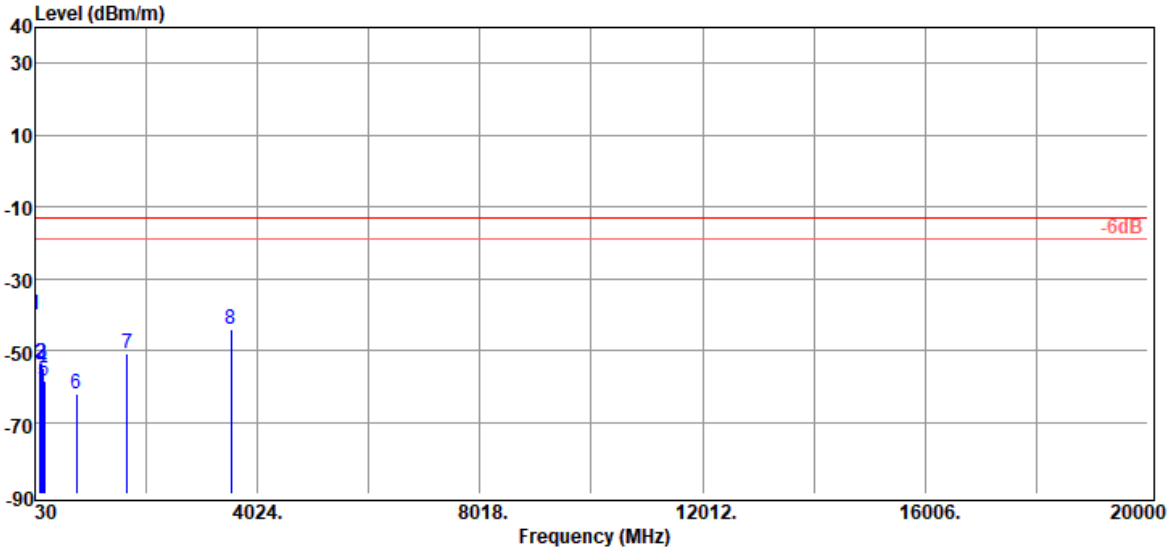

Freq. MHz	EIRP/ERP dBm	SG Output Level dBm	Antenna Gain dBi/dBd	Cable Loss dB	Limit dBm	Margin dB
32.91	-40.02	-19.25	-20.09	-0.68	-13.00	-27.02
118.27	-53.54	-45.01	-7.08	-1.45	-13.00	-40.54
147.37	-53.42	-44.18	-7.57	-1.67	-13.00	-40.42
164.83	-54.93	-46.62	-6.60	-1.71	-13.00	-41.93
196.84	-58.30	-53.93	-2.36	-2.01	-13.00	-45.30
772.05	-61.90	-55.96	-1.59	-4.35	-13.00	-48.90
1688.00	-50.77	-52.68	9.68	-7.77	-13.00	-37.77
3555.00	-44.16	-45.40	12.29	-11.05	-13.00	-31.16

Unless otherwise stated the results shown in this test report refer only to the sample(s) tested and such sample(s) are retained for 90 days only.

除非另有說明，此報告結果僅對測試之樣品負責，同時此樣品僅保留90天。本報告未經本公司書面許可，不可部份複製。

This document is issued by the Company subject to its General Conditions of Service printed overleaf, available on request or accessible at <http://www.sgs.com.tw/Terms-and-Conditions> and for electronic format documents, subject to Terms and Conditions for Electronic Documents at <http://www.sgs.com.tw/Terms-and-Conditions>. Attention is drawn to the limitation of liability, indemnification and jurisdiction issues defined therein. Any holder of this document is advised that information contained hereon reflects the Company's findings at the time of its intervention only and within the limits of Client's instructions, if any. The Company's sole responsibility is to its Client and this document does not exonerate parties to a transaction from exercising all their rights and obligations under the transaction documents. This document cannot be reproduced except in full, without prior written approval of the Company. Any unauthorized alteration, forgery or falsification of the content or appearance of this document is unlawful and offenders may be prosecuted to the fullest extent of the law.

Radiated Spurious Emission Measurement Result: LTE Band 12 + LTE Band 66 Mode

Report Number	:E2/2019/A0032	Test Date	:2020-02-17
Operation Mode	:LTE B12+B66	Temp./Humi.	:21.8/41
Test Mode	:TX CH LOW	Antenna Pol.	:VERTICAL
EUT Pol	:E2 Plan	Engineer	:Enzo
Test Frequency	:701.5 MHz + 1720 MHz		

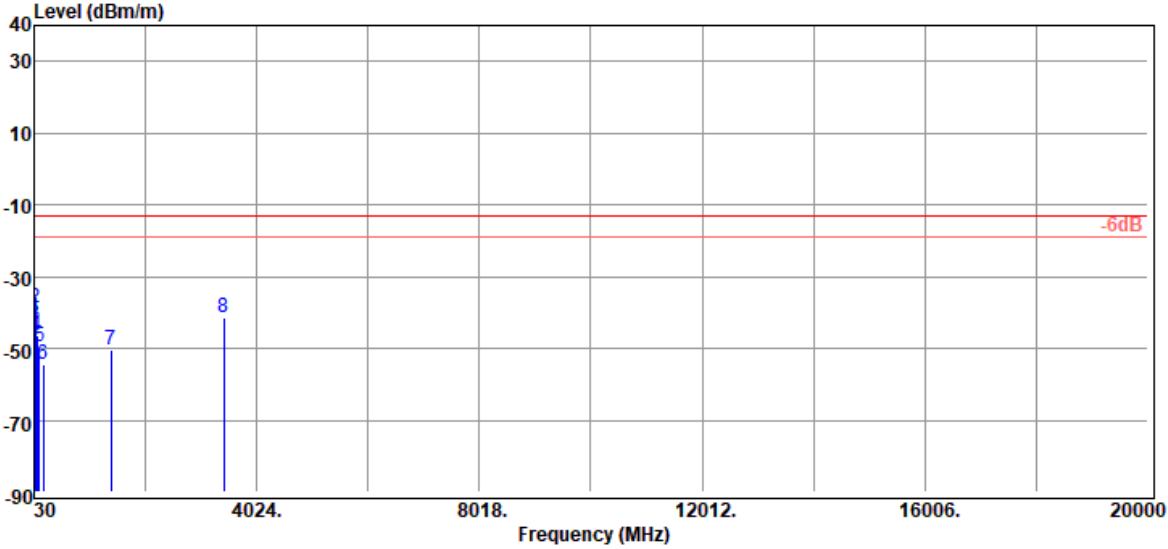

Freq. MHz	EIRP/ERP dBm	SG Output Level dBm	Antenna Gain dBi/dBd	Cable Loss dB	Limit dBm	Margin dB
37.76	-41.43	-21.28	-19.35	-0.80	-13.00	-28.43
44.55	-38.67	-19.30	-18.51	-0.86	-13.00	-25.67
51.34	-43.35	-25.14	-17.33	-0.88	-13.00	-30.35
86.26	-46.46	-38.63	-6.67	-1.16	-13.00	-33.46
117.30	-49.48	-40.94	-7.09	-1.45	-13.00	-36.48
202.66	-54.64	-50.56	-2.00	-2.08	-13.00	-41.64
1403.00	-50.24	-50.73	7.02	-6.53	-13.00	-37.24
3440.00	-41.41	-42.84	12.62	-11.19	-13.00	-28.41

Unless otherwise stated the results shown in this test report refer only to the sample(s) tested and such sample(s) are retained for 90 days only.

除非另有說明，此報告結果僅對測試之樣品負責，同時此樣品僅保留90天。本報告未經本公司書面許可，不可部份複製。

This document is issued by the Company subject to its General Conditions of Service printed overleaf, available on request or accessible at <http://www.sgs.com.tw/Terms-and-Conditions> and for electronic format documents, subject to Terms and Conditions for Electronic Documents at <http://www.sgs.com.tw/Terms-and-Conditions>. Attention is drawn to the limitation of liability, indemnification and jurisdiction issues defined therein. Any holder of this document is advised that information contained hereon reflects the Company's findings at the time of its intervention only and within the limits of Client's instructions, if any. The Company's sole responsibility is to its Client and this document does not exonerate parties to a transaction from exercising all their rights and obligations under the transaction documents. This document cannot be reproduced except in full, without prior written approval of the Company. Any unauthorized alteration, forgery or falsification of the content or appearance of this document is unlawful and offenders may be prosecuted to the fullest extent of the law.

Report Number :E2/2019/A0032
 Operation Mode :LTE B12+B66
 Test Mode :TX CH LOW
 EUT Pol :E2 Plan
 Test Frequency :701.5 MHz + 1720 MHz

Test Date :2020-02-17
 Temp./Humi. :21.8/41
 Antenna Pol. :HORIZONTAL
 Engineer :Enzo

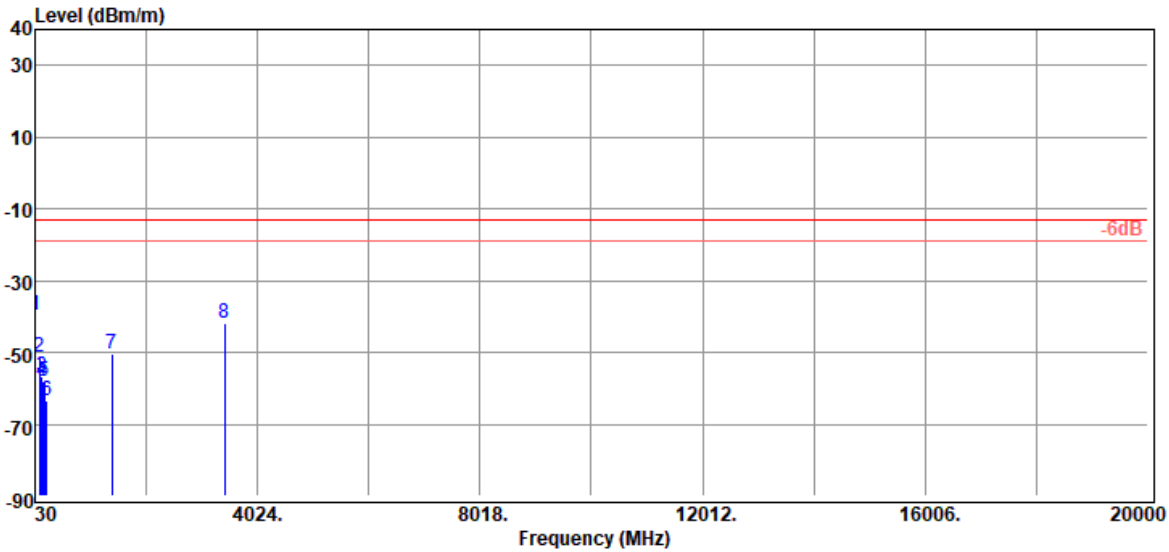

Freq. MHz	EIRP/ERP dBm	SG Output Level dBm	Antenna Gain dBi/dBd	Cable Loss dB	Limit dBm	Margin dB
34.85	-39.72	-19.22	-19.77	-0.73	-13.00	-26.72
116.33	-51.49	-42.91	-7.13	-1.45	-13.00	-38.49
151.25	-56.73	-47.70	-7.35	-1.68	-13.00	-43.73
162.89	-58.16	-49.65	-6.81	-1.70	-13.00	-45.16
191.02	-57.99	-53.28	-2.82	-1.89	-13.00	-44.99
240.49	-63.60	-59.54	-1.83	-2.23	-13.00	-50.60
1403.00	-50.29	-50.78	7.02	-6.53	-13.00	-37.29
3440.00	-41.68	-43.11	12.62	-11.19	-13.00	-28.68

Unless otherwise stated the results shown in this test report refer only to the sample(s) tested and such sample(s) are retained for 90 days only.

除非另有說明，此報告結果僅對測試之樣品負責，同時此樣品僅保留90天。本報告未經本公司書面許可，不可部份複製。

This document is issued by the Company subject to its General Conditions of Service printed overleaf, available on request or accessible at <http://www.sgs.com.tw/Terms-and-Conditions> and for electronic format documents, subject to Terms and Conditions for Electronic Documents at <http://www.sgs.com.tw/Terms-and-Conditions>. Attention is drawn to the limitation of liability, indemnification and jurisdiction issues defined therein. Any holder of this document is advised that information contained hereon reflects the Company's findings at the time of its intervention only and within the limits of Client's instructions, if any. The Company's sole responsibility is to its Client and this document does not exonerate parties to a transaction from exercising all their rights and obligations under the transaction documents. This document cannot be reproduced except in full, without prior written approval of the Company. Any unauthorized alteration, forgery or falsification of the content or appearance of this document is unlawful and offenders may be prosecuted to the fullest extent of the law.

Report Number	:E2/2019/A0032	Test Date	:2020-02-17
Operation Mode	:LTE B12+B66	Temp./Humi.	:21.8/41
Test Mode	:TX CH MID	Antenna Pol.	:VERTICAL
EUT Pol	:E2 Plan	Engineer	:Enzo
Test Frequency	:707.5 MHz + 1745 MHz		

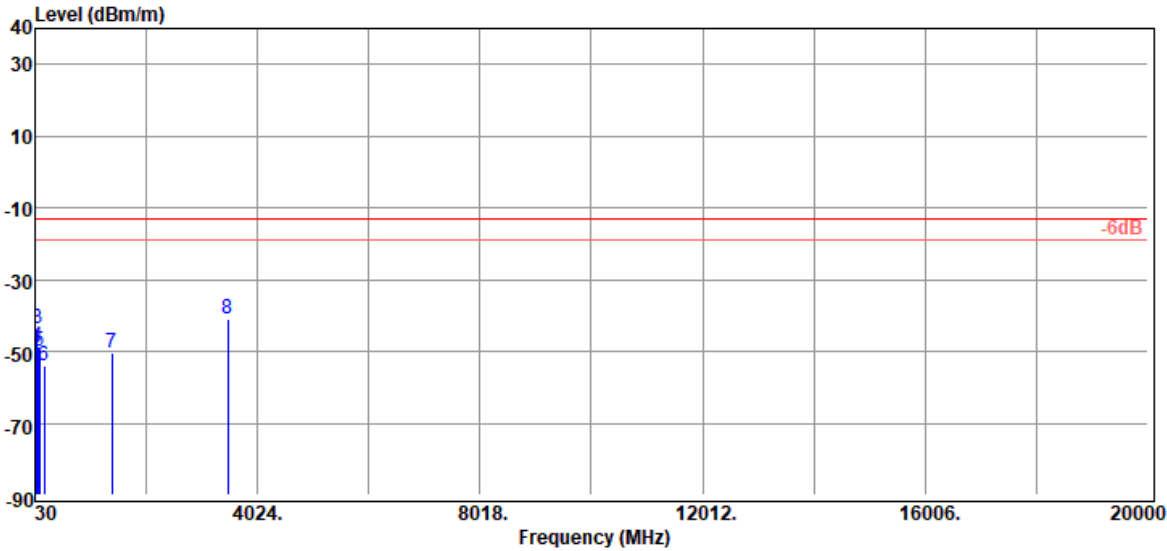

Freq. MHz	EIRP/ERP dBm	SG Output Level dBm	Antenna Gain dBi/dBd	Cable Loss dB	Limit dBm	Margin dB
32.91	-53.34	-32.57	-20.09	-0.68	-13.00	-40.34
44.55	-50.72	-31.35	-18.51	-0.86	-13.00	-37.72
67.83	-43.88	-30.05	-12.83	-1.00	-13.00	-30.88
83.35	-48.76	-40.15	-7.45	-1.16	-13.00	-35.76
115.36	-50.15	-41.56	-7.14	-1.45	-13.00	-37.15
201.69	-53.80	-49.67	-2.05	-2.08	-13.00	-40.80
1415.00	-50.29	-50.86	7.12	-6.55	-13.00	-37.29
3490.00	-41.07	-42.56	12.36	-10.87	-13.00	-28.07

Unless otherwise stated the results shown in this test report refer only to the sample(s) tested and such sample(s) are retained for 90 days only.

除非另有說明，此報告結果僅對測試之樣品負責，同時此樣品僅保留90天。本報告未經本公司書面許可，不可部份複製。

This document is issued by the Company subject to its General Conditions of Service printed overleaf, available on request or accessible at <http://www.sgs.com.tw/Terms-and-Conditions> and for electronic format documents, subject to Terms and Conditions for Electronic Documents at <http://www.sgs.com.tw/Terms-and-Conditions>. Attention is drawn to the limitation of liability, indemnification and jurisdiction issues defined therein. Any holder of this document is advised that information contained hereon reflects the Company's findings at the time of its intervention only and within the limits of Client's instructions, if any. The Company's sole responsibility is to its Client and this document does not exonerate parties to a transaction from exercising all their rights and obligations under the transaction documents. This document cannot be reproduced except in full, without prior written approval of the Company. Any unauthorized alteration, forgery or falsification of the content or appearance of this document is unlawful and offenders may be prosecuted to the fullest extent of the law.

Report Number :E2/2019/A0032
 Operation Mode :LTE B12+B66
 Test Mode :TX CH MID
 EUT Pol :E2 Plan
 Test Frequency :707.5 MHz + 1745 MHz

Test Date :2020-02-17
 Temp./Humi. :21.8/41
 Antenna Pol. :HORIZONTAL
 Engineer :Enzo

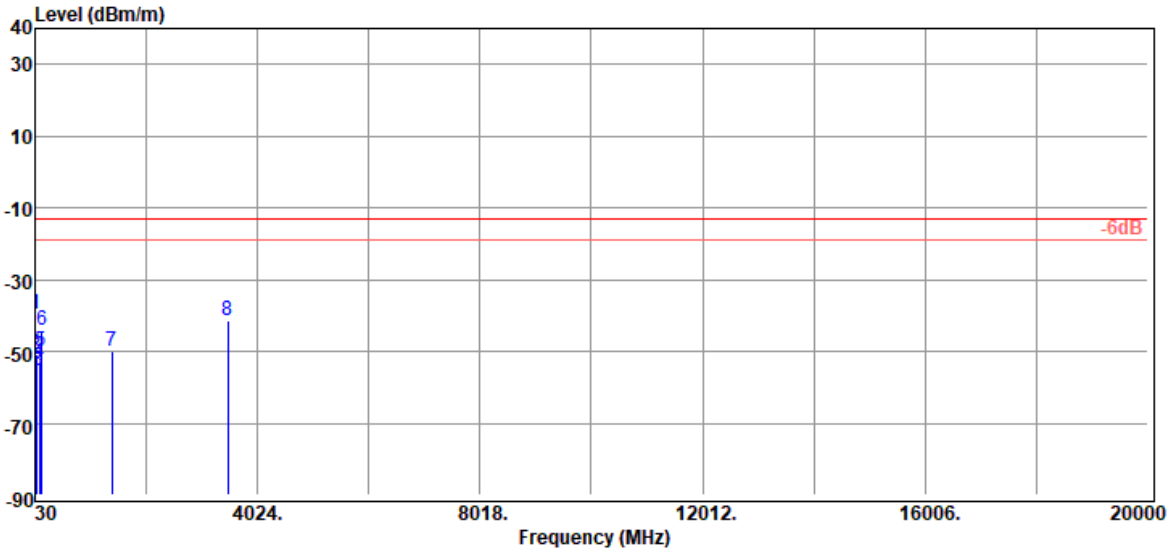

Freq. MHz	EIRP/ERP dBm	SG Output Level dBm	Antenna Gain dBi/dBd	Cable Loss dB	Limit dBm	Margin dB
35.82	-39.74	-19.34	-19.64	-0.76	-13.00	-26.74
57.16	-50.78	-33.76	-16.06	-0.96	-13.00	-37.78
68.80	-55.23	-41.78	-12.45	-1.00	-13.00	-42.23
116.33	-53.31	-44.73	-7.13	-1.45	-13.00	-40.31
138.64	-50.18	-40.85	-7.67	-1.66	-13.00	-37.18
152.22	-44.19	-35.22	-7.29	-1.68	-13.00	-31.19
1415.00	-50.12	-50.69	7.12	-6.55	-13.00	-37.12
3490.00	-41.26	-42.75	12.36	-10.87	-13.00	-28.26

Unless otherwise stated the results shown in this test report refer only to the sample(s) tested and such sample(s) are retained for 90 days only.

除非另有說明，此報告結果僅對測試之樣品負責，同時此樣品僅保留90天。本報告未經本公司書面許可，不可部份複製。

This document is issued by the Company subject to its General Conditions of Service printed overleaf, available on request or accessible at <http://www.sgs.com.tw/Terms-and-Conditions> and for electronic format documents, subject to Terms and Conditions for Electronic Documents at <http://www.sgs.com.tw/Terms-and-Conditions>. Attention is drawn to the limitation of liability, indemnification and jurisdiction issues defined therein. Any holder of this document is advised that information contained hereon reflects the Company's findings at the time of its intervention only and within the limits of Client's instructions, if any. The Company's sole responsibility is to its Client and this document does not exonerate parties to a transaction from exercising all their rights and obligations under the transaction documents. This document cannot be reproduced except in full, without prior written approval of the Company. Any unauthorized alteration, forgery or falsification of the content or appearance of this document is unlawful and offenders may be prosecuted to the fullest extent of the law.

Report Number :E2/2019/A0032
 Operation Mode :LTE B12+B66
 Test Mode :TX CH HIGH
 EUT Pol :E2 Plan
 Test Frequency :713.5 MHz + 1770 MHz

Test Date :2020-02-17
 Temp./Humi. :21.8/41
 Antenna Pol. :VERTICAL
 Engineer :Enzo

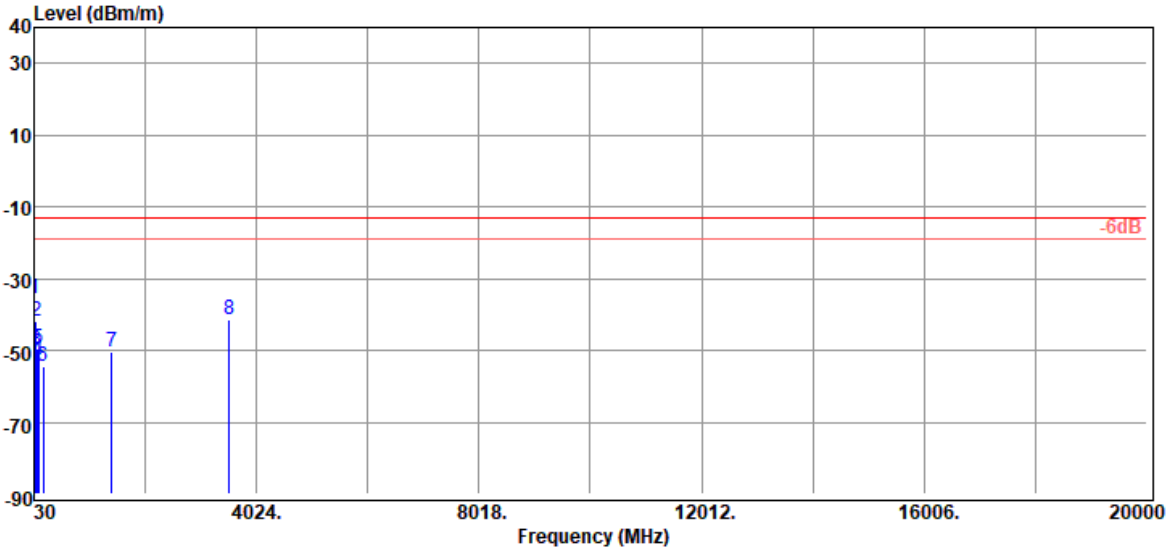

Freq. MHz	EIRP/ERP dBm	SG Output Level dBm	Antenna Gain dBi/dBd	Cable Loss dB	Limit dBm	Margin dB
37.76	-35.68	-15.53	-19.35	-0.80	-13.00	-22.68
64.92	-41.88	-27.17	-13.71	-1.00	-13.00	-28.88
81.41	-50.08	-40.98	-7.94	-1.16	-13.00	-37.08
104.69	-52.50	-44.33	-6.78	-1.39	-13.00	-39.50
116.33	-49.50	-40.92	-7.13	-1.45	-13.00	-36.50
202.66	-54.64	-50.56	-2.00	-2.08	-13.00	-41.64
1427.00	-50.19	-50.84	7.22	-6.57	-13.00	-37.19
3540.00	-41.20	-42.51	12.30	-10.99	-13.00	-28.20

Unless otherwise stated the results shown in this test report refer only to the sample(s) tested and such sample(s) are retained for 90 days only.

除非另有說明，此報告結果僅對測試之樣品負責，同時此樣品僅保留90天。本報告未經本公司書面許可，不可部份複製。

This document is issued by the Company subject to its General Conditions of Service printed overleaf, available on request or accessible at <http://www.sgs.com.tw/Terms-and-Conditions> and for electronic format documents, subject to Terms and Conditions for Electronic Documents at <http://www.sgs.com.tw/Terms-and-Conditions>. Attention is drawn to the limitation of liability, indemnification and jurisdiction issues defined therein. Any holder of this document is advised that information contained hereon reflects the Company's findings at the time of its intervention only and within the limits of Client's instructions, if any. The Company's sole responsibility is to its Client and this document does not exonerate parties to a transaction from exercising all their rights and obligations under the transaction documents. This document cannot be reproduced except in full, without prior written approval of the Company. Any unauthorized alteration, forgery or falsification of the content or appearance of this document is unlawful and offenders may be prosecuted to the fullest extent of the law.

Report Number	:E2/2019/A0032	Test Date	:2020-02-17
Operation Mode	:LTE B12+B66	Temp./Humi.	:21.8/41
Test Mode	:TX CH HIGH	Antenna Pol.	:HORIZONTAL
EUT Pol	:E2 Plan	Engineer	:Enzo
Test Frequency	:713.5 MHz + 1770 MHz		

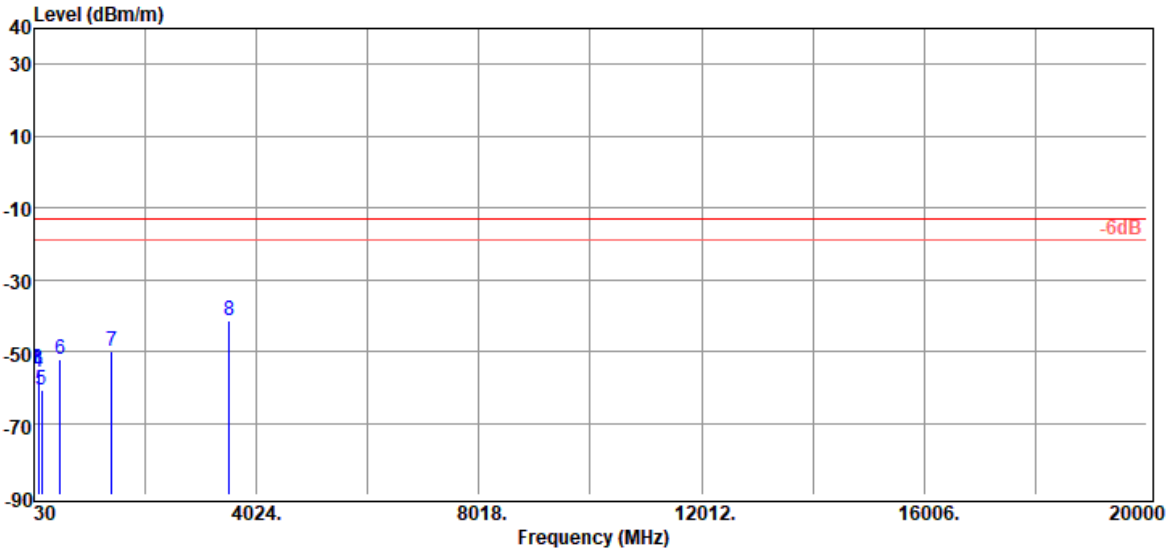

Freq. MHz	EIRP/ERP dBm	SG Output Level dBm	Antenna Gain dBi/dBd	Cable Loss dB	Limit dBm	Margin dB
33.88	-54.81	-34.26	-19.84	-0.71	-13.00	-41.81
37.76	-54.88	-34.73	-19.35	-0.80	-13.00	-41.88
103.72	-55.11	-47.10	-6.64	-1.37	-13.00	-42.11
111.48	-55.60	-47.06	-7.09	-1.45	-13.00	-42.60
163.86	-60.70	-52.34	-6.66	-1.70	-13.00	-47.70
496.57	-52.17	-47.60	-1.08	-3.49	-13.00	-39.17
1427.00	-50.02	-50.67	7.22	-6.57	-13.00	-37.02
3540.00	-41.45	-42.76	12.30	-10.99	-13.00	-28.45

Unless otherwise stated the results shown in this test report refer only to the sample(s) tested and such sample(s) are retained for 90 days only.

除非另有說明，此報告結果僅對測試之樣品負責，同時此樣品僅保留90天。本報告未經本公司書面許可，不可部份複製。

This document is issued by the Company subject to its General Conditions of Service printed overleaf, available on request or accessible at <http://www.sgs.com.tw/Terms-and-Conditions> and for electronic format documents, subject to Terms and Conditions for Electronic Documents at <http://www.sgs.com.tw/Terms-and-Conditions>. Attention is drawn to the limitation of liability, indemnification and jurisdiction issues defined therein. Any holder of this document is advised that information contained hereon reflects the Company's findings at the time of its intervention only and within the limits of Client's instructions, if any. The Company's sole responsibility is to its Client and this document does not exonerate parties to a transaction from exercising all their rights and obligations under the transaction documents. This document cannot be reproduced except in full, without prior written approval of the Company. Any unauthorized alteration, forgery or falsification of the content or appearance of this document is unlawful and offenders may be prosecuted to the fullest extent of the law.

10 FREQUENCY STABILITY MEASUREMENT

10.1 Standard Applicabl

The frequency stability shall be sufficient to ensure that the fundamental emission stays within the authorized frequency block.

10.2 Test Set-up

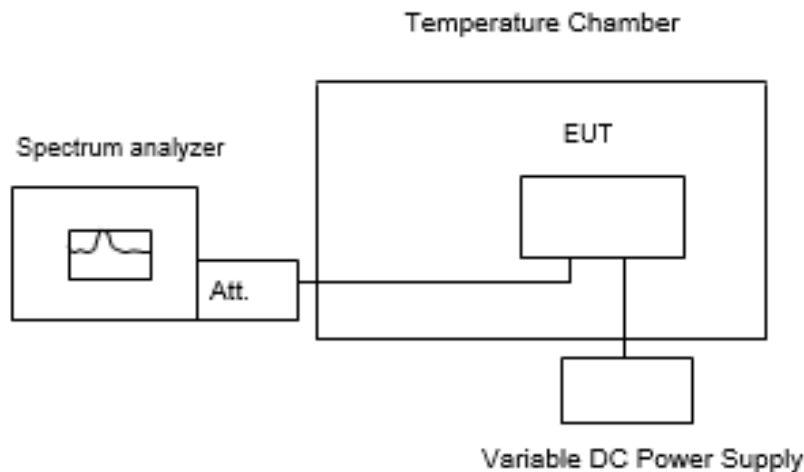

Note: Measurement setup for testing on Antenna connector

10.3 Measurement Procedure

The equipment under test was connected to an external AC or DC power supply and input rated voltage. RF output was connected to a frequency counter or spectrum analyzer via feed through attenuators. The EUT was placed inside the temperature chamber. Set the spectrum analyzer RBW low enough to obtain the desired frequency resolution and measure EUT 25°C operating frequency as reference frequency. Turn EUT off and set the chamber temperature to -30°C. After the temperature stabilized for approximately 30 minutes recorded the frequency. Repeat step measure with 10°C increased per stage until the highest temperature of +50°C reached.

Set chamber temperature to 25°C. Use a variable AC power supply / DC power source to power the EUT and set the voltage to rated voltage. Set the spectrum analyzer RBW low enough to obtain the desired frequency resolution and recorded the frequency.

Reduce the input voltage to specify extreme voltage variation (+/- 15%) and endpoint as declared by the manufacturer, record the maximum frequency change.

Unless otherwise stated the results shown in this test report refer only to the sample(s) tested and such sample(s) are retained for 90 days only.

除非另有說明，此報告結果僅對測試之樣品負責，同時此樣品僅保留90天。本報告未經本公司書面許可，不可部份複製。

This document is issued by the Company subject to its General Conditions of Service printed overleaf, available on request or accessible at <http://www.sgs.com.tw/Terms-and-Conditions> and for electronic format documents, subject to Terms and Conditions for Electronic Documents at <http://www.sgs.com.tw/Terms-and-Conditions>. Attention is drawn to the limitation of liability, indemnification and jurisdiction issues defined therein. Any holder of this document is advised that information contained hereon reflects the Company's findings at the time of its intervention only and within the limits of Client's instructions, if any. The Company's sole responsibility is to its Client and this document does not exonerate parties to a transaction from exercising all their rights and obligations under the transaction documents. This document cannot be reproduced except in full, without prior written approval of the Company. Any unauthorized alteration, forgery or falsification of the content or appearance of this document is unlawful and offenders may be prosecuted to the fullest extent of the law.

10.4 Measurement Equipment Used

Conducted Emission (measured at antenna port) Test Site					
EQUIPMENT TYPE	MFR	MODEL NUMBER	SERIAL NUMBER	LAST CAL.	CAL DUE.
Spectrum Analyzer	KEYSIGHT	N9010A	MY51440113	07/15/2019	07/14/2020
Radio Communication Analyser	Anritsu	MT8821C	6261786084	01/18/2020	01/17/2021
Attenuator	Marvelous	MVE2213-10	RF30	11/20/2019	11/19/2020
DC Block	PASTERNAK	PE8210	RF32	11/20/2019	11/19/2020
Splitter	Woken	DOM35LW1 A2	RF83	11/20/2019	11/19/2020
Coaxial Cables	Woken	00100A1F1A 185C	RF229	11/20/2019	11/19/2020

10.5 Measurement Result

Note: The battery is rated 3.3V dc.

Reference Freq.: LTE B5B Mid Channel 834 MHz 10M QPSK CH 20500				
Power Supply Vdc	Temp. (°C)	Freq. (MHz)	Delta (Hz)	Limit = +/- 2.5 ppm (Hz)
Freq. ERROR vs. VOLTAGE				
3.465	25	834.000012	12	2091
3.3	25	834.000015	15	2091
3.135	25	834.000020	20	2091
2.9 (End Point)	25	834.000017	17	2091
Freq. ERROR vs. Temp.				
3.3	-30	833.999997	-3	2091
3.3	-20	833.999993	-7	2091
3.3	-10	833.999989	-11	2091
3.3	0	833.999980	-20	2091
3.3	10	834.000008	8	2091
3.3	20	833.999994	-6	2091
3.3	30	833.999986	-14	2091
3.3	40	833.999994	-6	2091
3.3	50	833.999996	-4	2091

Unless otherwise stated the results shown in this test report refer only to the sample(s) tested and such sample(s) are retained for 90 days only.

除非另有說明，此報告結果僅對測試之樣品負責，同時此樣品僅保留90天。本報告未經本公司書面許可，不可部份複製。

This document is issued by the Company subject to its General Conditions of Service printed overleaf, available on request or accessible at <http://www.sgs.com.tw/Terms-and-Conditions>, and for electronic format documents, subject to Terms and Conditions for Electronic Documents at <http://www.sgs.com.tw/Terms-and-Conditions>. Attention is drawn to the limitation of liability, indemnification and jurisdiction issues defined therein. Any holder of this document is advised that information contained hereon reflects the Company's findings at the time of its intervention only and within the limits of Client's instructions, if any. The Company's sole responsibility is to its Client and this document does not exonerate parties to a transaction from exercising all their rights and obligations under the transaction documents. This document cannot be reproduced except in full, without prior written approval of the Company. Any unauthorized alteration, forgery or falsification of the content or appearance of this document is unlawful and offenders may be prosecuted to the fullest extent of the law.

Reference Freq.: LTE B7C Mid Channel 2525.6 MHz 10M QPSK CH 21006				
Power Supply Vdc	Temp. (°C)	Freq. (MHz)	Delta (Hz)	Limit = +/- 2.5 ppm (Hz)
Freq. ERROR vs. VOLTAGE				
3.465	25	2525.600016	16	6338
3.3	25	2525.600014	14	6338
3.135	25	2525.600012	12	6338
2.9 (End Point)	25	2525.600006	6	6338
Freq. ERROR vs. Temp.				
3.3	-30	2525.600005	5	6338
3.3	-20	2525.599991	-9	6338
3.3	-10	2525.599986	-14	6338
3.3	0	2525.599981	-19	6338
3.3	10	2525.600005	5	6338
3.3	20	2525.599983	-17	6338
3.3	30	2525.599987	-13	6338
3.3	40	2525.599991	-9	6338
3.3	50	2525.599983	-17	6338
Reference Freq.: LTE B41C Mid Channel 2583.8 MHz 5M QPSK CH 40528				
Power Supply Vdc	Temp. (°C)	Freq. (MHz)	Delta (Hz)	Limit = +/- 2.5 ppm (Hz)
Freq. ERROR vs. VOLTAGE				
3.465	25	2583.800008	8	6488
3.3	25	2583.800019	19	6488
3.135	25	2583.800018	18	6488
2.9 (End Point)	25	2583.800013	13	6488
Freq. ERROR vs. Temp.				
3.3	-30	2583.799991	-9	6488
3.3	-20	2583.799986	-14	6488
3.3	-10	2583.799988	-12	6488
3.3	0	2583.799986	-14	6488
3.3	10	2583.800009	9	6488
3.3	20	2583.799985	-15	6488
3.3	30	2583.799981	-19	6488
3.3	40	2583.799995	-5	6488
3.3	50	2583.800008	8	6488

Unless otherwise stated the results shown in this test report refer only to the sample(s) tested and such sample(s) are retained for 90 days only.

除非另有說明，此報告結果僅對測試之樣品負責，同時此樣品僅保留90天。本報告未經本公司書面許可，不可部份複製。

This document is issued by the Company subject to its General Conditions of Service printed overleaf, available on request or accessible at <http://www.sgs.com.tw/Terms-and-Conditions> and for electronic format documents, subject to Terms and Conditions for Electronic Documents at <http://www.sgs.com.tw/Terms-and-Conditions>. Attention is drawn to the limitation of liability, indemnification and jurisdiction issues defined therein. Any holder of this document is advised that information contained hereon reflects the Company's findings at the time of its intervention only and within the limits of Client's instructions, if any. The Company's sole responsibility is to its Client and this document does not exonerate parties to a transaction from exercising all their rights and obligations under the transaction documents. This document cannot be reproduced except in full, without prior written approval of the Company. Any unauthorized alteration, forgery or falsification of the content or appearance of this document is unlawful and offenders may be prosecuted to the fullest extent of the law.

Reference Freq.: LTE B48C Mid Channel 3615.8 MHz 5M QPSK CH 55898				
Power Supply Vdc	Temp. (°C)	Freq. (MHz)	Delta (Hz)	Limit = +/- 2.5 ppm (Hz)
Freq. ERROR vs. VOLTAGE				
3.465	25	3615.800011	11	6488
3.3	25	3615.800015	15	6488
3.135	25	3615.800011	11	6488
2.9 (End Point)	25	3615.800008	8	6488
Freq. ERROR vs. Temp.				
3.3	-30	3615.799984	-16	6488
3.3	-20	3615.799989	-11	6488
3.3	-10	3615.799992	-8	6488
3.3	0	3615.800008	8	6488
3.3	10	3615.800009	9	6488
3.3	20	3615.800011	11	6488
3.3	30	3615.800015	15	6488
3.3	40	3615.800014	14	6488
3.3	50	3615.800011	11	6488
Reference Freq.: LTE B66B Mid Channel 1753 MHz 5M QPSK CH 132398				
Power Supply Vdc	Temp. (°C)	Freq. (MHz)	Delta (Hz)	Limit = +/- 2.5 ppm (Hz)
Freq. ERROR vs. VOLTAGE				
3.465	25	1752.600027	27	6488
3.3	25	1752.600016	16	6488
3.135	25	1752.600014	14	6488
2.9 (End Point)	25	1752.600016	16	6488
Freq. ERROR vs. Temp.				
3.3	-30	1752.599985	-15	6488
3.3	-20	1752.599981	-19	6488
3.3	-10	1752.599972	-28	6488
3.3	0	1752.599984	-16	6488
3.3	10	1752.600005	5	6488
3.3	20	1752.599986	-14	6488
3.3	30	1752.599989	-11	6488
3.3	40	1752.599991	-9	6488
3.3	50	1752.600005	5	6488

Unless otherwise stated the results shown in this test report refer only to the sample(s) tested and such sample(s) are retained for 90 days only.

除非另有說明，此報告結果僅對測試之樣品負責，同時此樣品僅保留90天。本報告未經本公司書面許可，不可部份複製。

This document is issued by the Company subject to its General Conditions of Service printed overleaf, available on request or accessible at <http://www.sgs.com.tw/Terms-and-Conditions> and for electronic format documents, subject to Terms and Conditions for Electronic Documents at <http://www.sgs.com.tw/Terms-and-Conditions>. Attention is drawn to the limitation of liability, indemnification and jurisdiction issues defined therein. Any holder of this document is advised that information contained hereon reflects the Company's findings at the time of its intervention only and within the limits of Client's instructions, if any. The Company's sole responsibility is to its Client and this document does not exonerate parties to a transaction from exercising all their rights and obligations under the transaction documents. This document cannot be reproduced except in full, without prior written approval of the Company. Any unauthorized alteration, forgery or falsification of the content or appearance of this document is unlawful and offenders may be prosecuted to the fullest extent of the law.

Reference Freq.: LTE B66C Mid Channel 1746 MHz 5M QPSK CH 132330				
Power Supply Vdc	Temp. (°C)	Freq. (MHz)	Delta (Hz)	Limit = +/- 2.5 ppm (Hz)
Freq. ERROR vs. VOLTAGE				
3.465	25	1745.800021	21	6488
3.3	25	1745.800014	14	6488
3.135	25	1745.800011	11	6488
2.9 (End Point)	25	1745.800011	11	6488
Freq. ERROR vs. Temp.				
3.3	-30	1745.799989	-11	6488
3.3	-20	1745.799983	-17	6488
3.3	-10	1745.799979	-21	6488
3.3	0	1745.799989	-11	6488
3.3	10	1745.800001	1	6488
3.3	20	1745.799989	-11	6488
3.3	30	1745.799993	-7	6488
3.3	40	1745.799996	-4	6488
3.3	50	1745.800006	6	6488

Unless otherwise stated the results shown in this test report refer only to the sample(s) tested and such sample(s) are retained for 90 days only.

除非另有說明，此報告結果僅對測試之樣品負責，同時此樣品僅保留90天。本報告未經本公司書面許可，不可部份複製。

This document is issued by the Company subject to its General Conditions of Service printed overleaf, available on request or accessible at <http://www.sgs.com.tw/Terms-and-Conditions> and for electronic format documents, subject to Terms and Conditions for Electronic Documents at <http://www.sgs.com.tw/Terms-and-Conditions>. Attention is drawn to the limitation of liability, indemnification and jurisdiction issues defined therein. Any holder of this document is advised that information contained hereon reflects the Company's findings at the time of its intervention only and within the limits of Client's instructions, if any. The Company's sole responsibility is to its Client and this document does not exonerate parties to a transaction from exercising all their rights and obligations under the transaction documents. This document cannot be reproduced except in full, without prior written approval of the Company. Any unauthorized alteration, forgery or falsification of the content or appearance of this document is unlawful and offenders may be prosecuted to the fullest extent of the law.

SGS Taiwan Ltd.

台灣檢驗科技股份有限公司

No.134,Wu Kung Road, New Taipei Industrial Park, Wuku District, New Taipei City, Taiwan/新北市五股區新北產業園區五工路 134 號

t (886-2) 2299-3279

f (886-2) 2298-0488

www.sgs.com.tw

Member of SGS Group

11 PEAK TO AVERAGE RATIO

11.1 Standard Applicable

The peak-to-average ratio (PAR) of the transmission may not exceed 13dB.

11.2 Test SET-UP

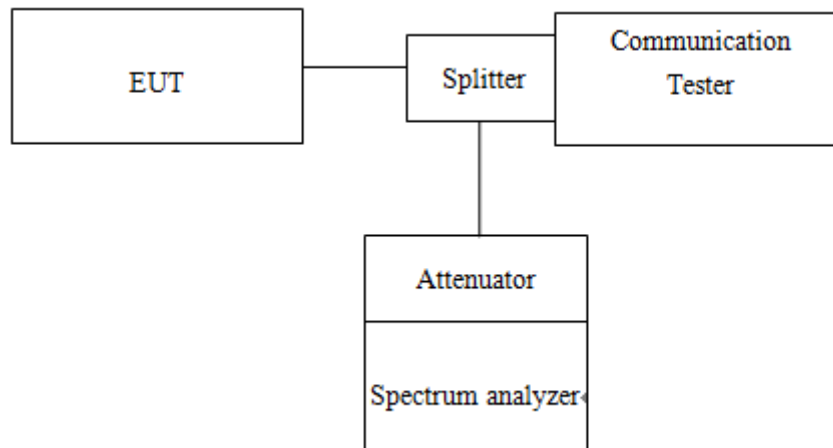

11.3 Measurement Procedure

1. KDB 971168 D01 is employed as the following procedure is proper adjusted accordingly:
2. Set resolution/measurement bandwidth \geq signal's occupied bandwidth; & internal = 1ms
3. Set the number of counts to a value that stabilizes the measured CCDF curve.

Unless otherwise stated the results shown in this test report refer only to the sample(s) tested and such sample(s) are retained for 90 days only.

除非另有說明，此報告結果僅對測試之樣品負責，同時此樣品僅保留90天。本報告未經本公司書面許可，不可部份複製。

This document is issued by the Company subject to its General Conditions of Service printed overleaf, available on request or accessible at <http://www.sgs.com.tw/Terms-and-Conditions> and for electronic format documents, subject to Terms and Conditions for Electronic Documents at <http://www.sgs.com.tw/Terms-and-Conditions>. Attention is drawn to the limitation of liability, indemnification and jurisdiction issues defined therein. Any holder of this document is advised that information contained hereon reflects the Company's findings at the time of its intervention only and within the limits of Client's instructions, if any. The Company's sole responsibility is to its Client and this document does not exonerate parties to a transaction from exercising all their rights and obligations under the transaction documents. This document cannot be reproduced except in full, without prior written approval of the Company. Any unauthorized alteration, forgery or falsification of the content or appearance of this document is unlawful and offenders may be prosecuted to the fullest extent of the law.

SGS Taiwan Ltd.

台灣檢驗科技股份有限公司

No.134, Wu Kung Road, New Taipei Industrial Park, Wuku District, New Taipei City, Taiwan/ 新北市五股區新北產業園區五工路 134 號

t (886-2) 2299-3279

f (886-2) 2298-0488

www.sgs.com.tw

Member of SGS Group

11.4 Measurement Equipment Used

Conducted Emission (measured at antenna port) Test Site					
EQUIPMENT TYPE	MFR	MODEL NUMBER	SERIAL NUMBER	LAST CAL.	CAL DUE.
Spectrum Analyzer	KEYSIGHT	N9010A	MY51440113	07/15/2019	07/14/2020
Radio Communication Analyser	Anritsu	MT8821C	6261786084	01/18/2020	01/17/2021
Attenuator	Marvelous	MVE2213-10	RF30	11/20/2019	11/19/2020
DC Block	PASTERNAK	PE8210	RF32	11/20/2019	11/19/2020
Splitter	Woken	DOM35LW1A2	RF83	11/20/2019	11/19/2020
Coaxial Cables	Woken	00100A1F1A18 5C	RF229	11/20/2019	11/19/2020

Unless otherwise stated the results shown in this test report refer only to the sample(s) tested and such sample(s) are retained for 90 days only.

除非另有說明，此報告結果僅對測試之樣品負責，同時此樣品僅保留90天。本報告未經本公司書面許可，不可部份複製。

This document is issued by the Company subject to its General Conditions of Service printed overleaf, available on request or accessible at <http://www.sgs.com.tw/Terms-and-Conditions> and for electronic format documents, subject to Terms and Conditions for Electronic Documents at <http://www.sgs.com.tw/Terms-and-Conditions>. Attention is drawn to the limitation of liability, indemnification and jurisdiction issues defined therein. Any holder of this document is advised that information contained hereon reflects the Company's findings at the time of its intervention only and within the limits of Client's instructions, if any. The Company's sole responsibility is to its Client and this document does not exonerate parties to a transaction from exercising all their rights and obligations under the transaction documents. This document cannot be reproduced except in full, without prior written approval of the Company. Any unauthorized alteration, forgery or falsification of the content or appearance of this document is unlawful and offenders may be prosecuted to the fullest extent of the law.

SGS Taiwan Ltd.

台灣檢驗科技股份有限公司

No.134,Wu Kung Road, New Taipei Industrial Park, Wuku District, New Taipei City, Taiwan/新北市五股區新北產業園區五工路 134 號

t (886-2) 2299-3279

f (886-2) 2298-0488

www.sgs.com.tw

Member of SGS Group

11.5 Measurement Result

	First Band		Freq. (MHz)	+	Second Band		Freq. (MHz)	PAPR	
	Band width	Channel			Band width	Channel		256QAM	Limit
5B	5 MHz	20428	826.8	+	10 MHz	20500	834	8.30	13
	5 MHz	20478	831.8		10 MHz	20550	839	7.87	13
	5 MHz	20528	836.8		10 MHz	20600	844	7.81	13
7C	20 MHz	20850	2510	+	20 MHz	21048	2529.8	8.09	13
	20 MHz	21001	2525.1		20 MHz	21199	2544.9	7.97	13
	20 MHz	21152	2540.2		20 MHz	21350	2560	7.85	13
41C	5 MHz	39683	2499.3	+	20 MHz	39800	2511	9.51	13
	5 MHz	40528	2583.8		20 MHz	40645	2595.5	9.75	13
	5 MHz	41373	2668.3		20 MHz	41490	2680	10.51	13
48C	5 MHz	55273	3553.3	+	20 MHz	55390	3565	11.08	13
	5 MHz	55898	3615.8		20 MHz	56015	3627.5	9.75	13
	5 MHz	56523	3678.3		20 MHz	56640	3690	10.41	13
66B	15 MHz	132047	1717.5	+	5 MHz	132140	1726.8	7.16	13
	15 MHz	132398	1752.6		5 MHz	132491	1761.9	7.08	13
	15 MHz	132549	1767.7		5 MHz	132642	1777	6.88	13
66C	20 MHz	132072	1720	+	5 MHz	132189	1731.7	7.69	13
	20 MHz	132397	1752.5		5 MHz	132514	1764.2	7.41	13
	20 MHz	132522	1765		5 MHz	132639	1776.7	7.17	13

Unless otherwise stated the results shown in this test report refer only to the sample(s) tested and such sample(s) are retained for 90 days only.

除非另有說明，此報告結果僅對測試之樣品負責，同時此樣品僅保留90天。本報告未經本公司書面許可，不可部份複製。

This document is issued by the Company subject to its General Conditions of Service printed overleaf, available on request or accessible at <http://www.sgs.com.tw/Terms-and-Conditions> and for electronic format documents, subject to Terms and Conditions for Electronic Documents at <http://www.sgs.com.tw/Terms-and-Conditions>. Attention is drawn to the limitation of liability, indemnification and jurisdiction issues defined therein. Any holder of this document is advised that information contained hereon reflects the Company's findings at the time of its intervention only and within the limits of Client's instructions, if any. The Company's sole responsibility is to its Client and this document does not exonerate parties to a transaction from exercising all their rights and obligations under the transaction documents. This document cannot be reproduced except in full, without prior written approval of the Company. Any unauthorized alteration, forgery or falsification of the content or appearance of this document is unlawful and offenders may be prosecuted to the fullest extent of the law.

256QAM_B5(826.8+834)

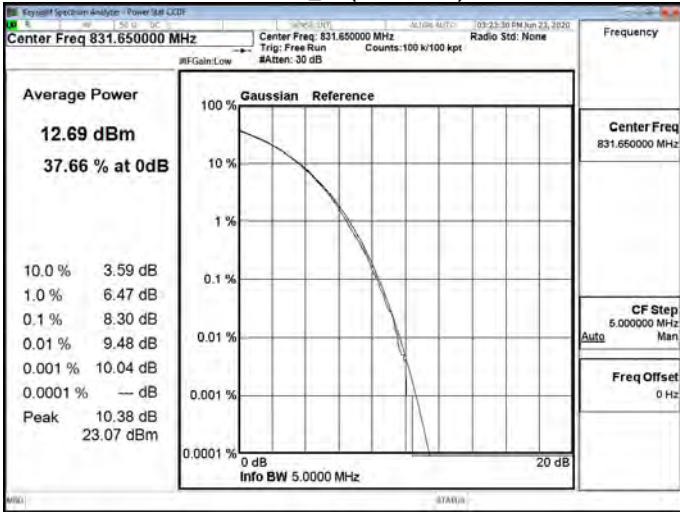

256QAM_B7(2510+2529.8)

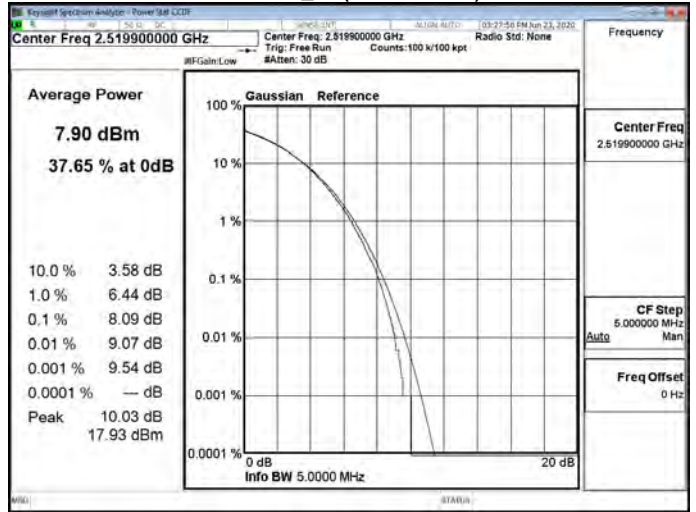

256QAM_B5(831.8+839)

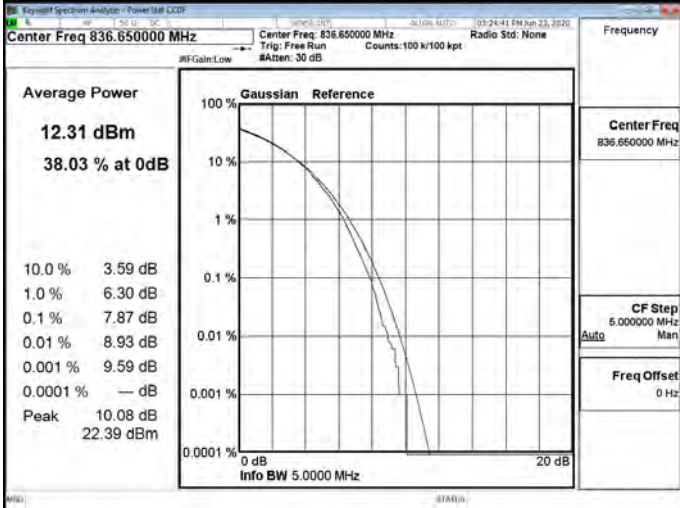

256QAM_B7(2525.1+2544.9)

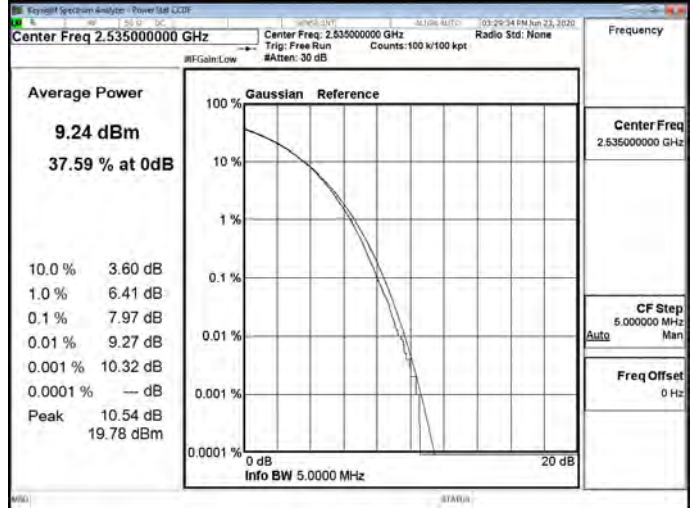

256QAM_B5(836.8+844)

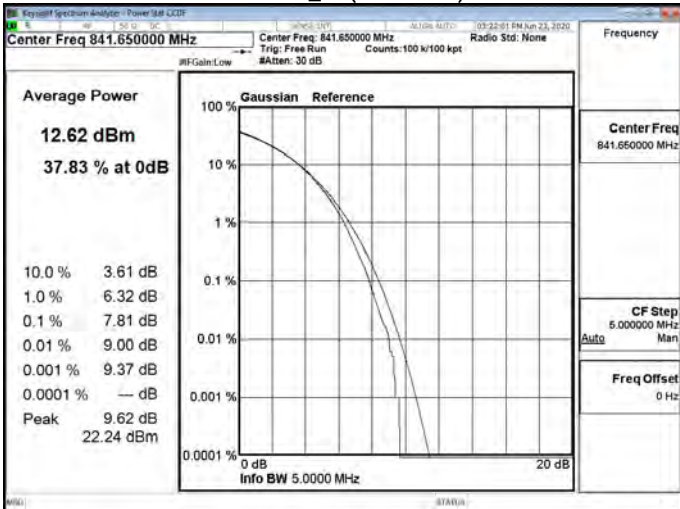

256QAM_B7(2540.2+2560)

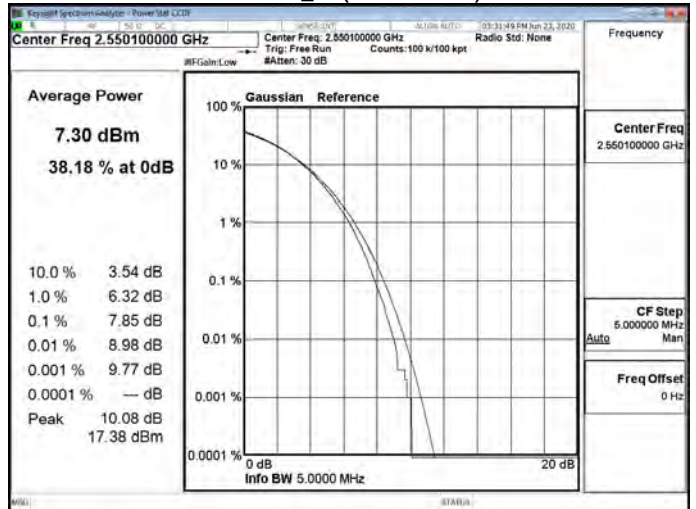

Unless otherwise stated the results shown in this test report refer only to the sample(s) tested and such sample(s) are retained for 90 days only.

除非另有說明，此報告結果僅對測試之樣品負責，同時此樣品僅保留90天。本報告未經本公司書面許可，不可部份複製。

This document is issued by the Company subject to its General Conditions of Service printed overleaf, available on request or accessible at <http://www.sgs.com.tw/Terms-and-Conditions> and for electronic format documents, subject to Terms and Conditions for Electronic Documents at <http://www.sgs.com.tw/Terms-and-Conditions>. Attention is drawn to the limitation of liability, indemnification and jurisdiction issues defined therein. Any holder of this document is advised that information contained hereon reflects the Company's findings at the time of its intervention only and within the limits of Client's instructions, if any. The Company's sole responsibility is to its Client and this document does not exonerate parties to a transaction from exercising all their rights and obligations under the transaction documents. This document cannot be reproduced except in full, without prior written approval of the Company. Any unauthorized alteration, forgery or falsification of the content or appearance of this document is unlawful and offenders may be prosecuted to the fullest extent of the law.

256QAM_B41(2499.3+2511)

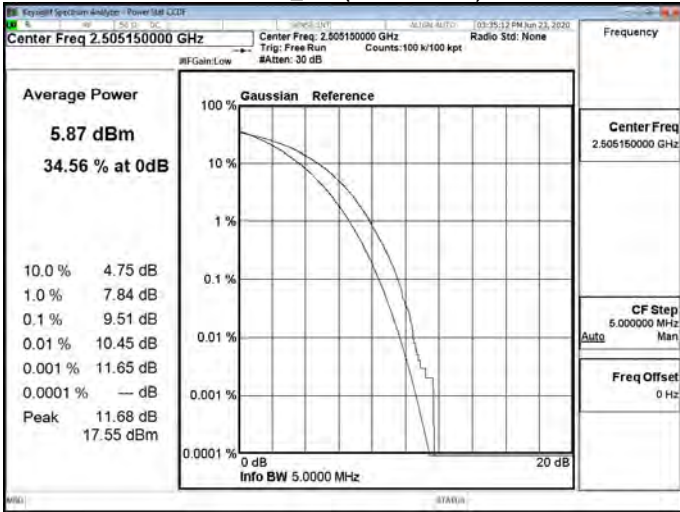

256QAM_B48(3553.3+3565)

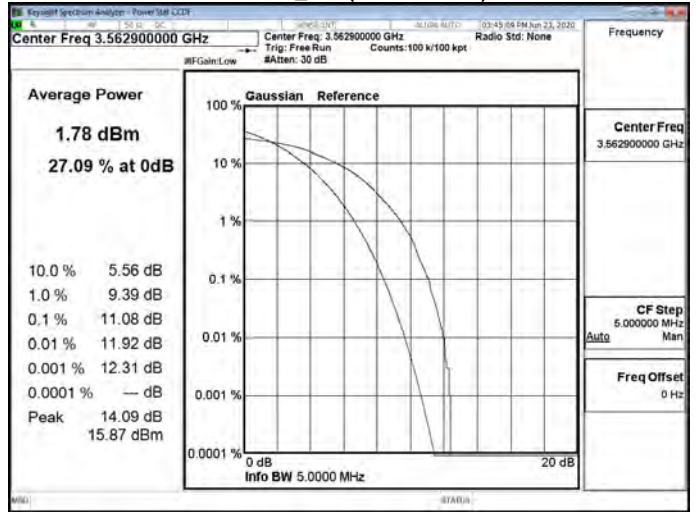

256QAM_B41(2583.8+2595.5)

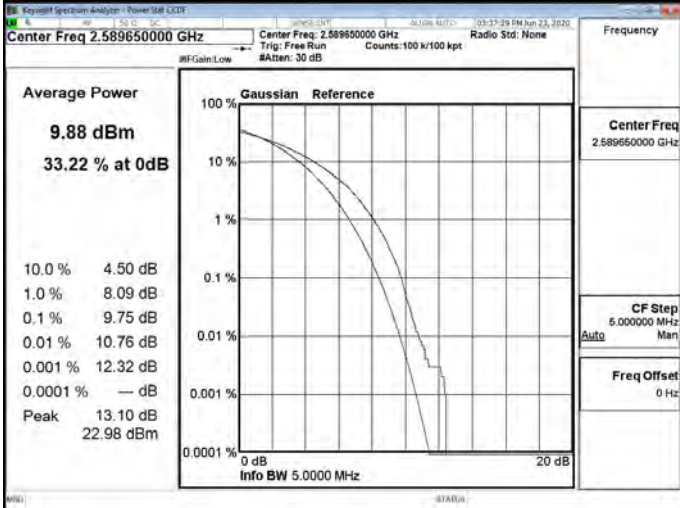

256QAM_B48(3615.8+3627.5)

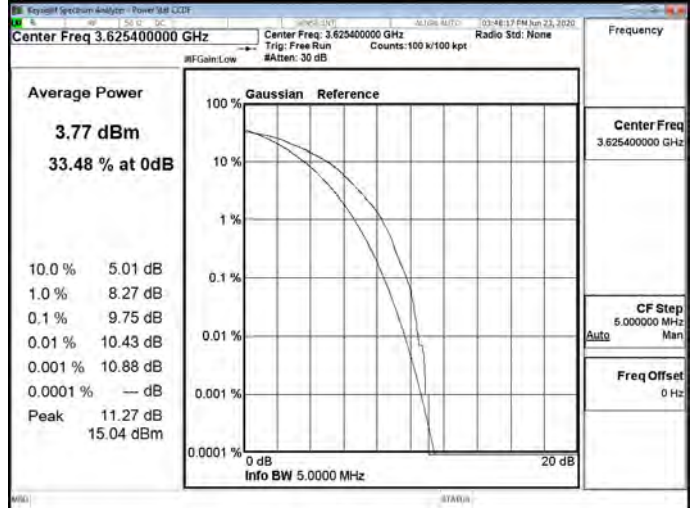

256QAM_B41(2668.3+2680)

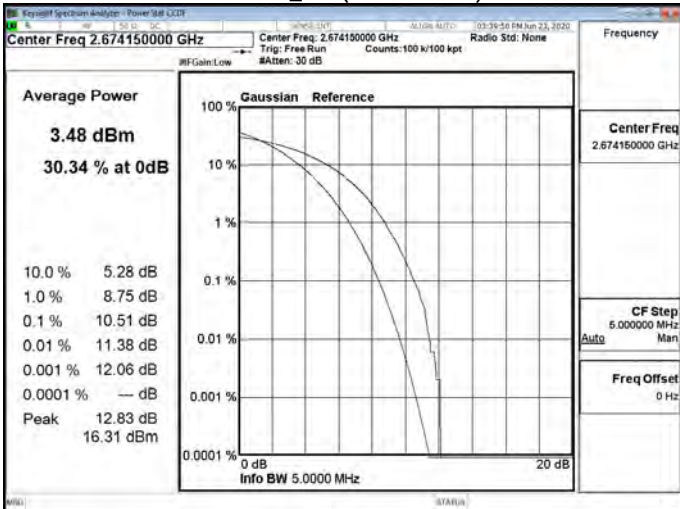

256QAM_B48(3678.3+3690)

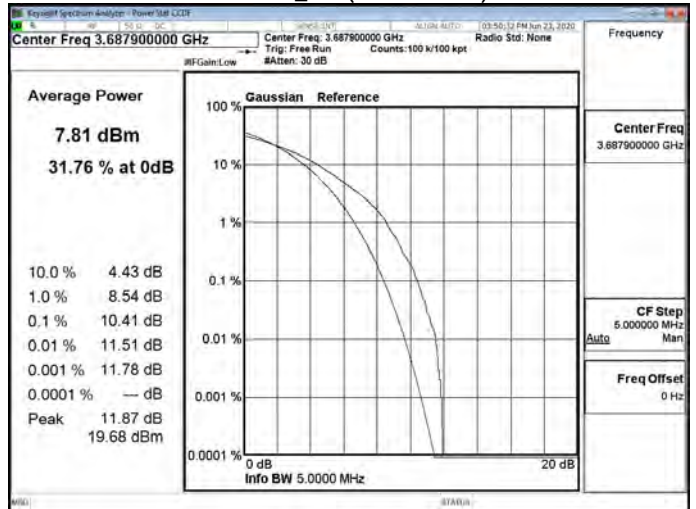

Unless otherwise stated the results shown in this test report refer only to the sample(s) tested and such sample(s) are retained for 90 days only.

除非另有說明，此報告結果僅對測試之樣品負責，同時此樣品僅保留90天。本報告未經本公司書面許可，不可部份複製。

This document is issued by the Company subject to its General Conditions of Service printed overleaf, available on request or accessible at <http://www.sgs.com.tw/Terms-and-Conditions> and for electronic format documents, subject to Terms and Conditions for Electronic Documents at <http://www.sgs.com.tw/Terms-and-Conditions>. Attention is drawn to the limitation of liability, indemnification and jurisdiction issues defined therein. Any holder of this document is advised that information contained hereon reflects the Company's findings at the time of its intervention only and within the limits of Client's instructions, if any. The Company's sole responsibility is to its Client and this document does not exonerate parties to a transaction from exercising all their rights and obligations under the transaction documents. This document cannot be reproduced except in full, without prior written approval of the Company. Any unauthorized alteration, forgery or falsification of the content or appearance of this document is unlawful and offenders may be prosecuted to the fullest extent of the law.

256QAM_B66B(1717.5+1726.8)

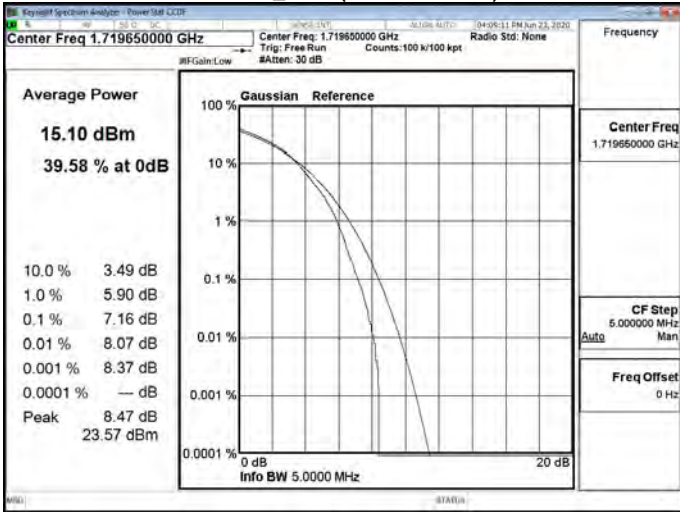

256QAM_B66C(1720+1731.7)

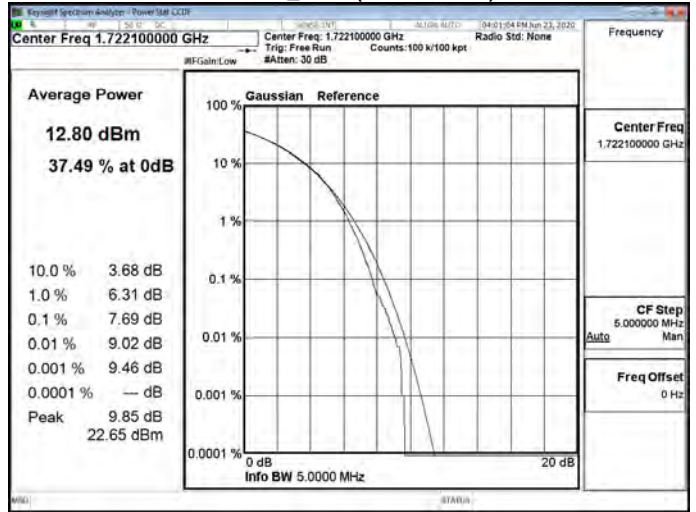

256QAM_B66B(1752.6+1761.9)

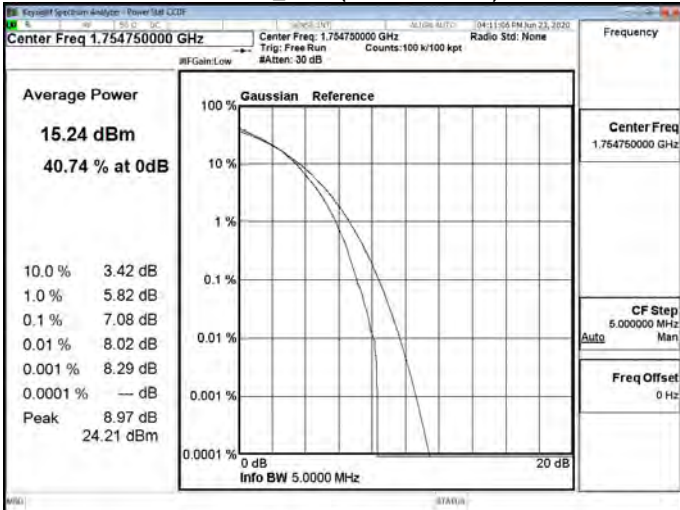

256QAM_B66C(1752.5+1764.2)

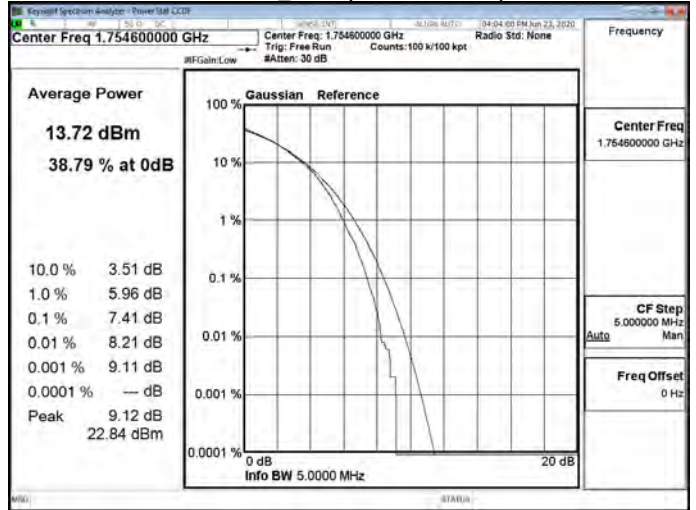

256QAM_B66B(1767.7+1777)

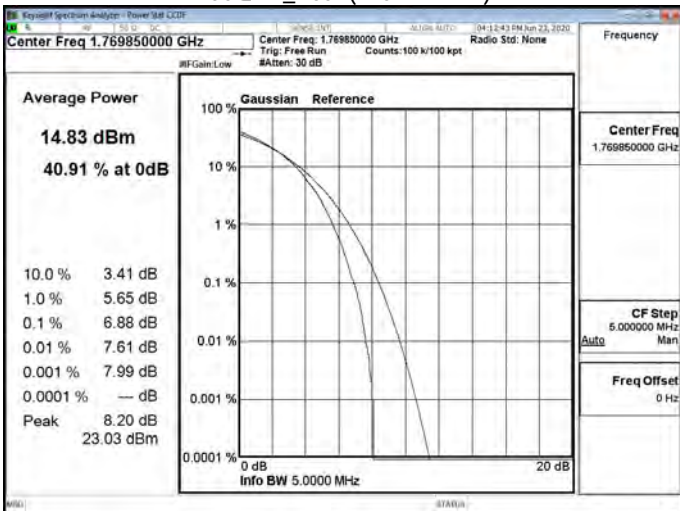

256QAM_B66C(1765+1776.7)

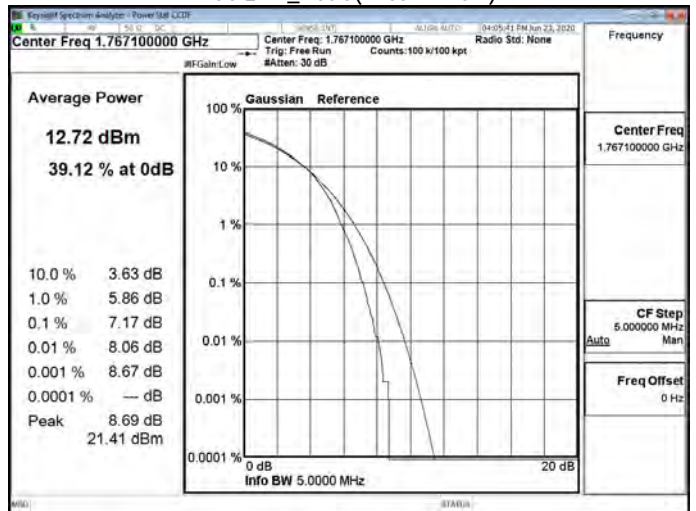

Unless otherwise stated the results shown in this test report refer only to the sample(s) tested and such sample(s) are retained for 90 days only.

除非另有說明，此報告結果僅對測試之樣品負責，同時此樣品僅保留90天。本報告未經本公司書面許可，不可部份複製。

This document is issued by the Company subject to its General Conditions of Service printed overleaf, available on request or accessible at <http://www.sgs.com.tw/Terms-and-Conditions> and for electronic format documents, subject to Terms and Conditions for Electronic Documents at <http://www.sgs.com.tw/Terms-and-Conditions>. Attention is drawn to the limitation of liability, indemnification and jurisdiction issues defined therein. Any holder of this document is advised that information contained hereon reflects the Company's findings at the time of its intervention only and within the limits of Client's instructions, if any. The Company's sole responsibility is to its Client and this document does not exonerate parties to a transaction from exercising all their rights and obligations under the transaction documents. This document cannot be reproduced except in full, without prior written approval of the Company. Any unauthorized alteration, forgery or falsification of the content or appearance of this document is unlawful and offenders may be prosecuted to the fullest extent of the law.

~ End of Report ~

Unless otherwise stated the results shown in this test report refer only to the sample(s) tested and such sample(s) are retained for 90 days only.

除非另有說明，此報告結果僅對測試之樣品負責，同時此樣品僅保留90天。本報告未經本公司書面許可，不可部份複製。

This document is issued by the Company subject to its General Conditions of Service printed overleaf, available on request or accessible at <http://www.sgs.com.tw/Terms-and-Conditions> and for electronic format documents, subject to Terms and Conditions for Electronic Documents at <http://www.sgs.com.tw/Terms-and-Conditions>. Attention is drawn to the limitation of liability, indemnification and jurisdiction issues defined therein. Any holder of this document is advised that information contained hereon reflects the Company's findings at the time of its intervention only and within the limits of Client's instructions, if any. The Company's sole responsibility is to its Client and this document does not exonerate parties to a transaction from exercising all their rights and obligations under the transaction documents. This document cannot be reproduced except in full, without prior written approval of the Company. Any unauthorized alteration, forgery or falsification of the content or appearance of this document is unlawful and offenders may be prosecuted to the fullest extent of the law.

SGS Taiwan Ltd.

台灣檢驗科技股份有限公司

No.134,Wu Kung Road, New Taipei Industrial Park, Wuku District, New Taipei City, Taiwan/新北市五股區新北產業園區五工路 134 號

t (886-2) 2299-3279

f (886-2) 2298-0488

www.sgs.com.tw

Member of SGS Group