



# FCC RADIO TEST REPORT

**FCC ID** : GKRRXLG1  
**Equipment** : 5G LGA Module  
**Brand Name** : Compal  
**Model Name** : RXL-G1  
**Marketing Name** : 5G LGA Module  
**Applicant** : Compal Electronics, Inc.  
No.581 & 581-1, Ruiguang Rd., Neihu District,  
Taipei, (114) Taiwan  
**Manufacturer** : Compal Electronics, Inc.  
No.581 & 581-1, Ruiguang Rd., Neihu District,  
Taipei, (114) Taiwan  
**Standard** : FCC 47 CFR Part 2, 96

The product was received on May 17, 2023 and testing was performed from May 22, 2023 to Jun. 26, 2023. We, Sporton International Inc. EMC & Wireless Communications Laboratory, would like to declare that the tested sample has been evaluated in accordance with the test procedures given in ANSI / TIA-603-E and has been in compliance with the applicable technical standards.

The test results in this report apply exclusively to the tested model / sample. Without written approval from Sporton International Inc. EMC & Wireless Communications Laboratory, the test report shall not be reproduced except in full.

*Louis Wu*

Approved by: Louis Wu

**Sporton International Inc. EMC & Wireless Communications Laboratory**

No. 52, Huaya 1st Rd., Guishan Dist., Taoyuan City 333, Taiwan (R.O.C.)



## Table of Contents

**History of this test report..... 3**

**Summary of Test Result..... 4**

**1 General Description ..... 5**

    1.1 Product Feature of Equipment Under Test ..... 5

    1.2 Modification of EUT ..... 5

    1.3 Testing Location ..... 6

    1.4 Applied Standards ..... 7

**2 Test Configuration of Equipment Under Test ..... 8**

    2.1 Test Mode..... 8

    2.2 Connection Diagram of Test System ..... 9

    2.3 Support Unit used in test configuration ..... 9

    2.4 Measurement Results Explanation Example ..... 9

    2.5 Frequency List of Low/Middle/High Channels..... 10

**3 Conducted Test Items..... 11**

    3.1 Measuring Instruments..... 11

    3.2 Conducted Output Power ..... 12

    3.3 Peak-to-Average Ratio ..... 13

    3.4 EIRP ..... 14

    3.5 Occupied Bandwidth ..... 15

    3.6 Conducted Band Edge ..... 16

    3.7 Conducted Spurious Emission ..... 17

    3.8 Frequency Stability..... 18

**4 Radiated Test Items ..... 19**

    4.1 Measuring Instruments..... 19

    4.2 Test Setup ..... 19

    4.3 Test Result of Radiated Test..... 20

    4.4 Radiated Spurious Emission ..... 21

**5 List of Measuring Equipment..... 22**

**6 Measurement Uncertainty ..... 24**

**Appendix A. Test Results of Conducted Test**

**Appendix B. Test Results of Radiated Test**

**Appendix C. Test Setup Photographs**





### Summary of Test Result

Report Clause	Ref Std. Clause	Test Items	Result (PASS/FAIL)	Remark
3.2	§2.1046 RSS-192 8.6	Conducted Output Power	Reporting only	-
3.3	§96.41	Peak-to-Average Ratio	Pass	
3.4	§96.41	Effective Isotropic Radiated Power	Pass	-
3.5	§2.1049 §96.41	Occupied Bandwidth	Reporting only	-
3.6	§2.1051 §96.41	Conducted Band Edge Measurement	Pass	-
3.7	§2.1051 §96.41	Conducted Spurious Emission	Pass	
3.8	§2.1055	Frequency Stability for Temperature & Voltage	Pass	-
4.4	§2.1051 §96.41	Radiated Spurious Emission	Pass	17.68 dB under the limit at 14649.00 MHz

**Conformity Assessment Condition:**

1. The test results (PASS/FAIL) with all measurement uncertainty excluded are presented against the regulation limits or in accordance with the requirements stipulated by the applicant/manufacturer who shall bear all the risks of non-compliance that may potentially occur if measurement uncertainty is taken into account.
2. The measurement uncertainty please refer to each test result in the section "Measurement Uncertainty".

**Disclaimer:**

The product specifications of the EUT presented in the test report that may affect the test assessments are declared by the manufacturer who shall take full responsibility for the authenticity.

**Reviewed by: Keven Cheng**  
**Report Producer: Doris Chen**



# 1 General Description

## 1.1 Product Feature of Equipment Under Test

Product Feature
<b>General Specs</b> 5G NR
<b>Antenna Type</b> WWAN: PIFA Antenna RF Exposure Max Antenna Gain: -1dBi

**Remark:** The EUT's information above is declared by manufacturer. Please refer to Disclaimer in report summary.

## 1.2 Modification of EUT

No modifications made to the EUT during the testing.



### 1.3 Testing Location

<b>Test Site</b>	Sporton International Inc. EMC & Wireless Communications Laboratory
<b>Test Site Location</b>	No.52, Huaya 1st Rd., Guishan Dist., Taoyuan City 333, Taiwan (R.O.C.) TEL: +886-3-327-3456 FAX: +886-3-328-4978
<b>Test Site No.</b>	<b>Sporton Site No.</b>
	TH03-HY
<b>Test Engineer</b>	George Chen
<b>Temperature (°C)</b>	21~24
<b>Relative Humidity (%)</b>	46~58

**Note:** The test site complies with ANSI C63.4 2014 requirement.

<b>Test Site</b>	Sporton International Inc. Wensan Laboratory
<b>Test Site Location</b>	No.58, Aly. 75, Ln. 564, Wenhua 3rd, Rd., Guishan Dist., Taoyuan City 333010, Taiwan (R.O.C.) TEL: +886-3-327-0868 FAX: +886-3-327-0855
<b>Test Site No.</b>	<b>Sporton Site No.</b>
	03CH12-HY (TAF Code: 3786)
<b>Test Engineer</b>	Tim Lee and Wilson Wu
<b>Temperature (°C)</b>	20~25
<b>Relative Humidity (%)</b>	50~60
<b>Remark</b>	The Radiated Spurious Emission test item subcontracted to Sporton International Inc. Wensan Laboratory.

**Note:** The test site complies with ANSI C63.4 2014 requirement.

FCC Designation No.: TW1190 and TW3786



## **1.4 Applied Standards**

According to the specifications declared by the manufacturer, the EUT must comply with the requirements of the following standards:

- ♦ ANSI C63.26-2015
- ♦ ANSI / TIA-603-E
- ♦ FCC 47 CFR Part 2, 96
- ♦ FCC KDB 971168 D01 Power Meas. License Digital Systems v03r01
- ♦ FCC KDB 940660 D01 Part 96 CBRS Eqpt v03
- ♦ FCC KDB 412172 D01 Determining ERP and EIRP v01r01
- ♦ FCC KDB 414788 D01 Radiated Test Site v01r01

**Remark:**

1. All the test items were validated and recorded in accordance with the standards without any modification during the testing.
2. This EUT has also been tested and complied with the requirements of FCC Part 15, Subpart B, recorded in a separate test report.
3. The TAF code is not including all the FCC KDB listed without accreditation.



## 2 Test Configuration of Equipment Under Test

### 2.1 Test Mode

Antenna port conducted and radiated test items listed below are performed according to KDB 971168 D01 Power Meas. License Digital Systems v03r01 with maximum output power.

For radiated measurement, the measured emission level of the EUT was maximized by rotating the EUT on a turntable, adjusting the orientation of the EUT and EUT antenna in three orthogonal axis (X: flat, Y: portrait, Z: landscape), and adjusting the measurement antenna orientation, following C63.26 exploratory test procedures and only the worst case emissions were reported in this report.

Test Items	Band	Bandwidth (MHz)				Modulation					RB #			Test Channel		
		10	15	20	40	PI/2 BPSK	QPSK	16QAM	64QAM	256QAM	1	Half	Full	L	M	H
Max. Output Power	n48			v	v	v	v	v	v	v	v	v	v	v	v	v
26dB and 99% Bandwidth	n48			v	v	v	v	v	v	v			v		v	
Conducted Band Edge	n48			v	v	v	v	v	v	v	v		v	v	v	v
Peak-to-Average Ratio	n48			v		v	v	v	v	v			v		v	
Conducted Spurious Emission	n48			v			v				v			v	v	v
E.I.R.P	n48			v	v	v	v	v	v	v	Max. Power					
Frequency Stability	n48			v		v					v				v	
Radiated Spurious Emission	n48	Worst Case											v	v	v	
Remark	<ol style="list-style-type: none"> <li>The mark "v" means that this configuration is chosen for testing</li> <li>The mark "-" means that this bandwidth is not supported.</li> <li>The device is investigated from 30MHz to 10 times of fundamental signal for radiated spurious emission test under different RB size/offset and modulations in exploratory test. Subsequently, only the worst case emissions are reported.</li> <li>For radiated measurement, pre-scanned in two modes, DFT-s OFDM and CP OFDM. The worst cases (DFT-s OFDM) were recorded in this report</li> <li>One representative bandwidth is selected to perform PAR and frequency stability.</li> </ol>															



## 2.2 Connection Diagram of Test System

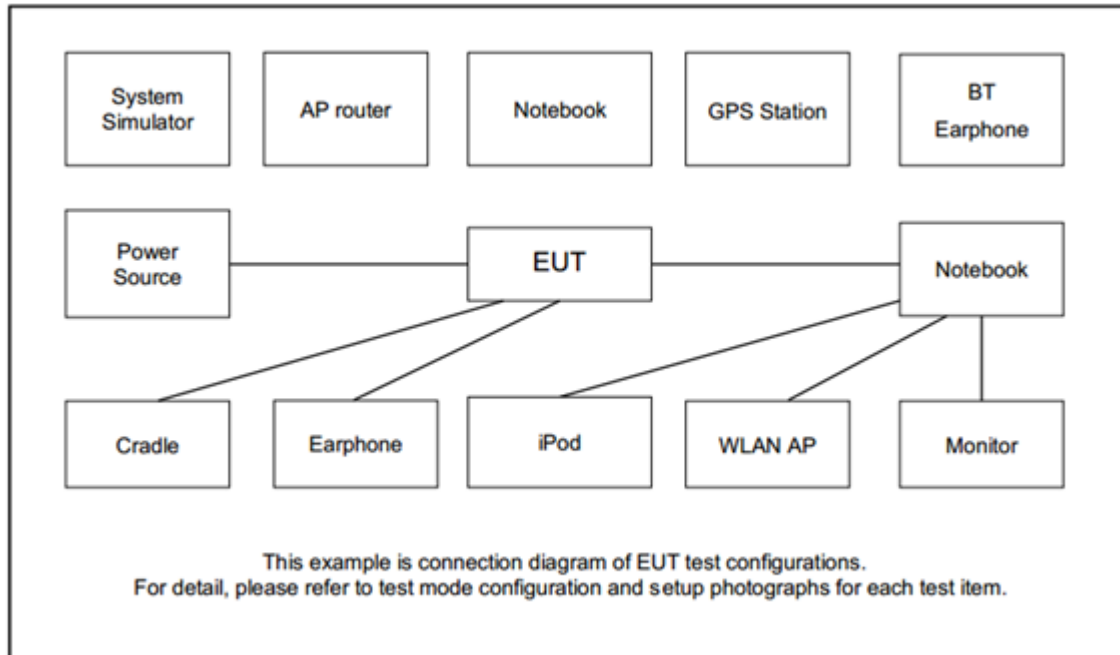

## 2.3 Support Unit used in test configuration

Item	Equipment	Brand Name	Model No.	FCC ID	Data Cable	Power Cord
1.	System Simulator	Anritsu	MT8000A	N/A	N/A	Unshielded, 1.8 m
2.	Adapter	Compal	N/A	N/A	N/A	N/A

## 2.4 Measurement Results Explanation Example

### For all conducted test items:

The offset level is set in the spectrum analyzer to compensate the RF cable loss and attenuator factor between EUT conducted output port and spectrum analyzer. With the offset compensation, the spectrum analyzer reading level is exactly the EUT RF output level.

The spectrum analyzer offset is derived from RF cable loss and attenuator factor.

*Offset = RF cable loss + attenuator factor.*

Following shows an offset computation example with cable loss 4.2 dB and 10dB attenuator.

Example :

$$\begin{aligned} \text{Offset}(dB) &= \text{RF cable loss}(dB) + \text{attenuator factor}(dB). \\ &= 4.2 + 10 = 14.2 \text{ (dB)} \end{aligned}$$



## 2.5 Frequency List of Low/Middle/High Channels

5G NR n48 Channel and Frequency List				
BW [MHz]	Channel/Frequency(MHz)	Lowest	Middle	Highest
40	Channel	638000	641666	645332
	Frequency	3570	3624.99	3679.98
20	Channel	637334	641666	646000
	Frequency	3560.01	3624.99	3690

### 3 Conducted Test Items

#### 3.1 Measuring Instruments

See list of measuring instruments of this test report.

##### 3.1.1 Test Setup

##### 3.1.2 Conducted Output Power

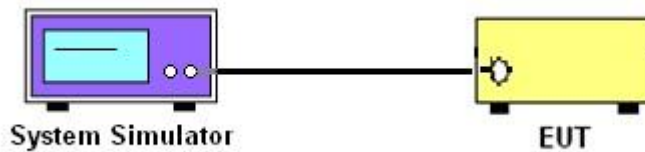

##### 3.1.3 EIRP, Peak-to-Average Ratio, Occupied Bandwidth, Conducted Band-Edge and Conducted Spurious Emission

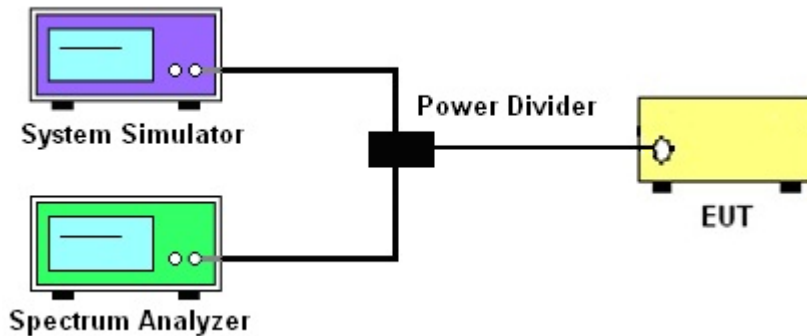

##### 3.1.4 Frequency Stability

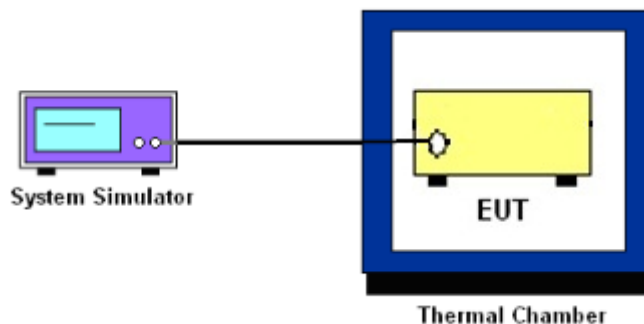

##### 3.1.5 Test Result of Conducted Test

Please refer to Appendix A.



## **3.2 Conducted Output Power**

### **3.2.1 Description of the Conducted Output Power Measurement**

A system simulator was used to establish communication with the EUT. Its parameters were set to force the EUT transmitting at maximum output power. The measured power in the radio frequency on the transmitter output terminals shall be reported.

### **3.2.2 Test Procedures**

1. The transmitter output port was connected to the system simulator.
2. Set EUT at maximum power through the system simulator.
3. Select lowest, middle, and highest channels for each band and different modulation.
4. Measure and record the power level from the system simulator.



### **3.3 Peak-to-Average Ratio**

#### **3.3.1 Description of the PAR Measurement**

Power Complementary Cumulative Distribution Function (CCDF) curves provide a means for characterizing the power peaks of a digitally modulated signal on a statistical basis. A CCDF curve depicts the probability of the peak signal amplitude exceeding the average power level. Most contemporary measurement instrumentation include the capability to produce CCDF curves for an input signal provided that the instrument's resolution bandwidth can be set wide enough to accommodate the entire input signal bandwidth. In measuring transmissions in this band using an average power technique, the peak-to-average ratio (PAR) of the transmission may not exceed 13 dB.

#### **3.3.2 Test Procedures**

The testing follows ANSI C63.26-2015 Section 5.2.6

1. The EUT was connected to spectrum and system simulator via a power divider.
2. Set the CCDF (Complementary Cumulative Distribution Function) option in spectrum analyzer.
3. The highest RF powers were measured and recorded the maximum PAPR level associated with a probability of 0.1 %.
4. Record the deviation as Peak to Average Ratio



### 3.4 EIRP

#### 3.4.1 Description of the EIRP Measurement

The EIRP of mobile transmitters must not exceed 23 dBm /10 megahertz for LTE Band 48.

The testing follows ANSI C63.26-2015 Section 5.2.5.5

According to KDB 412172 D01 Power Approach,

$EIRP = P_T + G_T - LC$ , where

$P_T$  = transmitter output power in dBm

$G_T$  = gain of the transmitting antenna in dBi

$LC$  = signal attenuation in the connecting cable between the transmitter and antenna in dB

Device	Maximum EIRP (dBm/10 MHz)	Maximum PSD (dBm/MHz)
End User Device	23	n/a

**Remark:** Total channel power is complied with EIRP limit 23dBm/10MHz.

#### 3.4.2 Test Procedures

The testing follows procedure in Section 5.2 of ANSI C63.26-2015 and KDB 940660 D01 Part 96 CBRS Eqpt v03 Section 3.2(b)(2)

Determine the EIRP by adding the effective antenna gain to the measured average conducted power level.



## 3.5 Occupied Bandwidth

### 3.5.1 Description of Occupied Bandwidth Measurement

The occupied bandwidth is the width of a frequency band such that, below the lower and above the upper frequency limits, the mean powers emitted are each equal to a specified percentage 0.5% of the total mean transmitted power.

The 26 dB emission bandwidth is defined as the frequency range between two points, one above and one below the carrier frequency, at which the spectral density of the emission is attenuated 26 dB below the maximum in-band spectral density of the modulated signal. Spectral density (power per unit bandwidth) is to be measured with a detector of resolution bandwidth equal to approximately 1.0% of the emission bandwidth.

### 3.5.2 Test Procedures

The testing follows ANSI C63.26-2015 Section 5.4.3 (26dB) and Section 5.4.4 (99OB)

1. The EUT was connected to spectrum analyzer and system simulator via a power divider.
2. The spectrum analyzer center frequency is set to the nominal EUT channel center frequency. The span range for the spectrum analyzer shall be between two and five times the anticipated OBW.
3. The nominal resolution bandwidth (RBW) shall be in the range of 1 to 5 % of the anticipated OBW, and the VBW shall be at least 3 times the RBW.
4. Set the detection mode to peak, and the trace mode to max hold.
5. Determine the reference value: Set the EUT to transmit a modulated signal. Allow the trace to stabilize. Set the spectrum analyzer marker to the highest level of the displayed trace.  
(this is the reference value)
6. Determine the “-26 dB down amplitude” as equal to (Reference Value – X).
7. Place two markers, one at the lowest and the other at the highest frequency of the envelope of the spectral display such that each marker is at or slightly below the “-X dB down amplitude” determined in step 6. If a marker is below this “-X dB down amplitude” value it shall be placed as close as possible to this value. The OBW is the positive frequency difference between the two markers.
8. Use the 99 % power bandwidth function of the spectrum analyzer and report the measured bandwidth.



## **3.6 Conducted Band Edge**

### **3.6.1 Description of Conducted Band Edge Measurement**

The conducted power of any End User Device emission outside the fundamental emission (whether in or outside of the authorized band) shall not exceed  $-13$  dBm/MHz within 0 to B megahertz (where B is the bandwidth in megahertz of the assigned channel or multiple contiguous channels of the End User Device) above the upper CBSD-assigned channel edge and within 0 to B megahertz below the lower CBSD-assigned channel edge. At all frequencies greater than B megahertz above the upper CBSD assigned channel edge and less than B megahertz below the lower CBSD-assigned channel edge, the conducted power of any End User Device emission shall not exceed  $-25$  dBm/MHz. Notwithstanding the emission limits in this paragraph, the Adjacent Channel Leakage Ratio for End User Devices shall be at least 30 dB.

### **3.6.2 Test Procedures**

The testing follows FCC KDB 971168 D01 v03r01 Section 6.1.

1. The EUT was connected to spectrum analyzer and system simulator via a power divider.
2. The band edges of low and high channels for the highest RF powers were measured.
3. Set RBW  $\geq$  1% EBW in the 1MHz band immediately outside and adjacent to the band edge.
4. Beyond the 1 MHz band from the band edge, RBW=1MHz was used
5. Set spectrum analyzer with RMS detector.
6. The RF fundamental frequency should be excluded against the limit line in the operating frequency band.

For Adjacent Channel Leakage Ratio (ACLR) measurement,

1. The Adjacent Channel Leakage Ratio (ACLR) is the ratio of the average power in the assigned aggregated channel bandwidth to the average power over the equivalent adjacent channel bandwidth.
2. The option ACLR of spectrum analyzer is used and measures the ACLR ratio by setting equivalent channel bandwidth.
3. The measured ACLR ratio shall be at least 30 dB.





## 3.7 Conducted Spurious Emission

### 3.7.1 Description of Conducted Spurious Emission Measurement

96.41 (e)(2)

The conducted power of any emissions below 3530 MHz or above 3720 MHz shall not exceed -40dBm/MHz.

### 3.7.2 Test Procedures

The testing follows FCC KDB 971168 D01 v03r01 Section 6.1.

1. The EUT was connected to spectrum analyzer and system simulator via a power divider.
2. The RF output of EUT was connected to the spectrum analyzer by RF cable and attenuator. The path loss was compensated to the results for each measurement.
3. The middle channel for the highest RF power within the transmitting frequency was measured.
4. The conducted spurious emission for the whole frequency range was taken.
5. Make the measurement with the spectrum analyzer's RBW = 1MHz, VBW = 3MHz.
6. Set spectrum analyzer with RMS detector.
7. Taking the record of maximum spurious emission.
8. The RF fundamental frequency should be excluded against the limit line in the operating frequency band.
9. The limit line is -40dBm/MHz.



## **3.8 Frequency Stability**

### **3.8.1 Description of Frequency Stability Measurement**

The frequency stability shall be measured by variation of ambient temperature and variation of primary supply voltage to ensure that the fundamental emission stays within the authorized frequency block. The frequency stability of the transmitter shall be maintained within  $\pm 0.00025\%$  ( $\pm 2.5\text{ppm}$ ) of the center frequency

### **3.8.2 Test Procedures for Temperature Variation**

The testing follows FCC KDB 971168 D01 v03r01 Section 9.0.

1. The EUT was set up in the thermal chamber and connected with the system simulator.
2. With power OFF, the temperature was decreased to  $-30^{\circ}\text{C}$  and the EUT was stabilized before testing. Power was applied and the maximum change in frequency was recorded within one minute.
3. With power OFF, the temperature was raised in  $10^{\circ}\text{C}$  step up to  $50^{\circ}\text{C}$ . The EUT was stabilized at each step for at least half an hour. Power was applied and the maximum frequency change was recorded within one minute.

### **3.8.3 Test Procedures for Voltage Variation**

The testing follows FCC KDB 971168 D01 v03r01 Section 9.0.

1. The EUT was placed in a temperature chamber at  $25\pm 5^{\circ}\text{C}$  and connected with the system simulator.
2. The power supply voltage to the EUT was varied from 85% to 115% of the nominal value measured at the input to the EUT.
3. The variation in frequency was measured for the worst case.

## 4 Radiated Test Items

### 4.1 Measuring Instruments

See list of measuring instruments of this test report.

### 4.2 Test Setup

For radiated emissions below 30MHz

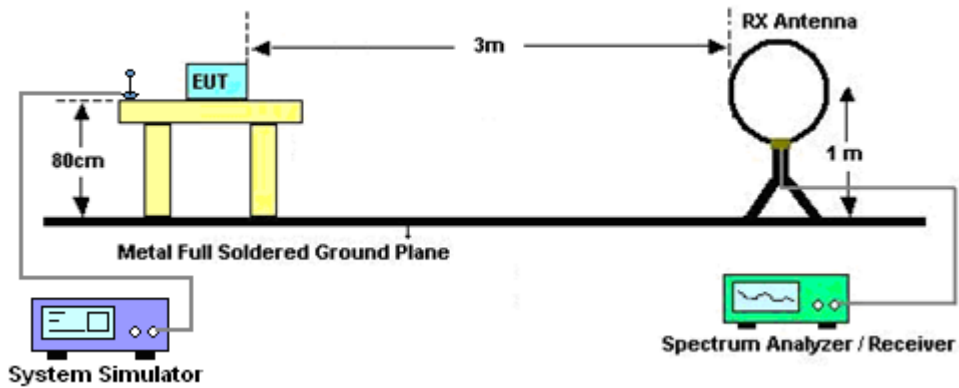

For radiated emissions from 30MHz to 1GHz

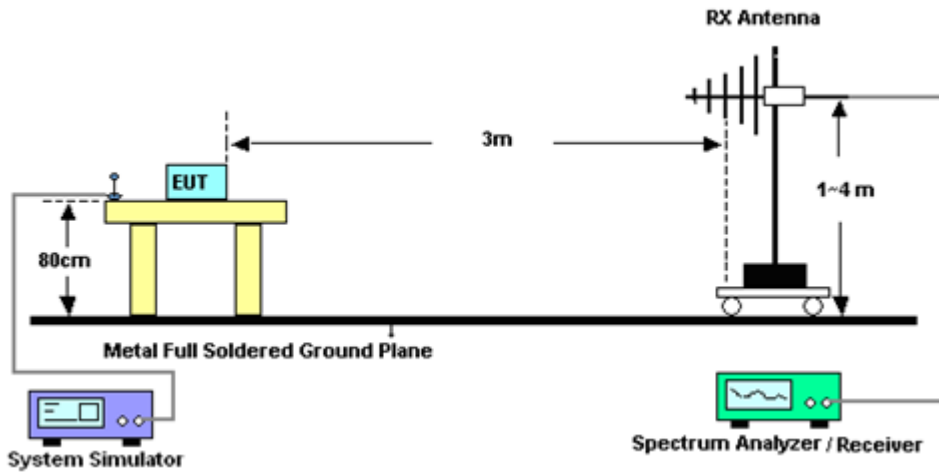

For radiated test from 1GHz to 18GHz

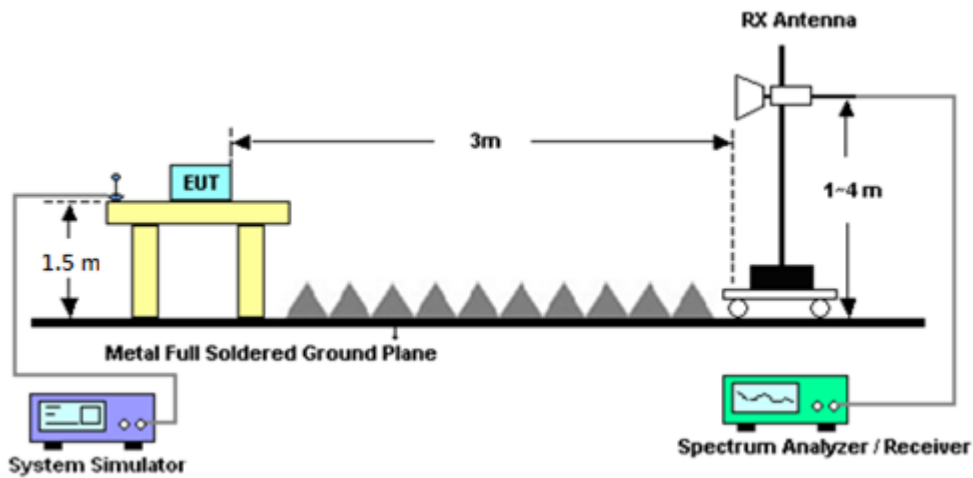

For radiated test above 18GHz

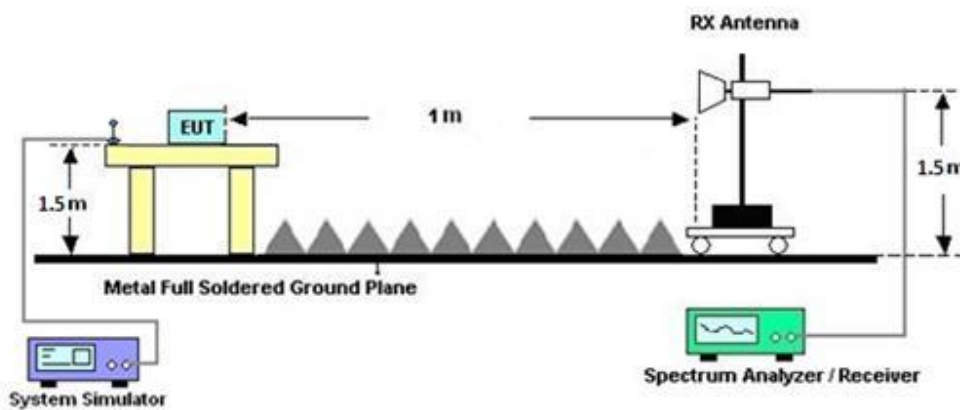

### 4.3 Test Result of Radiated Test

Please refer to Appendix B.

**Note:**

The low frequency, which started from 9 kHz to 30MHz, was pre-scanned and the result which was 20dB lower than the limit line was not reported.

There is adequate comparison measurement of both open-field test site and alternative test site - semi-Anechoic chamber according to 414788 D01 Radiated Test Site v01r01, and the result came out very similar.



## 4.4 Radiated Spurious Emission

### 4.4.1 Description of Radiated Spurious Emission Measurement

The radiated spurious emission was measured by substitution method according to ANSI / TIA-603-E. The power of any emission outside of the authorized operating frequency ranges must be attenuated below the transmitter power (P) by a factor of at least -40dBm / MHz .

The spectrum is scanned from 30 MHz up to a frequency including its 10th harmonic.

### 4.4.2 Test Procedures

The testing follows FCC KDB 971168 D01 v03r01 Section 7 and ANSI / TIA-603-E Section 2.2.12.

1. The EUT was placed on a turntable with 0.8 meter height for frequency below 1GHz and 1.5 meter height for frequency above 1GHz respectively above ground.
2. The EUT was set 3 meters from the receiving antenna mounted on the antenna tower.
3. The table was rotated 360 degrees to determine the position of the highest spurious emission.
4. The height of the receiving antenna is varied between 1m to 4m to search the maximum spurious emission for both horizontal and vertical polarizations.
5. During the measurement, the system simulator parameters were set to force the EUT transmitting at maximum output power.
6. Make the measurement with the spectrum analyzer's RBW = 1MHz, VBW = 3MHz, taking the record of maximum spurious emission.
7. A horn antenna was substituted in place of the EUT and was driven by a signal generator. Tune the output power of signal generator to the same emission level with EUT maximum spurious emission.  
EIRP (dBm) = S.G. Power – Tx Cable Loss + Tx Antenna Gain  
ERP (dBm) = EIRP - 2.15
8. The RF fundamental frequency should be excluded against the limit line in the operating frequency band.  
The limit line is -40dBm/MHz



## 5 List of Measuring Equipment

Instrument	Brand Name	Model No.	Serial No.	Characteristics	Calibration Date	Test Date	Due Date	Remark
Loop Antenna	Rohde & Schwarz	HFH2-Z2	100488	9 kHz~30 MHz	Sep. 20, 2022	Jun. 07, 2023~ Jun. 08 2023	Sep. 19, 2023	Radiation (03CH12-HY)
Bilog Antenna	TESEQ	CBL 6111D & 00800N1D01 N-06	37059 & 01	30MHz~1GHz	Nov. 10, 2022	Jun. 07, 2023~ Jun. 08 2023	Nov. 09, 2023	Radiation (03CH12-HY)
Horn Antenna	SCHWARZBE CK	BBHA 9120 D	9120D-021 14	1GHz~18GHz	Aug. 09, 2022	Jun. 07, 2023~ Jun. 08 2023	Aug. 08, 2023	Radiation (03CH12-HY)
SHF-EHF Horn Antenna	SCHWARZBE CK	BBHA9170	00993	18GHz~40GHz	Nov. 24, 2022	Jun. 07, 2023~ Jun. 08 2023	Nov. 23, 2023	Radiation (03CH12-HY)
Preamplifier	COM-POWER	PA-103A	161241	10MHz~1GHz	Oct. 03, 2022	Jun. 07, 2023~ Jun. 08 2023	Oct. 02, 2023	Radiation (03CH12-HY)
Preamplifier	Agilent	8449B	3008A023 75	1GHz~26.5GHz	May 23, 2023	Jun. 07, 2023~ Jun. 08 2023	May 22, 2024	Radiation (03CH12-HY)
Preamplifier	E-INSTRUME NT TECH LTD.	ERA-100M-18 G-56-01-A70	EC190024 9	1GHz~18GHz	Dec. 21, 2022	Jun. 07, 2023~ Jun. 08 2023	Dec. 20, 2023	Radiation (03CH12-HY)
Preamplifier	EMEC	EM18G40G	060715	18GHz~40GHz	Dec. 07, 2022	Jun. 07, 2023~ Jun. 08 2023	Dec. 06, 2023	Radiation (03CH12-HY)
Spectrum Analyzer	Agilent	N9010A	MY534701 18	10Hz~44GHz	Jan. 10, 2023	Jun. 07, 2023~ Jun. 08 2023	Jan. 09, 2024	Radiation (03CH12-HY)
Filter	Wainwright	WHKX8-5872. 5-6750-18000 -40ST	SN2	6.75GHz High Pass Filter	Mar. 14, 2023	Jun. 07, 2023~ Jun. 08 2023	Mar. 13, 2024	Radiation (03CH12-HY)
RF Cable	HUBER + SUHNER	SUCOFLEX 102	803951/2	9kHz~30MHz	Mar. 07, 2023	Jun. 07, 2023~ Jun. 08 2023	Mar. 06, 2024	Radiation (03CH12-HY)
RF Cable	HUBER + SUHNER	SUCOFLEX 126E	0058/126E	30MHz~18GHz	Dec. 20, 2022	Jun. 07, 2023~ Jun. 08 2023	Dec. 19, 2023	Radiation (03CH12-HY)
RF Cable	HUBER + SUHNER	SUCOFLEX 102	505134/2	30MHz~40GHz	Dec. 20, 2022	Jun. 07, 2023~ Jun. 08 2023	Dec. 19, 2023	Radiation (03CH12-HY)
RF Cable	HUBER + SUHNER	SUCOFLEX 102	803953/2	30MHz~40GHz	Dec. 20, 2022	Jun. 07, 2023~ Jun. 08 2023	Dec. 19, 2023	Radiation (03CH12-HY)
Hygrometer	TECPEL	DTM-303B	TP210090	N/A	Oct. 03, 2022	Jun. 07, 2023~ Jun. 08 2023	Oct. 02, 2023	Radiation (03CH12-HY)
Controller	EMEC	EM1000	N/A	Control Turn table & Ant Mast	N/A	Jun. 07, 2023~ Jun. 08 2023	N/A	Radiation (03CH12-HY)
Antenna Mast	EMEC	AM-BS-4500- B	N/A	1m~4m	N/A	Jun. 07, 2023~ Jun. 08 2023	N/A	Radiation (03CH12-HY)
5G Wireless Test Platform	Anritsu	MT8000A	626194032 7	N/A	Dec. 09, 2022	Jun. 07, 2023~ Jun. 08 2023	Dec. 08, 2023	Radiation (03CH12-HY)
Turn Table	EMEC	TT2000	N/A	0~360 Degree	N/A	Jun. 07, 2023~ Jun. 08 2023	N/A	Radiation (03CH12-HY)
Software	Audix	E3 6.2009-8-24	RK-00098 9	N/A	N/A	Jun. 07, 2023~ Jun. 08 2023	N/A	Radiation (03CH12-HY)



Instrument	Brand Name	Model No.	Serial No.	Characteristics	Calibration Date	Test Date	Due Date	Remark
Programmable Power Supply	GW Instek	PSS-2005	EL890001	50Hz~60Hz	Sep. 29, 2022	May 22, 2023~ Jun. 26, 2023	Sep. 28, 2023	Conducted (TH03-HY)
Signal Analyzer	Rohde & Schwarz	FSV3044	101049	10Hz~44GHz	Oct. 07, 2022	May 22, 2023~ Jun. 26, 2023	Oct. 06, 2023	Conducted (TH03-HY)
Temperature Chamber	ESPEC	SH-641	92013720	-40°C~90°C	Sep. 07, 2022	May 22, 2023~ Jun. 26, 2023	Sep. 06, 2023	Conducted (TH03-HY)
Base Station (Measure)	Anritsu	MT8821C	626211672 5	LTE	Oct. 12, 2022	May 22, 2023~ Jun. 26, 2023	Oct. 11, 2023	Conducted (TH03-HY)



## 6 Measurement Uncertainty

### Uncertainty of Radiated Emission Measurement (30 MHz ~ 1000 MHz)

Measuring Uncertainty for a Level of Confidence of 95% ( $U = 2Uc(y)$ )	3.31 dB
---	---------

### Uncertainty of Radiated Emission Measurement (1 GHz ~ 18 GHz)

Measuring Uncertainty for a Level of Confidence of 95% ( $U = 2Uc(y)$ )	3.25 dB
---	---------

### Uncertainty of Radiated Emission Measurement (18 GHz ~ 40 GHz)

Measuring Uncertainty for a Level of Confidence of 95% ( $U = 2Uc(y)$ )	3.81 dB
---	---------





## Appendix A. Test Results of Conducted Test

### Conducted Output Power(Average power) and ERP/EIRP

NR n48 Maximum Average Power [dBm] (GT - LC = -1 dB)								
BW [MHz]	RB Size	RB Offset	Mod	Lowest	Middle	Highest	EIRP (dBm)	EIRP(W)
20	1	1	PI/2 BPSK	14.89	23.56	23.71	22.71	0.1866
20	1	49		22.79	23.59	15.61		
20	25	12		22.84	23.52	23.61		
20	1	0		14.97	22.99	23.21		
20	1	50		22.21	23.04	15.66		
20	50	0		14.81	23.04	15.65		
20	1	1	QPSK	14.85	23.50	23.69		
20	1	49		22.78	23.60	15.59		
20	25	12		22.84	23.55	23.65		
20	1	0		14.96	22.57	22.72		
20	1	50		21.72	22.58	15.59		
20	50	0		14.80	22.60	15.63		
20	1	1	16-QAM	14.95	22.66	22.94	21.94	0.1563
20	1	1	64-QAM	14.95	21.11	21.34		
20	1	1	256-QAM	14.53	18.76	18.94		
Limit	EIRP < 23dBm/10MHz			Result			Pass	

NR n48 Maximum Average Power [dBm] (GT - LC = -1 dB)								
BW [MHz]	RB Size	RB Offset	Mod	Lowest	Middle	Highest	EIRP (dBm)	EIRP(W)
40	1	1	PI/2 BPSK	10.77	11.54	11.58	22.91	0.1954
40	1	104		11.00	11.56	11.52		
40	50	25		10.59	23.91	11.43		
40	1	0		10.69	11.49	11.60		
40	1	105		11.00	11.57	11.50		
40	100	0		10.67	19.42	11.42		
40	1	1	QPSK	10.75	11.41	11.55		
40	1	104		10.97	11.38	11.55		
40	50	25		10.61	23.89	11.43		
40	1	0		10.74	11.35	11.57		
40	1	105		10.96	11.39	11.44		
40	100	0		10.69	19.47	11.41		
40	1	1	16-QAM	15.49	16.15	16.31	15.31	0.034
40	1	1	64-QAM	15.39	16.05	16.28		
40	1	1	256-QAM	15.03	15.71	15.84		
Limit	EIRP < 23dBm/10MHz			Result			Pass	



# FR1 n48

## Peak-to-Average Ratio

Mode	FR1 n48 / 20MHz / DFT-S OFDM				
Mod.	PI/2 BPSK	QPSK	16QAM	64QAM	Limit: 13dB
RB Size	Full RB	Full RB	Full RB	Full RB	Result
Middle CH	4.56	5.98	6.58	6.76	PASS
Mode	FR1 n48 / 20MHz / DFT-S OFDM				
Mod.	256QAM				Limit: 13dB
RB Size	Full RB				Result
Middle CH	6.42				PASS



FR1 n48 / 20MHz / DFT-S OFDM / Middle Channel / Full RB

PI/2 BPSK

QPSK

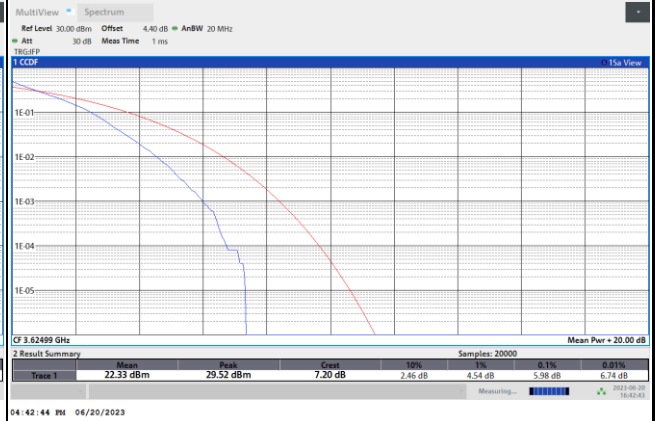
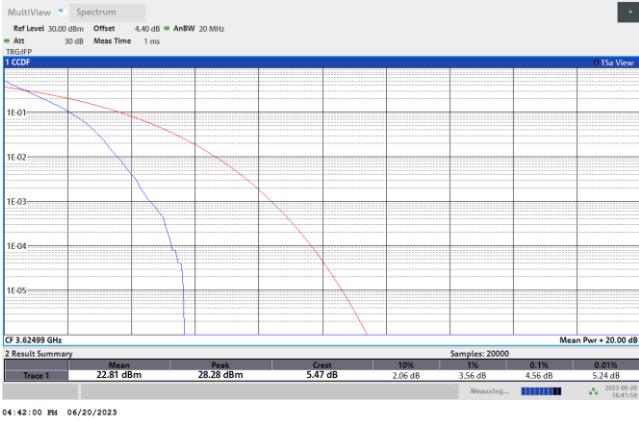

16QAM

64QAM

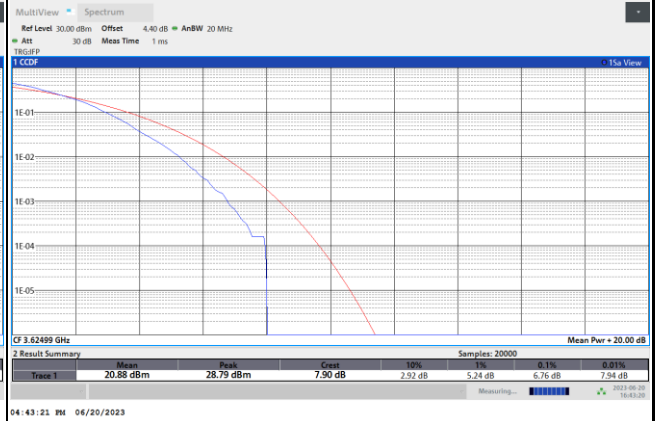
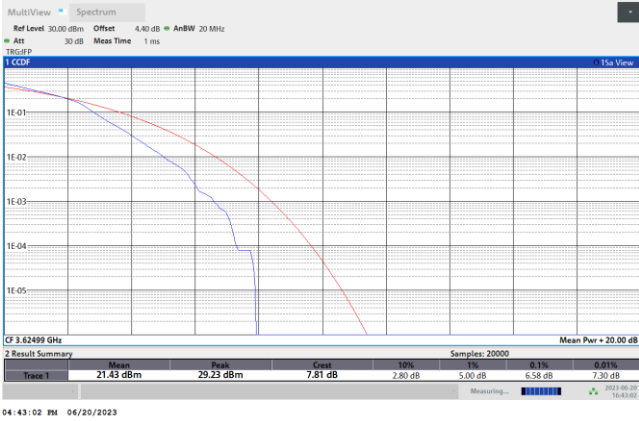

256QAM

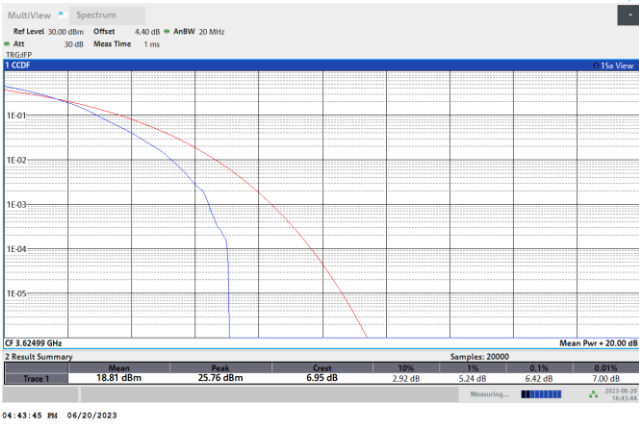



**26dB Bandwidth**

Mode	FR1 n48 : 26dB BW(MHz) / DFT-S OFDM							
BW	10MHz	20MHz	40MHz	50MHz	60MHz	80MHz	90MHz	100MHz
Mod.	PI/2 BPSK	PI/2 BPSK	PI/2 BPSK	PI/2 BPSK	PI/2 BPSK	PI/2 BPSK	PI/2 BPSK	PI/2 BPSK
Middle CH	-	19.42	38.36	-	-	-	-	-

Mode	FR1 n48 : 26dB BW(MHz) / CP OFDM							
BW	10MHz		20MHz		40MHz		50MHz	
Mod.	QPSK	16QAM	QPSK	16QAM	QPSK	16QAM	QPSK	16QAM
Middle CH	-	-	19.78	19.58	40.60	40.52	-	-
Mod.	64QAM	256QAM	64QAM	256QAM	64QAM	256QAM	64QAM	256QAM
Middle CH	-	-	19.78	19.42	40.68	40.68	-	-



FR1 n48 / 20MHz / DFT-S OFDM / Middle Channel / Full RB

PI/2 BPSK

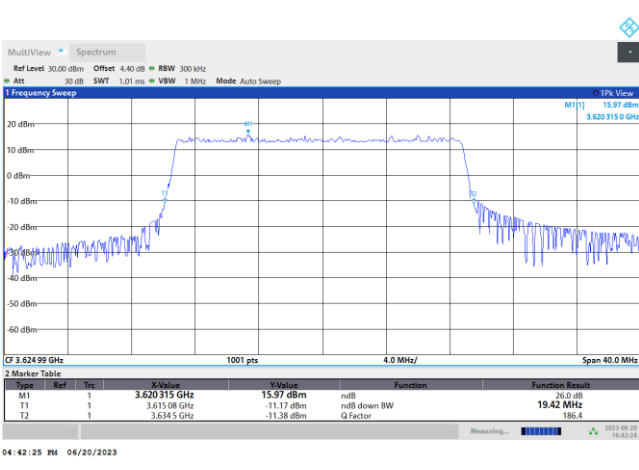

FR1 n48 / 20MHz / CP OFDM / Middle Channel / Full RB

QPSK

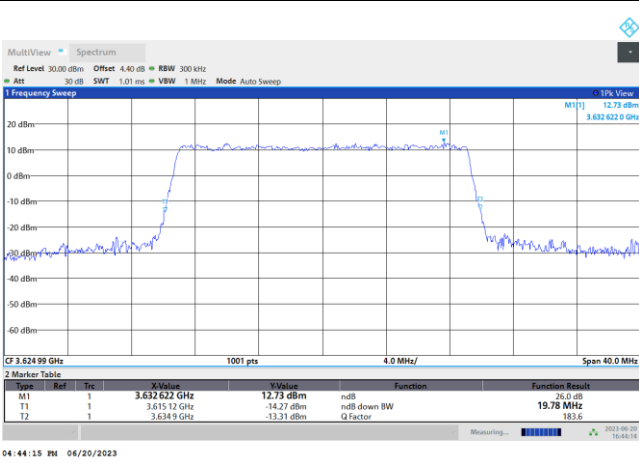

16QAM

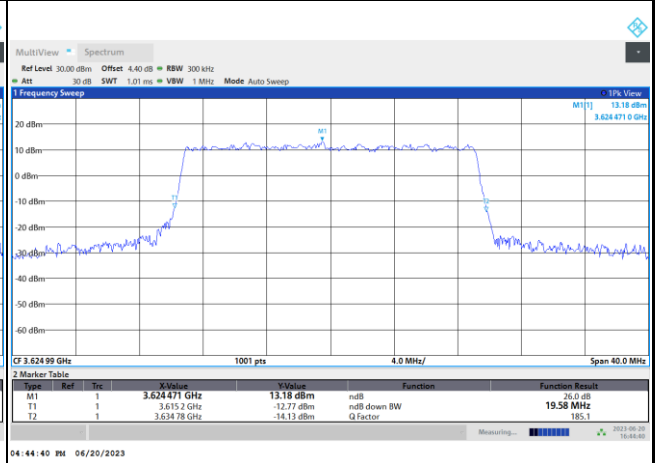

64QAM

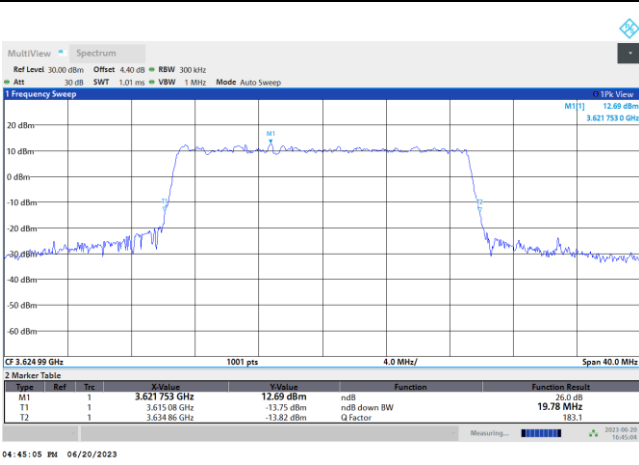

256QAM

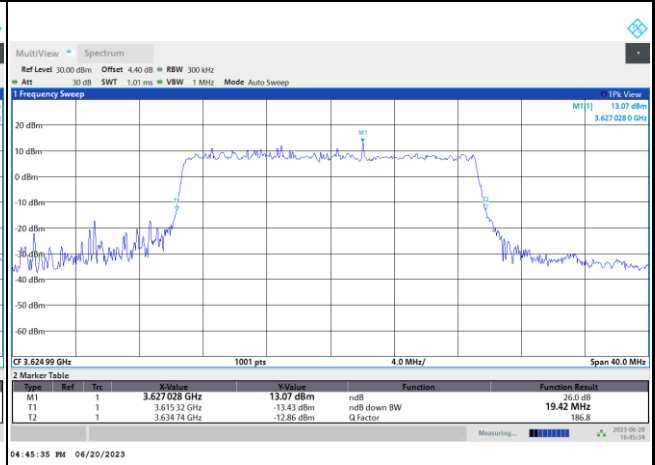



FR1 n48 / 40MHz / DFT-S OFDM / Middle Channel / Full RB

PI/2 BPSK

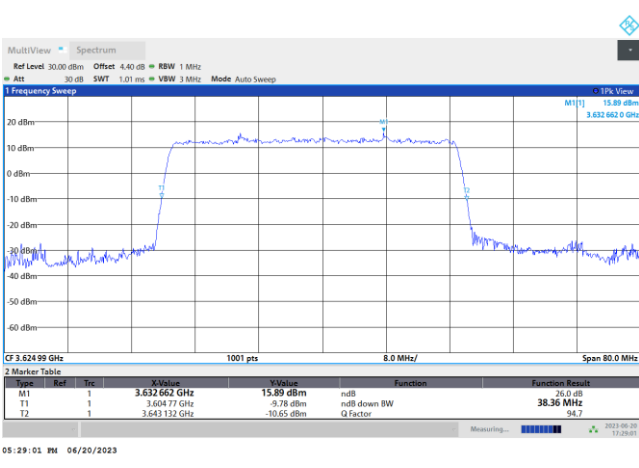

FR1 n48 / 40MHz / CP OFDM / Middle Channel / Full RB

QPSK

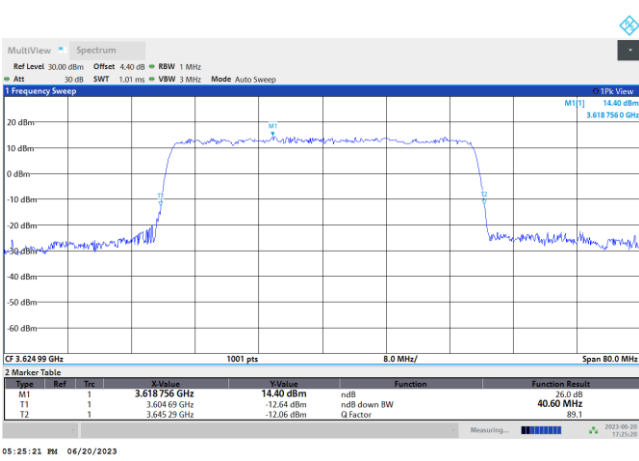

16QAM

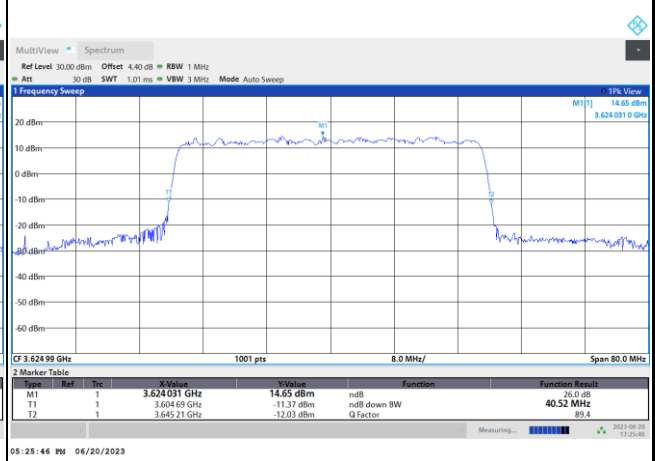

64QAM

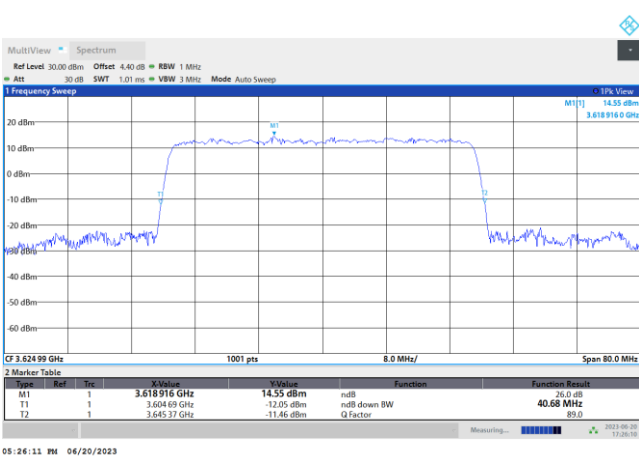

256QAM

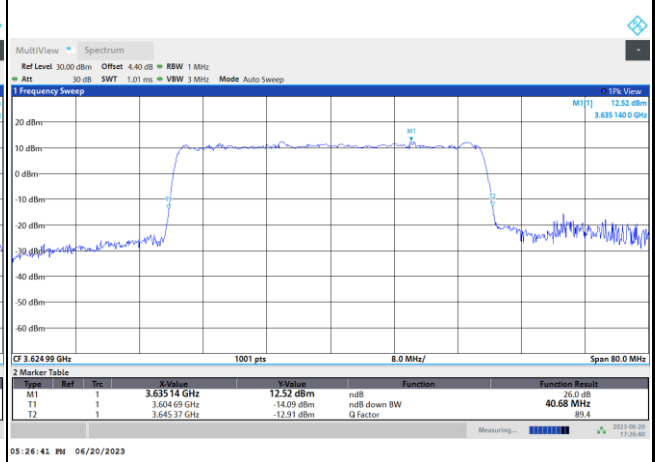



### Occupied Bandwidth

Mode	FR1 n48 : OB BW(MHz) / DFT-S OFDM							
BW	10MHz	20MHz	40MHz	50MHz	60MHz	80MHz	90MHz	100MHz
Mod.	PI/2 BPSK	PI/2 BPSK	PI/2 BPSK	PI/2 BPSK	PI/2 BPSK	PI/2 BPSK	PI/2 BPSK	PI/2 BPSK
Middle CH	-	17.93	35.85	-	-	-	-	-

Mode	FR1 n48 : OB BW(MHz) / CP OFDM							
BW	10MHz		20MHz		40MHz		50MHz	
Mod.	QPSK	16QAM	QPSK	16QAM	QPSK	16QAM	QPSK	16QAM
Middle CH	-	-	18.22	18.25	37.86	37.96	-	-
Mod.	64QAM	256QAM	64QAM	256QAM	64QAM	256QAM	64QAM	256QAM
Middle CH	-	-	18.26	18.26	37.95	38.21	-	-



FR1 n48 / 20MHz / DFT-S OFDM / Middle Channel / Full RB

PI/2 BPSK

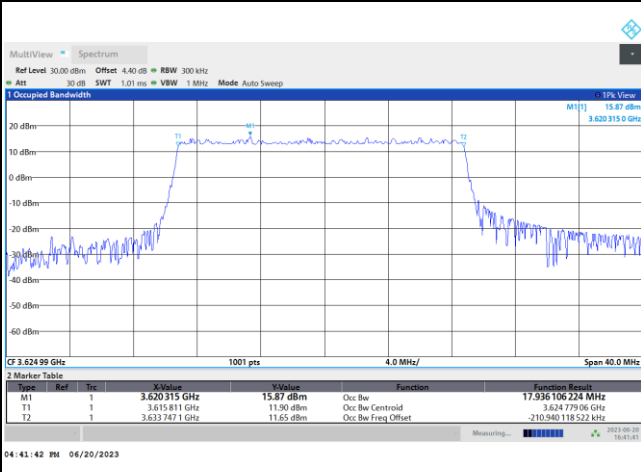

FR1 n48 / 20MHz / CP OFDM / Middle Channel / Full RB

QPSK

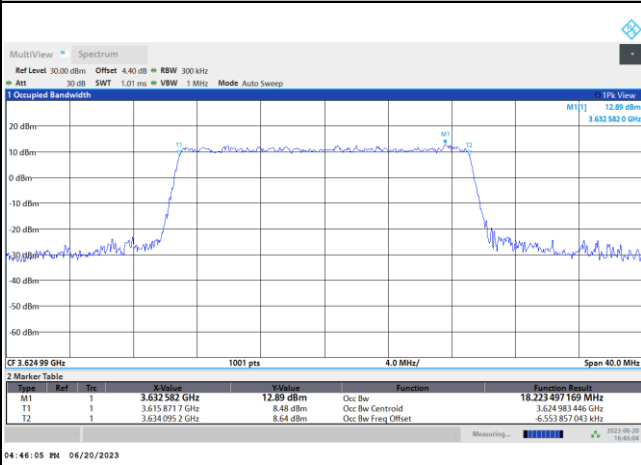

16QAM

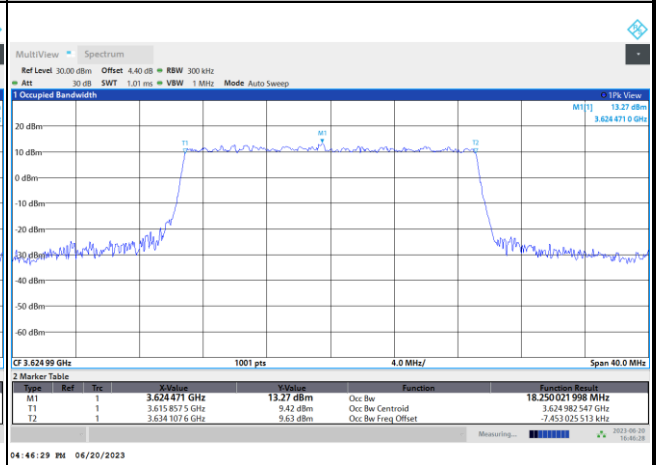

64QAM

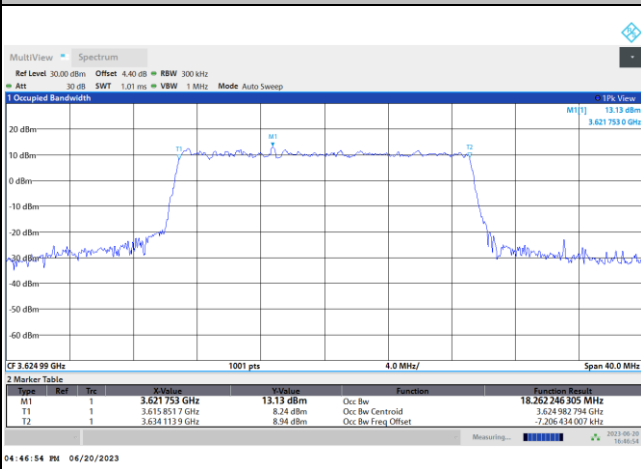

256QAM

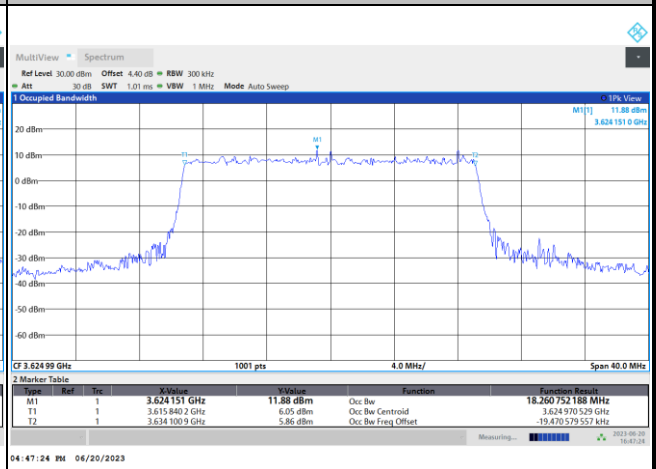





FR1 n48 / 40MHz / DFT-S OFDM / Middle Channel / Full RB

PI/2 BPSK

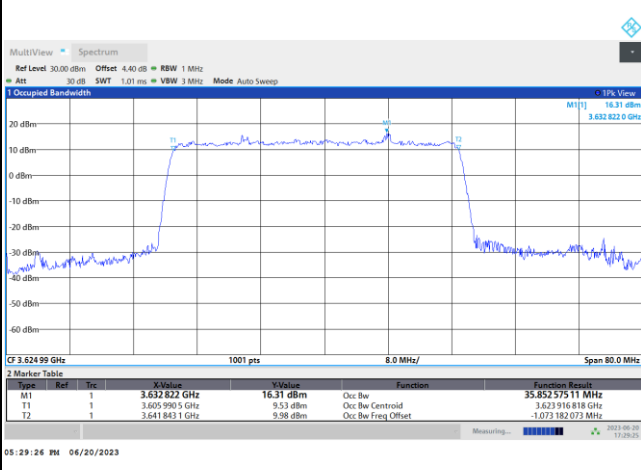

FR1 n48 / 40MHz / CP OFDM / Middle Channel / Full RB

QPSK

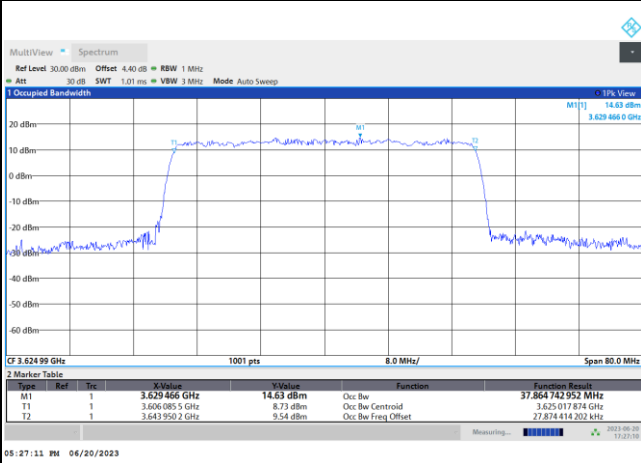

16QAM

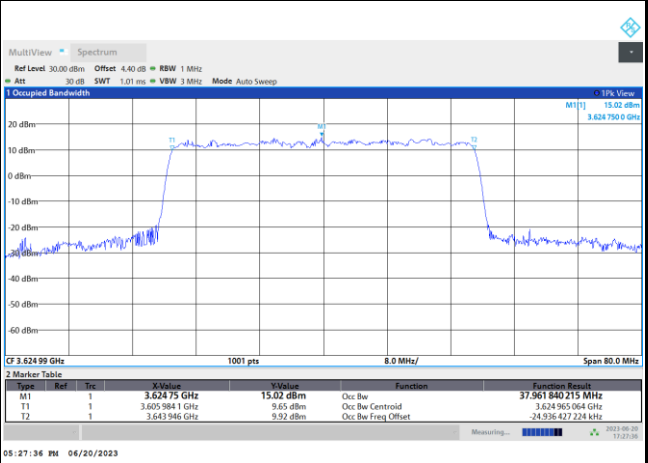

64QAM

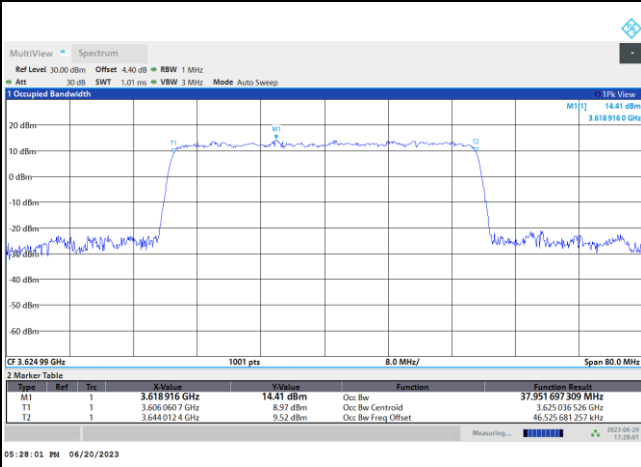

256QAM

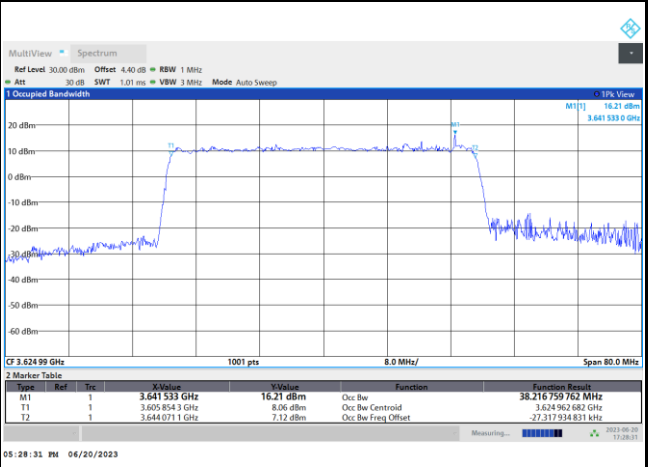



# Unwanted Emission (MASK)

FR1 n48 / 20MHz / DFT-S OFDM / PI/2 BPSK

## Lowest Channel

1RB0

1RBmax

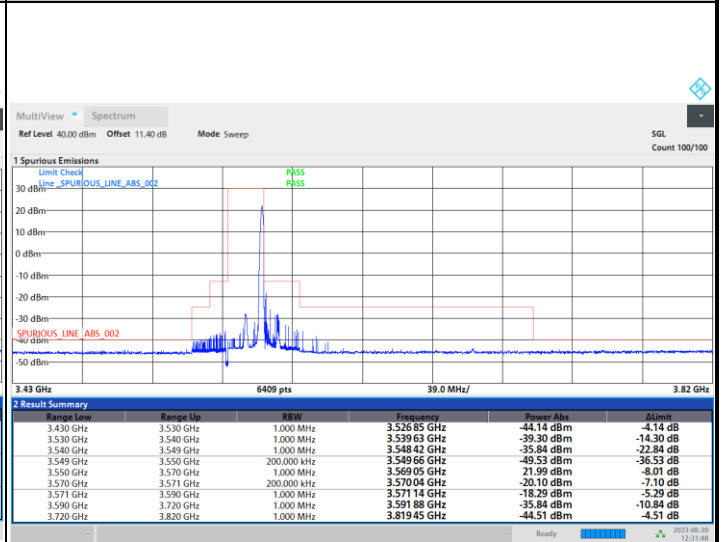
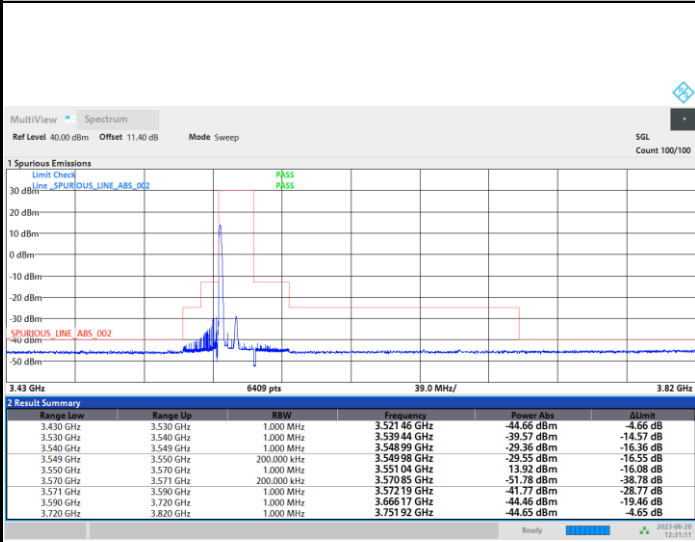

## Full RB

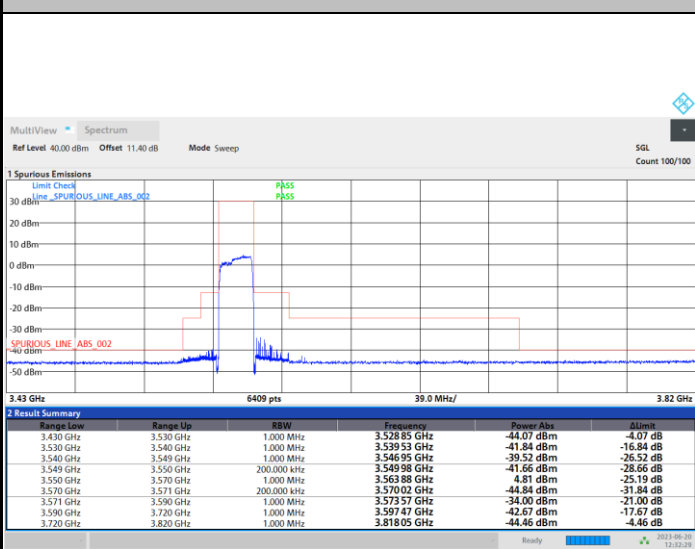



FR1 n48 / 20MHz / DFT-S OFDM / PI/2 BPSK

Middle Channel

1RB0

1RBmax

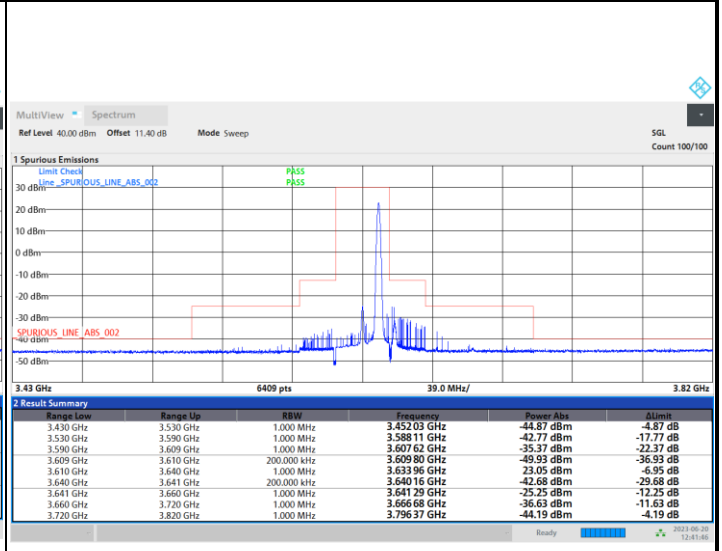
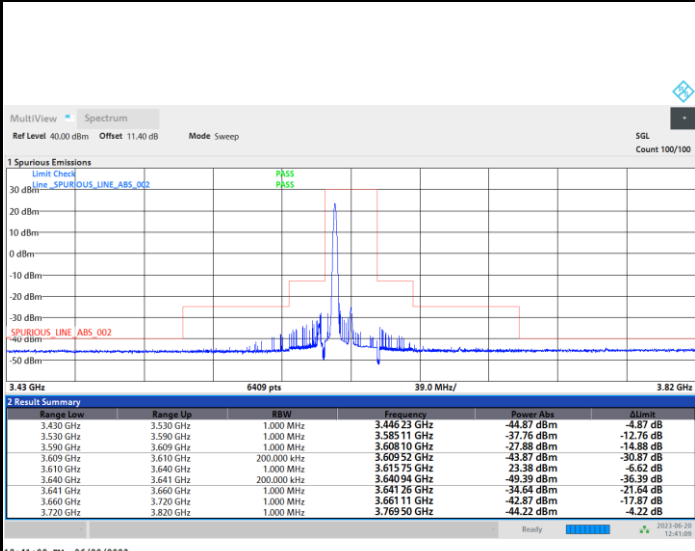

Full RB

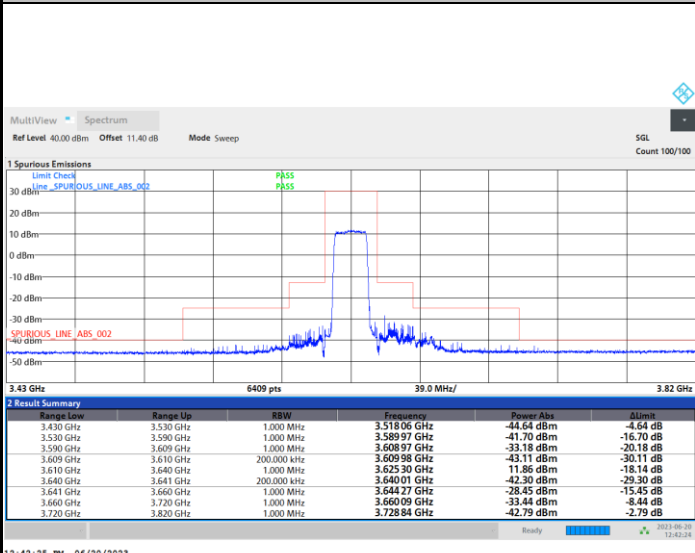



FR1 n48 / 20MHz / DFT-S OFDM / PI/2 BPSK

Highest Channel

1RB0

1RBmax

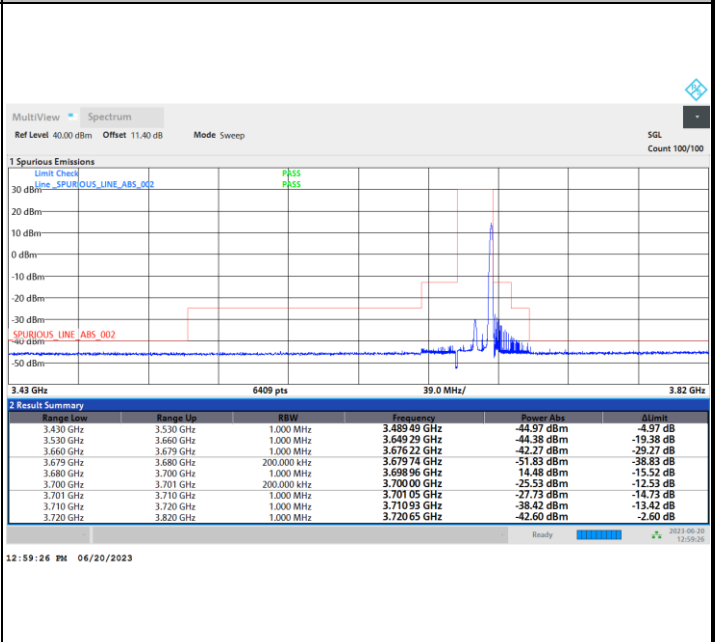
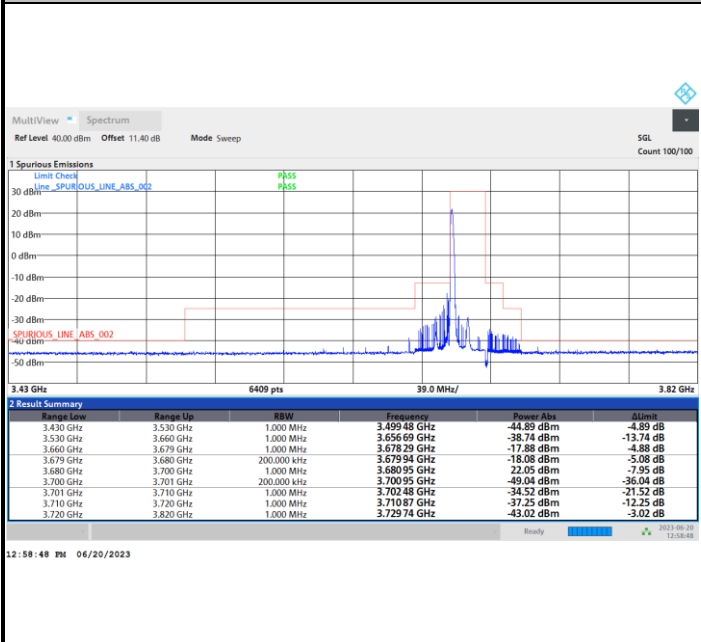

Full RB

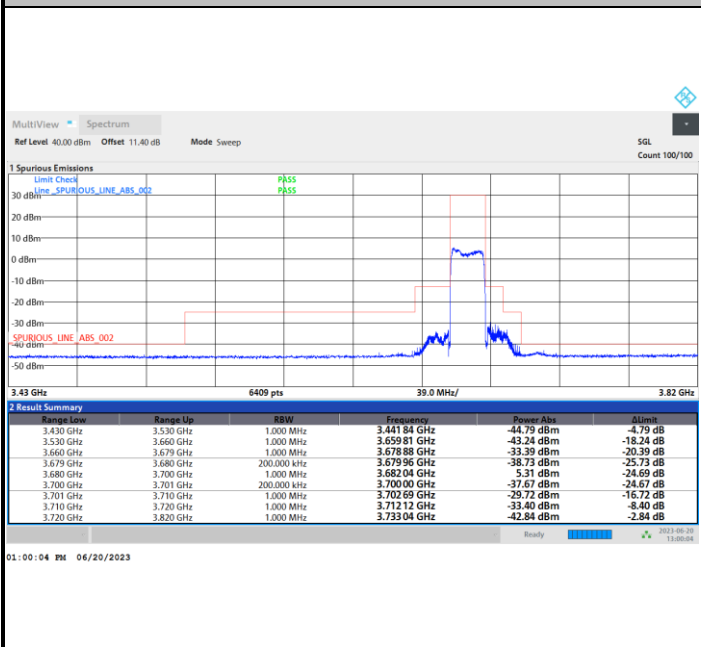



FR1 n48 / 20MHz / DFT-S OFDM / QPSK

Lowest Channel

1RB0

1RBmax

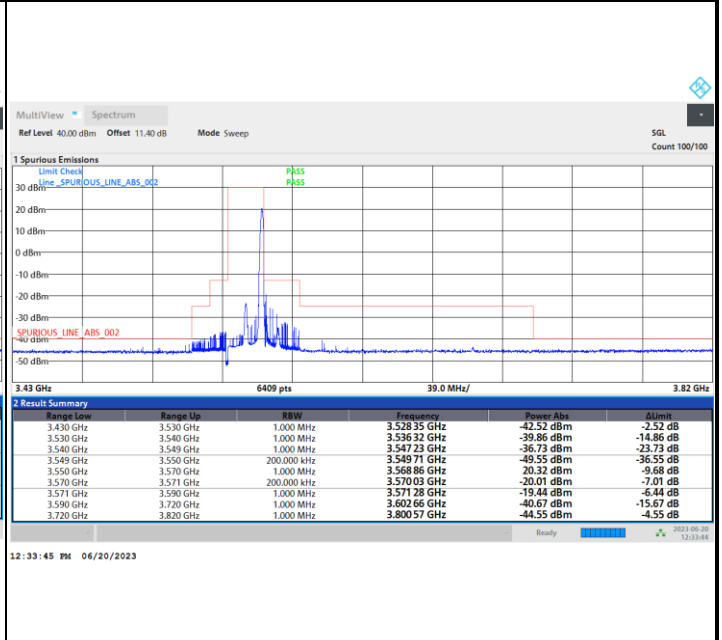
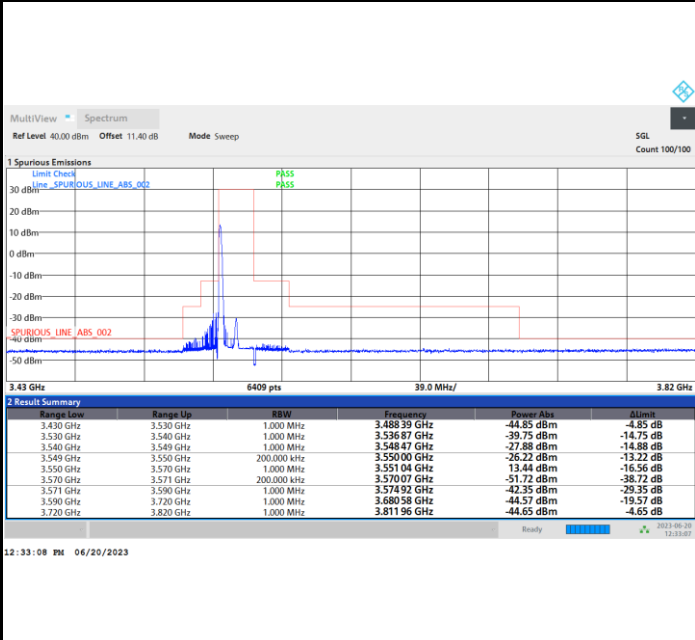

Full RB

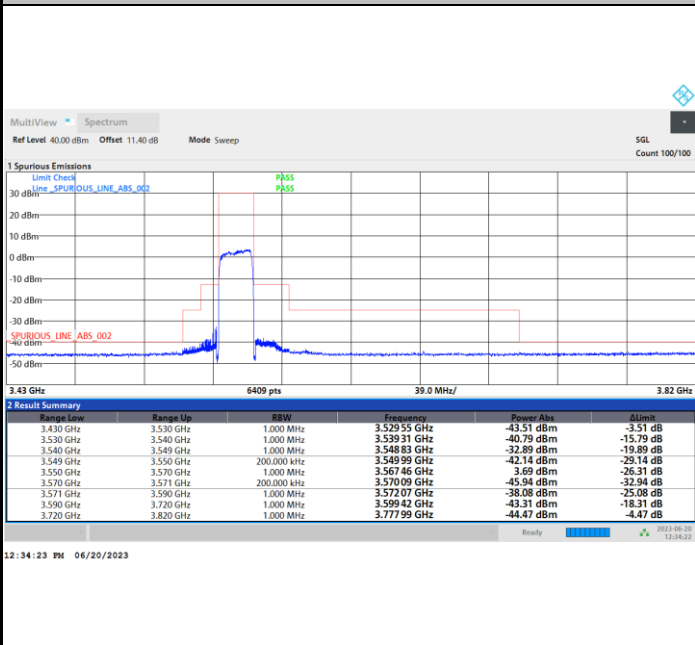



FR1 n48 / 20MHz / DFT-S OFDM / QPSK

Middle Channel

1RB0

1RBmax

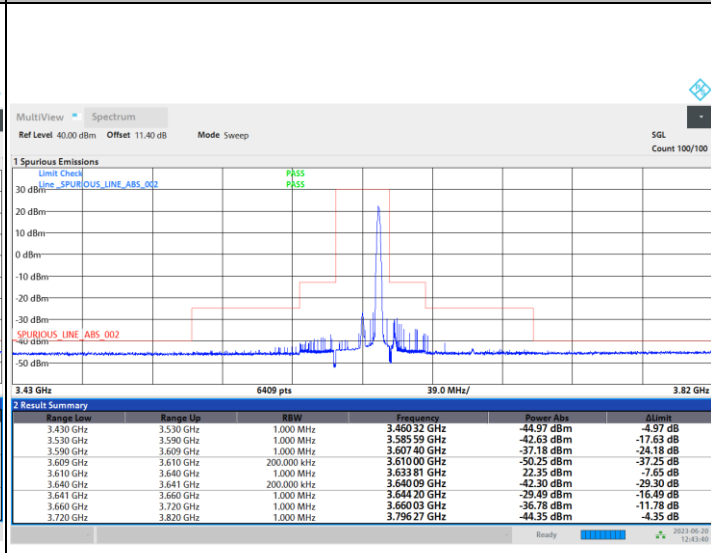
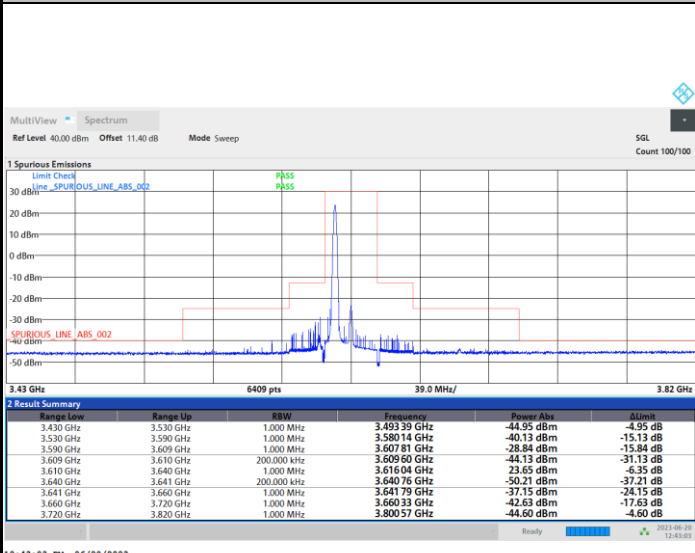

Full RB

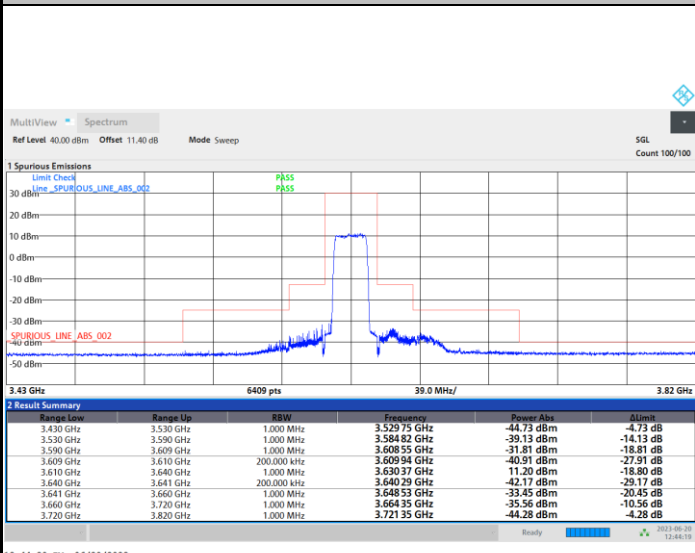



FR1 n48 / 20MHz / DFT-S OFDM / QPSK

Highest Channel

1RB0

1RBmax

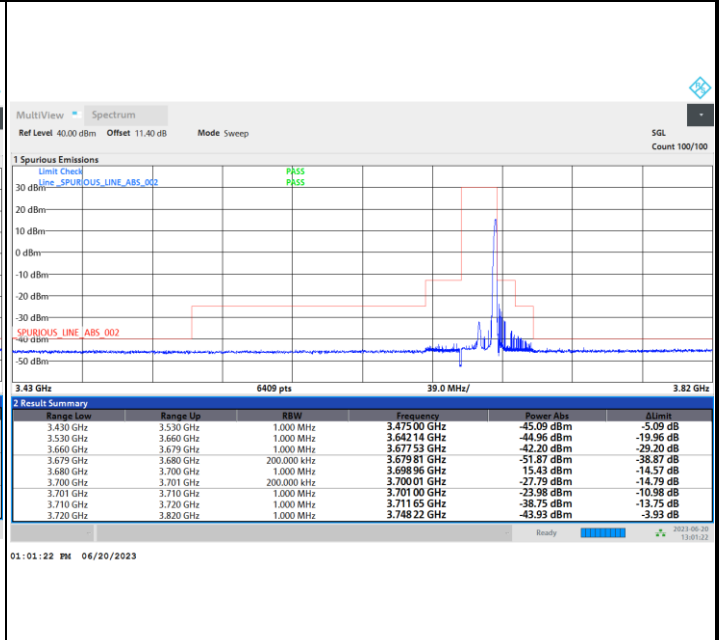
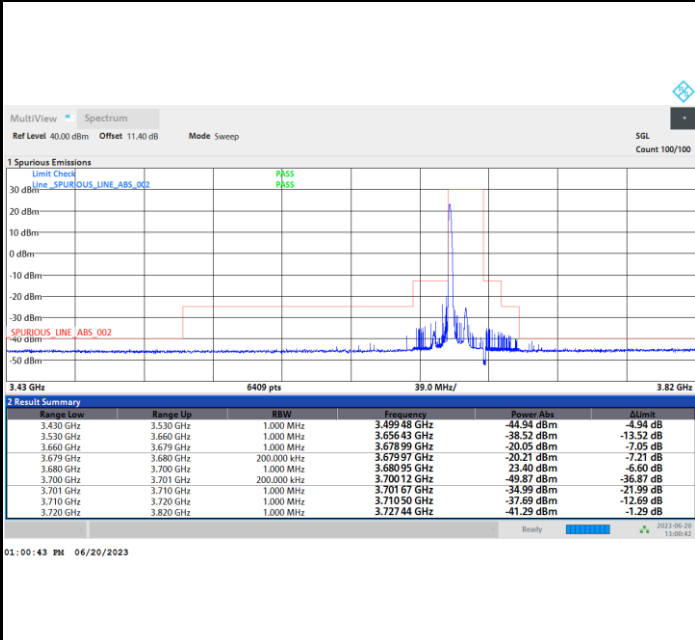

Full RB

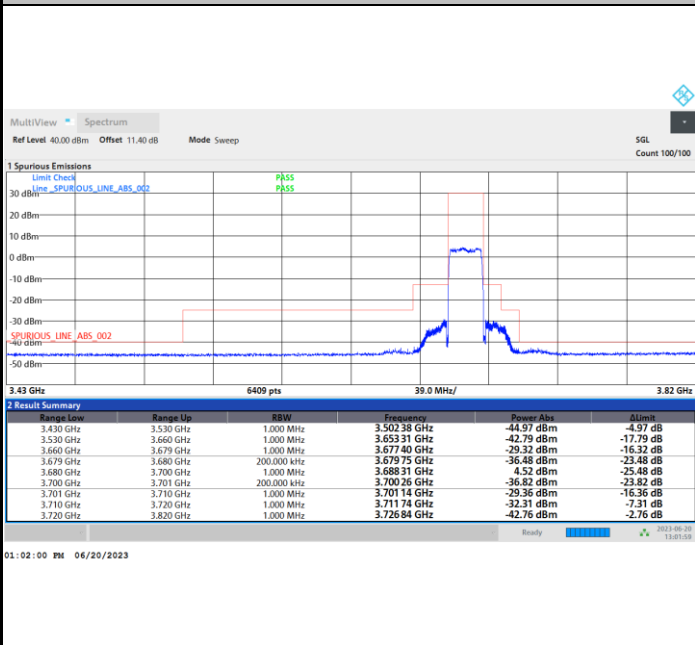



FR1 n48 / 20MHz / DFT-S OFDM / 16QAM

Lowest Channel

1RB0

1RBmax

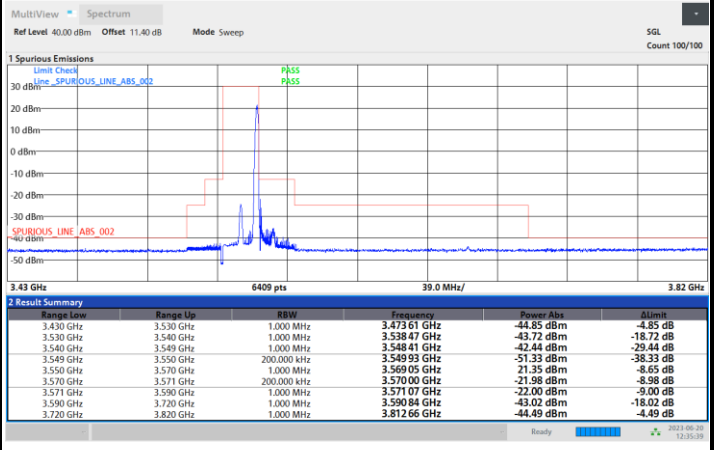
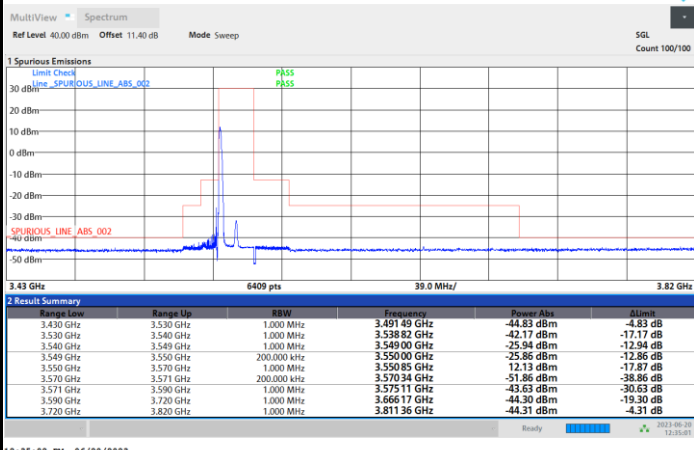

Full RB

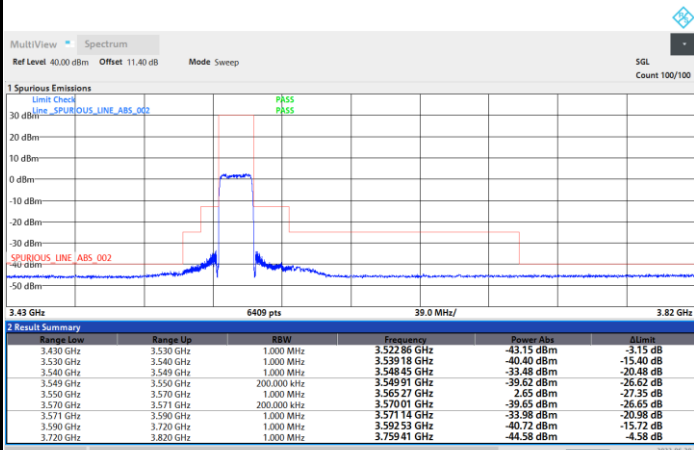





FR1 n48 / 20MHz / DFT-S OFDM / 16QAM

Middle Channel

1RB0

1RBmax

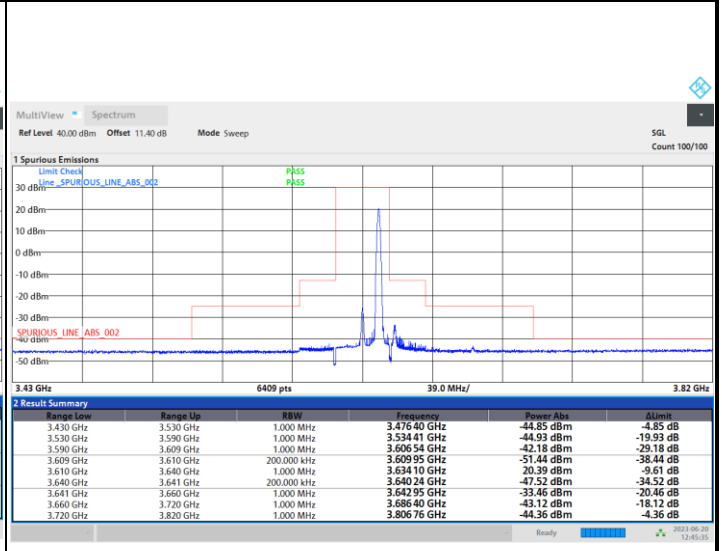
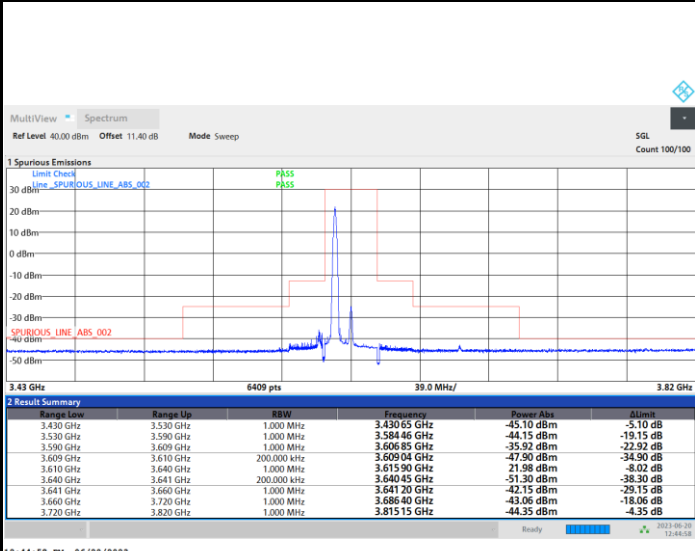

Full RB

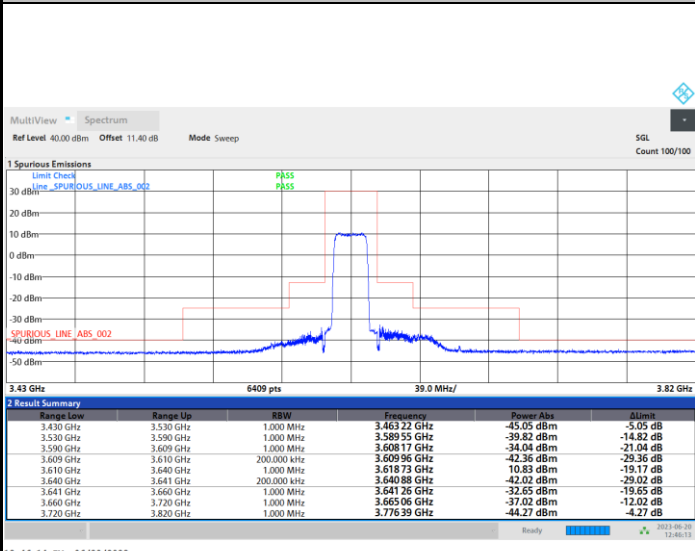



FR1 n48 / 20MHz / DFT-S OFDM / 16QAM

Highest Channel

1RB0

1RBmax

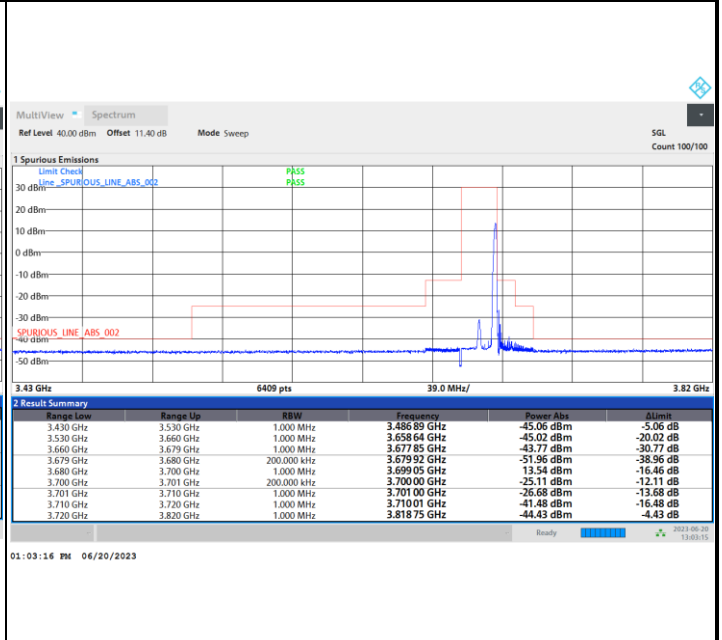
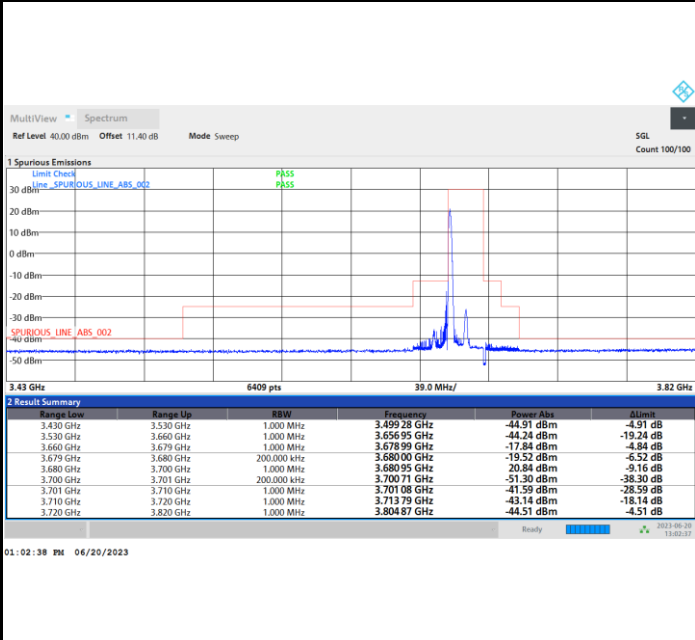

Full RB

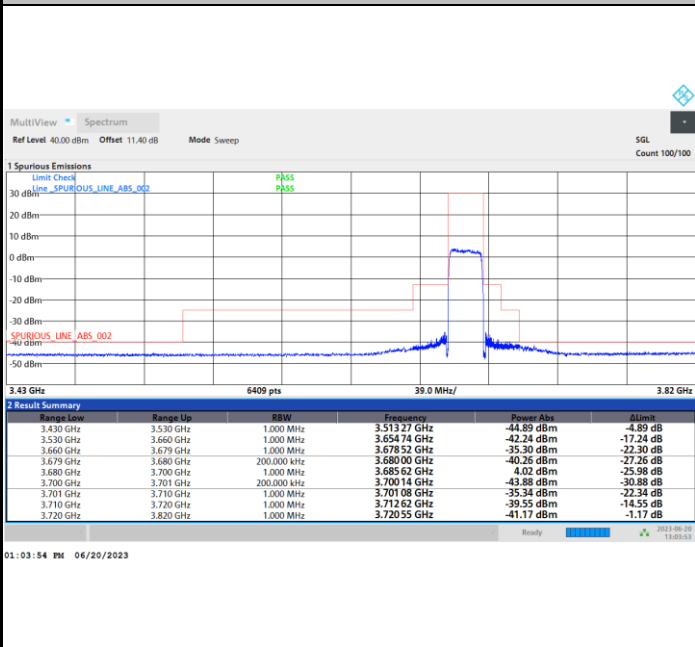



FR1 n48 / 20MHz / DFT-S OFDM / 64QAM

Lowest Channel

1RB0

1RBmax

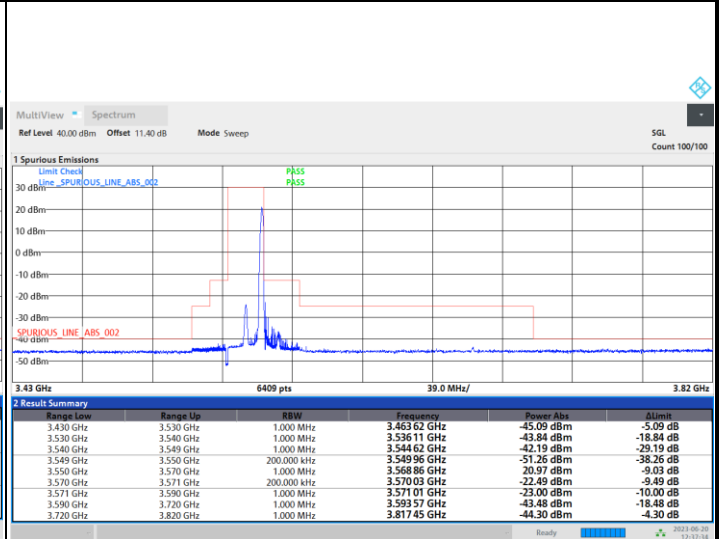
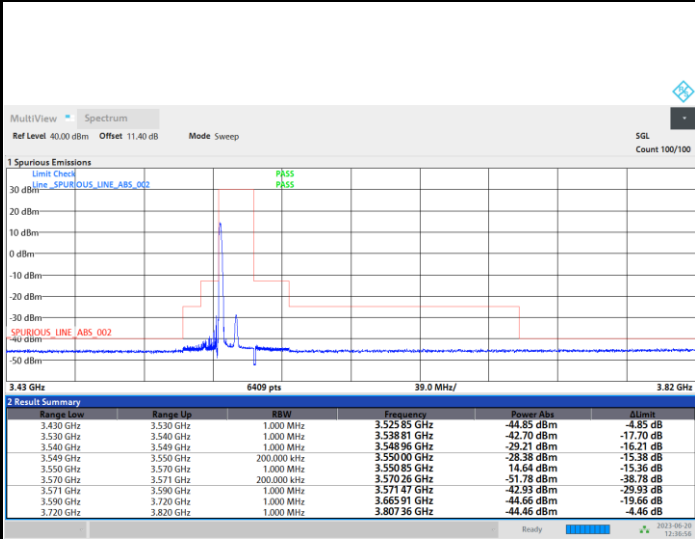

Full RB

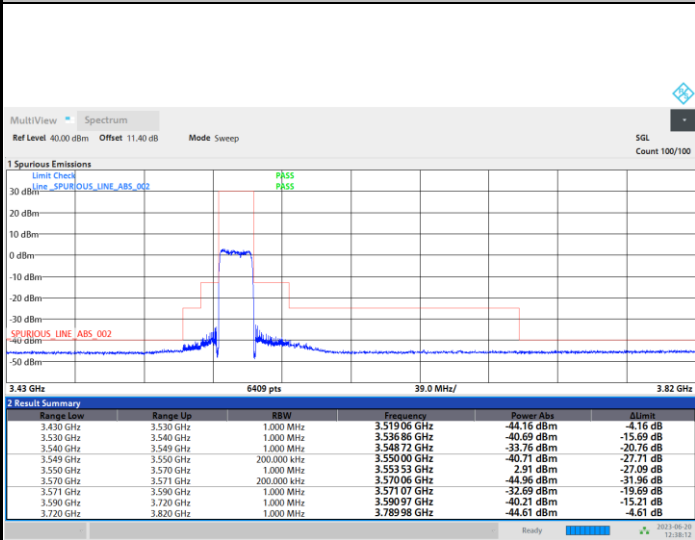



FR1 n48 / 20MHz / DFT-S OFDM / 64QAM

Middle Channel

1RB0

1RBmax

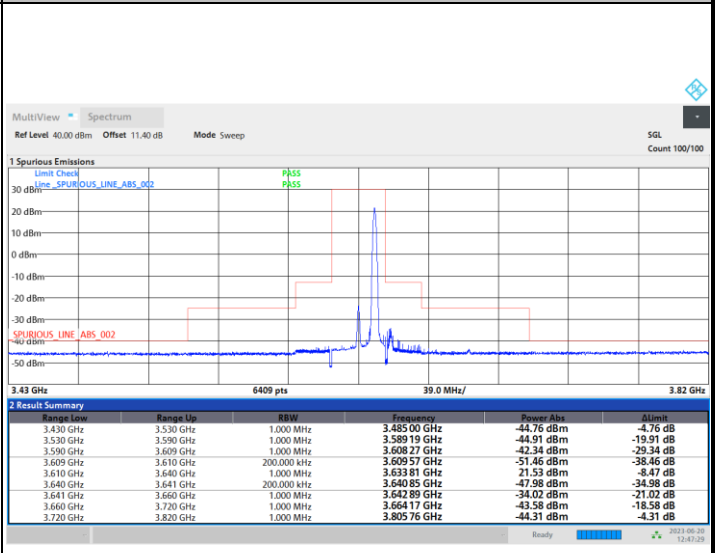
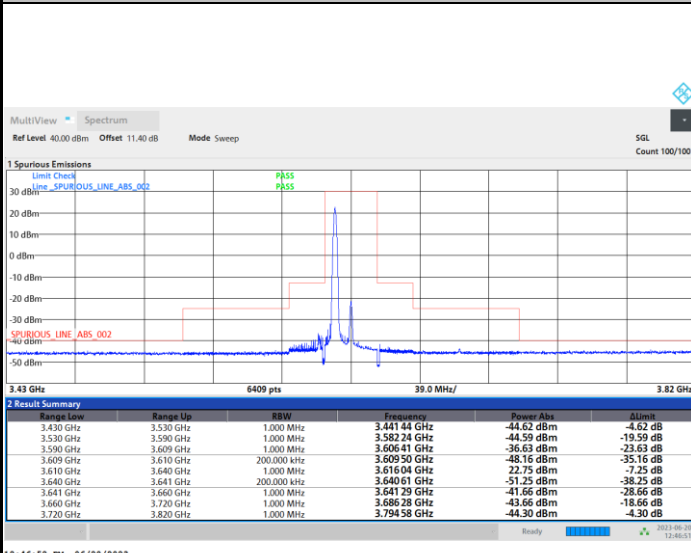

Full RB

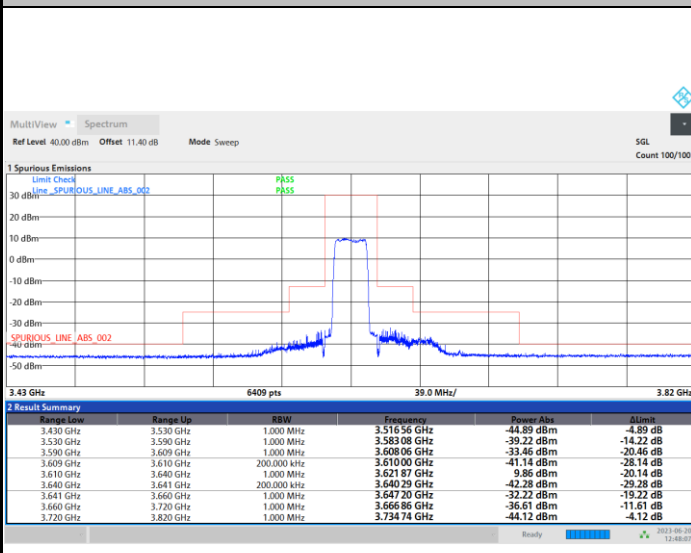



FR1 n48 / 20MHz / DFT-S OFDM / 64QAM

Highest Channel

1RB0

1RBmax

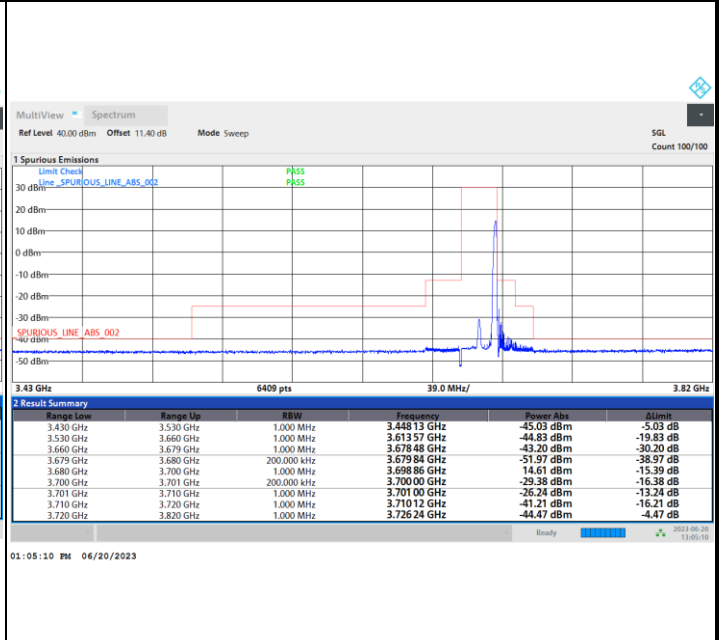
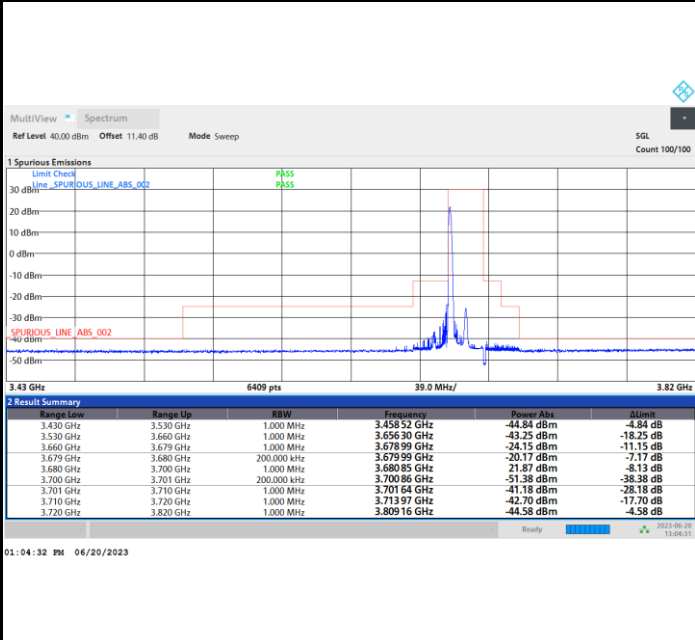

Full RB

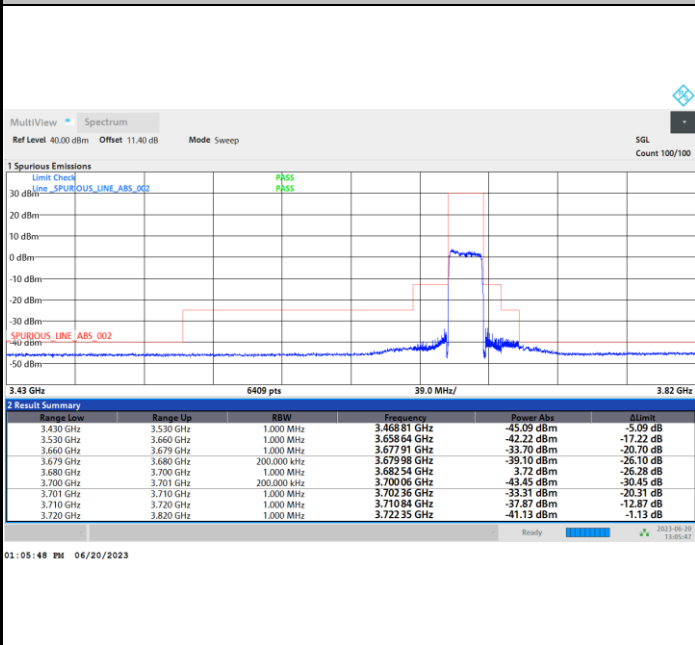



FR1 n48 / 20MHz / DFT-S OFDM / 256QAM

Lowest Channel

1RB0

1RBmax

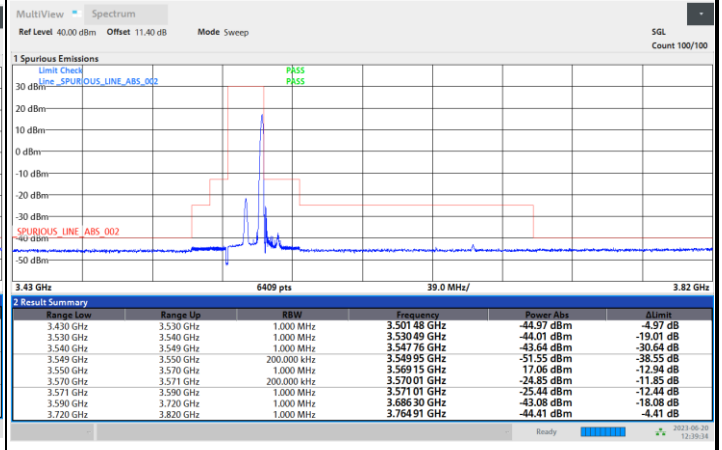
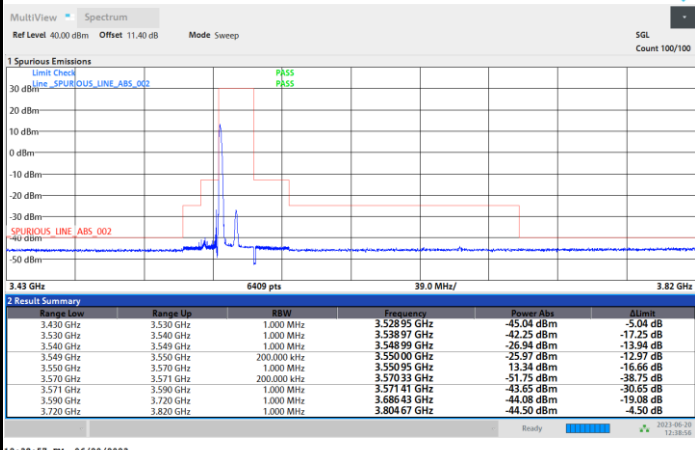

Full RB

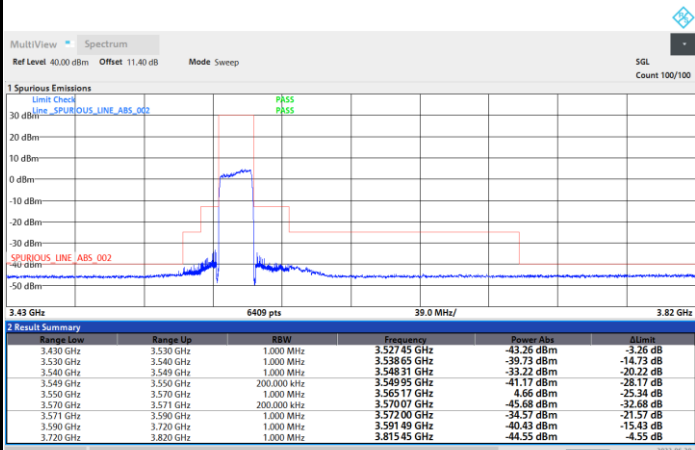



FR1 n48 / 20MHz / DFT-S OFDM / 256QAM

Middle Channel

1RB0

1RBmax

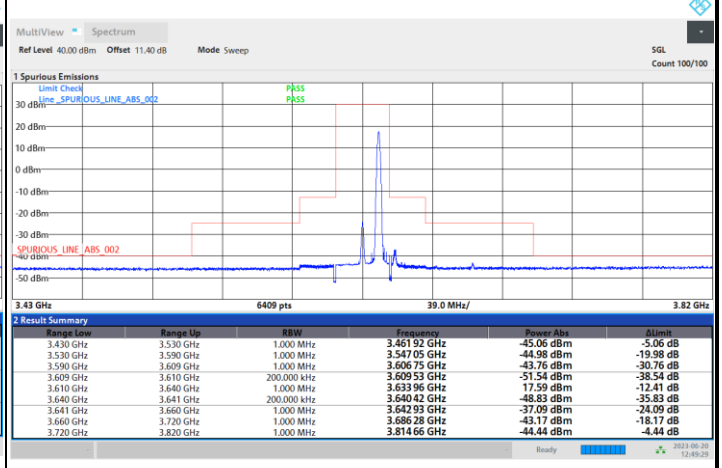
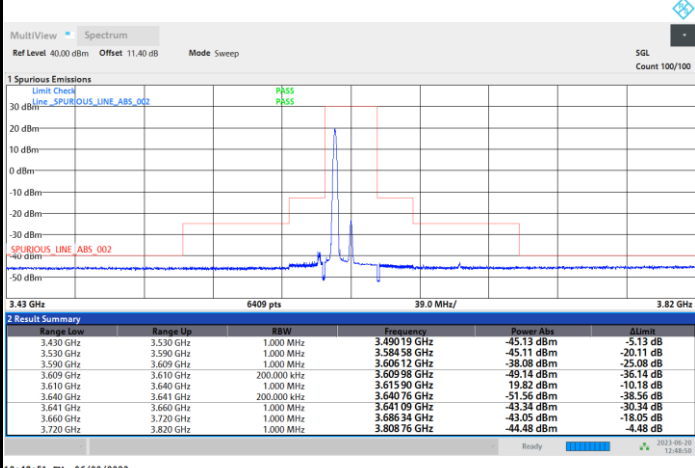

Full RB

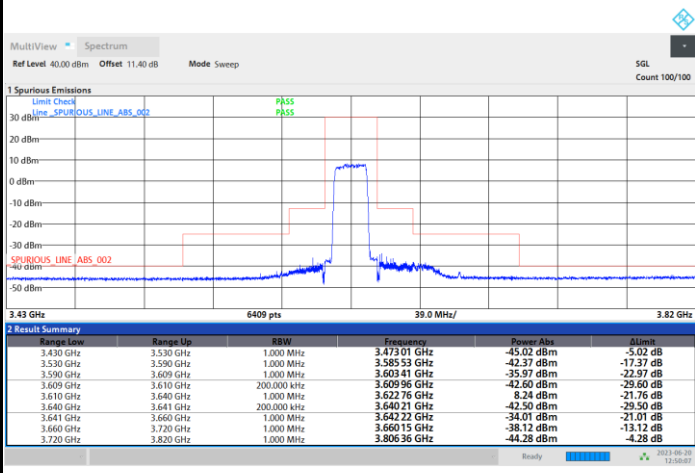



FR1 n48 / 20MHz / DFT-S OFDM / 256QAM

Highest Channel

1RB0

1RBmax

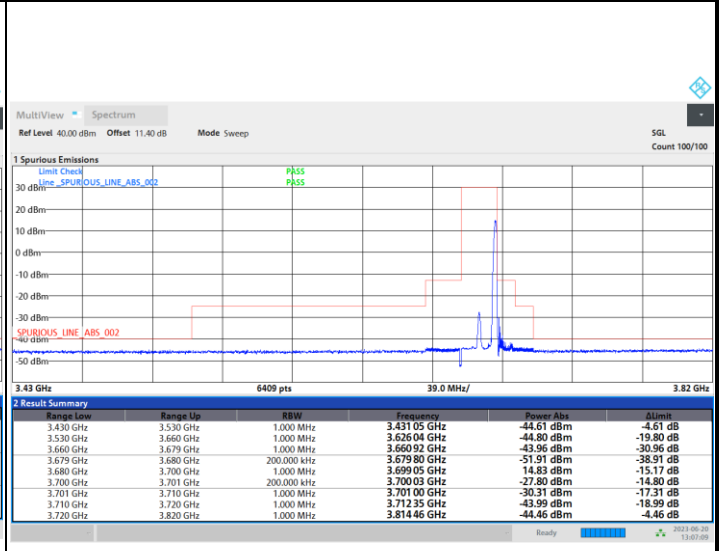
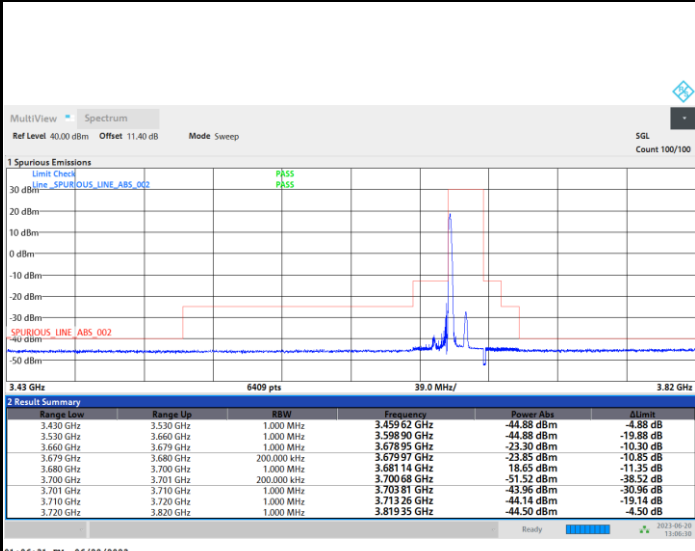

01:06:31 PM 06/20/2023

01:07:09 PM 06/20/2023

Full RB

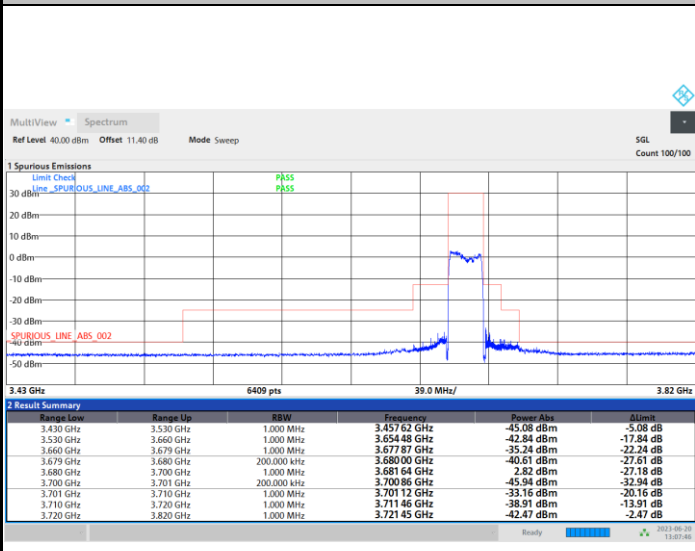

01:07:47 PM 06/20/2023





FR1 n48 / 40MHz / DFT-S OFDM / PI/2 BPSK

Lowest Channel

Full RB

