



FCC RADIO TEST REPORT

FCC ID : GKREXMG1A
Equipment : 5G Module
Brand Name : COMPAL
Model Name : RMM-G1
Applicant : Compal Electronics, Inc.
No.581 & 581-1, Ruiguang Rd., Neihu District,
Taipei, (114) Taiwan
Manufacturer : Compal Electronics, Inc.
No.581 & 581-1, Ruiguang Rd., Neihu District,
Taipei, (114) Taiwan
Standard : FCC 47 CFR Part 2, 22(H), 24(E), 27(L)

The product was received on Apr. 02, 2024 and testing was performed from May 08, 2024 to Jun. 18, 2024. We, Sporton International Inc. EMC & Wireless Communications Laboratory, would like to declare that the tested sample has been evaluated in accordance with the test procedures and has been in compliance with the applicable technical standards.

The test results in this report apply exclusively to the tested model / sample. Without written approval from Sporton International Inc. EMC & Wireless Communications Laboratory, the test report shall not be reproduced except in full.

Louis Wu

Approved by: Louis Wu

Sporton International Inc. EMC & Wireless Communications Laboratory
No. 52, Huaya 1st Rd., Guishan Dist., Taoyuan City 333, Taiwan (R.O.C.)



Table of Contents

History of this test report..... 3

Summary of Test Result..... 4

1 General Description 5

 1.1 Product Feature of Equipment Under Test 5

 1.2 Modification of EUT 5

 1.3 Testing Location 6

 1.4 Applicable Standards 6

2 Test Configuration of Equipment Under Test 7

 2.1 Test Mode..... 7

 2.2 Connection Diagram of Test System 7

 2.3 Support Unit used in test configuration 8

 2.4 Measurement Results Explanation Example 8

 2.5 Frequency List of Low/Middle/High Channels 8

3 Conducted Test Result 9

 3.1 Measuring Instruments 9

 3.2 Conducted Output Power and ERP/EIRP 10

 3.3 Peak-to-Average Ratio 11

 3.4 99% Occupied Bandwidth and 26dB Bandwidth Measurement..... 12

 3.5 Conducted Band Edge 13

 3.6 Conducted Spurious Emission 14

 3.7 Frequency Stability 15

4 Radiated Test Items 16

 4.1 Measuring Instruments 16

 4.2 Test Setup 16

 4.3 Test Result of Radiated Test 17

 4.4 Field Strength of Spurious Radiation Measurement 18

5 List of Measuring Equipment..... 19

6 Measurement Uncertainty 20

Appendix A. Test Results of Conducted Test

Appendix B. Test Results of Radiated Test

Appendix C. Test Setup Photographs



History of this test report

Report No.	Version	Description	Issue Date
FG432920-02A	01	Initial issue of report	Jul. 05, 2024
FG432920-02A	02	Revise Section 1.1 This report is an updated version, replacing the report issued on Jul. 05, 2024.	Jul. 11, 2024



Summary of Test Result

Report Clause	Ref Std. Clause	Test Items	Result (PASS/FAIL)	Remark
3.2	§2.1046	Conducted Output Power	Pass	-
	§22.913 (a)(5)	Effective Radiated Power (WCDMA Band V)		
	§24.232 (c)	Equivalent Isotropic Radiated Power (WCDMA Band II)		
	§27.50 (d)(4)	Equivalent Isotropic Radiated Power (WCDMA Band IV)		
3.3	§24.232 (d)	Peak-to-Average Ratio	Pass	-
3.4	§2.1049	Occupied Bandwidth (WCDMA Band V) (WCDMA Band II) (WCDMA Band IV)	Pass	-
	§22.917 (b)			
	§24.238 (b)			
	§27.53 (g)			
3.5	§2.1051	Band Edge Measurement (WCDMA Band V) (WCDMA Band II) (WCDMA Band IV)	Pass	-
	§22.917 (a)			
	§24.238 (a)			
	§27.53 (g)			
3.6	§2.1051	Conducted Emission (WCDMA Band V) (WCDMA Band II) (WCDMA Band IV)	Pass	-
	§22.917 (a)			
	§24.238 (a)			
	§27.53 (g)			
3.7	§2.1055	Frequency Stability Temperature & Voltage	Pass	-
	§22.355			
	§24.235			
	§27.54			
4.4	§2.1053 §22.917 (a) §24.238 (a) §27.53 (h)	Field Strength of Spurious Radiation (WCDMA Band V) (WCDMA Band II) (WCDMA Band IV)	Pass	31.19 dB under the limit at 7409.00 MHz

Conformity Assessment Condition:

- The test results (PASS/FAIL) with all measurement uncertainty excluded are presented against the regulation limits or in accordance with the requirements stipulated by the applicant/manufacturer who shall bear all the risks of non-compliance that may potentially occur if measurement uncertainty is taken into account.
- The measurement uncertainty please refer to each test result in the section "Measurement Uncertainty".

Disclaimer:

The product specifications of the EUT presented in the test report that may affect the test assessments are declared by the manufacturer who shall take full responsibility for the authenticity.

Reviewed by: Keven Cheng

Report Producer: Ming Chen



1 General Description

1.1 Product Feature of Equipment Under Test

Product Feature	
General Specs WCDMA/LTE/5G NR, and GNSS.	

Support band and evaluated information	
Supported band	Band II, Band IV, Band V
Evaluated and Tested band	Band II, Band IV, Band V

TDD band Power Class		
	PC3	PC2
Band II	V	
Band IV	V	
Band V	V	

Antenna information			
	Band	Model name	Antenna Type
WCDMA	2	4	Monopole
	4	4	Monopole
	5	3	Monopole

Remark: For Radiated spurious emissions, tests were performed using high-gain antennas in monopole and PIFA antennas. the above EUT's information was declared by manufacturer.

RF Exposure							
Max Antenna Gain information(dBi)							
Band	Ant 0						Main Ant. #
WCDMA B2	8						0
WCDMA B4	5						0
WCDMA B5	6						0

Remark: The EUT's information above is declared by manufacturer. Please refer to Disclaimer in report summary.

1.2 Modification of EUT

No modifications made to the EUT during the testing.



1.3 Testing Location

Test Site	Sporton International Inc. EMC & Wireless Communications Laboratory
Test Site Location	No.52, Huaya 1st Rd., Guishan Dist., Taoyuan City 333, Taiwan (R.O.C.) TEL: +886-3-327-3456 FAX: +886-3-328-4978
Test Site No.	Sporton Site No.
	TH03-HY
Test Engineer	Eric Wu
Temperature (°C)	24.6~26.6
Relative Humidity (%)	45.3~47.3

Test Site	Sporton International Inc. Wensan Laboratory
Test Site Location	No.58, Aly. 75, Ln. 564, Wenhua 3rd, Rd., Guishan Dist., Taoyuan City 333010, Taiwan (R.O.C.) TEL: +886-3-327-0868 FAX: +886-3-327-0855
Test Site No.	Sporton Site No.
	03CH16-HY (TAF Code: 3786)
Test Engineer	Bill Chang, Gary Guo and Steven Wu
Temperature (°C)	19.1~22.3
Relative Humidity (%)	62.5~68.3
Remark	The Radiated Spurious Emission test item subcontracted to Sporton International Inc. Wensan Laboratory.

Note: The test site complies with ANSI C63.4 2014 requirement.

FCC Designation No.: TW1190 and TW3786

1.4 Applicable Standards

According to the specifications declared by the manufacturer, the EUT must comply with the requirements of the following standards:

- ♦ ANSI C63.26-2015
- ♦ FCC 47 CFR Part 2, 22(H), 24(E), 27(L)
- ♦ FCC KDB 971168 D01 Power Meas. License Digital Systems v03r01
- ♦ FCC KDB 412172 D01 Determining ERP and EIRP v01r01
- ♦ FCC KDB 414788 D01 Radiated Test Site v01r01

Remark:

1. All the test items were validated and recorded in accordance with the standards without any modification during the testing.
2. This EUT has also been tested and complied with the requirements of FCC Part 15, Subpart B, recorded in a separate test report.
3. The TAF code is not including all the FCC KDB listed without accreditation.

2 Test Configuration of Equipment Under Test

2.1 Test Mode

Antenna port conducted and radiated test items were performed according to KDB 971168 D01 Power Meas. License Digital Systems v03r01 with maximum output power.

For radiated measurement, the measured emission level of the EUT was maximized by rotating the EUT on a turntable, adjusting the orientation of the EUT and EUT antenna in three orthogonal axis (X: flat, Y: portrait, Z: landscape), and adjusting the measurement antenna orientation, following C63.26 exploratory test procedures and only the worst case emissions were reported in this report.

Radiated emissions were investigated as following frequency range:

1. 30 MHz to 9000 MHz for WCDMA Band V
2. 30 MHz to 18000 MHz for WCDMA Band IV
3. 30 MHz to 19100 MHz for WCDMA Band II

All modes, data rates and positions were investigated.

Test modes are chosen to be reported as the worst case configuration below:

Test Modes		
Band	Radiated TCs	Conducted TCs
WCDMA Band V	■ RMC 12.2Kbps Link	■ RMC 12.2Kbps Link
WCDMA Band II	■ RMC 12.2Kbps Link	■ RMC 12.2Kbps Link
WCDMA Band IV	■ RMC 12.2Kbps Link	■ RMC 12.2Kbps Link

2.2 Connection Diagram of Test System

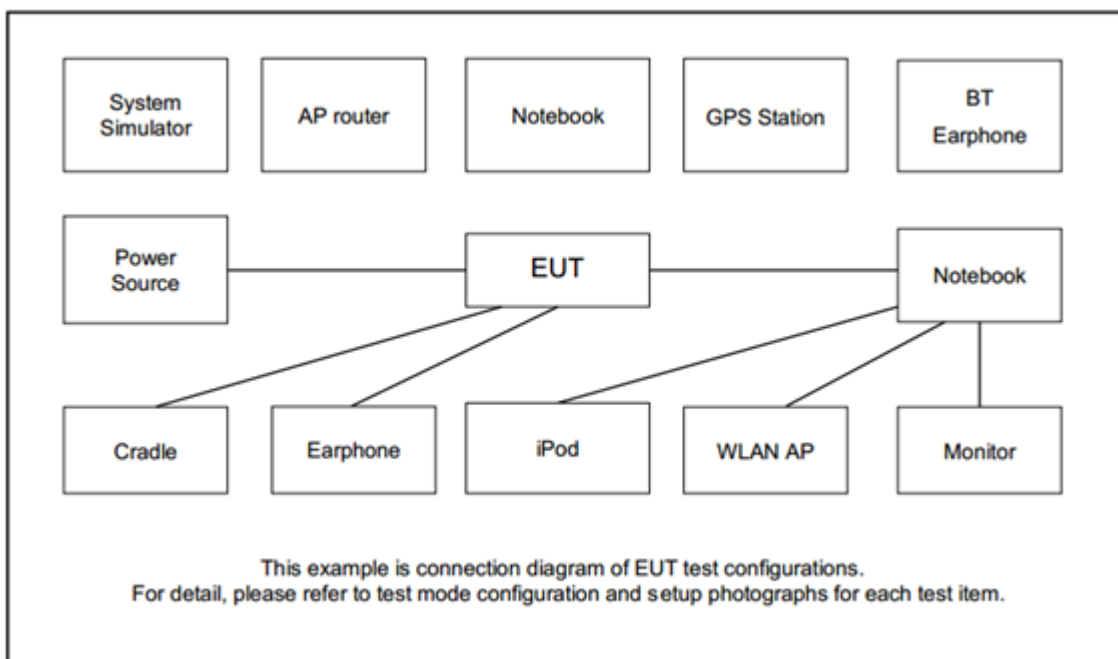



2.3 Support Unit used in test configuration

Item	Equipment	Brand Name	Model No.	FCC ID	Data Cable	Power Cord
1.	System Simulator	Anritsu	MT8000A	N/A	N/A	Unshielded, 1.8 m
2.	System Simulator	Anritsu	MT8821C	N/A	N/A	Unshielded, 1.8 m

2.4 Measurement Results Explanation Example

For all conducted test items:

The offset level is set in the spectrum analyzer to compensate the RF cable loss and attenuator factor between RF conducted output port and spectrum analyzer. With the offset compensation, the spectrum analyzer reading level will be exactly the RF output level.

The spectrum analyzer offset is derived from RF cable loss and attenuator factor.

Offset = RF cable loss + attenuator factor.

The following shows an offset computation example with RF cable loss 4.2 dB and a 10 dB attenuator.

Example:

$$\begin{aligned} \text{Offset(dB)} &= \text{RF cable loss(dB)} + \text{attenuator factor(dB)} \\ &= 4.2 + 10 = 14.2 \text{ (dB)} \end{aligned}$$

2.5 Frequency List of Low/Middle/High Channels

Frequency List				
Band	Channel/Frequency(MHz)	Lowest	Middle	Highest
WCDMA Band V	Channel	4132	4182	4233
	Frequency	826.4	836.4	846.6
WCDMA Band II	Channel	9262	9400	9538
	Frequency	1852.4	1880.0	1907.6
WCDMA Band IV	Channel	1312	1413	1513
	Frequency	1712.4	1732.6	1752.6

3 Conducted Test Result

3.1 Measuring Instruments

Please refer to the measuring equipment list in this test report.

3.1.1 Test Setup

3.1.2 Conducted Output Power

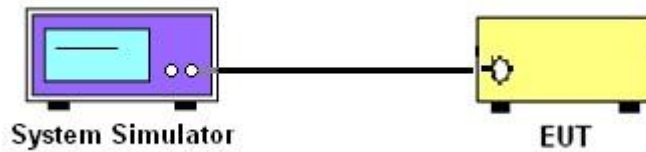

3.1.3 Peak-to-Average Ratio, Occupied Bandwidth, Conducted Band-Edge and Conducted Spurious Emission

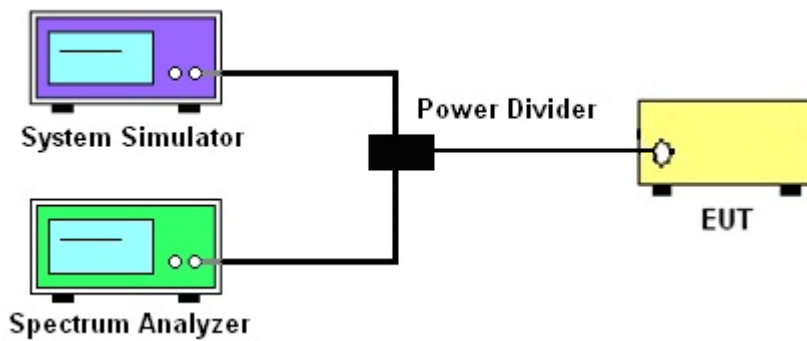

3.1.4 Frequency Stability

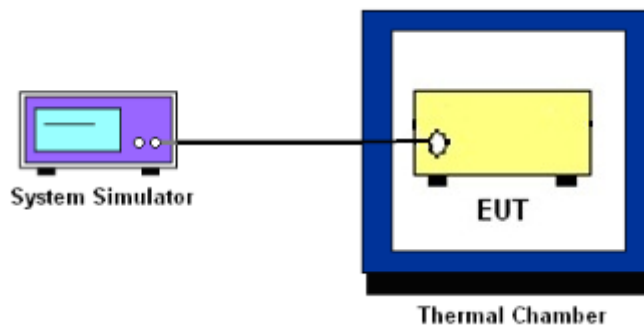

3.1.5 Test Result of Conducted Test

Please refer to Appendix A.



3.2 Conducted Output Power and ERP/EIRP

3.2.1 Description of the Conducted Output Power and ERP/EIRP

A system simulator was used to establish communication with the EUT. Its parameters were set to enforce EUT transmitting at the maximum power. The measured power in the radio frequency on the transmitter output terminals shall be reported.

The ERP of mobile transmitters must not exceed 7 Watts for WCDMA Band V

The EIRP of mobile transmitters must not exceed 2 Watts for WCDMA Band II

The EIRP of mobile transmitters must not exceed 1 Watts for WCDMA Band IV

According to KDB 412172 D01 Power Approach,

$EIRP = P_T + G_T - L_C$, $ERP = EIRP - 2.15$, where

P_T = transmitter output power in dBm

G_T = gain of the transmitting antenna in dBi

L_C = signal attenuation in the connecting cable between the transmitter and antenna in dB

3.2.2 Test Procedures

1. The transmitter output port is connected to the system simulator.
2. Set EUT at maximum power through system simulator.
3. Select the lowest, middle, and the highest channels for each band and different modulation.
4. Measure the maximum burst average power for GSM and maximum average power for other modulation signal.



3.3 Peak-to-Average Ratio

3.3.1 Description of the PAR Measurement

The peak-to-average ratio (PAR) of the transmission may not exceed 13 dB.

3.3.2 Test Procedures

The testing follows ANSI C63.26-2015 Section 5.2.6

1. The EUT is connected to spectrum analyzer and system simulator via a power divider.
2. Set EUT to transmit at maximum output power.
3. When the duty cycle is less than 98%, then signal gating will be implemented on the spectrum analyzer by triggering from the system simulator.
4. Set the CCDF (Complementary Cumulative Distribution Function) option of the spectrum analyzer.
5. Record the maximum PAPR level associated with a probability of 0.1%.



3.4 99% Occupied Bandwidth and 26dB Bandwidth Measurement

3.4.1 Description of 99% Occupied Bandwidth and 26dB Bandwidth Measurement

The occupied bandwidth is the width of a frequency band such that, below the lower and above the upper frequency limits, the mean powers emitted are each equal to a specified percentage 0.5% of the total mean transmitted power.

The 26 dB emission bandwidth is defined as the frequency range between two points, one above and one below the carrier frequency, at which the spectral density of the emission is attenuated 26 dB below the maximum in-band spectral density of the modulated signal. Spectral density (power per unit bandwidth) is to be measured with a detector of resolution bandwidth equal to approximately 1.0% of the emission bandwidth.

3.4.2 Test Procedures

The testing follows ANSI C63.26-2015 Section 5.4.3 (26dB) and Section 5.4.4 (99OB)

1. The EUT is connected to spectrum analyzer and system simulator via a power divider.
2. The spectrum analyzer center frequency is set to the nominal EUT channel center frequency. The span range for the spectrum analyzer shall be between two and five times the anticipated OBW.
3. The nominal resolution bandwidth (RBW) shall be in the range of 1 to 5 % of the anticipated OBW, and the VBW shall be at least 3 times the RBW.
4. Set the detection mode to peak, and the trace mode to max hold.
5. Determine the reference value: Set the EUT to transmit a modulated signal. Allow the trace to stabilize. Set the spectrum analyzer marker to the highest level of the displayed trace.
(This is the reference value)
6. Determine the “-26 dB down amplitude” as equal to (Reference Value – X).
7. Place two markers, one at the lowest and the other at the highest frequency of the envelope of the spectral display such that each marker is at or slightly below the “-X dB down amplitude” determined in step 6. If a marker is below this “-X dB down amplitude” value it shall be placed as close as possible to this value. The OBW is the positive frequency difference between the two markers.
8. Use the 99 % power bandwidth function of the spectrum analyzer and report the measured bandwidth.



3.5 Conducted Band Edge

3.5.1 Description of Conducted Band Edge Measurement

The power of any emission outside of the authorized operating frequency ranges must be lower than the transmitter power (P) by a factor of at least $43 + 10 \log (P)$ dB.

3.5.2 Test Procedures

The testing follows FCC KDB 971168 D01 v03r01 Section 6.1.

1. The EUT is connected to the spectrum analyzer and system simulator via a power divider.
2. The RF output of EUT is connected to the spectrum analyzer by an RF cable and attenuator. The path loss is compensated to the results for each measurement.
3. The band edges of low and high channels for the highest RF powers are measured.
4. The RF fundamental frequency shall be excluded against the limit line in the operating frequency band.
5. The limit line is derived from $43 + 10\log(P)$ dB below the transmitter power P(Watts)



3.6 Conducted Spurious Emission

3.6.1 Description of Conducted Spurious Emission Measurement

The power of any emission outside of the authorized operating frequency ranges must be lower than the transmitter power (P) by a factor of at least $43 + 10 \log (P)$ dB.

It is measured by means of a calibrated spectrum analyzer and scanned from 30 MHz up to a frequency including its 10th harmonic.

3.6.2 Test Procedures

The testing follows FCC KDB 971168 D01 v03r01 Section 6.1.

1. The EUT is connected to the spectrum analyzer and system simulator via a power divider.
2. The RF output of EUT is connected to the spectrum analyzer by an RF cable and attenuator. The path loss is compensated to the results for each measurement.
3. The middle channel for the highest RF power within the transmitting frequency is measured.
4. The conducted spurious emission for the whole frequency range is taken.
5. The RF fundamental frequency shall be excluded against the limit line in the operating frequency band.
6. The limit line is derived from $43 + 10\log(P)$ dB below the transmitter power P(Watts)



3.7 Frequency Stability

3.7.1 Description of Frequency Stability Measurement

22.355

The frequency stability shall be measured by variation of ambient temperature and variation of primary supply voltage to ensure that the fundamental emission stays within the authorized frequency block. The frequency stability of the transmitter shall be maintained within $\pm 0.00025\%$ ($\pm 2.5\text{ppm}$) of the center frequency.

24.235 & 27.54

The frequency stability shall be sufficient to ensure that the fundamental emission stays within the authorized frequency block.

3.7.2 Test Procedures for Temperature Variation

The testing follows FCC KDB 971168 D01 v03r01 Section 9.0.

1. The EUT is set up in the thermal chamber and connected with the system simulator.
2. With power OFF, the temperature is decreased to -30°C and the EUT is stabilized before testing. Power is applied and the maximum change in frequency is recorded within one minute.
3. With power OFF, the temperature is raised in 10°C steps up to 50°C . The EUT is stabilized at each step for at least half an hour. Power is applied and the maximum frequency change is recorded within one minute.

3.7.3 Test Procedures for Voltage Variation

The testing follows FCC KDB 971168 D01 v03r01 Section 9.0.

1. The EUT is placed in a temperature chamber at $20\pm 5^{\circ}\text{C}$ and connected with the system simulator.
2. The power supply voltage to the EUT is varied from 85% to 115% of the nominal value measured at the input to the EUT.
3. The variation in frequency is measured for the worst case.

4 Radiated Test Items

4.1 Measuring Instruments

Please refer to the measuring equipment list in this test report.

4.2 Test Setup

For radiated test below 30MHz

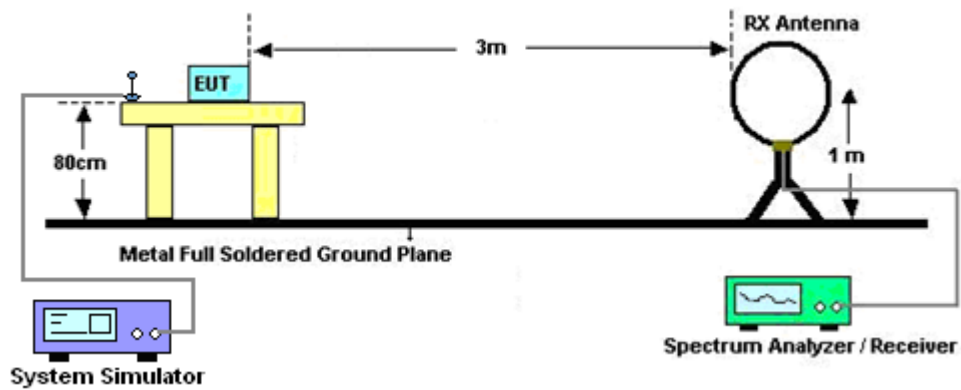

For radiated test from 30MHz to 1GHz

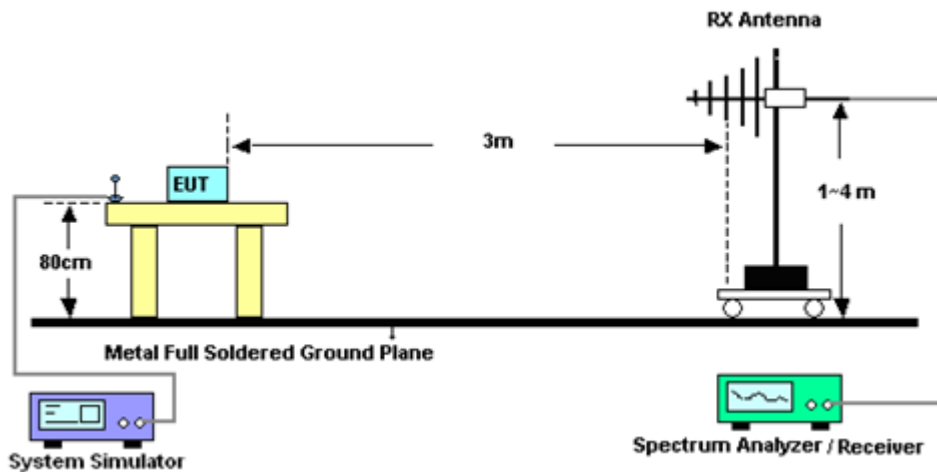

For radiated test from 1GHz to 18GHz

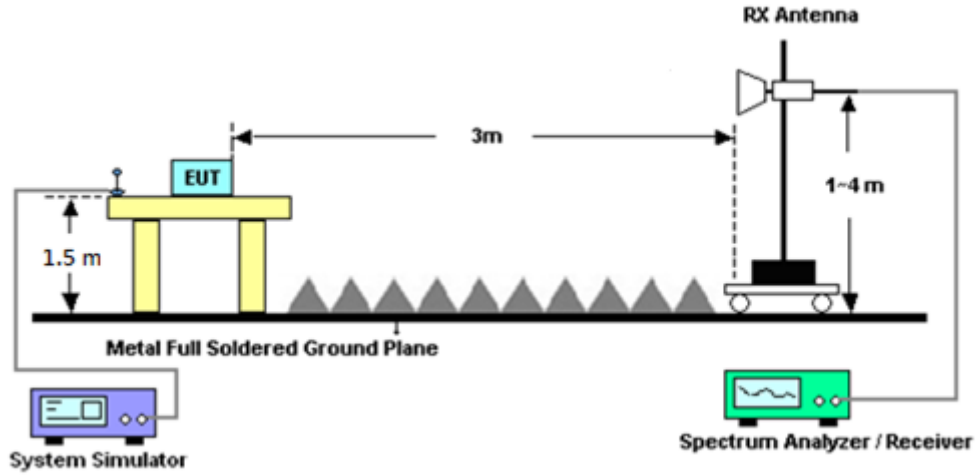

For radiated test above 18GHz

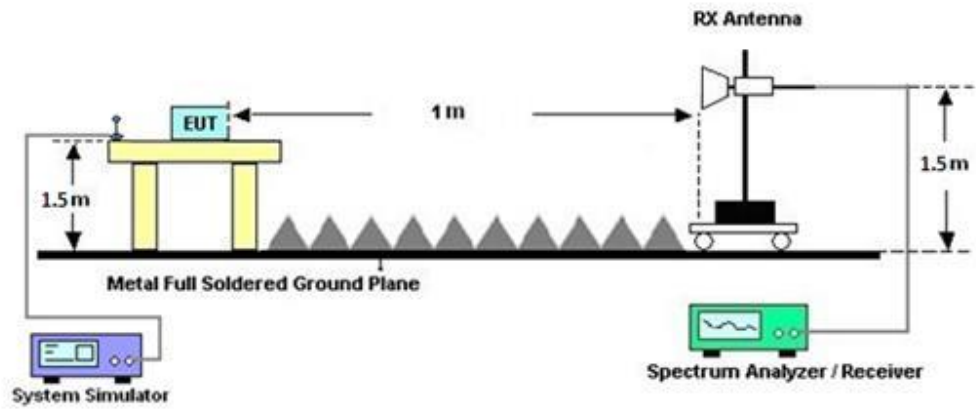

4.3 Test Result of Radiated Test

Please refer to Appendix B.

Note:

The low frequency, which starts from 9 kHz to 30 MHz, is pre-scanned and the result which is 20 dB lower than the limit line is not reported.

There is adequate comparison measurement of both open-field test site and alternative test site - semi-Anechoic chamber according to 414788 D01 Radiated Test Site v01r01, and the result came out very similar.



4.4 Field Strength of Spurious Radiation Measurement

4.4.1 Description of Field Strength of Spurious Radiated Measurement

The power of any emission outside of the authorized operating frequency ranges must be attenuated below the transmitter power (P) by a factor of at least $43 + 10 \log (P)$ dB. The spectrum is scanned from 30 MHz up to a frequency including its 10th harmonic.

4.4.2 Test Procedures

The testing follows FCC KDB 971168 D01 v03r01 Section 7 and ANSI C63.26-2015 section 5.5.4 Radiated measurement using the field strength method.

1. The EUT is placed on a rotatable wooden table 0.8 meters for frequency below 1 GHz and 1.5 meter for frequency above 1 GHz above the ground.
2. The EUT is set 3 meters away from the receiving antenna, which is mounted on the antenna tower.
3. The table is rotated 360 degrees to determine the position of the highest spurious emission.
4. The height of the receiving antenna is varied between one meter and four meters to search for the maximum spurious emission for both horizontal and vertical polarizations.
5. Make the measurement with the spectrum analyzer's RBW = 1 MHz, VBW = 3 MHz, taking record of maximum spurious emission.
6. To convert spectrum reading E(dBuV/m) to EIRP(dBm)
$$\text{EIRP(dBm)} = \text{Level (dBuV/m)} + 20\log(d) - 104.77,$$
where d is the distance at which field strength limit is specified in the rules
7. Field Strength Level (dBm) = Spectrum Reading (dBm) + Antenna Factor + Cable Loss + Read Level - Preamp Factor.
8. ERP (dBm) = EIRP (dBm) - 2.15
9. The RF fundamental frequency shall be excluded against the limit line in the operating frequency band.
10. The limit line is derived from $43 + 10\log(P)$ dB below the transmitter power P(Watts)



5 List of Measuring Equipment

Instrument	Brand Name	Model No.	Serial No.	Characteristics	Calibration Date	Test Date	Due Date	Remark
Loop Antenna	Rohde & Schwarz	HFH2-Z2	100488	9 kHz~30 MHz	Sep. 12, 2023	May 08, 2024~ Jun. 18, 2024	Sep. 11, 2024	Radiation (03CH16-HY)
SHF-EHF Horn Antenna	SCHWARZBECK	BBHA9170	00993	18GHz-40GHz	Nov. 24, 2023	May 08, 2024~ Jun. 18, 2024	Nov. 23, 2024	Radiation (03CH16-HY)
Bilog Antenna	TESEQ	CBL 6111D & 00802N1D01N -06	47020 & 06	30MHz to 1GHz	Oct. 07, 2023	May 08, 2024~ Jun. 18, 2024	Oct. 06, 2024	Radiation (03CH16-HY)
Horn Antenna	SCHWARZBECK	BBHA 9120 D	9120D-1522	1G~18GHz	Mar. 28, 2024	May 08, 2024~ Jun. 18, 2024	Mar. 27, 2025	Radiation (03CH16-HY)
Amplifier	SONOMA	310N	371607	9kHz~1GHz	Jul. 03, 2023	May 08, 2024~ Jun. 18, 2024	Jul. 02, 2024	Radiation (03CH16-HY)
Preamplifier	Keysight	83017A	MY53270264	1GHz~26.5GHz	Dec. 07, 2023	May 08, 2024~ Jun. 18, 2024	Dec. 06, 2024	Radiation (03CH16-HY)
Preamplifier	EMEC	EM1G18G	060812	1GHz~18GHz	Dec. 25, 2023	May 08, 2024~ Jun. 18, 2024	Dec. 24, 2024	Radiation (03CH16-HY)
Preamplifier	EMEC	EM18G40G	060872	18GHz~40GHz	Sep. 06, 2023	May 08, 2024~ Jun. 18, 2024	Sep. 05, 2024	Radiation (03CH16-HY)
Filter	Wainwright	WLK4-1000-15 30-8000-40SS	SN17	1.53GHz Low Pass Filter	Jan. 15, 2024	May 08, 2024~ Jun. 18, 2024	Jan. 14, 2025	Radiation (03CH16-HY)
Filter	Wainwright	WHKX12-900- 1000-15000-60 SS	SN11	1GHz High Pass Filter	Mar. 13, 2024	May 08, 2024~ Jun. 18, 2024	Mar. 12, 2025	Radiation (03CH16-HY)
Filter	Wainwright	WHKX12-2700 -3000-18000-6 0ST	SN3	3GHz High Pass Filter	Jun. 29, 2023	May 08, 2024~ Jun. 18, 2024	Jun. 28, 2024	Radiation (03CH16-HY)
Filter	Wainwright	WHKX8-5872. 5-6750-18000- 40ST	SN27	6.75GHz High Pass Filter	Nov. 13, 2023	May 08, 2024~ Jun. 18, 2024	Nov. 12, 2024	Radiation (03CH16-HY)
RF Cable	HUBER + SUHNER	SUCOFLEX 102	803951/2	9K~30M	Mar. 06, 2024	May 08, 2024~ Jun. 18, 2024	Mar. 05, 2025	Radiation (03CH16-HY)
RF Cable	HUBER + SUHNER	SUCOFLEX 102/SUCOFLE X 104	EC-A5-300-575 7,805935/4,802 434/4	30MHz~18GHz	Aug. 08, 2023	May 08, 2024~ Jun. 18, 2024	Aug. 07, 2024	Radiation (03CH16-HY)
RF Cable	HUBER + SUHNER	SUCOFLEX 102	804011/2,8040 12/2	18-40GHz	Jan. 02, 2024	May 08, 2024~ Jun. 18, 2024	Jan. 01, 2025	Radiation (03CH16-HY)
Software	Audix	E3 230621 V9	RK-002393	N/A	N/A	May 08, 2024~ Jun. 18, 2024	N/A	Radiation (03CH16-HY)
Controller	ChainTek	3000-1	N/A	Control Turn table & Ant Mast	N/A	May 08, 2024~ Jun. 18, 2024	N/A	Radiation (03CH16-HY)
Antenna Mast	ChainTek	MBS-520-1	N/A	1m~4m	N/A	May 08, 2024~ Jun. 18, 2024	N/A	Radiation (03CH16-HY)
Turn Table	ChainTek	T-200-S-1	N/A	0~360 Degree	N/A	May 08, 2024~ Jun. 18, 2024	N/A	Radiation (03CH16-HY)
Spectrum Analyzer	Rohde & Schwarz	FSP30	101329	9kHz~30GHz	Sep. 20, 2023	May 17, 2024~ Jun. 14, 2024	Sep. 19, 2024	Conducted (TH03-HY)
Programmable Power Supply	GW Instek	PSS-2005	EL890001	1V~20V 0.5A~4A	Sep. 12, 2023	May 17, 2024~ Jun. 14, 2024	Sep. 11, 2024	Conducted (TH03-HY)
Base Station (Measure)	Rohde & Schwarz	CMU200	117995	GSM / GPRS / WCDMA / CDMA	Aug. 06, 2023	May 17, 2024~ Jun. 14, 2024	Aug. 05, 2024	Conducted (TH03-HY)
Temperature & Humidity Cabinet Chamber	ESPEC	LHU-113	1012005860	-20°C~85°C	Dec. 13, 2023	May 17, 2024~ Jun. 14, 2024	Dec. 12, 2024	Conducted (TH03-HY)
Hygrometer	TECEPEL	DTM-303B	TP210073	N/A	Jun. 26, 2023	May 17, 2024~ Jun. 14, 2024	Jun. 25, 2024	Conducted (TH03-HY)
Power divider	Warison	WCOU-0.4-26. 5S-20	#A	N/A	Oct. 26, 2023	May 17, 2024~ Jun. 14, 2024	Oct. 25, 2024	Conducted (TH03-HY)



6 Measurement Uncertainty

Uncertainty of Radiated Emission Measurement (30 MHz ~ 1000 MHz)

Measuring Uncertainty for a Level of Confidence of 95% ($U = 2Uc(y)$)	3.09 dB
---	---------

Uncertainty of Radiated Emission Measurement (1 GHz ~ 18 GHz)

Measuring Uncertainty for a Level of Confidence of 95% ($U = 2Uc(y)$)	3.55 dB
---	---------

Uncertainty of Radiated Emission Measurement (18 GHz ~ 40 GHz)

Measuring Uncertainty for a Level of Confidence of 95% ($U = 2Uc(y)$)	4.02 dB
---	---------



Appendix A. Test Results of Conducted Test

Conducted Output Power(Average power) & ERP / EIRP

WCDMA Band V Maximum Average Power [dBm] (GT - LC = 6 dB)					
Channel	4132	4182	4233	ERP (dBm)	ERP (W)
Frequency	826.4	836.4	846.6		
RMC 12.2K	24.85	24.88	24.77	28.73	0.7464
HSDPA Subtest-1	23.88	23.84	23.82		
HSDPA Subtest-2	23.85	23.78	23.78		
HSDPA Subtest-3	23.42	23.33	23.31		
HSDPA Subtest-4	23.36	23.27	23.26		
HSUPA Subtest-1	22.82	22.73	22.74		
HSUPA Subtest-2	21.82	21.73	21.74		
HSUPA Subtest-3	22.84	22.76	22.77		
HSUPA Subtest-4	21.35	21.25	21.26		
HSUPA Subtest-5	22.80	22.70	22.70		
Limit	ERP < 7W				

WCDMA Band II Maximum Average Power [dBm] (GT - LC = 8 dB)					
Channel	9262	9400	9538	EIRP (dBm)	EIRP (W)
Frequency	1852.4	1880	1907.6		
RMC 12.2K	24.69	24.79	24.76	32.79	1.9011
HSDPA Subtest-1	23.69	23.75	23.73		
HSDPA Subtest-2	23.66	23.72	23.71		
HSDPA Subtest-3	23.20	23.25	23.24		
HSDPA Subtest-4	23.14	23.21	23.21		
HSUPA Subtest-1	22.79	22.87	22.82		
HSUPA Subtest-2	21.80	21.89	21.84		
HSUPA Subtest-3	22.63	22.74	22.74		
HSUPA Subtest-4	21.32	21.39	21.38		
HSUPA Subtest-5	22.60	22.70	22.70		
Limit	EIRP < 2W				

WCDMA Band IV Maximum Average Power [dBm] (GT - LC = 5 dB)					
Channel	1312	1413	1513	EIRP (dBm)	EIRP (W)
Frequency	1712.4	1732.6	1752.6		
RMC 12.2K	24.96	24.97	24.92	29.97	0.9931
HSDPA Subtest-1	23.94	23.92	23.92		
HSDPA Subtest-2	23.89	23.90	23.89		
HSDPA Subtest-3	23.42	23.45	23.41		
HSDPA Subtest-4	23.40	23.38	23.37		
HSUPA Subtest-1	23.04	23.05	23.01		
HSUPA Subtest-2	21.95	21.94	21.91		
HSUPA Subtest-3	22.90	22.90	22.87		
HSUPA Subtest-4	21.59	21.58	21.53		
HSUPA Subtest-5	22.80	22.90	22.80		
Limit	EIRP < 1W				



A2. WCDMA

Peak-to-Average Ratio

Mode	WCDMA Band V	WCDMA Band II	WCDMA Band IV	Limit: 13dB
Mod.	RMC 12.2Kbps	RMC 12.2Kbps	RMC 12.2Kbps	Result
Lowest CH	2.80	2.36	2.60	PASS
Middle CH	2.60	2.28	2.72	
Highest CH	2.40	2.20	2.80	

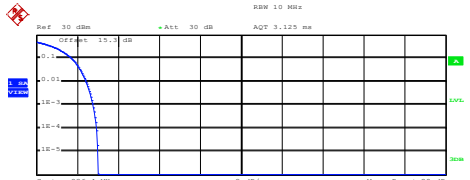
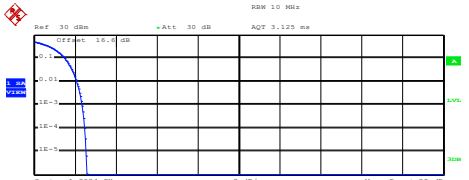
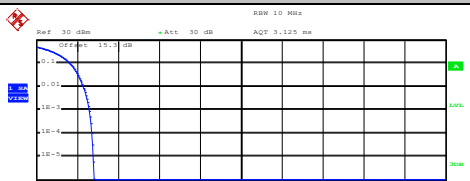
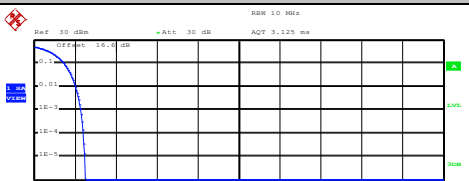
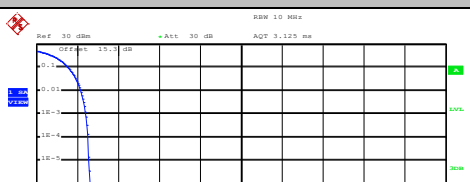
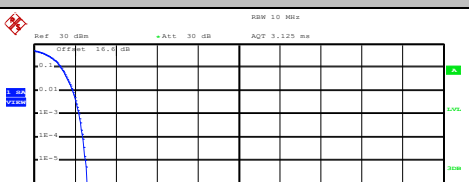

WCDMA Band V (RMC 12.2Kbps)	WCDMA Band II (RMC 12.2Kbps)
<p align="center">Lowest Channel</p>  <p>Center 826.4 MHz 2 dB/ Mean Pwr + 20 dB</p> <p>Complementary Cumulative Distribution Function (100000 samples)</p> <p>Trace 1</p> <p>Mean 24.14 dBm Peak 27.15 dBm Crest 3.01 dB</p> <p>10 % 1.72 dB 1 % 2.44 dB .1 % 2.80 dB .01 % 2.96 dB</p> <p>Date: 17.MAY.2024 17:26:51</p>	<p align="center">Lowest Channel</p>  <p>Center 1.8524 GHz 2 dB/ Mean Pwr + 20 dB</p> <p>Complementary Cumulative Distribution Function (100000 samples)</p> <p>Trace 1</p> <p>Mean 24.05 dBm Peak 26.65 dBm Crest 2.60 dB</p> <p>10 % 1.52 dB 1 % 2.08 dB .1 % 2.36 dB .01 % 2.48 dB</p> <p>Date: 17.MAY.2024 11:20:34</p>
<p align="center">Middle Channel</p>  <p>Center 826.4 MHz 2 dB/ Mean Pwr + 20 dB</p> <p>Complementary Cumulative Distribution Function (100000 samples)</p> <p>Trace 1</p> <p>Mean 24.03 dBm Peak 26.87 dBm Crest 2.84 dB</p> <p>10 % 1.64 dB 1 % 2.32 dB .1 % 2.60 dB .01 % 2.72 dB</p> <p>Date: 17.MAY.2024 17:27:08</p>	<p align="center">Middle Channel</p>  <p>Center 1.85 GHz 2 dB/ Mean Pwr + 20 dB</p> <p>Complementary Cumulative Distribution Function (100000 samples)</p> <p>Trace 1</p> <p>Mean 23.86 dBm Peak 26.37 dBm Crest 2.51 dB</p> <p>10 % 1.48 dB 1 % 2.04 dB .1 % 2.28 dB .01 % 2.40 dB</p> <p>Date: 17.MAY.2024 11:20:51</p>
<p align="center">Highest Channel</p>  <p>Center 846.6 MHz 2 dB/ Mean Pwr + 20 dB</p> <p>Complementary Cumulative Distribution Function (100000 samples)</p> <p>Trace 1</p> <p>Mean 24.12 dBm Peak 26.72 dBm Crest 2.61 dB</p> <p>10 % 1.56 dB 1 % 2.16 dB .1 % 2.40 dB .01 % 2.52 dB</p> <p>Date: 17.MAY.2024 17:27:26</p>	<p align="center">Highest Channel</p>  <p>Center 1.9076 GHz 2 dB/ Mean Pwr + 20 dB</p> <p>Complementary Cumulative Distribution Function (100000 samples)</p> <p>Trace 1</p> <p>Mean 23.99 dBm Peak 26.58 dBm Crest 2.59 dB</p> <p>10 % 1.32 dB 1 % 1.88 dB .1 % 2.20 dB .01 % 2.40 dB</p> <p>Date: 17.MAY.2024 11:21:07</p>



WCDMA Band IV (RMC 12.2Kbps)

Lowest Channel

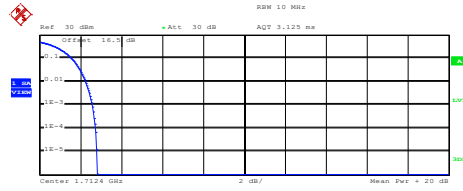

Complementary Cumulative Distribution Function (100000 samples)

Trace 1
 Mean 24.48 dBm
 Peak 27.29 dBm
 Crest 2.80 dB

10 % 1.56 dB
 1 % 2.24 dB
 .1 % 2.60 dB
 .01 % 2.76 dB

Date: 17.MAY.2024 16:54:56

Middle Channel

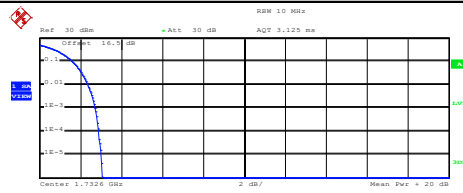

Complementary Cumulative Distribution Function (100000 samples)

Trace 1
 Mean 24.31 dBm
 Peak 27.36 dBm
 Crest 3.05 dB

10 % 1.60 dB
 1 % 2.36 dB
 .1 % 2.72 dB
 .01 % 2.88 dB

Date: 17.MAY.2024 16:55:13

Highest Channel

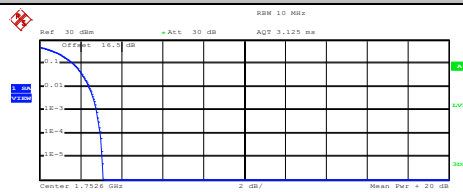

Complementary Cumulative Distribution Function (100000 samples)

Trace 1
 Mean 24.11 dBm
 Peak 27.22 dBm
 Crest 3.11 dB

10 % 1.64 dB
 1 % 2.40 dB
 .1 % 2.80 dB
 .01 % 2.96 dB

Date: 17.MAY.2024 16:55:30



26dB Bandwidth

Mode	WCDMA Band V 26dB BW(MHz)	WCDMA Band II 26dB BW(MHz)	WCDMA Band IV 26dB BW(MHz)
Mod.	RMC 12.2Kbps	RMC 12.2Kbps	RMC 12.2Kbps
Lowest CH	4.70	4.73	4.74
Middle CH	4.73	4.77	4.75
Highest CH	4.77	4.74	4.74

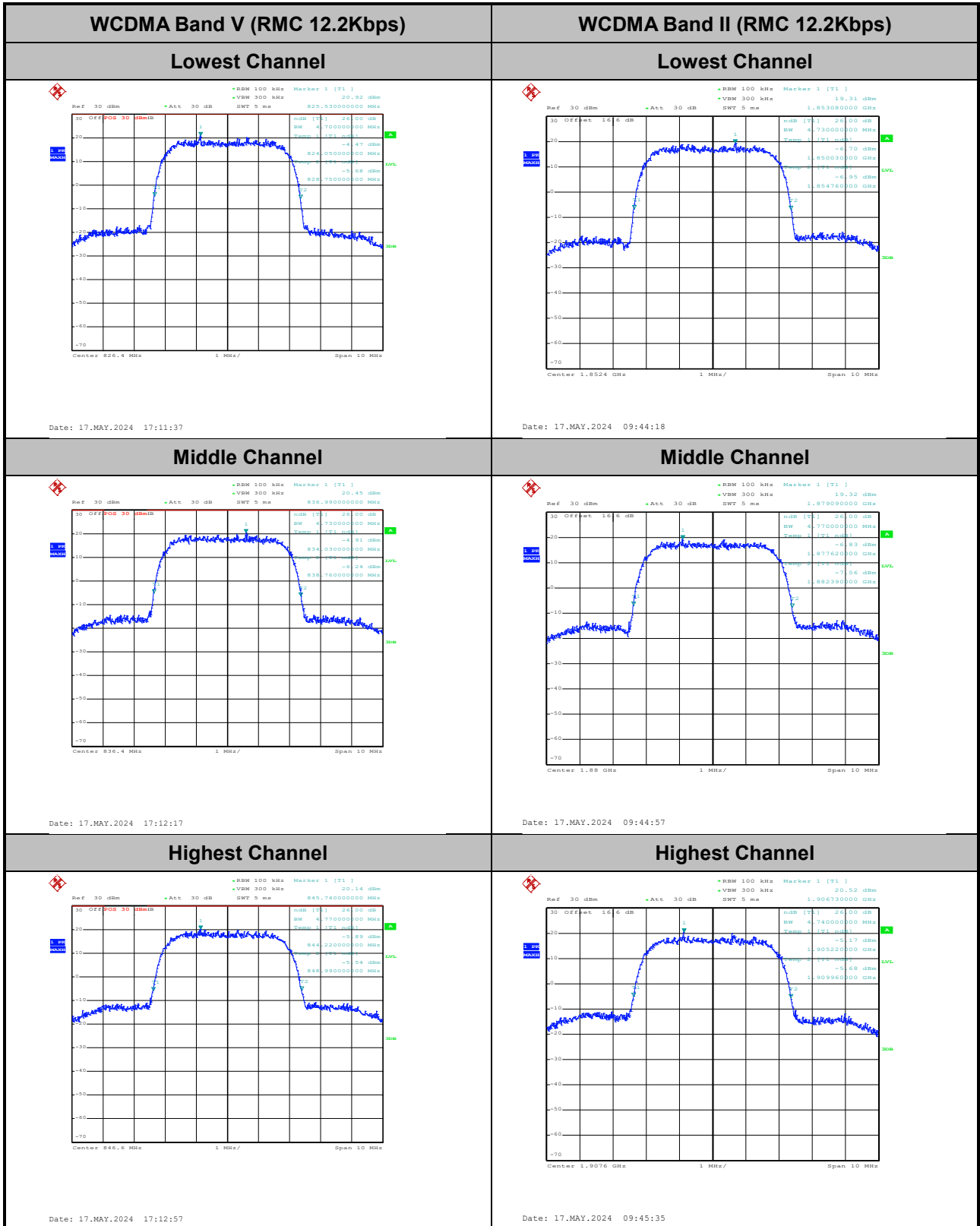



WCDMA Band IV (RMC 12.2Kbps)

Lowest Channel

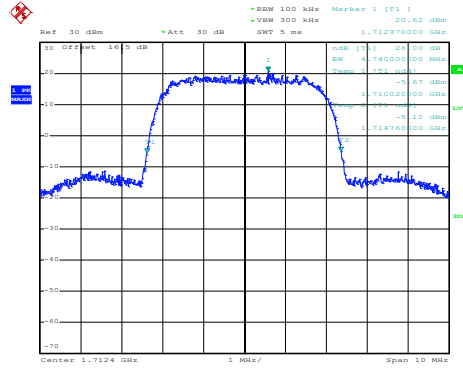

Date: 17.MAY.2024 16:34:59

Middle Channel

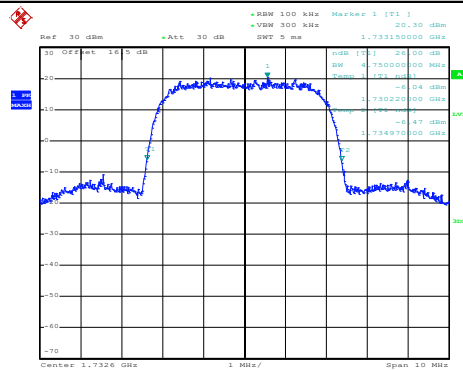

Date: 17.MAY.2024 16:35:39

Highest Channel

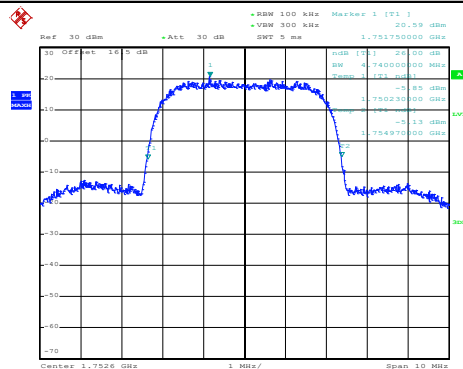

Date: 17.MAY.2024 16:36:16



Occupied Bandwidth

Mode	WCDMA Band V 99%OBW(MHz)	WCDMA Band II 99%OBW(MHz)	WCDMA Band IV 99%OBW(MHz)
Mod.	RMC 12.2Kbps	RMC 12.2Kbps	RMC 12.2Kbps
Lowest CH	4.16	4.21	4.18
Middle CH	4.17	4.22	4.18
Highest CH	4.18	4.27	4.17

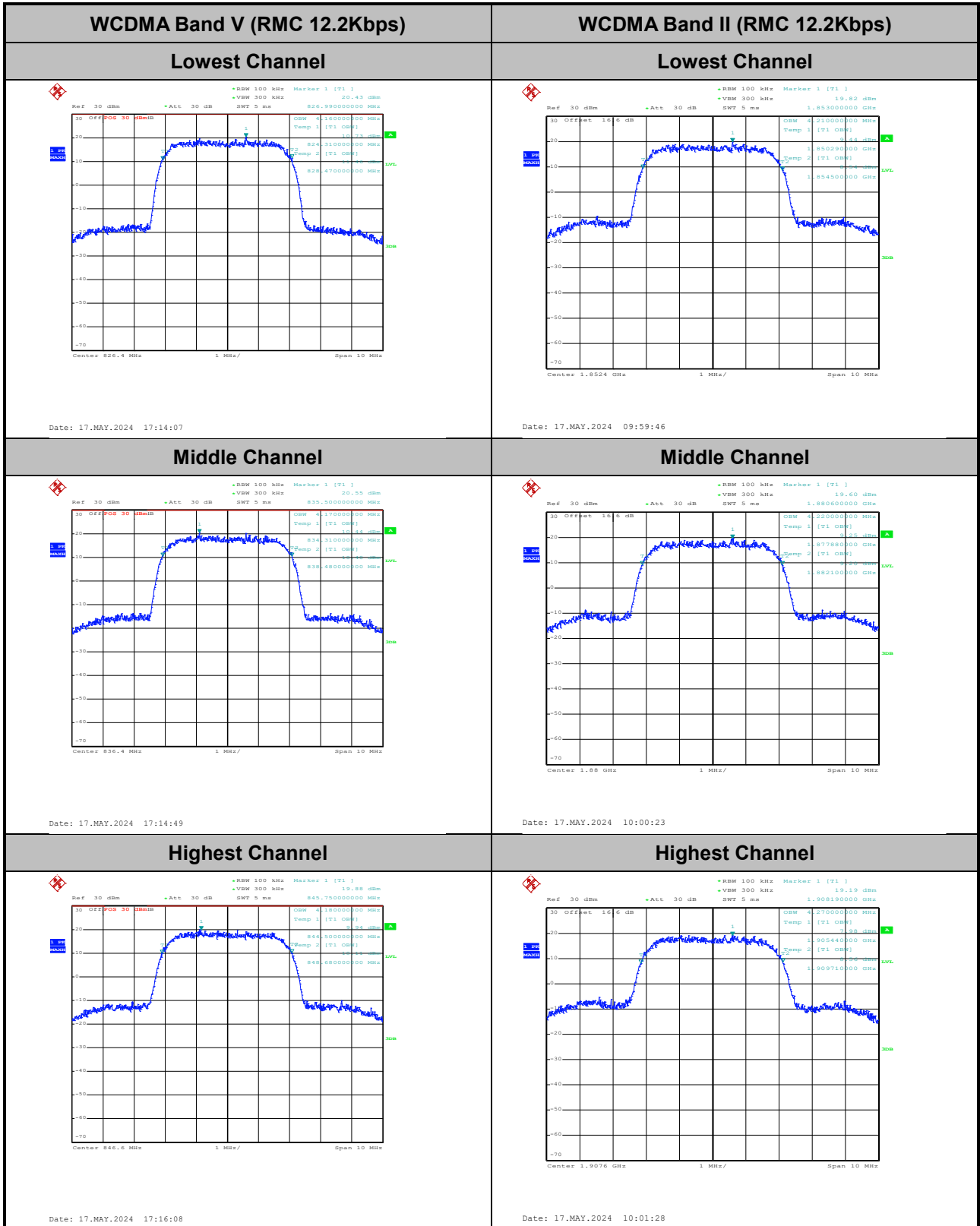



WCDMA Band IV (RMC 12.2Kbps)

Lowest Channel

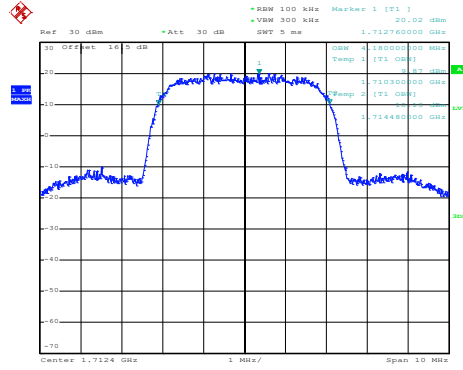

Date: 17.MAY.2024 16:37:25

Middle Channel

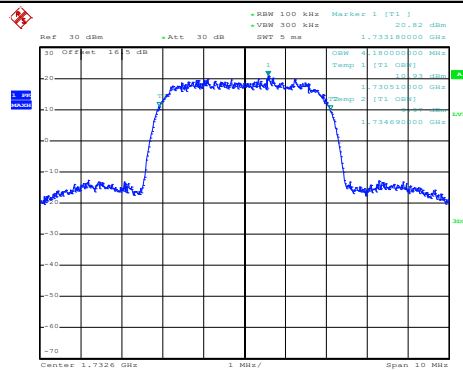

Date: 17.MAY.2024 16:38:10

Highest Channel

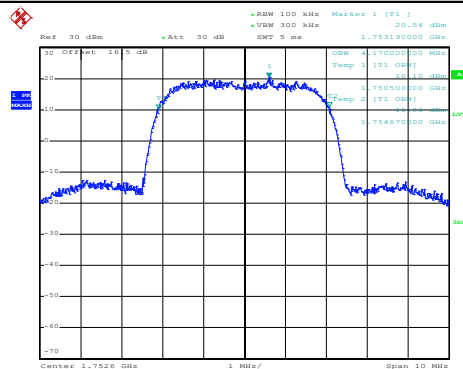

Date: 17.MAY.2024 16:39:02



Conducted Band Edge

WCDMA Band V (RMC 12.2Kbps)

Lowest Band Edge

Highest Band Edge

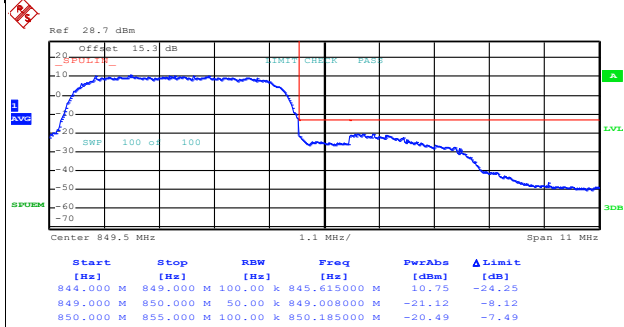
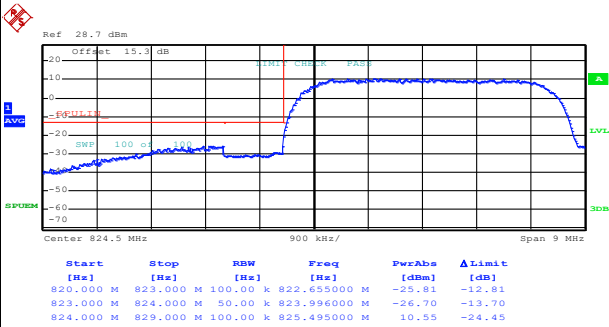

Date: 17.MAY.2024 17:19:58

Date: 17.MAY.2024 17:23:26



WCDMA Band II (RMC 12.2Kbps)

Lowest Band Edge

Highest Band Edge

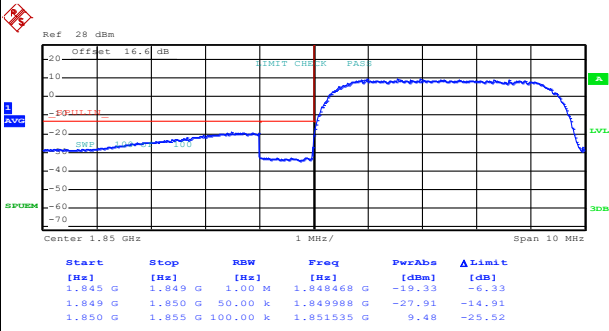

Date: 3.JUN.2024 14:47:23

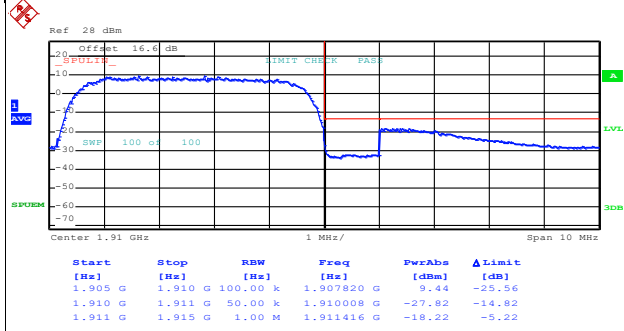

Date: 3.JUN.2024 14:43:26



WCDMA Band IV (RMC 12.2Kbps)

Lowest Band Edge

Highest Band Edge

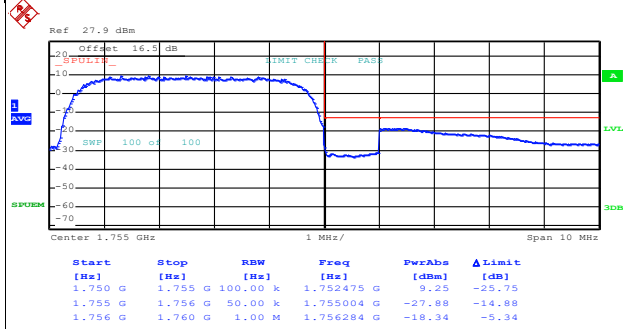
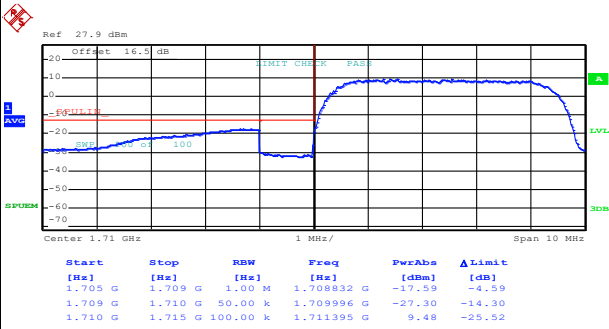

Date: 3.JUN.2024 14:55:11

Date: 3.JUN.2024 14:58:21



Conducted Spurious Emission

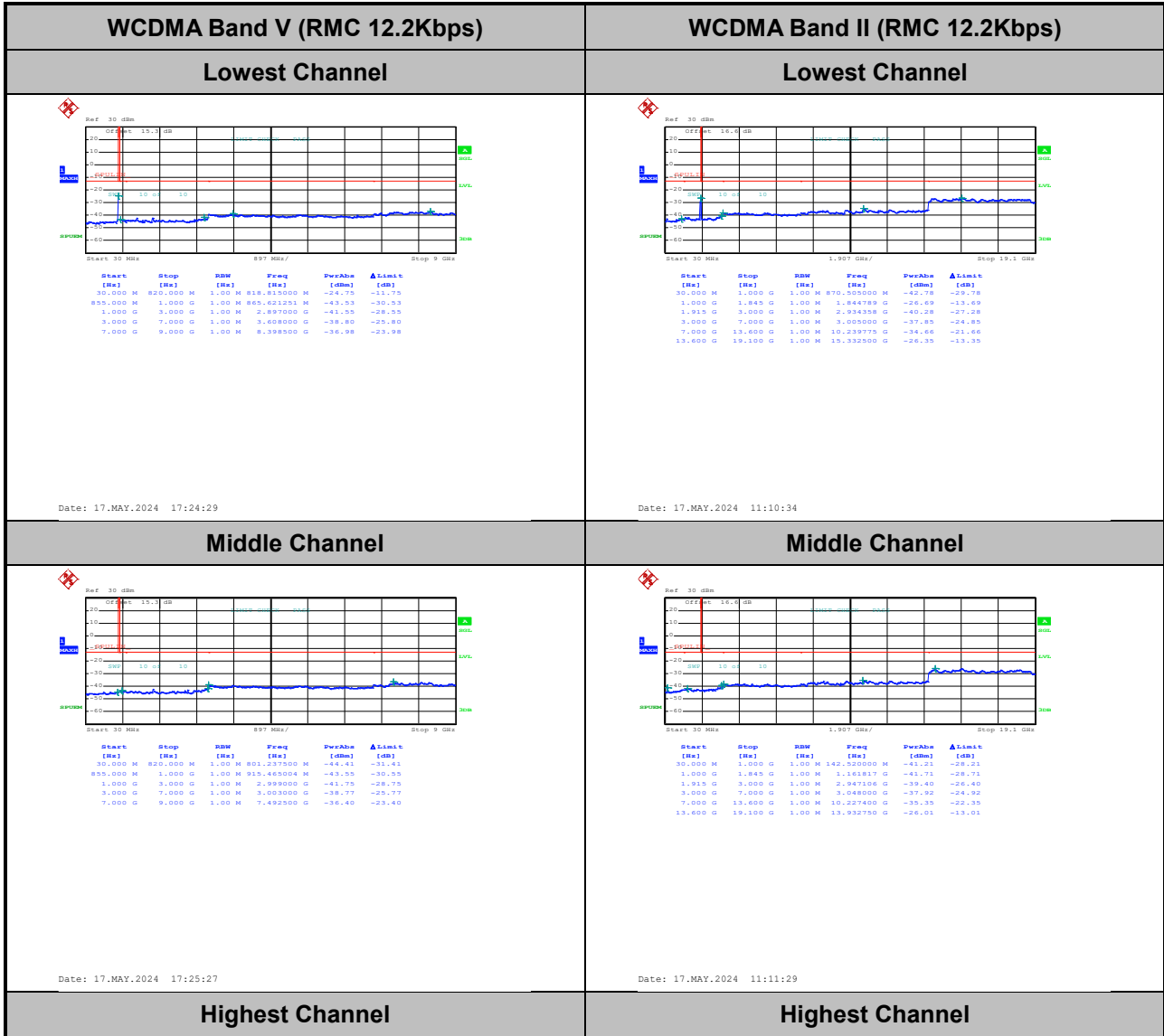

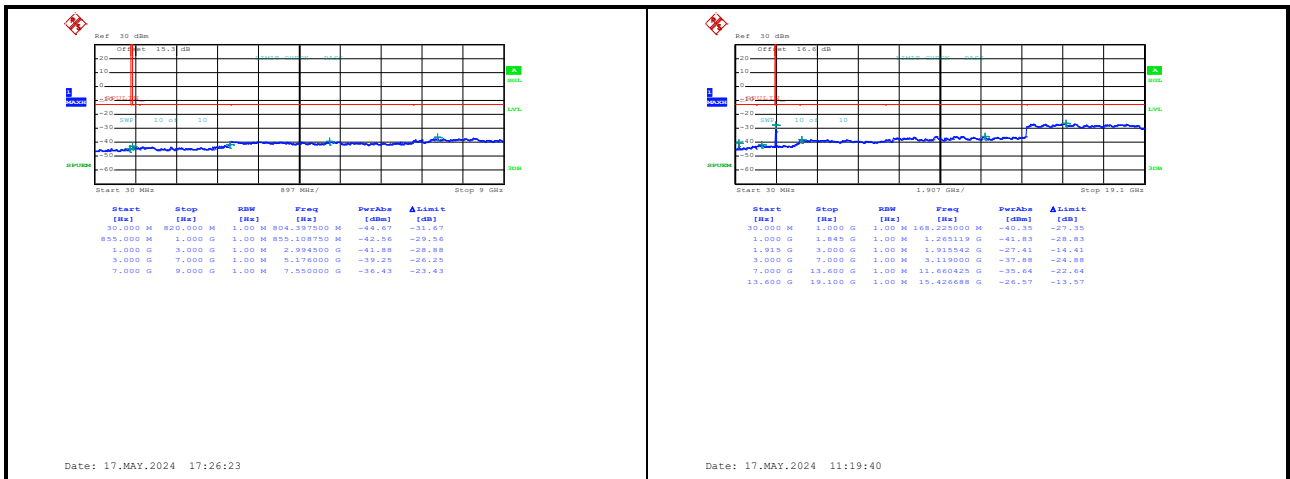



WCDMA Band IV (RMC 12.2Kbps)

Lowest Channel

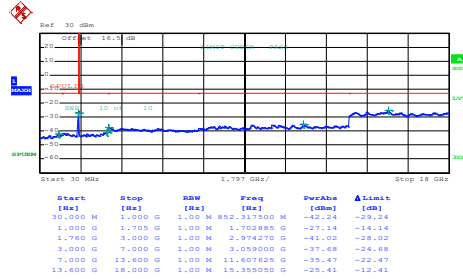

Date: 17.MAY.2024 16:50:17

Middle Channel

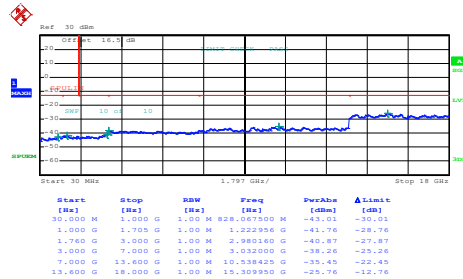

Date: 17.MAY.2024 16:51:19

Highest Channel

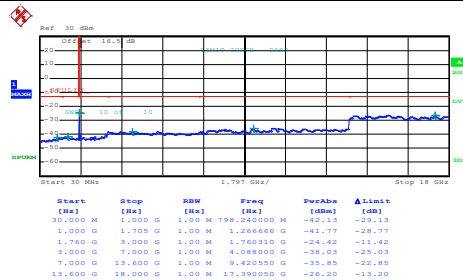

Date: 17.MAY.2024 16:52:37



Frequency Stability

Test Conditions Temperature (°C)	Middle Channel Voltage (Volt)	WCDMA Band V (RMC 12.2Kbps)	Limit 2.5ppm
		Deviation (ppm)	Result
50	Normal Voltage	0.0263	PASS
40	Normal Voltage	0.0024	
30	Normal Voltage	0.0096	
20(Ref.)	Normal Voltage	0.0000	
10	Normal Voltage	0.0024	
0	Normal Voltage	0.0012	
-10	Normal Voltage	0.0012	
-20	Normal Voltage	0.0036	
-30	Normal Voltage	0.0060	
20	Maximum Voltage	0.0036	
20	Normal Voltage	0.0108	
20	Battery End Point	0.0072	

Test Conditions Temperature (°C)	Middle Channel Voltage (Volt)	WCDMA Band II (RMC 12.2Kbps)	Limit Note 2.
		Deviation (ppm)	Result
50	Normal Voltage	0.0048	PASS
40	Normal Voltage	0.0053	
30	Normal Voltage	0.0043	
20(Ref.)	Normal Voltage	0.0000	
10	Normal Voltage	0.0048	
0	Normal Voltage	0.0027	
-10	Normal Voltage	0.0011	
-20	Normal Voltage	0.0032	
-30	Normal Voltage	0.0059	
20	Maximum Voltage	0.0069	
20	Normal Voltage	0.0016	
20	Battery End Point	0.0053	

Note:

1. Normal Voltage = 3.3V. ; Battery End Point (BEP) = 3.14 V. ; Maximum Voltage =4.4 V
2. The frequency fundamental emissions stay within the authorized frequency block based on the frequency deviation measured is small.



Test Conditions	Middle Channel	WCDMA Band IV (RMC 12.2Kbps)	Limit
		Deviation (ppm)	Note 2.
Temperature (°C)	Voltage (Volt)		Result
50	Normal Voltage	0.0006	PASS
40	Normal Voltage	0.0017	
30	Normal Voltage	0.0029	
20(Ref.)	Normal Voltage	0.0000	
10	Normal Voltage	0.0029	
0	Normal Voltage	0.0040	
-10	Normal Voltage	0.0012	
-20	Normal Voltage	0.0012	
-30	Normal Voltage	0.0237	
20	Maximum Voltage	0.0023	
20	Normal Voltage	0.0006	
20	Battery End Point	0.0052	

Note:

1. Normal Voltage = 3.3V. ; Battery End Point (BEP) = 3.14 V. ; Maximum Voltage =4.4 V
2. The frequency fundamental emissions stay within the authorized frequency block based on the frequency deviation measured is small.



Appendix B. Test Results of Radiated Test

B1. Summary of each worse mode

Mode	Part	Band	Ch	Freq (MHz)	Level (dBm)	Det	Ant Factor (dB)	Amp\Cbl (dB)	Filter (dB)	EIRPCF (dB)	Reading (dBuV)	Limit (dBm)	Margin (dB)	Pol	Ant
1	Part 22H	WCDMA B5	H	3384	-55.12	RMS	29.53	-20.64	0.26	-95.23	30.96	-13.00	-42.12	H	0
1	Part 24E	WCDMA B2	L	7409	-44.19	RMS	36.38	-16.79	0.38	-95.23	31.07	-13.00	-31.19	H	0
1	Part 27L	WCDMA B4	H	7010	-45.19	RMS	35.84	-17.14	0.38	-95.23	30.96	-13.00	-32.19	H	0



Ant 0

Part 22H Mode 1
WCDMA B5 Ch4132

L

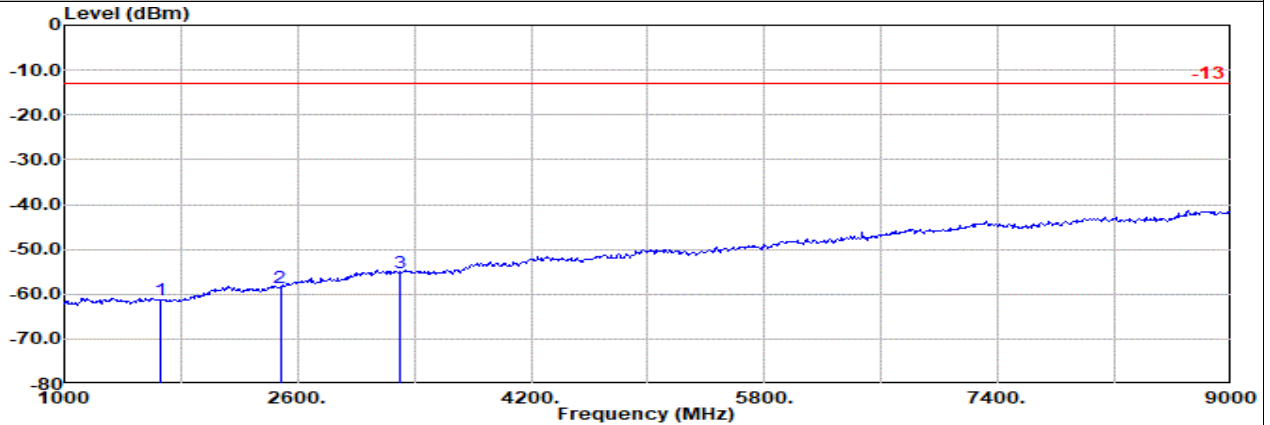

Site : 03CH16-HY
Condition: -13 3m 9120D-1522_240328 Horizontal
: WCDMA B5 Ch4132

	Freq MHz	Level dBm	Detector	Ant Amp\Cb		Filter	EIRPCF	Readin g	Limit	Margin	Pol
				Factor	1						
1	1656.00	-61.28	RMS	25.00	-23.93	0.52	-95.23	32.36	-13.00	-48.28	Horizontal
2	2480.00	-58.44	RMS	27.70	-22.24	0.33	-95.23	31.00	-13.00	-45.44	Horizontal
3	3304.00	-55.18	RMS	29.60	-20.77	0.26	-95.23	30.96	-13.00	-42.18	Horizontal

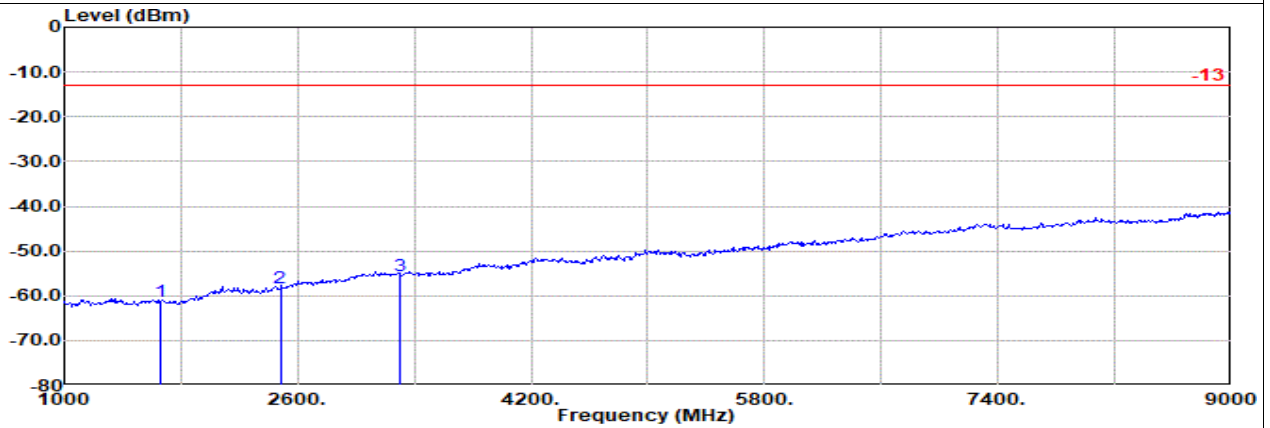

Site : 03CH16-HY
Condition: -13 3m 9120D-1522_240328 Vertical
: WCDMA B5 Ch4132

	Freq MHz	Level dBm	Detector	Ant Amp\Cb		Filter	EIRPCF	Readin g	Limit	Margin	Pol
				Factor	1						
1	1656.00	-61.37	RMS	25.00	-23.93	0.52	-95.23	32.27	-13.00	-48.37	Vertical
2	2480.00	-58.41	RMS	27.70	-22.24	0.33	-95.23	31.03	-13.00	-45.41	Vertical
3	3304.00	-55.43	RMS	29.60	-20.77	0.26	-95.23	30.71	-13.00	-42.43	Vertical



Ant 0

Part 22H Mode 1
WCDMA B5 Ch4182

M

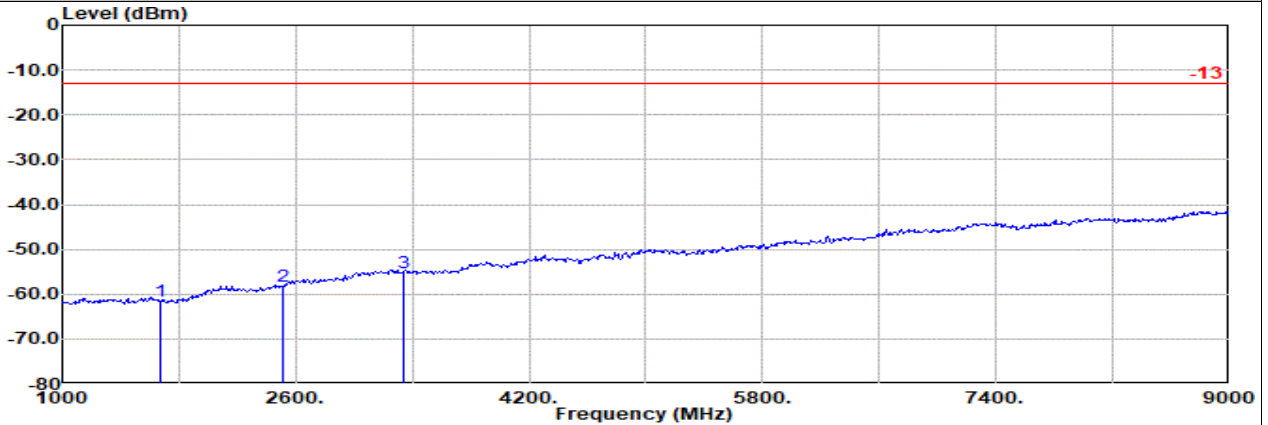

Site : 03CH16-HY
 Condition: -13 3m 9120D-1522_240328 Horizontal
 : WCDMA B5 Ch4182

Freq	Level	Detector	Ant Amp\Cb		Filter	EIRPCF	Reading	Limit	Margin		Pol
			Factor	1					dB	dB	
1	1672.00	-61.63	RMS	25.10	-23.89	0.51	-95.23	31.88	-13.00	-48.63	Horizontal
2	2512.00	-58.34	RMS	27.72	-22.22	0.33	-95.23	31.06	-13.00	-45.34	Horizontal
3	3344.00	-55.30	RMS	29.60	-20.71	0.26	-95.23	30.78	-13.00	-42.30	Horizontal

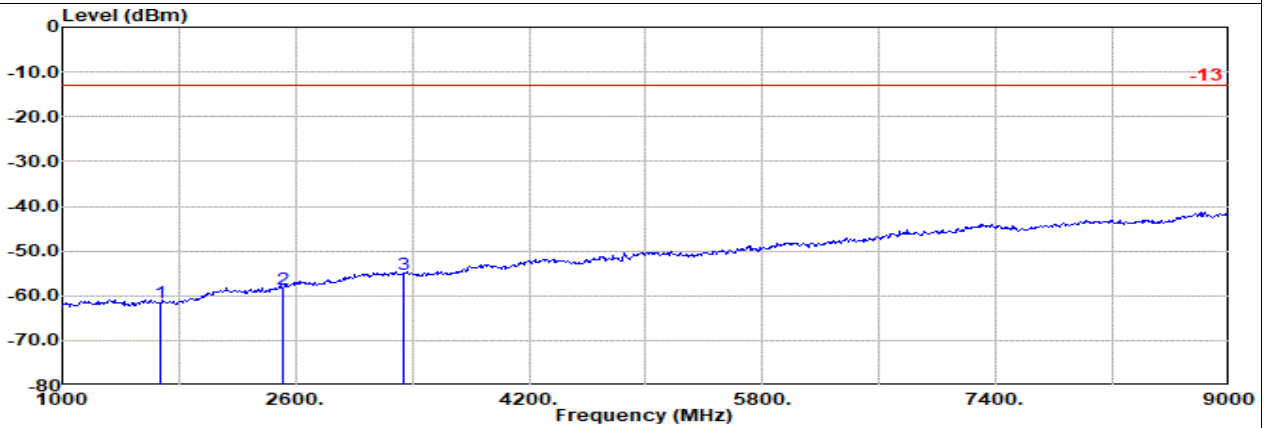

Site : 03CH16-HY
 Condition: -13 3m 9120D-1522_240328 Vertical
 : WCDMA B5 Ch4182

Freq	Level	Detector	Ant Amp\Cb		Filter	EIRPCF	Reading	Limit	Margin		Pol
			Factor	1					dB	dB	
1	1672.00	-61.53	RMS	25.10	-23.89	0.51	-95.23	31.98	-13.00	-48.53	Vertical
2	2512.00	-58.55	RMS	27.72	-22.22	0.33	-95.23	30.85	-13.00	-45.55	Vertical
3	3344.00	-55.12	RMS	29.60	-20.71	0.26	-95.23	30.96	-13.00	-42.12	Vertical



Ant 0

Part 22H Mode 1

WCDMA B5 Ch4233

H

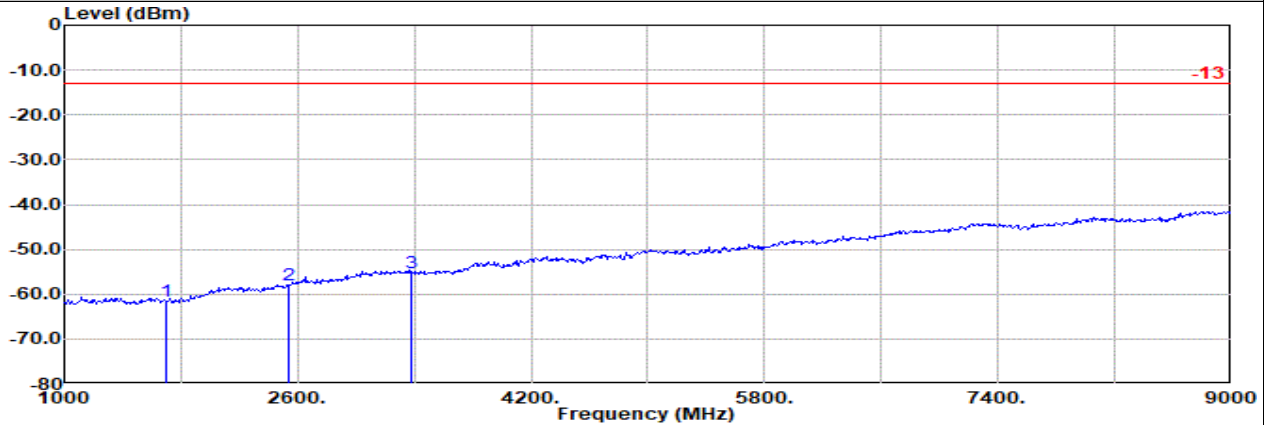

Site : 03CH16-HY
 Condition: -13 3m 9120D-1522_240328 Horizontal
 : WCDMA B5 Ch4233

1	2	3	Freq MHz	Level dBm	Detector	Ant Amp\Cb		Filter	EIRPCF	Reading	Limit	Margin	Pol
						Factor	1						
			1696.00	-61.54	RMS	24.94	-23.83	0.51	-95.23	32.07	-13.00	-48.54	Horizontal
			2536.00	-57.96	RMS	27.96	-22.17	0.33	-95.23	31.15	-13.00	-44.96	Horizontal
			3384.00	-55.12	RMS	29.53	-20.64	0.26	-95.23	30.96	-13.00	-42.12	Horizontal

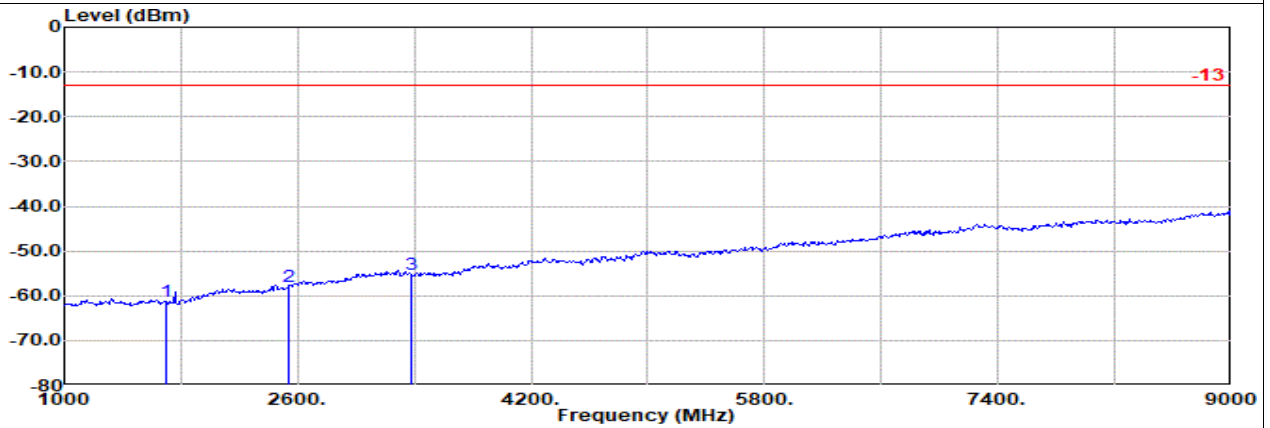

Site : 03CH16-HY
 Condition: -13 3m 9120D-1522_240328 Vertical
 : WCDMA B5 Ch4233

1	2	3	Freq MHz	Level dBm	Detector	Ant Amp\Cb		Filter	EIRPCF	Reading	Limit	Margin	Pol
						Factor	1						
			1696.00	-61.42	RMS	24.94	-23.83	0.51	-95.23	32.19	-13.00	-48.42	Vertical
			2536.00	-58.04	RMS	27.96	-22.17	0.33	-95.23	31.07	-13.00	-45.04	Vertical
			3384.00	-55.23	RMS	29.53	-20.64	0.26	-95.23	30.85	-13.00	-42.23	Vertical



Ant 0

Part 24E Mode 1

WCDMA B2 Ch9262

L

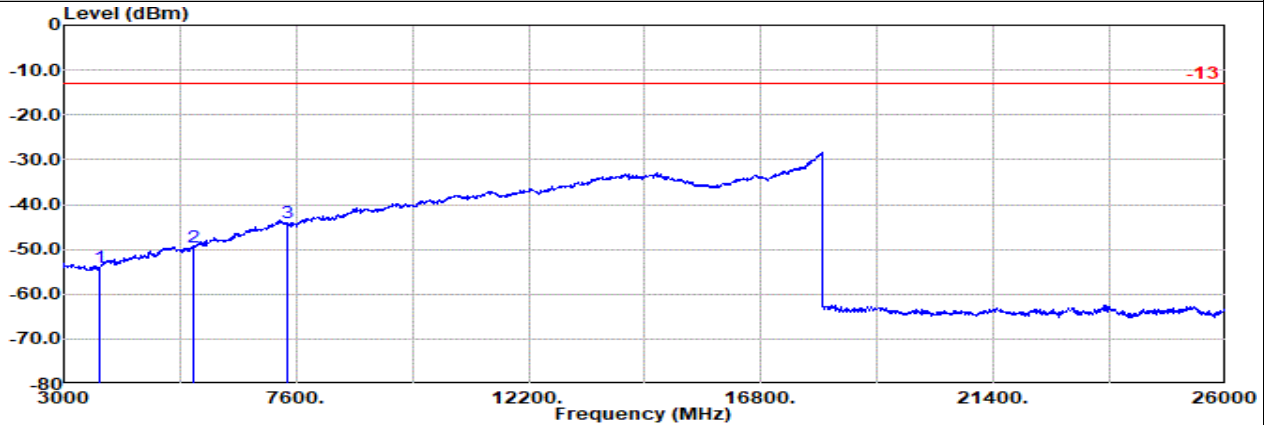

Site : 03CH16-HY
 Condition: -13 1m SHF_00993_231124 Horizontal
 : WCDMA B2 Ch9262

Freq	Level	Detector	Ant Amp\Cb Filter		EIRPCF	Readin	Limit	Margin Pol	
			Factor	1				g	
MHz	dBm		dB/m	dB	dB	dBuV	dBm	dB	
1 3704.00	-53.96	RMS	29.62	-20.12	0.81 -95.23	0.00	-13.00	-40.96	Horizontal
2 5557.00	-49.53	RMS	32.80	-17.56	0.39 -95.23	30.07	-13.00	-36.53	Horizontal
3 7409.00	-44.19	RMS	36.38	-16.79	0.38 -95.23	31.07	-13.00	-31.19	Horizontal

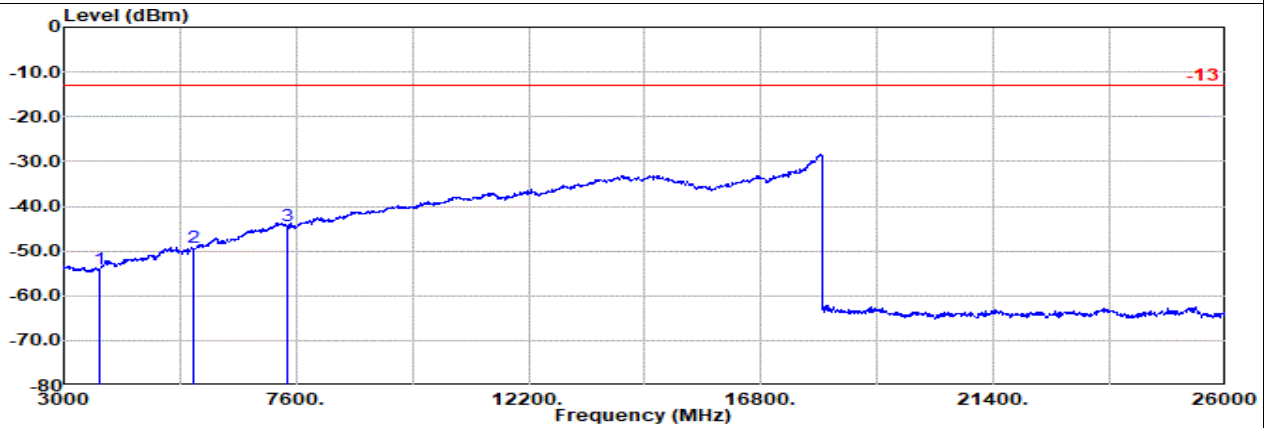

Site : 03CH16-HY
 Condition: -13 1m SHF_00993_231124 Vertical
 : WCDMA B2 Ch9262

Freq	Level	Detector	Ant Amp\Cb Filter		EIRPCF	Readin	Limit	Margin Pol	
			Factor	1				g	
MHz	dBm		dB/m	dB	dB	dBuV	dBm	dB	
1 3704.00	-54.00	RMS	29.62	-20.12	0.81 -95.23	30.92	-13.00	-41.00	Vertical
2 5557.00	-49.29	RMS	32.80	-17.56	0.39 -95.23	30.31	-13.00	-36.29	Vertical
3 7409.00	-44.35	RMS	36.38	-16.79	0.38 -95.23	30.91	-13.00	-31.35	Vertical



Ant 0

Part 24E Mode 1

WCDMA B2 Ch9400

M

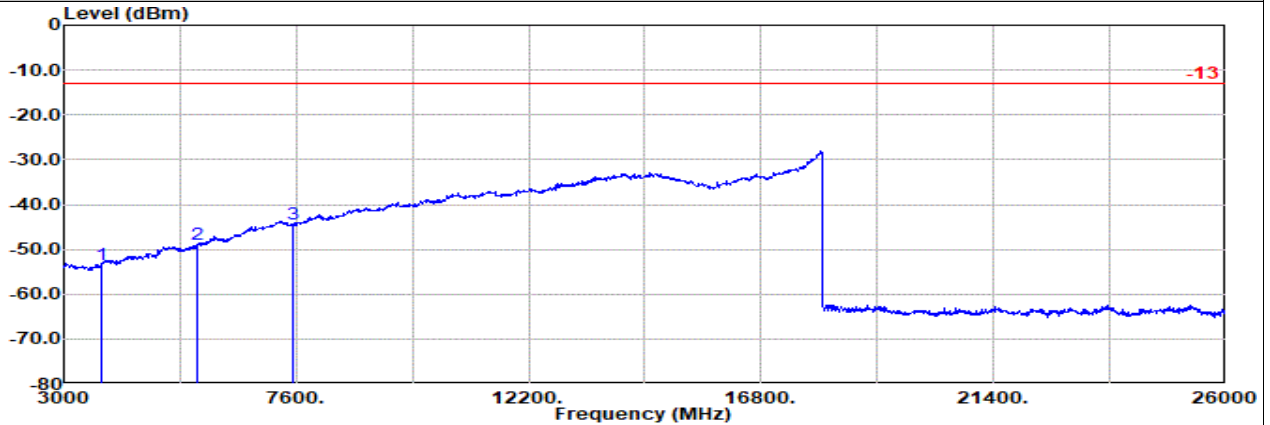

Site : 03CH16-HY
 Condition: -13 1m SHF_00993_231124 Horizontal
 : WCDMA B2 Ch9400

Freq	Level	Detector	Ant Amp\Cb Filter		EIRPCF	Readin	Limit	Margin Pol		
			Factor	1				g		
MHz	dBm		dB/m	dB	dB	dBuV	dBm	dB		
1 3760.00	-53.30	RMS	29.98	-19.94	0.76	-95.23	31.13	-13.00	-40.30	Horizontal
2 5640.00	-48.93	RMS	32.96	-17.50	0.39	-95.23	30.45	-13.00	-35.93	Horizontal
3 7520.00	-44.48	RMS	36.12	-16.74	0.47	-95.23	30.90	-13.00	-31.48	Horizontal

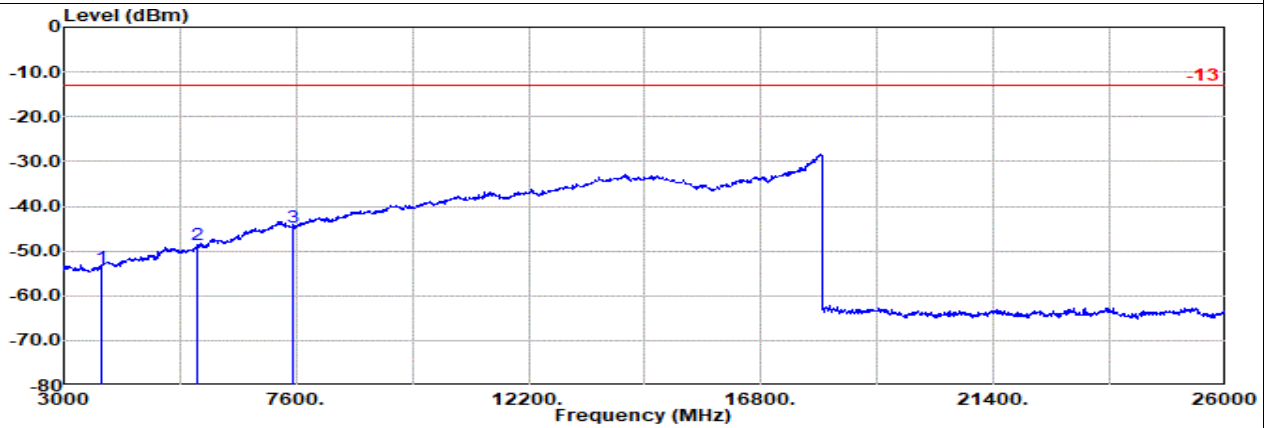

Site : 03CH16-HY
 Condition: -13 1m SHF_00993_231124 Vertical
 : WCDMA B2 Ch9400

Freq	Level	Detector	Ant Amp\Cb Filter		EIRPCF	Readin	Limit	Margin Pol		
			Factor	1				g		
MHz	dBm		dB/m	dB	dB	dBuV	dBm	dB		
1 3760.00	-53.82	RMS	29.98	-19.94	0.76	-95.23	30.61	-13.00	-40.82	Vertical
2 5640.00	-48.67	RMS	32.96	-17.50	0.39	-95.23	30.71	-13.00	-35.67	Vertical
3 7520.00	-44.53	RMS	36.12	-16.74	0.47	-95.23	30.85	-13.00	-31.53	Vertical



Ant 0

Part 24E Mode 1

WCDMA B2 Ch9538

H

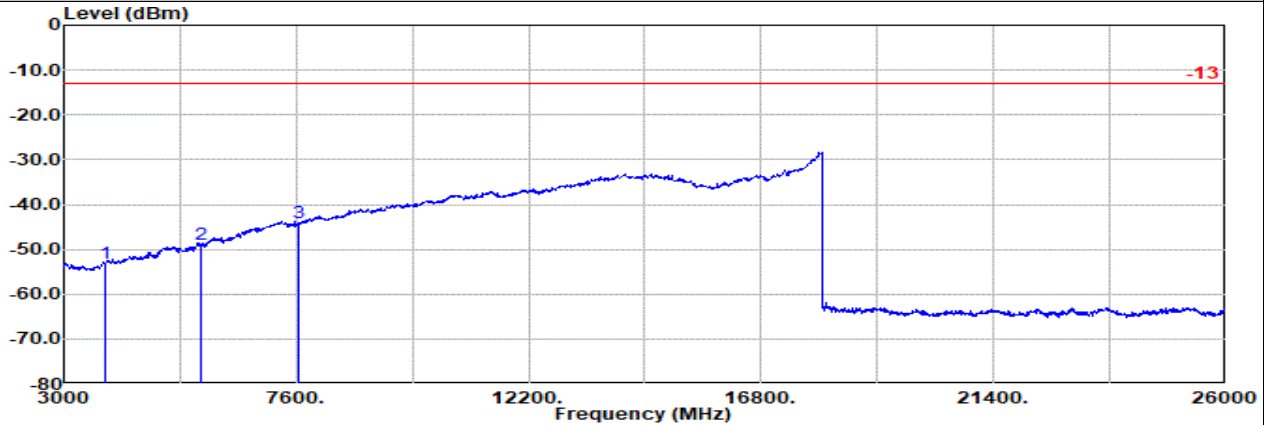

Site : 03CH16-HY
 Condition: -13 1m SHF_00993_231124 Horizontal
 : WCDMA B2 Ch9538

Freq	Level	Detector	Ant Amp\Cb Filter		EIRPCF	Reading	Limit	Margin Pol			
			Factor	1				dB	dB	dB	dB
1	3815.00	-53.11	RMS	30.42	-19.81	0.71	-95.23	30.80	-13.00	-40.11	Horizontal
2	5722.00	-48.83	RMS	33.44	-17.45	0.40	-95.23	30.01	-13.00	-35.83	Horizontal
3	7630.00	-44.20	RMS	36.16	-16.57	0.52	-95.23	30.92	-13.00	-31.20	Horizontal

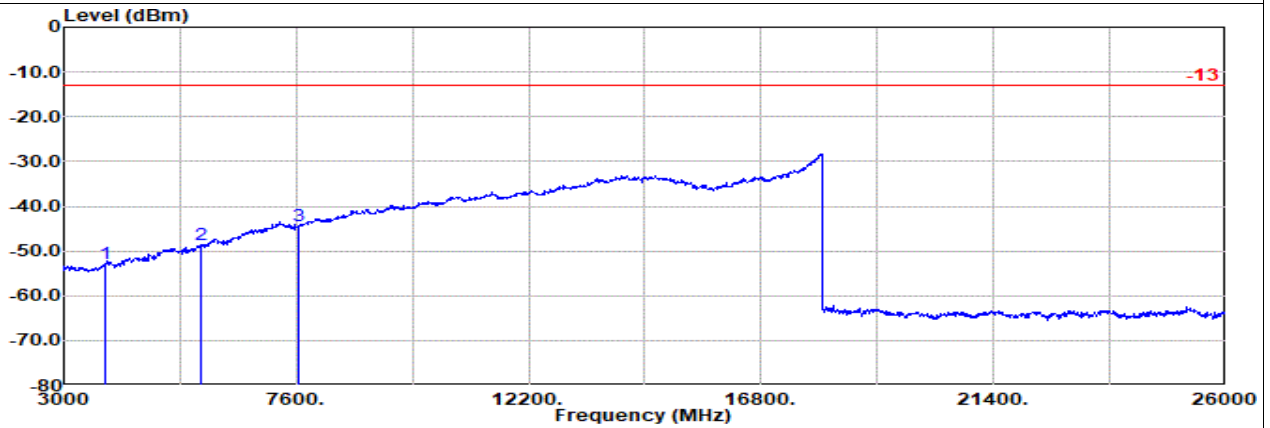

Site : 03CH16-HY
 Condition: -13 1m SHF_00993_231124 Vertical
 : WCDMA B2 Ch9538

Freq	Level	Detector	Ant Amp\Cb Filter		EIRPCF	Reading	Limit	Margin Pol			
			Factor	1				dB	dB	dB	dB
1	3815.00	-52.93	RMS	30.42	-19.81	0.71	-95.23	30.98	-13.00	-39.93	Vertical
2	5722.00	-48.61	RMS	33.44	-17.45	0.40	-95.23	30.23	-13.00	-35.61	Vertical
3	7630.00	-44.43	RMS	36.16	-16.57	0.52	-95.23	30.69	-13.00	-31.43	Vertical



Ant 0

Part 27L Mode 1
WCDMA B4 Ch1312

L

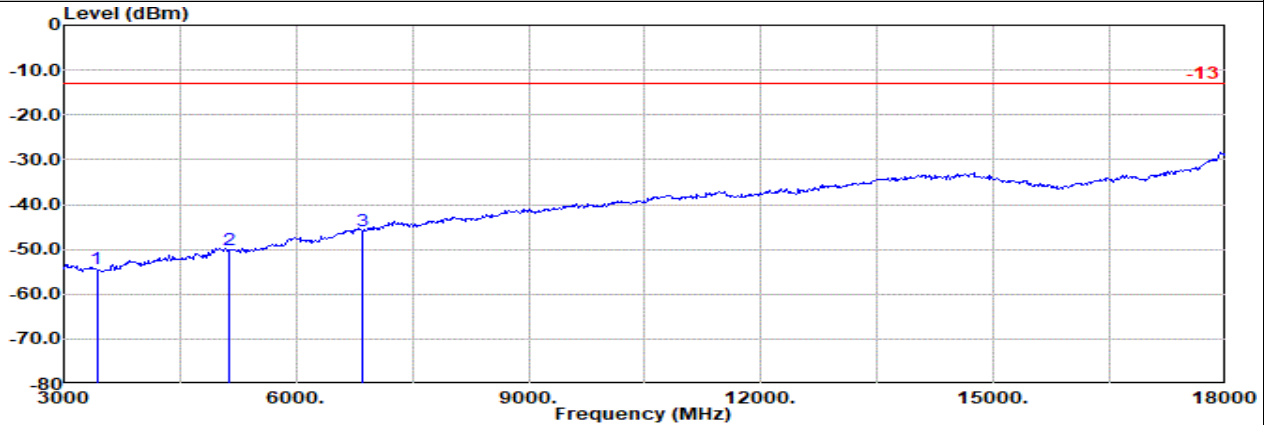

Site : 03CH16-HY
Condition: -13 3m 9120D-1522_240328 Horizontal
: WCDMA B4 Ch1312

1	2	3	Freq Level		Detector	Ant Amp\Cb Filter		Factor	Filter		EIRPCF	Readin g	Limit		Margin	Pol
			MHz	dBm		dB/m	dB		dB	dB			dBuV	dBm		
1	2	3	3425.00	-54.24	RMS	29.45	-20.57	0.91	-95.23	0.00	-13.00	-41.24	Horizontal			
2	2	3	5137.00	-50.02	RMS	32.97	-18.06	0.46	-95.23	29.84	-13.00	-37.02	Horizontal			
3	2	3	6850.00	-45.76	RMS	35.70	-17.02	0.40	-95.23	30.39	-13.00	-32.76	Horizontal			

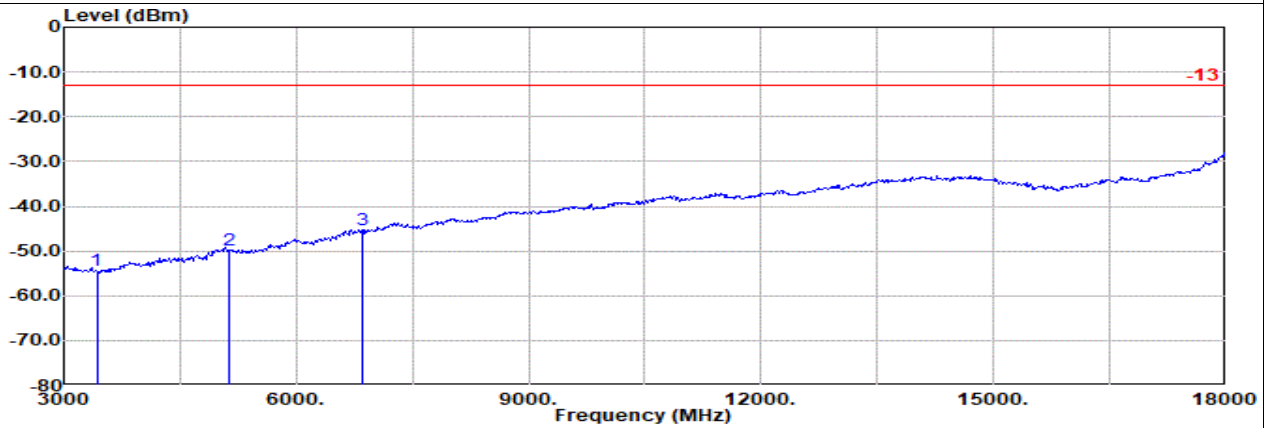

Site : 03CH16-HY
Condition: -13 3m 9120D-1522_240328 Vertical
: WCDMA B4 Ch1312

1	2	3	Freq Level		Detector	Ant Amp\Cb Filter		Factor	Filter		EIRPCF	Readin g	Limit		Margin	Pol
			MHz	dBm		dB/m	dB		dB	dB			dBuV	dBm		
1	2	3	3425.00	-54.20	RMS	29.45	-20.57	0.91	-95.23	31.24	-13.00	-41.20	Vertical			
2	2	3	5137.00	-49.73	RMS	32.97	-18.06	0.46	-95.23	30.13	-13.00	-36.73	Vertical			
3	2	3	6850.00	-45.39	RMS	35.70	-17.02	0.40	-95.23	30.76	-13.00	-32.39	Vertical			



Ant 0

Part 27L Mode 1

WCDMA B4 Ch1413

M

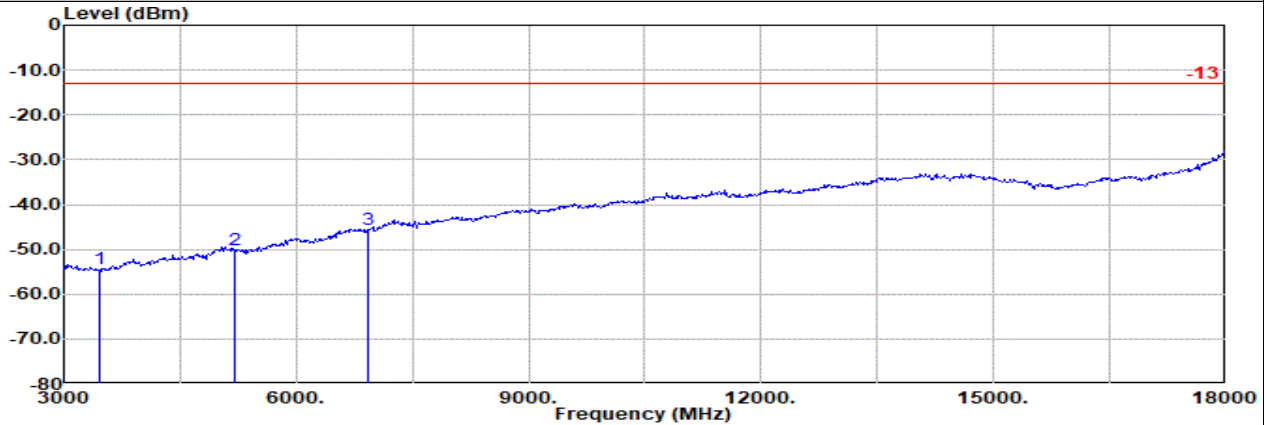

Site : 03CH16-HY
 Condition: -13 3m 9120D-1522_240328 Horizontal
 : WCDMA B4 Ch1413

Freq	Level	Detector	Ant Amp\Cb Filter		EIRPCF	Readin	Limit	Margin Pol	
			Factor	1				g	
MHz	dBm		dB/m	dB	dB	dBuV	dBm	dB	
1 3465.00	-54.44	RMS	29.40	-20.50	0.91 -95.23	30.98	-13.00	-41.44	Horizontal
2 5198.00	-50.24	RMS	33.00	-17.99	0.46 -95.23	29.52	-13.00	-37.24	Horizontal
3 6930.00	-45.56	RMS	35.80	-17.09	0.38 -95.23	30.58	-13.00	-32.56	Horizontal

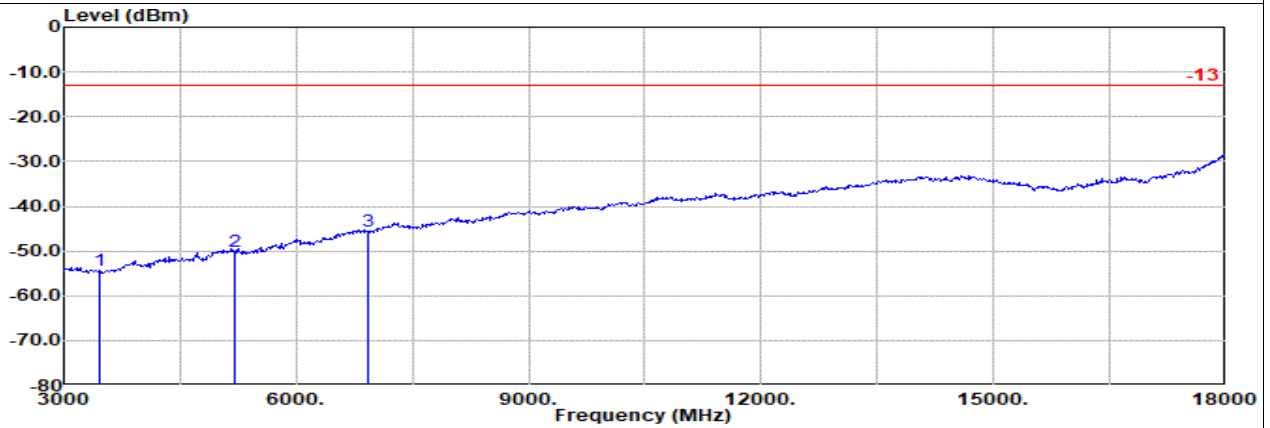

Site : 03CH16-HY
 Condition: -13 3m 9120D-1522_240328 Vertical
 : WCDMA B4 Ch1413

Freq	Level	Detector	Ant Amp\Cb Filter		EIRPCF	Readin	Limit	Margin Pol	
			Factor	1				g	
MHz	dBm		dB/m	dB	dB	dBuV	dBm	dB	
1 3465.00	-54.39	RMS	29.40	-20.50	0.91 -95.23	31.03	-13.00	-41.39	Vertical
2 5198.00	-50.15	RMS	33.00	-17.99	0.46 -95.23	29.61	-13.00	-37.15	Vertical
3 6930.00	-45.61	RMS	35.80	-17.09	0.38 -95.23	30.53	-13.00	-32.61	Vertical



Ant 0

Part 27L Mode 1
WCDMA B4 Ch1513

H

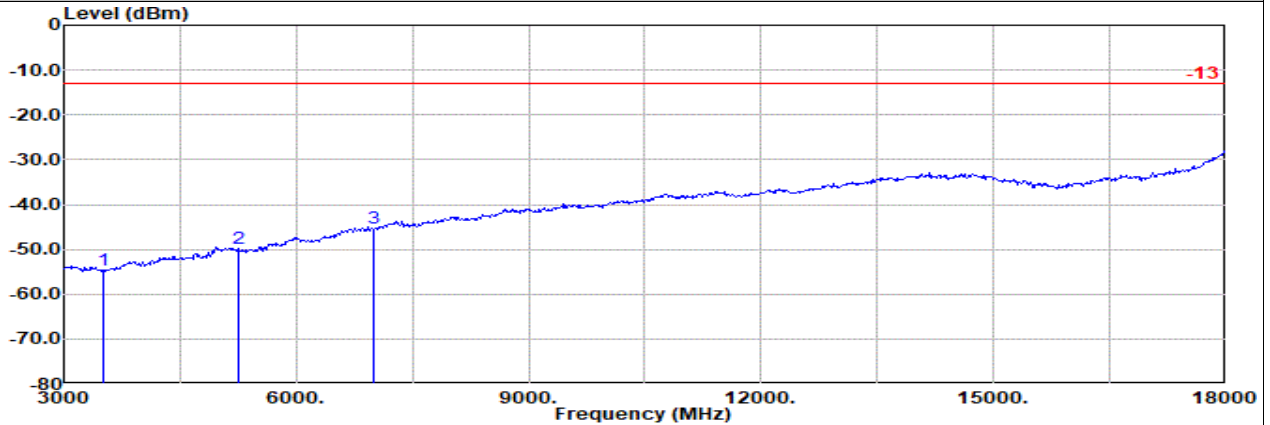

Site : 03CH16-HY
Condition: -13 3m 9120D-1522_240328 Horizontal
: WCDMA B4 Ch1513

Freq	Level	Detector	Ant Amp\Cb		Filter	EIRPCF	Readin	Limit	Margin		Pol
			Factor	1					g	dB	
MHz	dBm		dB/m	dB	dB	dB	dBuV	dBm	dB		
1	3505.00	-54.51 RMS	29.41	-20.44	0.90	-95.23	30.85	-13.00	-41.51	Horizontal	
2	5258.00	-49.92 RMS	32.88	-17.94	0.44	-95.23	29.93	-13.00	-36.92	Horizontal	
3	7010.00	-45.19 RMS	35.84	-17.14	0.38	-95.23	30.96	-13.00	-32.19	Horizontal	

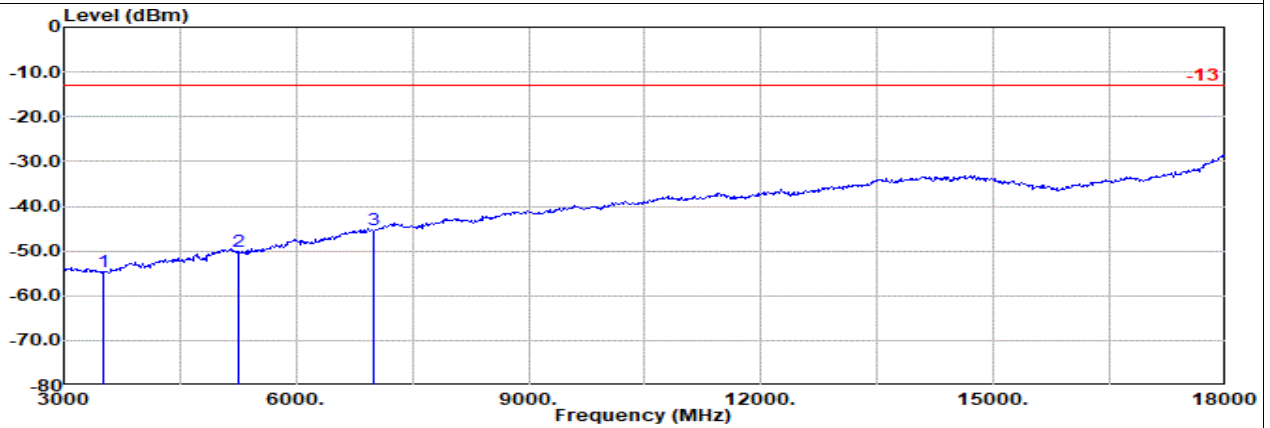

Site : 03CH16-HY
Condition: -13 3m 9120D-1522_240328 Vertical
: WCDMA B4 Ch1513

Freq	Level	Detector	Ant Amp\Cb		Filter	EIRPCF	Readin	Limit	Margin		Pol
			Factor	1					g	dB	
MHz	dBm		dB/m	dB	dB	dB	dBuV	dBm	dB		
1	3505.00	-54.78 RMS	29.41	-20.44	0.90	-95.23	30.58	-13.00	-41.78	Vertical	
2	5258.00	-50.17 RMS	32.88	-17.94	0.44	-95.23	29.68	-13.00	-37.17	Vertical	
3	7010.00	-45.33 RMS	35.84	-17.14	0.38	-95.23	30.82	-13.00	-32.33	Vertical	



Ant 0

Part 24E Mode 1

WCDMA B2 Ch9262

L

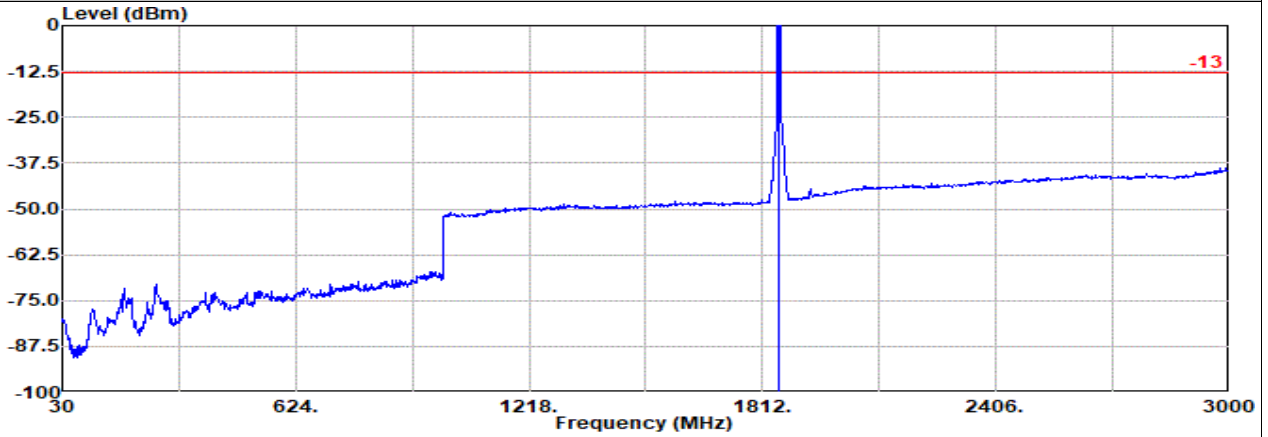

Site : 03CH16-HY
 Condition: -13 3m CBL6111D&00802N1D01N-06 _47020 & 06 Horizontal
 : WCDMA B2 Ch9262
 : #1 is fundamental signal which can be ignored.

Freq	Level	Detector	Ant Factor	Amp	Cb	Filter	EIRPCF	Readin	Limit	Margin	Pol
MHz	dBm		dB/m	dB	dB	dB	dB	dBuV	dBm	dB	
1 1852.00	18.91	RMS	25.14	6.75	0.00	-95.23	82.25	-13.00	31.91	Horizontal	

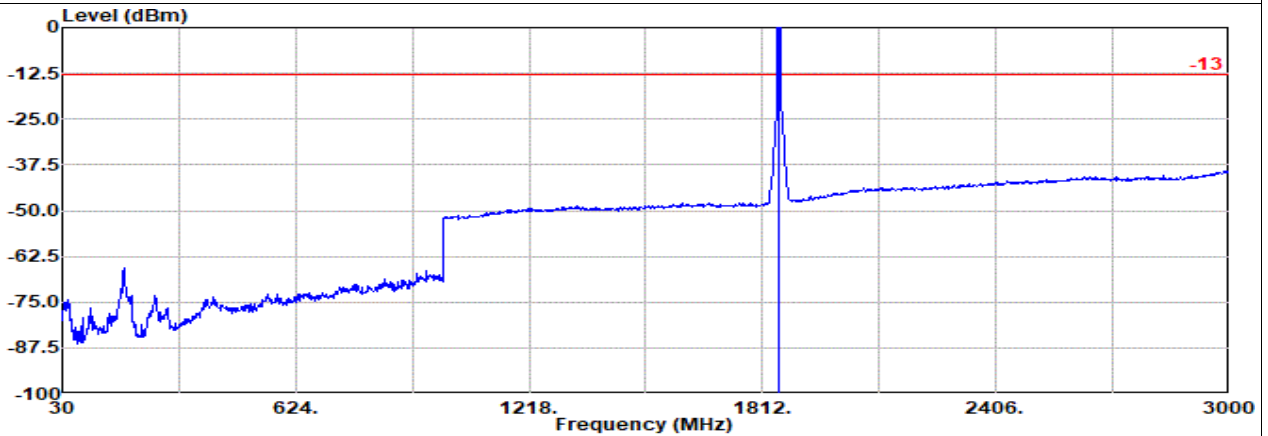

Site : 03CH16-HY
 Condition: -13 3m CBL6111D&00802N1D01N-06 _47020 & 06 Vertical
 : WCDMA B2 Ch9262
 : #1 is fundamental signal which can be ignored.

Freq	Level	Detector	Ant Factor	Amp	Cb	Filter	EIRPCF	Readin	Limit	Margin	Pol
MHz	dBm		dB/m	dB	dB	dB	dB	dBuV	dBm	dB	
1 1852.00	21.33	RMS	25.14	6.75	0.00	-95.23	84.67	-13.00	34.33	Vertical	

Remark: The limit signal #1 is fundamental signal which can be ignored.