



FCC RADIO TEST REPORT

FCC ID : GKRRMLV1
Equipment : 5G LGA Module
Brand Name : COMPAL
Model Name : RML-N1v
Marketing Name : 5G LGA Module
Applicant : Compal Electronics, Inc.
No.581 & 581-1, Ruiguang Rd., Neihu
District, Taipei, (114) Taiwan
Manufacturer : Compal Electronics, Inc.
No.581 & 581-1, Ruiguang Rd., Neihu
District, Taipei, (114) Taiwan
Standard : FCC 47 CFR Part 2, 27

The product was received on Jan. 21, 2022 and testing was performed from Jan. 25, 2022 to Feb. 25, 2022. We, Sporton International Inc. EMC & Wireless Communications Laboratory, would like to declare that the tested sample has been evaluated in accordance with the test procedures given in ANSI / TIA-603-E and has been in compliance with the applicable technical standards.

The test results in this report apply exclusively to the tested model / sample. Without written approval of Sporton International Inc. EMC & Wireless Communications Laboratory, the test report shall not be reproduced except in full.

Louis Wu

Approved by: Louis Wu

Sporton International Inc. EMC & Wireless Communications Laboratory

No. 52, Huaya 1st Rd., Guishan Dist., Taoyuan City 333, Taiwan (R.O.C.)



Table of Contents

History of this test report.....	3
Summary of Test Result.....	4
1 General Description	5
1.1 Product Feature of Equipment Under Test.....	5
1.2 Modification of EUT	5
1.3 Testing Location	6
1.4 Applicable Standards.....	6
2 Test Configuration of Equipment Under Test	7
2.1 Test Mode.....	7
2.2 Connection Diagram of Test System.....	8
2.3 Support Unit used in test configuration and system	8
2.4 Measurement Results Explanation Example.....	8
2.5 Frequency List of Low/Middle/High Channels	9
3 Conducted Test Items.....	10
3.1 Measuring Instruments	10
3.2 Conducted Output Power and EIRP	11
3.3 Peak-to-Average Ratio	13
3.4 Occupied Bandwidth.....	14
3.5 Conducted Band Edge	15
3.6 Conducted Spurious Emission	16
3.7 Frequency Stability	17
4 Radiated Test Items	18
4.1 Measuring Instruments	18
4.2 Radiated Spurious Emission Measurement	20
5 List of Measuring Equipment.....	21
6 Uncertainty of Evaluation.....	23
Appendix A. Test Results of Conducted Test	
Appendix B. Test Results of Radiated Test	
Appendix C. Test Setup Photographs	



History of this test report

Report No.	Version	Description	Issued Date
FG210421-02G	01	Initial issue of report	May 24, 2022
FG210421-02G	02	Revise antenna information	May 26, 2022
FG210421-02G	03	1. Revise appendix A1 ~ A4 2. Add remark description in section 1.1	Jul. 14, 2022



Summary of Test Result

Report Clause	Ref Std. Clause	Test Items	Result (PASS/FAIL)	Remark
3.2	§2.1046	Conducted Output Power	Reporting only	-
	§27.50 (j)(3)	Equivalent Isotropic Radiated Power (n77)	Pass	
3.3	§27.50 (j)(4)	Peak-to-Average Ratio	Reporting only	-
3.4	§2.1049	Occupied Bandwidth	Reporting only	-
3.5	§2.1051 §27.53 (l)(2)	Conducted Band Edge Measurement (n77)	Pass	-
3.6	§2.1051 §27.53 (l)(2)	Conducted Spurious Emission (n77)	Pass	-
3.7	§2.1055 §27.54	Frequency Stability Temperature & Voltage	Pass	-
4.2	§2.1051 §27.53 (l)(2)	Radiated Spurious Emission (n77)	Pass	Under limit 19.56 dB at 15165.000 MHz

Declaration of Conformity:

- The test results (PASS/FAIL) with all measurement uncertainty excluded are presented in accordance with the regulation limits or requirements declared by manufacturers.
It's means measurement values may risk exceeding the limit of regulation standards, if measurement uncertainty is include in test results.
- The measurement uncertainty please refer to this report "Uncertainty of Evaluation".

Comments and Explanations:

The product specifications of the EUT presented in the report are declared by the manufacturer who shall take full responsibility for the authenticity.

Reviewed by: Keven Cheng

Report Producer: Vivian Hsu



1 General Description

1.1 Product Feature of Equipment Under Test

LTE/5G NR and GNSS

Product Specification subjective to this standard	
Test Antenna Type	Monopole Antenna
Test Antenna Gain	<Ant. 2> 5G NR n77: -1.67 dBi <Ant. 4> 5G NR n77: -1.3 dBi <Ant. 5> 5G NR n77: -1.94 dBi <Ant. 6> 5G NR n77: -1.32 dBi

Remark:

1. The above EUT's information was declared by manufacturer. Please refer to Comments and Explanations in report summary.
2. The above antenna information was declared by manufacturer and used for Radiated Spurious Emission test.

1.2 Modification of EUT

No modifications are made to the EUT during all test items.



1.3 Testing Location

Test Site	Sporton International Inc. EMC & Wireless Communications Laboratory
Test Site Location	No.52, Huaya 1st Rd., Guishan Dist., Taoyuan City 333, Taiwan (R.O.C.) TEL: +886-3-327-3456 FAX: +886-3-328-4978
Test Site No.	Sporton Site No.
	TH03-HY
Test Engineer	Ivy Yeh
Temperature (°C)	20~24
Relative Humidity (%)	50~58

Test Site	Sporton International Inc. Wensan Laboratory.
Test Site Location	No.58, Aly. 75, Ln. 564, Wenhua 3rd, Rd., Guishan Dist., Taoyuan City 333010, Taiwan (R.O.C.) TEL: +886-3-327-0868 FAX: +886-3-327-0855
Test Site No.	Sporton Site No.
	03CH12-HY (TAF Code: 3786)
Test Engineer	Jack Cheng, Lance Chiang and Chuan Chu
Temperature (°C)	21.2~24.2
Relative Humidity (%)	58.2~68.8
Remark	The Radiated Spurious Emission test item subcontracted to Sporton International Inc. Wensan Laboratory.

Note: The test site complies with ANSI C63.4 2014 requirement.

FCC Designation No.: TW1190 and TW3786

1.4 Applicable Standards

According to the specifications of the manufacturer, the EUT must comply with the requirements of the following standards:

- ♦ ANSI C63.26-2015
- ♦ ANSI / TIA-603-E
- ♦ FCC 47 CFR Part 2, 27
- ♦ FCC KDB 971168 D01 Power Meas. License Digital Systems v03r01
- ♦ FCC KDB 412172 D01 Determining ERP and EIRP v01r01
- ♦ FCC KDB 414788 D01 Radiated Test Site v01r01

Remark:

1. All test items were verified and recorded according to the standards and without any deviation during the test.
2. This EUT has also been tested and complied with the requirements of FCC Part 15, Subpart B, recorded in a separate test report.
3. The TAF code is not including all the FCC KDB listed without accreditation.



2 Test Configuration of Equipment Under Test

2.1 Test Mode

Antenna port conducted and radiated test items listed below are performed according to KDB 971168 D01 Power Meas. License Digital Systems v03r01 with maximum output power.

For radiated measurement, the measured emission level of the EUT was maximized by rotating the EUT on a turntable, adjusting the orientation of the EUT and EUT antenna in three orthogonal axis (X: flat, Y: portrait, Z: landscape), and adjusting the measurement antenna orientation, following C63.26 exploratory test procedures and find: Y Plane for Ant. 5, MIMO <Ant. 4+2>, MIMO <Ant. 4 + 5>, MIMO <Ant. 5+2>, MIMO <Ant. 5+6>; Z Plane for Ant. 4, MIMO <Ant. 4+6> with Adapter as worst plane.

Test Items	NR Band	Bandwidth (MHz)											Modulation					RB #			Test Channel		
		10	15	20	30	40	50	60	70	80	90	100	PI/2 BPSK	QPSK	16QAM	64QAM	256QAM	1	Half	Full	L	M	H
Max. Output Power	n77	v	v	v		v	v	v		v	v	v	v	v	v	v	v	v	v	v	v	v	v
Peak-to-Average Ratio	n77			v								v	v	v	v	v			v		v		
26dB and 99% Bandwidth	n77	v	v	v		v	v	v		v	v	v	v	v	v	v	v			v		v	
Conducted Band Edge	n77	v	v	v		v	v	v		v	v	v	v	v	v	v	v	v		v	v		v
Conducted Spurious Emission	n77	v											v				v			v	v	v	
Frequency Stability	n77			v									v						v		v		
E.I.R.P	n77	v	v	v		v	v	v		v	v	v	v	v	v	v	v	Max. Power					
Radiated Spurious Emission	n77	Worst Case																			v	v	v
Remark	<ol style="list-style-type: none"> The mark "v" means that this configuration is chosen for testing The mark "-" means that this bandwidth is not supported. The device is investigated from 30MHz to 10 times of fundamental signal for radiated spurious emission test under different RB size/offset and modulations in exploratory test. Subsequently, only the worst case emissions are reported. For radiated measurement, pre-scanned in two modes, DFT-s OFDM and CP OFDM. The worst cases (DFT-s OFDM) were recorded in this report, and the worst modes of FR1 and LTE for simultaneous transmission were verified and compliant. In Ant 5 radiated measurement NSA mode ,pre-scanned the EN-DC combination the worst modes is EN-DC 66A-n77A tested by low, middle, high channels and were recorded in this report For 5G NR n77 support Ant. 2, Ant. 4, Ant. 5, Ant. 6, after verified, the worst case is Ant 5 for SA Mode ,ANT5+6 for MIMO Mode,. Therefore, only performed the Ant 5 &Ant5+6 test results for Conducted test item in this report. For 5G NR BW:10/15/20/40/50 support SCS15kHz&SCS30 kHz, after verified, the worst case is SCS15kHz. Therefore, only performed the SCS15kHz test results for Conducted test item in this report. 																						

2.2 Connection Diagram of Test System

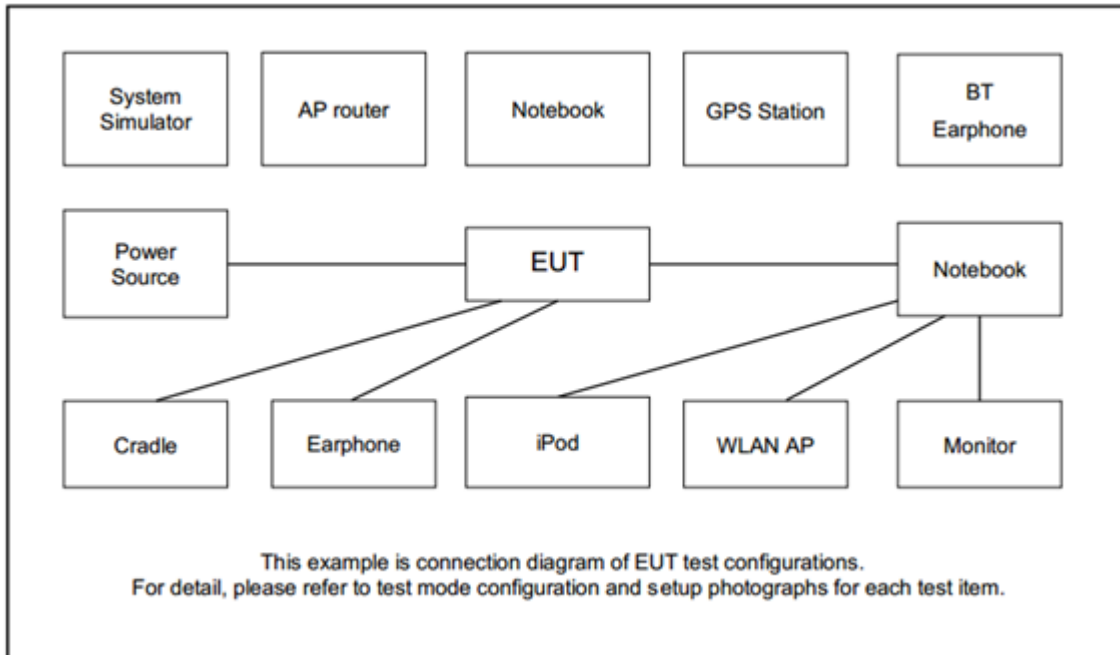

2.3 Support Unit used in test configuration and system

Item	Equipment	Brand Name	Model No.	FCC ID	Data Cable	Power Cord
1.	Radio Communication Analyzer	Anritsu	MT8821C	N/A	N/A	Unshielded, 1.8 m
2.	5G Wireless Test Platform	Anritsu	MT8000A	N/A	N/A	Unshielded, 1.8 m
3.	Fixture	Compal	ZM32	N/A	N/A	N/A

2.4 Measurement Results Explanation Example

For all conducted test items:

The offset level is set in the spectrum analyzer to compensate the RF cable loss and attenuator factor between EUT conducted output port and spectrum analyzer. With the offset compensation, the spectrum analyzer reading level is exactly the EUT RF output level.

The spectrum analyzer offset is derived from RF cable loss and attenuator factor.

Offset = RF cable loss + attenuator factor.

Following shows an offset computation example with cable loss 4.2 dB and 10dB attenuator.

Example :

$$\begin{aligned} \text{Offset(dB)} &= \text{RF cable loss(dB)} + \text{attenuator factor(dB)}. \\ &= 4.2 + 10 = 14.2 \text{ (dB)} \end{aligned}$$



2.5 Frequency List of Low/Middle/High Channels

5G NR Band n77 Channel and Frequency List				
BW [MHz]	Channel/Frequency(MHz)	Lowest	Middle	Highest
100	Channel	650000	656000	662000
	Frequency	3750	3840	3930
90	Channel	649668	656000	662332
	Frequency	3745.02	3840	3934.98
80	Channel	649334	656000	662666
	Frequency	3740.01	3840	3939.99
70	Channel	649000	656000	663000
	Frequency	3735	3840	3945
60	Channel	648668	656000	663332
	Frequency	3730.02	3840	3949.98
50	Channel	648334	656000	663666
	Frequency	3725.01	3840	3954.99
40	Channel	648000	656000	664000
	Frequency	3720	3840	3960
30	Channel	647668	656000	664332
	Frequency	3715.02	3840	3965
20	Channel	647334	656000	664666
	Frequency	3710.01	3840	3969.99
15	Channel	647168	656000	664832
	Frequency	3707.52	3840	3972.48
10	Channel	647000	656000	665000
	Frequency	3705	3840	3975

3 Conducted Test Items

3.1 Measuring Instruments

See list of measuring instruments of this test report.

3.1.1 Test Setup

3.1.2 Conducted Output Power

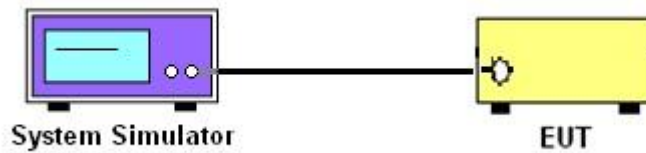

3.1.3 Peak-to-Average Ratio, Occupied Bandwidth ,Conducted Band-Edge and Conducted Spurious Emission

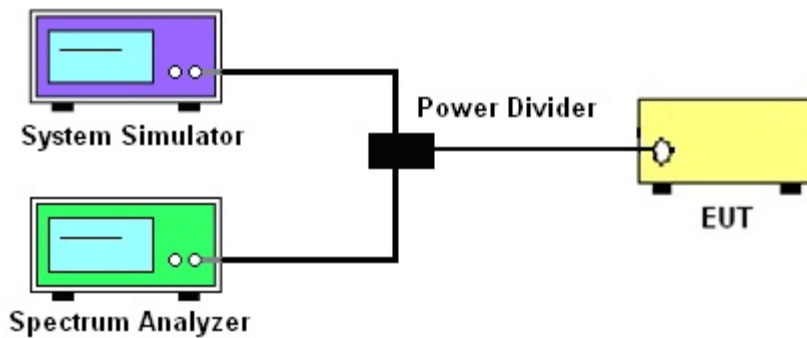

3.1.4 Frequency Stability

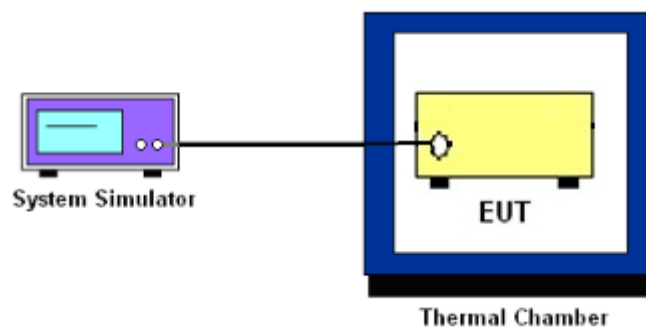

3.1.5 Test Result of Conducted Test

Please refer to Appendix A.

3.2 Conducted Output Power and EIRP

3.2.1 Description of the Conducted Output Power Measurement and EIRP

Measurement

A system simulator was used to establish communication with the EUT. Its parameters were set to force the EUT transmitting at maximum output power. The measured power in the radio frequency on the transmitter output terminals shall be reported.

The EIRP of mobile transmitters must not exceed 1 Watts for 5G NR n77

According to KDB 412172 D01 Power Approach,

$EIRP = P_T + G_T - L_C$, $ERP = EIRP - 2.15$, where

P_T = transmitter output power in dBm

G_T = gain of the transmitting antenna in dBi

L_C = signal attenuation in the connecting cable between the transmitter and antenna in dB

Note: For MIMO mode, the directional gain calculation is following F)2)f)ii) of KDB 662911 D01 v02r01.

$$DirectionalGain = 10 \cdot \log \left[\frac{\sum_{j=1}^{N_{SS}} \left\{ \sum_{k=1}^{N_{ANT}} g_{j,k} \right\}^2}{N_{ANT}} \right]$$

where

Each antenna is driven by no more than one spatial stream;

N_{SS} = the number of independent spatial streams of data;

N_{ANT} = the total number of antennas

$g_{j,k} = 10^{G_k/20}$ if the k th antenna is being fed by spatial stream j , or zero if it is not;

G_k is the gain in dBi of the k th antenna.

The directional gain “DG” is calculated as following table.

	Ant 2 (dBi)	Ant 4 (dBi)	Ant 5 (dBi)	Ant 6 (dBi)	Directional gain (dBi)
5G NR n77	-	-	-1.94	-1.32	1.39
	-1.67	-	-1.94	-	1.21
	-1.67	-1.3	-	-	1.53
		-1.3		-1.32	1.7



3.2.2 Test Procedures

1. The transmitter output port was connected to the system simulator.
2. Set EUT at maximum power through the system simulator.
3. Select lowest, middle, and highest channels for each band and different modulation.
4. Measure and record the power level from the system simulator.



3.3 Peak-to-Average Ratio

3.3.1 Description of the PAR Measurement

Power Complementary Cumulative Distribution Function (CCDF) curves provide a means for characterizing the power peaks of a digitally modulated signal on a statistical basis. A CCDF curve depicts the probability of the peak signal amplitude exceeding the average power level. Most contemporary measurement instrumentation include the capability to produce CCDF curves for an input signal provided that the instrument's resolution bandwidth can be set wide enough to accommodate the entire input signal bandwidth. In measuring transmissions in this band using an average power technique, the peak-to-average ratio (PAR) of the transmission may not exceed 13 dB.

3.3.2 Test Procedures

The testing follows ANSI C63.26-2015 Section 5.2.6

1. The EUT was connected to spectrum and system simulator via a power divider.
2. Set the CCDF (Complementary Cumulative Distribution Function) option in spectrum analyzer.
3. The highest RF powers were measured and recorded the maximum PAPR level associated with a probability of 0.1 %.
4. Record the deviation as Peak to Average Ratio.



3.4 Occupied Bandwidth

3.4.1 Description of Occupied Bandwidth Measurement

The occupied bandwidth is the width of a frequency band such that, below the lower and above the upper frequency limits, the mean powers emitted are each equal to a specified percentage 0.5% of the total mean transmitted power.

The 26 dB emission bandwidth is defined as the frequency range between two points, one above and one below the carrier frequency, at which the spectral density of the emission is attenuated 26 dB below the maximum in-band spectral density of the modulated signal. Spectral density (power per unit bandwidth) is to be measured with a detector of resolution bandwidth equal to approximately 1.0% of the emission bandwidth.

3.4.2 Test Procedures

The testing follows ANSI C63.26-2015 Section 5.4.3 (26dB) and Section 5.4.4 (99OB)

1. The EUT was connected to spectrum analyzer and system simulator via a power divider.
2. The spectrum analyzer center frequency is set to the nominal EUT channel center frequency. The span range for the spectrum analyzer shall be between two and five times the anticipated OBW.
3. The nominal resolution bandwidth (RBW) shall be in the range of 1 to 5 % of the anticipated OBW, and the VBW shall be at least 3 times the RBW.
4. Set the detection mode to peak, and the trace mode to max hold.
5. Determine the reference value: Set the EUT to transmit a modulated signal. Allow the trace to stabilize. Set the spectrum analyzer marker to the highest level of the displayed trace.
(this is the reference value)
6. Determine the “-26 dB down amplitude” as equal to (Reference Value – X).
7. Place two markers, one at the lowest and the other at the highest frequency of the envelope of the spectral display such that each marker is at or slightly below the “-X dB down amplitude” determined in step 6. If a marker is below this “-X dB down amplitude” value it shall be placed as close as possible to this value. The OBW is the positive frequency difference between the two markers.
8. Use the 99 % power bandwidth function of the spectrum analyzer and report the measured bandwidth.



3.5 Conducted Band Edge

3.5.1 Description of Conducted Band Edge Measurement

27.53 (I)(2)

For mobile operations in the 3700-3980 MHz band, the conducted power of any emission outside the licensee's authorized bandwidth shall not exceed -13 dBm/MHz. Compliance with this paragraph (I)(2) is based on the use of measurement instrumentation employing a resolution bandwidth of 1 megahertz or greater. However, in the 1 megahertz bands immediately outside and adjacent to the licensee's frequency block, the minimum resolution bandwidth for the measurement shall be either one percent of the emission bandwidth of the fundamental emission of the transmitter or 350 kHz. In the bands between 1 and 5 MHz removed from the licensee's frequency block, the minimum resolution bandwidth for the measurement shall be 500 kHz. The emission bandwidth is defined as the width of the signal between two points, one below the carrier center frequency and one above the carrier center frequency, outside of which all emissions are attenuated at least 26 dB below the transmitter power.

3.5.2 Test Procedures

The testing follows FCC KDB 971168 D01 v03r01 Section 6.1.

1. The EUT was connected to spectrum analyzer and system simulator via a power divider.
2. The band edges of low and high channels for the highest RF powers were measured.
3. Set RBW $\geq 1\%$ EBW in the 1MHz band immediately outside and adjacent to the band edge.
4. Beyond the 1 MHz band from the band edge, RBW=1MHz was used.
5. Set spectrum analyzer with RMS detector.
6. The RF fundamental frequency should be excluded against the limit line in the operating frequency band.
7. Checked that all the results comply with the emission limit line.

The limit line is derived from $43 + 10\log(P)$ dB below the transmitter power P(Watts)



3.6 Conducted Spurious Emission

3.6.1 Description of Conducted Spurious Emission Measurement

The power of any emission outside of the authorized operating frequency ranges must be lower than the transmitter power (P) by a factor of at least $43 + 10 \log (P)$ dB.

3.6.2 Test Procedures

The testing follows FCC KDB 971168 D01 v03r01 Section 6.1.

1. The EUT was connected to spectrum analyzer and system simulator via a power divider.
2. The RF output of EUT was connected to the spectrum analyzer by RF cable and attenuator. The path loss was compensated to the results for each measurement.
3. The middle channel for the highest RF power within the transmitting frequency was measured.
4. The conducted spurious emission for the whole frequency range was taken.
5. Make the measurement with the spectrum analyzer's RBW = 1MHz, VBW = 3MHz.
6. Set spectrum analyzer with RMS detector.
7. Taking the record of maximum spurious emission.
8. The RF fundamental frequency should be excluded against the limit line in the operating frequency band.
9. The limit line is derived from $43 + 10\log(P)$ dB below the transmitter power P(Watts)



3.7 Frequency Stability

3.7.1 Description of Frequency Stability Measurement

27.54

The frequency stability shall be sufficient to ensure that the fundamental emission stays within the authorized frequency block.

3.7.2 Test Procedures for Temperature Variation

The testing follows FCC KDB 971168 D01 v03r01 Section 9.0.

1. The EUT was set up in the thermal chamber and connected with the system simulator.
2. With power OFF, the temperature was decreased to -30°C and the EUT was stabilized before testing. Power was applied and the maximum change in frequency was recorded within one minute.
3. With power OFF, the temperature was raised in 10°C step up to 50°C . The EUT was stabilized at each step for at least half an hour. Power was applied and the maximum frequency change was recorded within one minute.

3.7.3 Test Procedures for Voltage Variation

The testing follows FCC KDB 971168 D01 v03r01 Section 9.0.

1. The EUT was placed in a temperature chamber at $20\pm 5^{\circ}\text{C}$ and connected with the system simulator.
2. The power supply voltage to the EUT was varied from 85% to 115% of the nominal value measured at the input to the EUT.
3. The variation in frequency was measured for the worst case.

4 Radiated Test Items

4.1 Measuring Instruments

See list of measuring instruments of this test report.

4.1.1 Test Setup

For radiated emissions below 30MHz

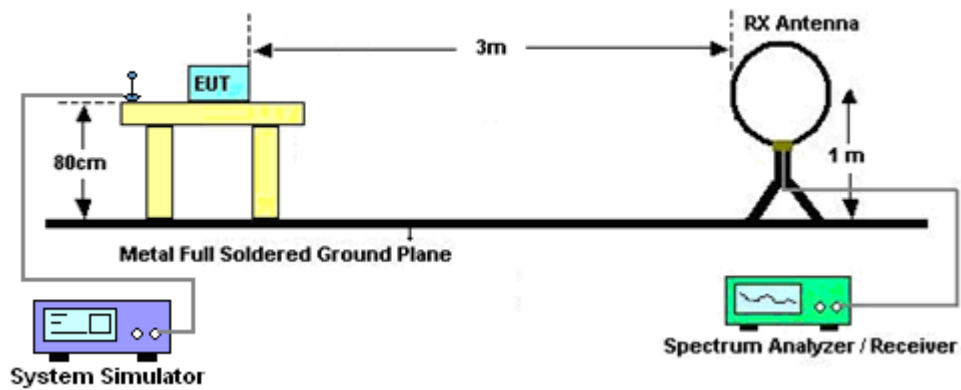

For radiated test from 30MHz to 1GHz

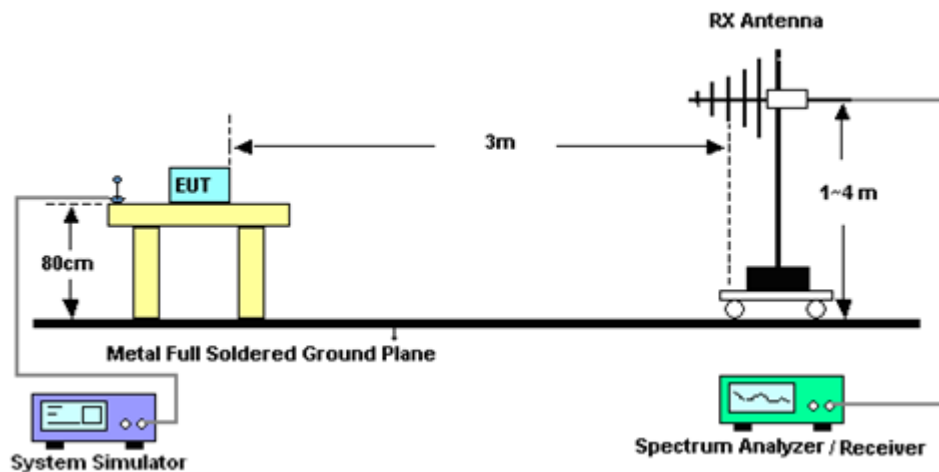

For radiated test from 1GHz to 18GHz

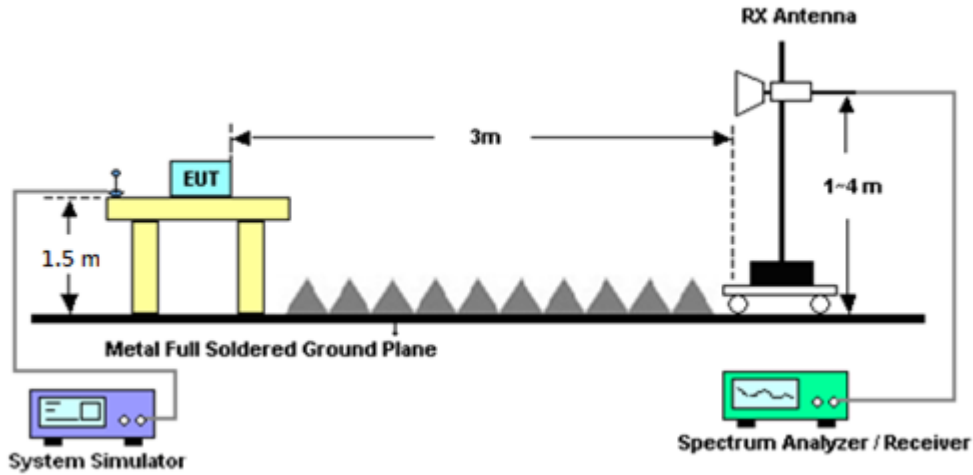

For radiated test above 18GHz

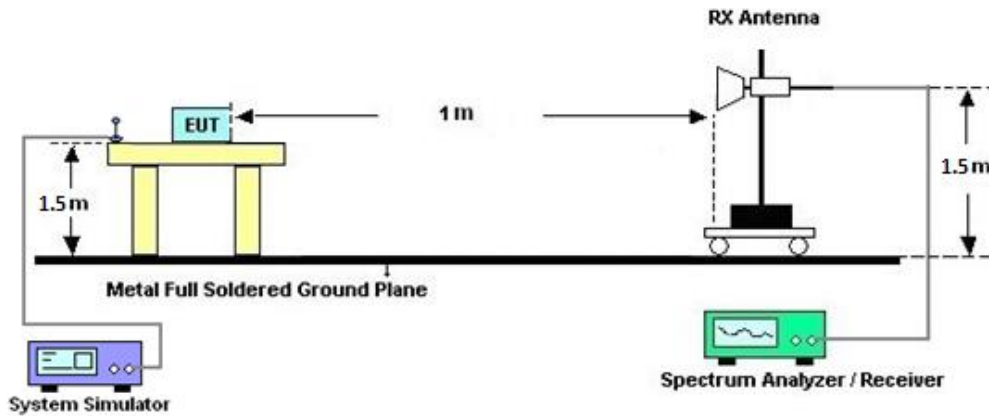

4.1.2 Test Result of Radiated Test

Please refer to Appendix B.

Note:

The low frequency, which started from 9 kHz to 30MHz, was pre-scanned and the result which was 20dB lower than the limit line was not reported.

There is adequate comparison measurement of both open-field test site and alternative test site - semi-Anechoic chamber according to 414788 D01 Radiated Test Site v01r01, and the result came out very similar.



4.2 Radiated Spurious Emission Measurement

4.2.1 Description of Radiated Spurious Emission Measurement

The radiated spurious emission was measured by substitution method according to ANSI / TIA-603-E. The power of any emission outside of the authorized operating frequency ranges must be attenuated below the transmitter power (P) by a factor of at least $43 + 10 \log (P)$ dB.

4.2.2 Test Procedures

The testing follows FCC KDB 971168 D01 v03r01 Section 7 and ANSI / TIA-603-E Section 2.2.12.

1. The EUT was placed on a turntable with 0.8 meter for frequency below 1GHz and 1.5 meter for frequency above 1GHz respectively above ground.
2. The EUT was set 3 meters from the receiving antenna, which was mounted on the antenna tower.
3. The table was rotated 360 degrees to determine the position of the highest spurious emission.
4. The height of the receiving antenna is varied between one meter and four meters to search the maximum spurious emission for both horizontal and vertical polarizations.
5. Make the measurement with the spectrum analyzer's RBW = 1MHz, VBW = 3MHz, taking the record of maximum spurious emission.
6. A horn antenna was substituted in place of the EUT and was driven by a signal generator.
7. Tune the output power of signal generator to the same emission level with EUT maximum spurious emission.
8. Taking the record of output power at antenna port.
9. Repeat step 7 to step 8 for another polarization.
10. The RF fundamental frequency should be excluded against the limit line in the operating frequency band.

The limit line is derived from $43 + 10\log(P)$ dB below the transmitter power P(Watts)



5 List of Measuring Equipment

Instrument	Brand Name	Model No.	Serial No.	Characteristics	Calibration Date	Test Date	Due Date	Remark
Loop Antenna	Rohde & Schwarz	HFH2-Z2	100488	9 kHz~30 MHz	Sep. 07, 2021	Jan. 28, 2022~ Feb. 25, 2022	Sep. 06, 2022	Radiation (03CH12-HY)
Bilog Antenna	TESEQ	CBL 6111D & 00800N1D01N -06	37059 & 01	30MHz~1GHz	Oct. 09, 2021	Jan. 28, 2022~ Feb. 25, 2022	Oct. 08, 2022	Radiation (03CH12-HY)
Bilog Antenna	TESEQ	CBL 6111D & N-6-06	35414 & AT-N0602	30MHz~1GHz	Oct. 09, 2021	Jan. 28, 2022~ Feb. 25, 2022	Oct. 08, 2022	Radiation (03CH12-HY)
Horn Antenna	SCHWARZBE CK	BBHA 9120 D	9120D-1326	1GHz~18GHz	Oct. 25, 2021	Jan. 28, 2022~ Feb. 25, 2022	Oct. 24, 2022	Radiation (03CH12-HY)
Horn Antenna	SCHWARZBE CK	BBHA 9120 D	9120D-1212	1GHz~18GHz	May 18, 2021	Jan. 28, 2022~ Feb. 25, 2022	May 17, 2022	Radiation (03CH12-HY)
SHF-EHF Horn Antenna	SCHWARZBE CK	BBHA 9170	BBHA91702 51	18GHz~40GHz	Nov. 30, 2021	Jan. 28, 2022~ Feb. 25, 2022	Nov. 29, 2022	Radiation (03CH12-HY)
SHF-EHF Horn Antenna	SCHWARZBE CK	BBHA 9170	BBHA91705 76	18GHz~40GHz	May 21, 2021	Jan. 28, 2022~ Feb. 25, 2022	May 20, 2022	Radiation (03CH12-HY)
Preamplifier	COM-POWER	PA-103	161075	10MHz~1GHz	Mar. 24, 2021	Jan. 28, 2022~ Feb. 25, 2022	Mar. 23, 2022	Radiation (03CH12-HY)
Preamplifier	Aglient	8449B	3008A02375	1GHz~26.5GHz	May 25, 2021	Jan. 28, 2022~ Feb. 25, 2022	May 24, 2022	Radiation (03CH12-HY)
Preamplifier	E-INSTRUME NT TECH LTD.	ERA-100M-18 G-56-01-A70	EC1900270	1GHz-18GHz	Dec. 27, 2021	Jan. 28, 2022~ Feb. 25, 2022	Dec. 26, 2022	Radiation (03CH12-HY)
Preamplifier	EMEC	EM18G40G	060801	18GHz~40GHz	Jun. 22, 2021	Jan. 28, 2022~ Feb. 25, 2022	Jun. 21, 2022	Radiation (03CH12-HY)
Spectrum Analyzer	Keysight	N9010A	MY54200486	10Hz~44GHz	Oct. 15, 2021	Jan. 28, 2022~ Feb. 25, 2022	Oct. 14, 2022	Radiation (03CH12-HY)
RF Cable	HUBER + SUHNER	SUCOFLEX 126E	0058/126E	30MHz~18GHz	Dec. 10, 2021	Jan. 28, 2022~ Feb. 25, 2022	Dec. 09, 2022	Radiation (03CH12-HY)
RF Cable	HUBER + SUHNER	SUCOFLEX 102	505134/2	30MHz~40GHz	Feb. 22, 2021	Jan. 28, 2022~ Feb. 20, 2022	Feb. 21, 2022	Radiation (03CH12-HY)
RF Cable	HUBER + SUHNER	SUCOFLEX 102	505134/2	30MHz~40GHz	Feb. 21, 2022	Feb. 21, 2022~ Feb. 25, 2022	Feb. 20, 2023	Radiation (03CH12-HY)
RF Cable	HUBER + SUHNER	SUCOFLEX 102	800740/2	30MHz~40GHz	Feb. 22, 2021	Jan. 28, 2022~ Feb. 20, 2022	Feb. 21, 2022	Radiation (03CH12-HY)
RF Cable	HUBER + SUHNER	SUCOFLEX 102	800740/2	30MHz~40GHz	Feb. 21, 2022	Feb. 21, 2022~ Feb. 25, 2022	Feb. 20, 2023	Radiation (03CH12-HY)
Filter	Wainwright	WLKS1200-12 SS	SN2	1.2GHz Low Pass Filter	Mar. 17, 2021	Jan. 28, 2022~ Feb. 25, 2022	Mar. 16, 2022	Radiation (03CH12-HY)
Filter	Wainwright	WHKX12-1080 -1200-15000-6 0SS	SN1	1.2GHz High Pass Filter	Mar. 17, 2021	Jan. 28, 2022~ Feb. 25, 2022	Mar. 16, 2022	Radiation (03CH12-HY)
Filter	Wainwright	WHKX12-2700 -3000-18000-6 0ST	SN2	3GHz High Pass Filter	Jul. 12, 2021	Jan. 28, 2022~ Feb. 25, 2022	Jul. 11, 2022	Radiation (03CH12-HY)
Filter	Wainwright	WHKX8-5872. 5-6750-18000- 40ST	SN2	6.75GHz High Pass Filter	Mar. 17, 2021	Jan. 28, 2022~ Feb. 25, 2022	Mar. 16, 2022	Radiation (03CH12-HY)
Hygrometer	TECPEL	DTM-303B	TP140349	N/A	Sep. 30, 2021	Jan. 28, 2022~ Feb. 25, 2022	Sep. 29, 2022	Radiation (03CH12-HY)
Controller	EMEC	EM1000	N/A	Control Turn table & Ant Mast	N/A	Jan. 28, 2022~ Feb. 25, 2022	N/A	Radiation (03CH12-HY)
Antenna Mast	EMEC	AM-BS-4500-B	N/A	1m~4m	N/A	Jan. 28, 2022~ Feb. 25, 2022	N/A	Radiation (03CH12-HY)
Turn Table	EMEC	TT2000	N/A	0~360 Degree	N/A	Jan. 28, 2022~ Feb. 25, 2022	N/A	Radiation (03CH12-HY)
Software	Audix	E3 6.2009-8-24	RK-000989	N/A	N/A	Jan. 28, 2022~ Feb. 25, 2022	N/A	Radiation (03CH12-HY)



Instrument	Brand Name	Model No.	Serial No.	Characteristics	Calibration Date	Test Date	Due Date	Remark
Programmable Power Supply	GW Instek	PSS-2005	EL890001	50Hz~60Hz	Oct. 06, 2021	Jan. 25, 2022~ Feb. 11, 2022	Oct. 05, 2022	Conducted (TH03-HY)
Signal Analyzer	Rohde & Schwarz	FSV3044	101048	10Hz~44GHz	Apr. 20, 2021	Jan. 25, 2022~ Feb. 11, 2022	Apr. 19, 2022	Conducted (TH03-HY)
Temperature Chamber	ESPEC	SU-241	92003713	-30°C ~95°C	May 21, 2021	Jan. 25, 2022~ Feb. 11, 2022	May 20, 2022	Conducted (TH03-HY)
Hygrometer	TECPEL	DTM-303B	TP200886	NA	Mar. 09, 2021	Jan. 25, 2022~ Feb. 11, 2022	Mar. 08, 2022	Conducted (TH03-HY)
Base Station (Measure)	Anritsu	MT8821C	6261849015	LTE	Oct. 06, 2021	Jan. 25, 2022~ Feb. 11, 2022	Oct. 05, 2022	Conducted (TH03-HY)
Base Station (Measure)	Anritsu	MT8000A	6261940327	FR1	Oct. 29, 2021	Jan. 25, 2022~ Feb. 11, 2022	Oct. 28, 2022	Conducted (TH03-HY)



6 Uncertainty of Evaluation

Uncertainty of Radiated Emission Measurement (30 MHz ~ 1000 MHz)

Measuring Uncertainty for a Level of Confidence of 95% ($U = 2Uc(y)$)	3.10 dB
---	---------

Uncertainty of Radiated Emission Measurement (1 GHz ~ 18 GHz)

Measuring Uncertainty for a Level of Confidence of 95% ($U = 2Uc(y)$)	3.39 dB
---	---------

Uncertainty of Radiated Emission Measurement (18 GHz ~ 40 GHz)

Measuring Uncertainty for a Level of Confidence of 95% ($U = 2Uc(y)$)	4.34 dB
---	---------



Appendix A. Test Results of Conducted Test

Conducted Output Power(Average power) and EIRP

<SISO Mode>

Sub carrier spacing : 15kHz

NR n77 Maximum Average Power [dBm] (GT - LC = 2 dB)								
BW [MHz]	RB Size	RB Offset	Mod	Lowest	Middle	Highest	EIRP (dBm)	EIRP(W)
10	1	1	PI/2 BPSK	27.36	27.14	27.13	29.49	0.8892
10	1	50		27.42	27.18	27.26		
10	25	12		27.41	27.22	27.24		
10	1	0		23.85	23.73	23.66		
10	1	51		24.03	23.84	23.88		
10	50	0		26.93	26.74	26.71		
10	1	1	QPSK	27.37	27.14	27.12		
10	1	50		27.49	27.21	27.20		
10	25	12		27.44	27.24	27.24		
10	1	0		23.88	23.68	23.63		
10	1	51		24.03	23.80	23.80		
10	50	0		26.42	26.23	26.26		
10	1	1	16-QAM	26.23	25.93	26.01	28.23	0.6653
10	1	1	64-QAM	24.84	24.73	24.56		
10	1	1	256-QAM	22.70	22.53	22.52		
Limit	EIRP < 1W			Result			Pass	

NR n77 Maximum Average Power [dBm] (GT - LC = 2 dB)								
BW [MHz]	RB Size	RB Offset	Mod	Lowest	Middle	Highest	EIRP (dBm)	EIRP(W)
15	1	1	PI/2 BPSK	27.32	27.10	27.22	29.48	0.8872
15	1	77		27.44	27.21	27.23		
15	36	18		27.45	27.22	27.29		
15	1	0		23.92	23.65	23.80		
15	1	78		24.03	23.87	23.88		
15	75	0		26.95	26.74	26.78		
15	1	1	QPSK	27.37	27.11	27.23		
15	1	77		27.48	27.31	27.26		
15	36	18		27.48	27.27	27.33		
15	1	0		23.93	23.68	23.72		
15	1	78		24.02	23.80	23.78		
15	75	0		26.43	26.23	26.36		
15	1	1	16-QAM	26.13	26.05	26.06	28.13	0.6501
15	1	1	64-QAM	24.85	24.65	24.80		
15	1	1	256-QAM	22.75	22.51	22.52		
Limit	EIRP < 1W			Result			Pass	



NR n77 Maximum Average Power [dBm] (GT - LC = 2 dB)										
BW [MHz]	RB Size	RB Offset	Mod	Lowest	Middle	Highest	EIRP (dBm)	EIRP(W)		
20	1	1	PI/2 BPSK	27.45	27.22	27.28	29.53	0.8974		
20	1	104		27.44	27.30	27.36				
20	50	25		27.46	27.21	27.27				
20	1	0		24.02	23.86	23.80				
20	1	105		24.14	23.98	23.94				
20	100	0		26.91	26.75	26.73				
20	1	1	QPSK	27.48	27.34	27.36			28.32	0.6792
20	1	104		27.53	27.38	27.47				
20	50	25		27.45	27.23	27.27				
20	1	0		24.00	23.78	23.80				
20	1	105		24.05	23.93	23.91				
20	100	0		26.46	26.26	26.29				
20	1	1	16-QAM	26.32	26.02	26.18	28.32	0.6792		
20	1	1	64-QAM	25.02	24.81	24.83				
20	1	1	256-QAM	22.88	22.67	22.63				
Limit	EIRP < 1W			Result			Pass			

NR n77 Maximum Average Power [dBm] (GT - LC = 2 dB)										
BW [MHz]	RB Size	RB Offset	Mod	Lowest	Middle	Highest	EIRP (dBm)	EIRP(W)		
40	1	1	PI/2 BPSK	27.78	27.56	27.37	29.89	0.9750		
40	1	214		27.83	27.56	27.51				
40	108	54		27.71	27.43	27.50				
40	1	0		24.38	27.54	23.97				
40	1	215		24.45	24.14	24.20				
40	216	0		26.73	26.94	26.96				
40	1	1	QPSK	27.77	27.55	27.41			28.68	0.7379
40	1	214		27.89	27.69	27.61				
40	108	54		27.68	27.47	27.43				
40	1	0		24.28	24.13	23.86				
40	1	215		24.36	24.16	24.23				
40	216	0		26.73	26.43	26.47				
40	1	1	16-QAM	26.68	26.43	26.42	28.68	0.7379		
40	1	1	64-QAM	25.32	25.06	25.02				
40	1	1	256-QAM	23.18	22.98	22.77				
Limit	EIRP < 1W			Result			Pass			



NR n77 Maximum Average Power [dBm] (GT - LC = 2 dB)								
BW [MHz]	RB Size	RB Offset	Mod	Lowest	Middle	Highest	EIRP (dBm)	EIRP(W)
50	1	1	PI/2 BPSK	27.66	27.54	27.45	29.96	0.9908
50	1	268		27.96	27.56	27.47		
50	135	67		27.59	27.48	27.41		
50	1	0		24.20	24.14	24.02		
50	1	269		24.53	24.17	24.06		
50	270	0		27.15	27.00	26.95		
50	1	1	QPSK	27.70	27.46	27.37	28.50	0.7079
50	1	268		27.95	27.47	27.47		
50	135	67		27.63	27.48	27.48		
50	1	0		24.17	24.11	23.95		
50	1	269		24.54	24.08	24.03		
50	270	0		26.70	26.53	26.45		
50	1	1	16-QAM	26.50	26.41	26.21	28.50	0.7079
50	1	1	64-QAM	25.21	25.13	25.31		
50	1	1	256-QAM	23.04	22.91	22.79		
Limit	EIRP < 1W			Result			Pass	



Sub carrier spacing : 30kHz

NR n77 Maximum Average Power [dBm] (GT - LC = 2 dB)								
BW [MHz]	RB Size	RB Offset	Mod	Lowest	Middle	Highest	EIRP (dBm)	EIRP(W)
10	1	1	PI/2 BPSK	27.24	27.13	27.07	29.41	0.8730
10	1	22		27.30	27.14	27.13		
10	12	6		27.36	27.22	27.18		
10	1	0		23.79	23.64	23.65		
10	1	23		23.81	23.71	23.70		
10	24	0		26.85	23.73	26.67		
10	1	1	QPSK	27.21	27.13	27.04	29.41	0.8730
10	1	22		27.28	27.16	27.11		
10	12	6		27.41	27.24	27.15		
10	1	0		23.68	23.62	23.40		
10	1	23		23.82	23.68	23.54		
10	24	0		26.31	26.20	26.10		
10	1	1	16-QAM	26.24	26.17	26.12	28.24	0.6668
10	1	1	64-QAM	25.05	24.97	24.78		
10	1	1	256-QAM	22.77	22.84	22.70		
Limit	EIRP < 1W			Result			Pass	

NR n77 Maximum Average Power [dBm] (GT - LC = 2 dB)								
BW [MHz]	RB Size	RB Offset	Mod	Lowest	Middle	Highest	EIRP (dBm)	EIRP(W)
15	1	1	PI/2 BPSK	27.25	27.13	27.16	29.40	0.8710
15	1	36		27.31	27.20	27.11		
15	18	9		27.38	27.22	27.24		
15	1	0		23.81	23.72	23.66		
15	1	37		23.91	23.77	23.72		
15	36	0		26.86	26.74	26.72		
15	1	1	QPSK	27.24	27.17	27.08	29.40	0.8710
15	1	36		27.26	27.18	27.05		
15	18	9		27.40	27.26	27.25		
15	1	0		23.73	23.69	23.67		
15	1	37		23.80	23.70	23.68		
15	36	0		26.39	26.20	26.21		
15	1	1	16-QAM	26.27	26.01	26.22	28.27	0.6714
15	1	1	64-QAM	25.01	24.90	24.60		
15	1	1	256-QAM	22.87	22.81	22.78		
Limit	EIRP < 1W			Result			Pass	



NR n77 Maximum Average Power [dBm] (GT - LC = 2 dB)										
BW [MHz]	RB Size	RB Offset	Mod	Lowest	Middle	Highest	EIRP (dBm)	EIRP(W)		
20	1	1	PI/2 BPSK	27.31	27.17	27.16	29.45	0.8810		
20	1	49		27.35	27.26	27.19				
20	25	12		27.45	27.28	27.23				
20	1	0		23.86	23.76	23.74				
20	1	50		23.85	23.82	23.75				
20	50	0		26.89	26.78	26.77				
20	1	1	QPSK	27.28	27.20	27.10			29.45	0.8810
20	1	49		27.31	27.23	27.13				
20	25	12		27.44	27.27	27.26				
20	1	0		23.81	23.67	23.71				
20	1	50		23.82	23.76	23.77				
20	50	0		26.36	26.28	26.26				
20	1	1	16-QAM	26.27	26.24	26.16	28.27	0.6714		
20	1	1	64-QAM	24.90	24.96	24.85				
20	1	1	256-QAM	23.01	22.72	22.88				
Limit	EIRP < 1W			Result			Pass			

NR n77 Maximum Average Power [dBm] (GT - LC = 2 dB)										
BW [MHz]	RB Size	RB Offset	Mod	Lowest	Middle	Highest	EIRP (dBm)	EIRP(W)		
40	1	1	PI/2 BPSK	27.70	27.56	27.31	29.74	0.9419		
40	1	104		27.74	27.52	27.53				
40	50	25		27.69	27.46	27.40				
40	1	0		24.26	24.09	23.89				
40	1	105		24.32	24.10	24.11				
40	100	0		27.17	26.97	26.91				
40	1	1	QPSK	27.63	27.55	27.32			29.74	0.9419
40	1	104		27.71	27.52	27.47				
40	50	25		27.69	27.46	27.40				
40	1	0		24.16	23.98	23.91				
40	1	105		24.17	24.07	23.99				
40	100	0		26.67	26.50	26.41				
40	1	1	16-QAM	26.83	26.66	26.34	28.83	0.7638		
40	1	1	64-QAM	25.49	25.25	25.12				
40	1	1	256-QAM	23.40	23.13	23.07				
Limit	EIRP < 1W			Result			Pass			



NR n77 Maximum Average Power [dBm] (GT - LC = 2 dB)										
BW [MHz]	RB Size	RB Offset	Mod	Lowest	Middle	Highest	EIRP (dBm)	EIRP(W)		
50	1	1	PI/2 BPSK	27.52	27.53	27.40	29.88	0.9727		
50	1	131		27.87	27.50	27.45				
50	64	32		27.63	27.49	27.41				
50	1	0		24.12	24.12	23.99				
50	1	132		24.46	27.52	24.00				
50	128	0		27.14	27.01	26.91				
50	1	1	QPSK	27.53	27.52	27.44			29.88	0.9727
50	1	131		27.88	27.56	27.39				
50	64	32		27.61	27.53	27.42				
50	1	0		24.10	24.10	24.03				
50	1	132		24.48	24.12	24.01				
50	128	0		26.63	26.54	26.44				
50	1	1	16-QAM	26.45	26.53	26.33	28.53	0.7129		
50	1	1	64-QAM	25.06	24.98	24.77				
50	1	1	256-QAM	23.00	23.25	22.93				
Limit	EIRP < 1W			Result			Pass			

NR n77 Maximum Average Power [dBm] (GT - LC = 2 dB)										
BW [MHz]	RB Size	RB Offset	Mod	Lowest	Middle	Highest	EIRP (dBm)	EIRP(W)		
60	1	1	PI/2 BPSK	27.50	27.38	27.18	29.97	0.9931		
60	1	160		27.97	27.39	27.38				
60	81	40		27.63	27.51	27.38				
60	1	0		24.03	23.88	23.76				
60	1	161		24.29	23.92	23.99				
60	162	0		27.17	26.97	26.85				
60	1	1	QPSK	27.47	27.38	27.18			29.97	0.9931
60	1	160		27.74	27.42	27.44				
60	81	40		27.68	27.51	27.36				
60	1	0		24.05	23.95	23.72				
60	1	161		24.28	23.96	23.98				
60	162	0		26.68	26.50	26.36				
60	1	1	16-QAM	26.39	26.45	26.18	28.45	0.6998		
60	1	1	64-QAM	25.02	24.83	24.56				
60	1	1	256-QAM	23.00	23.04	22.70				
Limit	EIRP < 1W			Result			Pass			



NR n77 Maximum Average Power [dBm] (GT - LC = 2 dB)								
BW [MHz]	RB Size	RB Offset	Mod	Lowest	Middle	Highest	EIRP (dBm)	EIRP(W)
80	1	1	PI/2 BPSK	27.44	27.41	27.13	29.70	0.9333
80	1	215		27.56	27.28	27.36		
80	108	54		27.67	27.51	27.35		
80	1	0		24.01	23.91	23.75		
80	1	216		24.13	23.88	23.99		
80	216	0		27.12	26.91	26.84		
80	1	1	QPSK	27.43	27.37	27.14		
80	1	215		27.55	27.29	27.45		
80	108	54		27.70	27.50	27.36		
80	1	0		23.97	23.97	23.70		
80	1	216		24.14	23.92	24.03		
80	216	0		26.62	26.50	26.35		
80	1	1	16-QAM	26.40	26.37	26.05	28.40	0.6918
80	1	1	64-QAM	24.80	24.73	24.49		
80	1	1	256-QAM	23.01	22.98	22.74		
Limit	EIRP < 1W			Result			Pass	

NR n77 Maximum Average Power [dBm] (GT - LC = 2 dB)								
BW [MHz]	RB Size	RB Offset	Mod	Lowest	Middle	Highest	EIRP (dBm)	EIRP(W)
90	1	1	PI/2 BPSK	27.32	27.37	27.20	29.73	0.9397
90	1	243		27.64	27.32	27.28		
90	120	60		27.66	27.46	27.40		
90	1	0		23.94	23.90	23.72		
90	1	244		24.27	23.94	23.92		
90	243	0		27.06	26.96	26.85		
90	1	1	QPSK	27.37	27.38	27.16		
90	1	243		27.73	27.32	27.25		
90	120	60		27.65	27.52	27.38		
90	1	0		23.90	23.94	23.73		
90	1	244		24.30	23.95	23.88		
90	243	0		26.57	26.48	26.38		
90	1	1	16-QAM	26.32	26.44	26.10	28.44	0.6982
90	1	1	64-QAM	24.67	24.75	24.73		
90	1	1	256-QAM	22.66	22.98	22.64		
Limit	EIRP < 1W			Result			Pass	



NR n77 Maximum Average Power [dBm] (GT - LC = 2 dB)								
BW [MHz]	RB Size	RB Offset	Mod	Lowest	Middle	Highest	EIRP (dBm)	EIRP(W)
100	1	1	PI/2 BPSK	27.42	27.33	27.05	29.72	0.9376
100	1	271		27.55	27.29	27.48		
100	135	67		27.68	27.50	27.36		
100	1	0		23.99	23.91	23.61		
100	1	272		24.18	23.90	24.06		
100	270	0		27.08	26.95	26.83		
100	1	1	QPSK	27.40	27.35	27.07	28.39	0.6902
100	1	271		27.53	27.31	27.42		
100	135	67		27.72	27.50	27.35		
100	1	0		24.03	23.94	23.58		
100	1	272		24.21	23.93	24.12		
100	270	0		26.57	26.43	26.34		
100	1	1	16-QAM	26.28	26.39	25.83	28.39	0.6902
100	1	1	64-QAM	24.84	24.67	24.69		
100	1	1	256-QAM	22.93	23.02	22.55		
Limit	EIRP < 1W			Result			Pass	



<MIMO Mode>

Sub carrier spacing : 15kHz

Part270 NR n77 Maximum Average Power [dBm], DG = 2 dBi														
BW (MHz)	RB Size	RB Offset	Mod	Antenna 5			Antenna 6			Combine			EIRP (dBm)	EIRP (W)
				Lowest	Middle	Highes	Lowest	Middle	Highes	Lowest	Middle	Highes		
10	1	1	QPSK	22.98	22.87	22.82	22.33	21.63	22.54	25.68	25.30	25.69	27.82	0.6053
10	1	50		23.02	22.87	22.87	22.44	21.80	22.74	25.75	25.38	25.82		
10	26	13		23.05	22.77	22.81	22.34	21.68	22.73	25.72	25.27	25.78		
10	1	0		20.83	20.58	20.74	20.17	19.54	20.45	23.52	23.10	23.61		
10	1	51		21.03	20.89	20.90	20.46	19.75	20.88	23.76	23.37	23.90		
10	52	0		21.46	21.23	21.30	20.84	20.20	21.23	24.17	23.76	24.28		
10	1	1	16-QAM	22.43	22.36	22.33	21.69	21.06	21.96	25.09	24.77	25.16	27.16	0.5200
10	1	1	64-QAM	20.94	20.86	20.74	20.35	19.57	20.55	23.67	23.27	23.66		
10	1	1	256-QAM	18.17	18.03	18.00	17.39	16.87	17.63	20.81	20.50	20.83		
Limit	EIRP < 1W			Result									Pass	

Part270 NR n77 Maximum Average Power [dBm], DG = 2 dBi														
BW (MHz)	RB Size	RB Offset	Mod	Antenna 5			Antenna 6			Combine			EIRP (dBm)	EIRP (W)
				Lowest	Middle	Highes	Lowest	Middle	Highes	Lowest	Middle	Highes		
15	1	1	QPSK	23.04	22.83	22.87	22.33	21.62	22.61	25.71	25.28	25.75	27.88	0.6138
15	1	77		23.13	22.94	22.94	22.51	21.67	22.80	25.84	25.36	25.88		
15	39	19		23.00	22.78	22.81	22.50	21.73	22.81	25.77	25.30	25.82		
15	1	0		20.74	20.72	20.79	20.22	19.54	20.46	23.50	23.18	23.64		
15	1	78		20.90	20.84	20.76	20.39	19.70	20.65	23.66	23.32	23.72		
15	79	0		21.40	21.34	21.30	20.88	20.26	21.25	24.16	23.84	24.29		
15	1	1	16-QAM	22.51	22.29	22.21	21.69	21.04	21.96	25.13	24.72	25.10	27.13	0.5164
15	1	1	64-QAM	20.85	20.81	20.77	20.27	19.65	20.67	23.58	23.28	23.73		
15	1	1	256-QAM	18.25	17.97	18.07	17.45	16.71	17.71	20.88	20.40	20.90		
Limit	EIRP < 1W			Result									Pass	

Part270 NR n77 Maximum Average Power [dBm], DG = 2 dBi														
BW (MHz)	RB Size	RB Offset	Mod	Antenna 5			Antenna 6			Combine			EIRP (dBm)	EIRP (W)
				Lowest	Middle	Highes	Lowest	Middle	Highes	Lowest	Middle	Highes		
20	1	1	QPSK	23.14	23.00	22.95	22.51	21.81	22.57	25.85	25.46	25.77	27.91	0.6180
20	1	104		23.10	23.03	23.00	22.62	21.84	22.80	25.88	25.49	25.91		
20	53	26		23.01	22.86	22.84	22.53	21.70	22.67	25.79	25.33	25.77		
20	1	0		21.08	20.87	20.90	20.45	19.75	20.58	23.79	23.36	23.75		
20	1	105		21.03	21.01	21.01	20.58	19.80	20.88	23.82	23.46	23.96		
20	106	0		21.48	21.35	21.35	20.99	20.18	21.15	24.25	23.81	24.26		
20	1	1	16-QAM	22.57	22.37	22.34	21.86	21.24	21.99	25.24	24.85	25.18	27.24	0.5297
20	1	1	64-QAM	21.05	20.93	20.90	20.43	19.75	20.64	23.76	23.39	23.78		
20	1	1	256-QAM	18.37	18.15	18.12	17.60	16.87	17.72	21.01	20.57	20.93		
Limit	EIRP < 1W			Result									Pass	

Part270 NR n77 Maximum Average Power [dBm], DG = 2 dBi														
BW (MHz)	RB Size	RB Offset	Mod	Antenna 5			Antenna 6			Combine			EIRP (dBm)	EIRP (W)
				Lowest	Middle	Highes	Lowest	Middle	Highes	Lowest	Middle	Highes		
40	1	1	QPSK	23.33	23.26	23.02	22.37	21.74	22.66	25.89	25.58	25.85	27.92	0.6194
40	1	214		23.22	23.27	23.06	22.49	21.92	22.76	25.88	25.66	25.92		
40	108	54		23.26	23.07	23.03	22.50	21.78	22.64	25.91	25.48	25.85		
40	1	0		21.38	21.21	20.93	20.44	19.64	20.53	23.95	23.51	23.74		
40	1	215		21.49	21.25	21.26	20.43	20.04	20.98	24.00	23.70	24.13		
40	216	0		21.70	21.55	21.45	20.95	20.25	21.12	24.35	23.96	24.30		
40	1	1	16-QAM	22.93	22.66	22.61	21.81	21.14	22.05	25.42	24.98	25.35	27.42	0.5521
40	1	1	64-QAM	21.51	21.14	21.02	20.52	19.73	20.66	24.05	23.50	23.85		
40	1	1	256-QAM	18.66	18.35	18.24	17.61	16.87	17.74	21.18	20.68	21.01		
Limit	EIRP < 1W			Result									Pass	



Part270 NR n77 Maximum Average Power [dBm], DG = 2 dBi														
BW (MHz)	RB Size	RB Offset	Mod	Antenna 5			Antenna 6			Combine			EIRP (dBm)	EIRP (W)
				Lowest	Middle	Highes	Lowest	Middle	Highes	Lowest	Middle	Highes		
50	1	1	QPSK	23.33	23.04	23.16	22.34	21.53	22.47	25.87	25.36	25.84	27.91	0.6180
50	1	268		23.10	23.05	23.15	22.70	21.74	22.60	25.91	25.45	25.89		
50	135	67		23.18	22.86	20.97	22.39	21.62	22.63	25.81	25.29	24.89		
50	1	0		21.30	20.95	21.04	20.30	19.50	20.58	23.84	23.30	23.83		
50	1	269		21.36	20.94	21.10	20.15	19.80	20.89	23.81	23.42	24.01		
50	270	0		21.53	21.40	21.53	20.67	20.05	21.18	24.13	23.79	24.37		
50	1	1	16-QAM	22.74	22.71	22.55	21.73	21.09	22.06	25.27	24.99	25.32	27.32	0.5395
50	1	1	64-QAM	21.33	21.22	21.05	20.40	19.73	20.63	23.90	23.55	23.86		
50	1	1	256-QAM	18.52	18.58	18.32	19.51	16.75	17.77	22.05	20.77	21.06		
Limit	EIRP < 1W			Result									Pass	



Sub carrier spacing : 30kHz

Part270 NR n77 Maximum Average Power [dBm], DG = 2 dBi														
BW (MHz)	RB Size	RB Offset	Mod	Antenna 5			Antenna 6			Combine			EIRP (dBm)	EIRP (W)
				Lowest	Middle	Highes	Lowest	Middle	Highes	Lowest	Middle	Highes		
10	1	1	QPSK	22.72	22.78	22.66	22.28	21.49	22.49	25.52	25.19	25.59	27.68	0.5861
10	1	22		22.83	22.78	22.63	22.35	21.53	22.70	25.61	25.21	25.68		
10	12	6		22.88	22.70	22.72	22.32	21.63	22.62	25.62	25.21	25.68		
10	1	0		20.72	20.62	20.53	20.21	19.45	20.48	23.48	23.08	23.52		
10	1	23		20.84	20.64	20.63	20.28	19.60	20.60	23.58	23.16	23.63		
10	24	0		21.31	21.14	21.13	20.79	20.13	21.03	24.07	23.67	24.09		
10	1	1	16-QAM	22.54	22.11	22.14	21.66	20.87	21.90	25.13	24.54	25.03	27.13	0.5164
10	1	1	64-QAM	20.97	20.62	20.84	20.32	19.42	20.49	23.67	23.07	23.68		
10	1	1	256-QAM	17.77	17.69	17.63	17.30	16.47	17.44	20.55	20.13	20.55		
Limit	EIRP < 1W			Result									Pass	

Part270 NR n77 Maximum Average Power [dBm], DG = 2 dBi														
BW (MHz)	RB Size	RB Offset	Mod	Antenna 5			Antenna 6			Combine			EIRP (dBm)	EIRP (W)
				Lowest	Middle	Highes	Lowest	Middle	Highes	Lowest	Middle	Highes		
15	1	1	QPSK	22.86	22.67	22.69	22.29	21.60	22.54	25.59	25.18	25.63	27.77	0.5984
15	1	36		22.85	22.71	22.72	22.50	21.67	22.80	25.69	25.23	25.77		
15	19	9		22.87	22.68	22.75	22.45	21.63	22.65	25.68	25.20	25.71		
15	1	0		20.84	20.63	20.65	20.24	19.46	20.48	23.56	23.09	23.58		
15	1	37		20.86	20.58	20.61	20.37	19.62	20.68	23.63	23.14	23.66		
15	38	0		21.38	21.19	21.18	20.85	20.12	21.17	24.13	23.70	24.19		
15	1	1	16-QAM	22.33	22.26	22.39	21.77	20.92	21.85	25.07	24.65	25.14	27.14	0.5176
15	1	1	64-QAM	20.95	20.78	20.89	20.42	19.54	20.57	23.70	23.21	23.74		
15	1	1	256-QAM	17.81	17.68	17.75	17.31	16.64	17.56	20.58	20.20	20.67		
Limit	EIRP < 1W			Result									Pass	

Part270 NR n77 Maximum Average Power [dBm], DG = 2 dBi														
BW (MHz)	RB Size	RB Offset	Mod	Antenna 5			Antenna 6			Combine			EIRP (dBm)	EIRP (W)
				Lowest	Middle	Highes	Lowest	Middle	Highes	Lowest	Middle	Highes		
20	1	1	QPSK	22.95	22.69	22.74	22.41	21.68	22.42	25.70	25.22	25.59	27.75	0.5957
20	1	49		22.91	22.73	22.86	22.40	21.71	22.61	25.67	25.26	25.75		
20	25	12		22.94	20.70	22.77	22.43	21.56	22.61	25.70	24.16	25.70		
20	1	0		20.87	20.66	20.73	20.32	19.57	20.24	23.61	23.16	23.50		
20	1	50		20.94	20.85	20.83	20.35	19.60	20.43	23.67	23.28	23.64		
20	51	0		21.42	21.25	21.24	20.88	20.06	21.01	24.17	23.71	24.14		
20	1	1	16-QAM	22.63	22.22	22.36	21.72	21.25	21.77	25.21	24.77	25.09	27.21	0.5260
20	1	1	64-QAM	21.23	20.88	20.87	20.48	19.58	20.49	23.88	23.29	23.69		
20	1	1	256-QAM	17.89	17.76	17.75	17.40	16.65	17.45	20.66	20.25	20.61		
Limit	EIRP < 1W			Result									Pass	

Part270 NR n77 Maximum Average Power [dBm], DG = 2 dBi														
BW (MHz)	RB Size	RB Offset	Mod	Antenna 5			Antenna 6			Combine			EIRP (dBm)	EIRP (W)
				Lowest	Middle	Highes	Lowest	Middle	Highes	Lowest	Middle	Highes		
40	1	1	QPSK	23.31	23.04	22.89	22.36	21.62	22.48	25.87	25.40	25.70	27.92	0.6194
40	1	104		23.38	23.08	23.01	22.34	21.80	22.80	25.90	25.50	25.92		
40	53	26		23.15	22.92	22.88	22.40	21.62	22.48	25.80	25.33	25.69		
40	1	0		21.44	21.00	20.87	20.14	19.66	20.46	23.85	23.39	23.68		
40	1	105		21.50	21.05	21.06	20.13	19.81	20.84	23.88	23.48	23.96		
40	106	0		21.66	21.38	21.37	20.80	20.10	21.04	24.26	23.80	24.22		
40	1	1	16-QAM	23.04	22.65	22.55	21.77	21.03	21.84	25.46	24.93	25.22	27.46	0.5572
40	1	1	64-QAM	21.53	21.23	21.13	20.57	19.70	20.56	24.09	23.54	23.86		
40	1	1	256-QAM	18.17	18.01	17.85	17.38	16.63	17.45	20.80	20.38	20.66		
Limit	EIRP < 1W			Result									Pass	



Part270 NR n77 Maximum Average Power [dBm], DG = 2 dBi														
BW (MHz)	RB Size	RB Offset	Mod	Antenna 5			Antenna 6			Combine			EIRP (dBm)	EIRP (W)
				Lowest	Middle	Highes	Lowest	Middle	Highes	Lowest	Middle	Highes		
50	1	1	QPSK	23.28	23.05	22.92	22.17	21.58	22.60	25.77	25.39	25.77	27.90	0.6166
50	1	131		23.53	23.01	22.93	22.13	21.85	22.85	25.90	25.48	25.90		
50	67	33		23.10	22.94	22.87	22.25	21.61	22.55	25.71	25.34	25.72		
50	1	0		21.04	21.02	20.87	20.21	19.55	20.53	23.66	23.36	23.71		
50	1	132		21.43	21.03	20.91	20.25	19.86	20.77	23.89	23.49	23.85		
50	133	0		21.57	21.41	21.35	20.70	20.11	21.04	24.17	23.82	24.21		
50	1	1	16-QAM	22.83	22.71	22.59	21.52	20.91	21.88	25.23	24.91	25.26	27.26	0.5321
50	1	1	64-QAM	21.22	21.30	21.14	20.17	19.61	20.62	23.74	23.55	23.90		
50	1	1	256-QAM	18.23	18.00	17.90	17.26	16.55	17.56	20.78	20.35	20.74		
Limit	EIRP < 1W			Result									Pass	

Part270 NR n77 Maximum Average Power [dBm], DG = 2 dBi														
BW (MHz)	RB Size	RB Offset	Mod	Antenna 1			Antenna 2			Combine			EIRP (dBm)	EIRP (W)
				Lowest	Middle	Highes	Lowest	Middle	Highes	Lowest	Middle	Highes		
60	1	1	QPSK	23.06	22.93	22.74	22.26	21.42	22.12	25.69	25.25	25.45	27.93	0.6209
60	1	160		23.27	22.88	23.01	22.11	21.72	22.82	25.74	25.35	25.93		
60	81	40		23.09	22.89	22.82	22.25	21.58	22.44	25.70	25.29	25.64		
60	1	0		21.06	20.94	20.71	20.12	19.28	20.15	23.63	23.20	23.45		
60	1	161		21.34	20.94	20.94	19.82	19.58	20.67	23.66	23.32	23.82		
60	162	0		21.54	21.38	21.27	20.70	20.02	20.86	24.15	23.76	24.08		
60	1	1	16-QAM	22.75	22.48	22.40	21.66	20.76	21.45	25.25	24.71	24.96	27.25	0.5309
60	1	1	64-QAM	21.25	21.12	20.98	20.35	19.47	20.19	23.83	23.38	23.61		
60	1	1	256-QAM	17.98	17.88	17.68	17.25	16.42	17.10	20.64	20.22	20.41		
Limit	EIRP < 1W			Result									Pass	

Part270 NR n77 Maximum Average Power [dBm], DG = 2 dBi														
BW (MHz)	RB Size	RB Offset	Mod	Antenna 5			Antenna 6			Combine			EIRP (dBm)	EIRP (W)
				Lowest	Middle	Highes	Lowest	Middle	Highes	Lowest	Middle	Highes		
80	1	1	QPSK	22.97	22.86	22.62	22.20	21.34	21.73	25.61	25.18	25.21	27.77	0.5984
80	1	215		22.93	22.73	22.84	21.87	21.69	22.68	25.44	25.25	25.77		
80	109	54		23.03	22.86	22.74	22.14	21.63	22.35	25.62	25.30	25.56		
80	1	0		20.90	20.81	20.52	20.15	19.32	19.63	23.55	23.14	23.11		
80	1	216		20.85	20.69	20.84	19.77	19.69	20.63	23.35	23.23	23.75		
80	217	0		21.50	21.34	21.24	20.57	19.99	20.74	24.07	23.73	24.01		
80	1	1	16-QAM	22.59	22.50	22.24	21.39	20.73	21.09	25.04	24.71	24.71	27.04	0.5058
80	1	1	64-QAM	20.96	20.99	20.79	20.02	19.33	19.74	23.53	23.25	23.31		
80	1	1	256-QAM	18.07	17.82	17.63	17.16	16.46	16.76	20.65	20.20	20.23		
Limit	EIRP < 1W			Result									Pass	

Part270 NR n77 Maximum Average Power [dBm], DG = 2 dBi														
BW (MHz)	RB Size	RB Offset	Mod	Antenna 5			Antenna 6			Combine			EIRP (dBm)	EIRP (W)
				Lowest	Middle	Highes	Lowest	Middle	Highes	Lowest	Middle	Highes		
90	1	1	QPSK	22.95	22.91	22.66	22.09	21.36	21.77	25.55	25.21	25.25	27.71	0.5902
90	1	243		23.17	22.78	22.73	21.89	21.81	22.66	25.59	25.33	25.71		
90	123	61		21.48	22.86	22.79	20.45	21.56	22.32	24.01	25.27	25.57		
90	1	0		20.86	20.73	20.63	20.06	19.41	19.65	23.49	23.13	23.18		
90	1	244		21.14	20.71	20.76	19.80	19.77	20.54	23.53	23.28	23.66		
90	245	0		21.44	21.27	21.23	20.53	19.98	20.75	24.02	23.68	24.01		
90	1	1	16-QAM	22.59	22.33	22.21	21.37	20.67	21.13	25.03	24.59	24.71	27.03	0.5047
90	1	1	64-QAM	21.03	20.82	20.82	20.06	19.40	19.68	23.58	23.18	23.30		
90	1	1	256-QAM	17.83	18.07	17.68	17.07	16.52	16.81	20.48	20.37	20.28		
Limit	EIRP < 1W			Result									Pass	



Part270 NR n77 Maximum Average Power [dBm], DG = 2 dBi														
BW (MHz)	RB Size	RB Offset	Mod	Antenna 5			Antenna 6			Combine			EIRP (dBm)	EIRP (W)
				Lowest	Middle	Highes	Lowest	Middle	Highes	Lowest	Middle	Highes		
100	1	1	QPSK	22.82	22.71	22.44	22.08	21.52	21.50	25.48	25.17	25.01	27.72	0.5916
100	1	271		22.75	22.54	22.78	21.55	21.73	22.63	25.20	25.16	25.72		
100	137	68		21.40	22.73	22.67	20.49	21.53	22.21	23.98	25.18	25.46		
100	1	0		20.74	20.63	20.34	20.01	19.40	19.48	23.40	23.07	22.94		
100	1	272		20.77	20.65	20.74	19.48	19.75	20.59	23.18	23.23	23.68		
100	273	0		21.27	21.16	21.07	20.39	19.94	20.55	23.86	23.60	23.83		
100	1	1	16-QAM	22.50	22.30	22.08	21.57	20.73	20.91	25.07	24.60	24.54	27.07	0.5093
100	1	1	64-QAM	20.80	20.64	20.64	20.13	19.37	19.51	23.49	23.06	23.12		
100	1	1	256-QAM	17.66	17.91	17.44	17.22	16.58	16.58	20.46	20.31	20.04		
Limit	EIRP < 1W			Result									Pass	



FR1 n77_SISO Mode ANT5

Peak-to-Average Ratio

Mode	FR1 n77 / 20MHz / DFT-S OFDM				
Mod.	PI/2 BPSK	QPSK	16QAM	64QAM	Limit: 13dB
RB Size	Full RB	Full RB	Full RB	Full RB	Result
Middle CH	4.36	4.98	5.90	6.68	PASS
Mode	FR1 n77 / 20MHz / DFT-S OFDM				
Mod.	256QAM				Limit: 13dB
RB Size	Full RB				Result
Middle CH	6.80				PASS



FR1 n77 / 20MHz / DFT-S OFDM / Middle Channel / Full RB

PI/2 BPSK

QPSK

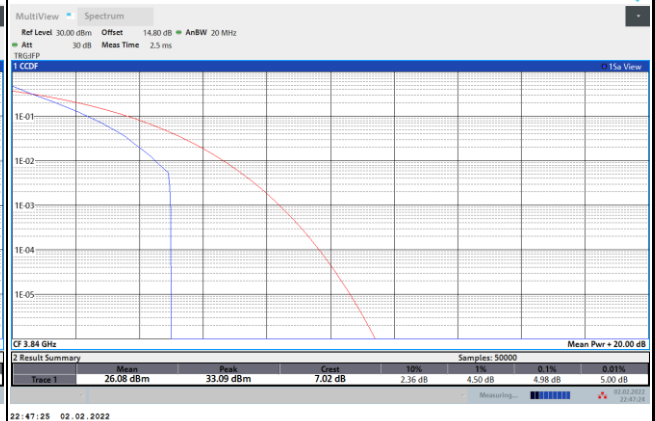
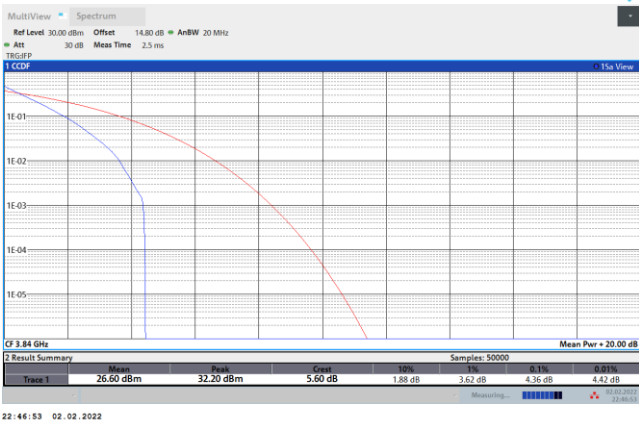

16QAM

64QAM

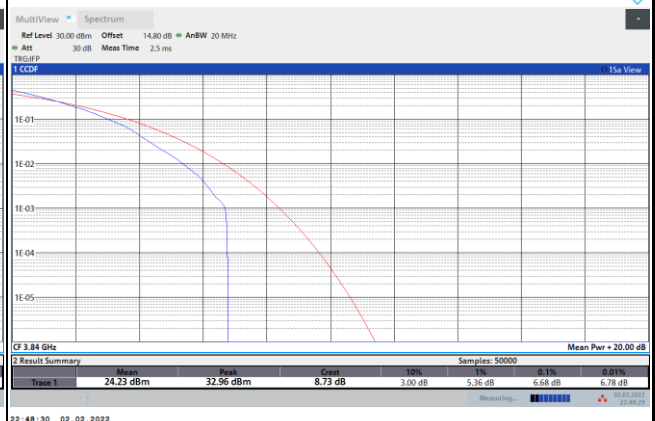
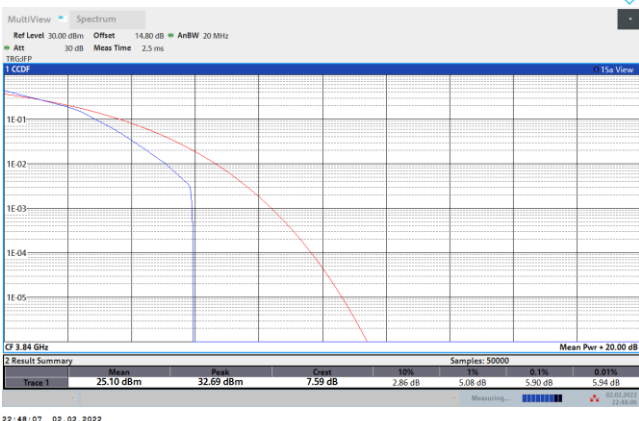

256QAM

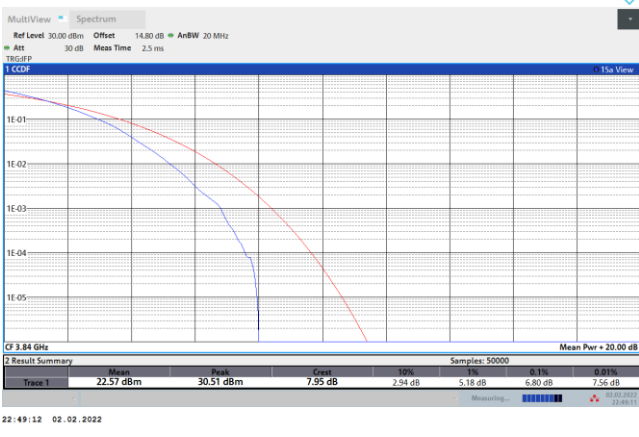



26dB Bandwidth

Mode	FR1 n77 : 26dB BW(MHz) / DFT-S OFDM							
BW	10MHz	15MHz	20MHz	25MHz	30MHz	40MHz	50MHz	60MHz
Mod.	PI/2 BPSK	PI/2 BPSK	PI/2 BPSK	PI/2 BPSK	PI/2 BPSK	PI/2 BPSK	PI/2 BPSK	PI/2 BPSK
Middle CH	9.35	14.21	18.78	-	-	39.80	50.65	60.66
BW	70MHz	80MHz	90MHz	100MHz				
Mod.	PI/2 BPSK	PI/2 BPSK	PI/2 BPSK	PI/2 BPSK				
Middle CH	-	79.92	90.09	99.30				

Mode	FR1 n77 : 26dB BW(MHz) / CP OFDM							
BW	10MHz		15MHz		20MHz		25MHz	
Mod.	QPSK	16QAM	QPSK	16QAM	QPSK	16QAM	QPSK	16QAM
Middle CH	9.71	9.71	14.96	14.89	19.78	19.86	-	-
Mod.	64QAM	256QAM	64QAM	256QAM	64QAM	256QAM	64QAM	256QAM
Middle CH	9.75	9.79	14.87	14.93	19.74	19.74	-	-
BW	30MHz		40MHz		50MHz		60MHz	
Mod.	QPSK	16QAM	QPSK	16QAM	QPSK	16QAM	QPSK	16QAM
Middle CH	-	-	39.64	39.72	50.65	50.85	60.54	60.66
Mod.	64QAM	256QAM	64QAM	256QAM	64QAM	256QAM	64QAM	256QAM
Middle CH	-	-	39.72	39.72	50.85	50.85	60.54	60.42
BW	70MHz		80MHz		90MHz		100MHz	
Mod.	QPSK	16QAM	QPSK	16QAM	QPSK	16QAM	QPSK	16QAM
Middle CH	-	-	80.40	80.24	90.27	90.27	100.50	100.70
Mod.	64QAM	256QAM	64QAM	256QAM	64QAM	256QAM	64QAM	256QAM
Middle CH	-	-	80.40	80.40	90.27	90.45	100.70	100.70



FR1 n77 / 10MHz / DFT-S OFDM / Middle Channel / Full RB

PI/2 BPSK

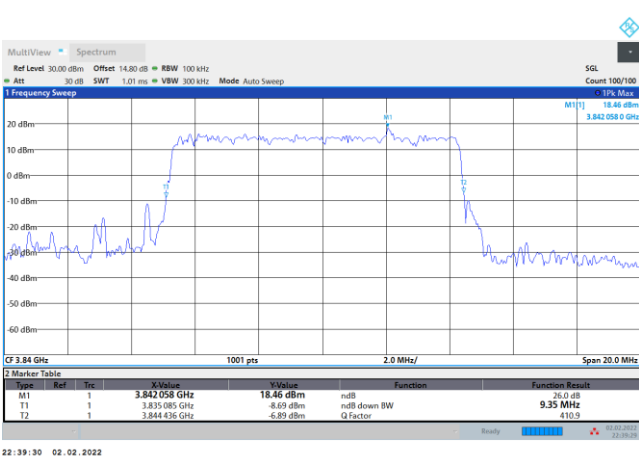

FR1 n77 / 10MHz / CP OFDM / Middle Channel / Full RB

QPSK

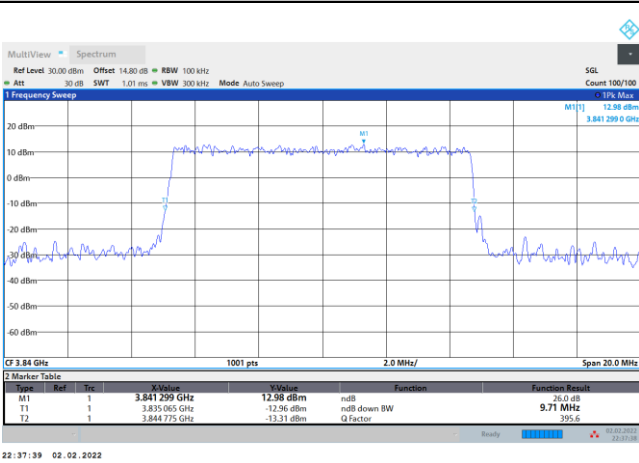

16QAM

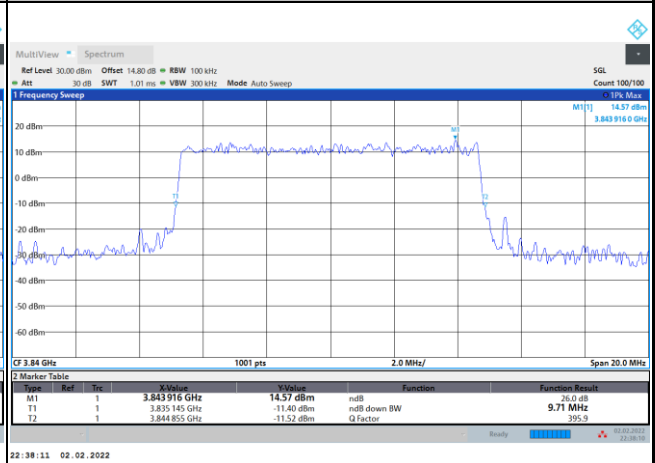

64QAM

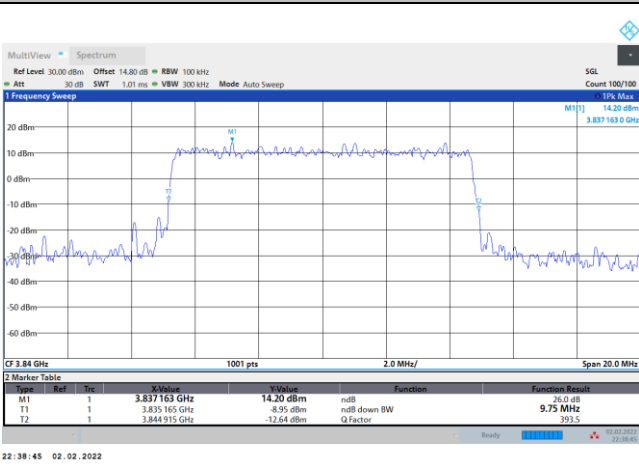

256QAM

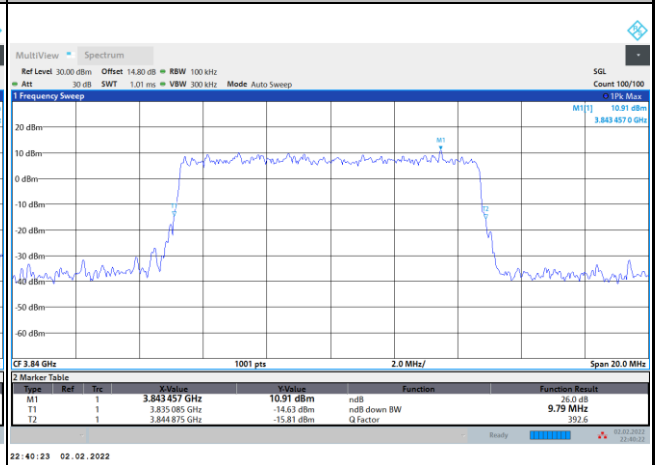



FR1 n77 / 15MHz / DFT-S OFDM / Middle Channel / Full RB

PI/2 BPSK

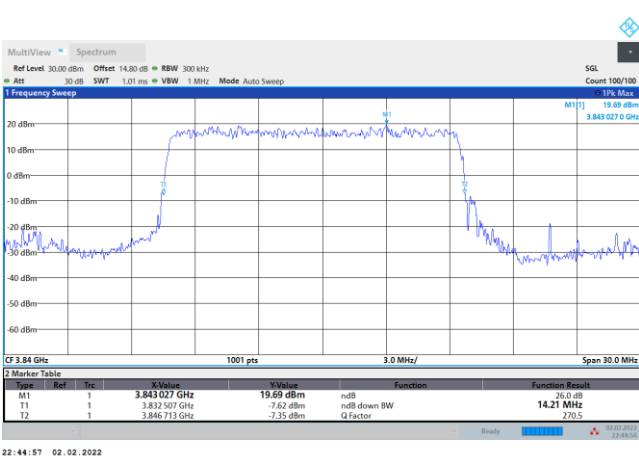

FR1 n77 / 15MHz / CP OFDM / Middle Channel / Full RB

QPSK

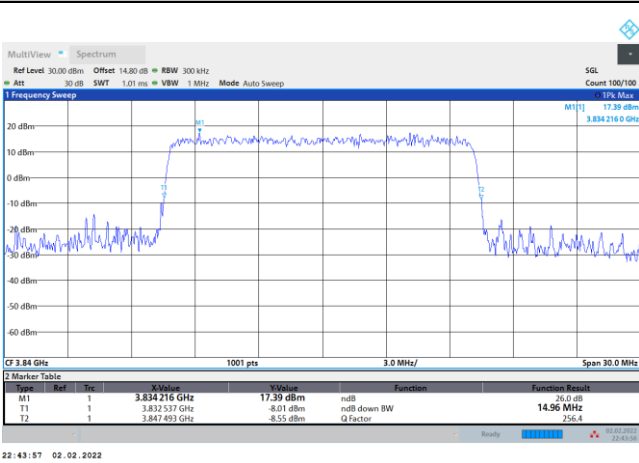

16QAM

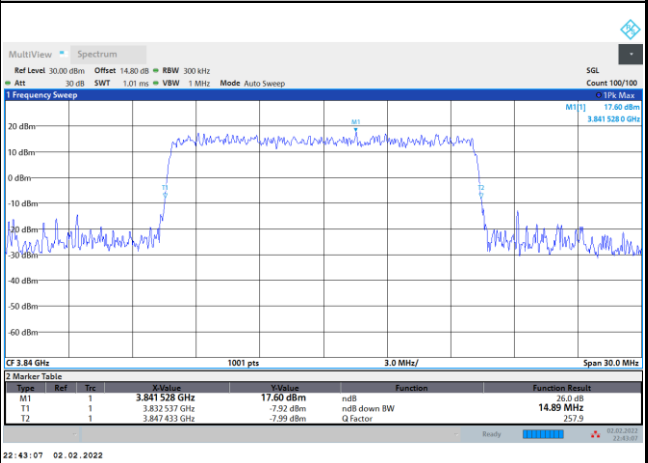

64QAM

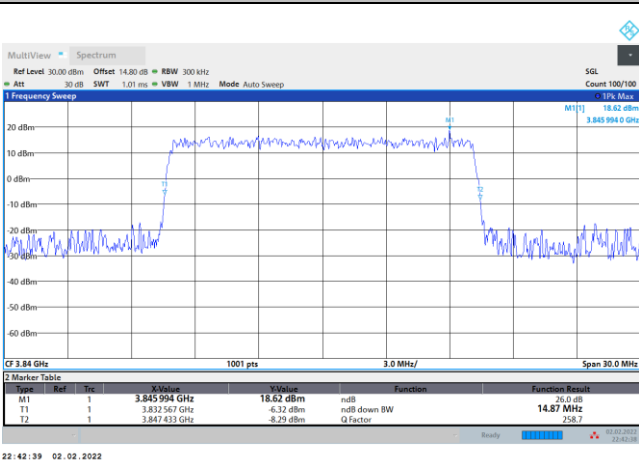

256QAM

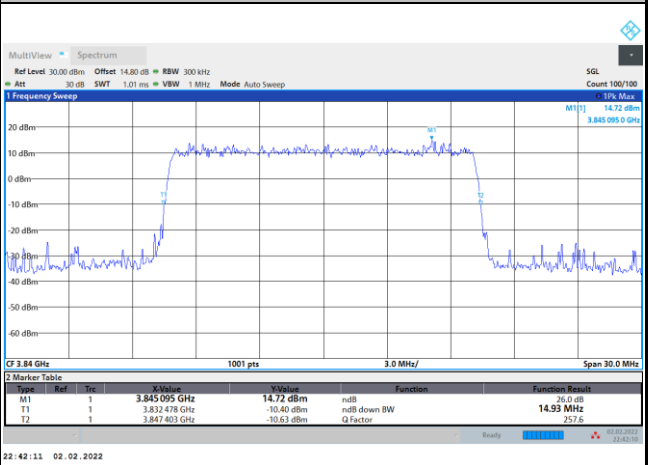



FR1 n77 / 20MHz / DFT-S OFDM / Middle Channel / Full RB

PI/2 BPSK

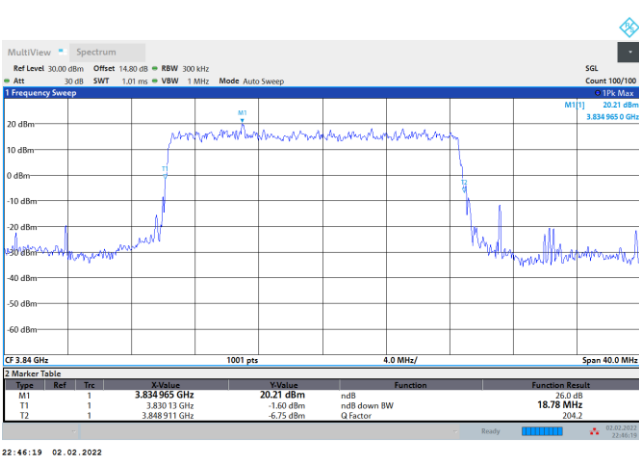

FR1 n77 / 20MHz / CP OFDM / Middle Channel / Full RB

QPSK

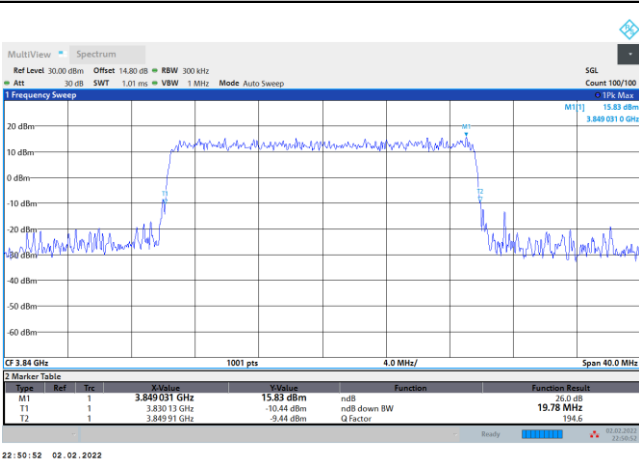

16QAM

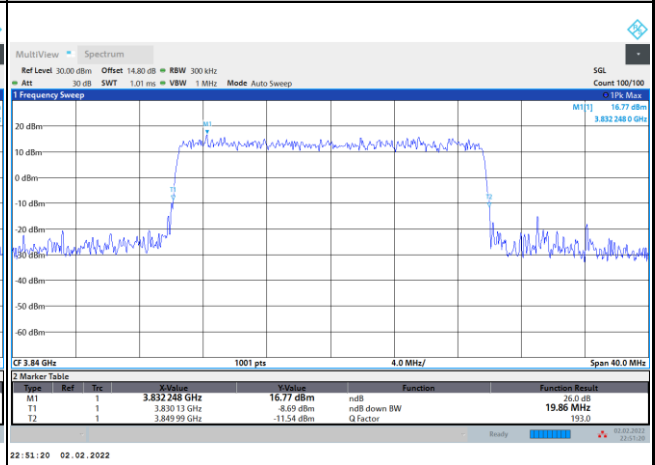

64QAM

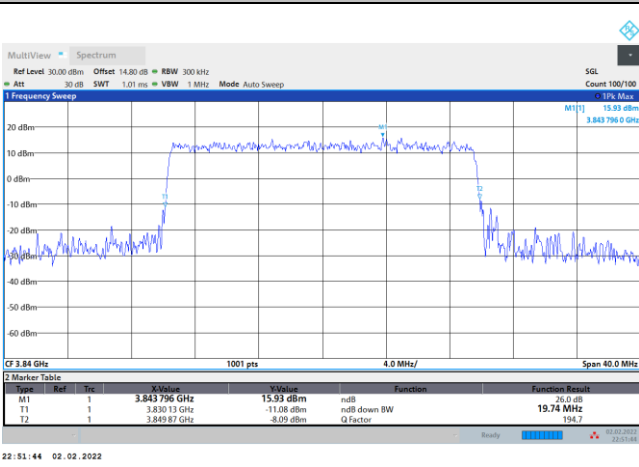

256QAM

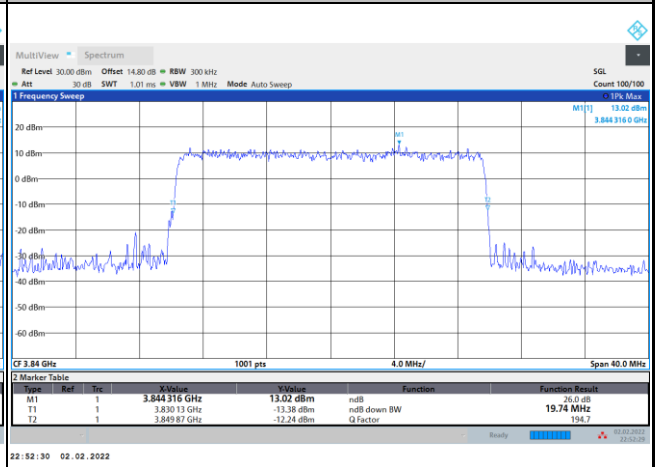



FR1 n77 / 40MHz / DFT-S OFDM / Middle Channel / Full RB

PI/2 BPSK

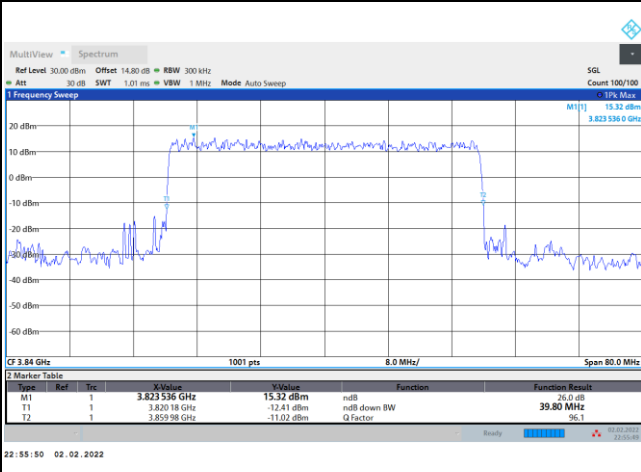

FR1 n77 / 40MHz / CP OFDM / Middle Channel / Full RB

QPSK

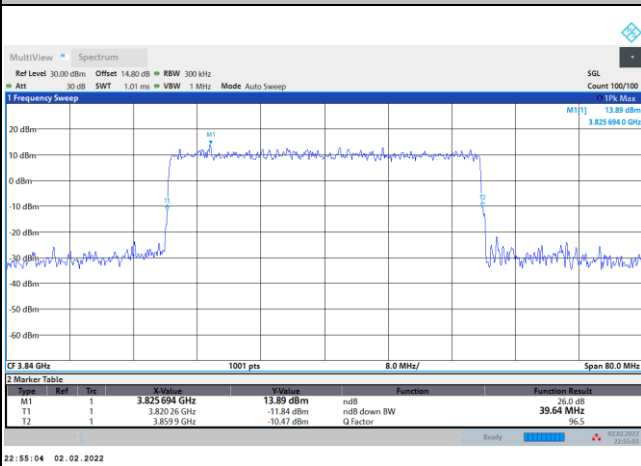

16QAM

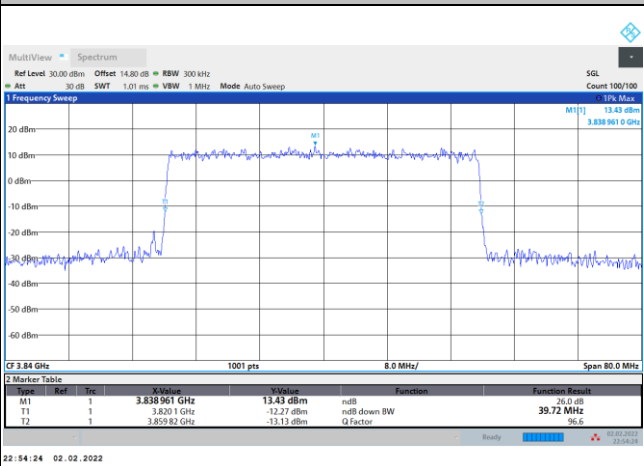

64QAM

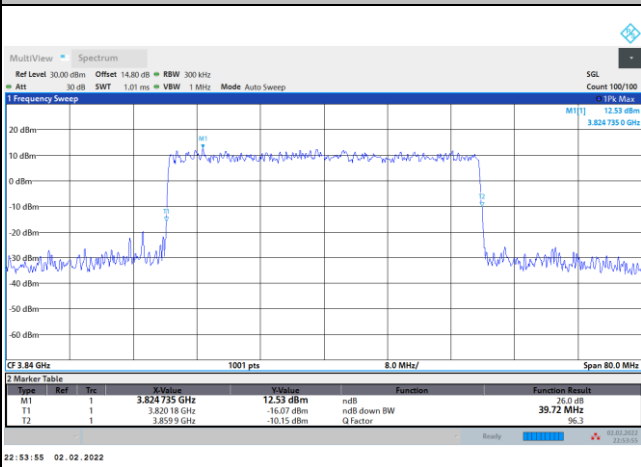

256QAM

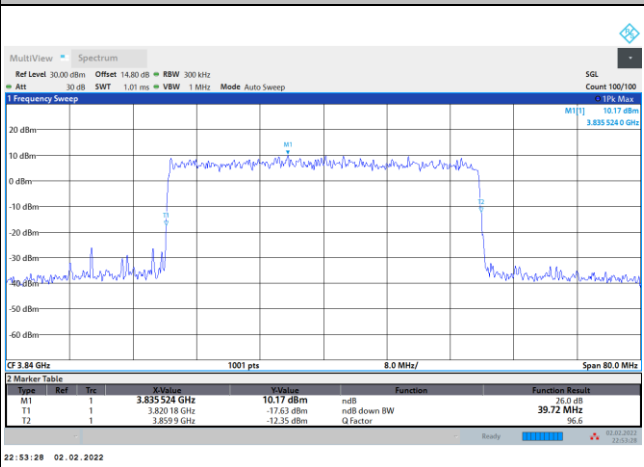



FR1 n77 / 50MHz / DFT-S OFDM / Middle Channel / Full RB

PI/2 BPSK

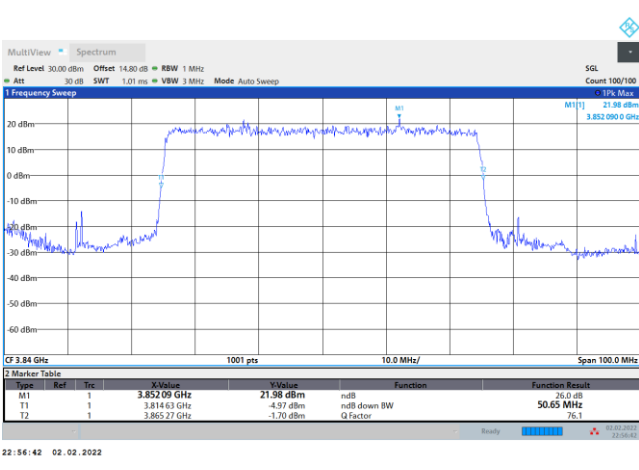

FR1 n77 / 50MHz / CP OFDM / Middle Channel / Full RB

QPSK

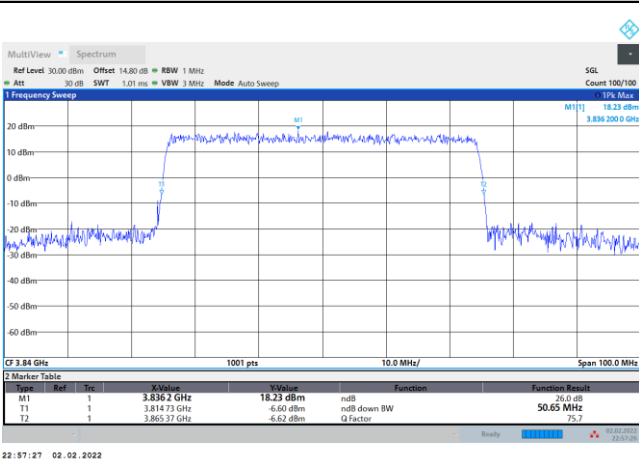

16QAM

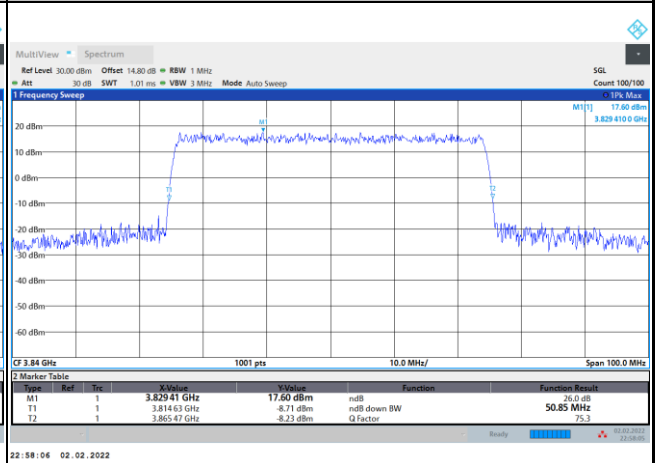

64QAM

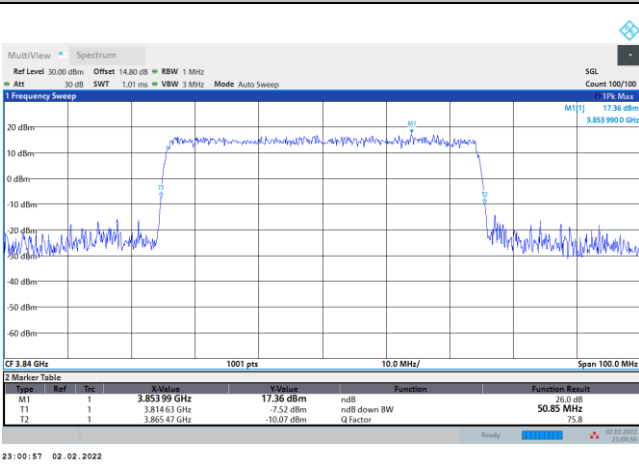

256QAM

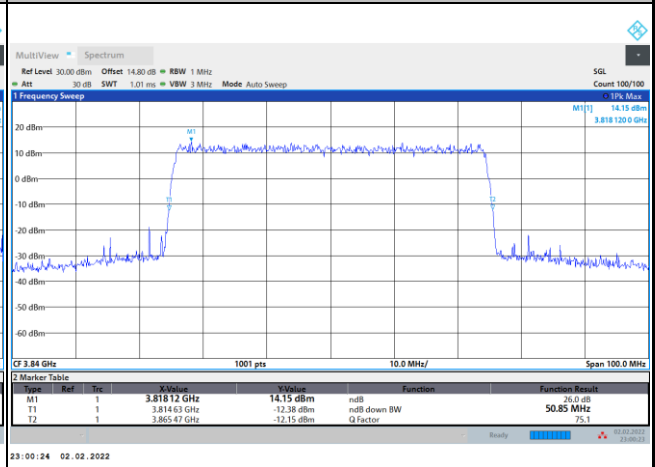



FR1 n77 / 60MHz / DFT-S OFDM / Middle Channel / Full RB

PI/2 BPSK

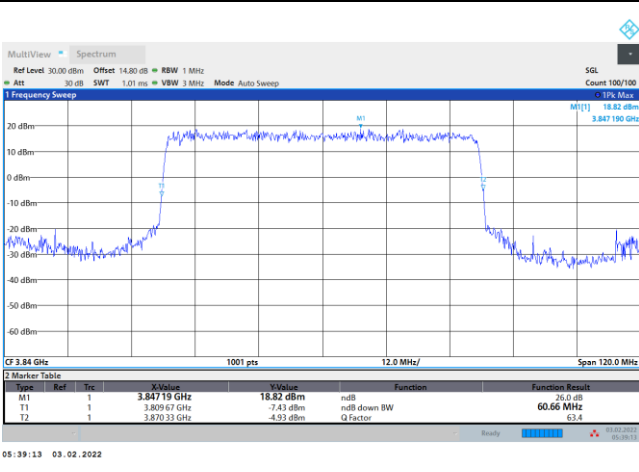

FR1 n77 / 60MHz / CP OFDM / Middle Channel / Full RB

QPSK

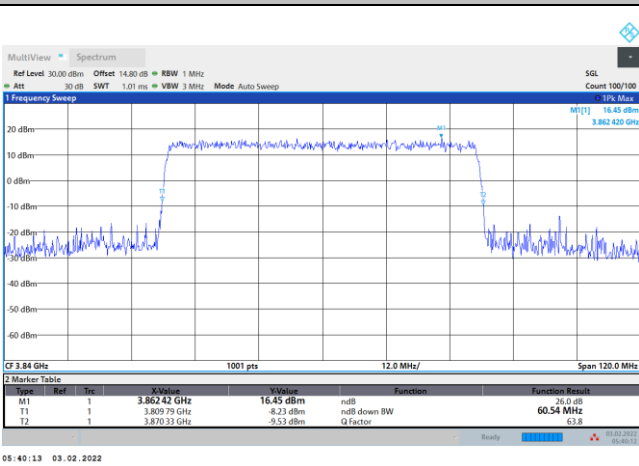

16QAM

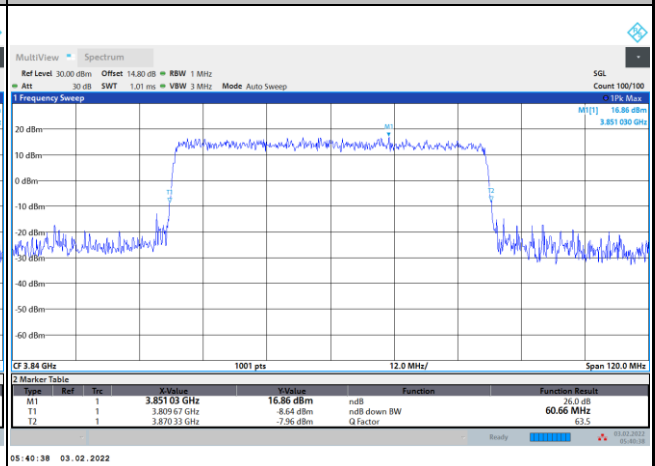

64QAM

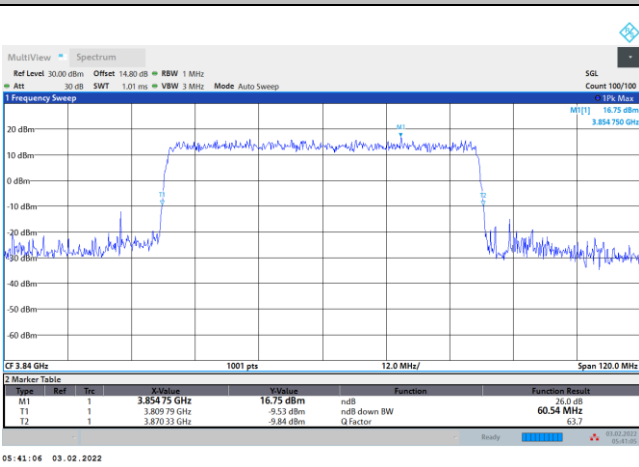

256QAM

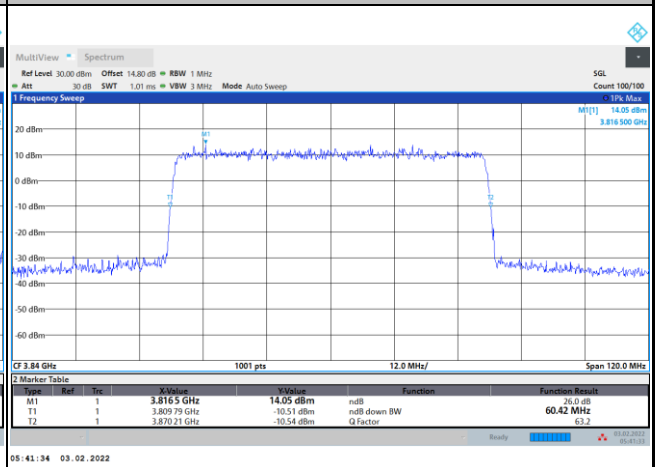



FR1 n77 / 80MHz / DFT-S OFDM / Middle Channel / Full RB

PI/2 BPSK

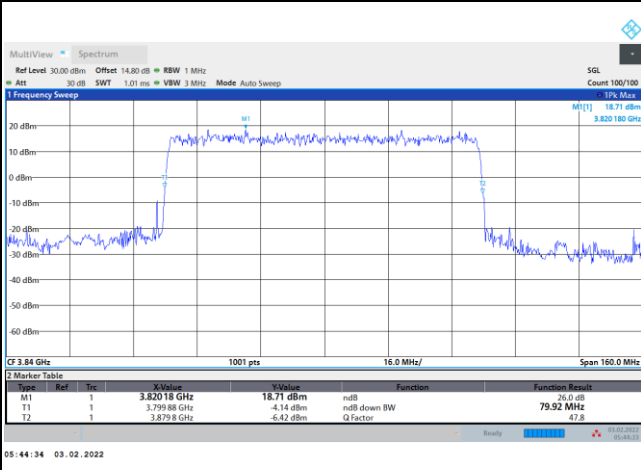

FR1 n77 / 80MHz / CP OFDM / Middle Channel / Full RB

QPSK

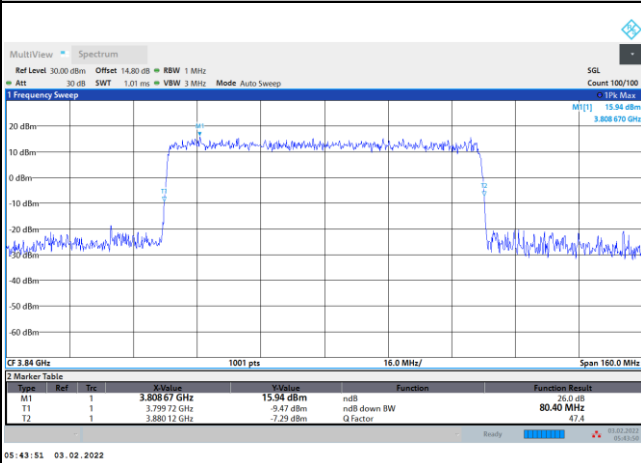

16QAM

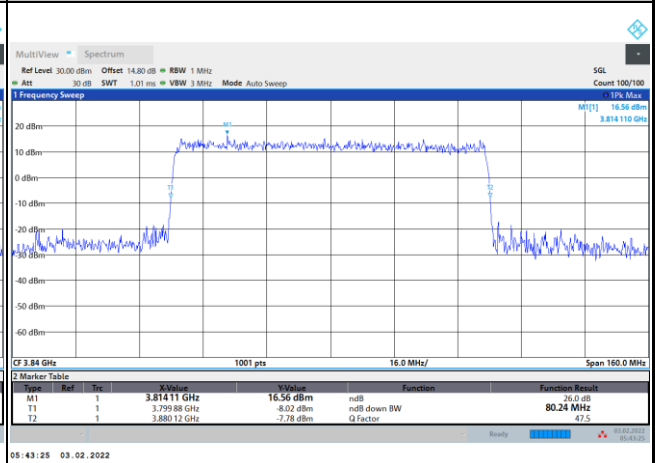

64QAM

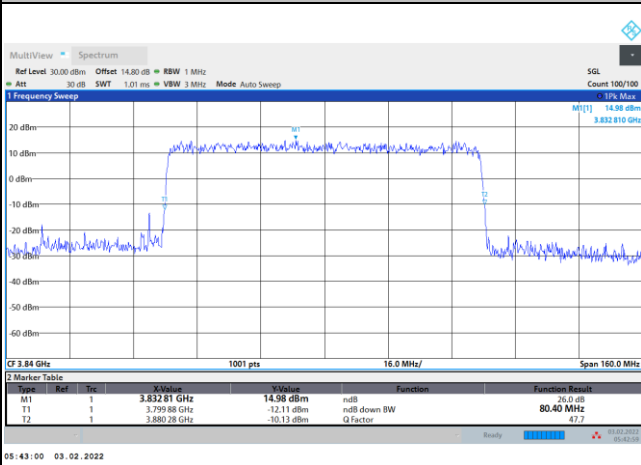

256QAM

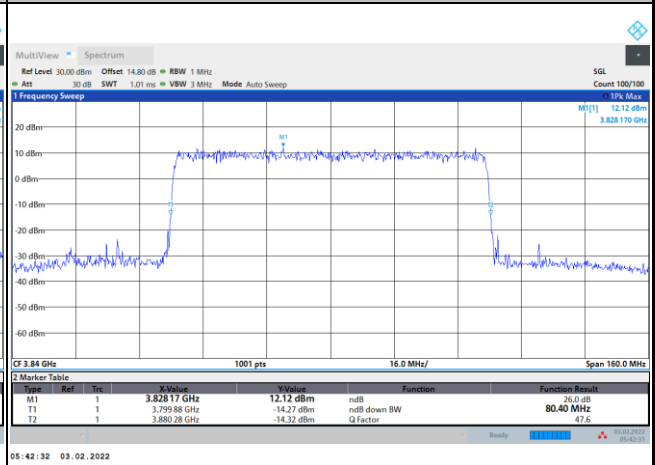



FR1 n77 / 90MHz / DFT-S OFDM / Middle Channel / Full RB

PI/2 BPSK

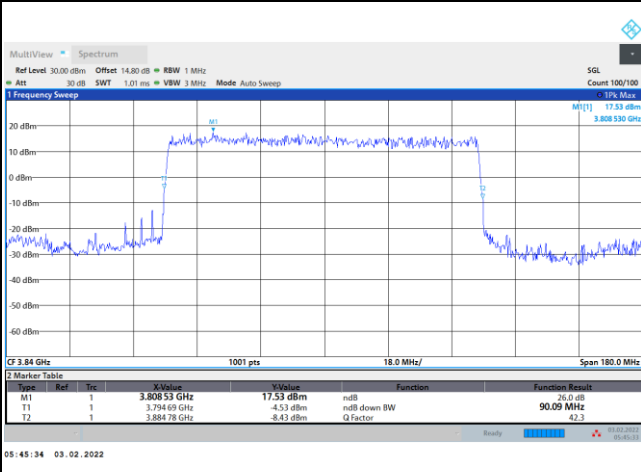

FR1 n77 / 90MHz / CP OFDM / Middle Channel / Full RB

QPSK

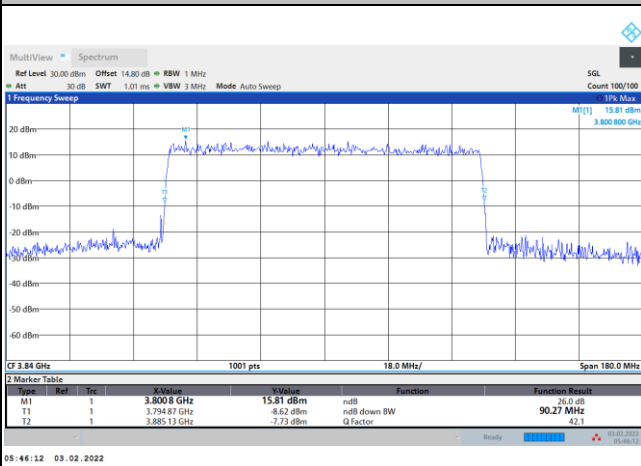

16QAM

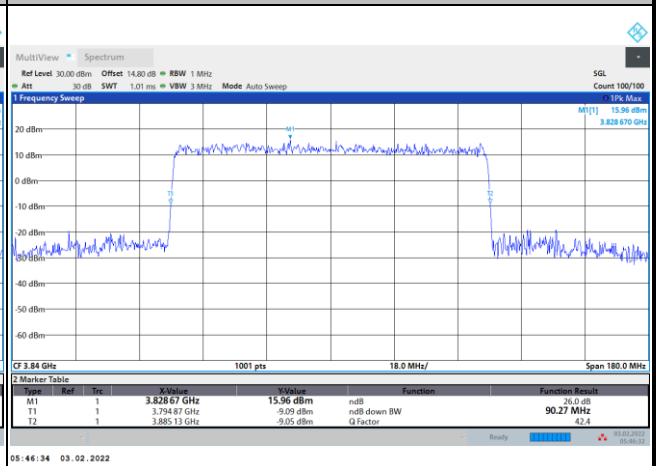

64QAM

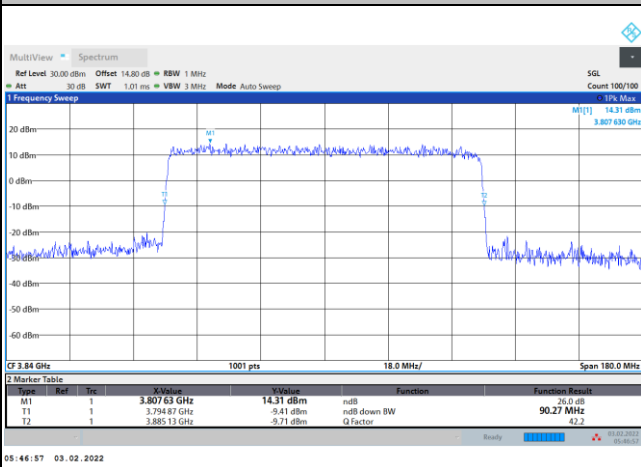

256QAM

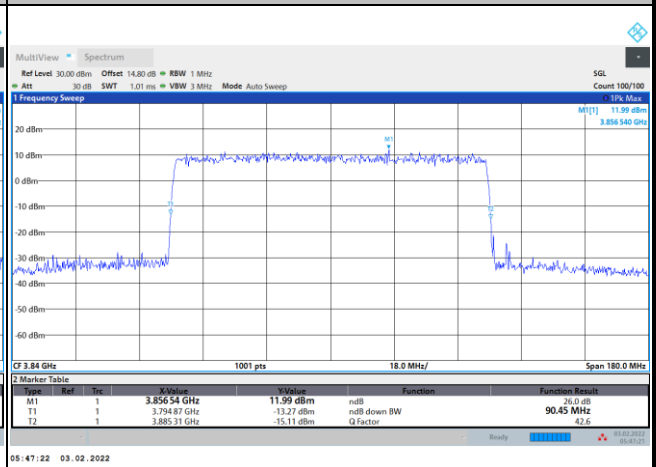



FR1 n77 / 100MHz / DFT-S OFDM / Middle Channel / Full RB

PI/2 BPSK

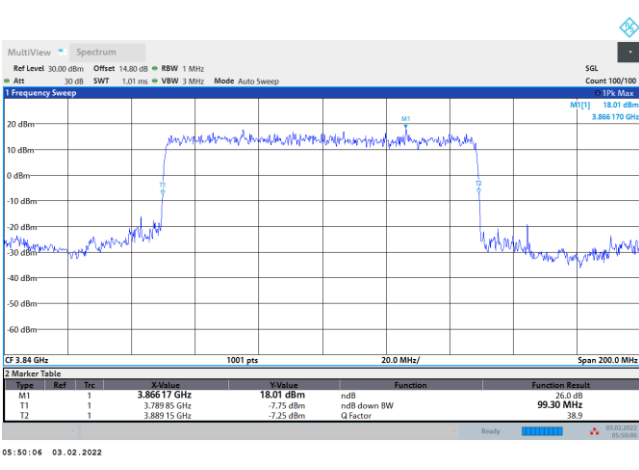

FR1 n77 / 100MHz / CP OFDM / Middle Channel / Full RB

QPSK

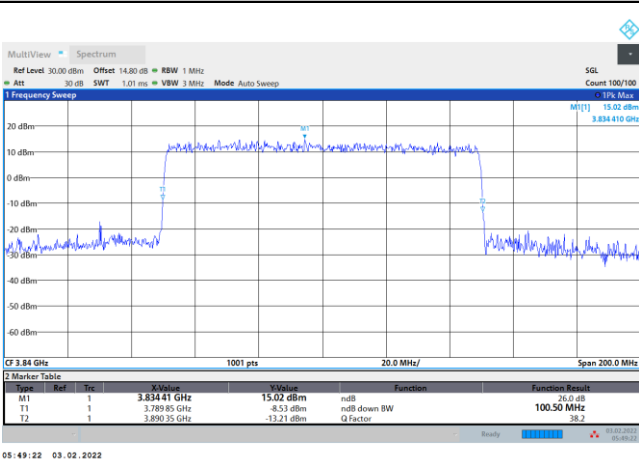

16QAM

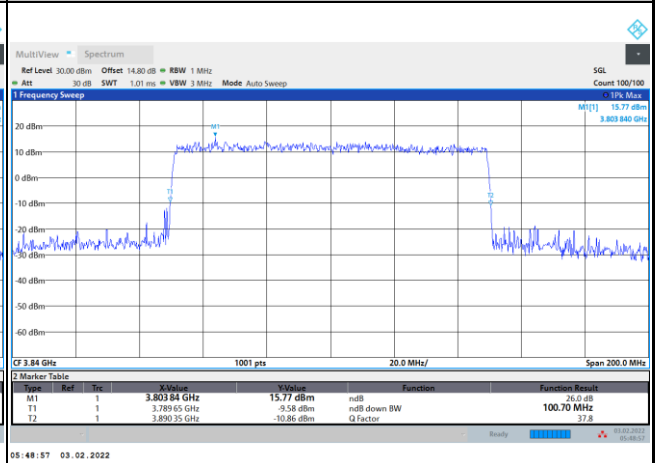

64QAM

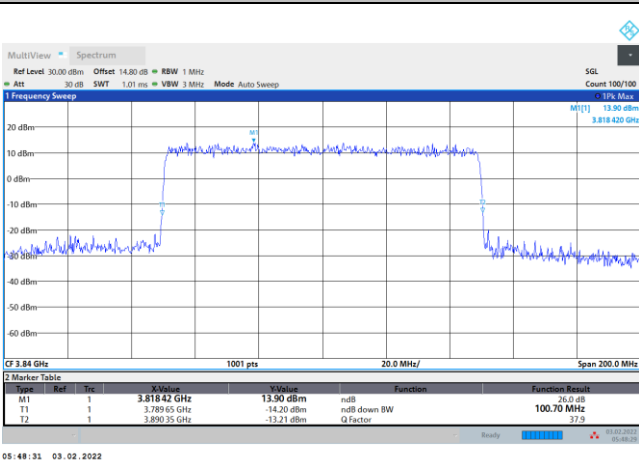

256QAM

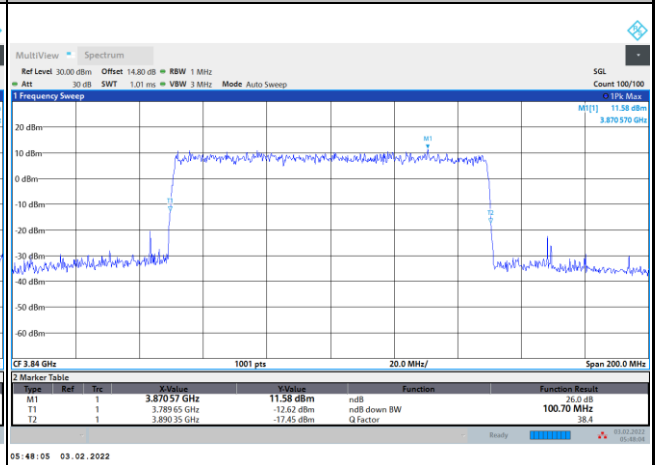



Occupied Bandwidth

Mode	FR1 n77 : OB BW(MHz) / DFT-S OFDM							
BW	10MHz	15MHz	20MHz	25MHz	30MHz	40MHz	50MHz	60MHz
Mod.	PI/2 BPSK	PI/2 BPSK	PI/2 BPSK	PI/2 BPSK	PI/2 BPSK	PI/2 BPSK	PI/2 BPSK	PI/2 BPSK
Middle CH	8.93	13.46	17.86	-	-	38.64	48.18	57.90
BW	70MHz	80MHz	90MHz	100MHz				
Mod.	PI/2 BPSK	PI/2 BPSK	PI/2 BPSK	PI/2 BPSK				
Middle CH	-	76.94	86.68	96.26				

Mode	FR1 n77 : OB BW(MHz) / CP OFDM							
BW	10MHz		15MHz		20MHz		25MHz	
Mod.	QPSK	16QAM	QPSK	16QAM	QPSK	16QAM	QPSK	16QAM
Middle CH	9.28	9.26	14.13	14.15	18.91	18.95	-	-
Mod.	64QAM	256QAM	64QAM	256QAM	64QAM	256QAM	64QAM	256QAM
Middle CH	9.30	9.26	14.11	14.14	18.91	18.97	-	-
BW	30MHz		40MHz		50MHz		60MHz	
Mod.	QPSK	16QAM	QPSK	16QAM	QPSK	16QAM	QPSK	16QAM
Middle CH	-	-	38.42	38.55	48.27	48.26	57.78	57.70
Mod.	64QAM	256QAM	64QAM	256QAM	64QAM	256QAM	64QAM	256QAM
Middle CH	-	-	38.55	38.49	48.25	48.39	57.74	57.75
BW	70MHz		80MHz		90MHz		100MHz	
Mod.	QPSK	16QAM	QPSK	16QAM	QPSK	16QAM	QPSK	16QAM
Middle CH	-	-	77.36	77.49	87.17	87.24	97.28	97.20
Mod.	64QAM	256QAM	64QAM	256QAM	64QAM	256QAM	64QAM	256QAM
Middle CH	-	-	77.30	77.41	87.24	87.43	97.41	97.02



FR1 n77 / 10MHz / DFT-S OFDM / Middle Channel / Full RB

PI/2 BPSK

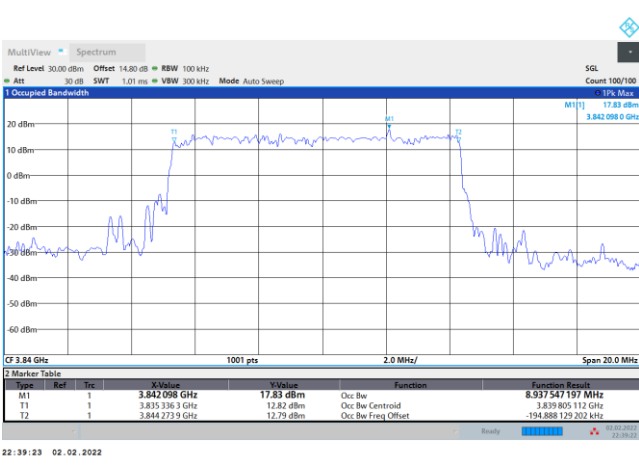

FR1 n77 / 10MHz / CP OFDM / Middle Channel / Full RB

QPSK

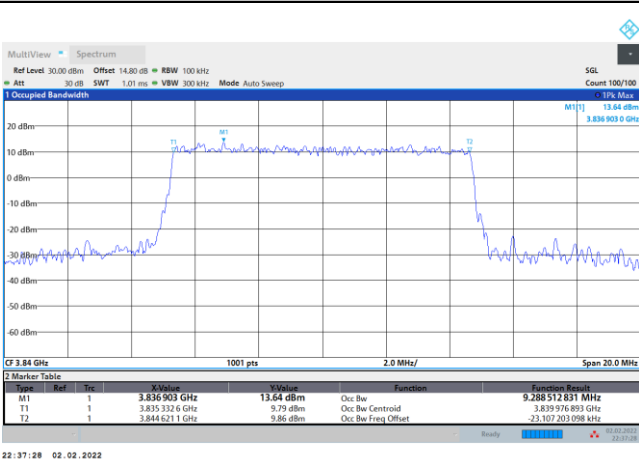

16QAM

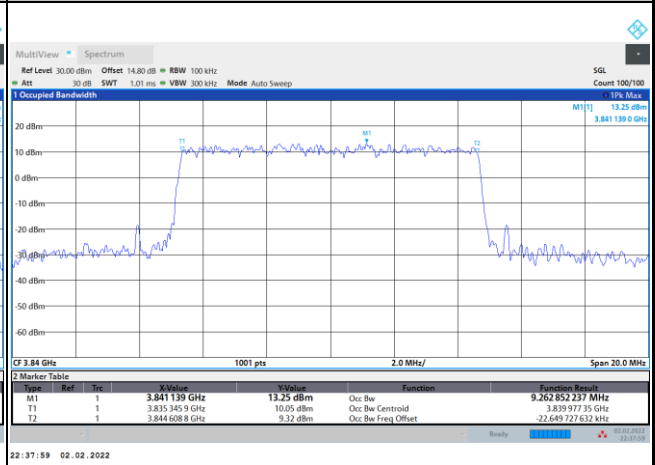

64QAM

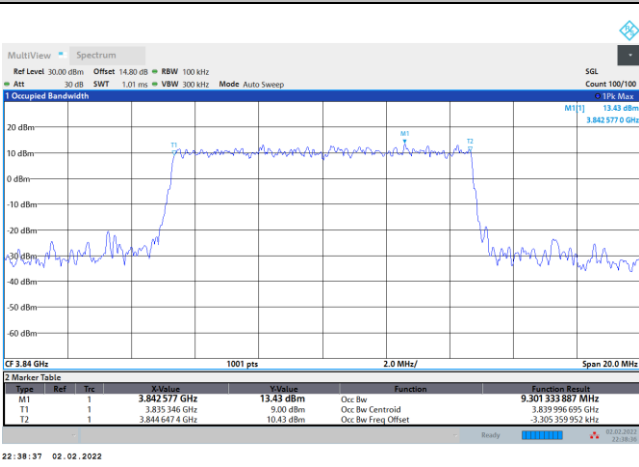

256QAM

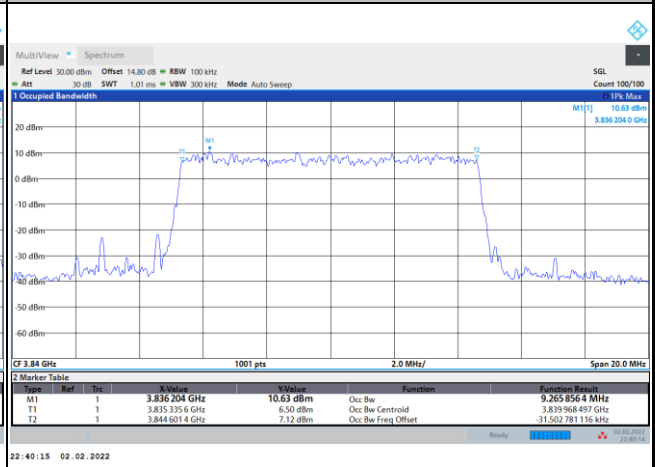



FR1 n77 / 15MHz / DFT-S OFDM / Middle Channel / Full RB

PI/2 BPSK

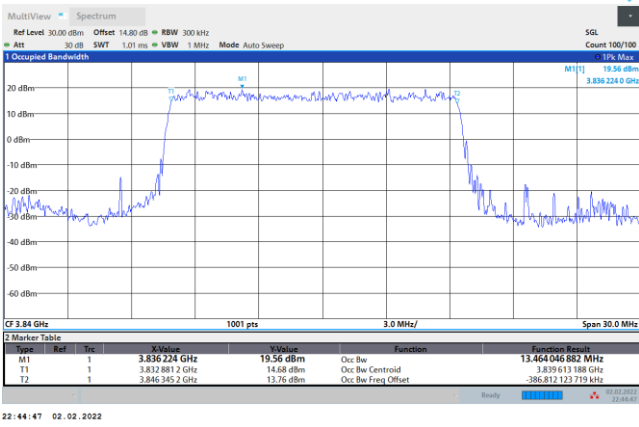

FR1 n77 / 15MHz / CP OFDM / Middle Channel / Full RB

QPSK

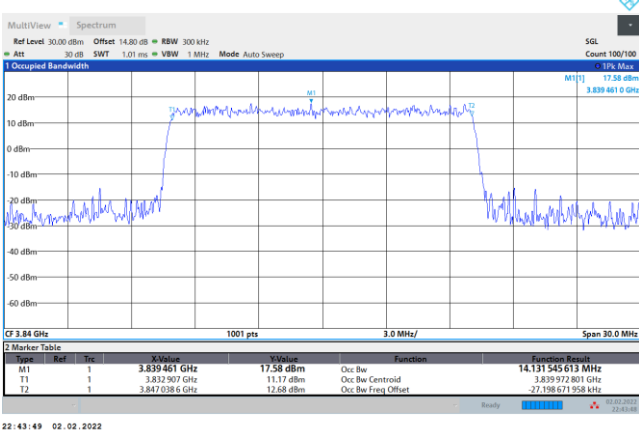

16QAM

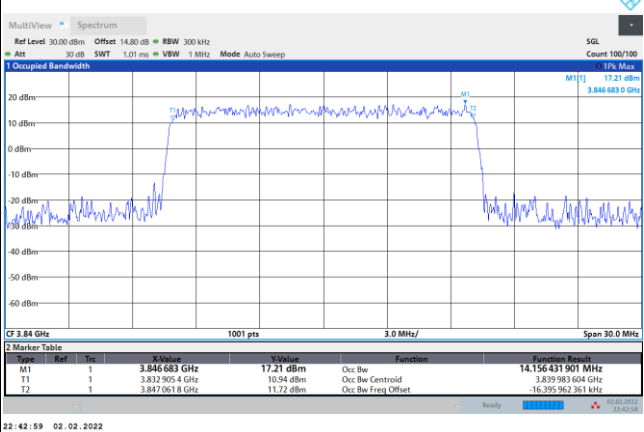

64QAM

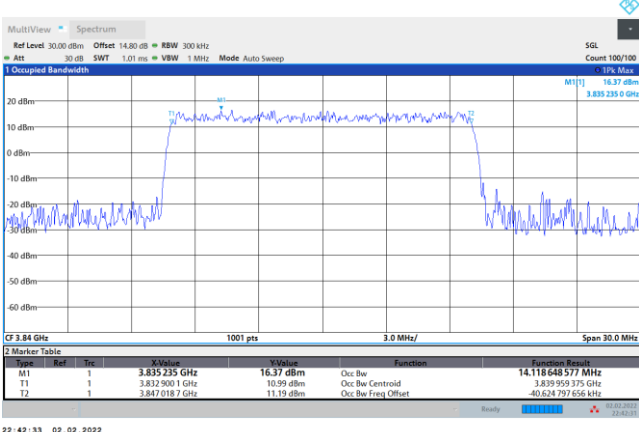

256QAM

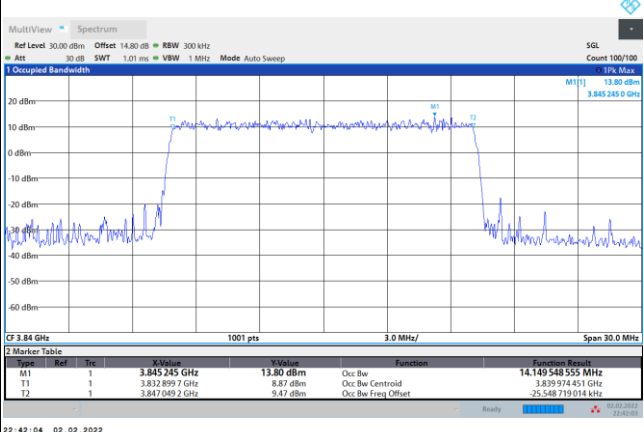



FR1 n77 / 20MHz / DFT-S OFDM / Middle Channel / Full RB

PI/2 BPSK

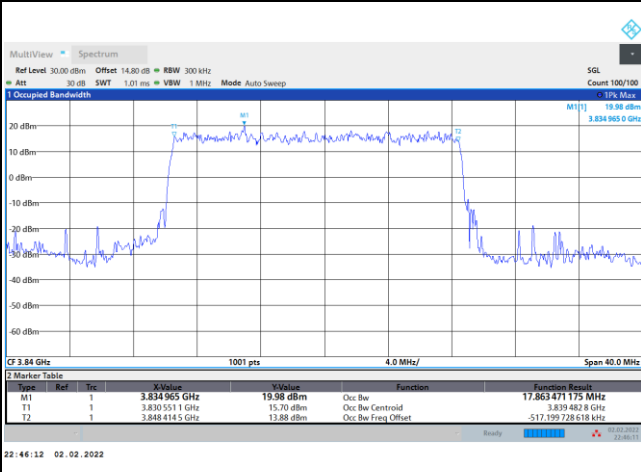

FR1 n77 / 20MHz / CP OFDM / Middle Channel / Full RB

QPSK

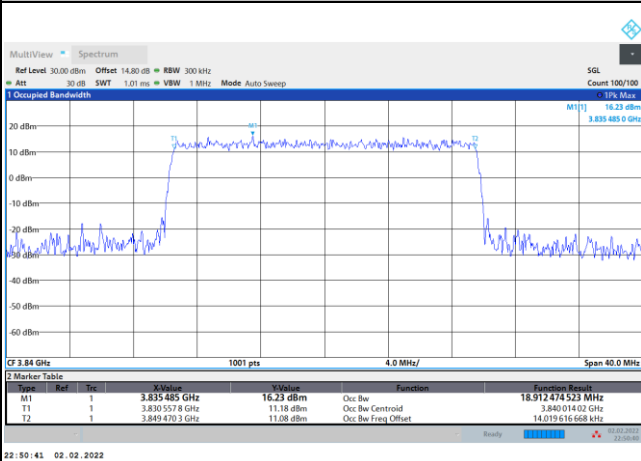

16QAM

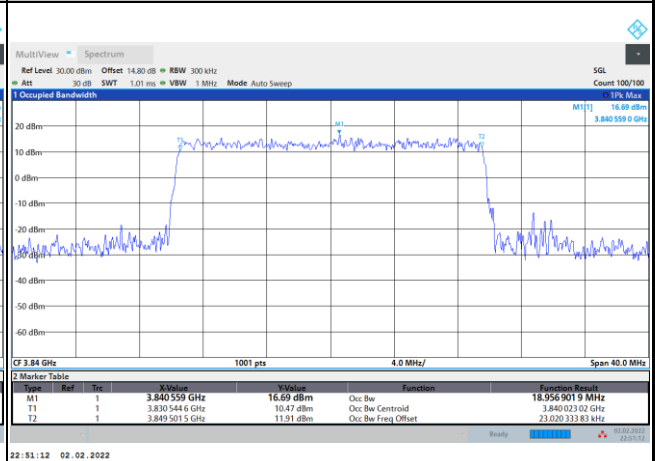

64QAM

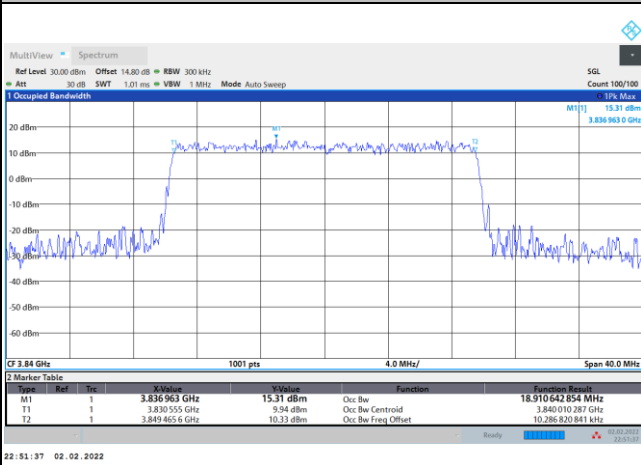

256QAM

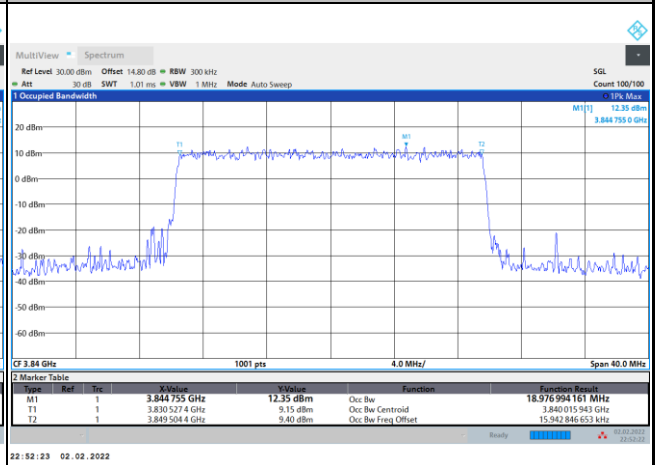



FR1 n77 / 40MHz / DFT-S OFDM / Middle Channel / Full RB

PI/2 BPSK

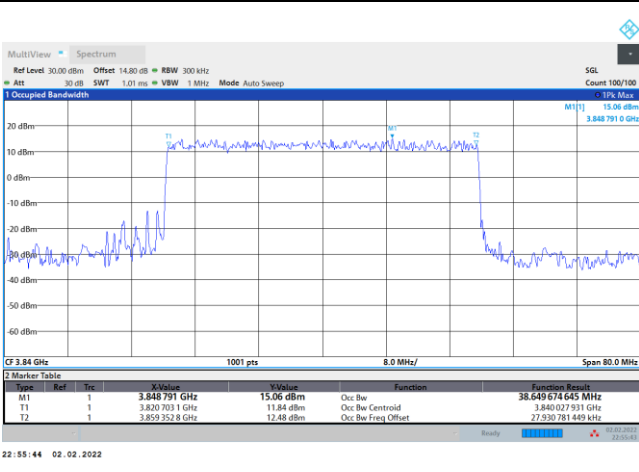

FR1 n77 / 40MHz / CP OFDM / Middle Channel / Full RB

QPSK

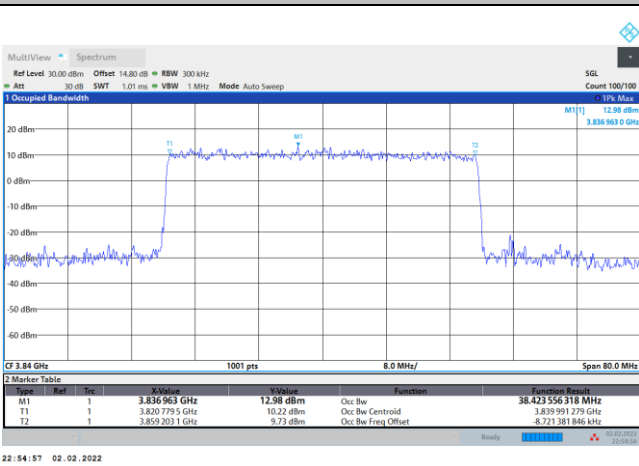

16QAM

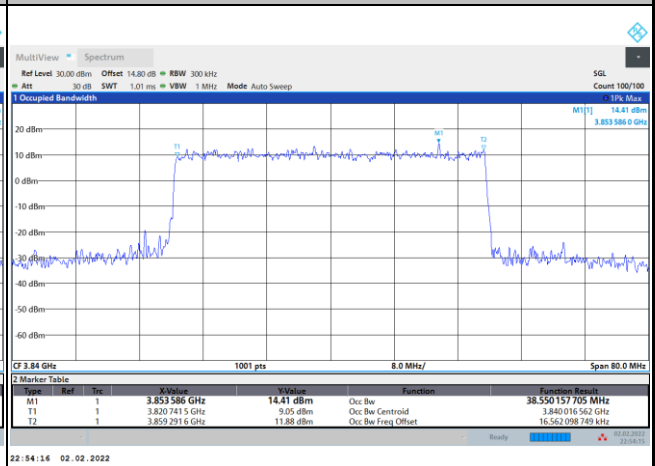

64QAM

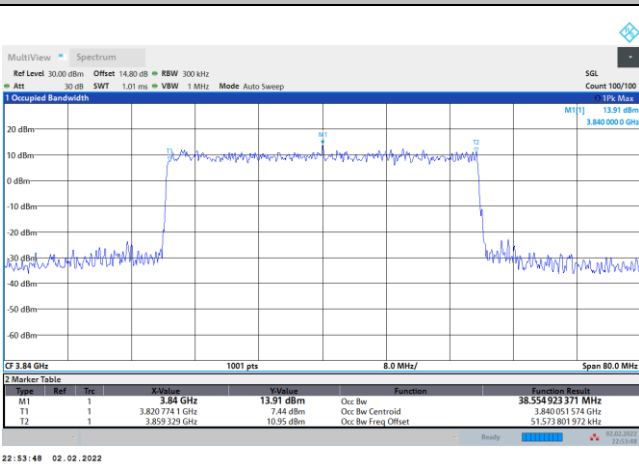

256QAM

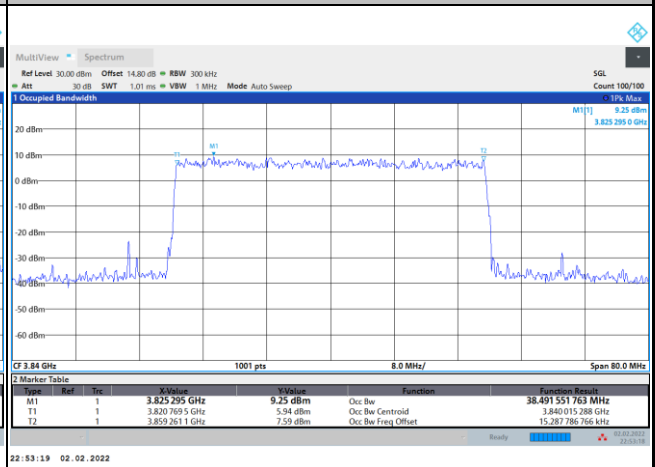



FR1 n77 / 50MHz / DFT-S OFDM / Middle Channel / Full RB

PI/2 BPSK

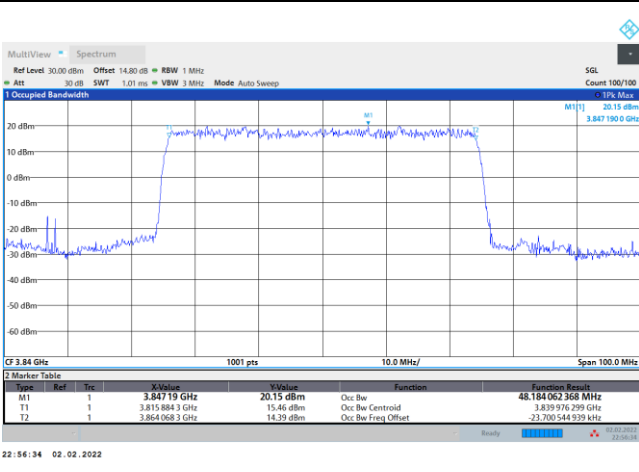

FR1 n77 / 50MHz / CP OFDM / Middle Channel / Full RB

QPSK

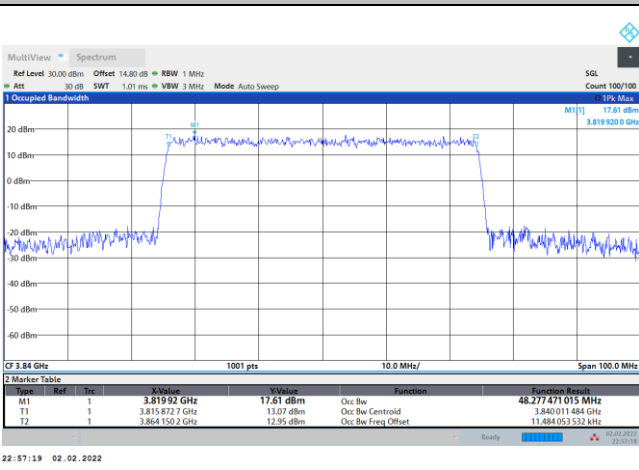

16QAM

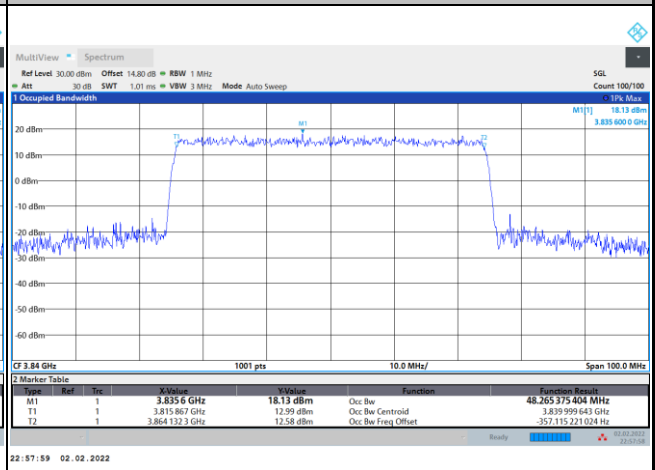

64QAM

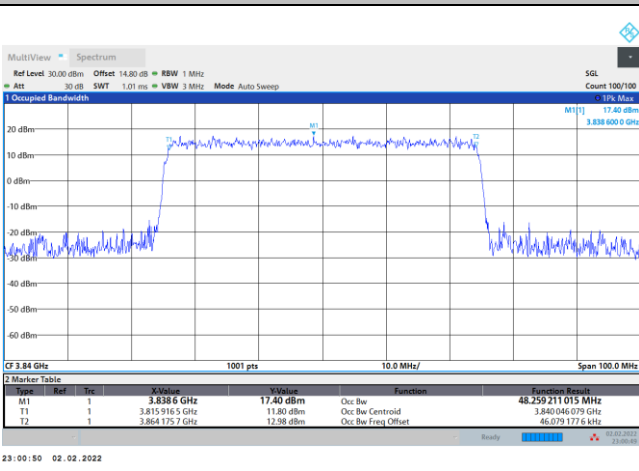

256QAM

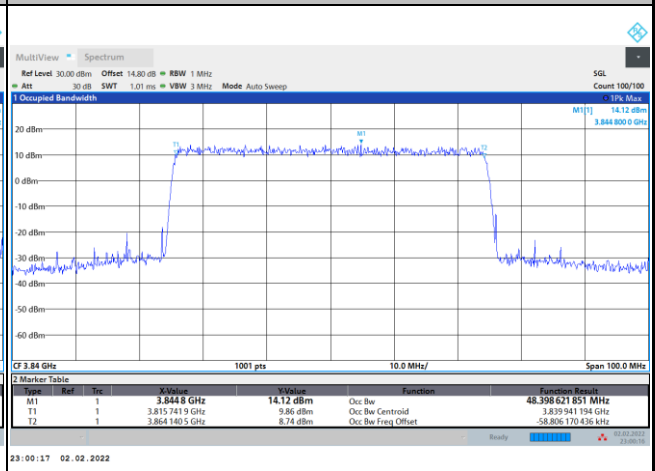



FR1 n77 / 60MHz / DFT-S OFDM / Middle Channel / Full RB

PI/2 BPSK

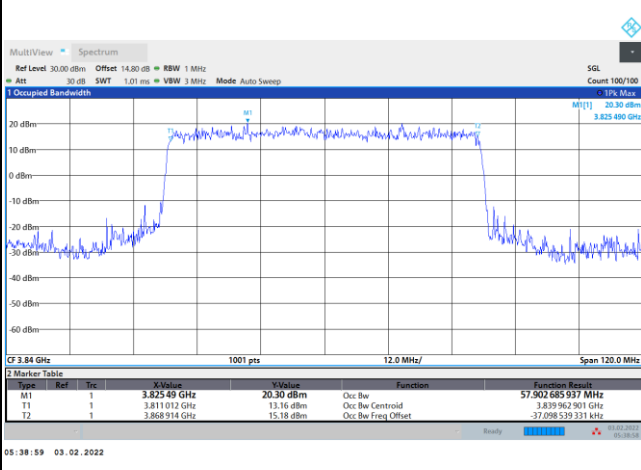

FR1 n77 / 60MHz / CP OFDM / Middle Channel / Full RB

QPSK

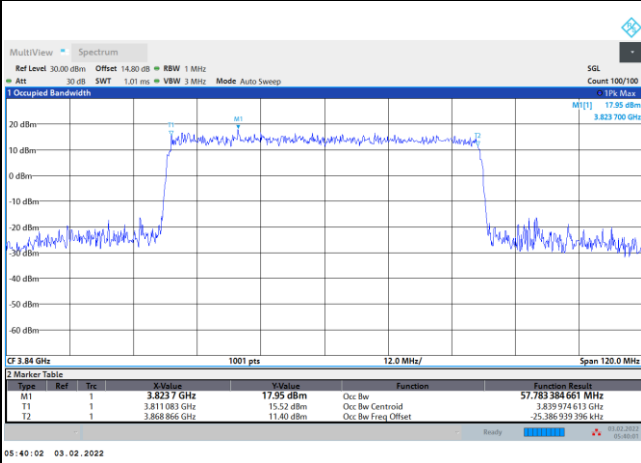

16QAM

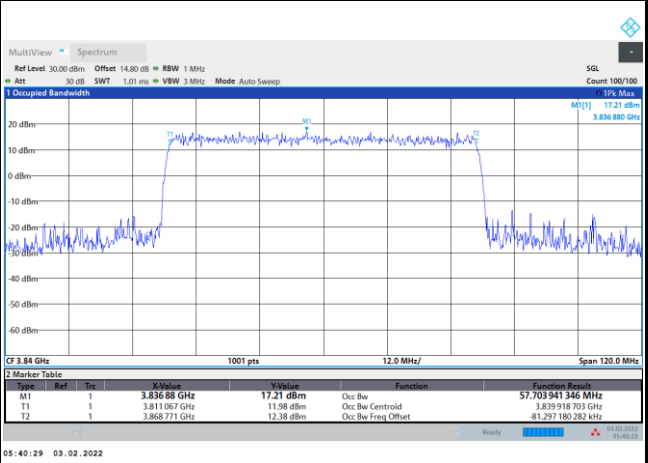

64QAM

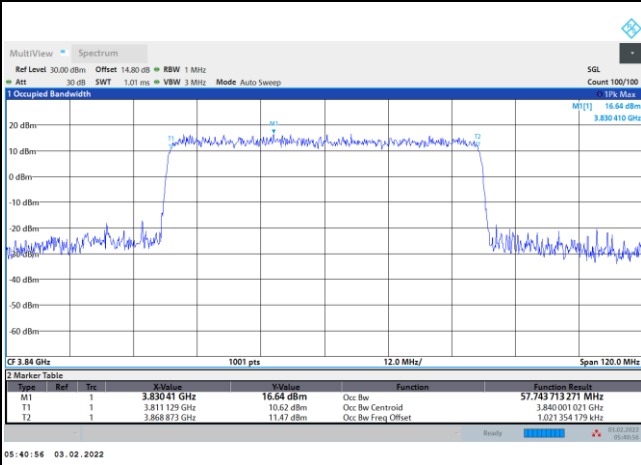

256QAM

