



FCC RADIO TEST REPORT

FCC ID : GKRRMLV1
Equipment : 5G LGA Module
Brand Name : COMPAL
Model Name : RML-N1v
Marketing Name : 5G LGA Module
Applicant : Compal Electronics, Inc.
No.581 & 581-1, Ruiguang Rd., Neihu District, Taipei, (114) Taiwan
Manufacturer : Compal Electronics, Inc.
No.581 & 581-1, Ruiguang Rd., Neihu District, Taipei, (114) Taiwan
Standard : FCC 47 CFR Part 2, 96

The product was received on Jan. 14, 2022 and testing was performed from Jan. 14, 2022 to Feb. 25, 2022. We, Sporton International Inc. EMC & Wireless Communications Laboratory, would like to declare that the tested sample has been evaluated in accordance with the test procedures given in ANSI / TIA-603-E and has been in compliance with the applicable technical standards.

The test results in this report apply exclusively to the tested model / sample. Without written approval of Sporton International Inc. EMC & Wireless Communications Laboratory, the test report shall not be reproduced except in full.

Louis Wu

Approved by: Louis Wu

Sporton International Inc. EMC & Wireless Communications Laboratory

No. 52, Huaya 1st Rd., Guishan Dist., Taoyuan City 333, Taiwan (R.O.C.)



Table of Contents

History of this test report..... 3

Summary of Test Result..... 4

1 General Description 5

 1.1 Product Feature of Equipment Under Test 5

 1.2 Modification of EUT 5

 1.3 Testing Location 5

 1.4 Applied Standards 6

2 Test Configuration of Equipment Under Test 7

 2.1 Test Mode..... 7

 2.2 Connection Diagram of Test System 8

 2.3 Support Unit used in test configuration 9

 2.4 Measurement Results Explanation Example 9

 2.5 Frequency List of Low/Middle/High Channels..... 9

3 Conducted Test Items 11

 3.1 Measuring Instruments 11

 3.2 Conducted Output Power 12

 3.3 Peak-to-Average Ratio 13

 3.4 EIRP 14

 3.5 Occupied Bandwidth 15

 3.6 Conducted Band Edge 16

 3.7 Conducted Spurious Emission 17

 3.8 Frequency Stability 18

4 Radiated Test Items 19

 4.1 Measuring Instruments 19

 4.2 Test Setup 19

 4.3 Test Result of Radiated Test 20

 4.4 Radiated Spurious Emission 21

5 List of Measuring Equipment..... 22

6 Uncertainty of Evaluation 24

Appendix A. Test Results of Conducted Test

Appendix B. Test Results of Radiated Test

Appendix C. Test Setup Photographs



Summary of Test Result

Report Clause	Ref Std. Clause	Test Items	Result (PASS/FAIL)	Remark
3.2	§2.1046	Conducted Output Power	Reporting only	-
3.3	§96.41	Peak-to-Average Ratio	Pass	-
3.4	§96.41	Effective Isotropic Radiated Power	Pass	-
3.5	§2.1049 §96.41	Occupied Bandwidth	Reporting only	-
3.6	§2.1051 §96.41	Conducted Band Edge Measurement	Pass	-
3.7	§2.1051 §96.41	Conducted Spurious Emission	Pass	-
3.8	§2.1055	Frequency Stability for Temperature & Voltage	Pass	-
4.4	§2.1051 §96.41	Radiated Spurious Emission	Pass	Under limit 3.40 dB at 10848.000 MHz

Declaration of Conformity:

1. The test results (PASS/FAIL) with all measurement uncertainty excluded are presented in accordance with the regulation limits or requirements declared by manufacturers.
It's means measurement values may risk exceeding the limit of regulation standards, if measurement uncertainty is include in test results.
2. The measurement uncertainty please refer to this report "Uncertainty of Evaluation".

Comments and Explanations:

The product specifications of the EUT presented in the report are declared by the manufacturer who shall take full responsibility for the authenticity.

Reviewed by: Keven Cheng

Report Producer: Vivian Hsu



1 General Description

1.1 Product Feature of Equipment Under Test

LTE/5G NR and GNSS

Product Specification subjective to this standard	
Test Antenna Type	Monopole Antenna
Test Antenna Gain	<Ant. 5>: LTE Band 48: -3.27 dBi <Ant. 6>: LTE Band 48: -2.99 dBi

Remark:

1. The above EUT's information was declared by manufacturer. Please refer to Comments and Explanations in report summary.
2. The above antenna information was declared by manufacturer and used for Radiated Spurious Emission test.

1.2 Modification of EUT

No modifications are made to the EUT during all test items.

1.3 Testing Location

Test Site	Sporton International Inc. EMC & Wireless Communications Laboratory
Test Site Location	No.52, Huaya 1st Rd., Guishan Dist., Taoyuan City 333, Taiwan (R.O.C.) TEL: +886-3-327-3456 FAX: +886-3-328-4978
Test Site No.	Sporton Site No. TH03-HY
Test Engineer	Bryant Liu
Temperature (°C)	22.2~23.6
Relative Humidity (%)	55~61

Test Site	Sporton International Inc. Wensan Laboratory.
Test Site Location	No.58, Aly. 75, Ln. 564, Wenhua 3rd, Rd., Guishan Dist., Taoyuan City 333010, Taiwan (R.O.C.) TEL: +886-3-327-0868 FAX: +886-3-327-0855
Test Site No.	Sporton Site No. 03CH12-HY (TAF Code: 3786)
Test Engineer	Jack Cheng, Lance Chiang and Chuan Chu
Temperature (°C)	21.2~24.2
Relative Humidity (%)	58.2~68.8
Remark	The Radiated Spurious Emission test item subcontracted to Sporton International Inc. Wensan Laboratory.

Note: The test site complies with ANSI C63.4 2014 requirement.

FCC Designation No.: TW1190 and TW3786



1.4 Applied Standards

According to the specifications of the manufacturer, the EUT must comply with the requirements of the following standards:

- ♦ ANSI C63.26-2015
- ♦ ANSI / TIA-603-E
- ♦ FCC 47 CFR Part 2, 96
- ♦ FCC KDB 971168 D01 Power Meas. License Digital Systems v03r01
- ♦ FCC KDB 940660 D01 Part 96 CBRS Eqpt v03
- ♦ FCC KDB 412172 D01 Determining ERP and EIRP v01r01
- ♦ FCC KDB 414788 D01 Radiated Test Site v01r01

Remark:

1. All test items were verified and recorded according to the standards and without any deviation during the test.
2. This EUT has also been tested and complied with the requirements of FCC Part 15, Subpart B, recorded in a separate test report.
3. The TAF code is not including all the FCC KDB listed without accreditation.



2 Test Configuration of Equipment Under Test

2.1 Test Mode

Antenna port conducted and radiated test items listed below are performed according to KDB 971168 D01 Power Meas. License Digital Systems v03r01 with maximum output power.

The measured emission level of the EUT was maximized by rotating the EUT on a turntable, adjusting the orientation of the EUT and EUT antenna in three orthogonal axis (X: flat, Y: portrait, Z: landscape), and adjusting the measurement antenna orientation, following C63.26 exploratory test procedures and find Z Plane as worst plane.

Test Items	Band	Bandwidth (MHz)						Modulation				RB #			Test Channel		
		1.4	3	5	10	15	20	QPSK	16QAM	64QAM	256QAM	1	Half	Full	L	M	H
Max. Output Power	48	-	-	v	v	v	v	v	v	v	v	v	v	v	v	v	v
26dB and 99% Bandwidth	48	-	-	v	v	v	v	v	v	v	v			v		v	
Conducted Band Edge	48	-	-	v	v	v	v	v	v	v	v	v		v	v	v	v
Peak-to-Average Ratio	48	-	-				v	v	v	v	v			v		v	
Conducted Spurious Emission	48	-	-	v	v	v	v	v				v			v	v	v
E.I.R.P	48	-	-	v	v	v	v	v	v	v	v	Max. Power					
Frequency Stability	48	-	-		v			v				v				v	
Radiated Spurious Emission	48	Worst Case												v	v	v	
Remark	<ol style="list-style-type: none"> The mark "v" means that this configuration is chosen for testing The mark "-" means that this bandwidth is not supported. The device is investigated from 30MHz to 10 times of fundamental signal for radiated spurious emission test under different RB size/offset and modulations in exploratory test. Subsequently, only the worst case emissions are reported. LTE Band 48, support Ant. 5, Ant. 6, after verified, the worst case is Ant. 5. Therefore, only performed the Ant. 5 test results in this report. The Ant. 6 test combination is ENDC 48A-n77A 																



Test Items	Band	Bandwidth (MHz)										Modulation				RB #			Test Channel		
		20+20	20+15	15+20	20+10	10+20	20+5	5+20	15+15	15+10	10+15	QPSK	16QAM	64QAM	256QAM	1	Half	Full	L	M	H
Max. Output Power	48C_CA	v	v	v	v	v	v	v	-	-	-	v	v	v	v	v	v	v	v	v	v
26dB and 99% Bandwidth	48C_CA	v	v	v	v	v	v	v	-	-	-	v	v	v	v			v			v
Conducted Band Edge	48C_CA	v	v	v	v	v	v	v	-	-	-	v	v	v	v	v		v	v	v	v
Conducted Spurious Emission	48C_CA	v	v	v	v	v	v	v	-	-	-	v				v			v	v	v
E.I.R.P.	48C_CA	v	v	v	v	v	v	v	-	-	-	v	v	v	v	Max. Power					
Radiated Spurious Emission	48C_CA	Worst Case																v	v	v	
Remark	1. The mark "v" means that this configuration is chosen for testing 2. The mark "-" means that this bandwidth is not supported. 3. The device is investigated from 30MHz to 10 times of fundamental signal for radiated spurious emission test under different RB size/offset and modulations in exploratory test. Subsequently, only the worst case emissions are reported.																				

2.2 Connection Diagram of Test System

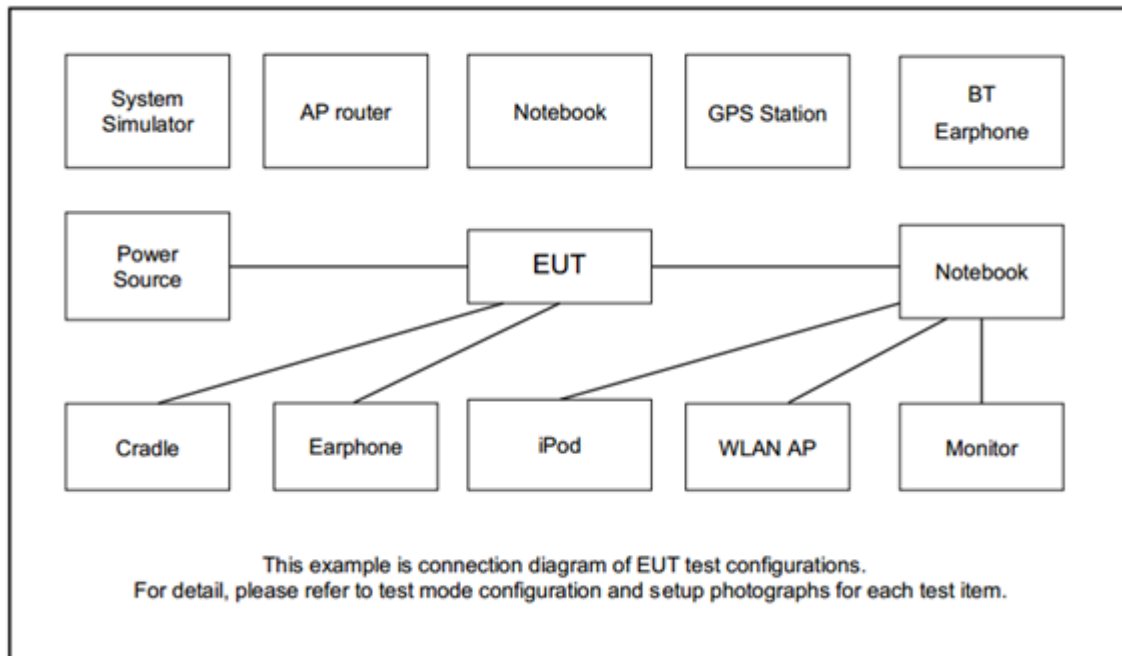



2.3 Support Unit used in test configuration

Item	Equipment	Brand Name	Model No.	FCC ID	Data Cable	Power Cord
1.	Radio Communication Analyzer	Anritsu	MT8821C	N/A	N/A	Unshielded, 1.8 m
2.	Fixture	Compal	ZM32	N/A	N/A	N/A

2.4 Measurement Results Explanation Example

For all conducted test items:

The offset level is set in the spectrum analyzer to compensate the RF cable loss and attenuator factor between EUT conducted output port and spectrum analyzer. With the offset compensation, the spectrum analyzer reading level is exactly the EUT RF output level.

The spectrum analyzer offset is derived from RF cable loss and attenuator factor.

Offset = RF cable loss + attenuator factor.

Following shows an offset computation example with cable loss 4.2 dB and 10dB attenuator.

Example :

$$\begin{aligned}
 \text{Offset(dB)} &= \text{RF cable loss(dB)} + \text{attenuator factor(dB)}. \\
 &= 4.2 + 10 = 14.2 \text{ (dB)}
 \end{aligned}$$

2.5 Frequency List of Low/Middle/High Channels

LTE Band 48 Channel and Frequency List				
BW [MHz]	Channel/Frequency(MHz)	Lowest	Middle	Highest
20	Channel	55340	55990	56640
	Frequency	3560.0	3625.0	3690.0
15	Channel	55315	55990	56665
	Frequency	3557.5	3625.0	3692.5
10	Channel	55290	55990	56690
	Frequency	3555.0	3625.0	3695.0
5	Channel	55265	55990	56715
	Frequency	3552.5	3625.0	3697.5



LTE Band 48C Channel and Frequency List_CA					
BW [MHz]	Channel/Frequency(MHz)		Lowest	Middle	Highest
5 + 20	PCC	Channel	55273	55898	56523
		Frequency	3553.3	3615.8	3678.3
	SCC	Channel	55390	56015	56640
		Frequency	3565	3627.5	3690
20 + 5	PCC	Channel	55340	55965	56590
		Frequency	3560	3622.5	3685
	SCC	Channel	55457	56082	56707
		Frequency	3571.7	3634.2	3696.7
10 + 20	PCC	Channel	55295	55896	56496
		Frequency	3555.5	3615.6	3675.6
	SCC	Channel	55439	56040	56640
		Frequency	3569.9	3630	3690
20 + 10	PCC	Channel	55340	55941	56541
		Frequency	3560	3620.1	3680.1
	SCC	Channel	55484	56085	56685
		Frequency	3574.4	3634.5	3694.5
15 + 20	PCC	Channel	55318	55893	56469
		Frequency	3557.8	3615.3	3672.9
	SCC	Channel	55489	56064	56640
		Frequency	3574.9	3632.4	3690
20 + 15	PCC	Channel	55340	55916	56491
		Frequency	3560	3617.6	3675.1
	SCC	Channel	55511	56087	56662
		Frequency	3577.1	3634.7	3692.2
20 + 20	PCC	Channel	55340	55891	56442
		Frequency	3560	3615.1	3670.2
	SCC	Channel	55538	56089	56640
		Frequency	3579.8	3634.9	3690

3 Conducted Test Items

3.1 Measuring Instruments

See list of measuring instruments of this test report.

3.1.1 Test Setup

3.1.2 Conducted Output Power



3.1.3 Peak-to-Average Ratio, Occupied Bandwidth, Conducted Band-Edge and Conducted Spurious Emission



3.1.4 Frequency Stability

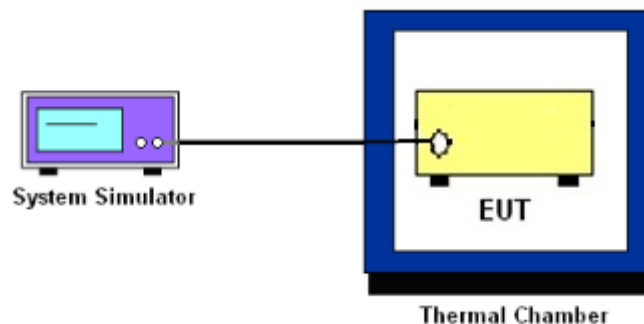

3.1.5 Test Result of Conducted Test

Please refer to Appendix A.



3.2 Conducted Output Power

3.2.1 Description of the Conducted Output Power Measurement

A system simulator was used to establish communication with the EUT. Its parameters were set to force the EUT transmitting at maximum output power. The measured power in the radio frequency on the transmitter output terminals shall be reported.

3.2.2 Test Procedures

1. The transmitter output port was connected to the system simulator.
2. Set EUT at maximum power through the system simulator.
3. Select lowest, middle, and highest channels for each band and different modulation.
4. Measure and record the power level from the system simulator.



3.3 Peak-to-Average Ratio

3.3.1 Description of the PAR Measurement

Power Complementary Cumulative Distribution Function (CCDF) curves provide a means for characterizing the power peaks of a digitally modulated signal on a statistical basis. A CCDF curve depicts the probability of the peak signal amplitude exceeding the average power level. Most contemporary measurement instrumentation include the capability to produce CCDF curves for an input signal provided that the instrument's resolution bandwidth can be set wide enough to accommodate the entire input signal bandwidth. In measuring transmissions in this band using an average power technique, the peak-to-average ratio (PAR) of the transmission may not exceed 13 dB.

3.3.2 Test Procedures

The testing follows ANSI C63.26-2015 Section 5.2.6

1. The EUT was connected to spectrum and system simulator via a power divider.
2. Set the CCDF (Complementary Cumulative Distribution Function) option in spectrum analyzer.
3. The highest RF powers were measured and recorded the maximum PAPR level associated with a probability of 0.1 %.
4. Record the deviation as Peak to Average Ratio



3.4 EIRP

3.4.1 Description of the EIRP Measurement

The EIRP of mobile transmitters must not exceed 23 dBm /10 megahertz for LTE Band 48.

The testing follows ANSI C63.26-2015 Section 5.2.5.5

According to KDB 412172 D01 Power Approach,

$EIRP = P_T + G_T - LC$, where

P_T = transmitter output power in dBm

G_T = gain of the transmitting antenna in dBi

LC = signal attenuation in the connecting cable between the transmitter and antenna in dB

Device	Maximum EIRP (dBm/10 MHz)	Maximum PSD (dBm/MHz)
End User Device	23	n/a

Remark: Total channel power is complied with EIRP limit 23dBm/10MHz.

3.4.2 Test Procedures

The testing follows procedure in Section 5.2 of ANSI C63.26-2015 and KDB 940660 D01 Part 96 CBRS Eqpt v03 Section 3.2(b)(2)

Determine the EIRP by adding the effective antenna gain to the measured average conducted power level.



3.5 Occupied Bandwidth

3.5.1 Description of Occupied Bandwidth Measurement

The occupied bandwidth is the width of a frequency band such that, below the lower and above the upper frequency limits, the mean powers emitted are each equal to a specified percentage 0.5% of the total mean transmitted power.

The 26 dB emission bandwidth is defined as the frequency range between two points, one above and one below the carrier frequency, at which the spectral density of the emission is attenuated 26 dB below the maximum in-band spectral density of the modulated signal. Spectral density (power per unit bandwidth) is to be measured with a detector of resolution bandwidth equal to approximately 1.0% of the emission bandwidth.

3.5.2 Test Procedures

The testing follows ANSI C63.26-2015 Section 5.4.3 (26dB) and Section 5.4.4 (99OB)

1. The EUT was connected to spectrum analyzer and system simulator via a power divider.
2. The spectrum analyzer center frequency is set to the nominal EUT channel center frequency. The span range for the spectrum analyzer shall be between two and five times the anticipated OBW.
3. The nominal resolution bandwidth (RBW) shall be in the range of 1 to 5 % of the anticipated OBW, and the VBW shall be at least 3 times the RBW.
4. Set the detection mode to peak, and the trace mode to max hold.
5. Determine the reference value: Set the EUT to transmit a modulated signal. Allow the trace to stabilize. Set the spectrum analyzer marker to the highest level of the displayed trace.
(this is the reference value)
6. Determine the “-26 dB down amplitude” as equal to (Reference Value – X).
7. Place two markers, one at the lowest and the other at the highest frequency of the envelope of the spectral display such that each marker is at or slightly below the “-X dB down amplitude” determined in step 6. If a marker is below this “-X dB down amplitude” value it shall be placed as close as possible to this value. The OBW is the positive frequency difference between the two markers.
8. Use the 99 % power bandwidth function of the spectrum analyzer and report the measured bandwidth.



3.6 Conducted Band Edge

3.6.1 Description of Conducted Band Edge Measurement

The conducted power of any End User Device emission outside the fundamental emission (whether in or outside of the authorized band) shall not exceed -13 dBm/MHz within 0 to B megahertz (where B is the bandwidth in megahertz of the assigned channel or multiple contiguous channels of the End User Device) above the upper CBSD-assigned channel edge and within 0 to B megahertz below the lower CBSD-assigned channel edge. At all frequencies greater than B megahertz above the upper CBSD assigned channel edge and less than B megahertz below the lower CBSD-assigned channel edge, the conducted power of any End User Device emission shall not exceed -25 dBm/MHz. Notwithstanding the emission limits in this paragraph, the Adjacent Channel Leakage Ratio for End User Devices shall be at least 30 dB.

3.6.2 Test Procedures

The testing follows FCC KDB 971168 D01 v03r01 Section 6.1.

1. The EUT was connected to spectrum analyzer and system simulator via a power divider.
2. The band edges of low and high channels for the highest RF powers were measured.
3. Set RBW $\geq 1\%$ EBW in the 1MHz band immediately outside and adjacent to the band edge.
4. Beyond the 1 MHz band from the band edge, RBW=1MHz was used
5. Set spectrum analyzer with RMS detector.
6. The RF fundamental frequency should be excluded against the limit line in the operating frequency band.

For Adjacent Channel Leakage Ratio (ACLR) measurement,

1. The Adjacent Channel Leakage Ratio (ACLR) is the ratio of the average power in the assigned aggregated channel bandwidth to the average power over the equivalent adjacent channel bandwidth.
2. The option ACLR of spectrum analyzer is used and measures the ACLR ratio by setting equivalent channel bandwidth.
3. The measured ACLR ratio shall be at least 30 dB.



3.7 Conducted Spurious Emission

3.7.1 Description of Conducted Spurious Emission Measurement

96.41 (e)(2)

The conducted power of any emissions below 3530 MHz or above 3720 MHz shall not exceed -40dBm/MHz.

3.7.2 Test Procedures

The testing follows FCC KDB 971168 D01 v03r01 Section 6.1.

1. The EUT was connected to spectrum analyzer and system simulator via a power divider.
2. The RF output of EUT was connected to the spectrum analyzer by RF cable and attenuator. The path loss was compensated to the results for each measurement.
3. The middle channel for the highest RF power within the transmitting frequency was measured.
4. The conducted spurious emission for the whole frequency range was taken.
5. Make the measurement with the spectrum analyzer's RBW = 1MHz, VBW = 3MHz.
6. Set spectrum analyzer with RMS detector.
7. Taking the record of maximum spurious emission.
8. The RF fundamental frequency should be excluded against the limit line in the operating frequency band.
9. The limit line is -40dBm/MHz.



3.8 Frequency Stability

3.8.1 Description of Frequency Stability Measurement

The frequency stability shall be measured by variation of ambient temperature and variation of primary supply voltage to ensure that the fundamental emission stays within the authorized frequency block. The frequency stability of the transmitter shall be maintained within $\pm 0.00025\%$ ($\pm 2.5\text{ppm}$) of the center frequency

3.8.2 Test Procedures for Temperature Variation

The testing follows FCC KDB 971168 D01 v03r01 Section 9.0.

1. The EUT was set up in the thermal chamber and connected with the system simulator.
2. With power OFF, the temperature was decreased to -30°C and the EUT was stabilized before testing. Power was applied and the maximum change in frequency was recorded within one minute.
3. With power OFF, the temperature was raised in 10°C step up to 50°C . The EUT was stabilized at each step for at least half an hour. Power was applied and the maximum frequency change was recorded within one minute.

3.8.3 Test Procedures for Voltage Variation

The testing follows FCC KDB 971168 D01 v03r01 Section 9.0.

1. The EUT was placed in a temperature chamber at $25\pm 5^{\circ}\text{C}$ and connected with the system simulator.
2. The power supply voltage to the EUT was varied from 85% to 115% of the nominal value measured at the input to the EUT.
3. The variation in frequency was measured for the worst case.

4 Radiated Test Items

4.1 Measuring Instruments

See list of measuring instruments of this test report.

4.2 Test Setup

For radiated emissions below 30MHz

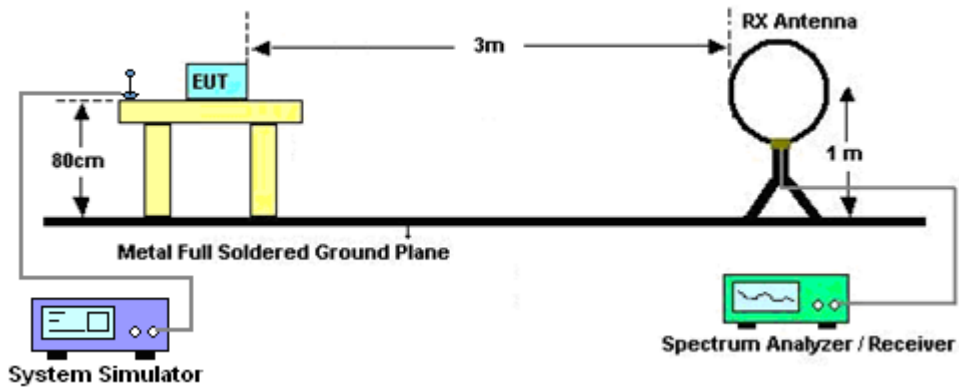

For radiated emissions from 30MHz to 1GHz

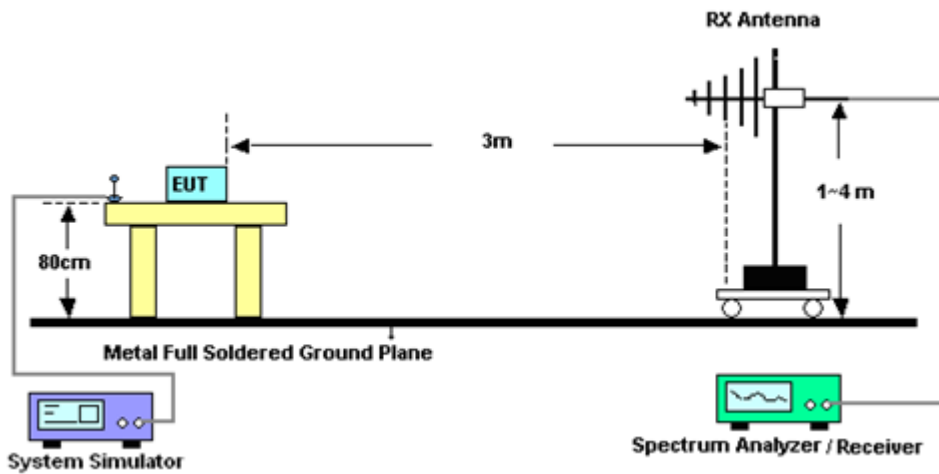

For radiated emissions from 1GHz to 18GHz

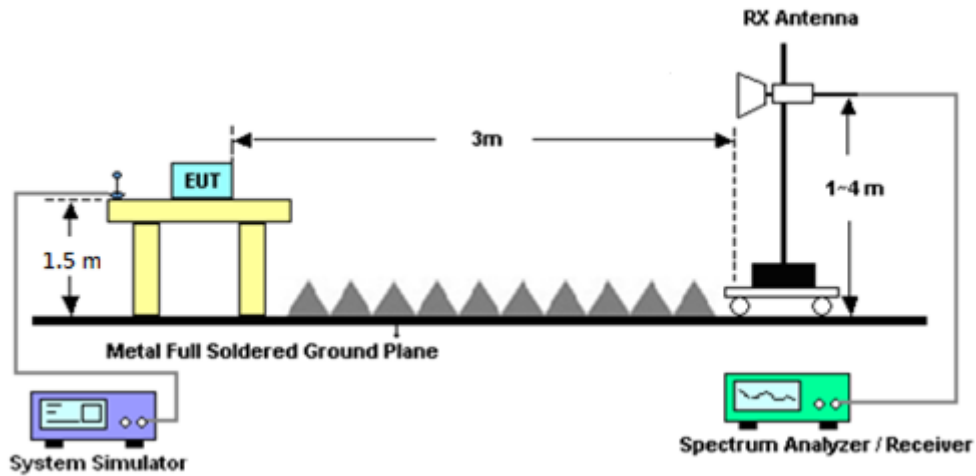

For radiated emissions above 18GHz

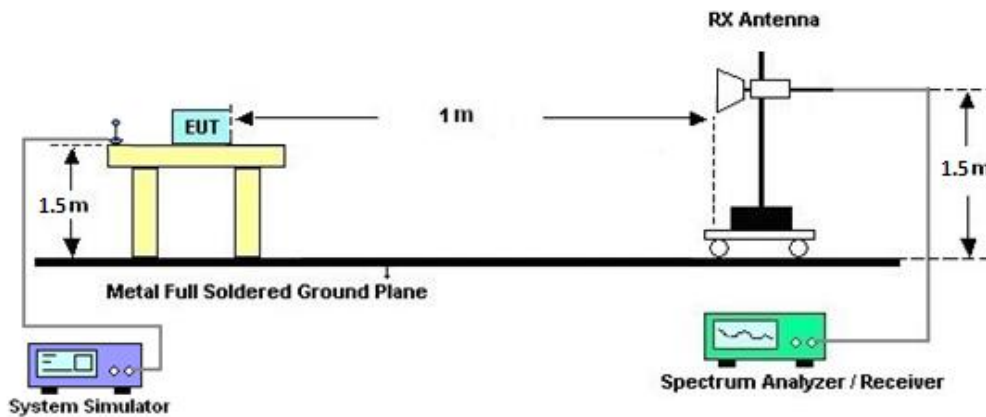

4.3 Test Result of Radiated Test

Please refer to Appendix B.

Note:

The low frequency, which started from 9 kHz to 30MHz, was pre-scanned and the result which was 20dB lower than the limit line was not reported.

There is adequate comparison measurement of both open-field test site and alternative test site - semi-Anechoic chamber according to 414788 D01 Radiated Test Site v01r01, and the result came out very similar.



4.4 Radiated Spurious Emission

4.4.1 Description of Radiated Spurious Emission Measurement

The radiated spurious emission was measured by substitution method according to ANSI / TIA-603-E. The power of any emission outside of the authorized operating frequency ranges must be attenuated below the transmitter power (P) by a factor of at least -40dBm / MHz .

The spectrum is scanned from 30 MHz up to a frequency including its 10th harmonic.

4.4.2 Test Procedures

The testing follows FCC KDB 971168 D01 v03r01 Section 7 and ANSI / TIA-603-E Section 2.2.12.

1. The EUT was placed on a turntable with 0.8 meter height for frequency below 1GHz and 1.5 meter height for frequency above 1GHz respectively above ground.
2. The EUT was set 3 meters from the receiving antenna mounted on the antenna tower.
3. The table was rotated 360 degrees to determine the position of the highest spurious emission.
4. The height of the receiving antenna is varied between 1m to 4m to search the maximum spurious emission for both horizontal and vertical polarizations.
5. During the measurement, the system simulator parameters were set to force the EUT transmitting at maximum output power.
6. Make the measurement with the spectrum analyzer's RBW = 1MHz, VBW = 3MHz, taking the record of maximum spurious emission.
7. A horn antenna was substituted in place of the EUT and was driven by a signal generator. Tune the output power of signal generator to the same emission level with EUT maximum spurious emission.
$$\text{EIRP (dBm)} = \text{S.G. Power} - \text{Tx Cable Loss} + \text{Tx Antenna Gain}$$
$$\text{ERP (dBm)} = \text{EIRP} - 2.15$$
8. The RF fundamental frequency should be excluded against the limit line in the operating frequency band.



5 List of Measuring Equipment

Instrument	Brand Name	Model No.	Serial No.	Characteristics	Calibration Date	Test Date	Due Date	Remark
Loop Antenna	Rohde & Schwarz	HFH2-Z2	100488	9 kHz~30 MHz	Sep. 07, 2021	Jan. 28, 2022~ Feb. 25, 2022	Sep. 06, 2022	Radiation (03CH12-HY)
Bilog Antenna	TESEQ	CBL 6111D & 00800N1D01N -06	37059 & 01	30MHz~1GHz	Oct. 09, 2021	Jan. 28, 2022~ Feb. 25, 2022	Oct. 08, 2022	Radiation (03CH12-HY)
Bilog Antenna	TESEQ	CBL 6111D & N-6-06	35414 & AT-N0602	30MHz~1GHz	Oct. 09, 2021	Jan. 28, 2022~ Feb. 25, 2022	Oct. 08, 2022	Radiation (03CH12-HY)
Horn Antenna	SCHWARZBE CK	BBHA 9120 D	9120D-1326	1GHz~18GHz	Oct. 25, 2021	Jan. 28, 2022~ Feb. 25, 2022	Oct. 24, 2022	Radiation (03CH12-HY)
Horn Antenna	SCHWARZBE CK	BBHA 9120 D	9120D-1212	1GHz~18GHz	May 18, 2021	Jan. 28, 2022~ Feb. 25, 2022	May 17, 2022	Radiation (03CH12-HY)
SHF-EHF Horn Antenna	SCHWARZBE CK	BBHA 9170	BBHA91702 51	18GHz~40GHz	Nov. 30, 2021	Jan. 28, 2022~ Feb. 25, 2022	Nov. 29, 2022	Radiation (03CH12-HY)
SHF-EHF Horn Antenna	SCHWARZBE CK	BBHA 9170	BBHA91705 76	18GHz~40GHz	May 21, 2021	Jan. 28, 2022~ Feb. 25, 2022	May 20, 2022	Radiation (03CH12-HY)
Preamplifier	COM-POWER	PA-103	161075	10MHz~1GHz	Mar. 24, 2021	Jan. 28, 2022~ Feb. 25, 2022	Mar. 23, 2022	Radiation (03CH12-HY)
Preamplifier	Aglient	8449B	3008A02375	1GHz~26.5GHz	May 25, 2021	Jan. 28, 2022~ Feb. 25, 2022	May 24, 2022	Radiation (03CH12-HY)
Preamplifier	E-INSTRUME NT TECH LTD.	ERA-100M-18 G-56-01-A70	EC1900270	1GHz-18GHz	Dec. 27, 2021	Jan. 28, 2022~ Feb. 25, 2022	Dec. 26, 2022	Radiation (03CH12-HY)
Preamplifier	EMEC	EM18G40G	060801	18GHz~40GHz	Jun. 22, 2021	Jan. 28, 2022~ Feb. 25, 2022	Jun. 21, 2022	Radiation (03CH12-HY)
Spectrum Analyzer	Keysight	N9010A	MY54200486	10Hz~44GHz	Oct. 15, 2021	Jan. 28, 2022~ Feb. 25, 2022	Oct. 14, 2022	Radiation (03CH12-HY)
RF Cable	HUBER + SUHNER	SUCOFLEX 126E	0058/126E	30MHz~18GHz	Dec. 10, 2021	Jan. 28, 2022~ Feb. 25, 2022	Dec. 09, 2022	Radiation (03CH12-HY)
RF Cable	HUBER + SUHNER	SUCOFLEX 102	505134/2	30MHz~40GHz	Feb. 22, 2021	Jan. 28, 2022~ Feb. 20, 2022	Feb. 21, 2022	Radiation (03CH12-HY)
RF Cable	HUBER + SUHNER	SUCOFLEX 102	505134/2	30MHz~40GHz	Feb. 21, 2022	Feb. 21, 2022~ Feb. 25, 2022	Feb. 20, 2023	Radiation (03CH12-HY)
RF Cable	HUBER + SUHNER	SUCOFLEX 102	800740/2	30MHz~40GHz	Feb. 22, 2021	Jan. 28, 2022~ Feb. 20, 2022	Feb. 21, 2022	Radiation (03CH12-HY)
RF Cable	HUBER + SUHNER	SUCOFLEX 102	800740/2	30MHz~40GHz	Feb. 21, 2022	Feb. 21, 2022~ Feb. 25, 2022	Feb. 20, 2023	Radiation (03CH12-HY)
Filter	Wainwright	WLKS1200-12 SS	SN2	1.2GHz Low Pass Filter	Mar. 17, 2021	Jan. 28, 2022~ Feb. 25, 2022	Mar. 16, 2022	Radiation (03CH12-HY)
Filter	Wainwright	WHKX12-1080 -1200-15000-6 0SS	SN1	1.2GHz High Pass Filter	Mar. 17, 2021	Jan. 28, 2022~ Feb. 25, 2022	Mar. 16, 2022	Radiation (03CH12-HY)
Filter	Wainwright	WHKX12-2700 -3000-18000-6 0ST	SN2	3GHz High Pass Filter	Jul. 12, 2021	Jan. 28, 2022~ Feb. 25, 2022	Jul. 11, 2022	Radiation (03CH12-HY)
Filter	Wainwright	WHKX8-5872. 5-6750-18000- 40ST	SN2	6.75GHz High Pass Filter	Mar. 17, 2021	Jan. 28, 2022~ Feb. 25, 2022	Mar. 16, 2022	Radiation (03CH12-HY)
Hygrometer	TECPEL	DTM-303B	TP140349	N/A	Sep. 30, 2021	Jan. 28, 2022~ Feb. 25, 2022	Sep. 29, 2022	Radiation (03CH12-HY)
Controller	EMEC	EM1000	N/A	Control Turn table & Ant Mast	N/A	Jan. 28, 2022~ Feb. 25, 2022	N/A	Radiation (03CH12-HY)
Antenna Mast	EMEC	AM-BS-4500-B	N/A	1m~4m	N/A	Jan. 28, 2022~ Feb. 25, 2022	N/A	Radiation (03CH12-HY)
Turn Table	EMEC	TT2000	N/A	0~360 Degree	N/A	Jan. 28, 2022~ Feb. 25, 2022	N/A	Radiation (03CH12-HY)
Software	Audix	E3 6.2009-8-24	RK-000989	N/A	N/A	Jan. 28, 2022~ Feb. 25, 2022	N/A	Radiation (03CH12-HY)



Instrument	Brand Name	Model No.	Serial No.	Characteristics	Calibration Date	Test Date	Due Date	Remark
Radio Communication Analyzer	Anritsu	MT8821C	6201664755	2/3/4G/LTE FDD/TDD with44/LTE-3CC DLCA/2CC ULCA, CatM1/NB1/NB2	Jul. 21, 2021	Jan. 14, 2022 ~ Feb. 17, 2022	Jul. 20, 2022	Conducted (TH03-HY)
Spectrum Analyzer	Rohde & Schwarz	FSV40	101908	10Hz~40GHz	Oct. 01, 2021	Jan. 14, 2022 ~ Feb. 17, 2022	Sep. 30, 2022	Conducted (TH03-HY)
Thermal Chamber	ESPEC	SH-641	92013720	-40°C ~90°C	Sep. 09, 2021	Jan. 14, 2022 ~ Feb. 17, 2022	Sep. 08, 2022	Conducted (TH03-HY)
DC Power Supply	GW Instek	GPP-2323	GES906037	0V~64V ; 0A~6A	Jan. 06, 2022	Jan. 14, 2022 ~ Feb. 17, 2022	Jan. 05, 2023	Conducted (TH03-HY)
Coupler	Warison	20dB 25W SMA Directional Coupler	#B	1-18GHz	Jan. 07, 2022	Jan. 14, 2022 ~ Feb. 17, 2022	Jan. 06, 2023	Conducted (TH03-HY)



6 Uncertainty of Evaluation

Uncertainty of Radiated Emission Measurement (30 MHz ~ 1000 MHz)

Measuring Uncertainty for a Level of Confidence of 95% ($U = 2Uc(y)$)	3.10 dB
---	---------

Uncertainty of Radiated Emission Measurement (1 GHz ~ 18 GHz)

Measuring Uncertainty for a Level of Confidence of 95% ($U = 2Uc(y)$)	3.39 dB
---	---------

Uncertainty of Radiated Emission Measurement (18 GHz ~ 40 GHz)

Measuring Uncertainty for a Level of Confidence of 95% ($U = 2Uc(y)$)	4.34 dB
---	---------



Appendix A. Test Results of Conducted Test

Conducted Output Power (Average power & EIRP)

LTE Band 48 Maximum Average Power [dBm] (GT - LC = -2 dB)								
BW [MHz]	RB Size	RB Offset	Mod	Lowest	Middle	Highest	EIRP (dBm)	EIRP (W)
20	1	0	QPSK	24.19	24.01	24.49	22.49	0.1774
20	1	49		24.27	24.47	24.00		
20	1	99		24.45	24.45	24.18		
20	50	0		23.30	23.50	23.18		
20	50	24		23.34	23.54	23.15		
20	50	50		23.40	23.60	23.13		
20	100	0		23.37	23.57	23.10		
20	1	0	16-QAM	23.53	23.73	23.48	21.96	0.1570
20	1	49		23.57	23.77	23.51		
20	1	99		23.76	23.96	23.49		
20	50	0		22.31	22.51	22.10		
20	50	24		22.34	22.56	22.12		
20	50	50		22.36	22.56	22.14		
20	100	0		22.31	22.51	22.04		
20	1	0	64-QAM	22.29	22.49	22.17	20.65	0.1161
20	1	49		22.32	22.52	22.20		
20	1	99		22.45	22.65	22.18		
20	50	0		21.26	21.46	21.12		
20	50	24		21.33	21.53	21.21		
20	50	50		21.41	21.61	21.30		
20	100	0		21.31	21.51	21.04		
20	1	0	256-QAM	19.19	19.39	19.11	17.58	0.0573
20	1	49		19.17	19.37	19.10		
20	1	99		19.38	19.58	19.11		
20	50	0		19.27	19.47	19.17		
20	50	24		19.21	19.41	19.07		
20	50	50		19.36	19.56	19.09		
20	100	0		19.24	19.44	18.97		
Limit	EIRP < 23dBm/10MHz			Result			Pass	



LTE Band 48 Maximum Average Power [dBm] (GT - LC = -2 dB)								
BW [MHz]	RB Size	RB Offset	Mod	Lowest	Middle	Highest	EIRP (dBm)	EIRP (W)
15	1	0	QPSK	24.00	23.95	24.35	22.37	0.1726
15	1	37		24.24	24.37	23.94		
15	1	74		24.36	24.36	24.06		
15	36	0		23.22	23.39	23.07		
15	36	20		23.23	23.42	23.08		
15	36	39		23.33	23.57	23.12		
15	75	0		23.33	23.46	23.09		
15	1	0	16-QAM	23.40	23.62	23.39	21.87	0.1538
15	1	37		23.41	23.68	23.42		
15	1	74		23.69	23.87	23.39		
15	36	0		22.11	22.36	22.11		
15	36	20		22.34	22.39	22.14		
15	36	39		22.27	22.48	22.10		
15	75	0		22.23	22.37	21.92		
15	1	0	64-QAM	22.28	22.31	22.12	20.61	0.1151
15	1	37		22.24	22.38	22.12		
15	1	74		22.42	22.61	22.14		
15	36	0		21.16	21.42	21.15		
15	36	20		21.26	21.50	21.09		
15	36	39		21.32	21.47	21.20		
15	75	0		21.20	21.36	20.94		
15	1	0	256-QAM	19.04	19.39	19.03	17.40	0.0550
15	1	37		19.09	19.28	18.95		
15	1	74		19.28	19.39	18.94		
15	36	0		19.18	19.27	19.16		
15	36	20		19.04	19.40	18.96		
15	36	39		19.30	19.38	19.04		
15	75	0		19.05	19.34	18.91		
Limit	EIRP < 23dBm/10MHz			Result			Pass	



LTE Band 48 Maximum Average Power [dBm] (GT - LC = -2 dB)								
BW [MHz]	RB Size	RB Offset	Mod	Lowest	Middle	Highest	EIRP (dBm)	EIRP (W)
10	1	0	QPSK	24.13	24.00	24.33	22.40	0.1738
10	1	25		24.18	24.40	24.00		
10	1	49		24.35	24.40	24.17		
10	25	0		23.17	23.49	23.04		
10	25	12		23.22	23.43	23.06		
10	25	25		23.28	23.49	23.12		
10	50	0		23.28	23.41	23.08		
10	1	0	16-QAM	23.40	23.73	23.46	21.80	0.1514
10	1	25		23.57	23.57	23.44		
10	1	49		23.72	23.80	23.36		
10	25	0		22.24	22.34	22.02		
10	25	12		22.22	22.48	21.99		
10	25	25		22.21	22.37	22.08		
10	50	0		22.21	22.46	21.97		
10	1	0	64-QAM	22.26	22.38	22.11	20.52	0.1127
10	1	25		22.16	22.52	22.12		
10	1	49		22.33	22.49	22.12		
10	25	0		21.14	21.42	20.94		
10	25	12		21.30	21.43	21.02		
10	25	25		21.23	21.42	21.11		
10	50	0		21.13	21.36	20.92		
10	1	0	256-QAM	19.15	19.29	18.91	17.41	0.0551
10	1	25		19.10	19.29	18.97		
10	1	49		19.32	19.41	19.09		
10	25	0		19.20	19.29	19.03		
10	25	12		19.01	19.24	19.02		
10	25	25		19.16	19.41	19.04		
10	50	0		19.04	19.30	18.80		
Limit	EIRP < 23dBm/10MHz			Result			Pass	



LTE Band 48 Maximum Average Power [dBm] (GT - LC = -2 dB)								
BW [MHz]	RB Size	RB Offset	Mod	Lowest	Middle	Highest	EIRP (dBm)	EIRP (W)
5	1	0	QPSK	24.04	23.98	24.35	22.37	0.1726
5	1	12		24.20	24.37	23.87		
5	1	24		24.30	24.27	23.99		
5	12	0		23.12	23.40	23.10		
5	12	7		23.32	23.45	23.05		
5	12	13		23.33	23.51	23.02		
5	25	0		23.32	23.44	23.09		
5	1	0	16-QAM	23.33	23.63	23.33	21.80	0.1514
5	1	12		23.39	23.63	23.41		
5	1	24		23.72	23.80	23.39		
5	12	0		22.11	22.34	22.07		
5	12	7		22.20	22.46	22.11		
5	12	13		22.32	22.46	21.98		
5	25	0		22.24	22.39	21.89		
5	1	0	64-QAM	22.12	22.38	22.09	20.49	0.1119
5	1	12		22.26	22.43	22.02		
5	1	24		22.28	22.49	22.01		
5	12	0		21.18	21.41	20.99		
5	12	7		21.27	21.44	21.15		
5	12	13		21.36	21.49	21.24		
5	25	0		21.27	21.32	20.99		
5	1	0	256-QAM	19.13	19.35	19.09	17.55	0.0569
5	1	12		19.15	19.35	19.10		
5	1	24		19.26	19.55	19.06		
5	12	0		19.10	19.37	19.14		
5	12	7		19.17	19.34	19.04		
5	12	13		19.36	19.51	19.01		
5	25	0		19.10	19.40	18.94		
Limit	EIRP < 23dBm/10MHz			Result			Pass	



LTE Band 48C_CA Maximum Average Power [dBm] (GT - LC = -2 dB)										
BW [MHz]	PCC		SCC		Mod	Lowest	Middle	Highest	EIRP (dBm)	EIRP (W)
	RB Size	RB Offset	RB Size	RB Offset						
20+20	100	0	100	0	QPSK	21.78	21.82	21.83	21.45	0.1396
20+20	1	0	1	99		15.13	15.08	15.21		
20+20	1	99	1	0		23.45	23.22	23.26		
20+20	100	0	100	0	16-QAM	20.85	20.86	20.88	21.07	0.1279
20+20	1	0	1	99		15.68	15.61	15.63		
20+20	1	99	1	0		23.07	22.91	22.79		
20+20	100	0	100	0	64-QAM	20.87	20.79	21.03	19.03	0.0800
20+20	1	0	1	99		15.38	15.34	15.51		
20+20	1	99	1	0		20.86	20.59	20.53		
20+20	100	0	100	0	256-QAM	19.00	18.77	18.46	17.00	0.0501
20+20	1	0	1	99		15.39	15.28	15.30		
20+20	1	99	1	0		18.63	18.36	18.49		
20+15	100	0	75	0	QPSK	21.78	21.57	21.86	21.41	0.1384
20+15	1	0	1	74		15.11	14.83	15.18		
20+15	1	74	1	0		23.41	23.18	23.35		
20+15	100	0	75	0	16-QAM	20.90	20.71	20.83	21.01	0.1262
20+15	1	0	1	74		15.54	15.45	15.52		
20+15	1	74	1	0		22.99	22.76	23.01		
20+15	100	0	75	0	64-QAM	20.74	20.49	20.94	18.94	0.0783
20+15	1	0	1	74		15.11	14.95	15.43		
20+15	1	74	1	0		20.50	20.37	20.56		
20+15	100	0	75	0	256-QAM	18.66	18.70	18.94	16.94	0.0494
20+15	1	0	1	74		15.24	15.23	15.31		
20+15	1	74	1	0		18.49	18.31	18.63		
15+20	75	0	100	0	QPSK	21.77	21.59	21.72	21.49	0.1409
15+20	1	0	1	99		15.05	15.04	15.15		
15+20	1	74	1	0		22.18	23.49	23.34		
15+20	75	0	100	0	16-QAM	20.76	20.26	20.81	20.89	0.1227
15+20	1	0	1	99		15.52	15.49	15.55		
15+20	1	74	1	0		22.67	22.89	22.78		
15+20	75	0	100	0	64-QAM	20.83	20.38	20.77	18.83	0.0764
15+20	1	0	1	99		15.49	14.97	15.44		
15+20	1	74	1	0		20.56	20.29	20.70		
15+20	75	0	100	0	256-QAM	18.79	18.42	18.82	16.82	0.0481
15+20	1	0	1	99		15.28	15.03	15.29		
15+20	1	74	1	0		18.72	18.32	18.49		
Limit	EIRP < 23dBm/10MHz					Result			Pass	

Total EIRP power is less than partial EIRP limit 23 dBm/10MHz.



LTE Band 48C_CA Maximum Average Power [dBm] (GT - LC = -2 dB)										
BW [MHz]	PCC		SCC		Mod	Lowest	Middle	Highest	EIRP (dBm)	EIRP (W)
	RB Size	RB Offset	RB Size	RB Offset						
20+10	100	0	50	0	QPSK	21.85	21.58	21.85	21.37	0.1371
20+10	1	0	1	49		15.16	14.87	15.01		
20+10	1	99	1	0		23.37	23.22	23.29		
20+10	100	0	50	0	16-QAM	20.97	20.65	20.79	21.08	0.1282
20+10	1	0	1	49		15.51	15.32	15.57		
20+10	1	99	1	0		23.01	22.74	23.08		
20+10	100	0	50	0	64-QAM	20.70	20.59	20.80	18.80	0.0759
20+10	1	0	1	49		15.15	15.13	15.15		
20+10	1	99	1	0		20.63	20.32	20.62		
20+10	100	0	50	0	256-QAM	18.78	18.60	18.82	16.82	0.0481
20+10	1	0	1	49		15.12	15.05	15.34		
20+10	1	99	1	0		18.26	18.24	18.52		
10+20	50	0	100	0	QPSK	21.61	21.52	21.81	21.38	0.1374
10+20	1	0	1	99		15.07	14.76	14.95		
10+20	1	49	1	0		23.38	23.01	23.38		
10+20	50	0	100	0	16-QAM	20.84	20.65	20.82	20.91	0.1233
10+20	1	0	1	99		15.28	15.31	15.40		
10+20	1	49	1	0		22.91	22.70	22.82		
10+20	50	0	100	0	64-QAM	20.93	20.68	20.89	18.93	0.0782
10+20	1	0	1	99		15.21	15.10	15.25		
10+20	1	49	1	0		20.53	20.37	20.50		
10+20	50	0	100	0	256-QAM	18.90	18.44	18.83	16.90	0.0490
10+20	1	0	1	99		15.22	15.12	15.01		
10+20	1	49	1	0		18.42	18.40	18.56		
20+5	100	0	25	0	QPSK	21.81	21.57	21.80	21.35	0.1365
20+5	1	0	1	24		14.91	14.68	14.81		
20+5	1	99	1	0		23.35	23.15	23.28		
20+5	100	0	25	0	16-QAM	20.79	20.66	20.88	20.92	0.1236
20+5	1	0	1	24		15.20	15.16	15.45		
20+5	1	99	1	0		22.80	22.70	22.92		
20+5	100	0	25	0	64-QAM	20.82	20.63	20.82	18.82	0.0762
20+5	1	0	1	24		15.11	14.84	15.14		
20+5	1	99	1	0		20.62	20.36	20.64		
20+5	100	0	25	0	256-QAM	18.76	18.55	18.56	16.76	0.0474
20+5	1	0	1	24		15.09	14.82	14.52		
20+5	1	99	1	0		18.52	18.33	17.92		
Limit	EIRP < 23dBm/10MHz					Result			Pass	

Total EIRP power is less than partial EIRP limit 23 dBm/10MHz.



LTE Band 48C_CA Maximum Average Power [dBm] (GT - LC = -2 dB)										
BW [MHz]	PCC		SCC		Mod	Lowest	Middle	Highest	EIRP (dBm)	EIRP (W)
	RB Size	RB Offset	RB Size	RB Offset						
5+20	25	0	100	0	QPSK	21.46	21.50	21.47	21.24	0.1330
5+20	1	0	1	99		14.57	14.56	14.61		
5+20	1	24	1	0		23.24	23.17	22.93		
5+20	25	0	100	0	16-QAM	20.68	20.55	20.49	20.81	0.1205
5+20	1	0	1	99		15.02	14.89	15.30		
5+20	1	24	1	0		22.81	22.76	22.79		
5+20	25	0	100	0	64-QAM	20.57	20.47	20.77	18.77	0.0753
5+20	1	0	1	99		14.88	14.80	15.05		
5+20	1	24	1	0		20.55	20.37	20.50		
5+20	25	0	100	0	256-QAM	18.61	18.64	18.81	16.81	0.0480
5+20	1	0	1	99		14.77	14.76	14.85		
5+20	1	24	1	0		18.43	18.39	18.50		
Limit	EIRP < 23dBm/10MHz					Result			Pass	

Total EIRP power is less than partial EIRP limit 23 dBm/10MHz.



LTE Band 48

Peak-to-Average Ratio

Mode	LTE Band 48 / 20MHz				
Mod.	QPSK	16QAM	64QAM	256QAM	Limit: 13dB
RB Size	Full RB	Full RB	Full RB	Full RB	Result
Middle CH	5.62	6.49	6.70	6.75	PASS

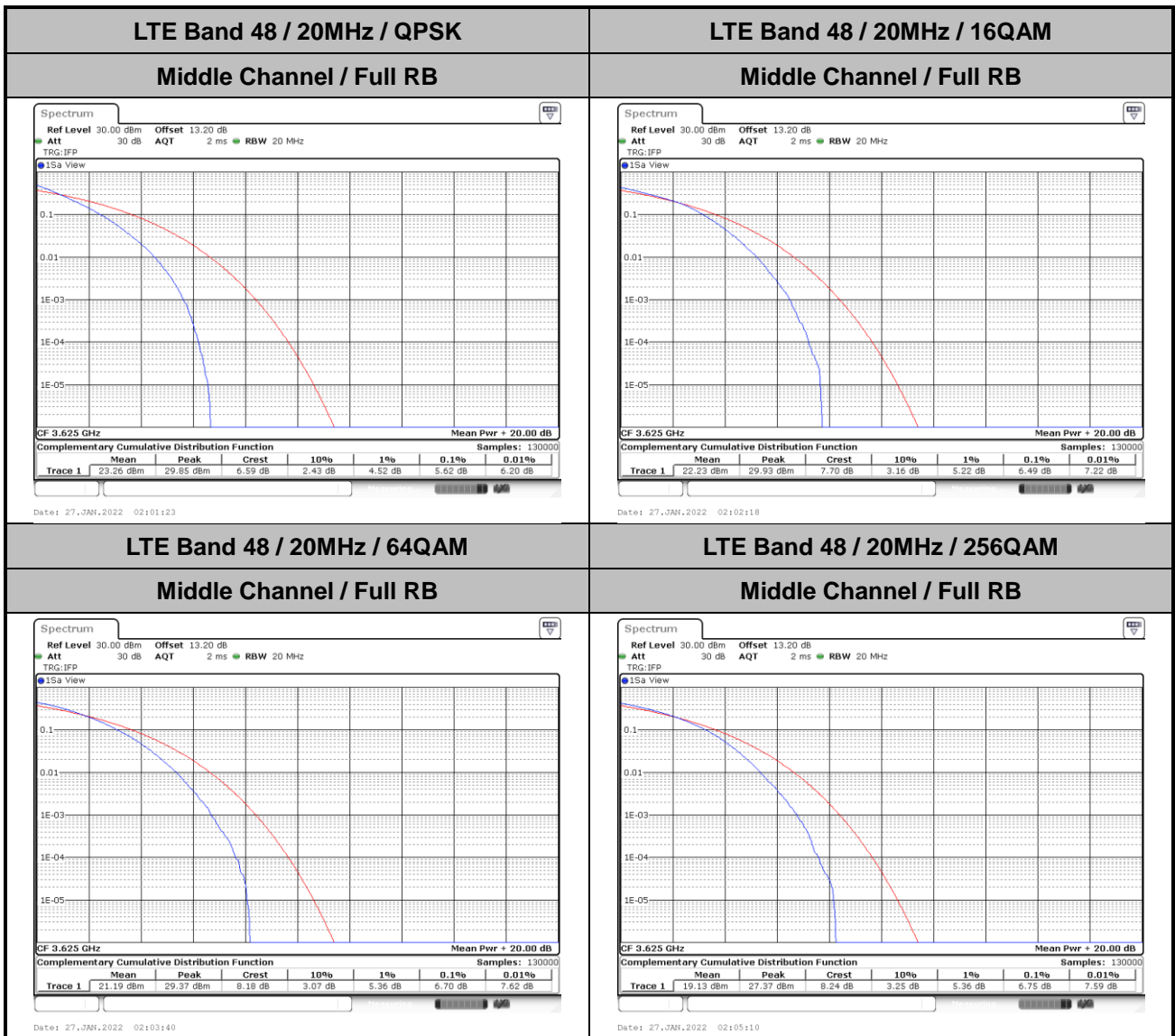



26dB Bandwidth

Mode	LTE Band 48 : 26dB BW(MHz)											
BW	1.4MHz		3MHz		5MHz		10MHz		15MHz		20MHz	
Mod.	QPSK	16QAM	QPSK	16QAM	QPSK	16QAM	QPSK	16QAM	QPSK	16QAM	QPSK	16QAM
Middle CH	-	-	-	-	4.85	4.80	9.65	9.81	14.24	14.21	18.74	18.82
Mode	LTE Band 48 : 26dB BW(MHz)											
BW	1.4MHz		3MHz		5MHz		10MHz		15MHz		20MHz	
Mod.	64QAM	256 QAM	64QAM	256 QAM	64QAM	256 QAM	64QAM	256 QAM	64QAM	256 QAM	64QAM	256 QAM
Middle CH	-	-	-	-	4.74	4.84	9.81	9.73	14.18	14.18	18.66	18.78



LTE Band 48

Middle Channel / 5MHz / QPSK

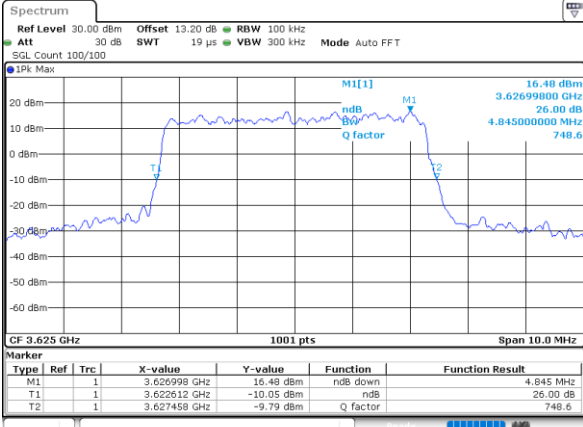

Date: 27_JAN_2022 01:50:39

Middle Channel / 5MHz / 16QAM

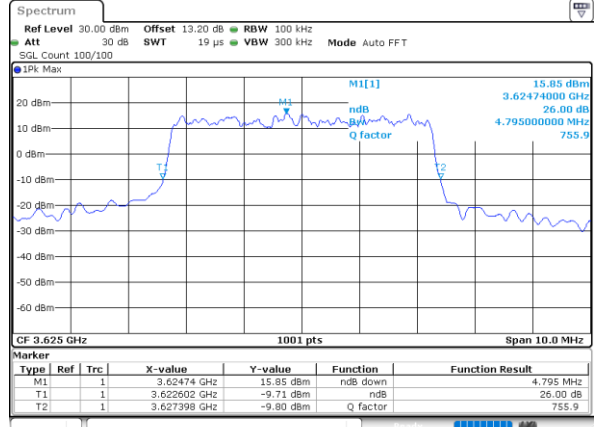

Date: 27_JAN_2022 01:51:00

Middle Channel / 10MHz / QPSK

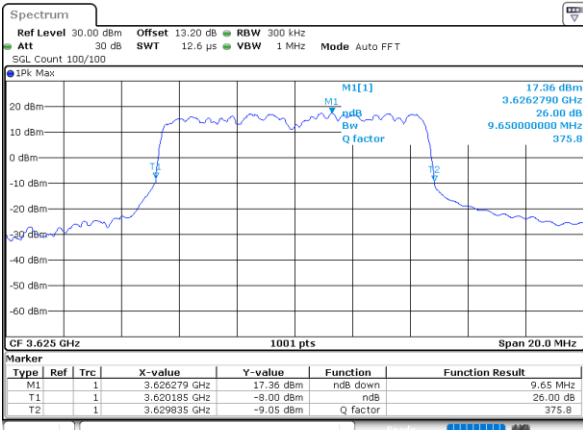

Date: 27_JAN_2022 01:52:02

Middle Channel / 10MHz / 16QAM

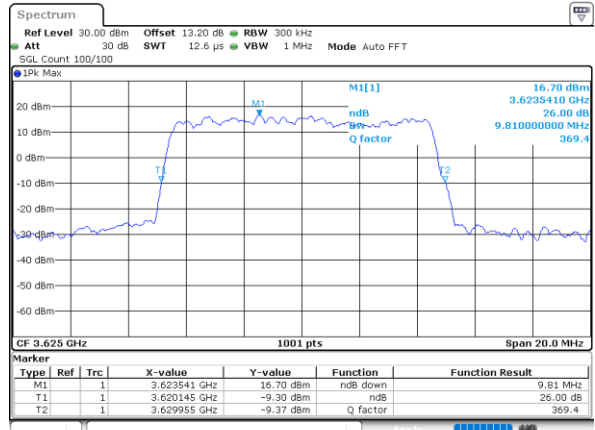

Date: 27_JAN_2022 01:52:22

Middle Channel / 15MHz / QPSK

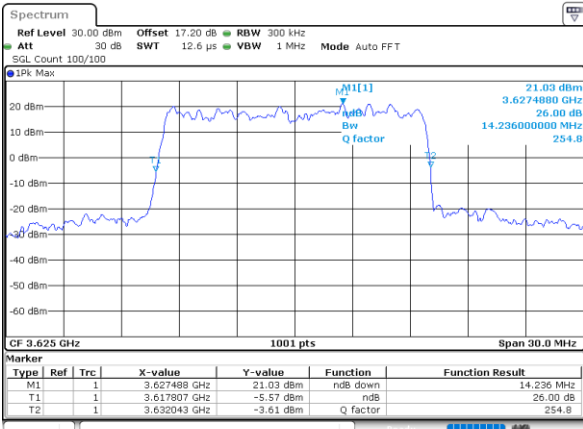

Date: 27_JAN_2022 03:56:02

Middle Channel / 15MHz / 16QAM

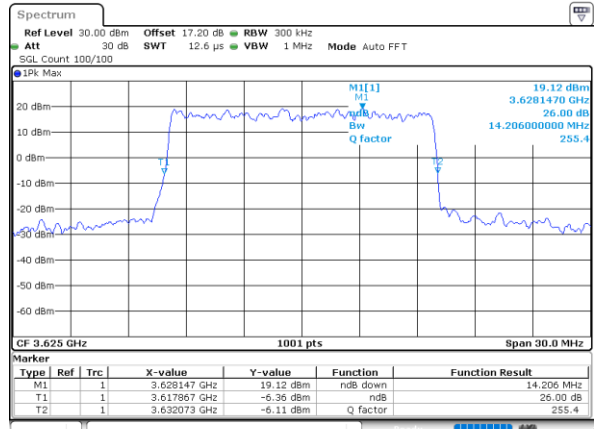

Date: 27_JAN_2022 03:55:38



LTE Band 48

Middle Channel / 20MHz / QPSK

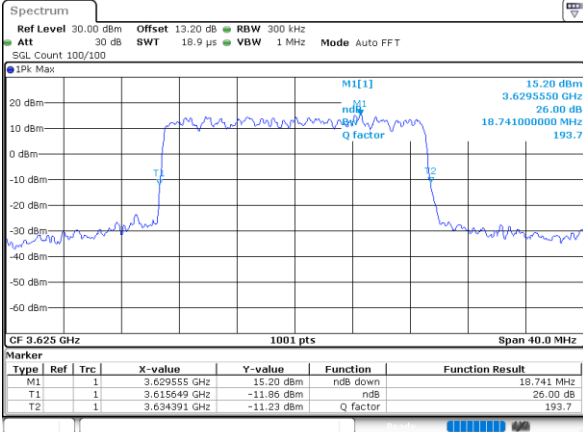

Date: 27_JAN_2022 01:54:47

Middle Channel / 20MHz / 16QAM

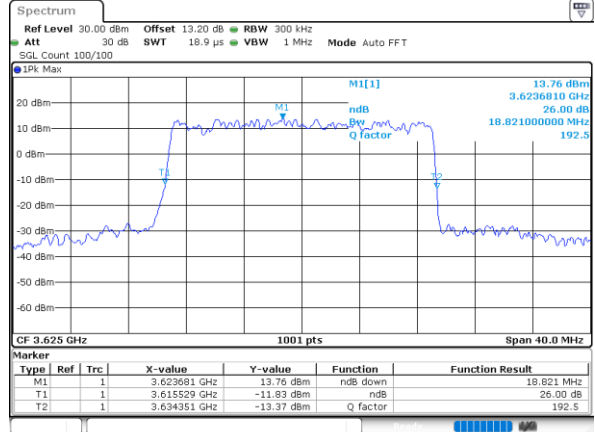

Date: 27_JAN_2022 01:55:07

Middle Channel / 5MHz / 64QAM

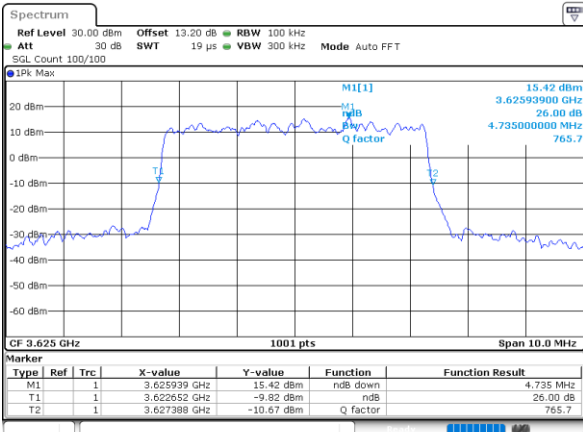

Date: 27_JAN_2022 01:55:49

Middle Channel / 10MHz / 64QAM

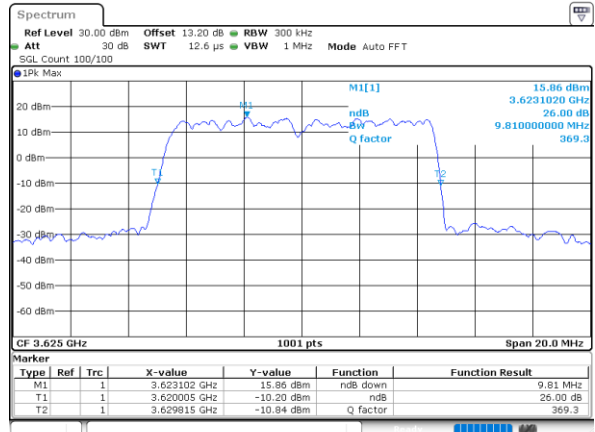

Date: 27_JAN_2022 01:56:30

Middle Channel / 15MHz / 64QAM

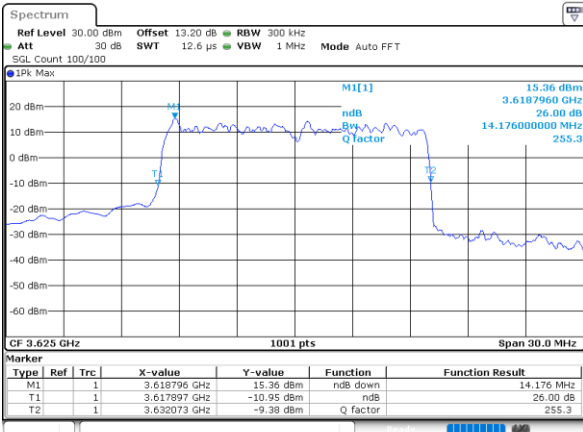

Date: 27_JAN_2022 01:57:11

Middle Channel / 20MHz / 64QAM

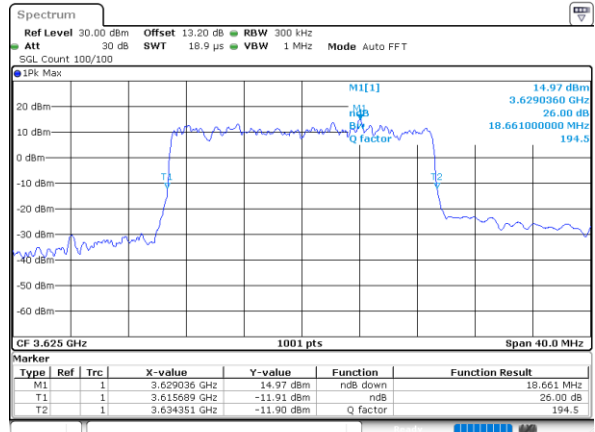

Date: 27_JAN_2022 01:57:53



LTE Band 48

Middle Channel / 5MHz / 256QAM

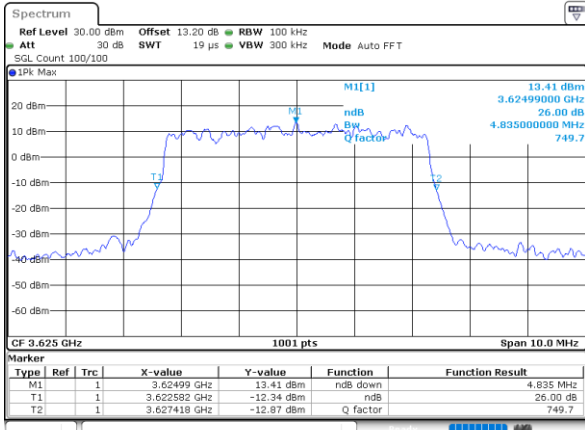

Date: 27_JAN_2022 02:23:04

Middle Channel / 10MHz / 256QAM

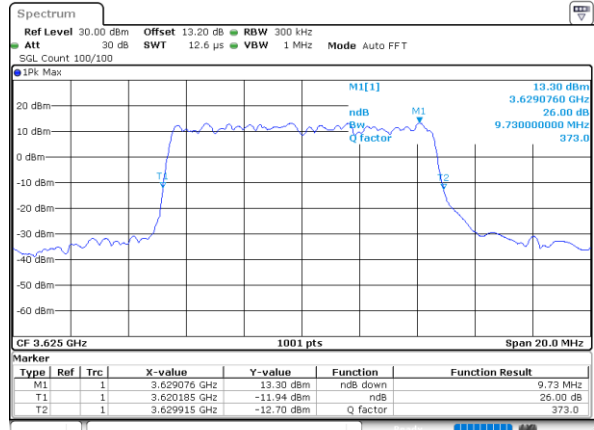

Date: 27_JAN_2022 02:23:46

Middle Channel / 15MHz / 256QAM

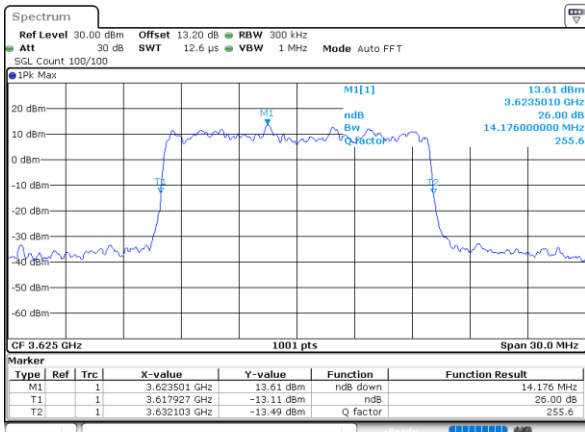

Date: 27_JAN_2022 02:24:27

Middle Channel / 20MHz / 256QAM

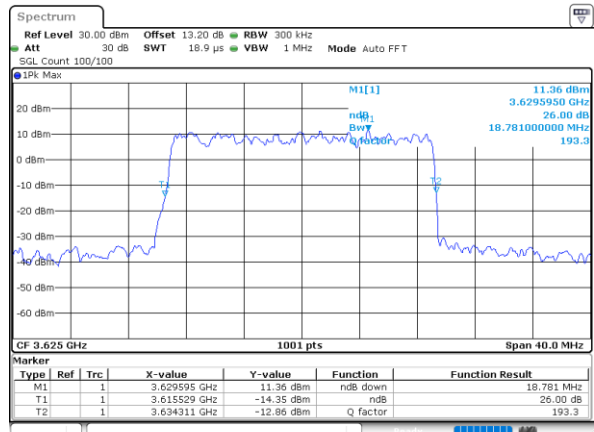

Date: 27_JAN_2022 02:25:08



Occupied Bandwidth

Mode	LTE Band 48 : 99%OBW(MHz)											
BW	1.4MHz		3MHz		5MHz		10MHz		15MHz		20MHz	
Mod.	QPSK	16QAM	QPSK	16QAM	QPSK	16QAM	QPSK	16QAM	QPSK	16QAM	QPSK	16QAM
Middle CH	-	-	-	-	4.47	4.48	9.03	8.99	13.49	13.37	17.82	17.86
Mode	LTE Band 48 : 99%OBW(MHz)											
BW	1.4MHz		3MHz		5MHz		10MHz		15MHz		20MHz	
Mod.	64QAM	256 QAM	64QAM	256 QAM	64QAM	256 QAM	64QAM	256 QAM	64QAM	256 QAM	64QAM	256 QAM
Middle CH	-	-	-	-	4.47	4.46	8.95	8.97	13.43	13.40	17.94	17.78



LTE Band 48

Middle Channel / 5MHz / QPSK

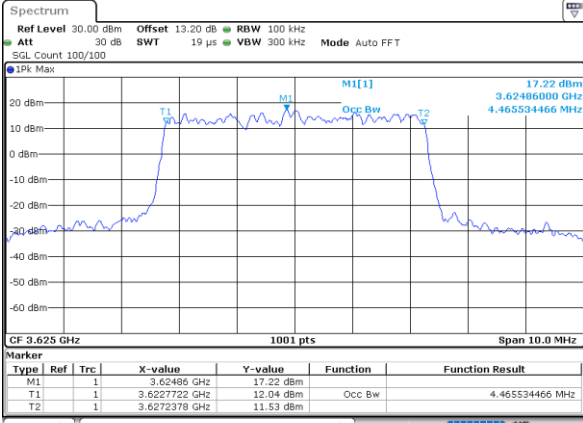

Date: 27_JAN.2022 01:49:50

Middle Channel / 5MHz / 16QAM

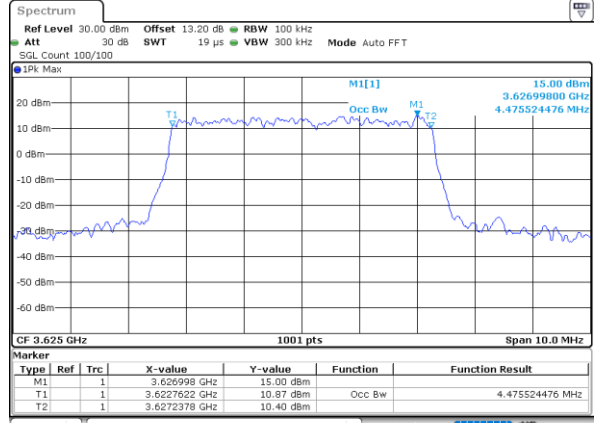

Date: 27_JAN.2022 01:50:19

Middle Channel / 10MHz / QPSK

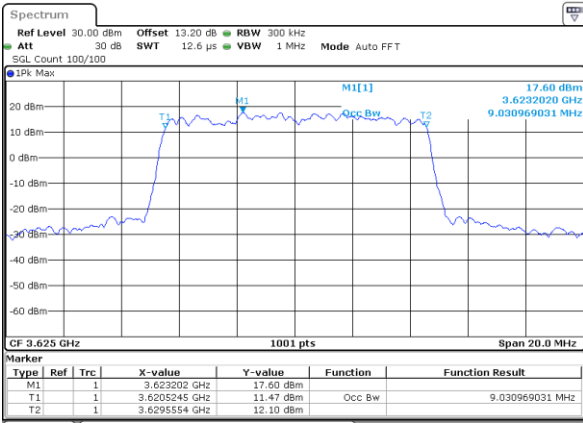

Date: 27_JAN.2022 01:51:21

Middle Channel / 10MHz / 16QAM

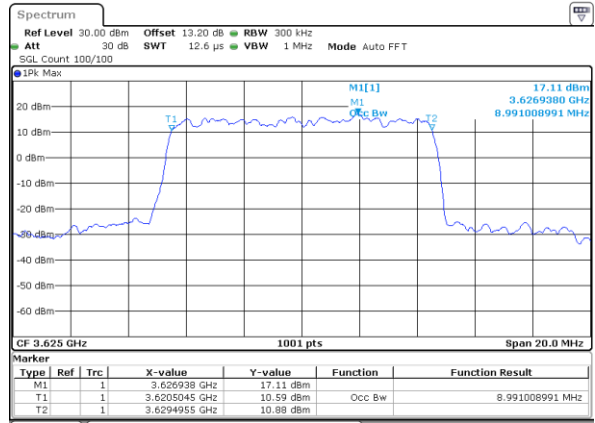

Date: 27_JAN.2022 01:51:41

Middle Channel / 15MHz / QPSK

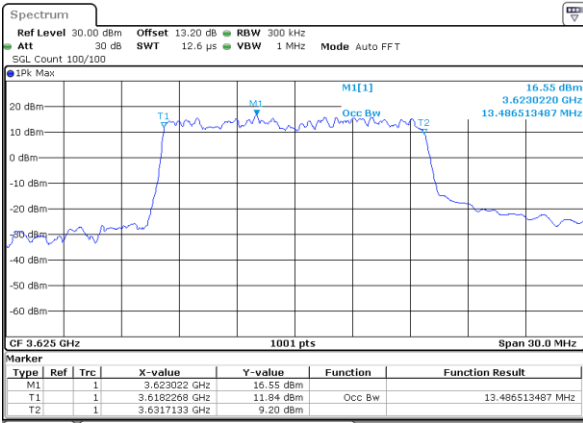

Date: 27_JAN.2022 01:52:43

Middle Channel / 15MHz / 16QAM

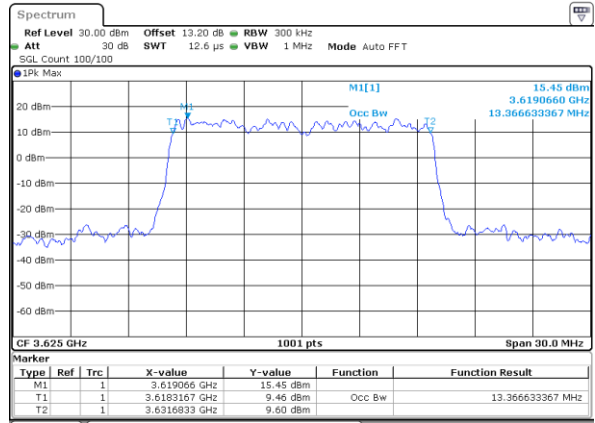

Date: 27_JAN.2022 01:53:04



LTE Band 48

Middle Channel / 20MHz / QPSK

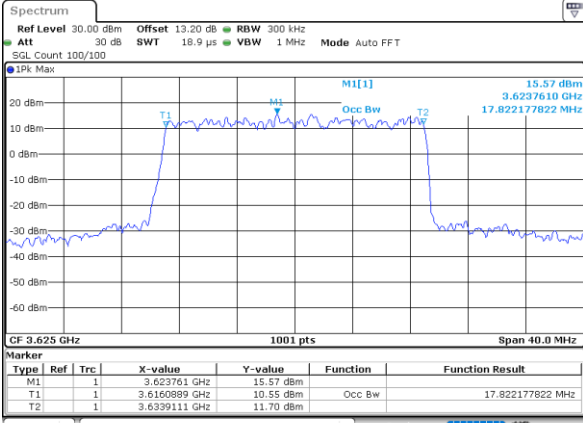

Date: 27_JAN,2022 01:54:06

Middle Channel / 20MHz / 16QAM

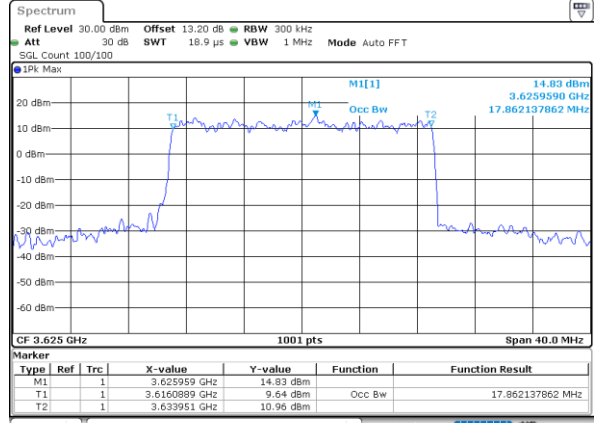

Date: 27_JAN,2022 01:54:26

Middle Channel / 5MHz / 64QAM

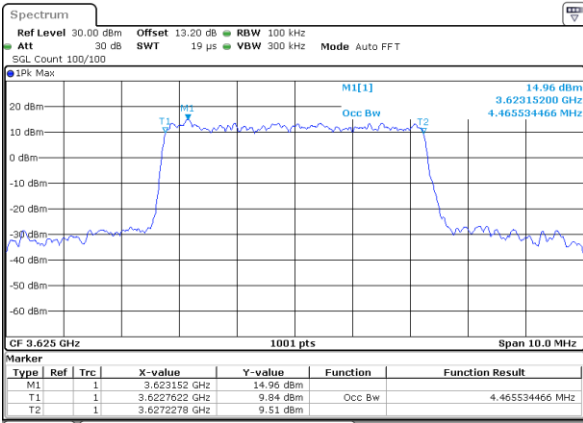

Date: 27_JAN,2022 01:55:28

Middle Channel / 10MHz / 64QAM

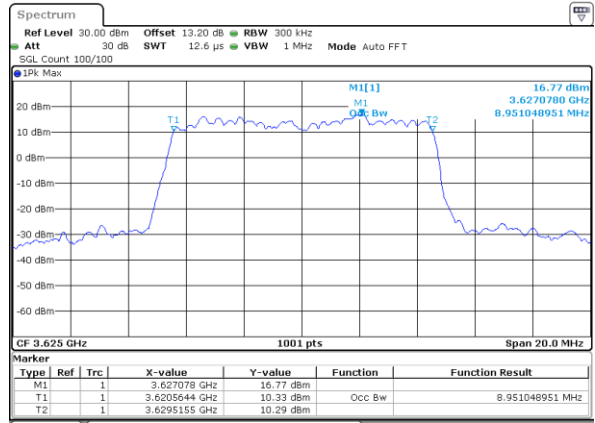

Date: 27_JAN,2022 01:56:10

Middle Channel / 15MHz / 64QAM

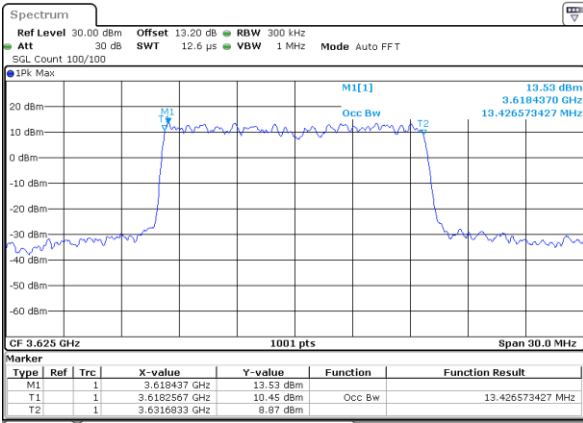

Date: 27_JAN,2022 01:56:51

Middle Channel / 20MHz / 64QAM

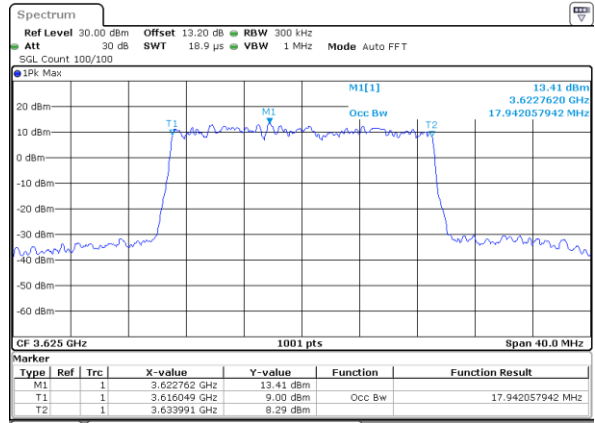

Date: 27_JAN,2022 01:57:32



LTE Band 48

Middle Channel / 5MHz / 256QAM

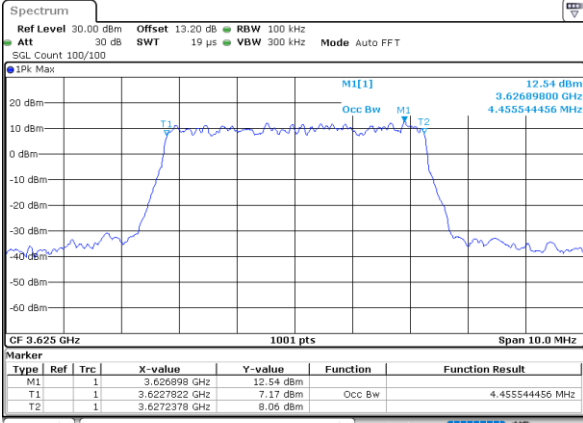

Date: 27_JAN_2022 02:22:44

Middle Channel / 10MHz / 256QAM

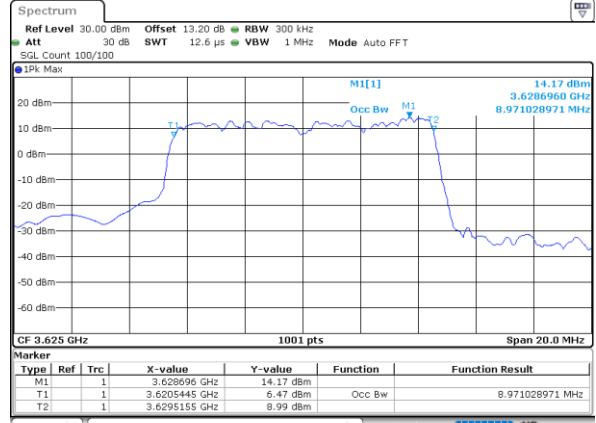

Date: 27_JAN_2022 02:23:25

Middle Channel / 15MHz / 256QAM

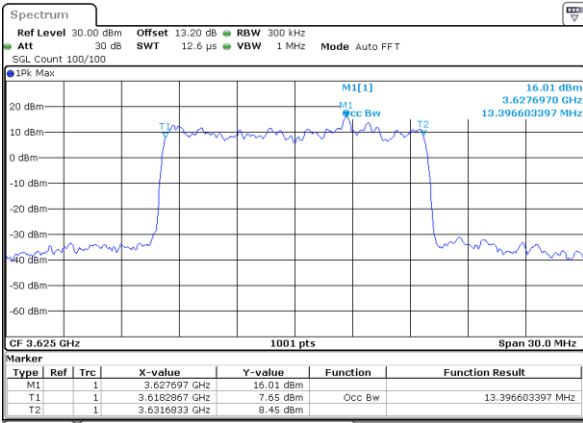

Date: 27_JAN_2022 02:24:07

Middle Channel / 20MHz / 256QAM

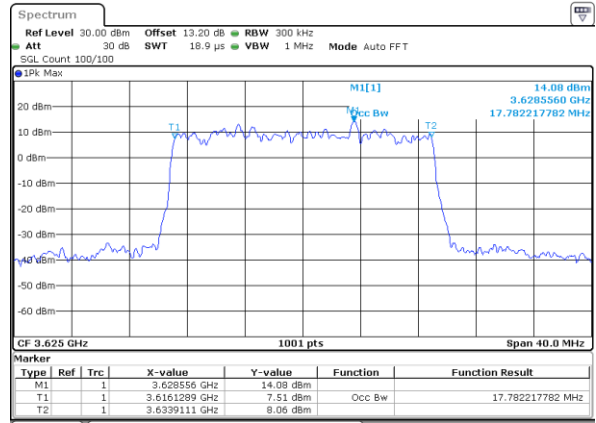

Date: 27_JAN_2022 02:24:48



ACLR

