



FCC RADIO TEST REPORT

FCC ID : GKRRMLN1
Equipment : 5G LGA Module
Brand Name : COMPAL
Model Name : RML-N1
Marketing Name : 5G LGA Module
Applicant : Compal Electronics, Inc.
No. 581 & 581-1, Ruiguang Rd., Neihu District,
Taipei, (114) Taiwan
Manufacturer : Compal Electronics, Inc.
No. 581 & 581-1, Ruiguang Rd., Neihu District,
Taipei, (114) Taiwan
Standard : FCC 47 CFR Part 2, 22(H), 24(E), 27

The product was received on Nov. 01, 2021 and testing was performed from Nov. 15, 2021 to Nov. 18, 2021 . We, Sporton International Inc. EMC & Wireless Communications Laboratory, would like to declare that the tested sample has been evaluated in accordance with the test procedures given in ANSI / TIA-603-E and has been in compliance with the applicable technical standards.

The test results in this variant report apply exclusively to the tested model / sample. Without written approval of Sporton International Inc. EMC & Wireless Communications Laboratory, the test report shall not be reproduced except in full.

Louis Wu

Approved by: Louis Wu

Sporton International Inc. EMC & Wireless Communications Laboratory

No. 52, Huaya 1st Rd., Guishan Dist., Taoyuan City 333, Taiwan (R.O.C.)



Table of Contents

History of this test report.....	3
Summary of Test Result.....	4
1 General Description	6
1.1 Product Feature of Equipment Under Test.....	6
1.2 Modification of EUT	6
1.3 Testing Location	7
1.4 Applicable Standards.....	7
2 Test Configuration of Equipment Under Test	8
2.1 Test Mode.....	8
2.2 Connection Diagram of Test System.....	9
2.3 Support Unit used in test configuration and system	9
2.4 Measurement Results Explanation Example.....	9
2.5 Frequency List of Low/Middle/High Channels	10
3 Conducted Test Items.....	11
3.1 Measuring Instruments	11
3.2 Conducted Output Power and ERP/EIRP	12
3.3 Peak-to-Average Ratio	13
3.4 Occupied Bandwidth.....	14
3.5 Conducted Band Edge	15
3.6 Conducted Spurious Emission	16
3.7 Frequency Stability	17
4 Radiated Test Items	18
4.1 Measuring Instruments	18
4.2 Radiated Spurious Emission Measurement	20
5 List of Measuring Equipment.....	21
6 Uncertainty of Evaluation.....	22
Appendix A. Test Results of Conducted Test	
Appendix B. Test Results of Radiated Test	
Appendix C. Test Setup Photographs	



History of this test report

Report No.	Version	Description	Issued Date
FG133040-04A	01	Initial issue of report	Nov. 30, 2021
FG133040-04A	02	1. Revise note in summary 2. Revise remark in section 2.1 3. Add all functions supported by the device. 4. Revise applicable standards in section 1.4	Dec. 14, 2021



Summary of Test Result

Report Clause	Ref Std. Clause	Test Items	Result (PASS/FAIL)	Remark
3.2	§2.1046	Conducted Output Power	Reporting only	-
	§22.913 (a)(5)	Effective Radiated Power (Band 5) (Band 26)	Pass	
	§27.50 (b)(10) §27.50 (c)(10)	Effective Radiated Power (Band 12) (Band 13) (Band 17) (Band 71)		
	§24.232 (c) §27.50 (h)(2)	Equivalent Isotropic Radiated Power (Band 2) (Band 25) (Band 41)		
	§27.50 (d)(4)	Equivalent Isotropic Radiated Power (Band 4) (Band 66)		
3.3	§24.232 (d) §27.50 (d)(5)	Peak-to-Average Ratio	Pass	-
3.4	§2.1049	Occupied Bandwidth	Reporting only	-
3.5	§2.1051 §22.917 (a) §24.238 (a) §27.53 (c)(2)(4) §27.53 (g) §27.53 (h)	Conducted Band Edge Measurement (Band 2) (Band 4) (Band 5) (Band 12) (Band 13) (Band 17) (Band 25) (Band 26) (Band 66) (Band 71)	Pass	-
	§2.1051 §27.53 (m)(4)	Conducted Band Edge Measurement (Band 41)		
3.6	§2.1051 §22.917 (a) §24.238 (a) §27.53 (c)(2) §27.53 (g) §27.53 (h)	Conducted Spurious Emission (Band 2) (Band 4) (Band 5) (Band 12) (Band 13) (Band 17) (Band 25) (Band 26) (Band 66) (Band 71)	Pass	-
	§2.1051 §27.53 (m)(4)	Conducted Spurious Emission (Band 41)		
3.7	§2.1055 §22.355 §24.235 §27.54	Frequency Stability Temperature & Voltage	Pass	-



Report Clause	Ref Std. Clause	Test Items	Result (PASS/FAIL)	Remark
4.2	§2.1053 §22.917 (a) §24.238 (a) §27.53 (c)(2) §27.53 (f) §27.53 (g) §27.53 (h)	Radiated Spurious Emission (Band 2) (Band 4) (Band 5) (Band 12) (Band 13) (Band 17) (Band 25) (Band 26) (Band 66) (Band 71)	Pass	Under limit 6.63 dB at 1568.000 MHz
	§2.1051 §27.53 (m)(4)	Radiated Spurious Emission (Band 41)		

Note: This is a variant report by turning on WWAN Band (LTE Band 13, 17 / 5G NR n78) via software. All the test cases were performed on original report which can be referred to Sporton Report Number FG133040-02A.

Declaration of Conformity:

The test results with all measurement uncertainty excluded are presented in accordance with the regulation limits or requirements declared by manufacturers.

Comments and Explanations:

The declared of product specification for EUT presented in the report are provided by the manufacturer, and the manufacturer takes all the responsibilities for the accuracy of product specification.

Reviewed by: Keven Cheng

Report Producer: Celery Wei



1 General Description

1.1 Product Feature of Equipment Under Test

LTE/5G NR and GNSS.

Product Specification is subject to this standard	
Test Antenna Type	Monopole Antenna
Test Antenna Gain	<p><Ant. 0>: LTE Band 2: 3.9 dBi LTE Band 4: 2.7 dBi LTE Band 5: 0.9 dBi LTE Band 12: 0 dBi LTE Band 13: 1.3 dBi LTE Band 17: 0 dBi LTE Band 25: 3.9 dBi LTE Band 26: 0.9 dBi LTE Band 66: 2.7 dBi LTE Band 71: 0 dBi</p> <p><Ant. 2>: LTE Band 41: 3.5 dBi</p> <p><Ant. 3>: LTE Band 13: 1.7 dBi</p> <p><Ant. 4>: LTE Band 2: 3.7 dBi LTE Band 4: 3.9 dBi LTE Band 25: 3.7 dBi LTE Band 66: 3.9 dBi</p>

Remark: The above EUT's information was declared by manufacturer. Please refer to Comments and Explanations in report summary.

1.2 Modification of EUT

No modifications are made to the EUT during all test items.



1.3 Testing Location

Test Site	Sporton International Inc. EMC & Wireless Communications Laboratory	
Test Site Location	No.52, Huaya 1st Rd., Guishan Dist., Taoyuan City 333, Taiwan (R.O.C.) TEL: +886-3-327-3456 FAX: +886-3-328-4978	
Test Site No.	Sporton Site No.	
	TH03-HY	03CH07-HY
Test Engineer	HaoEn Zhang	Jesse Wang, Stan Hsieh, and Ken Wu
Temperature (°C)	21.2~22.3°C	19~27°C
Relative Humidity (%)	52.1~53.0%	48~63%

Note: The test site complies with ANSI C63.4 2014 requirement.

FCC Designation No.: TW1190

1.4 Applicable Standards

According to the specifications of the manufacturer, the EUT must comply with the requirements of the following standards:

- ♦ ANSI C63.26-2015
- ♦ ANSI / TIA-603-E
- ♦ FCC 47 CFR Part 2, 22(H), 24(E), 27
- ♦ FCC KDB 971168 D01 Power Meas. License Digital Systems v03r01
- ♦ FCC KDB 412172 D01 Determining ERP and EIRP v01r01
- ♦ FCC KDB 414788 D01 Radiated Test Site v01r01

Remark:

1. All test items were verified and recorded according to the standards and without any deviation during the test.
2. This EUT has also been tested and complied with the requirements of FCC Part 15, Subpart B, recorded in a separate test report.
3. The TAF code is not including all the FCC KDB listed without accreditation.



2 Test Configuration of Equipment Under Test

2.1 Test Mode

Antenna port conducted and radiated test items listed below are performed according to KDB 971168 D01 Power Meas. License Digital Systems v03r01 with maximum output power.

For radiated measurement, the measured emission level of the EUT was maximized by rotating the EUT on a turntable, adjusting the orientation of the EUT and EUT antenna in three orthogonal axis (X: flat, Y: portrait, Z: landscape), and adjusting the measurement antenna orientation, following C63.10 exploratory test procedures and find X plane for LTE Band 13 and Z plane for EN-DC LTE B13 +5G NR n5 as worst plane.

Test Items	Band	Bandwidth (MHz)						Modulation				RB #			Test Channel			
		1.4	3	5	10	15	20	QPSK	16QAM	64QAM	256QAM	1	Half	Full	L	M	H	
Max. Output Power	13	-	-	v	v	-	-	v	v	v	v	v	v	v	v	v	v	v
	17	-	-	v	v	-	-	v	v	v	v	v	v	v	v	v	v	v
Peak-to-Average Ratio	13	-	-		v	-	-	v	v	v	v			v		v		
	17	Covered by Band 12																
26dB and 99% Bandwidth	13	-	-	v	v	-	-	v	v	v	v			v		v		
	17	Covered by Band 12																
Conducted Band Edge	13	-	-	v	v	-	-	v	v	v	v	v		v	v		v	
	17	Covered by Band 12																
Conducted Spurious Emission	13	-	-	v	v	-	-	v				v			v	v	v	
	17	Covered by Band 12																
Frequency Stability	13	-	-		v	-	-	v						v		v		
	17	Covered by Band 12																
E.R.P / E.I.R.P	13	-	-	v	v	-	-	v	v	v	v	Max. Power						
	17	-	-	v	v	-	-	v	v	v	v	Max. Power						
Radiated Spurious Emission	13	-	-	v	v	-	-	v				v			v	v	v	
	17	Covered by Band 12																
Remark	<ol style="list-style-type: none"> The mark "v" means that this configuration is chosen for testing The mark "-" means that this bandwidth is not supported. The device is investigated from 30MHz to 10 times of fundamental signal for radiated spurious emission test under different RB size/offset and modulations in exploratory test. Subsequently, only the worst case emissions are reported. Test combination is EN-DC 13A_n5A. LTE Band 13 support Ant. 0 and Ant. 3, after verified, the worst case is Ant. 0. Therefore, only performed the Ant. 0 test results in this report. For LTE Band 17, based on wider working range bandwidth and modulation, when the power is higher or the same, the same coverage area is narrower, so it is covered by LTE Band 12, other test results, please refer to FG133040-02A report. 																	

2.2 Connection Diagram of Test System

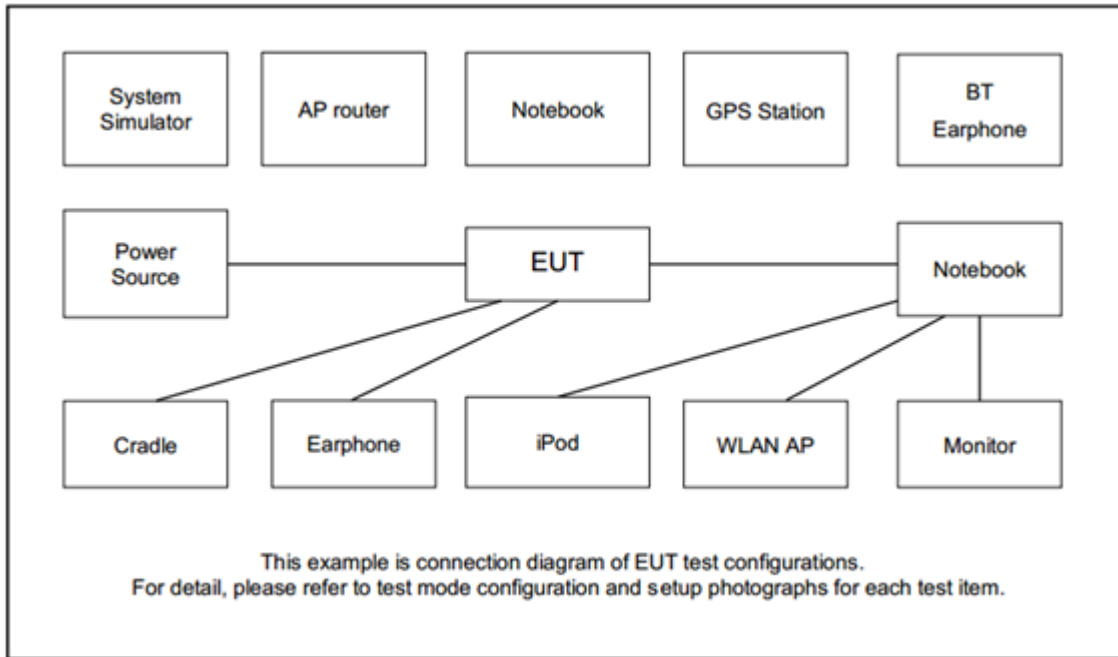

2.3 Support Unit used in test configuration and system

Item	Equipment	Brand Name	Model No.	FCC ID	Data Cable	Power Cord
1.	DC Power Supply	GW Instek	GPE-2323	N/A	N/A	Unshielded, 1.8 m
2.	System Simulator	Anritsu	MT8821C	N/A	N/A	Unshielded, 1.8 m
3.	5G Wireless Test Platform	Anritsu	MT8000A	N/A	N/A	Unshielded, 1.8 m
4.	fixture	Compal	ZM52	N/A	N/A	N/A

2.4 Measurement Results Explanation Example

For all conducted test items:

The offset level is set in the spectrum analyzer to compensate the RF cable loss and attenuator factor between EUT conducted output port and spectrum analyzer. With the offset compensation, the spectrum analyzer reading level is exactly the EUT RF output level.

The spectrum analyzer offset is derived from RF cable loss and attenuator factor.

Offset = RF cable loss + attenuator factor.

Following shows an offset computation example with cable loss 4.2 dB and 10dB attenuator.

Example :

$$\begin{aligned} \text{Offset}(dB) &= \text{RF cable loss}(dB) + \text{attenuator factor}(dB). \\ &= 4.2 + 10 = 14.2 \text{ (dB)} \end{aligned}$$



2.5 Frequency List of Low/Middle/High Channels

LTE Band 13 Channel and Frequency List				
BW [MHz]	Channel/Frequency(MHz)	Lowest	Middle	Highest
10	Channel	-	23230	-
	Frequency	-	782	-
5	Channel	23205	23230	23255
	Frequency	779.5	782	784.5

LTE Band 17 Channel and Frequency List				
BW [MHz]	Channel/Frequency(MHz)	Lowest	Middle	Highest
10	Channel	23780	23790	23800
	Frequency	709	710	711
5	Channel	23755	23790	23825
	Frequency	706.5	710	713.5

3 Conducted Test Items

3.1 Measuring Instruments

See list of measuring instruments of this test report.

3.1.1 Test Setup

3.1.2 Conducted Output Power

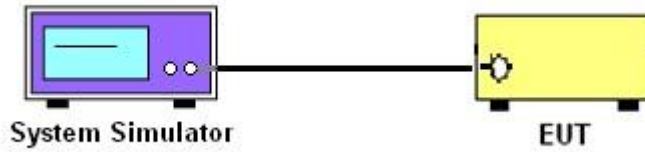

3.1.3 Peak-to-Average Ratio, Occupied Bandwidth ,Conducted Band-Edge and Conducted Spurious Emission



3.1.4 Frequency Stability

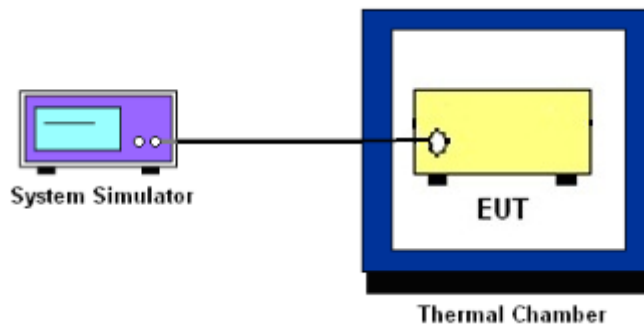

3.1.5 Test Result of Conducted Test

Please refer to Appendix A.



3.2 Conducted Output Power and ERP/EIRP

3.2.1 Description of the Conducted Output Power Measurement and ERP/EIRP Measurement

A system simulator was used to establish communication with the EUT. Its parameters were set to force the EUT transmitting at maximum output power. The measured power in the radio frequency on the transmitter output terminals shall be reported.

The ERP of mobile transmitters must not exceed 3 Watts for LTE Band 13 and Band 17

According to KDB 412172 D01 Power Approach,

$EIRP = P_T + G_T - L_C$, $ERP = EIRP - 2.15$, where

P_T = transmitter output power in dBm

G_T = gain of the transmitting antenna in dBi

L_C = signal attenuation in the connecting cable between the transmitter and antenna in dB

3.2.2 Test Procedures

1. The transmitter output port was connected to the system simulator.
2. Set EUT at maximum power through the system simulator.
3. Select lowest, middle, and highest channels for each band and different modulation.
4. Measure and record the power level from the system simulator.



3.3 Peak-to-Average Ratio

3.3.1 Description of the PAR Measurement

Power Complementary Cumulative Distribution Function (CCDF) curves provide a means for characterizing the power peaks of a digitally modulated signal on a statistical basis. A CCDF curve depicts the probability of the peak signal amplitude exceeding the average power level. Most contemporary measurement instrumentation include the capability to produce CCDF curves for an input signal provided that the instrument's resolution bandwidth can be set wide enough to accommodate the entire input signal bandwidth. In measuring transmissions in this band using an average power technique, the peak-to-average ratio (PAR) of the transmission may not exceed 13 dB.

3.3.2 Test Procedures

The testing follows ANSI C63.26-2015 Section 5.2.6

1. The EUT was connected to spectrum and system simulator via a power divider.
2. Set the CCDF (Complementary Cumulative Distribution Function) option in spectrum analyzer.
3. The highest RF powers were measured and recorded the maximum PAPR level associated with a probability of 0.1 %.
4. Record the deviation as Peak to Average Ratio.



3.4 Occupied Bandwidth

3.4.1 Description of Occupied Bandwidth Measurement

The occupied bandwidth is the width of a frequency band such that, below the lower and above the upper frequency limits, the mean powers emitted are each equal to a specified percentage 0.5% of the total mean transmitted power.

The 26 dB emission bandwidth is defined as the frequency range between two points, one above and one below the carrier frequency, at which the spectral density of the emission is attenuated 26 dB below the maximum in-band spectral density of the modulated signal. Spectral density (power per unit bandwidth) is to be measured with a detector of resolution bandwidth equal to approximately 1.0% of the emission bandwidth.

3.4.2 Test Procedures

The testing follows ANSI C63.26-2015 Section 5.4.3 (26dB) and Section 5.4.4 (99OB)

1. The EUT was connected to spectrum analyzer and system simulator via a power divider.
2. The spectrum analyzer center frequency is set to the nominal EUT channel center frequency. The span range for the spectrum analyzer shall be between two and five times the anticipated OBW.
3. The nominal resolution bandwidth (RBW) shall be in the range of 1 to 5 % of the anticipated OBW, and the VBW shall be at least 3 times the RBW.
4. Set the detection mode to peak, and the trace mode to max hold.
5. Determine the reference value: Set the EUT to transmit a modulated signal. Allow the trace to stabilize. Set the spectrum analyzer marker to the highest level of the displayed trace.
(this is the reference value)
6. Determine the “-26 dB down amplitude” as equal to (Reference Value – X).
7. Place two markers, one at the lowest and the other at the highest frequency of the envelope of the spectral display such that each marker is at or slightly below the “-X dB down amplitude” determined in step 6. If a marker is below this “-X dB down amplitude” value it shall be placed as close as possible to this value. The OBW is the positive frequency difference between the two markers.
8. Use the 99 % power bandwidth function of the spectrum analyzer and report the measured bandwidth.



3.5 Conducted Band Edge

3.5.1 Description of Conducted Band Edge Measurement

27.53 (c)

For operations in the 776-788 MHz band, the FCC limit is $43 + 10\log_{10}(P[\text{Watts}])$ dB below the transmitter power $P(\text{Watts})$ in a 100 kHz bandwidth. However, in the 100 kHz bands immediately outside and adjacent to the frequency block, a resolution bandwidth of at least 30 kHz may be employed. In addition, the power of any unwanted emissions in any 6.25 kHz bandwidth for all frequencies between 763-775 MHz and 793-806 MHz shall be attenuated below the transmitter power, P (dBW), by at least $65 + 10 \log_{10} p(\text{watts})$, dB, for mobile and portable equipment.

27.53 (g)

For operations in the 600MHz band and 698-746 MHz band, the FCC limit is $43 + 10\log_{10}(P[\text{Watts}])$ dB below the transmitter power $P(\text{Watts})$ in a 100 kHz bandwidth. However, in the 100 kilohertz bands immediately outside and adjacent to a licensee's frequency block, a resolution bandwidth of at least 30 kHz may be employed.

3.5.2 Test Procedures

The testing follows FCC KDB 971168 D01 v03r01 Section 6.1.

1. The EUT was connected to spectrum analyzer and system simulator via a power divider.
2. The band edges of low and high channels for the highest RF powers were measured.
3. Set RBW \geq 1% EBW in the 1MHz band immediately outside and adjacent to the band edge.
4. Beyond the 1 MHz band from the band edge, RBW=1MHz was used.
5. Set spectrum analyzer with RMS detector.
6. The RF fundamental frequency should be excluded against the limit line in the operating frequency band.
7. Checked that all the results comply with the emission limit line.

The limit line is derived from $43 + 10\log(P)\text{dB}$ below the transmitter power $P(\text{Watts})$



3.6 Conducted Spurious Emission

3.6.1 Description of Conducted Spurious Emission Measurement

The power of any emission outside of the authorized operating frequency ranges must be lower than the transmitter power (P) by a factor of at least $43 + 10 \log (P)$ dB.

It is measured by means of a calibrated spectrum analyzer and scanned from 30 MHz up to a frequency including its 10th harmonic.

3.6.2 Test Procedures

The testing follows FCC KDB 971168 D01 v03r01 Section 6.1.

1. The EUT was connected to spectrum analyzer and system simulator via a power divider.
2. The RF output of EUT was connected to the spectrum analyzer by RF cable and attenuator. The path loss was compensated to the results for each measurement.
3. The middle channel for the highest RF power within the transmitting frequency was measured.
4. The conducted spurious emission for the whole frequency range was taken.
5. Make the measurement with the spectrum analyzer's RBW = 1MHz, VBW = 3MHz.
6. Set spectrum analyzer with RMS detector.
7. Taking the record of maximum spurious emission.
8. The RF fundamental frequency should be excluded against the limit line in the operating frequency band.
9. The limit line is derived from $43 + 10\log(P)$ dB below the transmitter power P(Watts)



3.7 Frequency Stability

3.7.1 Description of Frequency Stability Measurement

27.54

The frequency stability shall be sufficient to ensure that the fundamental emission stays within the authorized frequency block.

3.7.2 Test Procedures for Temperature Variation

The testing follows FCC KDB 971168 D01 v03r01 Section 9.0.

1. The EUT was set up in the thermal chamber and connected with the system simulator.
2. With power OFF, the temperature was decreased to -30°C and the EUT was stabilized before testing. Power was applied and the maximum change in frequency was recorded within one minute.
3. With power OFF, the temperature was raised in 10°C step up to 50°C . The EUT was stabilized at each step for at least half an hour. Power was applied and the maximum frequency change was recorded within one minute.

3.7.3 Test Procedures for Voltage Variation

The testing follows FCC KDB 971168 D01 v03r01 Section 9.0.

4. The EUT was placed in a temperature chamber at $20\pm 5^{\circ}\text{C}$ and connected with the system simulator.
5. The power supply voltage to the EUT was varied from 85% to 115% of the nominal value measured at the input to the EUT.
6. The variation in frequency was measured for the worst case.

4 Radiated Test Items

4.1 Measuring Instruments

See list of measuring instruments of this test report.

4.1.1 Test Setup

For radiated test below 30MHz



For radiated test from 30MHz to 1GHz

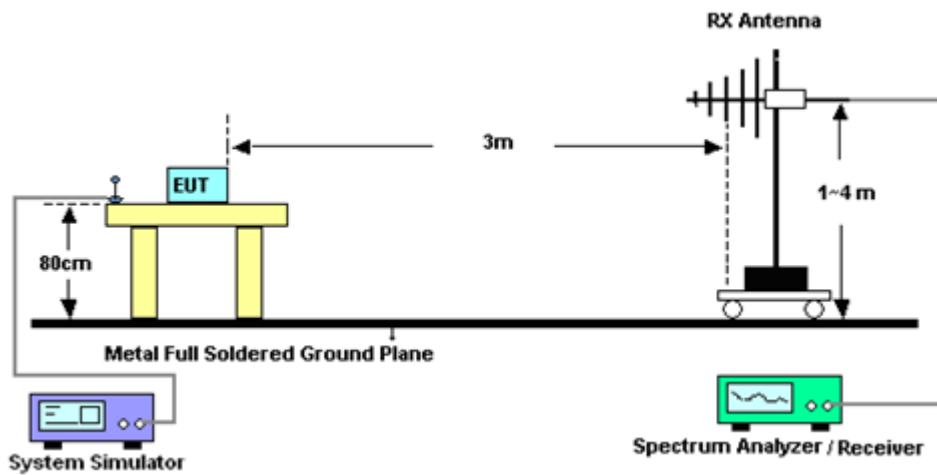

For radiated test above 1GHz

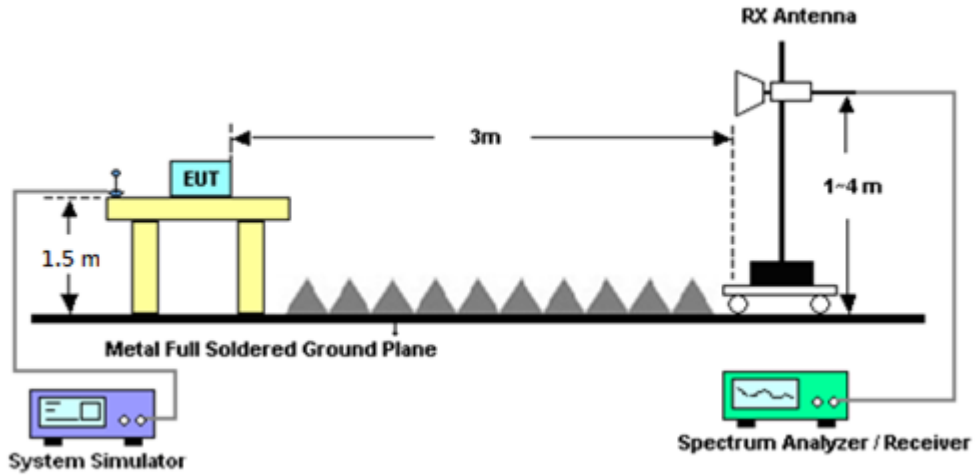

4.1.2 Test Result of Radiated Test

Please refer to Appendix B.

Note:

The low frequency, which started from 9 kHz to 30MHz, was pre-scanned and the result which was 20dB lower than the limit line was not reported.

There is adequate comparison measurement of both open-field test site and alternative test site - semi-Anechoic chamber according to 414788 D01 Radiated Test Site v01r01, and the result came out very similar.



4.2 Radiated Spurious Emission Measurement

4.2.1 Description of Radiated Spurious Emission Measurement

The radiated spurious emission was measured by substitution method according to ANSI / TIA-603-E. The power of any emission outside of the authorized operating frequency ranges must be attenuated below the transmitter power (P) by a factor of at least $43 + 10 \log (P)$ dB.

For LTE Band 13

For operations in the 746-758 MHz, 775-788 MHz, and 805-806 MHz bands, emissions in the band 1559-1610 MHz shall be limited to -70 dBW/MHz equivalent isotropically radiated power (EIRP) for wideband signals, and -80 dBW EIRP for discrete emissions of less than 700 Hz bandwidth.

The spectrum is scanned from 30 MHz up to a frequency including its 10th harmonic.

4.2.2 Test Procedures

The testing follows FCC KDB 971168 D01 v03r01 Section 7 and ANSI / TIA-603-E Section 2.2.12.

1. The EUT was placed on a turntable with 0.8 meter for frequency below 1GHz and 1.5 meter for frequency above 1GHz respectively above ground.
2. The EUT was set 3 meters from the receiving antenna, which was mounted on the antenna tower.
3. The table was rotated 360 degrees to determine the position of the highest spurious emission.
4. The height of the receiving antenna is varied between one meter and four meters to search the maximum spurious emission for both horizontal and vertical polarizations.
5. Make the measurement with the spectrum analyzer's RBW = 1MHz, VBW = 3MHz, taking the record of maximum spurious emission.
6. A horn antenna was substituted in place of the EUT and was driven by a signal generator.
7. Tune the output power of signal generator to the same emission level with EUT maximum spurious emission.
8. Taking the record of output power at antenna port.
9. Repeat step 7 to step 8 for another polarization.
10. The RF fundamental frequency should be excluded against the limit line in the operating frequency band.

The limit line is derived from $43 + 10\log(P)$ dB below the transmitter power P(Watts)

$EIRP \text{ (dBm)} = S.G. \text{ Power} - Tx \text{ Cable Loss} + Tx \text{ Antenna Gain}$

$ERP \text{ (dBm)} = EIRP - 2.15$



5 List of Measuring Equipment

Instrument	Brand Name	Model No.	Serial No.	Characteristics	Calibration Date	Test Date	Due Date	Remark
Bilog Antenna	TESEQ	CBL 6111D & 00800N1D01N-06	35419 & 03	30MHz~1GHz	Apr. 28, 2021	Nov. 16, 2021~Nov. 18, 2021	Apr. 27, 2022	Radiation (03CH07-HY)
Double Ridge Horn Antenna	ESCO	3117	00075962	1GHz ~ 18GHz	Dec. 01, 2020	Nov. 16, 2021~Nov. 18, 2021	Nov. 30, 2021	Radiation (03CH07-HY)
Preamplifier	MITEQ	AMF-7D-0010 1800-30-10P	1590075	1GHz~18GHz	Apr. 22, 2021	Nov. 16, 2021~Nov. 18, 2021	Apr. 21, 2022	Radiation (03CH07-HY)
Preamplifier	COM-POWER	PA-103A	161241	10MHz~1GHz	May 18, 2021	Nov. 16, 2021~Nov. 18, 2021	May 17, 2022	Radiation (03CH07-HY)
Preamplifier	Agilent	8449B	3008A02362	1GHz~26.5GHz	Oct. 04, 2021	Nov. 16, 2021~Nov. 18, 2021	Oct. 03, 2022	Radiation (03CH07-HY)
Preamplifier	EMEC	EM18G40G	0600789	18-40GHz	Jul. 23, 2021	Nov. 16, 2021~Nov. 18, 2021	Jul. 22, 2022	Radiation (03CH07-HY)
Spectrum Analyzer	Agilent	N9030A	MY52350276	3Hz~44GHz	Jul. 22, 2021	Nov. 16, 2021~Nov. 18, 2021	Jul. 21, 2022	Radiation (03CH07-HY)
RF Cable	HUBER + SUHNER	SUCOFLEX 104	MY15682-4	30MHz to 18GHz	Feb. 24, 2021	Nov. 16, 2021~Nov. 18, 2021	Feb. 23, 2022	Radiation (03CH07-HY)
RF Cable	HUBER + SUHNER	SUCOFLEX 104	MY24971-4	9kHz to 18GHz	Feb. 24, 2021	Nov. 16, 2021~Nov. 18, 2021	Feb. 23, 2022	Radiation (03CH07-HY)
RF Cable	HUBER + SUHNER	SUCOFLEX 104	MY28655-4	9kHz to 18GHz	Feb. 24, 2021	Nov. 16, 2021~Nov. 18, 2021	Feb. 23, 2022	Radiation (03CH07-HY)
RF Cable	HUBER + SUHNER	SUCOFLEX 126	532078/126E	30MHz~18GHz	Sep. 17, 2021	Nov. 16, 2021~Nov. 18, 2021	Sep. 16, 2022	Radiation (03CH07-HY)
Controller	EMEC	EM1000	N/A	Control Ant Mast	Apr. 28, 2021	Nov. 16, 2021~Nov. 18, 2021	Apr. 27, 2022	Radiation (03CH07-HY)
Controller	MF	MF-7802	N/A	Control Turn table	N/A	Nov. 16, 2021~Nov. 18, 2021	N/A	Radiation (03CH07-HY)
Antenna Mast	EMEC	AM-BS-4500E	N/A	Boresight mast 1M~4M	Apr. 28, 2021	Nov. 16, 2021~Nov. 18, 2021	Apr. 27, 2022	Radiation (03CH07-HY)
Turn Table	ChainTek	Chaintek 3000	N/A	0~360 Degree	N/A	Nov. 16, 2021~Nov. 18, 2021	N/A	Radiation (03CH07-HY)
Software	Audix	E3 6.2009-8-24	N/A	N/A	N/A	Nov. 16, 2021~Nov. 18, 2021	N/A	Radiation (03CH07-HY)
USB Data Logger	TECPEL	TR-32	HE17XB2495	N/A	Mar. 09, 2021	Nov. 16, 2021~Nov. 18, 2021	Mar. 08, 2022	Radiation (03CH07-HY)
Horn Antenna	EMCO	3117	00143261	1GHz~18GHz	Jan. 26, 2021	Nov. 16, 2021~Nov. 18, 2021	Jan. 25, 2022	Radiation (03CH07-HY)
Signal Generator	Rohde & Schwarz	SMF100A	101107	100kHz~40GHz	Dec. 04, 2020	Nov. 16, 2021~Nov. 18, 2021	Dec. 03, 2021	Radiation (03CH07-HY)
Radio Communication Analyzer	Anritsu	MT8821C	6201664755	2/3/4G/LTE FDD/TDD with44)/LTE-3C C DLCA/2CC ULCA, CatM1/NB1/NB2	Jul. 21, 2021	Nov. 15, 2021	Jul. 20, 2022	Conducted (TH03-HY)
Spectrum Analyzer	Rohde & Schwarz	FSV40	101909	10Hz~40GHz	Aug. 13, 2021	Nov. 15, 2021	Aug. 12, 2022	Conducted (TH03-HY)
Thermal Chamber	ESPEC	SH-641	92013720	-40℃ ~90℃	Sep. 09, 2021	Nov. 15, 2021	Sep. 08, 2022	Conducted (TH03-HY)
Programmable Power Supply	GW Instek	PSS-2005	EL890001	1V~20V 0.5A~5A	Oct. 06, 2021	Nov. 15, 2021	Oct. 05, 2022	Conducted (TH03-HY)
Coupler	Warison	20dB 25W SMA Directional Coupler	#B	1-18GHz	Jan. 09, 2021	Nov. 15, 2021	Jan. 08, 2022	Conducted (TH03-HY)



6 Uncertainty of Evaluation

Uncertainty of Radiated Emission Measurement (30 MHz ~ 1000 MHz)

Measuring Uncertainty for a Level of Confidence of 95% ($U = 2Uc(y)$)	3.16 dB
---	---------

Uncertainty of Radiated Emission Measurement (1 GHz ~ 18 GHz)

Measuring Uncertainty for a Level of Confidence of 95% ($U = 2Uc(y)$)	3.71 dB
---	---------

Uncertainty of Radiated Emission Measurement (18 GHz ~ 40 GHz)

Measuring Uncertainty for a Level of Confidence of 95% ($U = 2Uc(y)$)	4.16 dB
---	---------



Appendix A. Test Results of Conducted Test

Conducted Output Power(Average power & ERP)

LTE Band 13 Maximum Average Power [dBm] (GT - LC = 1.7 dB)								
BW [MHz]	RB Size	RB Offset	Mod	Lowest	Middle	Highest	ERP (dBm)	ERP (W)
10	1	0	QPSK		23.90		23.45	0.2213
10	1	25			23.89			
10	1	49			23.79			
10	25	0			22.73			
10	25	12			22.90			
10	25	25			22.92			
10	50	0			22.88			
10	1	0	16-QAM		23.21		22.76	0.1888
10	1	25			23.14			
10	1	49			23.10			
10	25	0			21.77			
10	25	12			21.88			
10	25	25			21.90			
10	50	0			21.84			
10	1	0	64-QAM		22.15		21.70	0.1479
10	1	25			22.11			
10	1	49			21.93			
10	25	0			20.72			
10	25	12			20.85			
10	25	25			20.89			
10	50	0			20.80			
10	1	0	256-QAM		19.06		18.61	0.0726
10	1	25			19.03			
10	1	49			18.92			
10	25	0			18.73			
10	25	12			18.87			
10	25	25			18.91			
10	50	0			18.83			
Limit	ERP < 3W			Result			Pass	



LTE Band 13 Maximum Average Power [dBm] (GT - LC = 1.7 dB)								
BW [MHz]	RB Size	RB Offset	Mod	Lowest	Middle	Highest	ERP (dBm)	ERP (W)
5	1	0	QPSK	23.87	23.85	23.88	23.44	0.2208
5	1	12		23.86	23.85	23.89		
5	1	24		23.76	23.78	23.73		
5	12	0		22.65	22.73	22.69		
5	12	7		22.83	22.80	22.86		
5	12	13		22.82	22.85	22.87		
5	25	0		22.83	22.87	22.79		
5	1	0	16-QAM	23.14	23.20	23.15	22.75	0.1884
5	1	12		23.06	23.07	23.05		
5	1	24		23.04	23.01	23.08		
5	12	0		21.70	21.71	21.70		
5	12	7		21.83	21.79	21.81		
5	12	13		21.88	21.84	21.83		
5	25	0		21.74	21.78	21.80		
5	1	0	64-QAM	22.05	22.05	22.06	21.64	0.1459
5	1	12		22.09	22.09	22.07		
5	1	24		21.89	21.92	21.90		
5	12	0		20.63	20.68	20.67		
5	12	7		20.84	20.76	20.84		
5	12	13		20.89	20.85	20.86		
5	25	0		20.75	20.78	20.77		
5	1	0	256-QAM	19.05	19.02	19.04	18.60	0.0724
5	1	12		19.02	19.01	19.01		
5	1	24		18.86	18.87	18.83		
5	12	0		18.71	18.64	18.66		
5	12	7		18.87	18.79	18.80		
5	12	13		18.87	18.85	18.89		
5	25	0		18.73	18.81	18.80		
Limit	ERP < 3W			Result			Pass	



LTE Band 17 Maximum Average Power [dBm] (GT - LC = 0 dB)								
BW [MHz]	RB Size	RB Offset	Mod	Lowest	Middle	Highest	ERP (dBm)	ERP (W)
10	1	0	QPSK	23.66	23.69	23.64	21.54	0.1426
10	1	25		23.58	23.68	23.61		
10	1	49		23.50	23.57	23.46		
10	25	0		22.67	22.78	22.73		
10	25	12		22.64	22.68	22.56		
10	25	25		22.54	22.65	22.60		
10	50	0		22.68	22.73	22.64		
10	1	0	16-QAM	22.92	23.02	22.94	20.87	0.1222
10	1	25		22.92	22.96	22.83		
10	1	49		22.74	22.80	22.71		
10	25	0		21.64	21.75	21.60		
10	25	12		21.59	21.65	21.60		
10	25	25		21.61	21.67	21.59		
10	50	0		21.60	21.70	21.58		
10	1	0	64-QAM	21.77	21.88	21.81	19.73	0.0940
10	1	25		21.69	21.80	21.74		
10	1	49		21.66	21.76	21.71		
10	25	0		20.68	20.72	20.65		
10	25	12		20.57	20.62	20.47		
10	25	25		20.53	20.63	20.56		
10	50	0		20.67	20.70	20.55		
10	1	0	256-QAM	18.68	18.78	18.67	16.63	0.0460
10	1	25		18.64	18.71	18.65		
10	1	49		18.58	18.68	18.57		
10	25	0		18.71	18.74	18.68		
10	25	12		18.59	18.66	18.57		
10	25	25		18.60	18.63	18.57		
10	50	0		18.64	18.71	18.60		
Limit	ERP < 3W			Result			Pass	



LTE Band 17 Maximum Average Power [dBm] (GT - LC = 0 dB)								
BW [MHz]	RB Size	RB Offset	Mod	Lowest	Middle	Highest	ERP (dBm)	ERP (W)
5	1	0	QPSK	23.59	23.66	23.56	21.53	0.1422
5	1	12		23.52	23.68	23.59		
5	1	24		23.49	23.55	23.37		
5	12	0		22.59	22.72	22.72		
5	12	7		22.54	22.61	22.52		
5	12	13		22.44	22.55	22.60		
5	25	0		22.67	22.70	22.58		
5	1	0	16-QAM	22.82	23.01	22.93	20.86	0.1219
5	1	12		22.92	22.96	22.82		
5	1	24		22.65	22.80	22.65		
5	12	0		21.59	21.67	21.55		
5	12	7		21.52	21.60	21.58		
5	12	13		21.53	21.58	21.51		
5	25	0		21.60	21.69	21.56		
5	1	0	64-QAM	21.73	21.81	21.72	19.66	0.0925
5	1	12		21.62	21.75	21.70		
5	1	24		21.61	21.73	21.69		
5	12	0		20.59	20.66	20.56		
5	12	7		20.50	20.59	20.39		
5	12	13		20.47	20.60	20.55		
5	25	0		20.64	20.67	20.53		
5	1	0	256-QAM	18.59	18.68	18.64	16.56	0.0453
5	1	12		18.61	18.68	18.55		
5	1	24		18.51	18.60	18.57		
5	12	0		18.68	18.71	18.63		
5	12	7		18.58	18.59	18.57		
5	12	13		18.55	18.56	18.53		
5	25	0		18.63	18.65	18.51		
Limit	ERP < 3W			Result			Pass	



LTE Band 13

Peak-to-Average Ratio

Mode	LTE Band 13 / 10MHz				
Mod.	QPSK	16QAM	64QAM	256QAM	Limit: 13dB
RB Size	Full RB	Full RB	Full RB	Full RB	Result
Middle CH	4.99	5.83	6.09	6.12	PASS

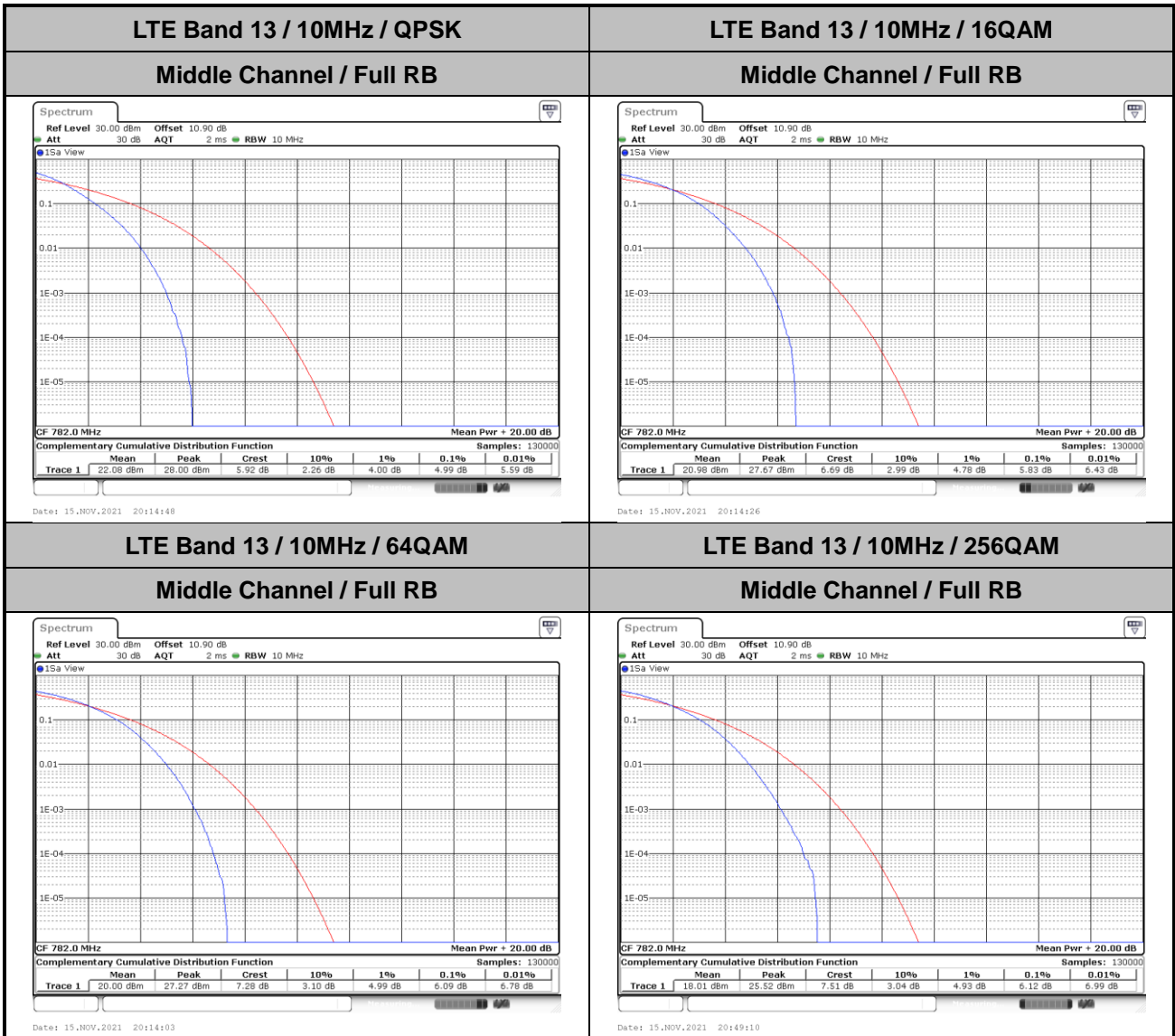



26dB Bandwidth

Mode	LTE Band 13 : 26dB BW(MHz)											
BW	1.4MHz		3MHz		5MHz		10MHz		15MHz		20MHz	
Mod.	QPSK	16QAM	QPSK	16QAM	QPSK	16QAM	QPSK	16QAM	QPSK	16QAM	QPSK	16QAM
Middle CH	-	-	-	-	4.88	4.85	9.79	9.79	-	-	-	-
Mode	LTE Band 13 : 26dB BW(MHz)											
BW	1.4MHz		3MHz		5MHz		10MHz		15MHz		20MHz	
Mod.	64QAM	256 QAM	64QAM	256 QAM	64QAM	256 QAM	64QAM	256 QAM	64QAM	256 QAM	64QAM	256 QAM
Middle CH	-	-	-	-	4.87	4.90	9.75	9.67	-	-	-	-



LTE Band 13

Middle Channel / 5MHz / QPSK

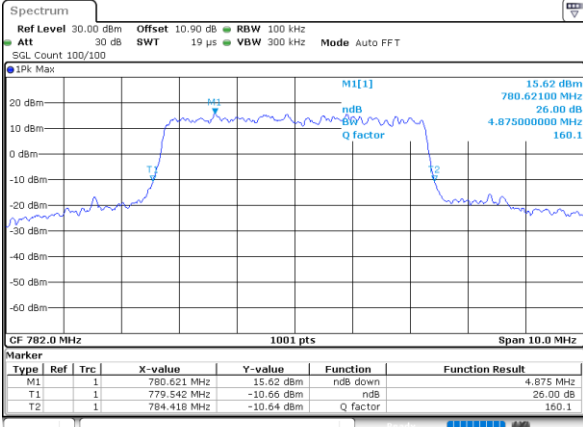

Date: 15.NOV.2021 19:36:59

Middle Channel / 5MHz / 16QAM

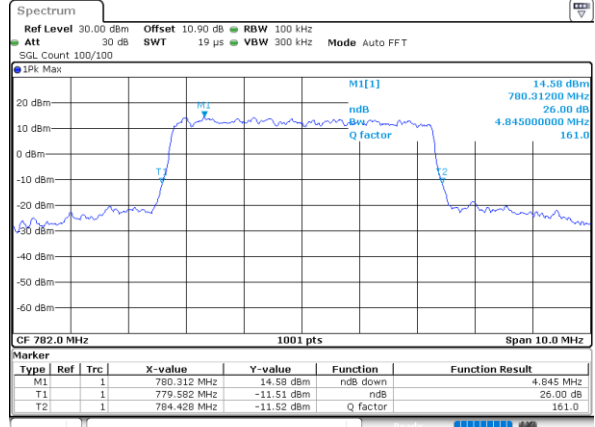

Date: 15.NOV.2021 19:37:120

Middle Channel / 10MHz / QPSK

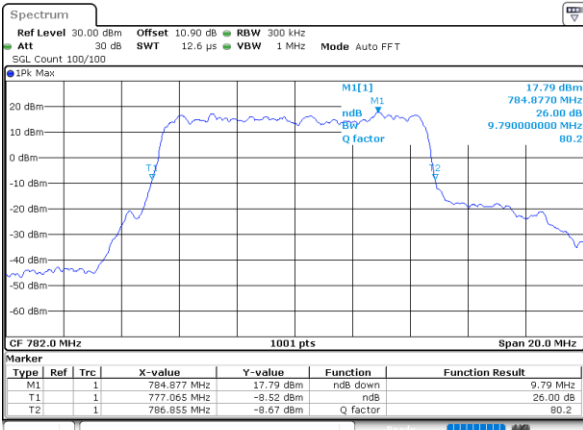

Date: 15.NOV.2021 19:55:41

Middle Channel / 10MHz / 16QAM

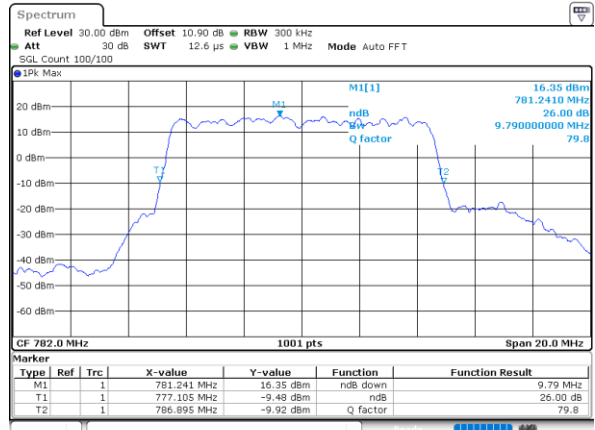

Date: 15.NOV.2021 19:55:121

Middle Channel / 5MHz / 64QAM

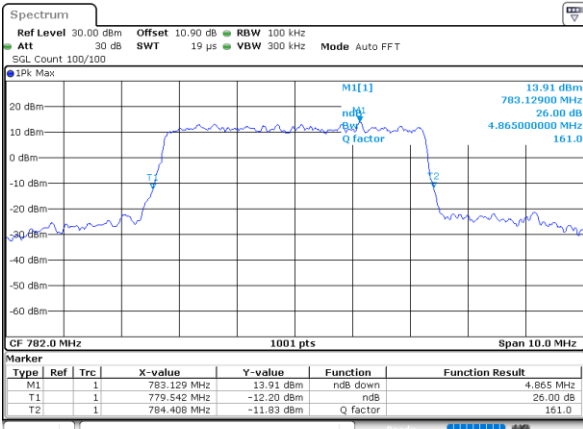

Date: 15.NOV.2021 19:50:16

Middle Channel / 10MHz / 64QAM

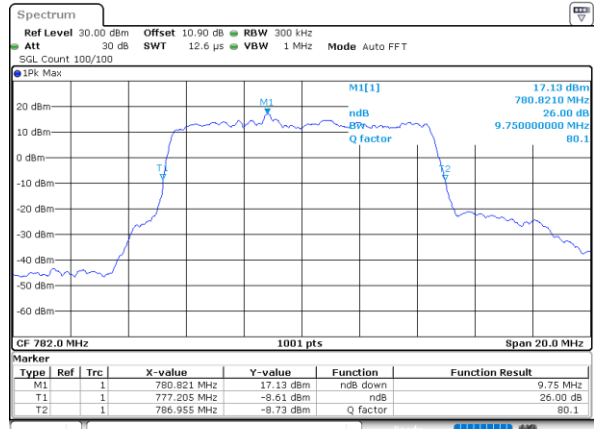

Date: 15.NOV.2021 20:08:12



LTE Band 13

Middle Channel / 5MHz / 256QAM

Middle Channel / 10MHz / 256QAM

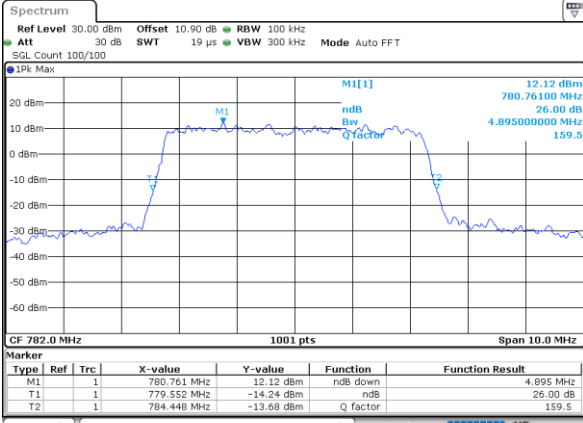

Date: 15,NOV,2021 20:33:15

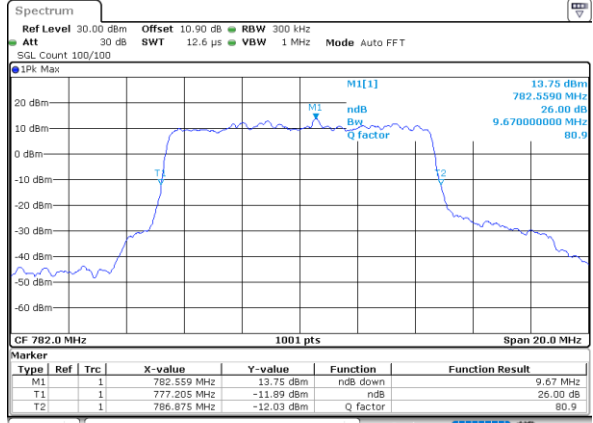

Date: 15,NOV,2021 20:43:18



Occupied Bandwidth

Mode	LTE Band 13 : 99%OBW(MHz)											
BW	1.4MHz		3MHz		5MHz		10MHz		15MHz		20MHz	
Mod.	QPSK	16QAM	QPSK	16QAM	QPSK	16QAM	QPSK	16QAM	QPSK	16QAM	QPSK	16QAM
Middle CH	-	-	-	-	4.50	4.48	9.03	8.97	-	-	-	-
Mode	LTE Band 13 : 99%OBW(MHz)											
BW	1.4MHz		3MHz		5MHz		10MHz		15MHz		20MHz	
Mod.	64QAM	256 QAM	64QAM	256 QAM	64QAM	256 QAM	64QAM	256 QAM	64QAM	256 QAM	64QAM	256 QAM
Middle CH	-	-	-	-	4.50	4.48	8.97	8.97	-	-	-	-



LTE Band 13

Middle Channel / 5MHz / QPSK

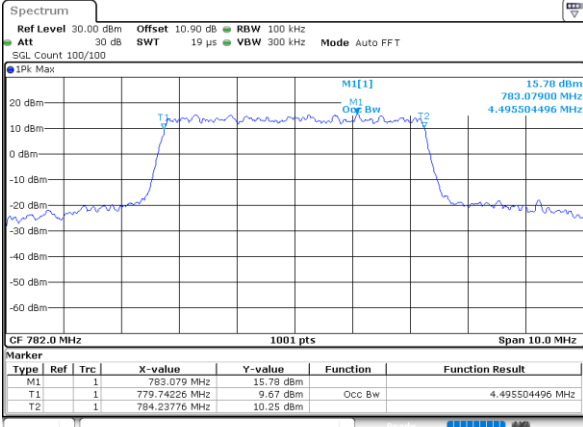

Date: 15.NOV.2021 19:38:01

Middle Channel / 5MHz / 16QAM

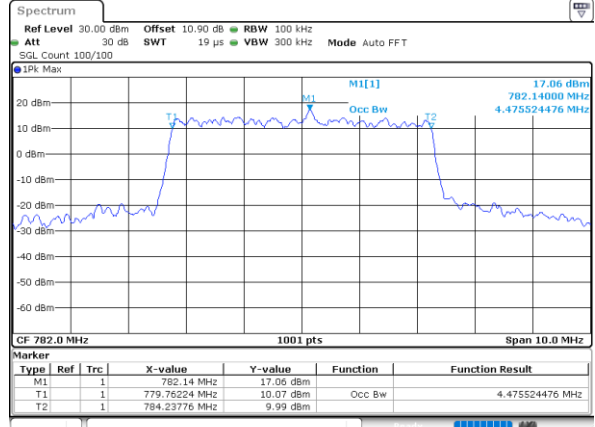

Date: 15.NOV.2021 19:37:40

Middle Channel / 10MHz / QPSK

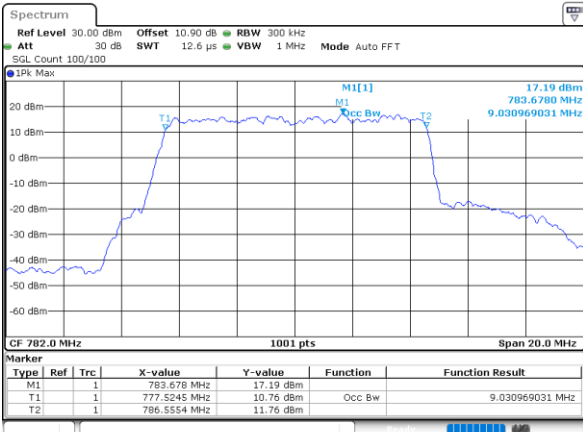

Date: 15.NOV.2021 19:54:39

Middle Channel / 10MHz / 16QAM

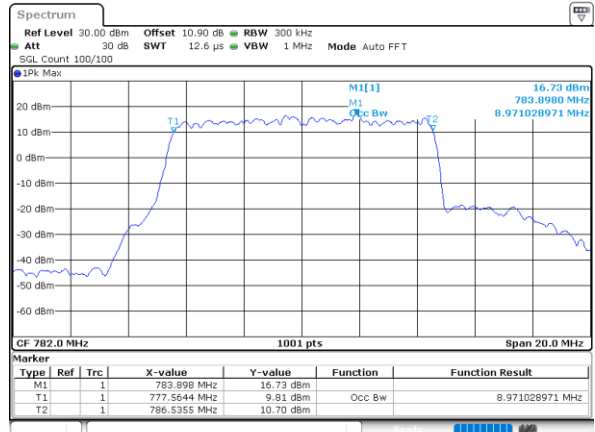

Date: 15.NOV.2021 19:55:00

Middle Channel / 5MHz / 64QAM

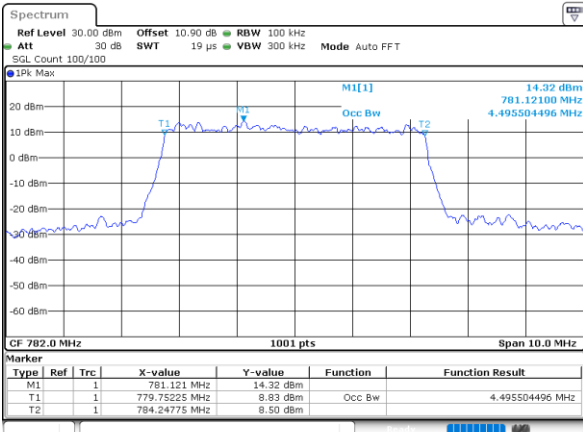

Date: 15.NOV.2021 19:50:37

Middle Channel / 10MHz / 64QAM

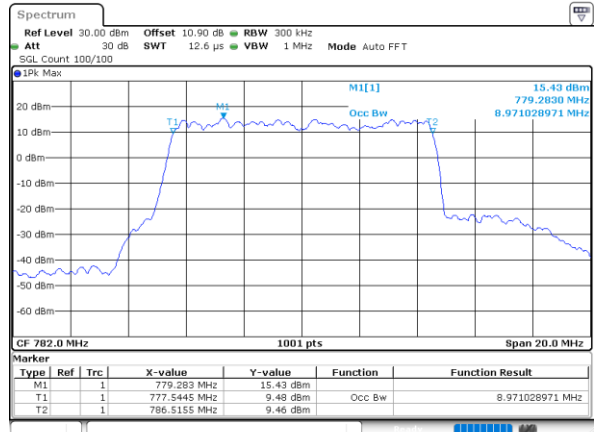

Date: 15.NOV.2021 20:07:51



LTE Band 13

Middle Channel / 5MHz / 256QAM

Middle Channel / 10MHz / 256QAM

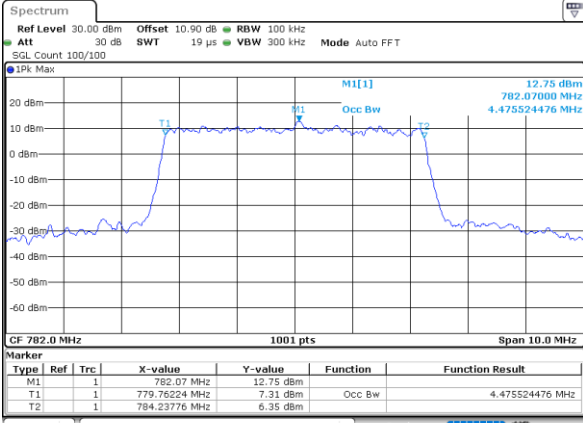

Date: 15,NOV,2021 20:33:36

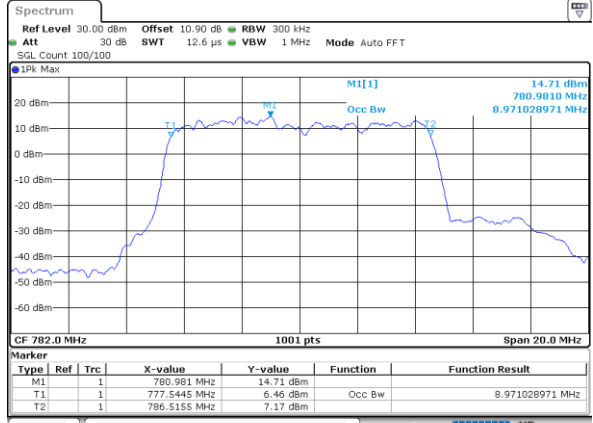

Date: 15,NOV,2021 20:42:58



Conducted Band Edge

LTE Band 13 / 5MHz / QPSK

Lowest Band Edge / 1 RB

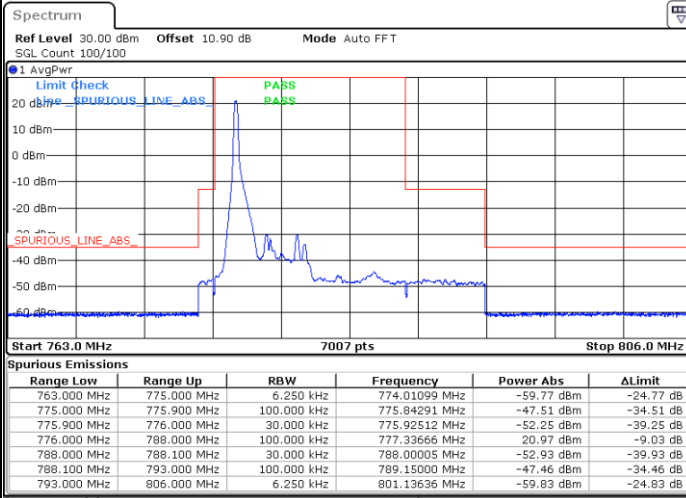

Date: 15.NOV.2021 19:34:58

Highest Band Edge / 1 RB

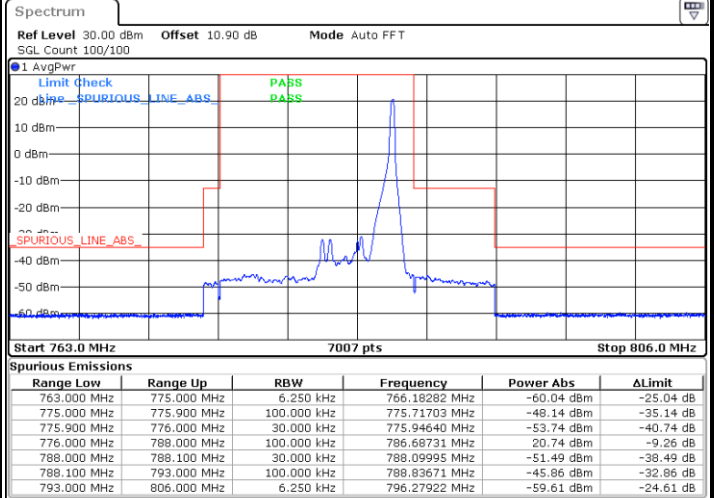

Date: 15.NOV.2021 19:45:23

Lowest Band Edge / Full RB

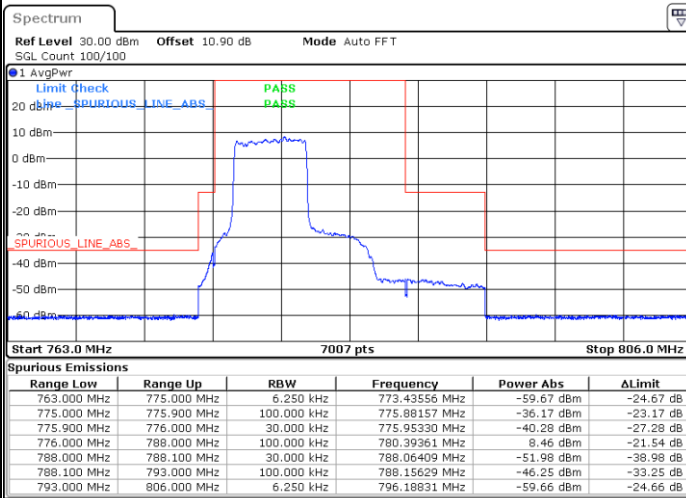

Date: 15.NOV.2021 19:29:26

Highest Band Edge / Full RB

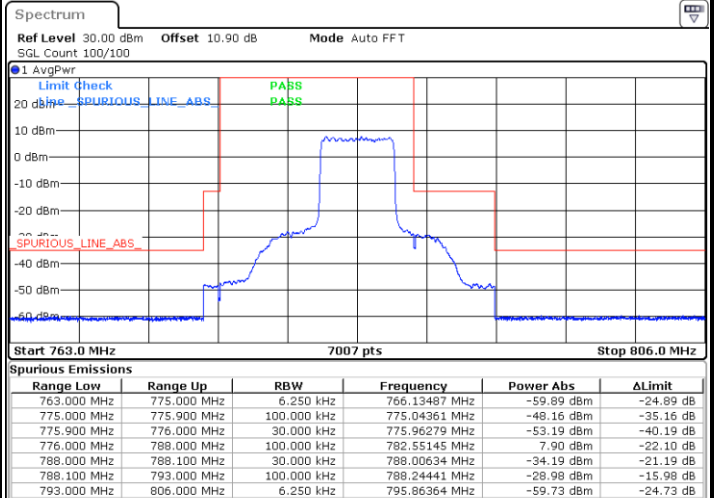

Date: 15.NOV.2021 19:39:52



LTE Band 13 / 5MHz / 16QAM

Lowest Band Edge / 1 RB

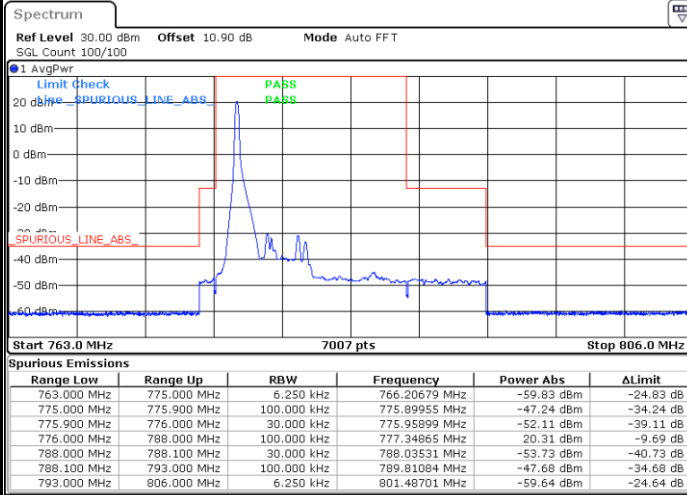

Date: 15.NOV.2021 19:33:07

Highest Band Edge / 1 RB

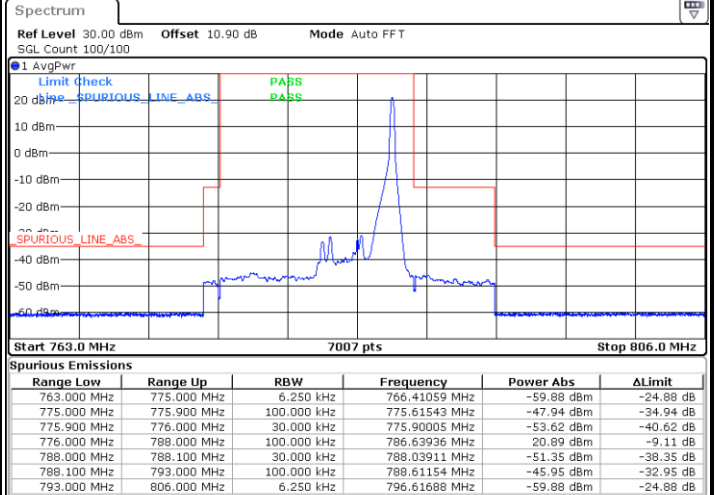

Date: 15.NOV.2021 19:43:33

Lowest Band Edge / Full RB

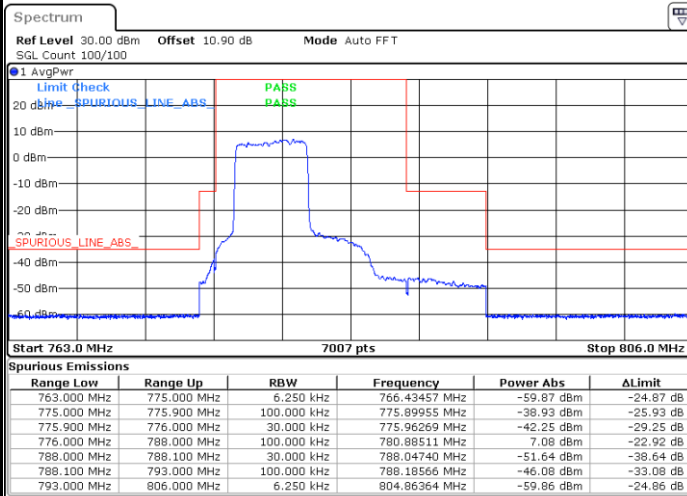

Date: 15.NOV.2021 19:31:17

Highest Band Edge / Full RB

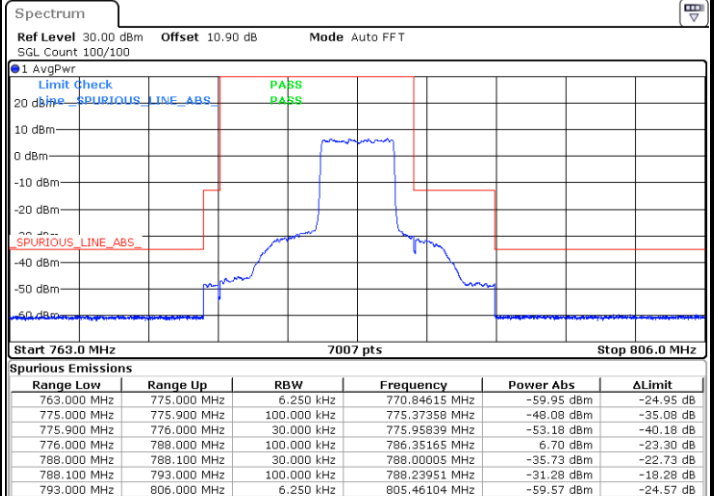

Date: 15.NOV.2021 19:41:42



LTE Band 13 / 5MHz / 64QAM

Lowest Band Edge / 1 RB

Highest Band Edge / 1 RB

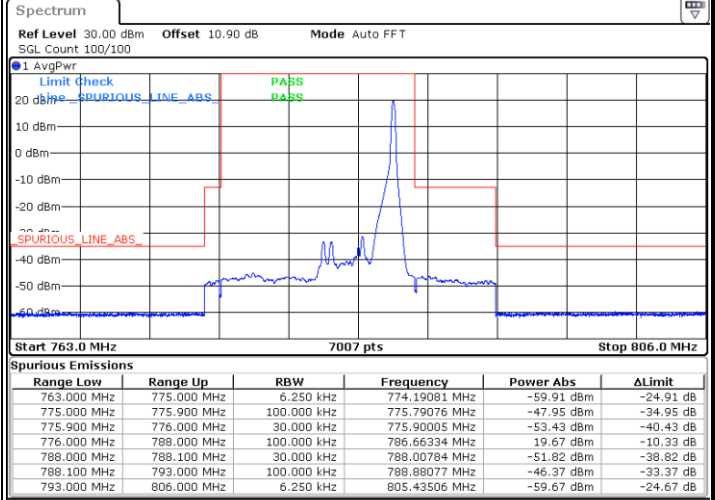
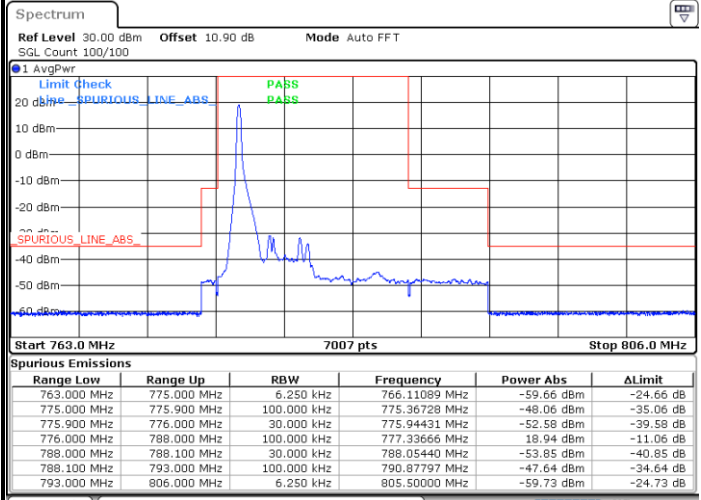

Date: 15.NOV.2021 19:49:55

Date: 15.NOV.2021 19:54:18

Lowest Band Edge / Full RB

Highest Band Edge / Full RB

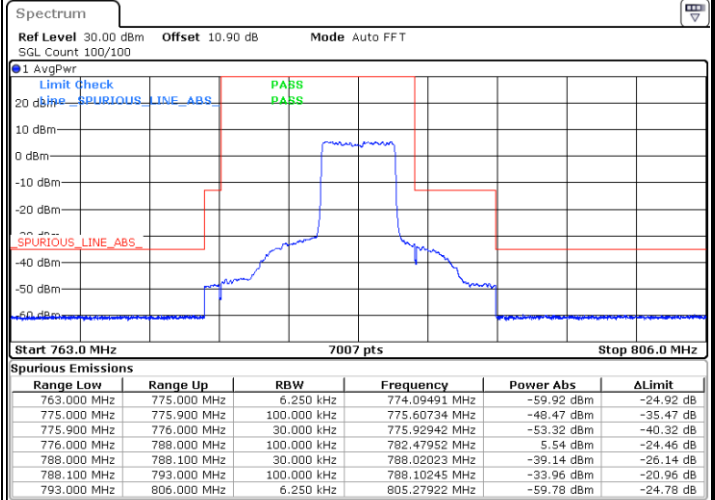
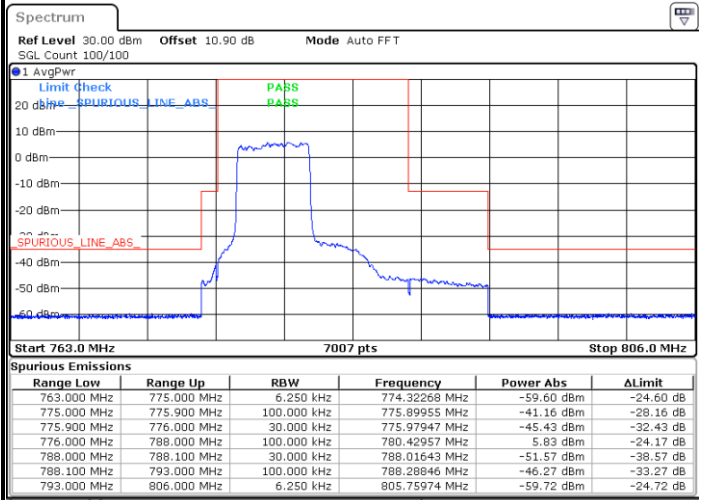

Date: 15.NOV.2021 19:48:04

Date: 15.NOV.2021 19:52:27



LTE Band 13 / 5MHz / 256QAM

Lowest Band Edge / 1 RB

Highest Band Edge / 1 RB

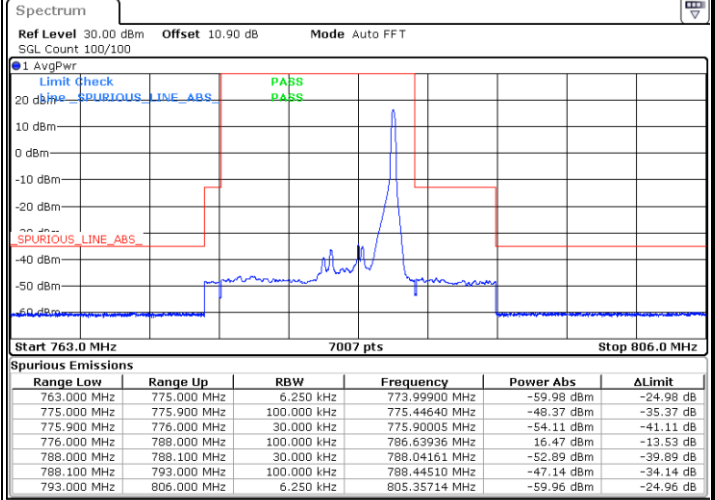
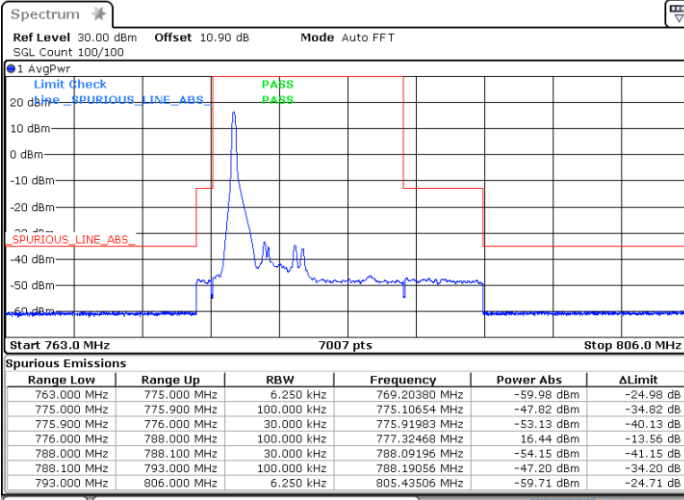

Date: 15.NOV.2021 21:03:22

Date: 15.NOV.2021 20:37:19

Lowest Band Edge / Full RB

Highest Band Edge / Full RB

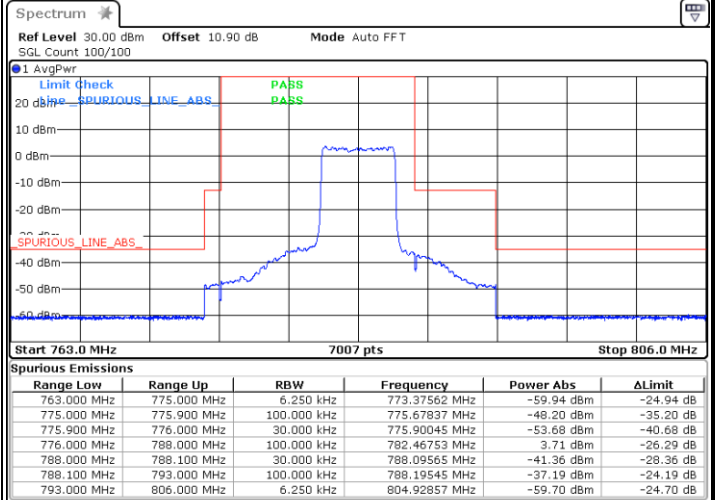
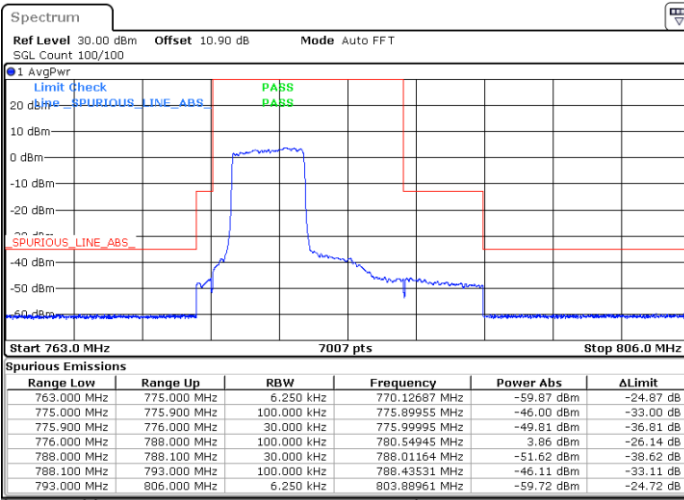

Date: 15.NOV.2021 20:22:59

Date: 15.NOV.2021 21:05:01



LTE Band 13 / 10MHz / QPSK

Lowest Band Edge / 1 RB

Highest Band Edge / 1 RB

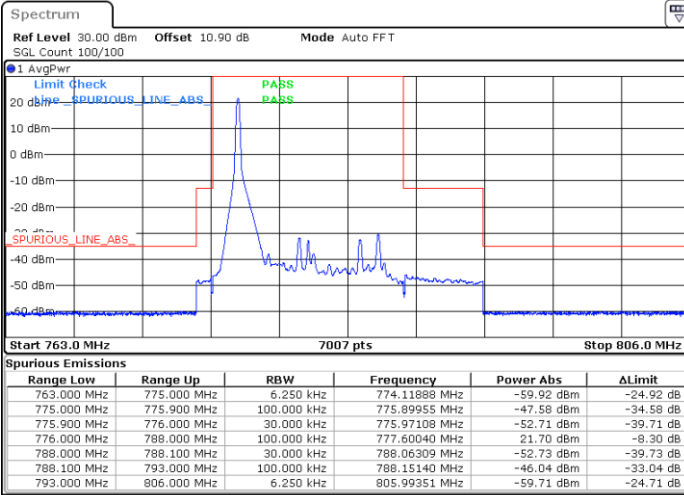

Date: 15.NOV.2021 20:03:01

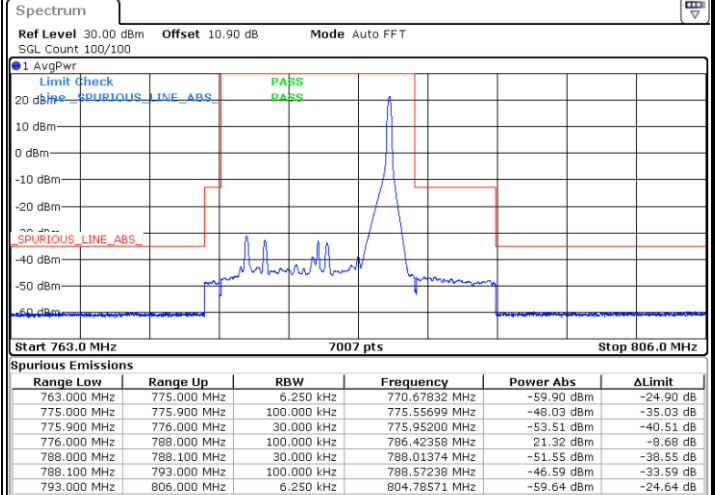

Date: 15.NOV.2021 20:04:51

Band Edge / Full RB

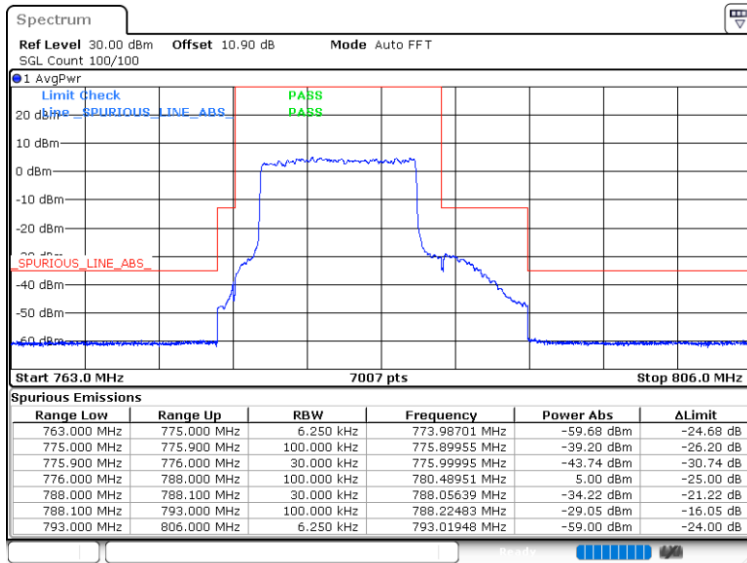

Date: 15.NOV.2021 19:57:31



LTE Band 13 / 10MHz / 16QAM

Lowest Band Edge / 1 RB

Highest Band Edge / 1 RB

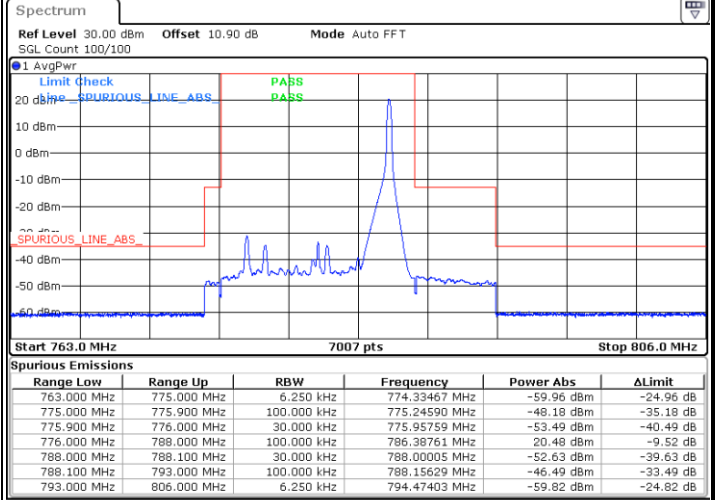
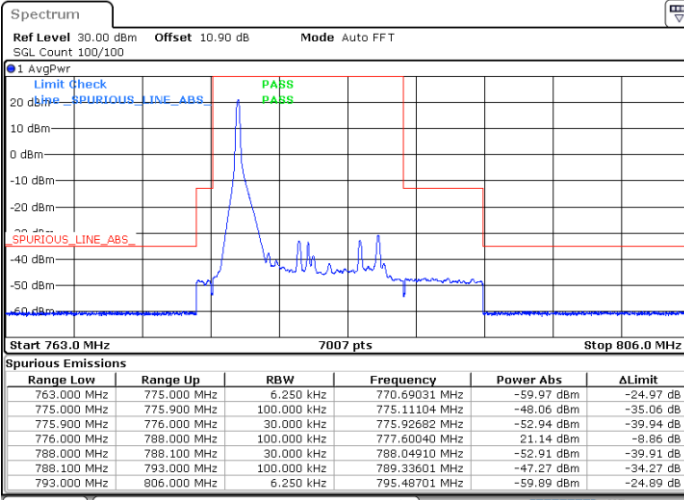

Date: 15.NOV.2021 20:01:11

Date: 15.NOV.2021 20:06:40

Band Edge / Full RB

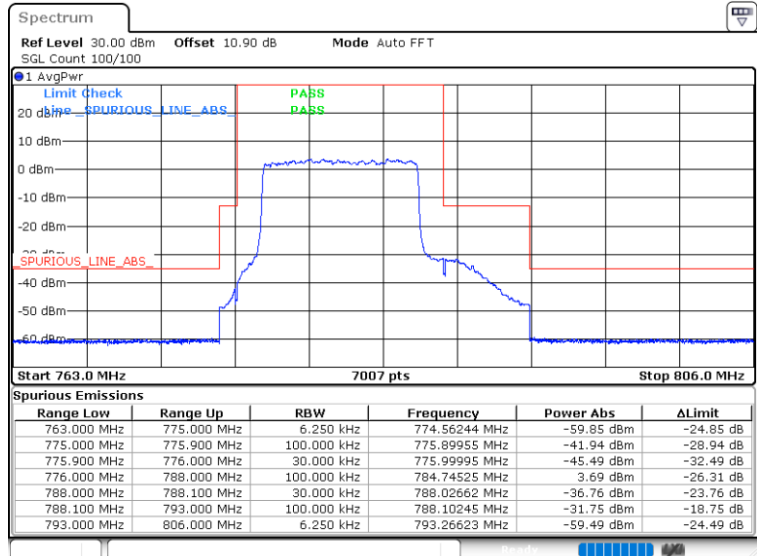

Date: 15.NOV.2021 19:59:21



LTE Band 13 / 10MHz / 64QAM

Lowest Band Edge / 1 RB

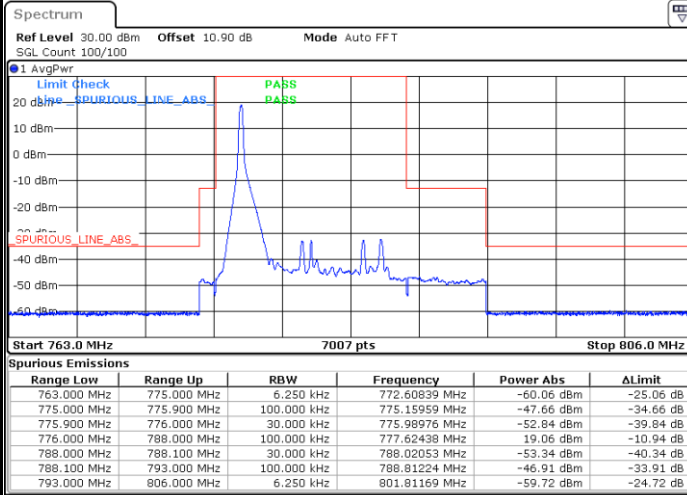

Date: 15.NOV.2021 20:11:52

Highest Band Edge / 1 RB

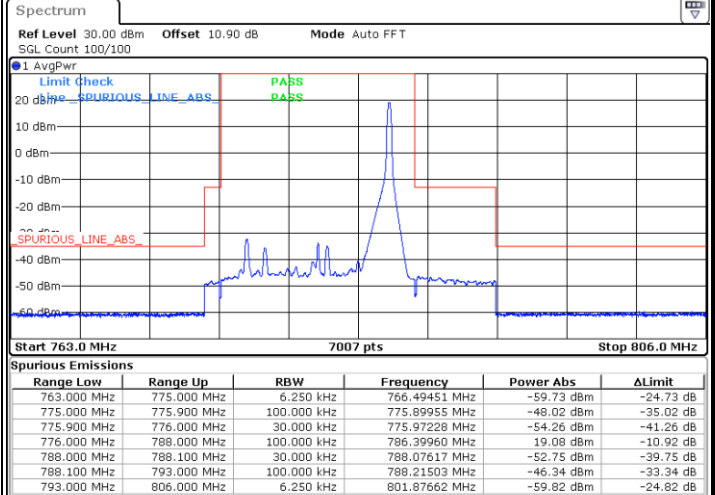

Date: 15.NOV.2021 20:13:41

Band Edge / Full RB

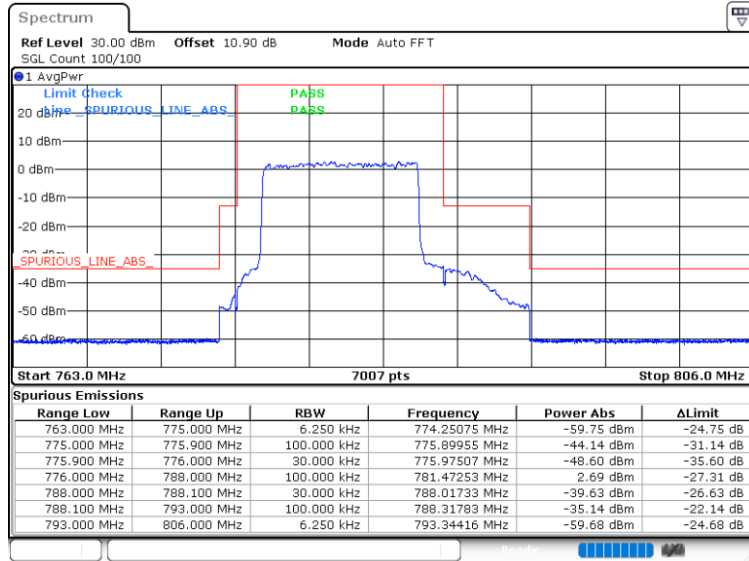

Date: 15.NOV.2021 20:10:02



LTE Band 13 / 10MHz / 256QAM

Lowest Band Edge / 1 RB

Highest Band Edge / 1 RB

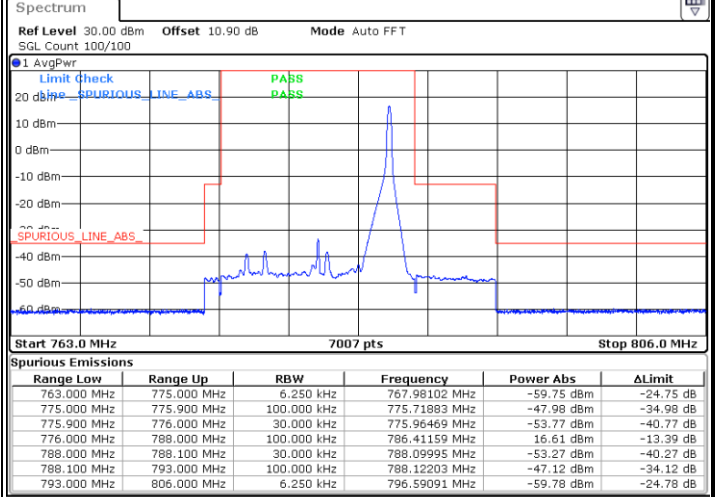
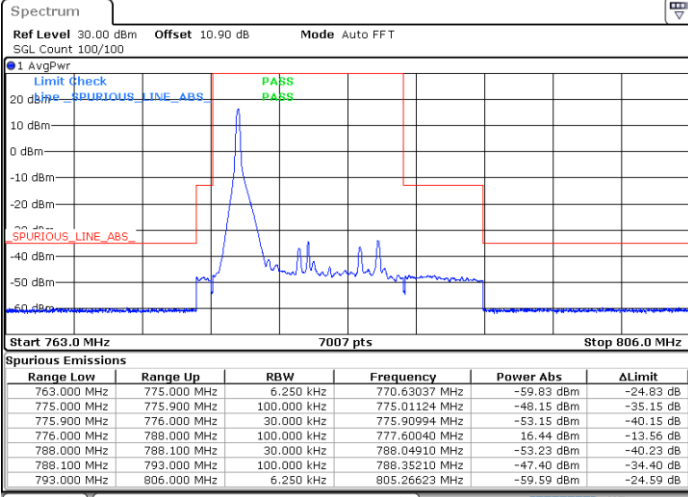

Date: 15.NOV.2021 20:58:43

Date: 15.NOV.2021 20:48:48

Band Edge / Full RB

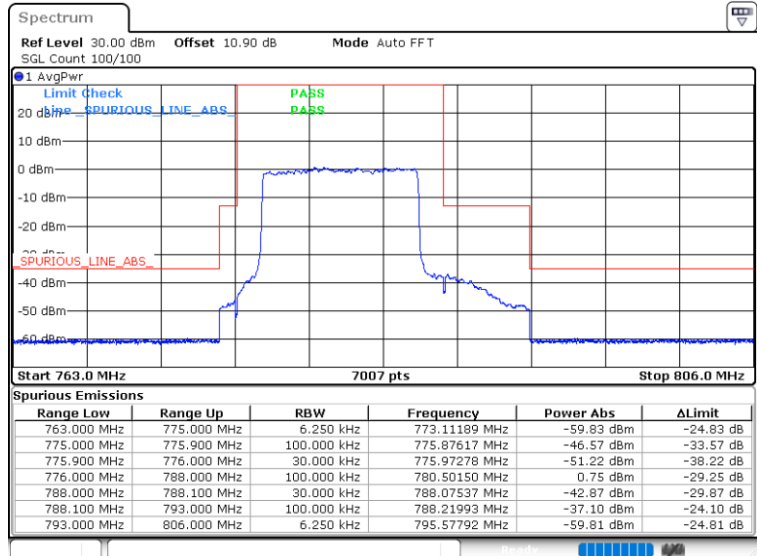

Date: 15.NOV.2021 20:45:08



Conducted Spurious Emission

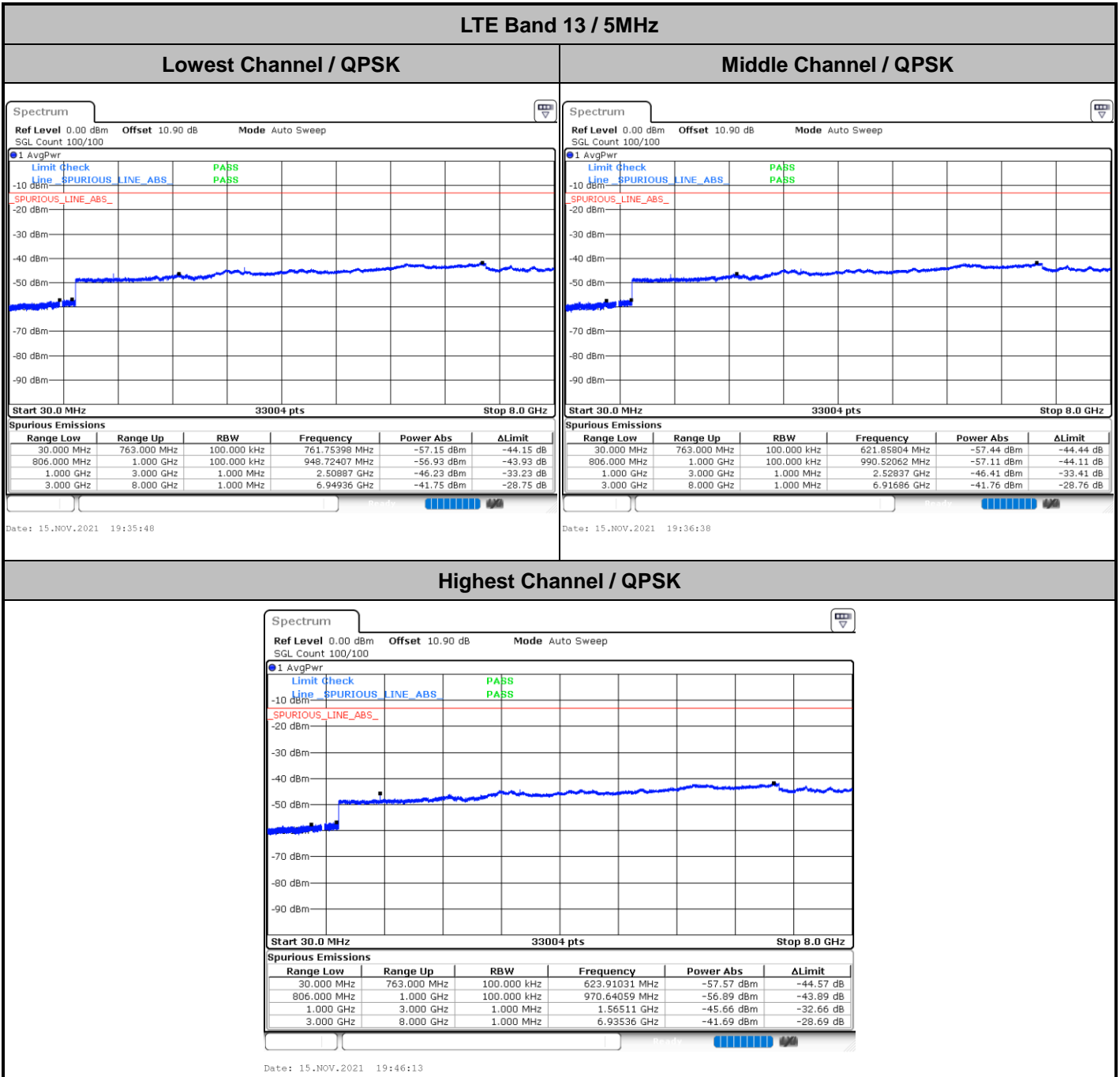



LTE Band 13 / 10MHz

Middle Channel / QPSK

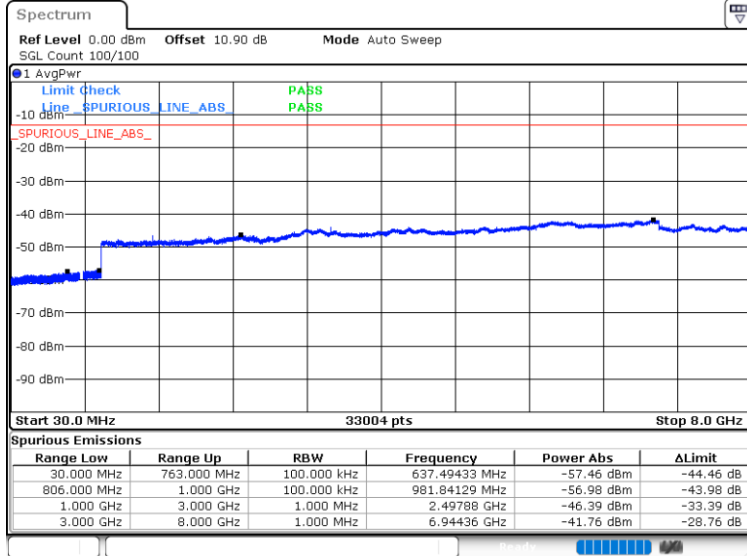

Date: 15.NOV.2021 20:07:30



Frequency Stability

Test Conditions		LTE Band 13 (QPSK) / Middle Channel	Limit
Temperature (°C)	Voltage (Volt)	BW 10MHz	Note 2.
		Deviation (ppm)	Result
50	Normal Voltage	0.0017	PASS
40	Normal Voltage	0.0014	
30	Normal Voltage	0.0096	
20(Ref.)	Normal Voltage	0.0000	
10	Normal Voltage	0.0001	
0	Normal Voltage	0.0059	
-10	Normal Voltage	0.0086	
-20	Normal Voltage	0.0040	
-30	Normal Voltage	0.0024	
20	Maximum Voltage	0.0111	
20	Normal Voltage	0.0000	
20	Battery End Point	0.0047	

Note:

- 1. Normal Voltage =3.8 V. ; Battery End Point (BEP) =3.4 V. ; Maximum Voltage =4.3 V.
- 2. The frequency fundamental emissions stay within the authorized frequency block.



Appendix B. Test Results of Radiated Test

<Ant. 0>

LTE Band 13

LTE Band 13 / 5MHz / QPSK									
Channel	Frequency (MHz)	ERP (dBm)	Limit (dBm)	Over Limit (dB)	SPA Reading (dBm)	S.G. Power (dBm)	TX Cable loss (dB)	TX Antenna Gain (dBi)	Polarization (H/V)
Lowest	1552	-60.21	-13	-47.21	-71.18	-62.28	0.94	5.15	H
	2336	-59.96	-13	-46.96	-76.47	-61.48	1.24	4.91	H
	3112	-58.67	-13	-45.67	-77.07	-61.33	1.48	6.29	H
									H
									H
									H
	1552	-60.16	-13.00	-47.16	-71.60	-62.23	0.94	5.15	V
	2336	-57.95	-13	-44.95	-75.00	-59.47	1.24	4.91	V
	3112	-56.86	-13	-43.86	-76.01	-59.52	1.48	6.29	V
									V
									V
									V
Middle	1560	-57.54	-42.15	-15.39	-68.69	-59.58	0.94	5.13	H
	2336	-60.34	-13	-47.34	-76.94	-61.86	1.24	4.91	H
	3120	-58.86	-13	-45.86	-77.36	-61.55	1.49	6.33	H
									H
									H
	1560	-60.24	-42.15	-18.09	-71.68	-62.28	0.94	5.13	V
	2336	-59.82	-13	-46.82	-76.78	-61.34	1.24	4.91	V
	3120	-57.94	-13	-44.94	-77.19	-60.63	1.49	6.33	V
									V
									V



Highest	1568	-61.66	-42.15	-19.51	-72.85	-63.68	0.94	5.11	H
	2344	-58.57	-13	-45.57	-75.20	-60.11	1.24	4.93	H
	3128	-57.62	-13	-44.62	-76.17	-60.35	1.49	6.36	H
									H
									H
									H
	1568	-60.77	-42.15	-18.62	-72.46	-62.79	0.94	5.11	V
	2344	-57.78	-13	-44.78	-74.75	-59.32	1.24	4.93	V
	3128	-57.29	-13	-44.29	-76.49	-60.02	1.49	6.36	V
									V
									V
									V

Remark: Spurious emissions within 30-1000MHz were found more than 20dB below limit line.



LTE Band 13 / 10MHz / QPSK										
Channel	Frequency (MHz)	ERP (dBm)	Limit (dBm)	Over Limit (dB)	SPA Reading (dBm)	S.G. Power (dBm)	TX Cable loss (dB)	TX Antenna Gain (dBi)	Polarization (H/V)	
Middle	1552	-60.02	-13	-47.02	-71.08	-62.09	0.94	5.15	H	
	2328	-60.07	-13	-47.07	-76.72	-61.57	1.24	4.88	H	
	3112	-58.79	-13	-45.79	-77.2	-61.45	1.48	6.29	H	
									H	
									H	
									H	
	1552	-60.01	-13	-47.01	-47.01	-71.57	-62.08	0.94	5.15	V
	2328	-59.85	-13	-46.85	-46.85	-76.72	-61.35	1.24	4.88	V
	3112	-56.72	-13	-43.72	-43.72	-75.95	-59.38	1.48	6.29	V
										V
										V
										V

Remark: Spurious emissions within 30-1000MHz were found more than 20dB below limit line.



<Ant. 3>

LTE Band 13

LTE Band 13 / 5MHz / QPSK									
Channel	Frequency (MHz)	ERP (dBm)	Limit (dBm)	Over Limit (dB)	SPA Reading (dBm)	S.G. Power (dBm)	TX Cable loss (dB)	TX Antenna Gain (dBi)	Polarization (H/V)
Lowest	1552	-50.43	-13	-37.43	-61.40	-52.50	0.94	5.15	H
	2336	-58.28	-13	-45.28	-74.57	-59.80	1.24	4.91	H
	3112	-58.74	-13	-45.74	-76.70	-61.40	1.48	6.29	H
									H
									H
									H
	1552	-50.03	-13.00	-37.03	-62.29	-52.10	0.94	5.15	V
	2336	-56.98	-13	-43.98	-73.66	-58.50	1.24	4.91	V
	3112	-57.94	-13	-44.94	-77.01	-60.60	1.48	6.29	V
									V
									V
									V
Middle	1560	-49.54	-42.15	-7.39	-60.30	-51.58	0.94	5.13	H
	2336	-57.58	-13	-44.58	-73.84	-59.10	1.24	4.91	H
	3120	-58.71	-13	-45.71	-76.88	-61.40	1.49	6.33	H
									H
									H
									H
	1560	-49.46	-42.15	-7.31	-60.65	-51.50	0.94	5.13	V
	2336	-57.98	-13	-44.98	-74.42	-59.50	1.24	4.91	V
	3120	-58.31	-13	-45.31	-76.86	-61.00	1.49	6.33	V
									V
									V
									V



Highest	1568	-48.78	-42.15	-6.63	-59.65	-50.80	0.94	5.11	H
	2344	-57.66	-13	-44.66	-74.18	-59.20	1.24	4.93	H
	3128	-58.67	-13	-45.67	-76.87	-61.40	1.49	6.36	H
									H
									H
									H
	1568	-49.08	-42.15	-6.93	-60.51	-51.10	0.94	5.11	V
	2344	-56.76	-13	-43.76	-73.70	-58.30	1.24	4.93	V
	3128	-58.07	-13	-45.07	-76.91	-60.80	1.49	6.36	V
									V
									V
									V

Remark:

- 1. Spurious emissions within 30-1000MHz were found more than 20dB below limit line.
- 2. The Ant. 3 test combination is EN-DC LTE B13 +5G NR n5.



LTE Band 13 / 10MHz / QPSK									
Channel	Frequency (MHz)	ERP (dBm)	Limit (dBm)	Over Limit (dB)	SPA Reading (dBm)	S.G. Power (dBm)	TX Cable loss (dB)	TX Antenna Gain (dBi)	Polarization (H/V)
Middle	1552	-50.33	-13	-37.33	-61.24	-52.4	0.94	5.15	H
	2336	-57.78	-13	-44.78	-74.03	-59.3	1.24	4.91	H
	3108	-58.96	-13	-45.96	-76.93	-61.6	1.48	6.28	H
									H
									H
									H
									H
	1552	-50.43	-13	-37.43	-61.66	-52.5	0.94	5.15	V
	2336	-57.78	-13	-44.78	-74.61	-59.3	1.24	4.91	V
	3108	-58.66	-13	-45.66	-77.19	-61.3	1.48	6.28	V
									V
									V
									V
									V

Remark:

1. Spurious emissions within 30-1000MHz were found more than 20dB below limit line.
2. The Ant. 3 test combination is EN-DC LTE B13 +5G NR n5.