

# FCC RADIO TEST REPORT

according to

47 CFR FCC Part 15 Subpart C § 15.247

**Equipment** : Skylight slate  
**Model No.** : 20082/4386  
**Brand Name** : Lenovo  
**Filing Type** : New Application  
**Applicant** : **Compal Electronics, Inc.**  
No.581, Ruiguang Rd., Neihu District,  
Taipei City 11492, Taiwan.  
**FCC ID** : **GKRPQXU1WB**  
**Manufacturer** : **Compal Electronics, Inc.**  
No.581, Ruiguang Rd., Neihu District,  
Taipei City 11492, Taiwan.  
**Received Date** : Dec. 23, 2010  
**Final Test Date** : Dec. 31, 2010

## Statement

**Test result included is only for the 802.11b/g/n part of the product.**

The test result in this report refers exclusively to the presented test model / sample.

Without written approval of SPORTON International Inc., the test report shall not be reproduced except in full.

The measurements and test results shown in this test report were made in accordance with the procedures and found in compliance with the limit given in **ANSI C63.4-2003** and **47 CFR FCC Part 15 Subpart C**.

The test equipment used to perform the test is calibrated and traceable to NML/ROC.



***SPORTON International Inc.***

No. 52 Hwa Ya 1<sup>st</sup> Rd., Hwa Ya Technology Park, Kwei-Shan Hsiang, Tao Yuan Hsien, Taiwan, R.O.C.

**Table of Contents**

**1 SUMMARY OF THE TEST RESULT ..... 2**

**2 GENERAL INFORMATION..... 3**

2.1 Product Details ..... 3

2.2 Accessories ..... 3

2.3 Table for Filed Antenna ..... 3

2.4 Table for Carrier Frequencies ..... 3

2.5 Table for Test Modes ..... 4

2.6 Table for Testing Locations ..... 4

2.7 Table for Supporting Units..... 5

2.8 Table for Parameters of Test Software Setting ..... 5

2.9 EUT Operation during Test ..... 5

2.10 Test Configuration ..... 6

**3 TEST RESULT ..... 8**

3.1 AC Power Line Conducted Emissions Measurement..... 8

3.2 Peak Output Power Measurement ..... 14

3.3 Test Procedures ..... 14

3.4 Power Spectral Density Measurement ..... 16

3.5 6dB Spectrum Bandwidth Measurement..... 24

3.6 Radiated Emissions Measurement..... 32

3.7 Band Edge and Fundamental Emissions Measurement ..... 56

3.8 Antenna Requirements..... 63

**4 LIST OF MEASURING EQUIPMENTS ..... 64**

**5 TEST LOCATION..... 65**

**6 TAF CERTIFICATE OF ACCREDITATION ..... 66**

**APPENDIX A. TEST PHOTOS ..... A1 ~ A7**

**APPENDIX B. PHOTOGRAPHS OF EUT ..... B1 ~ B25**

### History of This Test Report

Original Issue Date: Jan. 07, 2011

Report No.: FR0D1630AN

No additional attachment.

Additional attachment were issued as following record:

Attachment No.	Issue Date	Description

# CERTIFICATE OF COMPLIANCE

according to

47 CFR FCC Part 15 Subpart C § 15.247

Equipment : Skylight slate  
Model No. : 20082/4386  
Brand Name : Lenovo  
Applicant : Compal Electronics, Inc.  
No.581, Ruiguang Rd., Neihu District,  
Taipei City 11492, Taiwan.

Sporton International as requested by the applicant to evaluate the EMC performance of the product sample received on Dec. 23, 2010 would like to declare that the tested sample has been evaluated and found to be in compliance with the tested rule parts. The data recorded as well as the test configuration specified is true and accurate for showing the sample's EMC nature.



Wayne Hsu / Vice Manager

**SPORTON International Inc.**

No. 52 Hwa Ya 1<sup>st</sup> Rd., Hwa Ya Technology Park, Kwei-Shan Hsiang, Tao Yuan Hsien, Taiwan, R.O.C.

**1 SUMMARY OF THE TEST RESULT**

<b>Applied Standard: 47 CFR FCC Part 15 Subpart C</b>				
<b>Part</b>	<b>Rule Section</b>	<b>Description of Test</b>	<b>Result</b>	<b>Under Limit</b>
3.1	15.207	AC Power Line Conducted Emissions	Complies	4.14 dB
3.2	15.247(b)(3)	Peak Output Power	Complies	7.79 dB
3.3	15.247(e)	Power Spectral Density	Complies	12.98 dB
3.4	15.247(a)(2)	6dB Spectrum Bandwidth	Complies	-
3.5	15.247(d)	Radiated Emissions	Complies	3.42 dB
3.6	15.247(d)	Band Edge Emissions	Complies	1.16 dB
3.7	15.203	Antenna Requirements	Complies	-

<b>Test Items</b>	<b>Uncertainty</b>	<b>Remark</b>
AC Power Line Conducted Emissions	±2.3dB	Confidence levels of 95%
Peak Output Power	±0.8dB	Confidence levels of 95%
Power Spectral Density	±0.5dB	Confidence levels of 95%
6dB Spectrum Bandwidth	±8.5×10 <sup>-8</sup>	Confidence levels of 95%
Radiated Emissions (9kHz~30MHz)	±0.8dB	Confidence levels of 95%
Radiated Emissions (30MHz~1000MHz)	±1.9dB	Confidence levels of 95%
Radiated / Band Edge Emissions (1GHz~18GHz)	±1.9dB	Confidence levels of 95%
Radiated Emissions (18GHz~40GHz)	±1.9dB	Confidence levels of 95%
Temperature	±0.7°C	Confidence levels of 95%
Humidity	±3.2%	Confidence levels of 95%
DC / AC Power Source	±1.4%	Confidence levels of 95%

## 2 GENERAL INFORMATION

### 2.1 Product Details

Only the radio detail of IEEE 802.11b/g/n is shown in this report. For more detailed features description, please refer to the manufacturer's specifications or user's manual.

Items	Description
Power Type	12V from Adapter ; 7.4Vdc from Li-ion Battery
Modulation	DSSS for IEEE 802.11b ; OFDM for IEEE 802.11g/n
Data Modulation	DSSS (DBPSK / DQPSK / CCK) ; OFDM (BPSK / QPSK / 16QAM / 64QAM) See the below table for IEEE 802.11n
Data Rate (Mbps)	DSSS (1/ 2/ 5.5/11) ; OFDM (6/9/12/18/24/36/48/54)
Frequency Range	2400 ~ 2483.5MHz
Channel Number	11b/g/n: 11
Channel Band Width (99%)	11b: 14.07 MHz ; 11g: 16.38 MHz ; MCS 0 (20MHz) : 17.56 MHz
Conducted Output Power	11b: 19.79 dBm ; 11g: 22.21 dBm ; MCS 0 (20MHz) : 21.17 dBm

### 2.2 Accessories

Power	Brand	Model	Rating
AC Adaptor	DELTA	EADP-18SB AA	INPUT : 100-240V ~ 50/60Hz 0.4A OUTPUT : +12V 1.5A
Li-ion Battery	lenovo	L10M2121	DC7.4V 27Wh

### 2.3 Table for Filed Antenna

Ant.	Antenna Type	Connector	Gain (dBi)	Remark
A	Printed Antenna	U.FL	0.63	TX / RX

Note: 1T1R Spatial Multiplexing MIMO configuration.

### 2.4 Table for Carrier Frequencies

#### Frequency Allocation for 802.11b/g/n

Frequency Band	Channel No.	Frequency	Channel No.	Frequency
2400~2483.5MHz	1	2412 MHz	7	2442 MHz
	2	2417 MHz	8	2447 MHz
	3	2422 MHz	9	2452 MHz
	4	2427 MHz	10	2457 MHz
	5	2432 MHz	11	2462 MHz
	6	2437 MHz	-	-

IEEE 802.11n Modulation Scheme

MCS Index	Nss	Modulation	R	NBPS	NCBPS		NDBPS		Data rate(Mbps)
					20MHz		20MHz		800nsGI
					20MHz		20MHz		20MHz
0	1	BPSK	1/2	1	52	26	26	26	6.5
1	1	QPSK	1/2	2	104	52	52	52	13.0
2	1	QPSK	3/4	2	104	78	78	78	19.5
3	1	16-QAM	1/2	4	208	104	104	104	26.0
4	1	16-QAM	3/4	4	208	156	156	156	39.0
5	1	64-QAM	2/3	6	312	208	208	208	52.0
6	1	64-QAM	3/4	6	312	234	234	234	58.5
7	1	64-QAM	5/6	6	312	260	260	260	65.0

Symbol	Explanation
NSS	Number of spatial streams
R	Code rate
NBPS	Number of coded bits per single carrier
NCBPS	Number of coded bits per symbol
NDBPS	Number of data bits per symbol
GI	guard interval

2.5 Table for Test Modes

Preliminary tests were performed in different data rate to find the worst radiated emission. The data rate shown in the table below is the worst-case rate with respect to the specific test item. Investigation has been done on the entire possible configuration for searching the worst cases. The following table is a list of the test modes shown in this test report.

Test Items	Mode	Data Rate	Channel
AC Power Line Conducted Emissions	Adapter Mode / Charger Mode	Auto	-
Peak Output Power	11b/CCK	11 Mbps	1/6/11
Power Spectral Density	11g/BPSK	6 Mbps	1/6/11
6dB Spectrum Bandwidth	MCS 0 (20MHz)	6.5 Mbps	1/6/11
Radiated Emissions Above 1GHz			
Radiated Emissions 9kHz~1GHz	Normal Mode	Auto	-
Fundamental Emissions	11b/CCK	11 Mbps	1/6/11
	11g/BPSK	6 Mbps	1/6/11
	MCS 0 (20MHz)	6.5 Mbps	1/6/11
Band Edge Emissions	11b/CCK	11 Mbps	1/11
	11g/BPSK	6 Mbps	1/11
	MCS 0 (20MHz)	6.5 Mbps	1/11

2.6 Table for Testing Locations

Test Site No.	Site Category	Location
CO04-HY	Conduction	Hwa Ya
TH01-HY	OVEN Room	Hwa Ya
03CH03-HY	SAC	Hwa Ya

Semi Anechoic Chamber (SAC).

**2.7 Table for Supporting Units**

Support Unit	Brand	Model	FCC ID
Notebook	LENOVO	Z560	DoC

**2.8 Table for Parameters of Test Software Setting**

During testing, Channel & Power Controlling Software provided by the customer was used to control the operating channel as well as the output power level. The RF output power selection is for the setting of RF output power expected by the customer and is going to be fixed on the firmware of the final end product.

**Power Parameters of IEEE 802.11b/g/n**

Test Software Version	DOS		
Frequency	2412 MHz	2437 MHz	2462 MHz
IEEE 802.11b	19	19	19
IEEE 802.11g	15	15	15
IEEE 802.11n(20MHz)	13	13	12

**2.9 EUT Operation during Test**

**Conducted**

An executive program, "EMCTEST.EXE" under Linux, which generates a complete line of continuously repeating "H" pattern was used as the test software.

The program was executed as follows :

- a. Turn on the power of all equipment.
- b. The NB reads the test program from the hard disk drive and runs it.
- c. The NB sends "H" messages to the panel and displays "H" patterns on the screen.
- d. The NB sends signal messages to the modem.
- e. Repeat the steps from b to d.

**Radiated Emissions:**

- Executed "DOS" to keep transmitting signals at fixed frequency.



**2.10 Test Configuration**

**2.10.1 Radiation Emissions Test Configuration**

**For radiated emissions 9kHz~1GHz**

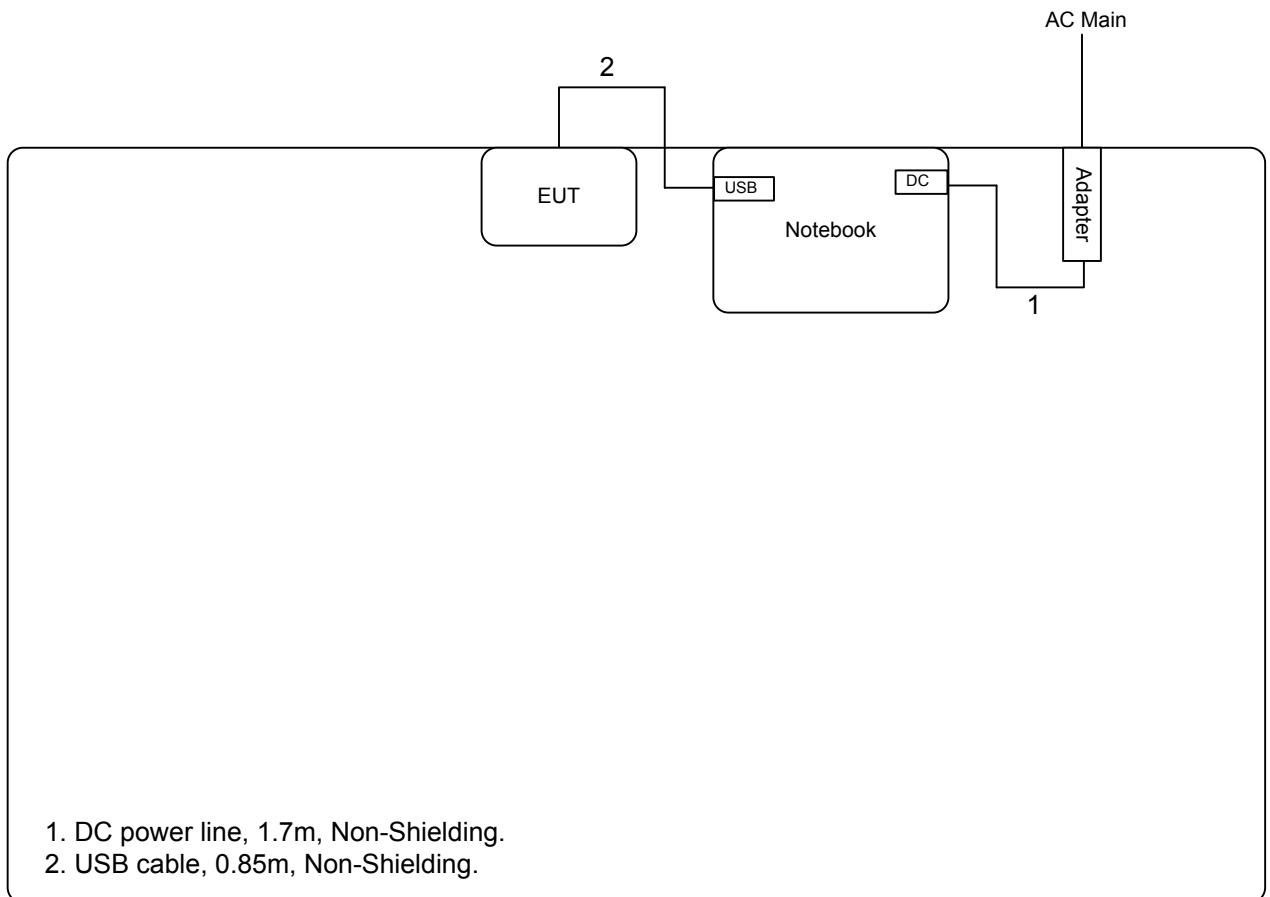

**For radiated emissions above 1GHz**

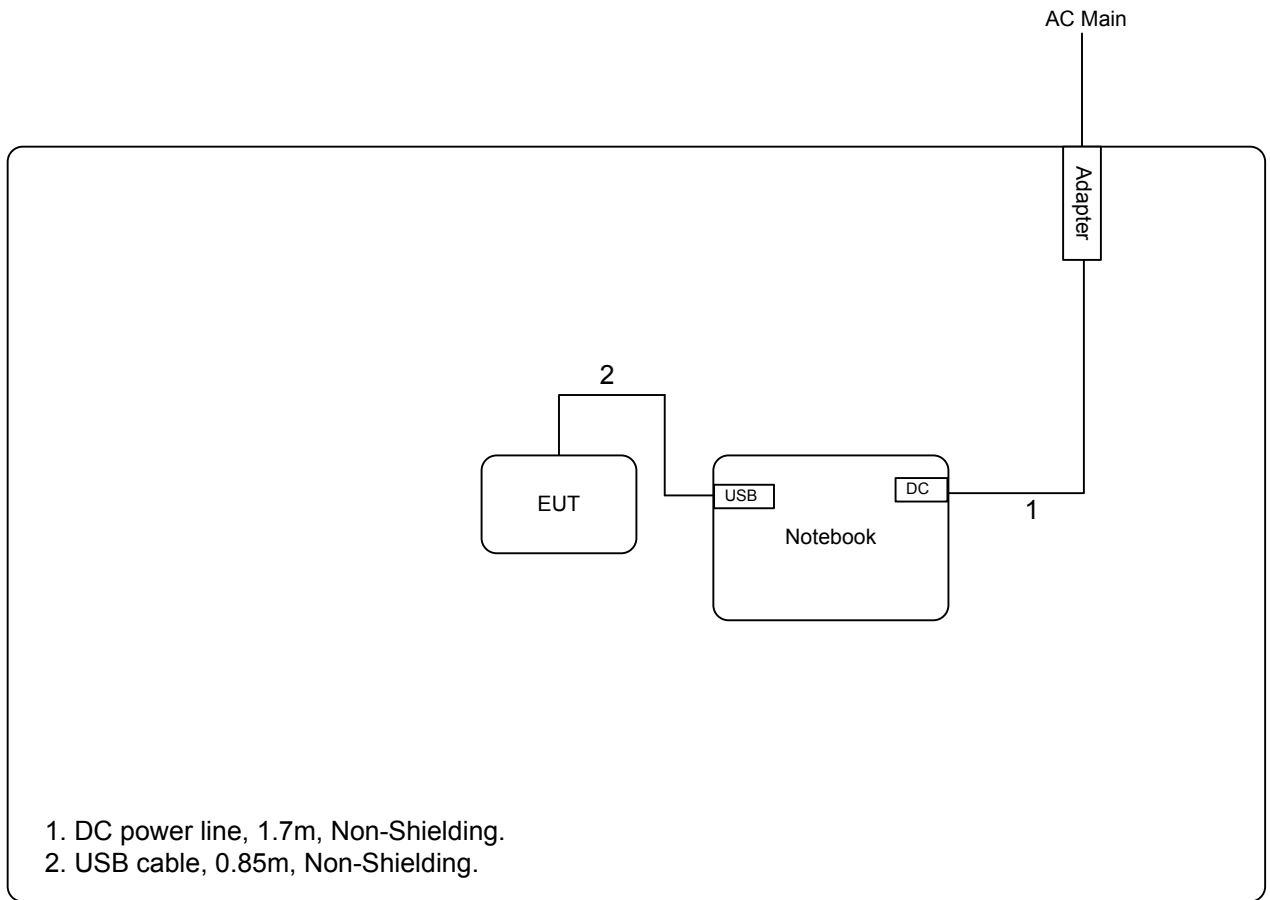

### 3 TEST RESULT

#### 3.1 AC Power Line Conducted Emissions Measurement

##### 3.1.1 Limit

For this product which is designed to be connected to the AC power line, the radio frequency voltage that is conducted back onto the AC power line on any frequency or frequencies within the band 150 kHz to 30 MHz shall not exceed below limits table.

**Class B**

Frequency (MHz)	QP Limit (dBuV)	AV Limit (dBuV)
0.15~0.5	66~56	56~46
0.5~5	56	46
5~30	60	50

##### 3.1.2 Measuring Instruments and Setting

Please refer to section 4 of equipments list in this report. The following table is the setting of the receiver.

Receiver Parameters	Setting
Attenuation	10 dB
Start Frequency	0.15 MHz
Stop Frequency	30 MHz
IF Bandwidth	9 KHz

##### 3.1.3 Test Procedures

1. The EUT warm up about 15 minutes then start test.
2. Configure the EUT according to ANSI C63.4. The EUT or host of EUT has to be placed 0.4 meter far from the conducting wall of the shielding room and at least 80 centimeters from any other grounded conducting surface.
3. Connect EUT or host of EUT to the power mains through a line impedance stabilization network (LISN).
4. All the support units are connected to the other LISNs. The LISN should provide 50uH/50ohms coupling impedance.
5. The frequency range from 150 KHz to 30 MHz was searched.
6. Set the test-receiver system to Peak Detect Function and Specified Bandwidth with Maximum Hold Mode.
7. The measurement has to be done between each power line and ground at the power terminal.

3.1.4 Test Setup Layout

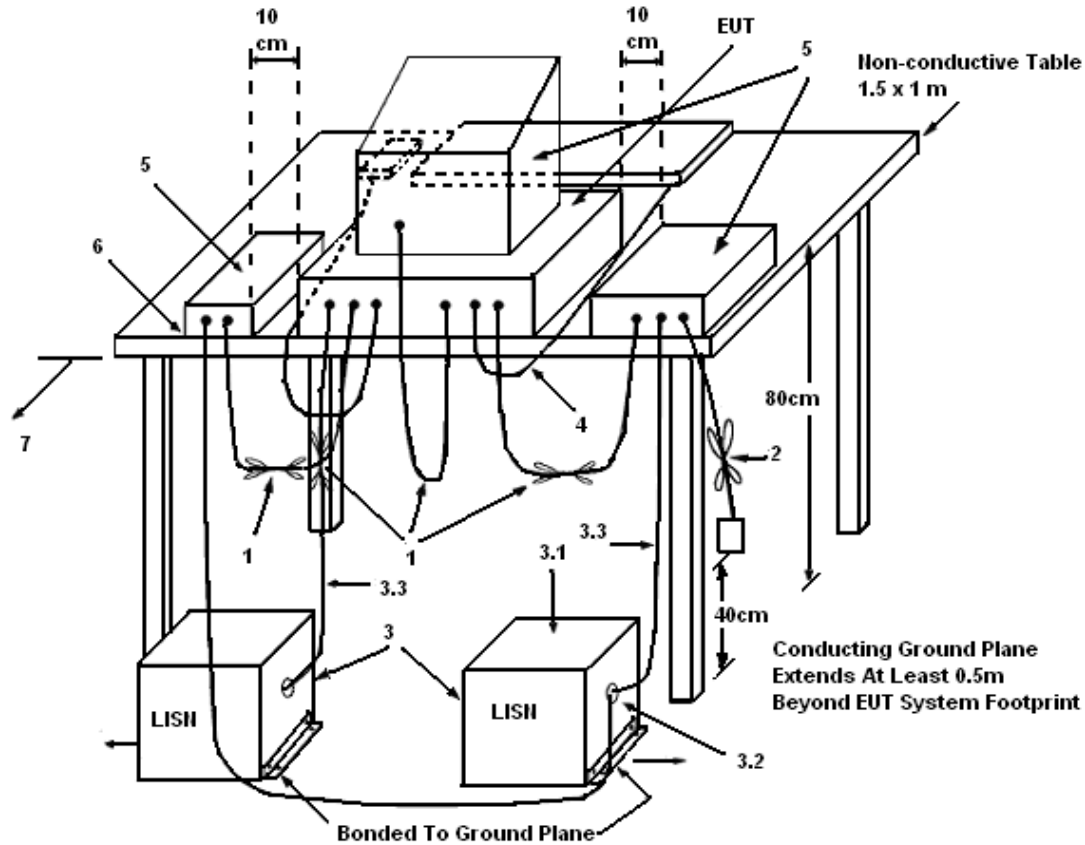

LEGEND:

- (1) Interconnecting cables that hang closer than 40 cm to the ground plane shall be folded back and forth in the center forming a bundle 30 to 40 cm long.
- (2) I/O cables that are not connected to a peripheral shall be bundled in the center. The end of the cable may be terminated, if required, using the correct terminating impedance. The overall length shall not exceed 1 m.
- (3) EUT connected to one LISN. Unused LISN measuring port connectors shall be terminated in 50 Ω. LISN can be placed on top of, or immediately beneath, reference ground plane.
- (3.1) All other equipment powered from additional LISN(s).
- (3.2) Multiple outlet strip can be used for multiple power cords of non-EUT equipment.
- (3.3) LISN at least 80 cm from nearest part of EUT chassis.
- (4) Cables of hand-operated devices, such as keyboards, mice, etc., shall be placed as for normal use.
- (5) Non-EUT components of EUT system being tested.
- (6) Rear of EUT, including peripherals, shall all be aligned and flush with rear of tabletop.
- (7) Rear of tabletop shall be 40 cm removed from a vertical conducting plane that is bonded to the ground plane.

3.1.5 Test Deviation

There is no deviation with the original standard.

3.1.6 EUT Operation during Test

The EUT was placed on the test table and programmed in normal function.

**3.1.7 Results of AC Power Line Conducted Emissions Measurement**

<b>Final Test Date</b>	Dec. 31, 2010	<b>Test Site No.</b>	CO04-HY
<b>Temperature</b>	20.1°C	<b>Humidity</b>	50.2%
<b>Test Engineer</b>	Jason	<b>Configuration</b>	Adapter Mode

*Line*

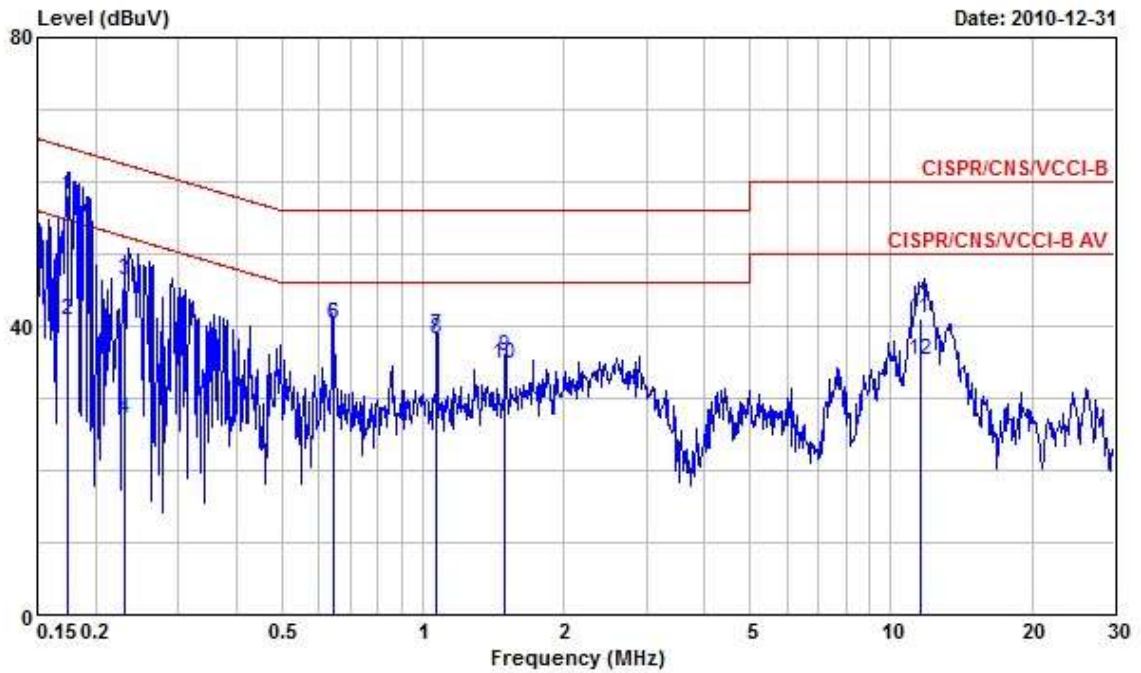

	Freq	Level	Over Limit	Limit Line	Read Level	LISN Factor	Cable Loss	Remark
	MHz	dBuV	dB	dBuV	dBuV	dB	dB	
1	0.1749130	58.21	-6.51	64.72	58.05	0.08	0.08	QP
2	0.1749130	40.87	-13.85	54.72	40.71	0.08	0.08	Average
3	0.2303310	46.42	-16.02	62.44	46.26	0.08	0.08	QP
4	0.2303310	27.19	-25.25	52.44	27.03	0.08	0.08	Average
5	0.6425800	40.32	-15.68	56.00	40.17	0.10	0.05	QP
6	0.6425800	40.16	-5.84	46.00	40.01	0.10	0.05	Average
7	1.071	38.56	-17.44	56.00	38.35	0.11	0.10	QP
8	1.071	38.20	-7.80	46.00	37.99	0.11	0.10	Average
9	1.500	35.75	-20.25	56.00	35.53	0.12	0.10	QP
10	1.500	34.62	-11.38	46.00	34.40	0.12	0.10	Average
11	11.536	41.05	-18.95	60.00	40.59	0.29	0.17	QP
12	11.536	35.35	-14.65	50.00	34.89	0.29	0.17	Average

Neutral

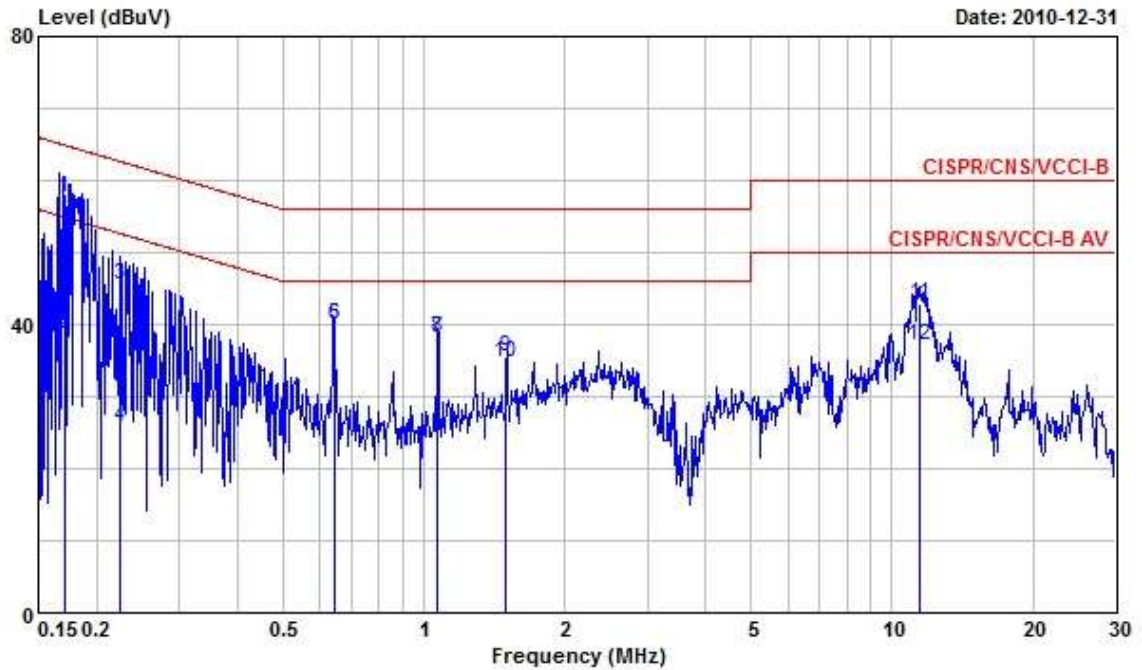

	Freq	Level	Over	Limit	Read	LISN	Cable	Remark
	MHz	dBuV	Limit	Line	Level	Factor	Loss	
			dB	dBuV	dBuV	dB	dB	
1	0.1701680	57.54	-7.41	64.95	57.38	0.08	0.08	QP
2	0.1701680	38.58	-16.37	54.95	38.42	0.08	0.08	Average
3	0.2236200	45.52	-17.16	62.68	45.36	0.08	0.08	QP
4	0.2236200	25.74	-26.94	52.68	25.58	0.08	0.08	Average
5	0.6434550	39.87	-16.13	56.00	39.73	0.09	0.05	QP
6	0.6434550	39.92	-6.08	46.00	39.78	0.09	0.05	Average
7	1.072	38.20	-17.80	56.00	38.00	0.10	0.10	QP
8	1.072	38.13	-7.87	46.00	37.93	0.10	0.10	Average
9	1.500	35.62	-20.38	56.00	35.41	0.11	0.10	QP
10	1.500	34.61	-11.39	46.00	34.40	0.11	0.10	Average
11	11.500	42.97	-17.03	60.00	42.52	0.28	0.17	QP
12	11.500	37.08	-12.92	50.00	36.63	0.28	0.17	Average

Note:

Level = Read Level + LISN Factor + Cable Loss.

Final Test Date	Dec. 31, 2010	Test Site No.	CO04-HY
Temperature	20.1°C	Humidity	50.2%
Test Engineer	Jason	Configuration	Charger Mode

Line

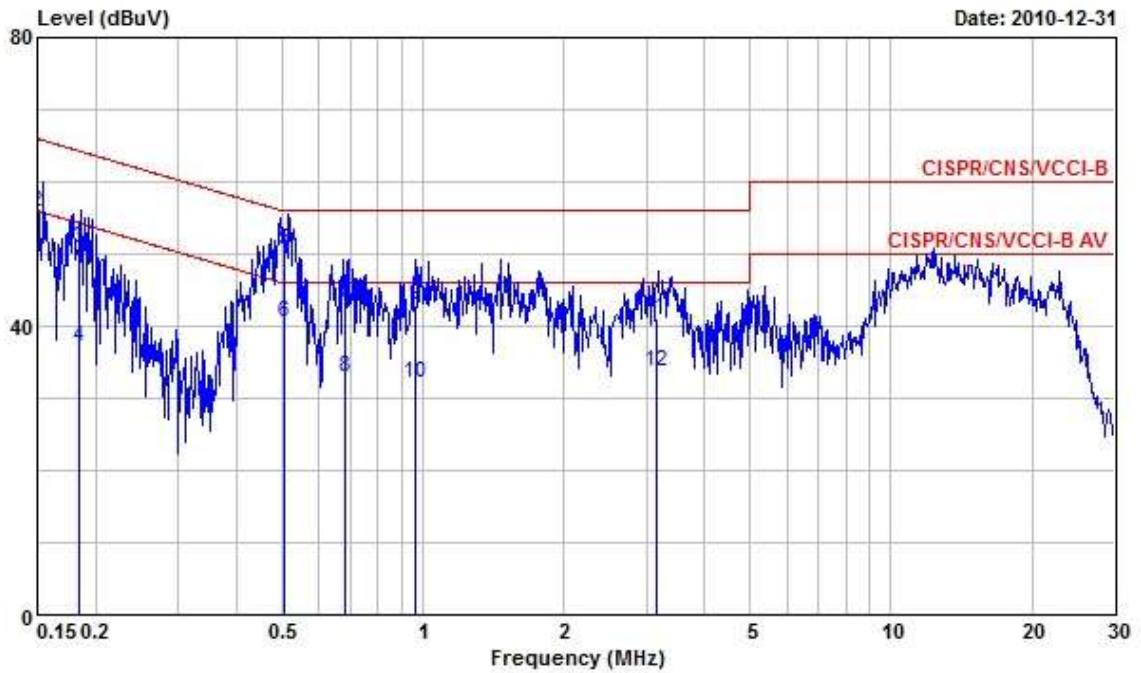

	Freq	Level	Over Limit	Limit Line	Read Level	LISN Factor	Cable Loss	Remark
	MHz	dBuV	dB	dBuV	dBuV	dB	dB	
1	0.1500000	38.15	-17.85	56.00	38.00	0.09	0.06	Average
2	0.1500000	55.75	-10.25	66.00	55.60	0.09	0.06	QP
3	0.1840100	50.90	-13.40	64.30	50.73	0.08	0.09	QP
4	0.1840100	37.23	-17.07	54.30	37.06	0.08	0.09	Average
5	0.5049530	50.49	-5.51	56.00	50.37	0.10	0.02	QP
6	0.5049530	40.49	-5.51	46.00	40.37	0.10	0.02	Average
7	0.6845680	43.27	-12.73	56.00	43.11	0.10	0.06	QP
8	0.6845680	32.90	-13.10	46.00	32.74	0.10	0.06	Average
9	0.9652810	42.99	-13.01	56.00	42.78	0.11	0.10	QP
10	0.9652810	32.05	-13.95	46.00	31.84	0.11	0.10	Average
11	3.142	41.03	-14.97	56.00	40.78	0.15	0.10	QP
12	3.142	33.78	-12.22	46.00	33.53	0.15	0.10	Average



Neutral

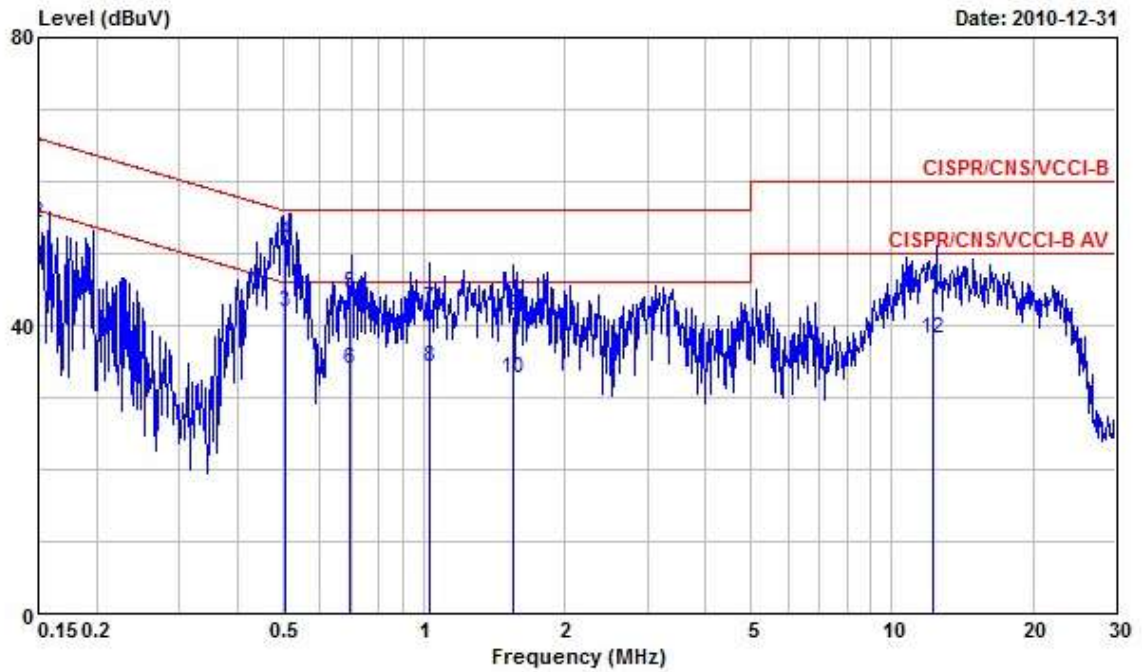

	Freq	Level	Over	Limit	Read	LISN	Cable	Remark
	MHz	dBuV	Limit	Line	Level	Factor	Loss	
			dB	dBuV	dBuV	dB	dB	
1	0.1500000	36.13	-19.87	56.00	35.99	0.08	0.06	Average
2	0.1500000	54.21	-11.79	66.00	54.07	0.08	0.06	QP
3	0.5037790	41.86	-4.14	46.00	41.75	0.09	0.02	Average
4	0.5037790	51.52	-4.48	56.00	51.41	0.09	0.02	QP
5	0.6921560	44.39	-11.61	56.00	44.24	0.09	0.06	QP
6	0.6921560	34.05	-11.95	46.00	33.90	0.09	0.06	Average
7	1.029	42.41	-13.59	56.00	42.21	0.10	0.10	QP
8	1.029	34.27	-11.73	46.00	34.07	0.10	0.10	Average
9	1.549	41.39	-14.61	56.00	41.18	0.11	0.10	QP
10	1.549	32.56	-13.44	46.00	32.35	0.11	0.10	Average
11	12.184	45.32	-14.68	60.00	44.83	0.29	0.20	QP
12	12.184	38.19	-11.81	50.00	37.70	0.29	0.20	Average

Note:

Level = Read Level + LISN Factor + Cable Loss.



**3.2 Peak Output Power Measurement**

**3.2.1 Limit**

For systems using digital modulation in the 2400-2483.5MHz, the limit for peak output power is 30dBm. The limited has to be reduced by the amount in dB that the gain of the antenna exceed 6dBi. In case of point-to-multipoint antenna reduction operation, the limit has to be reduced by 1dB for every dB that the directional gain of the antenna exceeds 6dBi. Systems operating in the 5725-5850 MHz band that are used exclusively for fixed, point-to-point operations may employ transmitting antennas with directional gain greater than 6 dBi without any corresponding reduction in transmitter conducted output power.

**3.2.2 Measuring Instruments and Setting**

Please refer to section 4 of equipments list in this report. The following table is the setting of the power meter.

Power Meter Parameter	Setting
Filter No.	Auto
Measurement time	0.135 s ~ 26 s
Used Peak Sensor	MA2411B

**3.3 Test Procedures**

1. The transmitter output (antenna port) was connected to the power meter.
2. Turn on the EUT and power meter and then record the peak power value.
3. Repeat above procedures on all channels needed to be tested.

**3.3.1 Test Setup Layout**

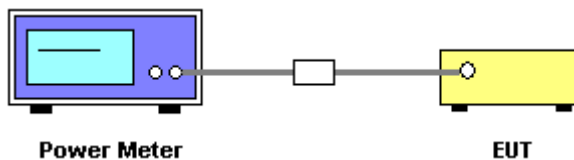

**3.3.2 Test Deviation**

There is no deviation with the original standard.

**3.3.3 EUT Operation during Test**

The EUT was programmed to be in continuously transmitting mode.

**3.3.4 Test Result of Peak Output Power**

<b>Final Test Date</b>	Dec. 24, 2010	<b>Test Site No.</b>	TH01-HY
<b>Temperature</b>	22.5°C	<b>Humidity</b>	63%
<b>Test Engineer</b>	Ian	<b>Configuration</b>	802.11b/g/n

**Configuration IEEE 802.11b**

Channel	Frequency	Conducted Peak Power (dBm)	Max. Limit (dBm)	Result
1	2412 MHz	19.63	30.00	<b>Complies</b>
6	2437 MHz	19.68	30.00	<b>Complies</b>
11	2462 MHz	19.79	30.00	<b>Complies</b>

**Configuration IEEE 802.11g**

Channel	Frequency	Conducted Peak Power (dBm)	Max. Limit (dBm)	Result
1	2412 MHz	21.89	30.00	<b>Complies</b>
6	2437 MHz	22.02	30.00	<b>Complies</b>
11	2462 MHz	22.21	30.00	<b>Complies</b>

**Configuration of IEEE 802.11n (20MHz)**

Channel	Frequency	Conducted Peak Power (dBm)	Max. Limit (dBm)	Result
1	2412 MHz	21.17	30.00	<b>Complies</b>
6	2437 MHz	20.98	30.00	<b>Complies</b>
11	2462 MHz	20.68	30.00	<b>Complies</b>

**3.4 Power Spectral Density Measurement**

**3.4.1 Limit**

For digitally modulated systems, the power spectral density conducted from the intentional radiator to the antenna shall not be greater than 8 dBm in any 3 kHz band during any time interval of continuous transmission.

**3.4.2 Measuring Instruments and Setting**

Please refer to section 4 of equipments list in this report. The following table is the setting of the spectrum analyzer.

Spectrum Parameter	Setting
Attenuation	Auto
Span Frequency	1.5MHz
RB	3 kHz
VB	30 kHz
Detector	Peak
Trace	Max Hold
Sweep Time	500s

**3.4.3 Test Procedures**

1. The transmitter output (antenna port) was connected to the spectrum analyzer.
2. Set RBW of spectrum analyzer to 3 kHz and VBW to 30 kHz. Set Detector to Peak, Trace to Max Hold.
3. Mark the frequency with maximum peak power as the center of the display of the spectrum.
4. Set the span to 1.5MHz and the sweep time to 500s and record the maximum peak value.

**3.4.4 Test Setup Layout**

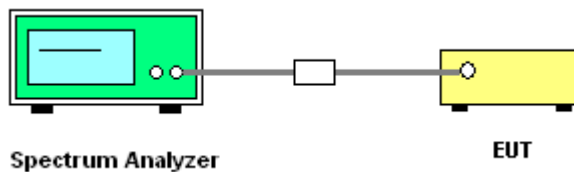

**3.4.5 Test Deviation**

There is no deviation with the original standard.

**3.4.6 EUT Operation during Test**

The EUT was programmed to be in continuously transmitting mode.

**3.4.7 Test Result of Power Spectral Density**

<b>Final Test Date</b>	Dec. 24, 2010	<b>Test Site No.</b>	TH01-HY
<b>Temperature</b>	22.5°C	<b>Humidity</b>	63%
<b>Test Engineer</b>	Ian	<b>Configuration</b>	802.11b/g/n

**Configuration IEEE 802.11b**

Channel	Frequency	Power Density (dBm)	Max. Limit (dBm)	Result
1	2412 MHz	-6.84	8.00	<b>Complies</b>
6	2437 MHz	-5.18	8.00	<b>Complies</b>
11	2462 MHz	-4.98	8.00	<b>Complies</b>

**Configuration IEEE 802.11g**

Channel	Frequency	Power Density (dBm)	Max. Limit (dBm)	Result
1	2412 MHz	-11.02	8.00	<b>Complies</b>
6	2437 MHz	-11.52	8.00	<b>Complies</b>
11	2462 MHz	-10.68	8.00	<b>Complies</b>

**Configuration of IEEE 802.11n (20MHz)**

Channel	Frequency	Power Density (dBm)	Max. Limit (dBm)	Result
1	2412 MHz	-12.35	8.00	Complies
6	2437 MHz	-12.97	8.00	Complies
11	2462 MHz	-14.18	8.00	Complies

Power Density Plot on Configuration IEEE 802.11b / 2412 MHz

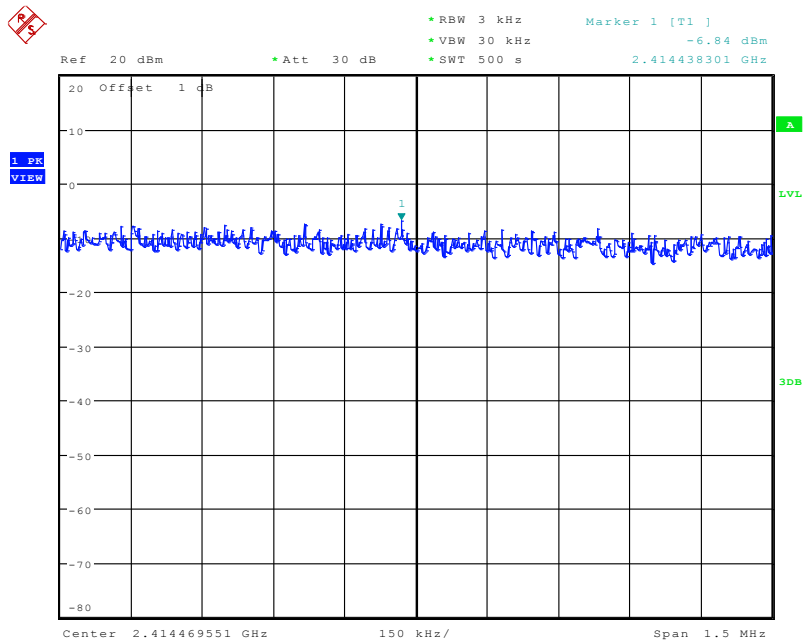

Date: 24.DEC.2010 10:55:37

Power Density Plot on Configuration IEEE 802.11b / 2437 MHz

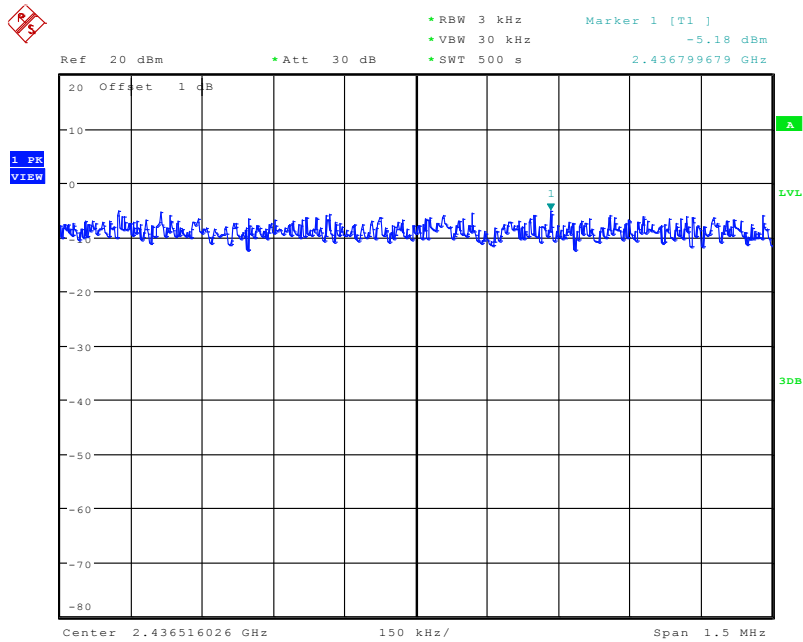

Date: 24.DEC.2010 11:02:27

Power Density Plot on Configuration IEEE 802.11b / 2462 MHz

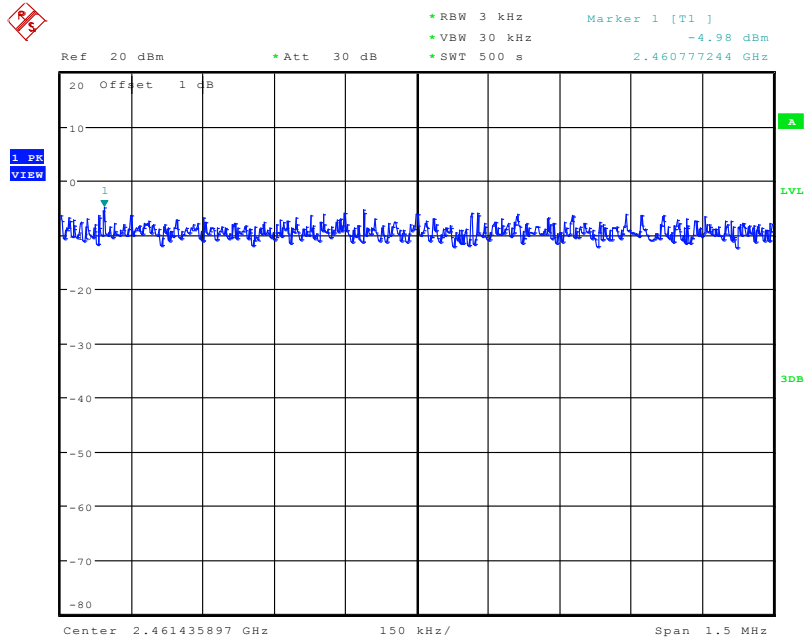

Date: 24.DEC.2010 11:16:08

Power Density Plot on Configuration IEEE 802.11g / 2412 MHz

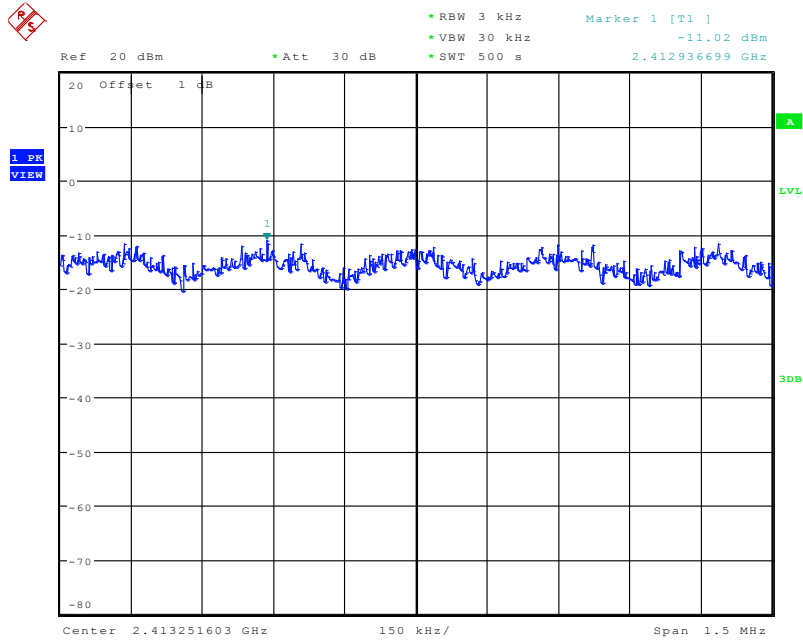

Date: 24.DEC.2010 11:26:41

Power Density Plot on Configuration IEEE 802.11g / 2437 MHz

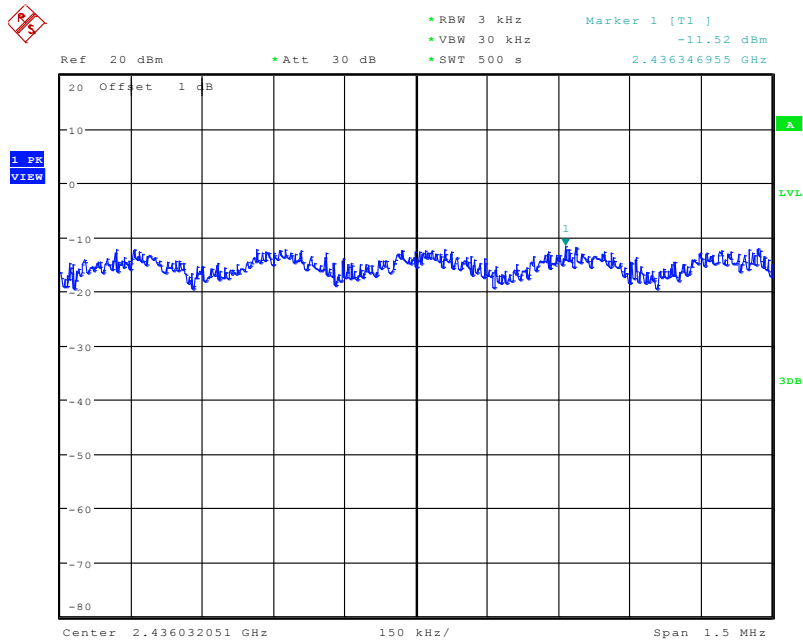

Date: 24.DEC.2010 11:32:07

Power Density Plot on Configuration IEEE 802.11g / 2462 MHz

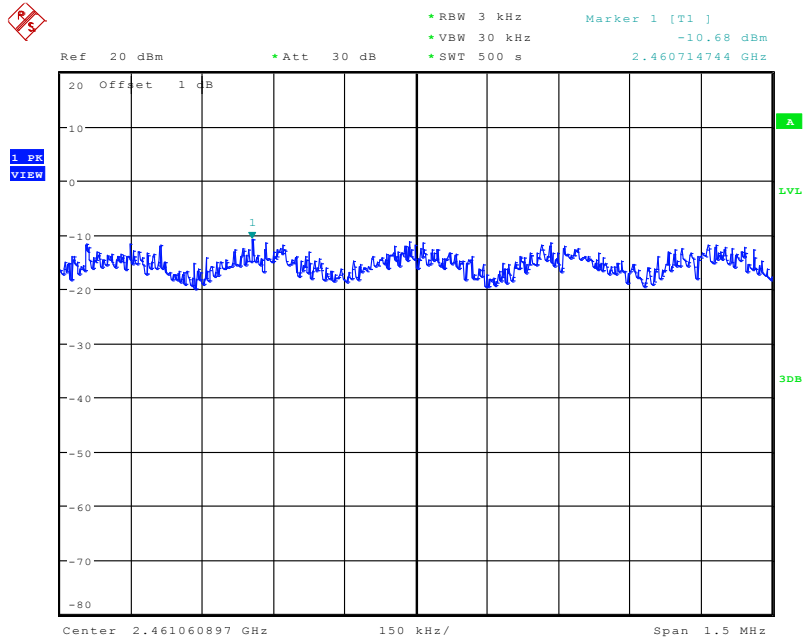

Date: 24.DEC.2010 11:38:57



Power Density Plot on Configuration of IEEE 802.11n (20MHz) / 2412 MHz

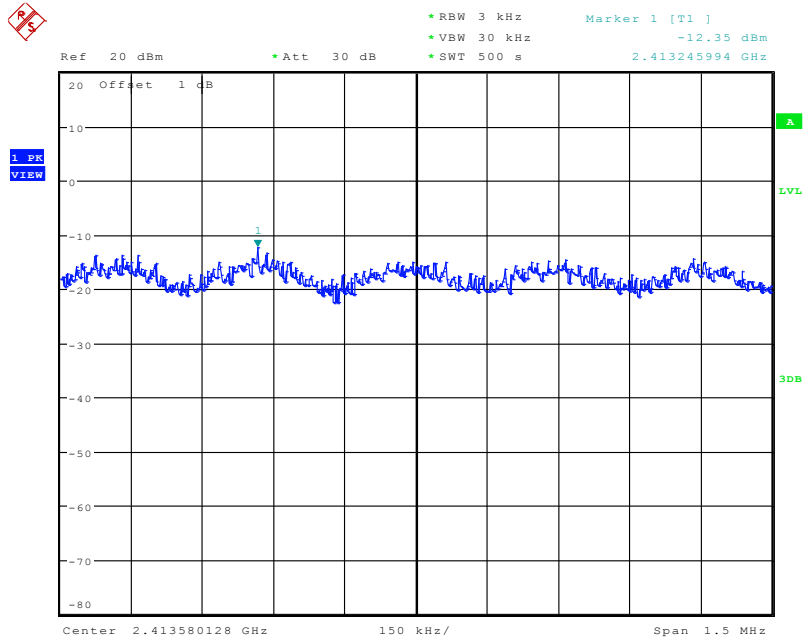

Date: 24.DEC.2010 14:13:58

Power Density Plot on Configuration of IEEE 802.11n (20MHz) / 2437 MHz

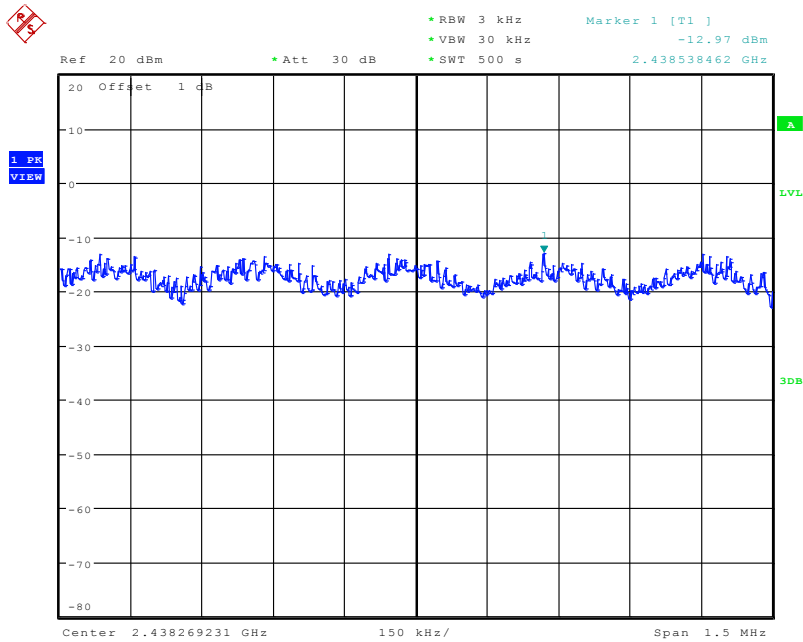

Date: 24.DEC.2010 13:54:04

Power Density Plot on Configuration of IEEE 802.11n (20MHz) / 2462 MHz

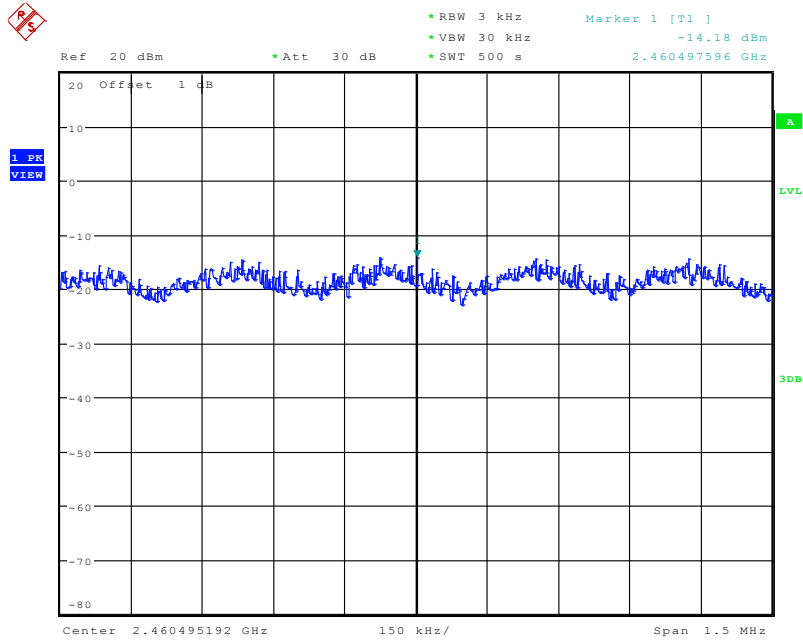

Date: 24.DEC.2010 14:00:01

**3.5 6dB Spectrum Bandwidth Measurement**

**3.5.1 Limit**

For digital modulation systems, the minimum 6dB bandwidth shall be at least 500 kHz.

**3.5.2 Measuring Instruments and Setting**

Please refer to section 4 of equipments list in this report. The following table is the setting of the spectrum analyzer.

Spectrum Parameters	Setting
Attenuation	Auto
Span Frequency	> 6dB Bandwidth
RB	100 kHz
VB	100 kHz
Detector	Peak
Trace	Max Hold
Sweep Time	Auto

**3.5.3 Test Procedures**

1. The transmitter output (antenna port) was connected to the spectrum analyzer in peak hold mode.
2. The resolution bandwidth of 100 kHz and the video bandwidth of 100 kHz were used.
3. Measured the spectrum width with power higher than 6dB below carrier.

**3.5.4 Test Setup Layout**

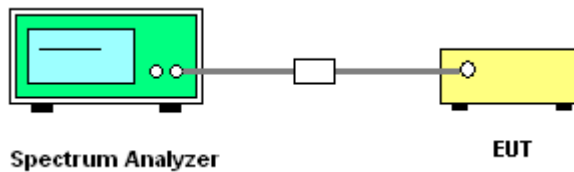

**3.5.5 Test Deviation**

There is no deviation with the original standard.

**3.5.6 EUT Operation during Test**

The EUT was programmed to be in continuously transmitting mode.

**3.5.7 Test Result of 6dB Spectrum Bandwidth**

<b>Final Test Date</b>	Dec. 24, 2010	<b>Test Site No.</b>	TH01-HY
<b>Temperature</b>	22.5°C	<b>Humidity</b>	63%
<b>Test Engineer</b>	Ian	<b>Configuration</b>	802.11b/g/n

**Configuration IEEE 802.11b**

Channel	Frequency	6dB Bandwidth (MHz)	99% Occupied Bandwidth (MHz)	Min. Limit (kHz)	Test Result
1	2412 MHz	8.49	13.21	500	Complies
6	2437 MHz	9.07	14.07	500	Complies
11	2462 MHz	9.13	13.75	500	Complies

**Configuration IEEE 802.11g**

Channel	Frequency	6dB Bandwidth (MHz)	99% Occupied Bandwidth (MHz)	Min. Limit (kHz)	Test Result
1	2412 MHz	15.13	16.38	500	<b>Complies</b>
6	2437 MHz	15.13	16.35	500	<b>Complies</b>
11	2462 MHz	15.13	16.35	500	<b>Complies</b>

**Configuration of IEEE 802.11n (20MHz)**

Channel	Frequency	6dB Bandwidth (MHz)	99% Occupied Bandwidth (MHz)	Min. Limit (kHz)	Test Result
1	2412 MHz	15.16	17.56	500	<b>Complies</b>
6	2437 MHz	15.16	17.53	500	<b>Complies</b>
11	2462 MHz	15.19	17.56	500	<b>Complies</b>

6 dB Bandwidth Plot on Configuration IEEE 802.11b / 2412 MHz

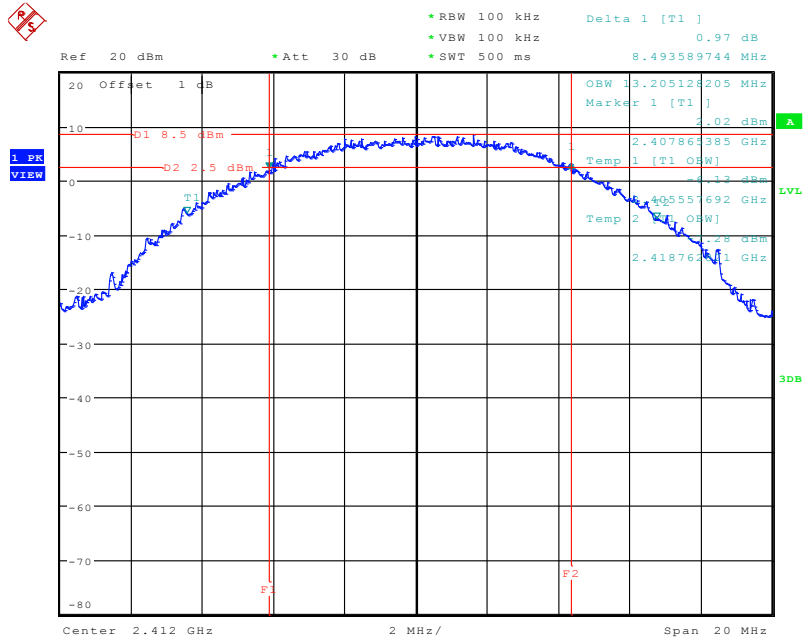

Date: 24.DEC.2010 10:52:20

6 dB Bandwidth Plot on Configuration IEEE 802.11b / 2437 MHz

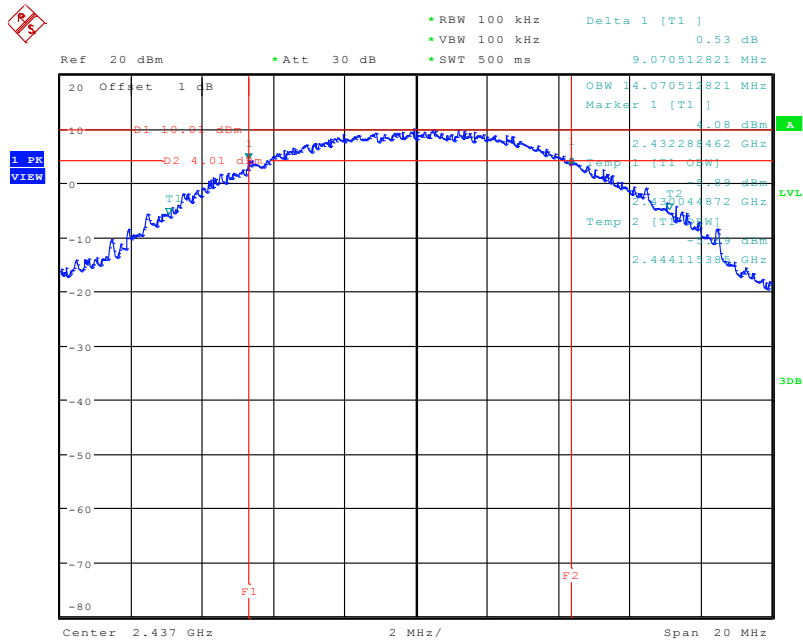

Date: 24.DEC.2010 11:01:39

6 dB Bandwidth Plot on Configuration IEEE 802.11b / 2462 MHz

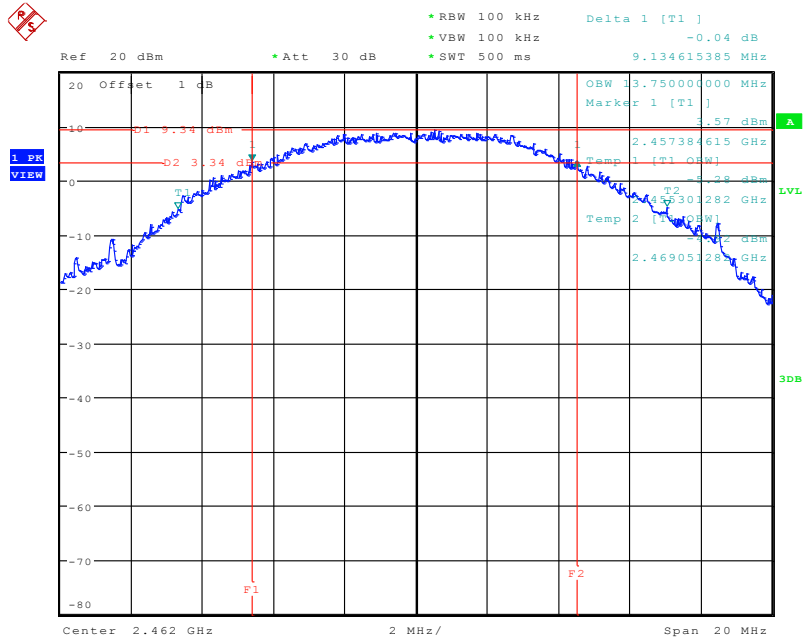

Date: 24.DEC.2010 11:13:53

6 dB Bandwidth Plot on Configuration IEEE 802.11g / 2412 MHz

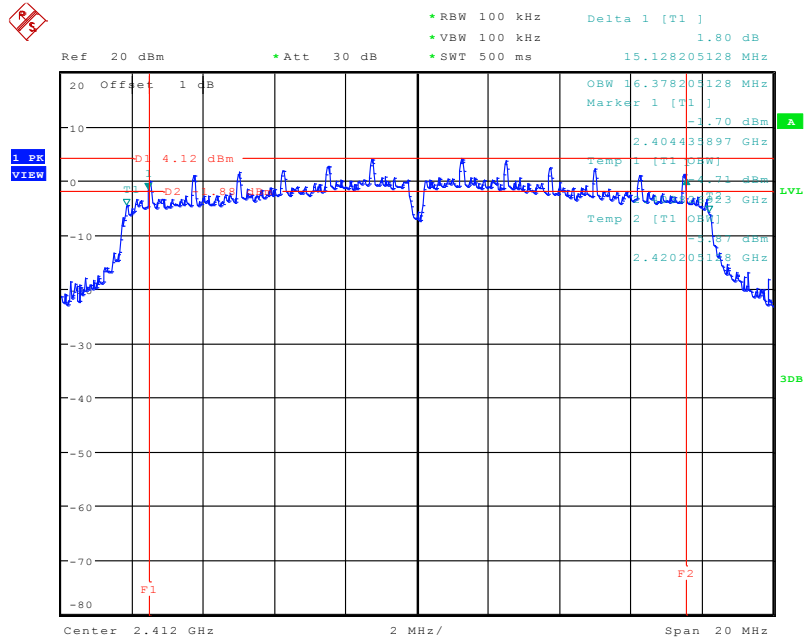

Date: 24.DEC.2010 11:24:39

6 dB Bandwidth Plot on Configuration IEEE 802.11g / 2437 MHz

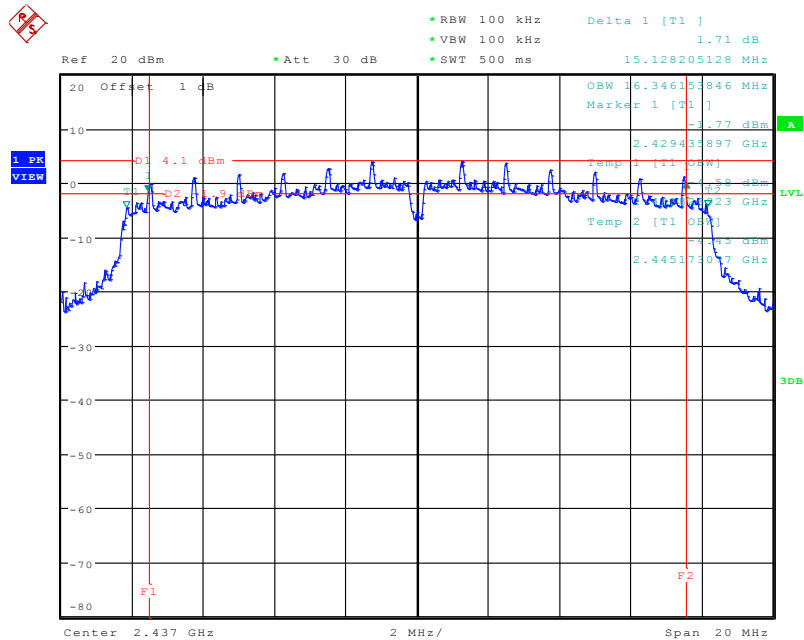

Date: 24.DEC.2010 11:30:58

6 dB Bandwidth Plot on Configuration IEEE 802.11g / 2462 MHz

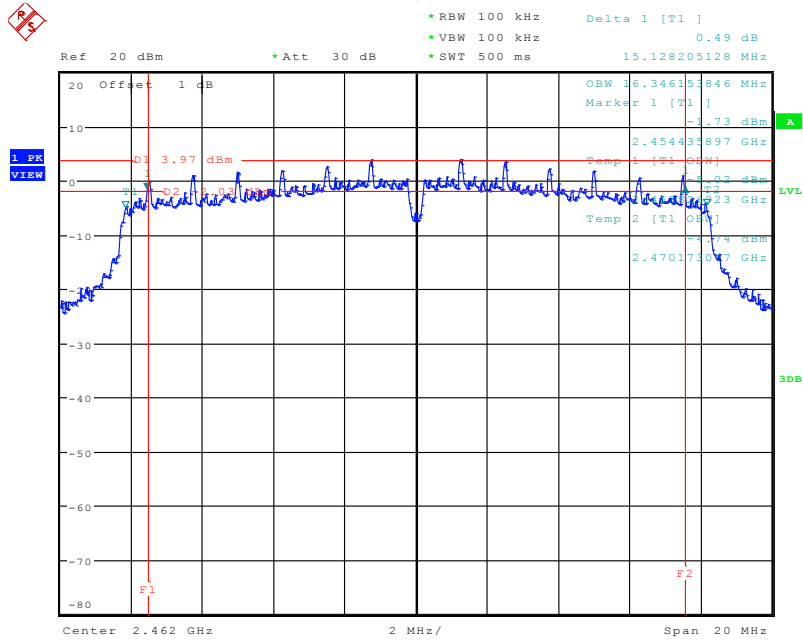

Date: 24.DEC.2010 11:36:59



6 dB Bandwidth Plot on Configuration of IEEE 802.11n (20MHz) / 2412 MHz

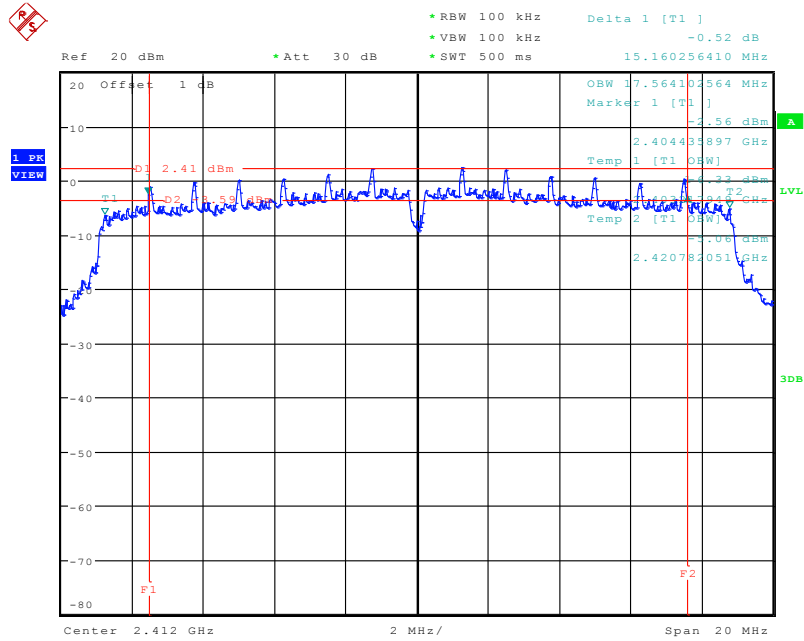

Date: 24.DEC.2010 13:48:48

6 dB Bandwidth Plot on Configuration of IEEE 802.11n (20MHz) / 2437 MHz

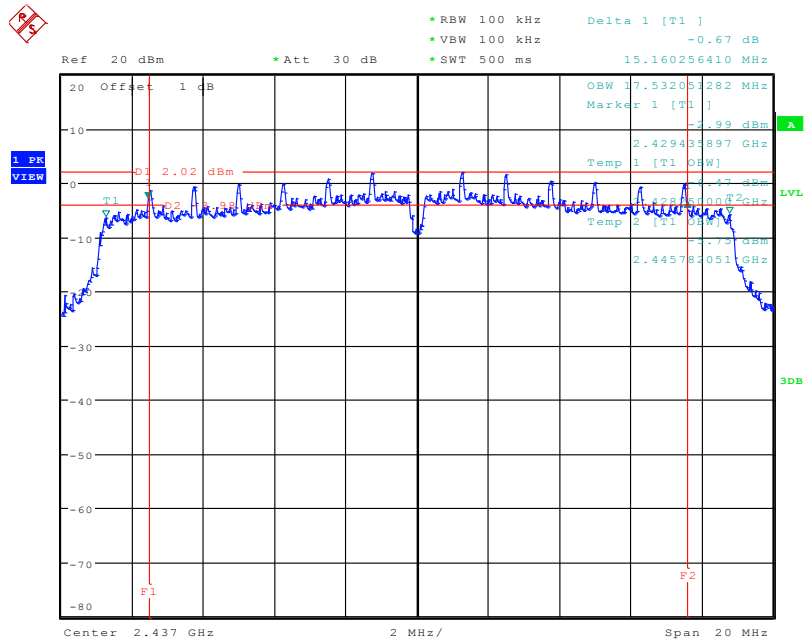

Date: 24.DEC.2010 13:53:12

6 dB Bandwidth Plot on Configuration of IEEE 802.11n (20MHz) / 2462 MHz

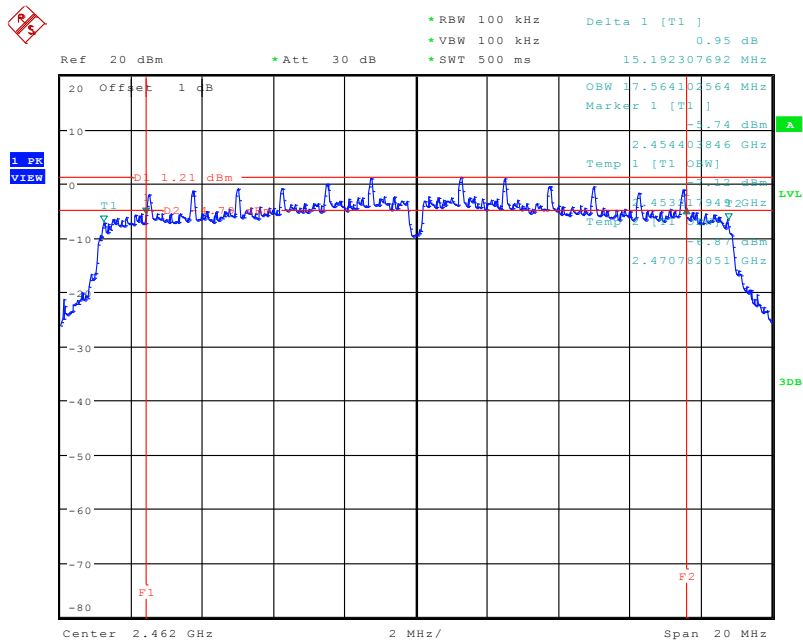

Date: 24.DEC.2010 13:58:22

**3.6 Radiated Emissions Measurement**

**3.6.1 Limit**

In any 100kHz bandwidth outside the frequency band in which the spread spectrum or digitally modulated intentional radiator is operating, the radio frequency power that is produced by the intentional radiator shall be at least 20dB below that in the 100kHz bandwidth within the band that contains the highest level of the desired power, based on either an RF conducted or a radiated measurement. If the transmitter measurement is based on the maximum conducted output power, the attenuation required under this paragraph shall be 30dB instead of 20dB. In addition, radiated emissions which fall in section 15.205(a) the restricted bands must also comply with the radiated emission limit specified in section 15.209(a).

<b>Frequencies (MHz)</b>	<b>Field Strength (micorvolts/meter)</b>	<b>Measurement Distance (meters)</b>
0.009~0.490	2400/F(KHz)	300
0.490~1.705	24000/F(KHz)	30
1.705~30.0	30	30
30~88	100	3
88~216	150	3
216~960	200	3
Above 960	500	3

**3.6.2 Measuring Instruments and Setting**

Please refer to section 4 of equipments list in this report. The following table is the setting of spectrum analyzer and receiver.

<b>Spectrum Parameter</b>	<b>Setting</b>
Attenuation	Auto
Start Frequency	1000 MHz
Stop Frequency	10th carrier harmonic
RB / VB (Emission in restricted band)	1MHz / 1MHz for Peak, 1 MHz / 10Hz for Average
RB / VB (Emission in non-restricted band)	1MHz / 1MHz for Peak

<b>Receiver Parameter</b>	<b>Setting</b>
Attenuation	Auto
Start ~ Stop Frequency	9kHz~150kHz / RB 200Hz for QP
Start ~ Stop Frequency	150kHz~30MHz / RB 9kHz for QP
Start ~ Stop Frequency	30MHz~1000MHz / RB 120kHz for QP

**3.6.3 Test Procedures**

1. Configure the EUT according to ANSI C63.4. The EUT was placed on the top of the turntable 0.8 meter above ground. The phase center of the receiving antenna mounted on the top of a height-variable antenna tower was placed 3 meters far away from the turntable.
2. Power on the EUT and all the supporting units. The turntable was rotated by 360 degrees to determine the position of the highest radiation.
3. The height of the broadband receiving antenna was varied between one meter and four meters above ground to find the maximum emissions field strength of both horizontal and vertical polarization.
4. For each suspected emissions, the antenna tower was scan (from 1 M to 4 M) and then the turntable was rotated (from 0 degree to 360 degrees) to find the maximum reading.
5. Set the test-receiver system to Peak or CISPR quasi-peak Detect Function with specified bandwidth under Maximum Hold Mode.
6. For emissions above 1GHz, use 1MHz VBW and RBW for peak reading. Then 1MHz RBW and 10Hz VBW for average reading in spectrum analyzer.
7. When the radiated emissions limits are expressed in terms of the average value of the emissions, and pulsed operation is employed, the measurement field strength shall be determined by averaging over one complete pulse train, including blanking intervals, as long as the pulse train does not exceed 0.1 seconds. As an alternative (provided the transmitter operates for longer than 0.1 seconds) or in cases where the pulse train exceeds 0.1 seconds, the measured field strength shall be determined from the average absolute voltage during a 0.1 second interval during which the field strength is at its maximum value.
8. If the emissions level of the EUT in peak mode was 3 dB lower than the average limit specified, then testing will be stopped and peak values of EUT will be reported, otherwise, the emissions which do not have 3 dB margin will be repeated one by one using the quasi-peak method for below 1GHz.
9. For testing above 1GHz, the emissions level of the EUT in peak mode was lower than average limit (that means the emissions level in peak mode also complies with the limit in average mode), then testing will be stopped and peak values of EUT will be reported, otherwise, the emissions will be measured in average mode again and reported.
10. In case the emission is lower than 30MHz, loop antenna has to be used for measurement and the recorded data should be QP measured by receiver. High – Low scan is not required in this case.

3.6.4 Test Setup Layout

For radiated emissions below 30MHz

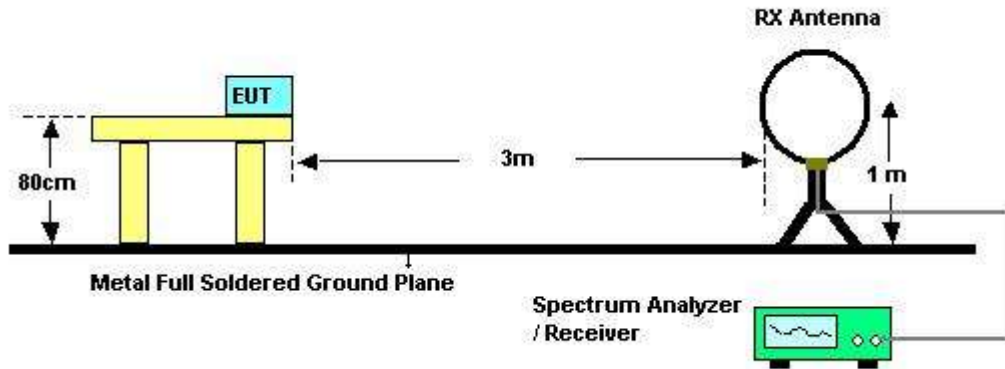

For radiated emissions above 30MHz

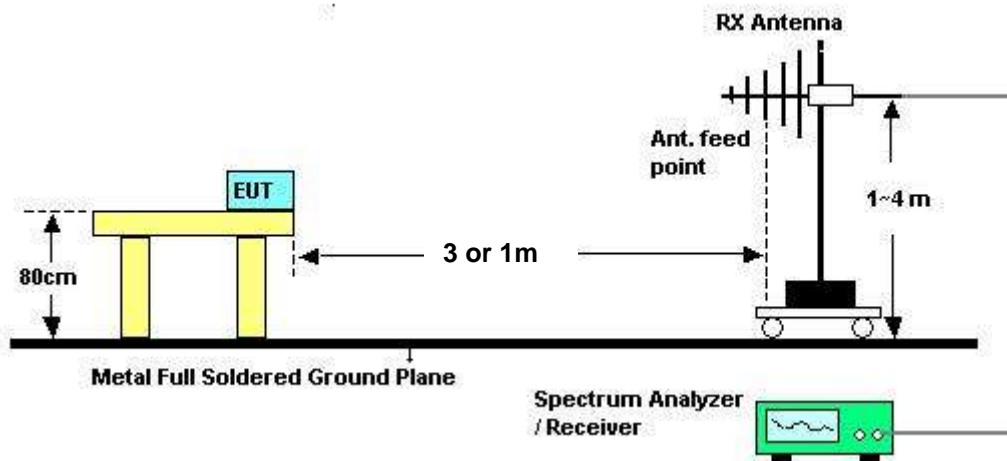

Above 10 GHz shall be extrapolated to the specified distance using an extrapolation factor of 20 dB/decade from 3m to 1m.

Distance extrapolation factor =  $20 \log (\text{specific distance [3m]} / \text{test distance [1m]})$  (dB);

Limit line = specific limits (dBuV) + distance extrapolation factor [9.54 dB].

3.6.5 Test Deviation

There is no deviation with the original standard.

3.6.6 EUT Operation during Test

The EUT was programmed to be in continuously transmitting mode.

**3.6.7 Results of Radiated Emissions (9kHz~30MHz)**

<b>Final Test Date</b>	Dec. 24, 2010	<b>Test Site No.</b>	03CH03-HY
<b>Temperature</b>	25.9°C	<b>Humidity</b>	53%
<b>Test Engineer</b>	Daniel		

<b>Freq. (MHz)</b>	<b>Level (dBuV)</b>	<b>Over Limit (dB)</b>	<b>Limit Line (dBuV)</b>	<b>Remark</b>
-	-	-	-	See Note

Note:

The amplitude of spurious emissions that are attenuated by more than 20 dB below the permissible value has no need to be reported.

Distance extrapolation factor =  $40 \log (\text{specific distance} / \text{test distance})$  (dB);

Limit line = specific limits (dBuV) + distance extrapolation factor.

3.6.8 Results of Radiated Emissions (30MHz~1GHz)

<b>Final Test Date</b>	Dec. 24, 2010	<b>Test Site No.</b>	03CH03-HY
<b>Temperature</b>	25.9°C	<b>Humidity</b>	58%
<b>Test Engineer</b>	Daniel	<b>Configuration</b>	Normal Mode

Horizontal

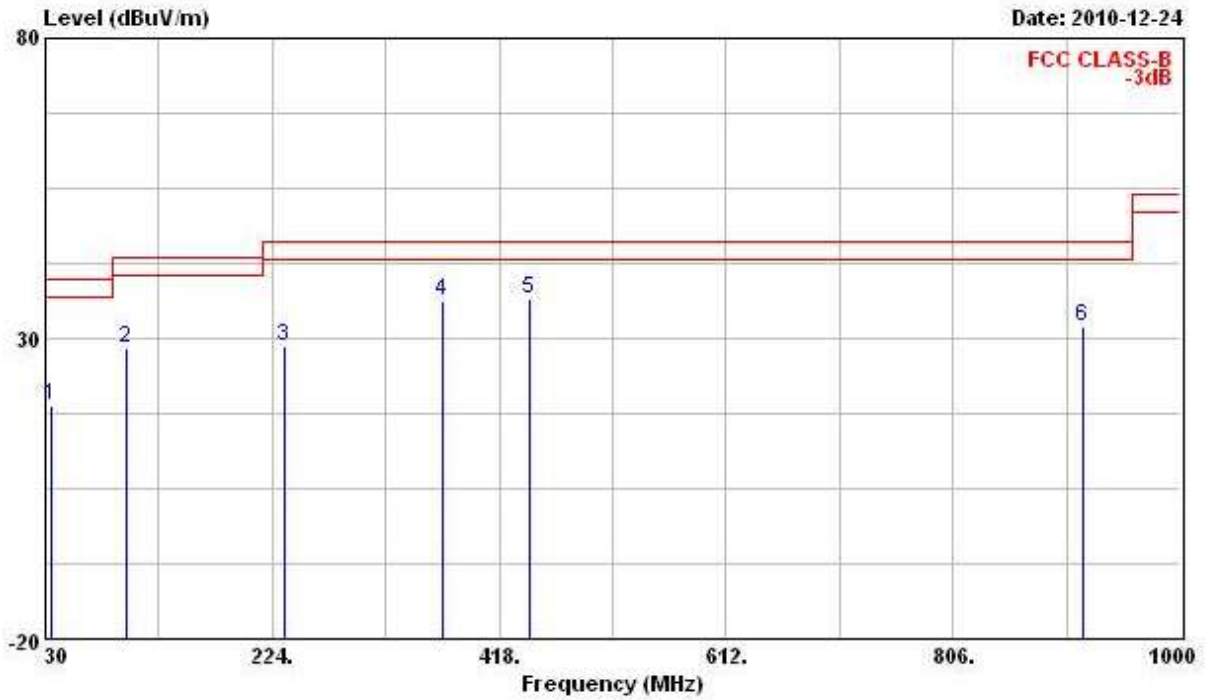

	Freq	Level	Over Limit	Limit Line	ReadAntenna	Cable	Preamp	Remark
	MHz	dBuV/m	dB	dBuV/m	dBuV	dB	dB	
1	35.820	18.92	-21.08	40.00	31.20	14.94	0.83	28.05 Peak
2	98.870	28.50	-15.00	43.50	43.48	11.03	1.65	27.66 Peak
3	234.670	28.75	-17.25	46.00	43.05	10.96	2.64	27.89 Peak
4	370.470	36.23	-9.77	46.00	45.82	15.52	3.36	28.47 Peak
5	444.190	36.66	-9.34	46.00	44.60	17.02	3.63	28.59 Peak
6	916.580	31.89	-14.11	46.00	34.65	21.13	5.63	29.52 Peak

Vertical

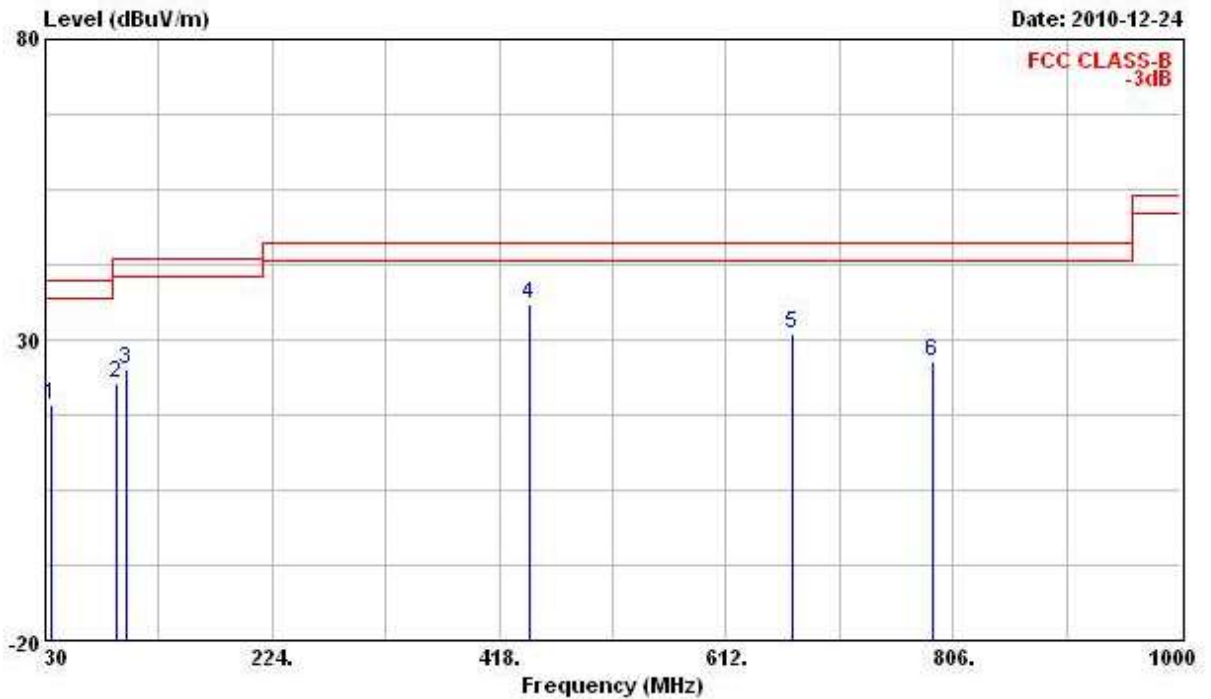

	Freq	Level	Over Limit	Limit Line	ReadAntenna Level	Antenna Factor	Cable Loss	Preamp Factor	Remark
	MHz	dBuV/m	dB	dBuV/m	dBuV	dB/m	dB	dB	
1	35.820	19.30	-20.70	40.00	31.58	14.94	0.83	28.05	Peak
2	90.140	22.75	-20.75	43.50	39.92	9.50	1.57	28.24	Peak
3	98.870	25.20	-18.30	43.50	40.18	11.03	1.65	27.66	Peak
4	444.190	35.84	-10.16	46.00	43.78	17.02	3.63	28.59	Peak
5	668.260	31.00	-15.00	46.00	35.89	19.75	4.62	29.26	Peak
6	789.510	26.42	-19.58	46.00	30.22	20.74	5.04	29.58	Peak

Note:

The amplitude of spurious emissions that are attenuated by more than 20dB below the permissible value has no need to be reported.

Emission level (dBuV/m) = 20 log Emission level (uV/m).

Corrected Reading: Antenna Factor + Cable Loss + Read Level - Preamp Factor = Level.



**3.6.9 Results for Radiated Emissions (1GHz~10<sup>th</sup> Harmonic)**

<b>Final Test Date</b>	Dec. 23, 2010	<b>Test Site No.</b>	03CH03-HY
<b>Temperature</b>	25.9°C	<b>Humidity</b>	53%
<b>Test Engineer</b>	Daniel	<b>Configuration</b>	802.11b Ch. 1

**Horizontal**

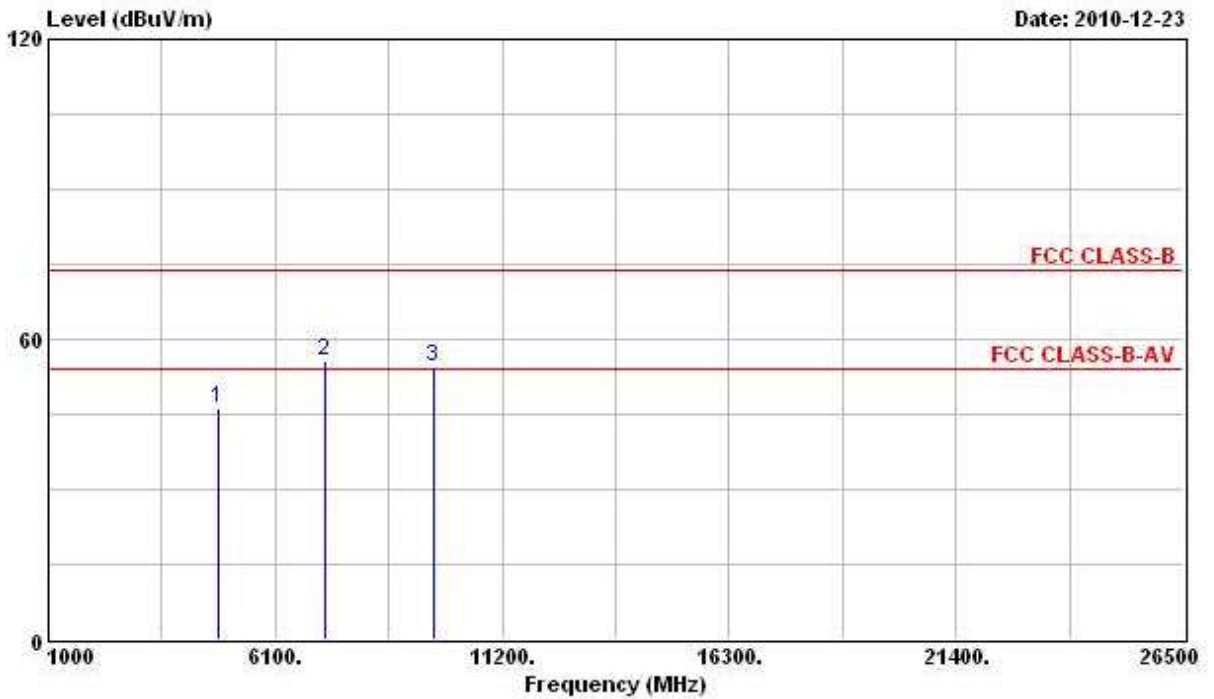

	<b>Freq</b>	<b>Level</b>	<b>Over</b>	<b>Limit</b>	<b>ReadAntenna</b>	<b>Cable</b>	<b>Preamp</b>	<b>Remark</b>
	<b>MHz</b>	<b>dBuV/m</b>	<b>Limit</b>	<b>Line</b>	<b>Level</b>	<b>Loss</b>	<b>Factor</b>	
			<b>dB</b>	<b>dBuV/m</b>	<b>dBuV</b>	<b>dB</b>	<b>dB</b>	
<b>1</b>	<b>4824.000</b>	<b>46.17</b>	<b>-7.83</b>	<b>54.00</b>	<b>43.05</b>	<b>33.06</b>	<b>2.70</b>	<b>32.63 PK</b>
<b>2</b>	<b>7236.000</b>	<b>55.80</b>			<b>48.60</b>	<b>35.53</b>	<b>4.55</b>	<b>32.89 Peak</b>
<b>3</b>	<b>9648.000</b>	<b>54.54</b>			<b>44.15</b>	<b>38.41</b>	<b>5.32</b>	<b>33.34 Peak</b>

Note: The items 2 and 3 are on un-restricted band, so the limit is -20dB for the field strength of the fundamental emissions (see section 3.6.7).

Vertical

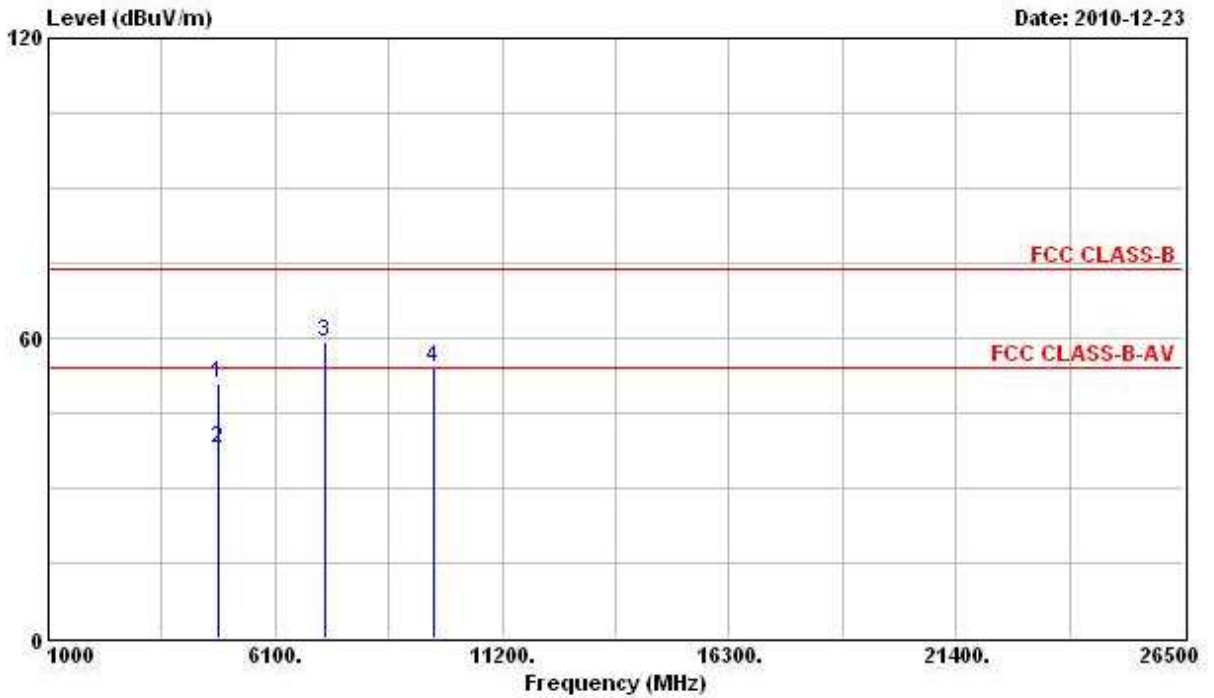

	Freq	Level	Over Limit	Limit Line	ReadAntenna Level	Antenna Factor	Cable Loss	Preamp Factor	Remark
	MHz	dBuV/m	dB	dBuV/m	dBuV	dB/m	dB	dB	
1	4824.000	51.05	-22.95	74.00	47.93	33.06	2.70	32.63	Peak
2	4824.000	37.92	-16.08	54.00	34.80	33.06	2.70	32.63	Average
3	7236.000	59.33			52.13	35.53	4.55	32.89	Peak
4	9648.000	54.16			43.77	38.41	5.32	33.34	Peak

Note: The items 3 and 4 are on un-restricted band, so the limit is -20dB for the field strength of the fundamental emissions (see section 3.6.7).

<b>Final Test Date</b>	Dec. 23, 2010	<b>Test Site No.</b>	03CH03-HY
<b>Temperature</b>	25.9°C	<b>Humidity</b>	53%
<b>Test Engineer</b>	Daniel	<b>Configuration</b>	802.11b Ch. 6

**Horizontal**

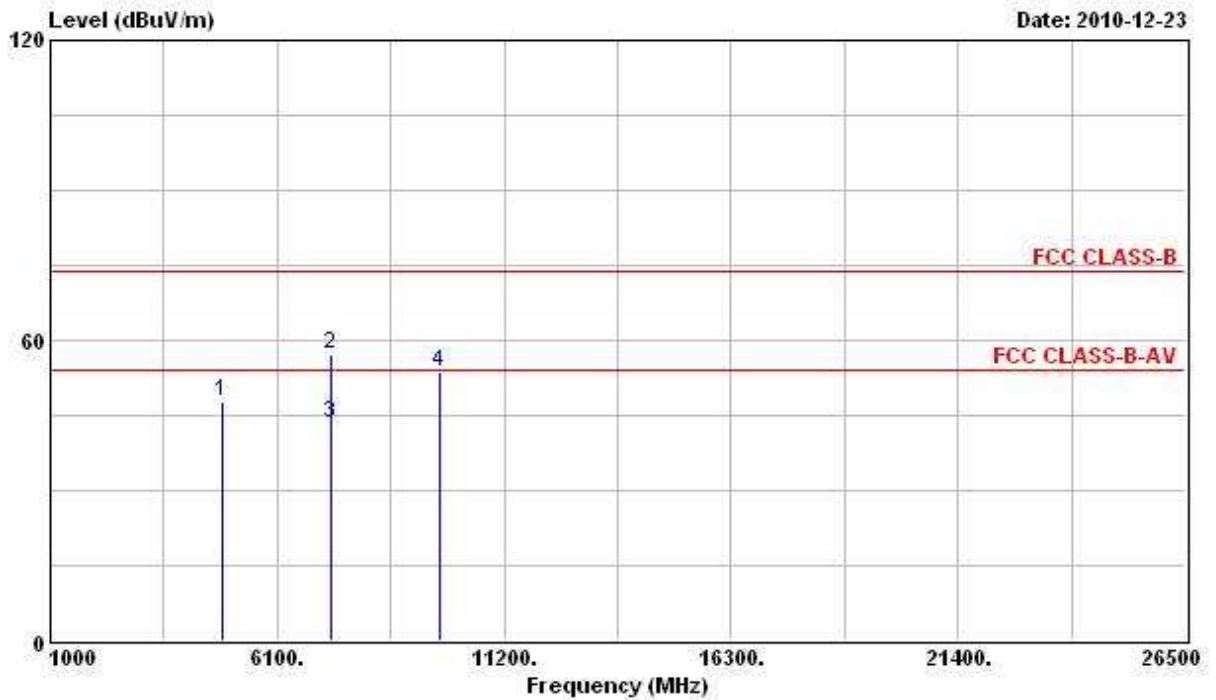

	Freq	Level	Over Limit	Limit Line	ReadAntenna Level	Antenna Factor	Cable Loss	Preamp Factor	Remark
	MHz	dBUV/m	dB	dBUV/m	dBuV	dB/m	dB	dB	
1	4874.000	47.58	-6.42	54.00	44.44	33.16	2.60	32.62	PK
2	7311.000	57.10	-16.90	74.00	49.67	35.68	4.65	32.90	Peak
3	7311.000	43.29	-10.71	54.00	35.86	35.68	4.65	32.90	Average
4	9748.000	53.67			42.97	38.62	5.42	33.34	Peak

Note: The item 4 is on un-restricted band, so the limit is -20dB for the field strength of the fundamental emissions (see section 3.6.7).

Vertical

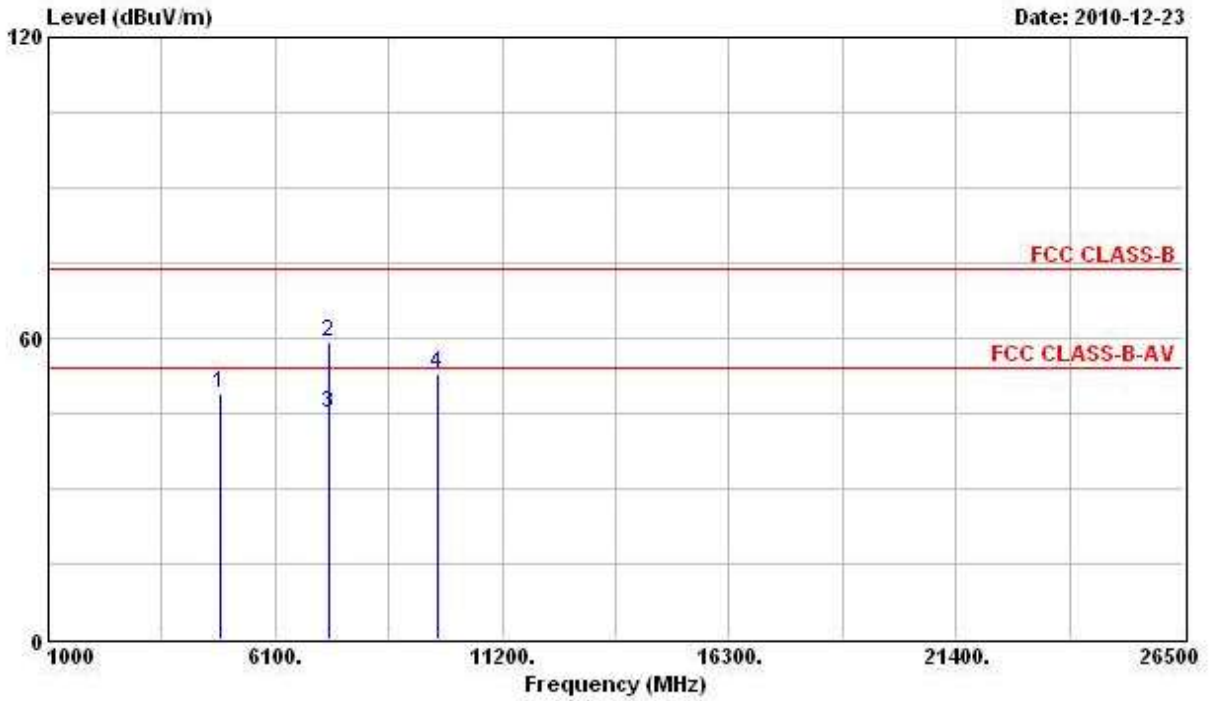

	Freq	Level	Over	Limit	ReadAntenna	Cable	Preamp	Remark
	MHz	dBuV/m	Limit	Line	Level	Loss	Factor	
			dB	dBuV/m	dBuV	dB	dB	
1	4874.000	48.88	-5.12	54.00	45.74	33.16	2.60	32.62 PK
2	7311.000	59.23	-14.77	74.00	51.80	35.68	4.65	32.90 Peak
3	7311.000	44.89	-9.11	54.00	37.46	35.68	4.65	32.90 Average
4	9748.000	52.76			42.06	38.62	5.42	33.34 Peak

Note: The item 4 is on un-restricted band, so the limit is -20dB for the field strength of the fundamental emissions (see section 3.6.7).

<b>Final Test Date</b>	Dec. 23, 2010	<b>Test Site No.</b>	03CH03-HY
<b>Temperature</b>	25.9°C	<b>Humidity</b>	53%
<b>Test Engineer</b>	Daniel	<b>Configuration</b>	802.11b Ch. 11

**Horizontal**

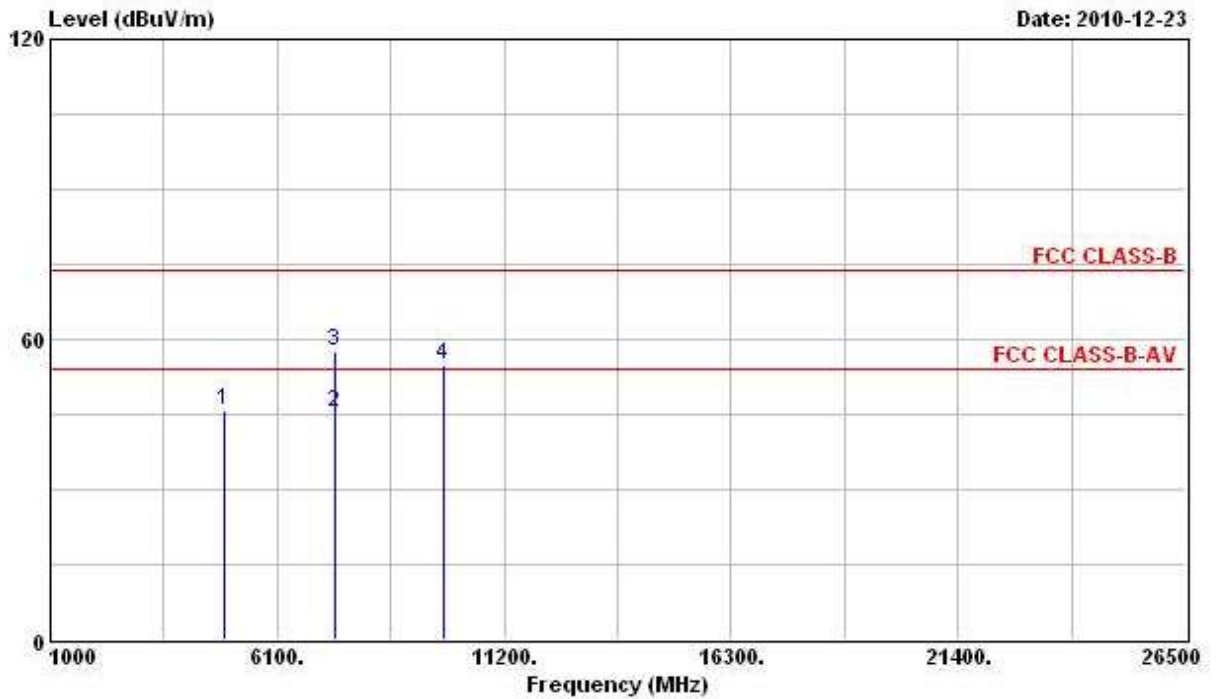

	Freq	Level	Over Limit	Limit Line	ReadAntenna Level	Antenna Factor	Cable Loss	Preamp Factor	Remark
	MHz	dBuV/m	dB	dBuV/m	dBuV	dB/m	dB	dB	
1	4924.000	45.66	-8.34	54.00	42.45	33.26	2.56	32.61	PK
2	7386.000	45.37	-8.63	54.00	37.67	35.87	4.75	32.92	Average
3	7386.000	57.78	-16.22	74.00	50.08	35.87	4.75	32.92	Peak
4	9848.000	54.94			43.99	38.79	5.49	33.33	Peak

Note: The item 4 is on un-restricted band, so the limit is -20dB for the field strength of the fundamental emissions (see section 3.6.7).

Vertical

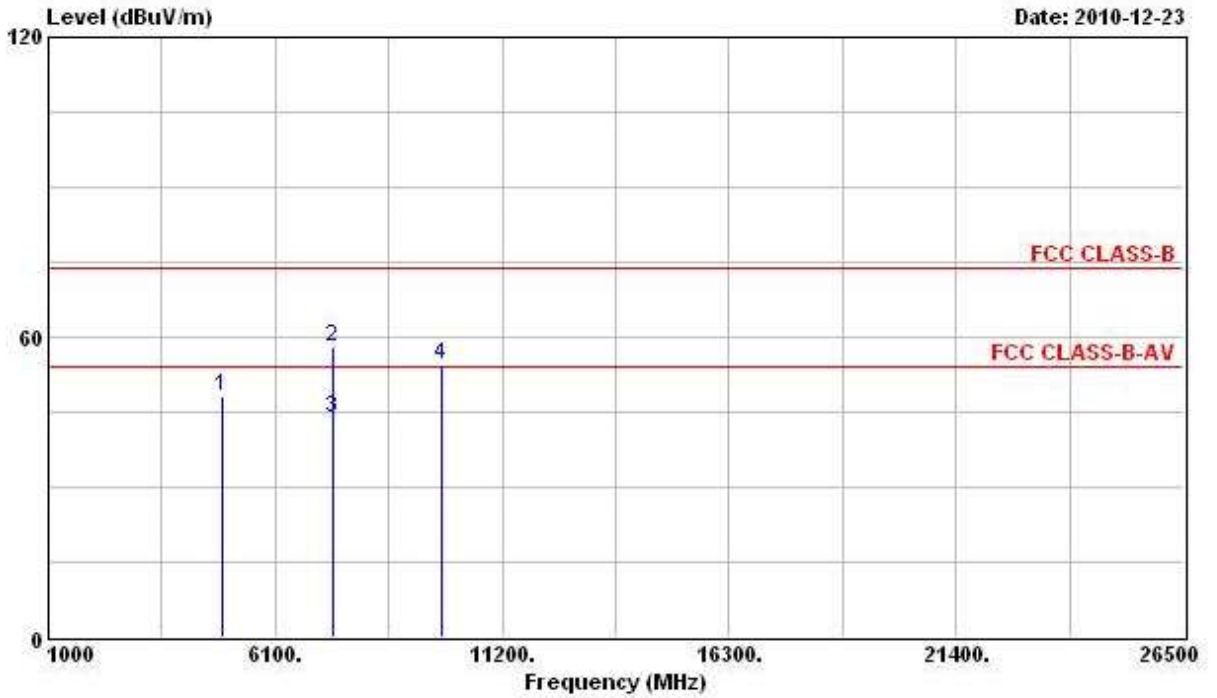

	Freq	Level	Over Limit	Limit Line	ReadAntenna Level	Antenna Factor	Cable Loss	Preamp Factor	Remark
	MHz	dBuV/m	dB	dBuV/m	dBuV	dB/m	dB	dB	
1	4924.000	48.16	-5.84	54.00	44.95	33.26	2.56	32.61	PK
2	7386.000	58.04	-15.96	74.00	50.34	35.87	4.75	32.92	Peak
3	7386.000	43.72	-10.28	54.00	36.02	35.87	4.75	32.92	Average
4	9848.000	54.60			43.65	38.79	5.49	33.33	Peak

Note: The item 4 is on un-restricted band, so the limit is -20dB for the field strength of the fundamental emissions (see section 3.6.7).

<b>Final Test Date</b>	Dec. 23, 2010	<b>Test Site No.</b>	03CH03-HY
<b>Temperature</b>	25.9°C	<b>Humidity</b>	53%
<b>Test Engineer</b>	Daniel	<b>Configuration</b>	802.11g Ch. 1

**Horizontal**

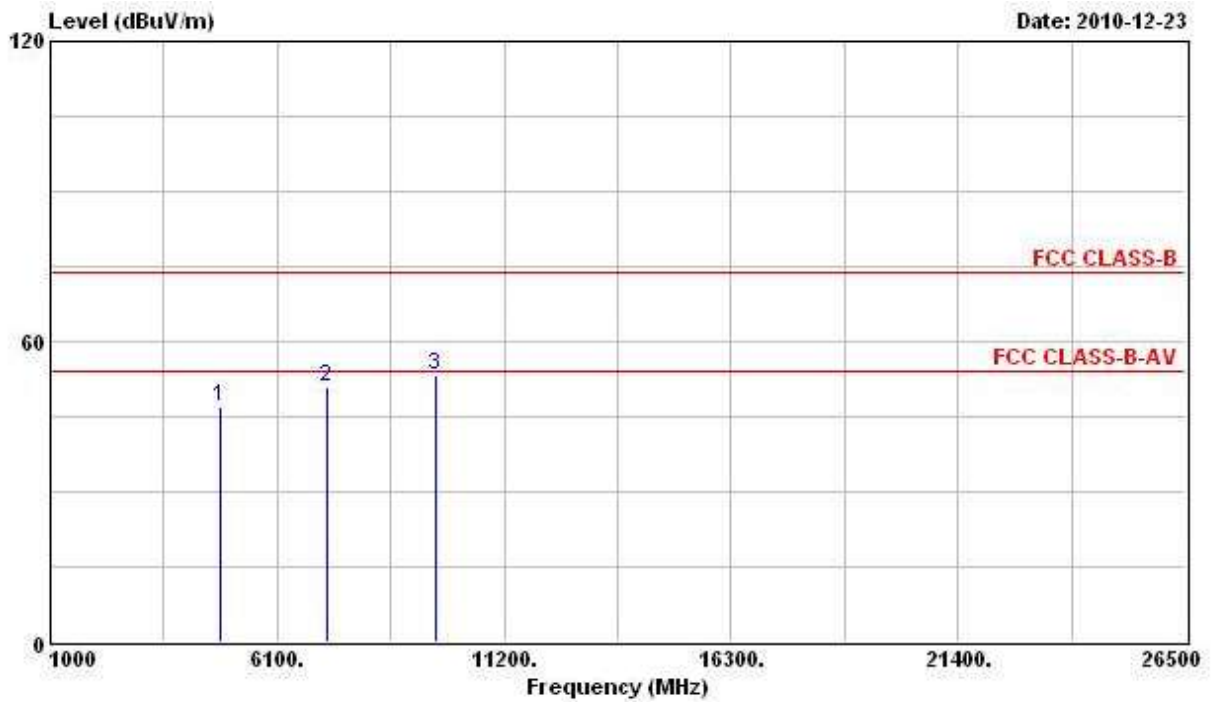

	<b>Freq</b>	<b>Level</b>	<b>Over Limit</b>	<b>Limit Line</b>	<b>ReadAntenna Level</b>	<b>Antenna Factor</b>	<b>Cable Loss</b>	<b>Preamp Factor</b>	<b>Remark</b>
	<b>MHz</b>	<b>dBuV/m</b>	<b>dB</b>	<b>dBuV/m</b>	<b>dBuV</b>	<b>dB/m</b>	<b>dB</b>	<b>dB</b>	
<b>1</b>	<b>4824.000</b>	<b>47.04</b>	<b>-6.96</b>	<b>54.00</b>	<b>43.92</b>	<b>33.06</b>	<b>2.70</b>	<b>32.63</b>	<b>pk</b>
<b>2</b>	<b>7236.000</b>	<b>50.73</b>			<b>43.53</b>	<b>35.53</b>	<b>4.55</b>	<b>32.89</b>	<b>Peak</b>
<b>3</b>	<b>9648.000</b>	<b>53.16</b>			<b>42.77</b>	<b>38.41</b>	<b>5.32</b>	<b>33.34</b>	<b>Peak</b>

Note: The items 2 and 3 are on un-restricted band, so the limit is -20dB for the field strength of the fundamental emissions (see section 3.6.7).

Vertical

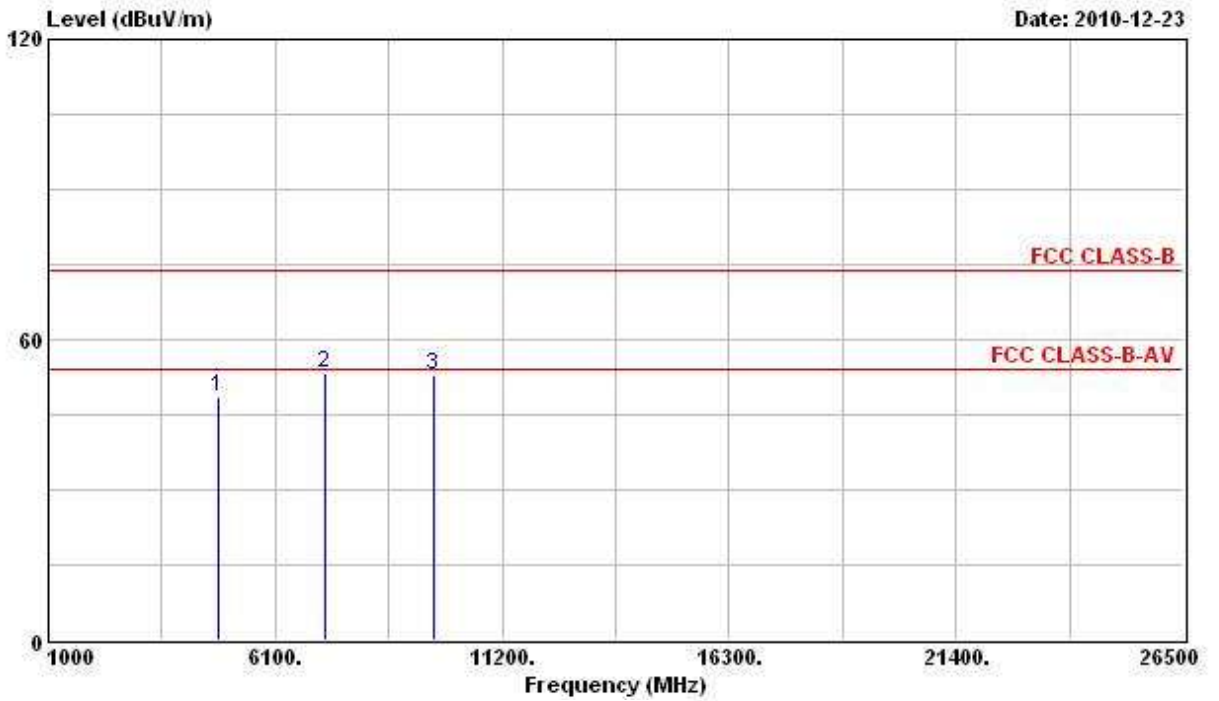

	Freq	Level	Over Limit	Limit Line	ReadAntenna Level	Antenna Factor	Cable Loss	Preamp Factor	Remark
	MHz	dBuV/m	dB	dBuV/m	dBuV	dB/m	dB	dB	
1	4824.000	48.36	-5.64	54.00	45.24	33.06	2.70	32.63	PK
2	7236.000	53.36			46.16	35.53	4.55	32.89	Peak
3	9648.000	52.88			42.49	38.41	5.32	33.34	Peak

Note: The items 2 and 3 are on un-restricted band, so the limit is -20dB for the field strength of the fundamental emissions (see section 3.6.7).



<b>Final Test Date</b>	Dec. 23, 2010	<b>Test Site No.</b>	03CH03-HY
<b>Temperature</b>	25.9°C	<b>Humidity</b>	53%
<b>Test Engineer</b>	Daniel	<b>Configuration</b>	802.11g Ch. 6

**Horizontal**

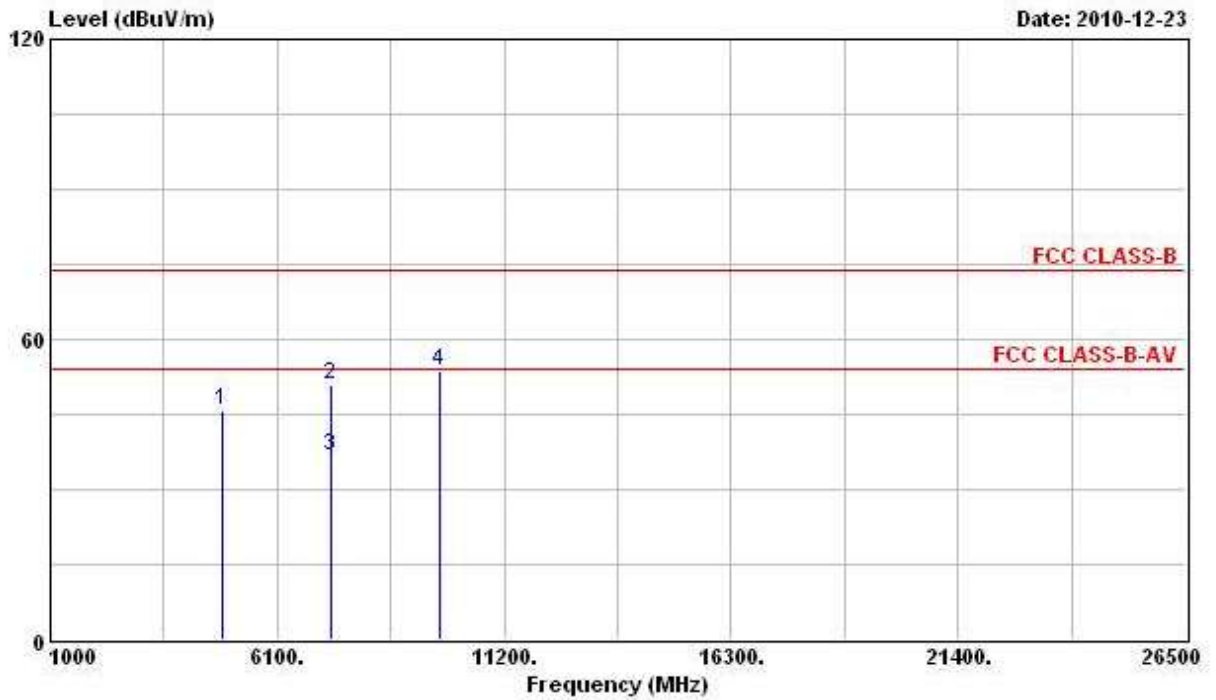

	<b>Freq</b>	<b>Level</b>	<b>Over Limit</b>	<b>Limit Line</b>	<b>ReadAntenna Level</b>	<b>Antenna Factor</b>	<b>Cable Loss</b>	<b>Preamp Factor</b>	<b>Remark</b>
	<b>MHz</b>	<b>dBUV/m</b>	<b>dB</b>	<b>dBUV/m</b>	<b>dBuV</b>	<b>dB/m</b>	<b>dB</b>	<b>dB</b>	
<b>1</b>	<b>4874.000</b>	<b>45.68</b>	<b>-8.32</b>	<b>54.00</b>	<b>42.54</b>	<b>33.16</b>	<b>2.60</b>	<b>32.62</b>	<b>PK</b>
<b>2</b>	<b>7311.000</b>	<b>51.08</b>	<b>-22.92</b>	<b>74.00</b>	<b>43.65</b>	<b>35.68</b>	<b>4.65</b>	<b>32.90</b>	<b>Peak</b>
<b>3</b>	<b>7311.000</b>	<b>36.64</b>	<b>-17.36</b>	<b>54.00</b>	<b>29.21</b>	<b>35.68</b>	<b>4.65</b>	<b>32.90</b>	<b>Average</b>
<b>4</b>	<b>9748.000</b>	<b>53.67</b>			<b>42.97</b>	<b>38.62</b>	<b>5.42</b>	<b>33.34</b>	<b>Peak</b>

Note: The item 4 is on un-restricted band, so the limit is -20dB for the field strength of the fundamental emissions (see section 3.6.7).

Vertical

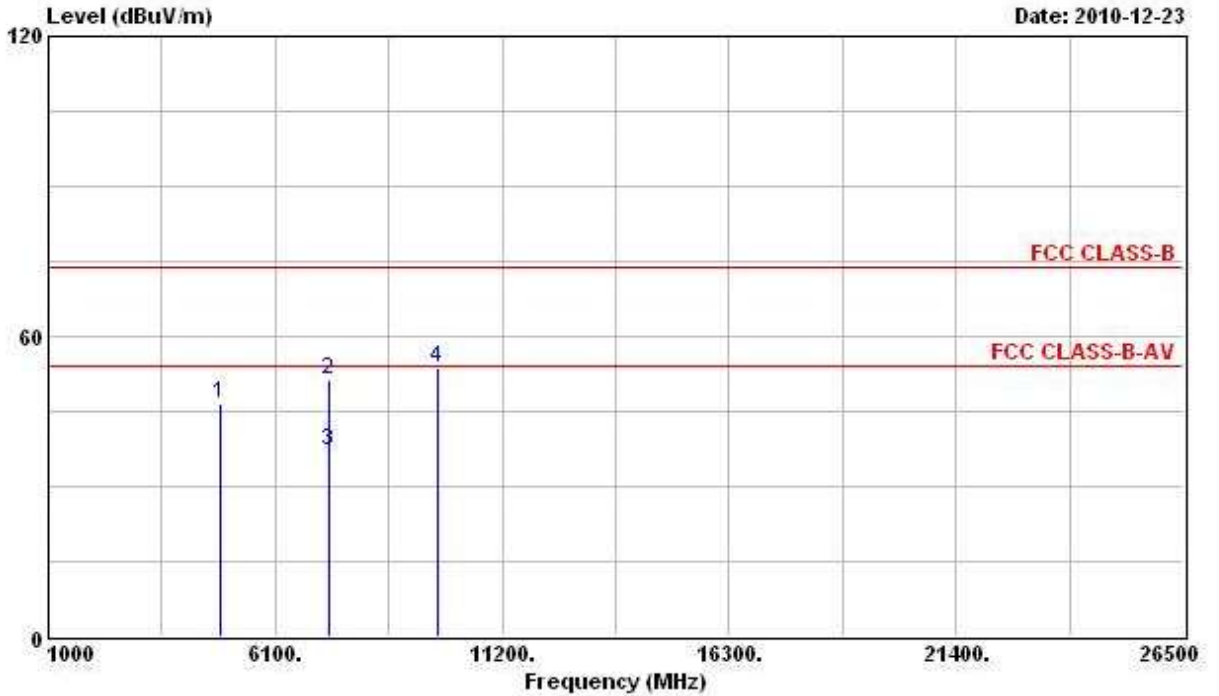

	Freq	Level	Over Limit	Limit Line	ReadAntenna Level	Antenna Factor	Cable Loss	Preamp Factor	Remark
	MHz	dBuV/m	dB	dBuV/m	dBuV	dB/m	dB	dB	
1	4874.000	46.70	-7.30	54.00	43.56	33.16	2.60	32.62	PK
2	7311.000	51.42	-22.58	74.00	43.99	35.68	4.65	32.90	Peak
3	7311.000	37.29	-16.71	54.00	29.86	35.68	4.65	32.90	Average
4	9748.000	53.76			43.06	38.62	5.42	33.34	Peak

Note: The item 4 is on un-restricted band, so the limit is -20dB for the field strength of the fundamental emissions (see section 3.6.7).

<b>Final Test Date</b>	Dec. 23, 2010	<b>Test Site No.</b>	03CH03-HY
<b>Temperature</b>	25.9°C	<b>Humidity</b>	53%
<b>Test Engineer</b>	Daniel	<b>Configuration</b>	802.11g Ch. 11

**Horizontal**

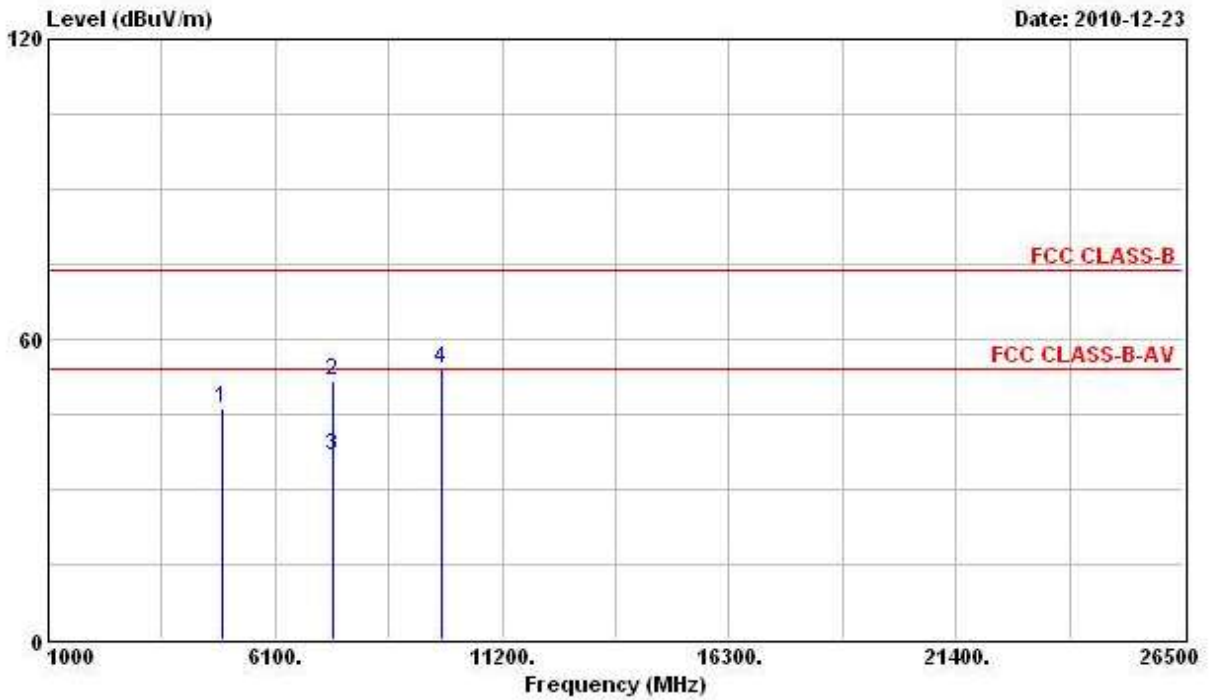

	Freq	Level	Over Limit	Limit Line	ReadAntenna Level	Antenna Factor	Cable Loss	Preamp Factor	Remark
	MHz	dBuV/m	dB	dBuV/m	dBuV	dB/m	dB	dB	
1	4924.000	46.32	-7.68	54.00	43.11	33.26	2.56	32.61	PK
2	7386.000	51.86	-22.14	74.00	44.16	35.87	4.75	32.92	Peak
3	7386.000	36.56	-17.44	54.00	28.86	35.87	4.75	32.92	Average
4	9848.000	54.00			43.05	38.79	5.49	33.33	Peak

Note: The item 4 is on un-restricted band, so the limit is -20dB for the field strength of the fundamental emissions (see section 3.6.7).

Vertical

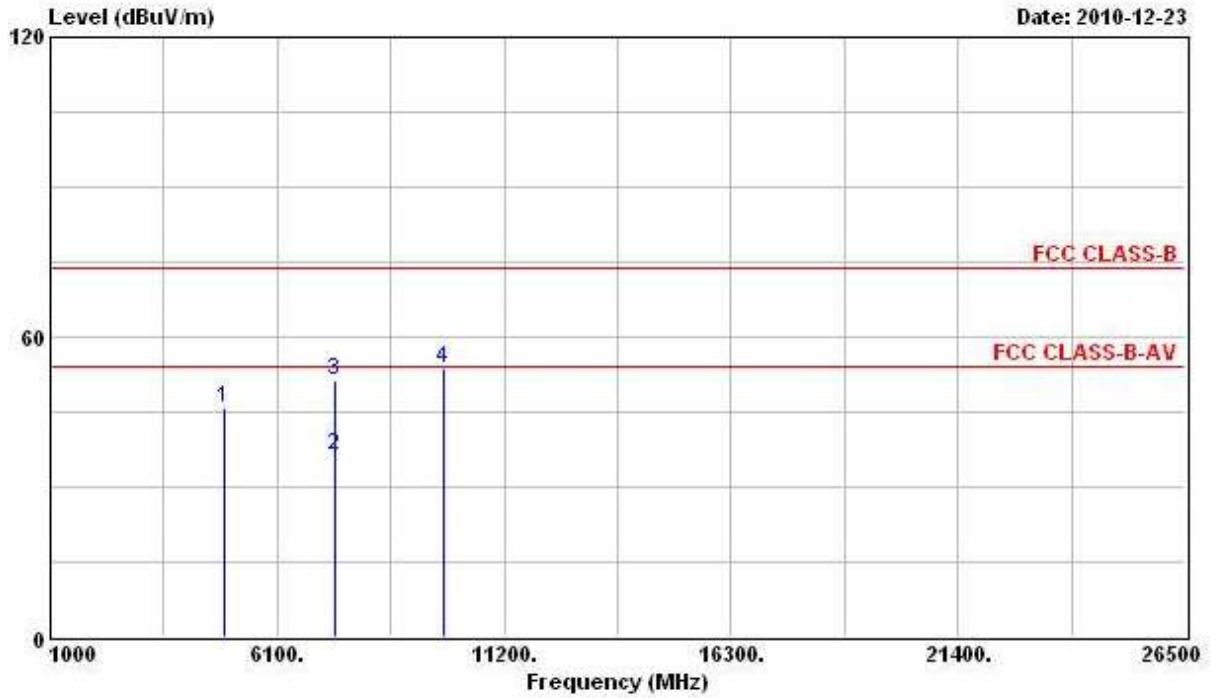

	Freq	Level	Over Limit	Limit Line	ReadAntenna Level	Antenna Factor	Cable Loss	Preamp Factor	Remark
	MHz	dBuV/m	dB	dBuV/m	dBuV	dB/m	dB	dB	
1	4924.000	45.99	-8.01	54.00	42.78	33.26	2.56	32.61	PK
2	7386.000	36.43	-17.57	54.00	28.73	35.87	4.75	32.92	Average
3	7386.000	51.42	-22.58	74.00	43.72	35.87	4.75	32.92	Peak
4	9848.000	53.84			42.89	38.79	5.49	33.33	Peak

Note: The item 4 is on un-restricted band, so the limit is -20dB for the field strength of the fundamental emissions (see section 3.6.7).

<b>Final Test Date</b>	Dec. 23, 2010	<b>Test Site No.</b>	03CH03-HY
<b>Temperature</b>	25.9°C	<b>Humidity</b>	53%
<b>Test Engineer</b>	Daniel	<b>Configuration</b>	802.11n Ch. 1 (20MHz)

**Horizontal**

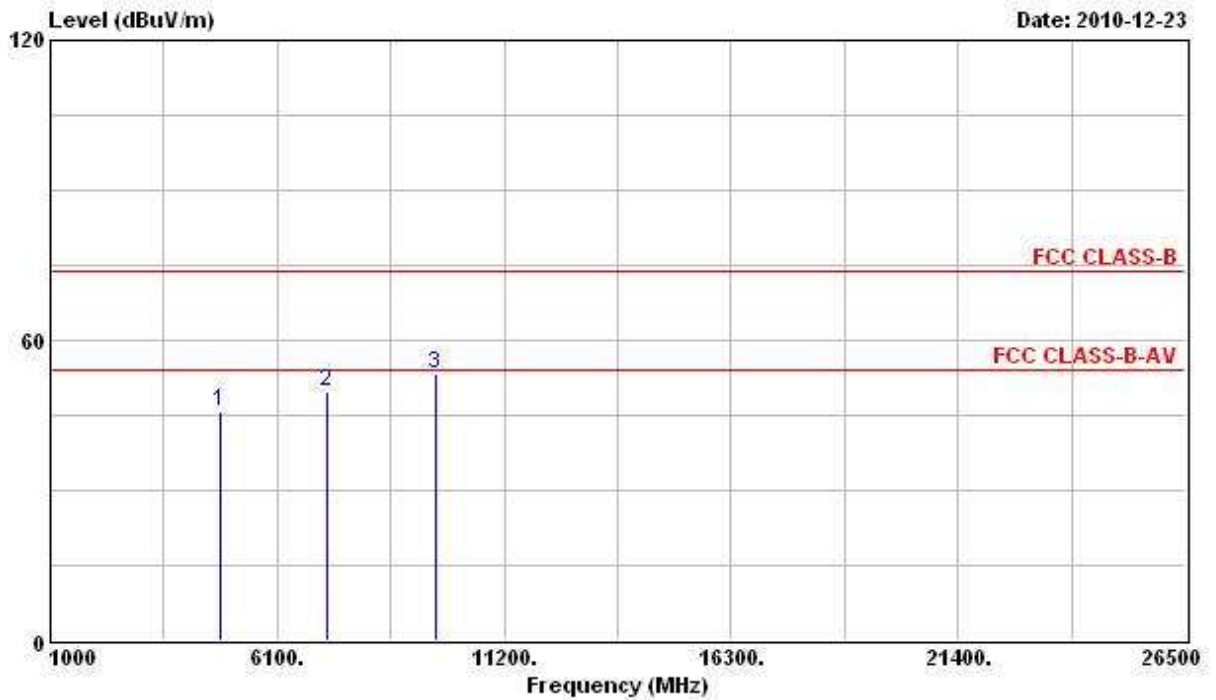

	<b>Freq</b>	<b>Level</b>	<b>Over</b>	<b>Limit</b>	<b>ReadAntenna</b>	<b>Cable</b>	<b>Preamp</b>	<b>Remark</b>
	<b>MHz</b>	<b>dBuV/m</b>	<b>dB</b>	<b>dBuV/m</b>	<b>dBuV</b>	<b>dB/m</b>	<b>dB</b>	<b>dB</b>
<b>1</b>	<b>4824.000</b>	<b>45.80</b>	<b>-8.20</b>	<b>54.00</b>	<b>42.68</b>	<b>33.06</b>	<b>2.70</b>	<b>32.63 PK</b>
<b>2</b>	<b>7236.000</b>	<b>49.91</b>			<b>42.71</b>	<b>35.53</b>	<b>4.55</b>	<b>32.89 Peak</b>
<b>3</b>	<b>9648.000</b>	<b>53.26</b>			<b>42.87</b>	<b>38.41</b>	<b>5.32</b>	<b>33.34 Peak</b>

Note: The items 2 and 3 are on un-restricted band, so the limit is -20dB for the field strength of the fundamental emissions (see section 3.6.7).

Vertical

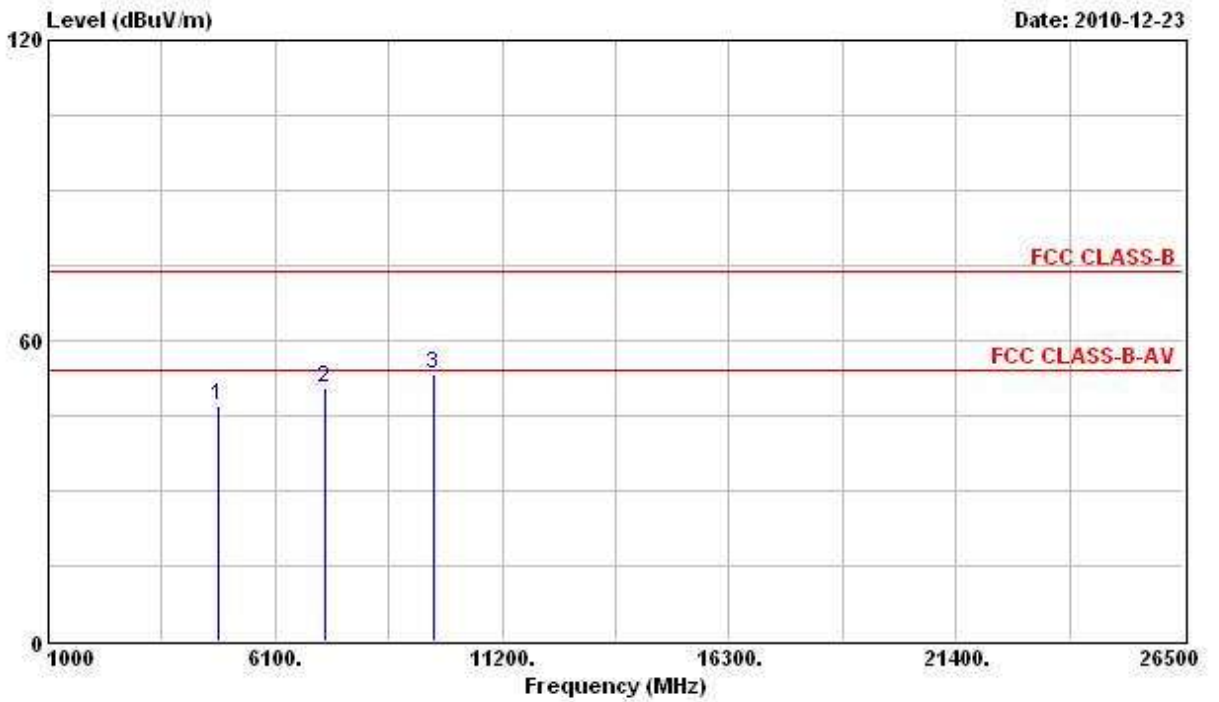

	Freq	Level	Over Limit	Limit Line	ReadAntenna Level	Antenna Factor	Cable Loss	Preamp Factor	Remark
	MHz	dBuV/m	dB	dBuV/m	dBuV	dB/m	dB	dB	
1	4824.000	46.91	-7.09	54.00	43.79	33.06	2.70	32.63	pk
2	7236.000	50.37			43.17	35.53	4.55	32.89	Peak
3	9648.000	53.36			42.97	38.41	5.32	33.34	Peak

Note: The items 2 and 3 are on un-restricted band, so the limit is -20dB for the field strength of the fundamental emissions (see section 3.6.7).

<b>Final Test Date</b>	Dec. 23, 2010	<b>Test Site No.</b>	03CH03-HY
<b>Temperature</b>	25.9°C	<b>Humidity</b>	53%
<b>Test Engineer</b>	Daniel	<b>Configuration</b>	802.11n Ch. 6 (20MHz)

**Horizontal**

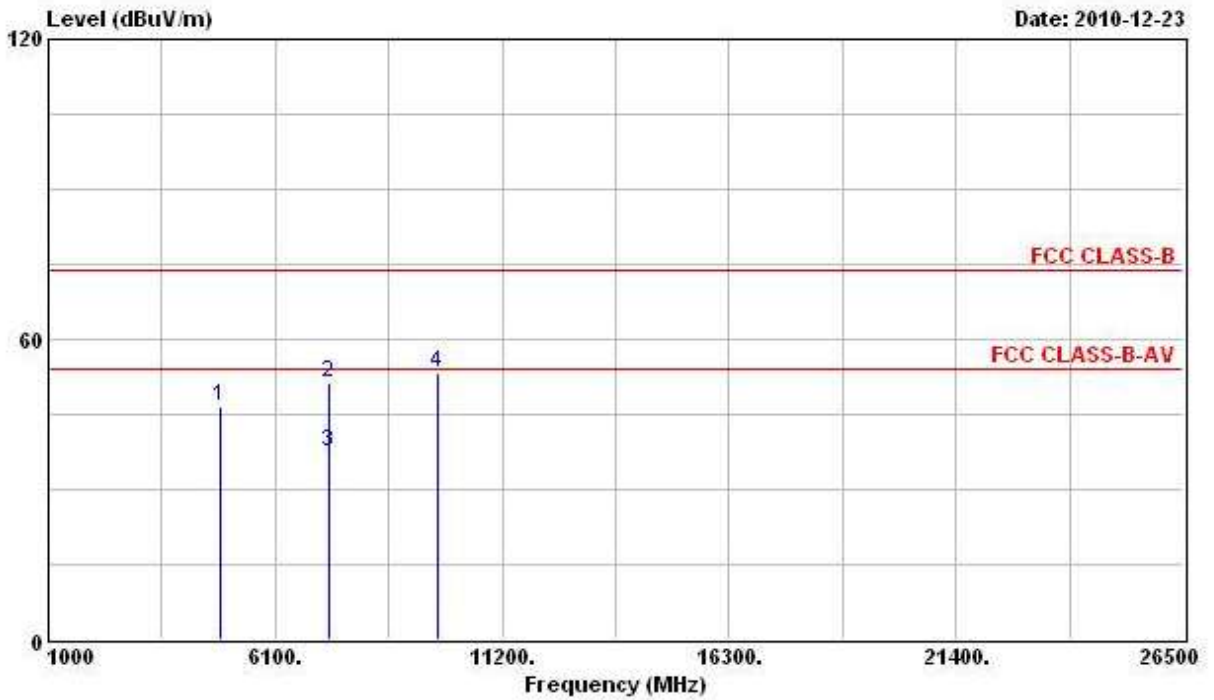

	<b>Freq</b>	<b>Level</b>	<b>Over Limit</b>	<b>Limit Line</b>	<b>ReadAntenna Level</b>	<b>Antenna Factor</b>	<b>Cable Loss</b>	<b>Preamp Factor</b>	<b>Remark</b>
	<b>MHz</b>	<b>dBuV/m</b>	<b>dB</b>	<b>dBuV/m</b>	<b>dBuV</b>	<b>dB/m</b>	<b>dB</b>	<b>dB</b>	
<b>1</b>	<b>4874.000</b>	<b>46.40</b>	<b>-27.60</b>	<b>74.00</b>	<b>43.26</b>	<b>33.16</b>	<b>2.60</b>	<b>32.62</b>	<b>PK</b>
<b>2</b>	<b>7311.000</b>	<b>51.25</b>	<b>-22.75</b>	<b>74.00</b>	<b>43.82</b>	<b>35.68</b>	<b>4.65</b>	<b>32.90</b>	<b>Peak</b>
<b>3</b>	<b>7311.000</b>	<b>37.53</b>	<b>-16.47</b>	<b>54.00</b>	<b>30.10</b>	<b>35.68</b>	<b>4.65</b>	<b>32.90</b>	<b>Average</b>
<b>4</b>	<b>9748.000</b>	<b>53.20</b>			<b>42.50</b>	<b>38.62</b>	<b>5.42</b>	<b>33.34</b>	<b>Peak</b>

Note: The item 4 is on un-restricted band, so the limit is -20dB for the field strength of the fundamental emissions (see section 3.6.7).

Vertical

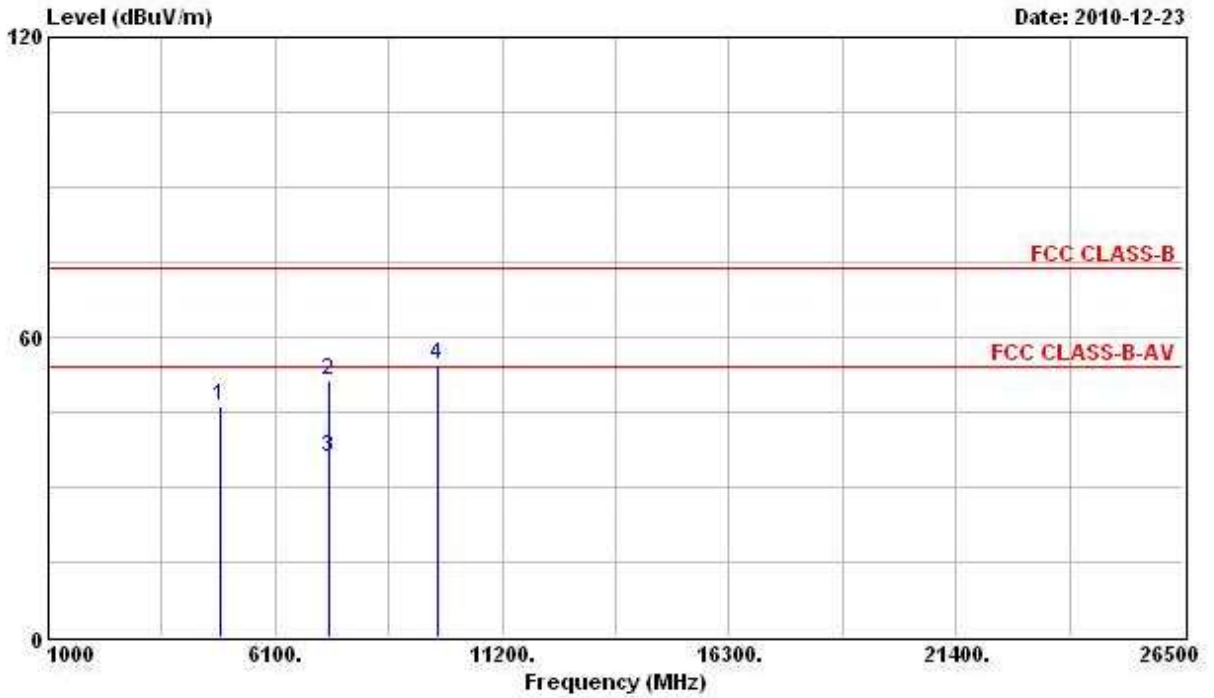

	Freq	Level	Over Limit	Limit Line	ReadAntenna Level	Antenna Factor	Cable Loss	Preamp Factor	Remark
	MHz	dBuV/m	dB	dBuV/m	dBuV	dB/m	dB	dB	
1	4874.000	46.13	-27.87	74.00	42.99	33.16	2.60	32.62	PK
2	7311.000	51.29	-22.71	74.00	43.86	35.68	4.65	32.90	Peak
3	7311.000	35.96	-18.04	54.00	28.53	35.68	4.65	32.90	Average
4	9748.000	54.62			43.92	38.62	5.42	33.34	Peak

Note: The item 4 is on un-restricted band, so the limit is -20dB for the field strength of the fundamental emissions (see section 3.6.7).



<b>Final Test Date</b>	Dec. 23, 2010	<b>Test Site No.</b>	03CH03-HY
<b>Temperature</b>	25.9°C	<b>Humidity</b>	53%
<b>Test Engineer</b>	Daniel	<b>Configuration</b>	802.11n Ch. 11 (20MHz)

**Horizontal**

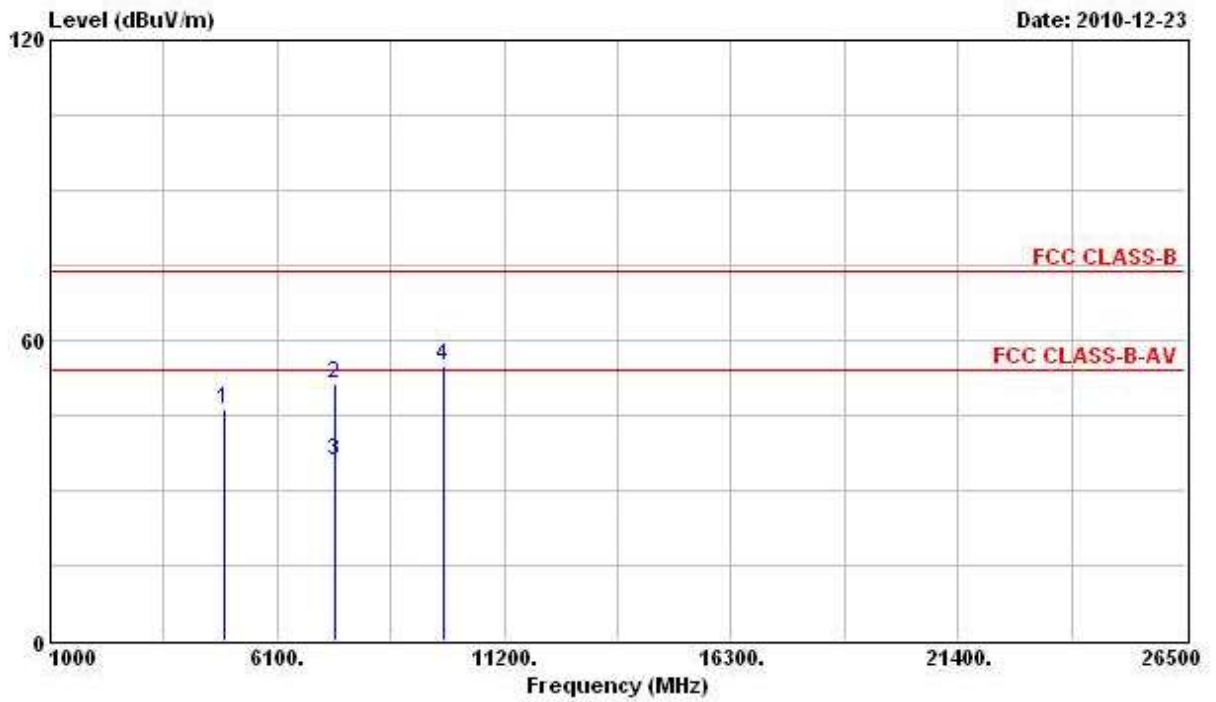

	<b>Freq</b>	<b>Level</b>	<b>Over</b>	<b>Limit</b>	<b>ReadAntenna</b>	<b>Cable</b>	<b>Preamp</b>	<b>Remark</b>
	<b>MHz</b>	<b>dBuV/m</b>	<b>Limit</b>	<b>Line</b>	<b>Level</b>	<b>Loss</b>	<b>Factor</b>	
			<b>dB</b>	<b>dBuV/m</b>	<b>dBuV</b>	<b>dB</b>	<b>dB</b>	
<b>1</b>	<b>4924.000</b>	<b>46.28</b>	<b>-7.72</b>	<b>54.00</b>	<b>43.07</b>	<b>33.26</b>	<b>2.56</b>	<b>32.61 PK</b>
<b>2</b>	<b>7386.000</b>	<b>51.49</b>	<b>-22.51</b>	<b>74.00</b>	<b>43.79</b>	<b>35.87</b>	<b>4.75</b>	<b>32.92 Peak</b>
<b>3</b>	<b>7386.000</b>	<b>35.91</b>	<b>-18.09</b>	<b>54.00</b>	<b>28.21</b>	<b>35.87</b>	<b>4.75</b>	<b>32.92 Average</b>
<b>4</b>	<b>9848.000</b>	<b>54.93</b>			<b>43.98</b>	<b>38.79</b>	<b>5.49</b>	<b>33.33 Peak</b>

Note: The item 4 is on un-restricted band, so the limit is -20dB for the field strength of the fundamental emissions (see section 3.6.7).

Vertical

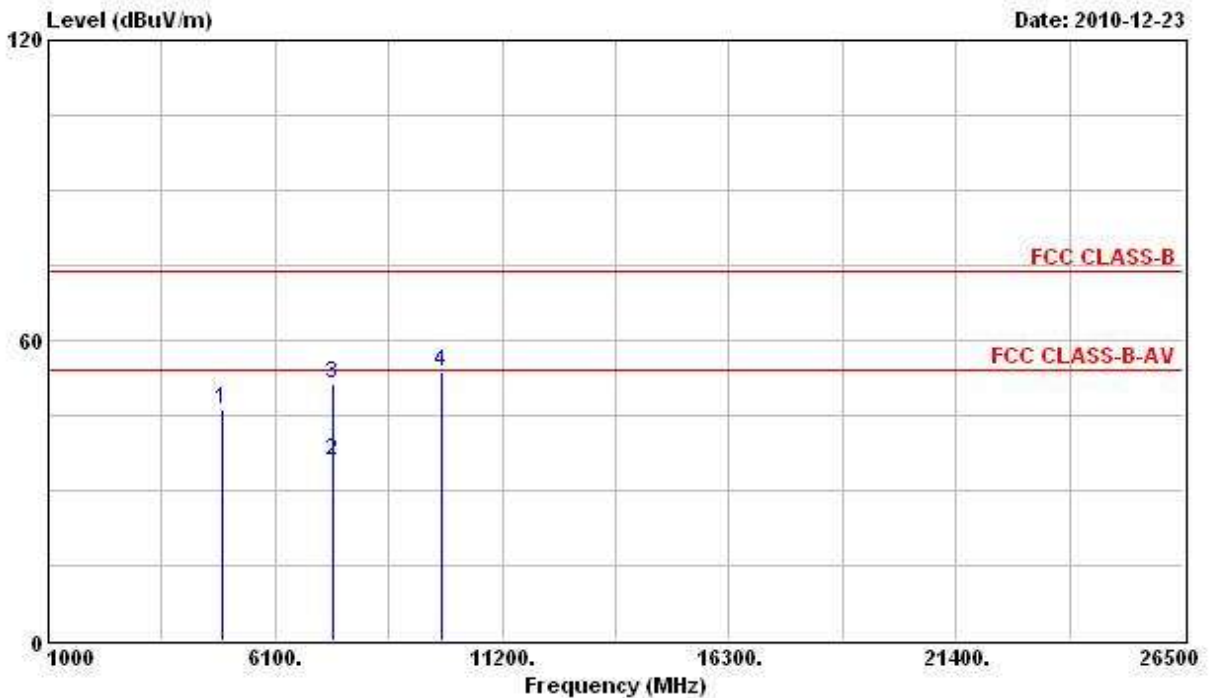

	Freq	Level	Over Limit	Limit Line	ReadAntenna Level	Antenna Factor	Cable Loss	Preamp Factor	Remark
	MHz	dBuV/m	dB	dBuV/m	dBuV	dB/m	dB	dB	
1	4924.000	46.04	-7.96	54.00	42.83	33.26	2.56	32.61	PK
2	7386.000	35.89	-18.11	54.00	28.19	35.87	4.75	32.92	Average
3	7386.000	51.38	-22.62	74.00	43.68	35.87	4.75	32.92	Peak
4	9848.000	53.53			42.58	38.79	5.49	33.33	Peak

Note: The item 4 is on un-restricted band, so the limit is -20dB for the field strength of the fundamental emissions (see section 3.6.7).

Emission level (dBuV/m) = 20 log Emission level (uV/m).

Corrected Reading: Antenna Factor + Cable Loss + Read Level - Preamp Factor = Level.

**3.7 Band Edge and Fundamental Emissions Measurement**

**3.7.1 Limit**

In any 100kHz bandwidth outside the frequency band in which the spread spectrum or digitally modulated intentional radiator is operating, the radio frequency power that is produced by the intentional radiator shall be at least 20dB below that in the 100kHz bandwidth within the band that contains the highest level of the desired power, based on either an RF conducted or a radiated measurement. If the transmitter measurement is based on the maximum conducted output power, the attenuation required under this paragraph shall be 30dB instead of 20dB. In addition, radiated emissions which fall in section 15.205(a) the restricted bands must also comply with the radiated emission limit specified in section 15.209(a).

<b>Frequencies (MHz)</b>	<b>Field Strength (micorvolts/meter)</b>	<b>Measurement Distance (meters)</b>
0.009~0.490	2400/F(KHz)	300
0.490~1.705	24000/F(KHz)	30
1.705~30.0	30	30
30~88	100	3
88~216	150	3
216~960	200	3
Above 960	500	3

**3.7.2 Measuring Instruments and Setting**

Please refer to section 4 of equipments list in this report. The following table is the setting of the spectrum analyzer.

<b>Spectrum Parameter</b>	<b>Setting</b>
Attenuation	Auto
Span Frequency	100 MHz
RB / VB (Emission in restricted band)	1MHz / 1MHz for Peak, 1 MHz / 10Hz for Average
RB / VB (Emission in non-restricted band)	11MHz / 1MHz for Peak

**3.7.3 Test Procedures**

1. The test procedure is the same as section 3.5.3; only the frequency range investigated is limited to 100MHz around band edges.
2. In case the emission is fail due to the used RB/VB is too wide, marker-delta method of FCC Public Notice DA00-705 will be followed.

**3.7.4 Test Setup Layout**

This test setup layout is the same as that shown in section 3.5.4.

**3.7.5 Test Deviation**

There is no deviation with the original standard.

**3.7.6 EUT Operation during Test**

The EUT was programmed to be in continuously transmitting mode.

**3.7.7 Test Result of Band Edge and Fundamental Emissions**

<b>Final Test Date</b>	Dec. 23, 2010	<b>Test Site No.</b>	03CH03-HY
<b>Temperature</b>	25.9°C	<b>Humidity</b>	53%
<b>Test Engineer</b>	Daniel	<b>Configuration</b>	802.11b Ch. 1, 6, 11

**Channel 1**

	<b>Freq</b>	<b>Level</b>	<b>Over Limit</b>	<b>Limit Line</b>	<b>ReadAntenna Level</b>	<b>Antenna Factor</b>	<b>Cable Loss</b>	<b>Preamp Factor</b>	<b>Remark</b>
	<b>MHz</b>	<b>dBuV/m</b>	<b>dB</b>	<b>dBuV/m</b>	<b>dBuV</b>	<b>dB/m</b>	<b>dB</b>	<b>dB</b>	
<b>1</b>	<b>2390.000</b>	<b>63.86</b>	<b>-10.14</b>	<b>74.00</b>	<b>33.14</b>	<b>28.13</b>	<b>2.58</b>	<b>0.00</b>	<b>Peak</b>
<b>2 X</b>	<b>2413.170</b>	<b>117.90</b>			<b>87.15</b>	<b>28.16</b>	<b>2.58</b>	<b>0.00</b>	<b>Peak</b>
<b>1</b>	<b>2390.000</b>	<b>50.75</b>	<b>-3.25</b>	<b>54.00</b>	<b>20.03</b>	<b>28.13</b>	<b>2.58</b>	<b>0.00</b>	<b>Average</b>
<b>2 ☒</b>	<b>2412.980</b>	<b>108.14</b>			<b>77.39</b>	<b>28.16</b>	<b>2.58</b>	<b>0.00</b>	<b>Average</b>

The item 2 is Fundamental Emissions.

**Channel 6**

	<b>Freq</b>	<b>Level</b>	<b>Over Limit</b>	<b>Limit Line</b>	<b>ReadAntenna Level</b>	<b>Antenna Factor</b>	<b>Cable Loss</b>	<b>Preamp Factor</b>	<b>Remark</b>
	<b>MHz</b>	<b>dBuV/m</b>	<b>dB</b>	<b>dBuV/m</b>	<b>dBuV</b>	<b>dB/m</b>	<b>dB</b>	<b>dB</b>	
<b>1 X</b>	<b>2438.060</b>	<b>116.61</b>			<b>85.79</b>	<b>28.22</b>	<b>2.61</b>	<b>0.00</b>	<b>Peak</b>
<b>1 X</b>	<b>2437.490</b>	<b>107.08</b>			<b>76.26</b>	<b>28.22</b>	<b>2.61</b>	<b>0.00</b>	<b>Average</b>

The item 1 is Fundamental Emissions.

**Channel 11**

	<b>Freq</b>	<b>Level</b>	<b>Over Limit</b>	<b>Limit Line</b>	<b>ReadAntenna Level</b>	<b>Antenna Factor</b>	<b>Cable Loss</b>	<b>Preamp Factor</b>	<b>Remark</b>
	<b>MHz</b>	<b>dBuV/m</b>	<b>dB</b>	<b>dBuV/m</b>	<b>dBuV</b>	<b>dB/m</b>	<b>dB</b>	<b>dB</b>	
<b>1 X</b>	<b>2460.860</b>	<b>117.92</b>			<b>87.05</b>	<b>28.24</b>	<b>2.63</b>	<b>0.00</b>	<b>Peak</b>
<b>2</b>	<b>2483.500</b>	<b>64.36</b>	<b>-9.64</b>	<b>74.00</b>	<b>33.46</b>	<b>28.27</b>	<b>2.63</b>	<b>0.00</b>	<b>Peak</b>
<b>1 ☒</b>	<b>2462.570</b>	<b>108.29</b>			<b>77.42</b>	<b>28.24</b>	<b>2.63</b>	<b>0.00</b>	<b>Average</b>
<b>2</b>	<b>2483.500</b>	<b>52.78</b>	<b>-1.22</b>	<b>54.00</b>	<b>21.88</b>	<b>28.27</b>	<b>2.63</b>	<b>0.00</b>	<b>Average</b>

The item 1 is Fundamental Emissions.

Note:

Emission level (dBuV/m) = 20 log Emission level (uV/m).

Corrected Reading: Antenna Factor + Cable Loss + Read Level - Preamp Factor = Level.

<b>Final Test Date</b>	Dec. 23, 2010	<b>Test Site No.</b>	03CH03-HY
<b>Temperature</b>	25.9°C	<b>Humidity</b>	53%
<b>Test Engineer</b>	Daniel	<b>Configuration</b>	802.11g Ch. 1, 6, 11

**Channel 1**

	<b>Freq</b>	<b>Level</b>	<b>Over Limit</b>	<b>Limit Line</b>	<b>ReadAntenna Level</b>	<b>Antenna Factor</b>	<b>Cable Loss</b>	<b>Preamp Factor</b>	<b>Remark</b>
	<b>MHz</b>	<b>dBuV/m</b>	<b>dB</b>	<b>dBuV/m</b>	<b>dBuV</b>	<b>dB/m</b>	<b>dB</b>	<b>dB</b>	
<b>1</b>	<b>2390.000</b>	<b>73.39</b>	<b>-0.61</b>	<b>74.00</b>	<b>42.67</b>	<b>28.13</b>	<b>2.58</b>	<b>0.00</b>	<b>Peak</b>
<b>2 X</b>	<b>2413.170</b>	<b>112.19</b>			<b>81.44</b>	<b>28.16</b>	<b>2.58</b>	<b>0.00</b>	<b>Peak</b>
<b>1</b>	<b>2390.000</b>	<b>52.71</b>	<b>-1.29</b>	<b>54.00</b>	<b>21.99</b>	<b>28.13</b>	<b>2.58</b>	<b>0.00</b>	<b>Average</b>
<b>2 X</b>	<b>2410.890</b>	<b>101.25</b>			<b>70.50</b>	<b>28.16</b>	<b>2.58</b>	<b>0.00</b>	<b>Average</b>

The item 2 is Fundamental Emissions.

**Channel 6**

	<b>Freq</b>	<b>Level</b>	<b>Over Limit</b>	<b>Limit Line</b>	<b>ReadAntenna Level</b>	<b>Antenna Factor</b>	<b>Cable Loss</b>	<b>Preamp Factor</b>	<b>Remark</b>
	<b>MHz</b>	<b>dBuV/m</b>	<b>dB</b>	<b>dBuV/m</b>	<b>dBuV</b>	<b>dB/m</b>	<b>dB</b>	<b>dB</b>	
<b>1 X</b>	<b>2436.730</b>	<b>112.66</b>			<b>81.84</b>	<b>28.22</b>	<b>2.61</b>	<b>0.00</b>	<b>Peak</b>
<b>1 X</b>	<b>2438.250</b>	<b>100.65</b>			<b>69.83</b>	<b>28.22</b>	<b>2.61</b>	<b>0.00</b>	<b>Average</b>

The item 1 is Fundamental Emissions.

**Channel 11**

	<b>Freq</b>	<b>Level</b>	<b>Over Limit</b>	<b>Limit Line</b>	<b>ReadAntenna Level</b>	<b>Antenna Factor</b>	<b>Cable Loss</b>	<b>Preamp Factor</b>	<b>Remark</b>
	<b>MHz</b>	<b>dBuV/m</b>	<b>dB</b>	<b>dBuV/m</b>	<b>dBuV</b>	<b>dB/m</b>	<b>dB</b>	<b>dB</b>	
<b>1 X</b>	<b>2461.050</b>	<b>111.62</b>			<b>80.75</b>	<b>28.24</b>	<b>2.63</b>	<b>0.00</b>	<b>Peak</b>
<b>2</b>	<b>2483.850</b>	<b>70.97</b>	<b>-3.03</b>	<b>74.00</b>	<b>40.07</b>	<b>28.27</b>	<b>2.63</b>	<b>0.00</b>	<b>Peak</b>
<b>1 X</b>	<b>2463.140</b>	<b>100.41</b>			<b>69.54</b>	<b>28.24</b>	<b>2.63</b>	<b>0.00</b>	<b>Average</b>
<b>2</b>	<b>2483.500</b>	<b>52.84</b>	<b>-1.16</b>	<b>54.00</b>	<b>21.94</b>	<b>28.27</b>	<b>2.63</b>	<b>0.00</b>	<b>Average</b>

The item 1 is Fundamental Emissions.

Note:

Emission level (dBuV/m) = 20 log Emission level (uV/m).

Corrected Reading: Antenna Factor + Cable Loss + Read Level - Preamp Factor = Level.

<b>Final Test Date</b>	Dec. 23, 2010	<b>Test Site No.</b>	03CH03-HY
<b>Temperature</b>	25.9°C	<b>Humidity</b>	53%
<b>Test Engineer</b>	Daniel	<b>Configuration</b>	802.11n Ch. 1, 6, 11 (20MHz)

**Channel 1**

	<b>Freq</b>	<b>Level</b>	<b>Over Limit</b>	<b>Limit Line</b>	<b>ReadAntenna Level</b>	<b>Antenna Factor</b>	<b>Cable Loss</b>	<b>Preamp Factor</b>	<b>Remark</b>
	<b>MHz</b>	<b>dBuV/m</b>	<b>dB</b>	<b>dBuV/m</b>	<b>dBuV</b>	<b>dB/m</b>	<b>dB</b>	<b>dB</b>	
<b>1</b>	<b>2389.610</b>	<b>72.74</b>	<b>-1.26</b>	<b>74.00</b>	<b>42.02</b>	<b>28.13</b>	<b>2.58</b>	<b>0.00</b>	<b>Peak</b>
<b>2 X</b>	<b>2410.890</b>	<b>111.59</b>			<b>80.84</b>	<b>28.16</b>	<b>2.58</b>	<b>0.00</b>	<b>Peak</b>
<b>1</b>	<b>2390.000</b>	<b>52.78</b>	<b>-1.22</b>	<b>54.00</b>	<b>22.06</b>	<b>28.13</b>	<b>2.58</b>	<b>0.00</b>	<b>Average</b>
<b>2 X</b>	<b>2410.700</b>	<b>99.48</b>			<b>68.73</b>	<b>28.16</b>	<b>2.58</b>	<b>0.00</b>	<b>Average</b>

The item 2 is Fundamental Emissions.

**Channel 6**

	<b>Freq</b>	<b>Level</b>	<b>Over Limit</b>	<b>Limit Line</b>	<b>ReadAntenna Level</b>	<b>Antenna Factor</b>	<b>Cable Loss</b>	<b>Preamp Factor</b>	<b>Remark</b>
	<b>MHz</b>	<b>dBuV/m</b>	<b>dB</b>	<b>dBuV/m</b>	<b>dBuV</b>	<b>dB/m</b>	<b>dB</b>	<b>dB</b>	
<b>1 X</b>	<b>2437.490</b>	<b>110.34</b>			<b>79.52</b>	<b>28.22</b>	<b>2.61</b>	<b>0.00</b>	<b>Peak</b>
<b>1 X</b>	<b>2438.060</b>	<b>98.54</b>			<b>67.72</b>	<b>28.22</b>	<b>2.61</b>	<b>0.00</b>	<b>Average</b>

The item 1 is Fundamental Emissions.

**Channel 11**

	<b>Freq</b>	<b>Level</b>	<b>Over Limit</b>	<b>Limit Line</b>	<b>ReadAntenna Level</b>	<b>Antenna Factor</b>	<b>Cable Loss</b>	<b>Preamp Factor</b>	<b>Remark</b>
	<b>MHz</b>	<b>dBuV/m</b>	<b>dB</b>	<b>dBuV/m</b>	<b>dBuV</b>	<b>dB/m</b>	<b>dB</b>	<b>dB</b>	
<b>1 X</b>	<b>2461.810</b>	<b>109.80</b>			<b>78.93</b>	<b>28.24</b>	<b>2.63</b>	<b>0.00</b>	<b>Peak</b>
<b>2</b>	<b>2485.180</b>	<b>68.12</b>	<b>-5.88</b>	<b>74.00</b>	<b>37.22</b>	<b>28.27</b>	<b>2.63</b>	<b>0.00</b>	<b>Peak</b>
<b>1 X</b>	<b>2463.140</b>	<b>98.65</b>			<b>67.78</b>	<b>28.24</b>	<b>2.63</b>	<b>0.00</b>	<b>Average</b>
<b>2</b>	<b>2483.500</b>	<b>51.87</b>	<b>-2.13</b>	<b>54.00</b>	<b>20.97</b>	<b>28.27</b>	<b>2.63</b>	<b>0.00</b>	<b>Average</b>

The item 1 is Fundamental Emissions.

Note:

Emission level (dBuV/m) = 20 log Emission level (uV/m).

Corrected Reading: Antenna Factor + Cable Loss + Read Level - Preamp Factor = Level.

**For Emission not in Restricted Band**

<b>Final Test Date</b>	Dec. 24, 2010	<b>Test Site No.</b>	TH01-HY
<b>Temperature</b>	22.5°C	<b>Humidity</b>	63%
<b>Test Engineer</b>	Ian	<b>Configuration</b>	802.11b/g/n

**Low Band Edge Plot on Configuration IEEE 802.11b / 2412 MHz**

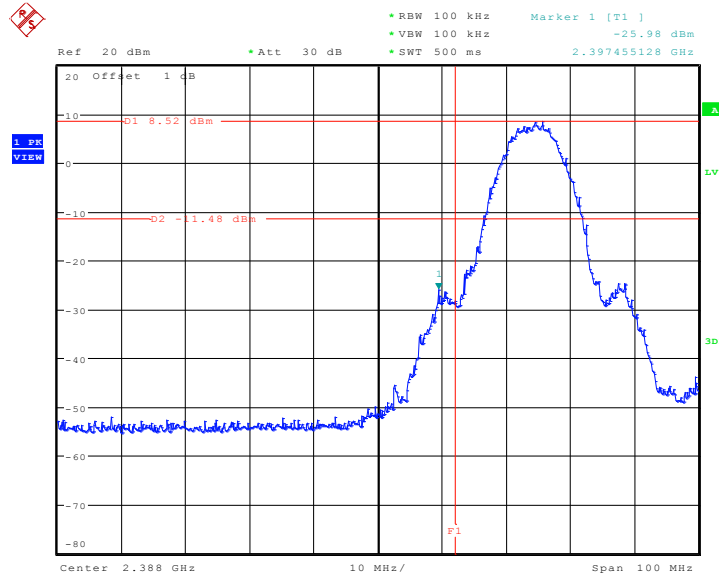

Date: 24.DEC.2010 10:54:11

**High Band Edge Plot on Configuration IEEE 802.11b / 2462 MHz**

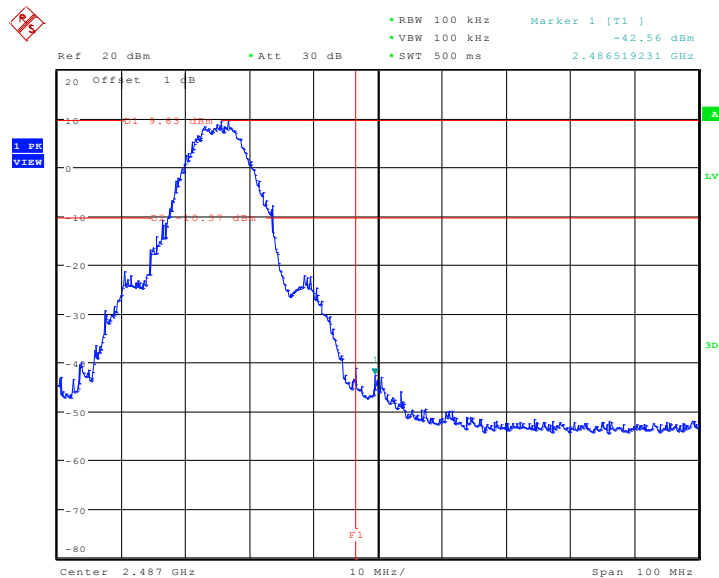

Date: 24.DEC.2010 11:14:52

Low Band Edge Plot on Configuration IEEE 802.11g / 2412 MHz

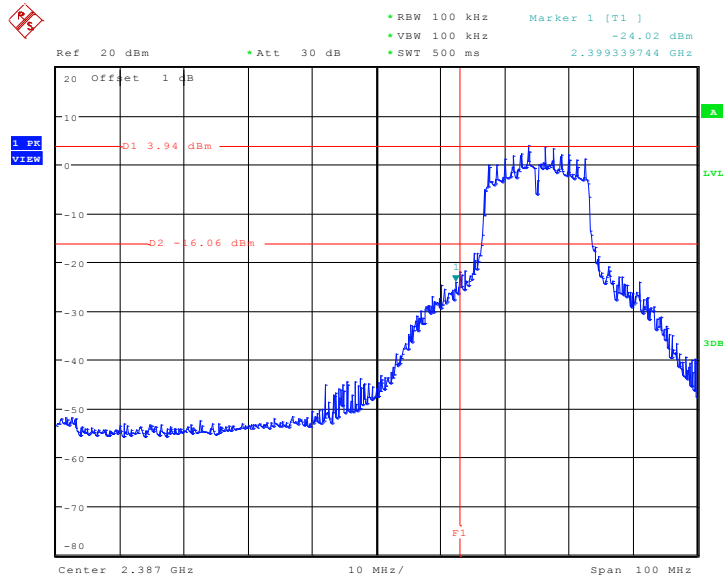

Date: 24.DEC.2010 11:25:54

High Band Edge Plot on Configuration IEEE 802.11g / 2462 MHz

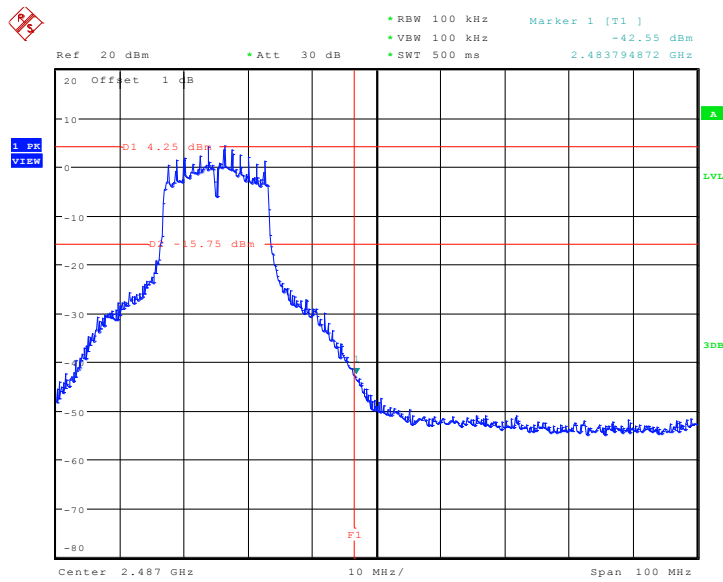

Date: 24.DEC.2010 11:37:56



Low Band Edge Plot on Configuration of IEEE 802.11n (20MHz) / 2412 MHz

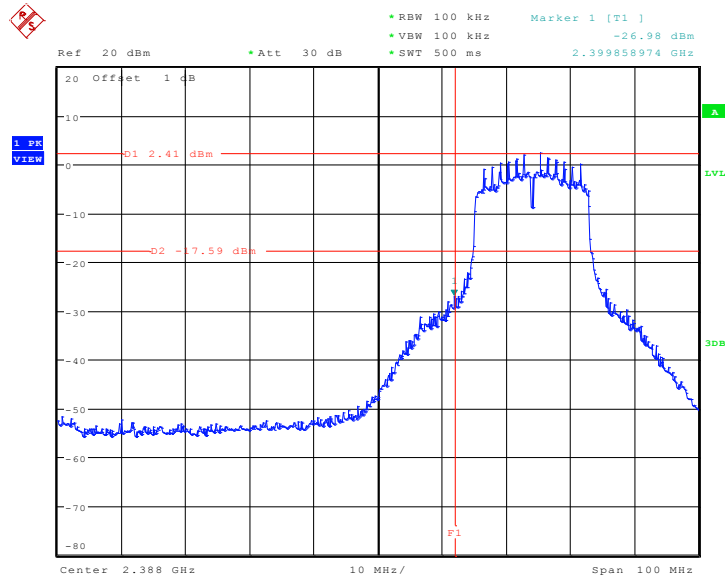

Date: 24.DEC.2010 13:49:53

High Band Edge Plot on Configuration of IEEE 802.11n (20MHz) / 2462 MHz

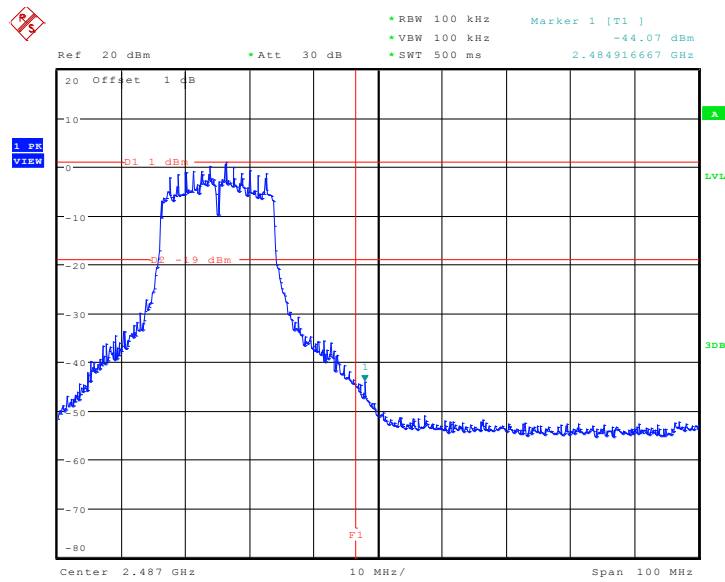

Date: 24.DEC.2010 13:59:06

### **3.8 Antenna Requirements**

#### **3.8.1 Limit**

Except for special regulations, the Low-power Radio-frequency Devices must not be equipped with any jacket for installing an antenna with extension cable. An intentional radiator shall be designed to ensure that no antenna other than that furnished by the responsible party shall be used with the device. The use of a permanently attached antenna or of an antenna that uses a unique coupling to the intentional radiator shall be considered sufficient to comply with the provisions of this Section. The manufacturer may design the unit so that the user can replace a broken antenna, but the use of a standard antenna jack or electrical connector is prohibited.

#### **3.8.2 Antenna Connector Construction**

Please refer to section 2.3 in this test report; antenna connector complied with the requirements.

**4 LIST OF MEASURING EQUIPMENTS**

Instrument	Manufacturer	Model No.	Serial No.	Characteristics	Calibration Date	Remark
EMC Receiver	R&S	ESCS 30	100174	9kHz – 2.75GHz	Apr. 06, 2010	Conduction (CO04-HY)
LISN	MessTec	NNB-2/16Z	99041	9kHz – 30MHz	Mar. 23, 2010	Conduction (CO04-HY)
LISN (Support Unit)	EMCO	3810/2NM	9703-1839	9kHz – 30MHz	Apr. 29, 2010	Conduction (CO04-HY)
RF Cable-CON	UTIFLEX	3102-26886-4	CB049	9kHz – 30MHz	Apr. 20, 2010	Conduction (CO04-HY)

Note: Calibration Interval of instruments listed above is one year.

Instrument	Manufacturer	Model No.	Serial No.	Characteristics	Calibration Date	Remark
Spectrum Analyzer	R&S	FSU26.5	100015	20Hz ~ 26.5GHz	Nov. 19, 2010	Conducted (TH01-HY)
DC Power Source	G.W.	GPC-6030D	C671845	DC 1V ~ 60V	Apr. 16, 2010	Conducted (TH01-HY)
Temp. and Humidity Chamber	Giant Force	GTH-225-20-S	MAB0103-001	N/A	Oct. 22, 2010	Conducted (TH01-HY)
RF CABLE-1m	Jye Bao	RG142	CB034-1m	20MHz ~ 7GHz	Dec. 02, 2010	Conducted (TH01-HY)
RF CABLE-2m	Jye Bao	RG142	CB035-2m	20MHz ~ 1GHz	Dec. 02, 2010	Conducted (TH01-HY)
Signal Generator	R&S	SMR40	100116	10MHz ~ 40GHz	Mar. 30, 2010	Conducted (TH01-HY)
Power Sensor	Anritsu	MA2411B	0917017	300MHz~40GHz	Dec. 03, 2010	Conducted (TH01-HY)
Power Meter	Anritsu	ML2495A	0949003	300MHz~40GHz	Dec. 03, 2010	Conducted (TH01-HY)

Note: Calibration Interval of instruments listed above is one year.

Instrument	Manufacturer	Model No.	Serial No.	Characteristics	Calibration Date	Remark
AC Power Source	HPC	HPA-500W	HPA-9100024	AC 0 ~ 300V	Jul. 26, 2010*	Conducted (TH01-HY)

Note: Calibration Interval of instruments listed above is two year

Instrument	Manufacturer	Model No.	Serial No.	Characteristics	Calibration Date	Remark
Spectrum Analyzer	R&S	FSP40	100305/040	9 kHz - 40GHz	Feb. 02, 2010	Radiation (03CH03-HY)
3m Semi Anechoic Chamber	SIDT FRANKONIA	SAC-3M	03CH03-HY	30 MHz - 1 GHz 3m	May. 01, 2010	Radiation (03CH03-HY)
Amplifier	Agilent	8447D	2944A11146	100 kHz – 1.3 GHz	Jul. 23, 2010	Radiation (03CH03-HY)
Amplifier	Agilent	8449B	3008A02373	1GHz – 26.5 GHz	Jul. 23, 2010	Radiation (03CH03-HY)
Horn Antenna	ETS-LINDGREN	3117	00091920	1GHz~18GHz	Oct. 21, 2010	Radiation (03CH03-HY)
RF Cable-R03m	Jye Bao	RG142	CB021	30MHz ~ 1GHz	Feb. 26, 2010	Radiation (03CH03-HY)
RF Cable-HIGH	SUHNER	SUCOFLEX106	03CH03-HY	1GHz~40GHz	Feb. 26, 2010	Radiation (03CH03-HY)
Bilog Antenna	SCHAFFNER	CBL61128	2723	30 MHz - 2 GHz	Oct. 16, 2010	Radiation (03CH03-HY)

Note: Calibration Interval of instruments listed above is one year.

Instrument	Manufacturer	Model No.	Serial No.	Characteristics	Calibration Date	Remark
Loop Antenna	R&S	HFH2-Z2	860004/001	9 kHz - 30 MHz	Jul. 29, 2010*	Radiation (03CH03-HY)

Note: Calibration Interval of instruments listed above is two year.

## 5 TEST LOCATION

SHIJR	ADD : 6Fl., No. 106, Sec. 1, Shintai 5th Rd., Shijr City, Taipei, Taiwan 221, R.O.C. TEL : 886-2-2696-2468 FAX : 886-2-2696-2255
HWA YA	ADD : No. 52, Hwa Ya 1st Rd., Kwei-Shan Hsiang, Tao Yuan Hsien, Taiwan, R.O.C. TEL : 886-3-327-3456 FAX : 886-3-318-0055
LINKOU	ADD : No. 30-2, Dingfu Tsuen, Linkou Shiang, Taipei, Taiwan 244, R.O.C TEL : 886-2-2601-1640 FAX : 886-2-2601-1695
DUNGHU	ADD : No. 3, Lane 238, Kangle St., Neihu Chiu, Taipei, Taiwan 114, R.O.C. TEL : 886-2-2631-4739 FAX : 886-2-2631-9740
JUNGHE	ADD : 7Fl., No. 758, Jungjeng Rd., Junghe City, Taipei, Taiwan 235, R.O.C. TEL : 886-2-8227-2020 FAX : 886-2-8227-2626
NEIHU	ADD : 4Fl., No. 339, Hsin Hu 2 <sup>nd</sup> Rd., Taipei 114, Taiwan, R.O.C. TEL : 886-2-2794-8886 FAX : 886-2-2794-9777
JHUBEI	ADD : No.8, Lane 724, Bo-ai St., Jhubei City, HsinChu County 302, Taiwan, R.O.C. TEL : 886-3-656-9065 FAX : 886-3-656-9085

6 TAF CERTIFICATE OF ACCREDITATION



Certificate No. : L1190-100529

**財團法人全國認證基金會**  
**Taiwan Accreditation Foundation**

## Certificate of Accreditation

This is to certify that

**Sporton International Inc.**  
**EMC & Wireless Communications Laboratory**  
No.52, Hwa Ya 1st Rd., Hwa Ya Technology Park, Kwei-Shan Hsiang, Tao Yuan Hsien,  
Taiwan, R.O.C.

**is accredited in respect of laboratory**

<b>Accreditation Criteria</b>	: ISO/IEC 17025:2005
<b>Accreditation Number</b>	: 1190
<b>Originally Accredited</b>	: December 15, 2003
<b>Effective Period</b>	: January 10, 2010 to January 09, 2013
<b>Accredited Scope</b>	: Testing Field, see described in the Appendix
<b>Specific Accreditation Program</b>	: Accreditation Program for Designated Testing Laboratory for Commodities Inspection Accreditation Program for Telecommunication Equipment Testing Laboratory Accreditation Program for BSMI Mutual Recognition Arrangement with Foreign Authorities



Jay-San Chen  
President, Taiwan Accreditation Foundation  
Date : May 29, 2010

PI, total 23 pages

The Appendix forms an integral part of this Certificate, which shall be invalid when use without the Appendix