

FCC ID: GKRM990

EUT: 19" COLOR MONITOR

COMPAL ELECTRONIES, INC.

USER'S MANUAL

EXHIBIT C

# Table of Contents

<b>Chapter 1</b>	<b>1</b>
Introduction	1
Unpacking	1
<b>Getting Started</b>	<b>2</b>
Choosing a Workstation	2
The AC Connection	3
The Signal Cable Connection	3
Monitor Adjustments	4
<b>Chapter 2</b>	<b>5</b>
Adjusting the Brightness and Contrast	6
The On-Screen Display (OSD)	7
Color Temperature Setup	9
OSD Window Status	11
Reset and Degauss	12
Self-Test Screen	13
Summary of OSD Icons	14
<b>Appendix A</b>	<b>16</b>
Technical Information	16
Monitor Specifications	16
Preset Mode Timing	18
Trouble Shooting	19



## Getting Started

This chapter covers setting up the monitor and stand in a suitable workplace, and connecting the power cord and signal cable.



## Choosing a Workstation

Keep the following in mind when choosing a work place for the Monitor.

- The monitor is quite heavy and should be placed on a sturdy counter-top with a stable and even surface.
- Access to an electrical outlet and telephone jack.
- Ensure at least three inches clearance at the rear of the monitor to allow for sufficient airflow.
- Position the Monitor a little *above* eye-level to reduce neck-strain.
- Do not place near a window. Exposing the Monitor to direct sunlight for extended periods may damage the unit.
- You may want to use a desk lamp to adjust the ambient lighting for your viewing comfort.
- A viewing filter is recommended to reduce eye stress and fatigue.

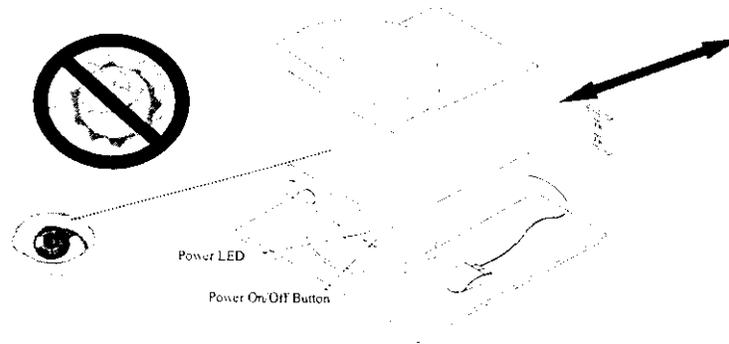
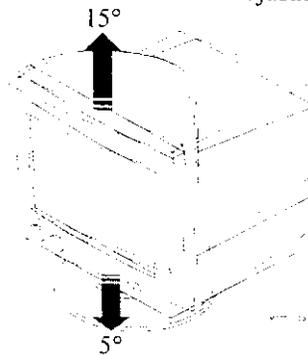

*Figure 2: The Workstation*



## Monitor Adjustments

The monitor is capable of both tilt and swivel adjustments.



*Figure 5: Tilt Adjustment*

- With the tilt feature, the monitor is capable of vertical adjustments of +5° to -15°.
- The swivel feature allows for horizontal monitor adjustments of +45° to -45°.

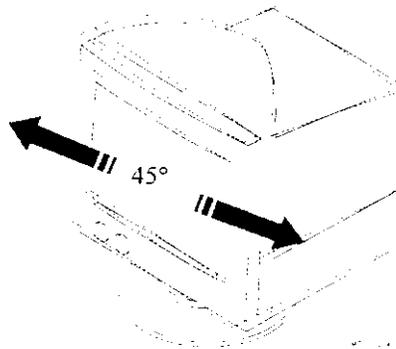

*Figure 6: Swivel Adjustment*

This concludes Chapter 1. The next chapter covers the on-screen display (OSD) features.



## Adjusting the Brightness and Contrast

To adjust the contrast and/or brightness, turn the *Contrast Control* or the *Brightness Control*, to call up the following on-screen display:

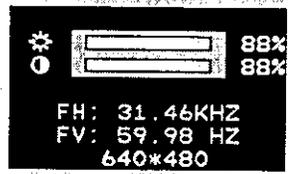

*Brightness*



Turn the *Brightness Control* clockwise to increase the brightness. Turn the control counterclockwise to decrease the brightness. The brightness level is adjusted from 0% to 100%.

*Contrast*



Turn the *Contrast Control* clockwise to increase the contrast. Turn the control counterclockwise to decrease the contrast. The contrast level is adjusted from 0% to 100%.

*H. Frequency*

**FH:**

This field displays the current Horizontal Scan Frequency. . Display only field

*V. Frequency*

**FV:**

This field displays the current Vertical Refresh Rate. Display only field.

*Resolution*

**640\*480**

This field shows the display resolution to which your monitor is set. This is a display only field.

*H-Center*



Scroll to the *H-Center* icon. Turn the *Contrast Control* to position the display along the horizontal axis of the screen.

*V-Size*



Scroll to the *V-Size* icon. Turn the *Contrast Control* to adjust the vertical size of the display.

*V-Center*



Scroll to the *V-Center* icon. Turn the *Contrast Control* to position the display along the vertical axis of the screen.

*Pincushion*



Scroll to the *Pincushion* icon. Turn the *Contrast Control* to adjust pincushion or barrel distortion.

*Trapezoid*



Scroll to the *Trapezoid* icon. Turn the *Contrast Control* to adjust trapezoid distortion.

*Tilt*



Scroll to the *Tilt* icon. Turn the *Contrast Control* to adjust display tilt.

*Parallel*



Scroll to the *Parallel* icon. Turn the *Contrast Control* to adjust parallel distortion.

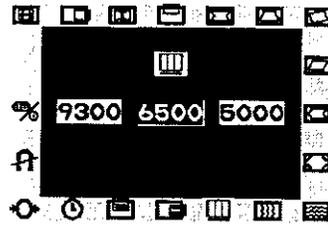

This screen allows you to select a color temperature for your monitor. Turn the *Contrast Control* to select the desired option. The available options are:

- ◆ 9300
- ◆ 6500
- ◆ 5000

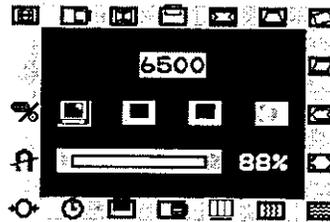

From this window you can make changes to the display's Red, Green and Blue gain. Turn the *Brightness Control* to scroll through the options; change values using the *Contrast Control*; after making changes, turning the *Brightness Control* will enter your changes, and move to the next icon.

Values for the *Red, Green or Blue Gain* are displayed from 0% to 100%.

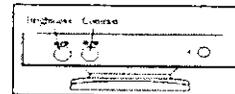

Scroll to the *Red Gain* icon. Turn the *Contrast Control* to adjust the red gain for your display.

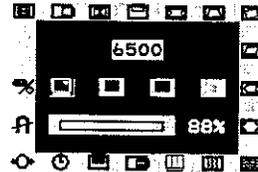

OSD on the screen.

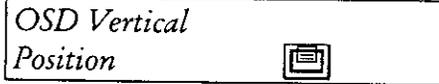

Scroll to the *OSD Vertical Position* icon. Turn the *Contrast Control* to adjust the vertical position of the OSD on the screen.

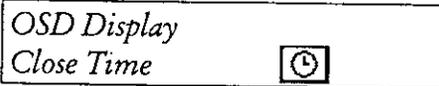
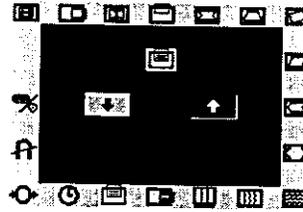

Scroll to the *OSD Display Close Time* icon. Turn the *Contrast Control* to set the amount of time that elapses before the OSD closes. Countdown can be set from 1 to 60 seconds.



**Note!**

Don't be rushed when changing display settings: The *Display Close Time* does not begin countdown while you are making display adjustments.



### Reset and Degauss

The *Reset All* option allows you to reset all display settings to their default values. Use the *Degauss* option to remove unwanted magnetism from the monitor's CRT.

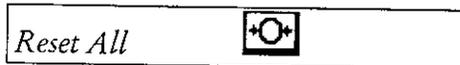

Scroll to the *Reset All* icon. Turn the *Contrast Control* to reset all display options. If you do not wish to reset all display options, push the *Brightness Control* to close the OSD window.

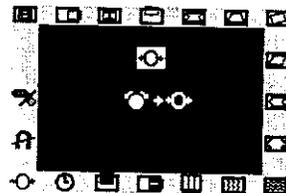



## Summary of OSD Icons

<b>Icon</b>	<b>Function</b>	<b>Description</b>
	H-Size	Use this option to adjust the horizontal size of the display.
	H-Center	Use this option to position the display along the horizontal axis of the screen.
	V-Size	Use this option to adjust the vertical size of the display.
	V-Center	Use this option to position the display along the vertical axis of the screen.
	Pincushion	Use this option to adjust pincushion or barrel distortion.
	Trapezoid	Use this option to adjust trapezoid distortion.
	Tilt	Use this option to adjust image tilt.
	Parallel	Use this option to adjust parallel distortion.
	Unbalance	Use this option to adjust unbalance distortion.
	Corner	Use this option to correct distortion to the corners of your screen.
	H. Moire	This option is used to correct horizontal monitor misalignment.
	V. Moire	This option is used to correct vertical monitor misalignment.
	Display Color Setting	Use this option to adjust the color setup. Refer to <i>The Color Setup</i> in the following section for more information.

# APPENDIX A

## Technical Information

### Monitor Specifications

---

**Screen**

Size	19" CRT
Dot Pitch (mm)	0.26
Surface	Non-glare
Display Size (mm)	360 x 270

---

**Input Signal****Video Syns.**

- RGB Analog 0.7Vp-p/750hm
- a. Separate H/V, TTL (+/-)
- b. Composite H+V, TTL (+/-)
- c. Sync. on Green

---

**Scanning Frequency**

Horizontal (KHz)	31.5-95KHz
Vertical (Hz)	60-85Hz
Video Bandwidth	150MHz
Max. Resolution	1600 x 1200

---

**Compatibility**

IBMVGA, VESA VGA, ERGOVGA, SVGA, UVGA and XGA modes.

**Low Radiation**

**MPR II Optional**

**Operating**

Temperature 0-40°C  
 Relative Humidity 10%-90%  
 Altitude Sea level to 8,000ft

**Dimensions (including stand)**

472mm(L) x 452mm (W) x 462 mm (H)

**Weight**

24.9kg (54.8lb)

**Preset mode timing**

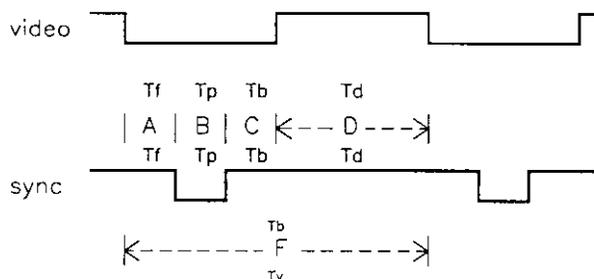

**Figure 8**

	MODE	H Pixels V Lines	Fd (MHz)	Fh (KHz)	F: Th (us)	D: Td (us)	C: Tb (us)	B: Tp (us)	A: Tf (us)
			Polar (H/V)	Fv (Hz)	F: Tv (ms)	D: Td (ms)	C: Tb (ms)	B: Tp (ms)	A: Tf (ms)
			d dot			d. display	b. backporch	P: Pulse	f. front
1	VGA60	640 480	25.175 N/N	31.469 59.941	31.778 16.683	25.422 15.253	1.907 1.048	3.813 0.064	0.636 0.318
2	VESA85	800 600	56.25 P/P	53.674 85.061	18.631 11.756	14.222 11.179	2.702 0.503	1.138 00.056	0.569 0.019
3	VESA75	1024 768	78.75 P/P	60.023 75.029	16.66 13.328	13.003 12.795	2.355 0.466	1.219 0.05	0.203 0.017
4	VESA85	1024 768	94.5 P/P	68.677 84.997	14.561 11.765	10.836 11.183	2.201 0.524	1.016 0.044	0.508 0.015
5	VESA85 (primary)	1280 1024	15.75 P/P	91.146 85.024	10.971 11.761	8.127 11.255	1.422 0.483	1.016 0.053	0.046 0.011
6	VESA75	1280 1024	135 P/P	79.976 75.025	12.504 13.329	9.481 12.804	1.837 0.475	1.067 0.038	0.119 0.013
7	VESA70	1600 1200	189 P/P	87.5 70	11.429 14.286	8.466 15.714	1.608 0.526	1.016 0.054	0.539 0.011
8	VESA75	1600 1200	202.5 P/P	95.75 75	10.677 13.355	7.901 12.80	1.501 0.491	0.948 0.032	0.316 0.011

**Figure 9**

# Troubleshooting



This section will try to anticipate potential problems that you may encounter in the day-to-day use of your monitor. Included in this section is information which should help solve these problems for you. If after trying the suggested solutions, your monitor's symptom remains the same, contact your authorized service center.

Symptoms	Solution
The monitor is switched on, but the power LED is not lit.	Check to make sure that the power cord is properly connected. If the monitor is plugged into a powered extension cord or a surge protector, make sure that extension cord or the surge protector is turned on.
The LED light is on but there is no display on the monitor's screen.	Make sure that the computer's switch is in the "On" position.  Make sure that the video cable's D-shaped connector is properly connected to the video adapter port on the back of the PC.  Check to make sure that the brightness and contrast control are not turned to their dimmest position.
The display image is either dangling or unstable.	Make sure that the video cable's D-shaped connector is properly connected to the video adapter port on the back of the PC.
The picture is bouncing or a wave pattern is present in the display.	Move any electrical devices away from the monitor which may cause display interference. Please refer to the FCC statement at the beginning of the manual for more details on display interference.

Plug & Play	DDC1 & DDC2B
Display Colors	Unlimited
<b>Signal Cable</b>	
15 pin, mini D-sub	
<b>Power</b>	
Consumption	150W
Supply	90-260VAC 50/60Hz
Power Management	
Complies with EPA, VESA DPMS & TCO	
<b>On Screen Display</b>	
Brightness	Yes
Contrast	Yes
H/V Size	Yes
H/V Center	Yes
Pincushion	Yes
Tilt	Yes
Trapezoid	Yes
Parallel	Yes
Unbalance	Yes
Corner	Yes
H. Moire	Yes
V. Moire	Yes
Degaussing	Yes
OSD Position Adjusting	Yes
OSD Close Time	Yes
RGB Gain	Yes
Reset All	Yes
<b>Display Modes</b>	
Preset	16
User	28

<b>Icon</b>	<b>Function</b>	<b>Description</b>
<b>9300</b>	CIE coordinate 9300°	Select this option to set the monitor for the CIE coordinate 9300° color temperature.
<b>6500</b>	CIE coordinate 6500°	Select this option to set the monitor for the CIE coordinate 6500° color temperature.
<b>5000</b>	CIE coordinate 5000°	Select this option to set the monitor for the CIE coordinate 5000° color temperature.
	Red Gain	Use this option to adjust the red gain.
	Green Gain	Use this option to adjust the green gain.
	Blue Gain	Use this option to adjust the blue gain.
	Reset	This option allows you to reset the three color settings to the default value.
	OSD Horizontal Position	Select this option to adjust the horizontal position of the OSD on the screen.
	OSD Vertical Position	Select this option to adjust the vertical position of the OSD on the screen.
	OSD Display Close Time	Use this option to set the amount of time that elapses before the OSD closes.
	Reset All	Use this option to reset all display settings to their default values.
	Degauss	The Degauss option removes unwanted magnetism from the monitor's CRT.
	DSUB/BNC SW	SYNC input D-SUB or BNC switch.

This concludes Chapter 2. The following appendix provides details on your monitor's technical specifications. You will also find tips on troubleshooting any problems you may run into.

**Degauss**

Scroll to the *Degauss* icon. Turn the *Contrast Control* to degauss the CRT. If you do not wish to degauss the CRT, push the *Brightness Control* to close the OSD window.

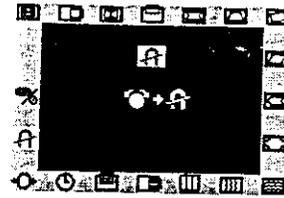
**D-SUB/BNC SW**

Input SYNC D-SUB (15P) or BNC SYNC switch

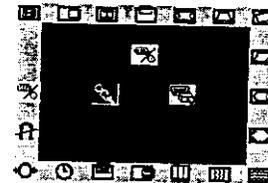

## Self-Test Screen

When the monitor is powered On, but there is no video signal, the following self-test screen will appear.

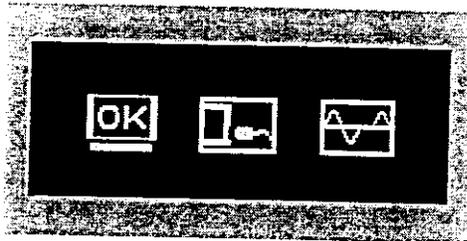

This screen indicates the monitor itself is OK. If this screen appears, it is possible that the monitor's VGA cable is not connected properly to your computer's VGA port. Check the connection.

If the VGA cable is properly connected but the monitor screen is blank, (i.e., there is no picture and none of the above icons appear), then there may be a problem with the monitor.

*Green Gain* 

Scroll to the *Green Gain* icon. Turn the *Contrast Control* to adjust the green gain for your display.

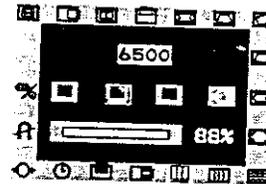

*Blue Gain* 

Scroll to the *Blue Gain* icon. Turn the *Contrast Control* to adjust the blue gain for your display.

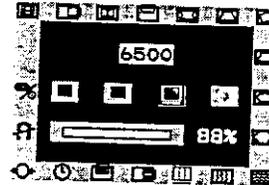

*Reset* 

Scroll to the *Reset* icon. Turn the *Contrast Control* to reset all three gain values to the default settings. The OSD window will close.

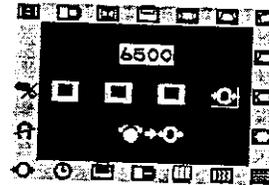

 **OSD Window Status**

The OSD Window status icons allow you to adjust the position of the OSD window on your screen. You can also set the time that the OSD window will be displayed on the screen.

*OSD Horizontal Position* 

Scroll to the *OSD Horizontal Position* icon. Turn the *Contrast Control* to adjust the horizontal position of the

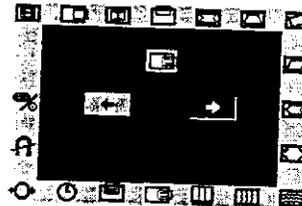

*Unbalance*



Scroll to the *Unbalance* icon. Turn the contrast control to adjust unbalance distortion.

*Corner*



Scroll to the *corner* icon. Turn the *Contrast Control* to correct distortion to the corners of your screen.

*H. Moire*



Scroll to the *H. Moire* icon. Turn the *Contrast Control* to correct horizontal monitor misalignment.

*V. Moire*



Scroll to the *V. Moire* icon. Turn the *Contrast Control* to correct vertical monitor misalignment.

**Note!**

*Moire* is a visible display distortion and can result from a variety of conditions. One cause is internal monitor misalignment.



## Color Temperature Setup

To access the Color setup menu, scroll to the *Display Color Setting* icon. The following screen appears:

## The On-Screen Display (OSD)

The monitor features an intuitive, on-screen display (OSD), making changes to the display settings convenient and simple. You can access the OSD any time your PC is powered *On*. If the PC is in *Standby* mode, or is powered *Off*, the OSD cannot be accessed.

To access the OSD Main Menu, push the *Brightness Control*. The following screen will appear:

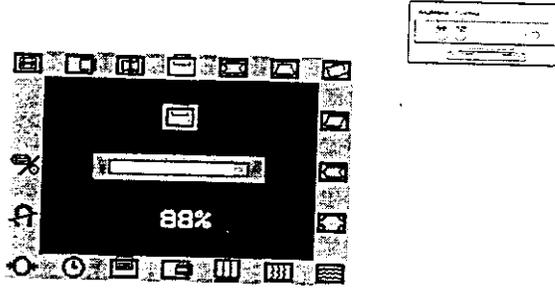

This screen shows the *V-Center* window allowing you to make adjustments to the display's vertical position. Notice the *V-Center* icon in the window border is highlighted.

### Changing Display Settings

Call up the *OSD* as described above. Now turn the *Brightness Control* button to scroll through the icons in the window border. You can scroll clockwise or counterclockwise in the window border by rotating the control in the respective direction.

Once you have selected an icon, use the *Contrast Control* to adjust the option value. Turn the control clockwise to increase the value; Turn the control counterclockwise to decrease the value.

When making changes to the following settings, a screen similar to the above *V-Center* window will appear on your monitor screen.

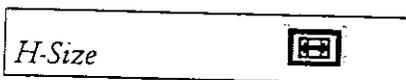

Scroll to the *H-Size* icon. Turn the *Contrast Control* to adjust the horizontal size of the display.



## CHAPTER 2

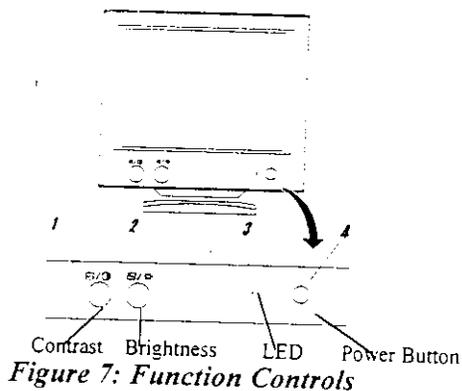

*Figure 7: Function Controls*

### **Contrast (and OSD Increase/Decrease) Control**

When the OSD Main Menu is not engaged, turn the *Contrast Control* (1) to adjust the display contrast level to accommodate the ambient lighting conditions of your specific working environment.

When the OSD Main Menu is engaged, turning this control adjusts the display-setting values.

### **Brightness (and OSD On/Off) Control**

When the OSD Main Menu is not engaged turn the *Brightness Control* (2) to adjust the display brightness level. Pushing the *Brightness Control* calls up the OSD Main Menu. Turn the control to scroll through the menu options.

### **Power LED**

The Power LED (3) informs you of the monitor's current operating status. The Power LED will light *Green* when the monitor is powered On. In Standby mode the LED lights *Amber*. When powered Off the LED is not lit.

### **Power On/Off Button**

Push the Power Button (4) to power the monitor *On* or *Off*.



## The AC Connection

- ♦ Locate the AC port on the rear of the monitor (refer to *Figure 3*).
- ♦ Plug the female end of the AC cord into the AC port.
- ♦ Plug the male end into the power supply.

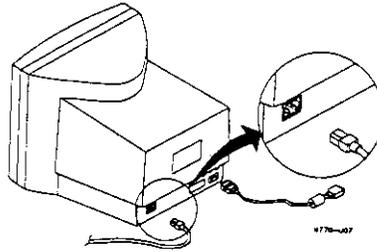

*Figure 3: Connecting the Power Cord*

## The Signal Cable Connection

- ♦ Make sure that the monitor is powered *Off*. When powered off the Power LED (see *Figure 2*) will not be lit.
- ♦ Locate the VGA port on the rear of the PC. The signal cable has a standard 15-pin mini D-sub (VGA) connector. If you are having trouble locating the VGA port, please refer to the documentation which came with your PC. Connect the Signal cable to the PC's VGA port.

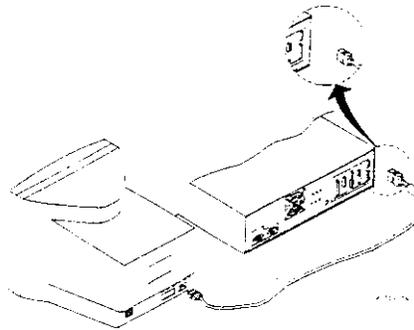

*Figure 4: Connecting the Signal Cable*



# CHAPTER 1

## Introduction

Congratulations on your purchase of the new high performance 19" Monitor. Much consideration has gone into the design of the monitor in order to meet your requirements for full compatibility and versatility as well as quality.

Using state-of-the-art electronics, the monitor can support a resolution of 1280 x 1024. are available. The on-screen display allows you to customize the display settings to suit your individual needs, or you can choose from one of the sixteen pre-set factory modes. User display settings will be automatically saved to memory. In addition, at the touch of a button the user can, at any time, return to the factory default display settings.

Two conveniently placed multi-function display controls that allow you to make all monitor display adjustments. Other ergonomic features include a non-glare screen and tilt and swivel adjustment for a comfortable viewing angle.

## Unpacking

Please make sure the following items are in the shipping package and found in good condition:

- 19" Monitor
- Tilt and swivel stand
- Power cord
- Signal cable
- This manual

If any of the above are missing or appear damaged, please contact your dealer immediately.

# FEDERAL COMMUNICATIONS COMMISSION

## NOTE

This equipment has been tested and found to comply with the limits for a Class B digital device, pursuant to Part 15 of the FCC Rules. These limits are designed to provide reasonable protection. This equipment generates, uses and can radiated radio frequency energy and, if not installed and used in accordance with the instructions, may cause harmful interference to radio communications. However, there is no guarantee that interference will not occur in a particular installation. If this equipment does cause harmful interference to radio or television reception, which can be determined by turning the equipment off and on, the user is encouraged to try to correct the interference by one or more of the following measures:

- Reorient or relocate the receiving antenna.
- Increase the separation between the equipment and receiver.
- Connect the equipment into an outlet on a circuit different from that to which the receiver is connected.
- Consult the dealer or an experienced radio/TV technician for help.

Shielded interface cables must be used in order to comply with emission limits.

Changes or modifications not expressly approved by the party responsible for compliance could void the user's authority to operate the equipment.