

Important Safety Instructions

1. Please read these instructions thoroughly.
2. Please keep this guide for future use.
3. Please disconnect the device from the main supply before cleaning. Do not use any liquid or aerosol spray cleaners. The best for cleaning is a piece of cloth dampened with water.
4. To avoid damage of the device, you should only use accessory parts permitted by the manufacturer.
5. The device must be protected against moisture.
6. To setup the device, it must be put in a stable stand position. Tipping it over or dropping it may cause injuries. Only use safety setup locations and follow the setup instructions of the manufacturer.
7. The ventilation openings are used for air circulation which protect the device against overheating.
8. To connect the device, follow the connected load values of the main supply.
9. Due to electrical safety, the wall socket must be equipped with a non-fused earthed conductor contact.
10. The power cable must be laid in a way that nobody may trip over it. There should also nothing be resting on the cable.
11. All instructions and warning remarks on the device must be followed.
12. If the device will not be used for a longer time period, you should dis-connect it from the main supply. Thus, in case of overvoltage damage can be avoided.
13. Any objects or liquid should never enter the device via its openings for air circulation. This could cause a fire or an electric shock.
14. Do not open the device ever. Due to electrical safety, the device shall be opened by the authorized customer service personnel only.
15. If following conditions occur, the device must be disconnected from the main supply, and it must be checked by a qualified service center:
 - a- Power cable or power plug are damaged.
 - b- Liquid has entered the device.
 - c- The device was exposed to moisture.
 - d- When the device does not operate according to the user's guide, or you do not achieve any improvement with the aid of this guide.
 - e- The device has dropped and/or the casing is damaged.
 - f- When the device shows obvious signs of a defect.
16. For repair, only original spare parts or parts in accordance with the original parts may be used. Use of unsuitable spare parts can cause more damage.
17. Please turn to your service center for all questions concerning service and repair. Thus, you guarantee the device's performance reliability.
18. The socket outlet must be installed near the equipment to be easily accessible.

陳政宏 4/3

0004

Federal Communications Commission (FCC Statement)

This equipment has been tested and found to comply with the limits for a Class B digital device, pursuant to Part 15 of the FCC Rules.- These limits are designed to provide reasonable protection against harmful interference in a residential installation. This equipment generates, uses, and can radiate radio frequency energy, and, if not installed and used in accordance with the instructions, may cause harmful interference to radio communications. However, there is no guarantee that interference will not occur in a particular installation. If this equipment does cause harmful interference to radio or television reception, which can be determined by turning the equipment off and on, the user is encouraged to try to correct the interference by one or more of the following measures:

- Reorient or relocate the receiving antenna;
- Increase the separation between the equipment and receiver;
- Connect the equipment into an outlet on a circuit different from that to which the receiver is connected;
- Consult the dealer or an experienced radio/TV technician for help.

Any changes or modifications not expressly approved by the manufacturers may void the user's authority to operate this equipment.

NOTE:

A shielded-type power cord is required in order to meet the FCC emission limits and also to prevent interference to nearby radio and television reception. It is essential that only the supplied power cord be used. Use only shielded cables to connect I/O devices to this equipment.

Canadian Doc Notice

For Class B Computing Devices

This Class B digital apparatus meets all requirements of the Canadian Interference-Causing Equipment Regulations.

Cet appareil numérique de la classe B respecte toutes les exigences du Règlement sur le matériel brouilleur du Canada.

Table of Contents

1. GETTING STARTED.....	
<i>Unpacking</i>	2
<i>Connecting the Monitor and Stand</i>	2
<i>Choosing A Workstation</i>	3
<i>The AC Connection</i>	3
<i>The Signal Cable Connection</i>	4
2. MONITOR ADJUSTMENTS.....	
<i>User Controls</i>	6
<i>The Monitor's Functions</i>	6
3. ICON DESCRIPTIONS.....	7
4. TECHNICAL INFORMATION.....	8
<i>15" Monitor Specifications</i>	8
<i>Preset Timing</i>	9
5. TROUBLE SHOOTING.....	10
<i>Power</i>	10
<i>LED</i>	10
<i>Display</i>	10
6. CARING FOR YOUR MONITOR.....	11
<i>Cleaning the screen</i>	11
<i>Ventilation slots</i>	11
<i>Power Cord</i>	11
<i>Grounding</i>	11

1. Getting Started

Introduction

This document is related to a 14" CRT color monitor TM454 to be used with various kind of graphic adapters, including IBMVGA, VESAVGA, ERGOVGA, SVGA, UVGA, and XGA modes. It is intended as a mutisync monitor type based on microprocessor unit, capable to support all the video standards. Other graphic standards can be supported by this monitor, simply adjusting image size and centering by means of the user controls gathered on the front panel. The monitor is used with 30KHZ to 54KHZ frequency in horizontal sweep while vertical refresh rate is from 50HZ to 120HZ.

Moreover it offers Power Management and DDC1 and DDC2B features according to VESA recommendations.

Unpacking

Please make sure the following items are in the shipping package and found in good condition:

- ◆ 14" Monitor
- ◆ Tilt and swivel stand
- ◆ Power cord
- ◆ This manual

If any of the above are missing or appear damaged, please contact your dealer immediately.

Connecting the Monitor and Stand

- Align the stand's four tabs with the slots on the bottom of the monitor.
- Insert the tabs into the slots.
- Slide the stand towards the front of the monitor.

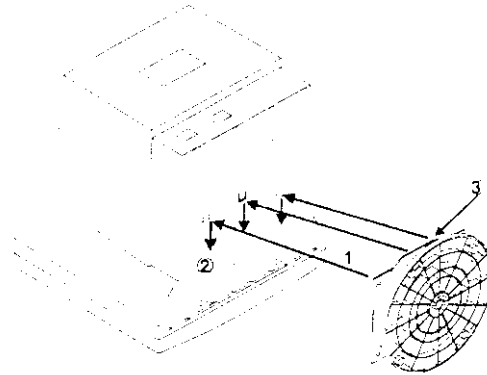

Figure 1: Monitor and Stand Connection

Choosing A Workstation

When choosing an appropriate workspace, keep these few things in mind:

- ◆ A sturdy, level surface.
- ◆ An electrical wall outlet and a telephone wall jack near the computer.
- ◆ At least 3-inch clearance at the back of the computer to allow for the required airflow.
- ◆ Do not place near a window. Exposing the Monitor to direct sunlight for extended periods may damage the unit.
- ◆ You may want to use a desk lamp to adjust the ambient lighting for your viewing comfort.

A viewing filter is recommended to reduce eye stress and fatigue.

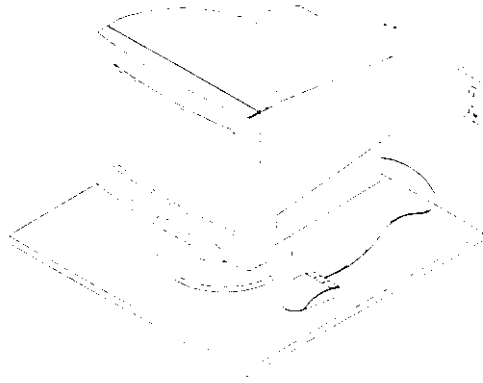

Figure 2: The Workstation

The AC Connection

- ◆ Locate the AC port on the rear of the monitor.
- ◆ Plug the female end of the AC cord into the AC port.
- ◆ Plug the male end into the power supply.

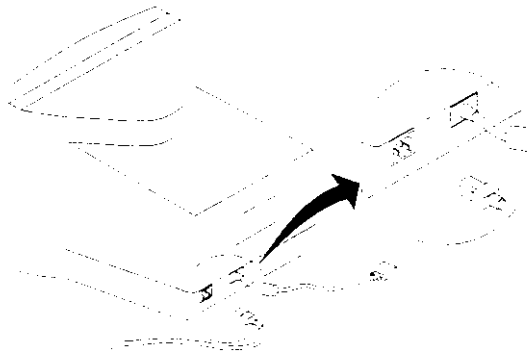

Figure 3: Connecting the Power Cord

The Signal Cable Connection

- ◆ Locate the ON/OFF power switch. See Figure 4.
- ◆ Make sure that the Monitor power switch is in the OFF position. The OFF position is indicated with a circular icon.

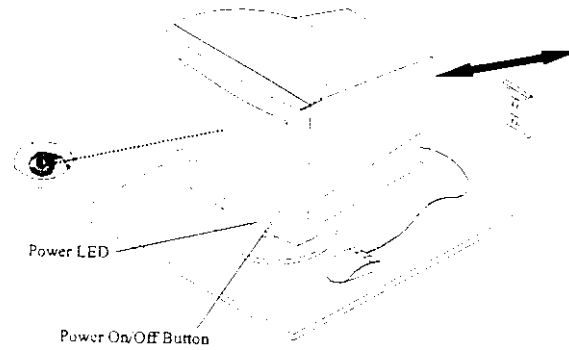

Figure 4: ON/OFF Power Switch

- ◆ Locate the VGA port on the rear of the PC. The signal cable has a standard 15-pin mini D-sub (VGA) connector. If you are having trouble locating the VGA port, please refer to the documentation which came with your PC.
- ◆ Connect the Signal cable to the PC's VGA port.

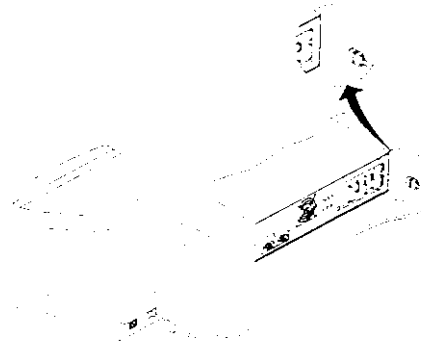

Figure 5: Connecting the Signal Cable

2 Monitor Adjustments

The monitor is capable of both tilt and swivel adjustments.

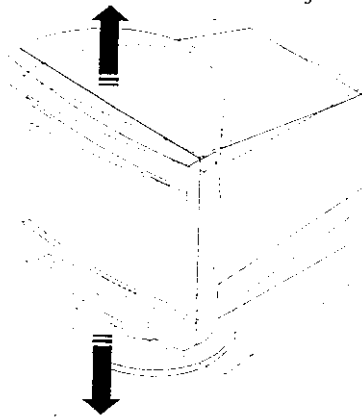

Figure 6: Tilt Adjustment

- ◆ With the tilt feature, the monitor is capable of vertical adjustments of $+5^\circ$ to -15° .
- ◆ The swivel feature allows for horizontal monitor adjustments of $+45^\circ$ to -45° .

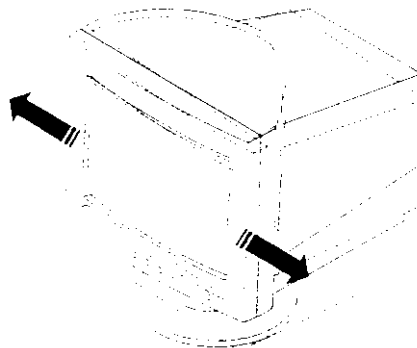

Figure 7: Swivel Adjustment

User Controls

This display device shall have external controls to implement at least the following function:

- POWER SWITCH
- POWER INDICATOR
- BRIGHTNESS CONTROL
- CONTRAST CONTROL
- HORIZONTAL WIDTH CONTROL
- VERTICAL HEIGHT CONTROL
- PINCUSHION CONTROL
- TRAPEZOID CONTROL

A recall function shall be present on the monitor to recall the factory preset.







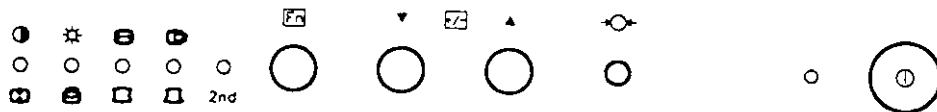

All this functions as shown in the drawing below:

Note! 

- *When the highest or lowest possible setting for a particular display control has been reached, its corresponding LED will flash.*
- *When the 2nd LED light is on, you must follow the 2nd function indication.*



3 Icon Descriptions

Icon	Description
	Contrast: This control allows you to adjust the display contrast level to accommodate the ambient lighting conditions of your working environment.
	Brightness: This control allows you to fine tune the display brightness level.
	H-Width: This control allows you to stretch or squeeze the display area horizontally.
	H-Phase: This control allows you to adjust the display to the right or to the left.
	V-Height: This control allows you to stretch or squeeze the display area vertically.
	V-Center: This control allows you to adjust the display up or down on the screen.
	Pincushion: This control allows you to alter the image geometry of the display area to prevent the image from curving either inwardly or outwardly.
	TRAPEZOID: This control allows you to adjust the trapezoid of the display.

4 Technical Information

14" Monitor Specifications

Screen	14" CRT
Dot Pitch (mm)	0.28
Surface	Non-glare
Display Size (mm)	250 x 188
Input Signal	
Video Syns.	RGB Analog 0.7Vp-p/750hm Separate H/V. TTL (+/-)
Scanning Frequency	
Horizontal (KHz)	30-54
Vertical (Hz)	50-120
Video Bandwidth	65MHz
Max. Resolution	1024x768
Compatibility	
VGA, SVGA, 8514A, VESA	
Plug & Play	DDC1 & DDC2B
Display Colors	Unlimited
Signal Cable	Captive 15 pin. mini D-sub
Power	
Consumption	70W for normal tubes 75W for Low Radiation tubes
Supply	90-264VAC 47-63Hz
Power Management	Complies with EPA, VESA DPMS & TCO
Digital Controls	
Brightness	Yes
Contrast	Yes
H/V Size	Yes
H/V Center	Yes
Pincushion	Yes
Trapezoid	Yes

Display Modes	
Presetting	4
User	12
Low Radiation	MPR II Optional
Operating	
Temperature	0-40°C
Relative Humidity	10%-90%
Dimensions	
388mm(L) x 366mm(W) x 377mm(H) (including tilt and swivel base)	
Weight (excluding packaging)	12.0 kg

Preset Timing

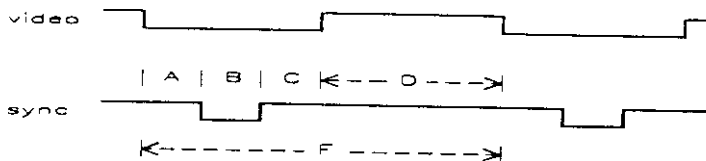

MODE	H Pixels V Lines	Fd(MHz) Polar(H/V)	sweep		F		D		C		B		A	
			Fh(KHz) Fv(Hz)	Th(us) Tv(ms)	Td(us) Td(ms)	Tb(us) Tb(ms)	Tp(us) Tp(us)	Tf(us) Tf(us)						
		d: dot				d: display	b: backporch	p: pulse	f: front					
1	VGA60 640 480	25.175 N/N	31.469 59.94	31.777 16.683	25.422 15.253	1.907 1.049	3.813 0.064	0.635 0.317						
2	VESA75 800 600	49.5 P/P	46.875 75	21.333 13.333	16.162 12.8	3.232 0.448	1.616 0.064	0.323 0.021						
3	VESA60 1024 768	65 N/N	48.363 60	20.667 16.667	15.754 15.88	2.462 0.6	2.092 0.124	0.369 0.063						
4	VESA85 800 600	56.25 P/P	53.674 85.061	18.631 11.756	14.222 11.179	2.702 0.503	1.138 0.056	0.569 0.018						

*The above columns A through F units lists the horizontal value first in units of μ s and is followed by the vertical value in units of ms.

5 Trouble Shooting

This section will try to anticipate potential problems that you may encounter in the day-to-day use of your monitor. Included in this section is information which should help solve these problems for you. If after trying the suggested solutions, your monitor's symptom remains the same, contact your authorized service center.

Power

Symptom: The monitor is switched on, but the power LED is not lit.

Solution: Check to make sure that the power cord and video cable are properly connected. If the monitor is plugged into a powered extension cord or a surge protector, make sure that extension cord or the surge protector is turned on. (Note: When the monitor is power saving on off mode, the power LED is flash continuously.)

LED

Symptom: The LED light is on but there is no display on the monitor's screen.

Solution: Make sure that the computer's switch is in the "On" position. Make sure that the video cable's D-shaped connector is properly connected to the video adapter port on the back of the PC.

Display

Symptom: The display image is either not centered, too small, or too large.

Solution: Adjust the size and phase controls.

Symptom: The display image is either dangling or unstable.

Solution: Make sure that the video cable's D-shaped connector is properly connected to the video adapter port on the back of the PC.

Symptom: The picture is bouncing or a wave pattern is present in the display.

Solution: Move any electrical devices away from the monitor which may cause display interference. Please refer to the FCC statement at the beginning of the manual for more details on display interference.

6 Caring For Your Monitor

Cleaning the screen

To clean your screen follow these steps:

- Never spray liquid cleaners on or around the Monitor.
- Spray the liquid cleaner on a rag while standing away from the computer. Avoid excessive dampening.
- Clean the screen with slightly damp rag

Ventilation slots

The ventilation slots allow air to flow through the Monitor. They protect the unit from overheating. Therefore, do not cover or obstruct the ventilation slots. Likewise, do not place the Monitor on or near a heater.

Power Cord

It is best to place the power cord out of the way. If it must be exposed to traffic, tape it to the floor or use a cord shield.

Grounding

Grounding protects the Monitor from static discharge. Do not defeat the purpose of the plug by cutting off the third prong and jamming it into a two prong outlet.

APPENDIX 5

USER'S MANUAL OF EUT

The enclosed manual is for the EUT. As you will notice on the preceding page of this manual is the **FCC WARNING** about radio and television interference as per the requirement set forth in Part 15 of the FCC Rules.