



FCC RADIO TEST REPORT

FCC ID : GKREXMG1A
Equipment : LTE Module
Brand Name : COMPAL
Model Name : EXM-G1A
Applicant : Compal Electronics, Inc.
No.581 & 581-1, Ruiguang Rd., Neihu District,
Taipei, (114) Taiwan
Manufacturer : Compal Electronics, Inc.
No.581 & 581-1, Ruiguang Rd., Neihu District,
Taipei, (114) Taiwan
Standard : FCC 47 CFR Part 2, 96

The product was received on Dec. 19, 2023 and testing was performed from Dec. 28, 2023 to Mar. 08, 2024. We, Sporton International Inc. EMC & Wireless Communications Laboratory, would like to declare that the tested sample has been evaluated in accordance with the test procedures given in ANSI / TIA-603-E and has been in compliance with the applicable technical standards.

The test results in this report apply exclusively to the tested model / sample. Without written approval of Sporton International Inc. EMC & Wireless Communications Laboratory, the test report shall not be reproduced except in full.

Louis Wu

Approved by: Louis Wu

Sporton International Inc. EMC & Wireless Communications Laboratory

No. 52, Huaya 1st Rd., Guishan Dist., Taoyuan City 333, Taiwan (R.O.C.)



Table of Contents

History of this test report.....	3
Summary of Test Result.....	4
1 General Description	5
1.1 Product Feature of Equipment Under Test	5
1.2 Modification of EUT	5
1.3 Testing Location	6
1.4 Applied Standards	6
2 Test Configuration of Equipment Under Test	7
2.1 Test Mode.....	7
2.2 Connection Diagram of Test System	8
2.3 Support Unit used in test configuration	8
2.4 Measurement Results Explanation Example	9
2.5 Frequency List of Low/Middle/High Channels.....	9
3 Conducted Test Items.....	11
3.1 Measuring Instruments.....	11
3.2 Conducted Output Power	12
3.3 Peak-to-Average Ratio	13
3.4 EIRP	14
3.5 Occupied Bandwidth	15
3.6 Conducted Band Edge	16
3.7 Conducted Spurious Emission	17
3.8 Frequency Stability.....	18
4 Radiated Test Items	19
4.1 Measuring Instruments.....	19
4.2 Test Setup	19
4.3 Test Result of Radiated Test.....	20
4.4 Radiated Spurious Emission	21
5 List of Measuring Equipment.....	22
6 Measurement Uncertainty	23
Appendix A. Test Results of Conducted Test	
Appendix B. Test Results of Radiated Test	
Appendix C. Test Setup Photographs	



History of this test report

Report No.	Version	Description	Issue Date
FG3D1840-01C	01	Initial issue of report	Mar. 13, 2024



Summary of Test Result

Report Clause	Ref Std. Clause	Test Items	Result (PASS/FAIL)	Remark
3.2	§2.1046	Conducted Output Power	Reporting only	-
3.3	§96.41	Peak-to-Average Ratio	Pass	-
3.4	§96.41	Effective Isotropic Radiated Power	Pass	-
3.5	§2.1049 §96.41	Occupied Bandwidth	Reporting only	-
3.6	§2.1051 §96.41	Conducted Band Edge Measurement	Pass	-
3.7	§2.1051 §96.41	Conducted Spurious Emission	Pass	-
3.8	§2.1055	Frequency Stability for Temperature & Voltage	Pass	-
4.4	§2.1053 §96.41	Radiated Spurious Emission	Pass	3.32 dB under the limit at 7362.00 MHz

Conformity Assessment Condition:

1. The test results (PASS/FAIL) with all measurement uncertainty excluded are presented against the regulation limits or in accordance with the requirements stipulated by the applicant/manufacturer who shall bear all the risks of non-compliance that may potentially occur if measurement uncertainty is taken into account.
2. The measurement uncertainty please refer to each test result in the section "Measurement Uncertainty".

Disclaimer:

The product specifications of the EUT presented in the test report that may affect the test assessments are declared by the manufacturer who shall take full responsibility for the authenticity.

Reviewed by: Keven Cheng

Report Producer: Michelle Chen



1 General Description

1.1 Product Feature of Equipment Under Test

Product Feature	
General Specs WCDMA/LTE, and GNSS.	

	Band	Brand	Model	Antenna Type	RF Exposure Max Antenna Gain(dBi)
LTE	48	Hongbo	1	Monopole	1

Support band and evaluated information	
Supported band	B48, B48C
Evaluated and Tested band	B48, B48C

TDD band Power Class		
	PC3	PC2
Band 48	V	
Band 48C	V	

Remark: The EUT's information above is declared by manufacturer. Please refer to Disclaimer in report summary.

1.2 Modification of EUT

No modifications are made to the EUT during all test items.



1.3 Testing Location

Test Site	Sporton International Inc. EMC & Wireless Communications Laboratory
Test Site Location	No.52, Huaya 1st Rd., Guishan Dist., Taoyuan City 333, Taiwan (R.O.C.) TEL: +886-3-327-3456 FAX: +886-3-328-4978
Test Site No.	Sporton Site No. TH03-HY
Test Engineer	Diego Huang
Temperature (°C)	22.2~23.7
Relative Humidity (%)	50.6~55.5

Test Site	Sporton International Inc. Wensan Laboratory
Test Site Location	No.58, Aly. 75, Ln. 564, Wenhua 3rd, Rd., Guishan Dist., Taoyuan City 333010, Taiwan (R.O.C.) TEL: +886-3-327-0868 FAX: +886-3-327-0855
Test Site No.	Sporton Site No. 03CH21-HY (TAF Code: 3786)
Test Engineer	Jack Cheng, Ray Lung and Sky Chang
Temperature (°C)	18~26
Relative Humidity (%)	50~70
Remark	The Radiated Spurious Emission test item subcontracted to Sporton International Inc. Wensan Laboratory.

Note: The test site complies with ANSI C63.4 2014 requirement.

FCC Designation No.: TW1190 and TW3786

1.4 Applied Standards

According to the specifications of the manufacturer, the EUT must comply with the requirements of the following standards:

- ♦ ANSI C63.26-2015
- ♦ ANSI / TIA-603-E
- ♦ FCC 47 CFR Part 2, 96
- ♦ FCC KDB 971168 D01 Power Meas. License Digital Systems v03r01
- ♦ FCC KDB 940660 D01 Part 96 CBRS Eqpt v03
- ♦ FCC KDB 412172 D01 Determining ERP and EIRP v01r01
- ♦ FCC KDB 414788 D01 Radiated Test Site v01r01

Remark:

1. All the test items were validated and recorded in accordance with the standards without any modification during the testing.
2. This EUT has also been tested and complied with the requirements of FCC Part 15, Subpart B, recorded in a separate test report.
3. The TAF code is not including all the FCC KDB listed without accreditation.



2 Test Configuration of Equipment Under Test

2.1 Test Mode

Antenna port conducted and radiated test items listed below are performed according to KDB 971168 D01 Power Meas. License Digital Systems v03r01 with maximum output power.

For radiated measurement, the measured emission level of the EUT was maximized by rotating the EUT on a turntable, adjusting the orientation of the EUT and EUT antenna in three orthogonal axis (X: flat, Y: portrait, Z: landscape), and adjusting the measurement antenna orientation, following C63.26 exploratory test procedures and only the worst case emissions were reported in this report..

Modulation Type	Modulation
A	QPSK
B	16QAM
C	64QAM

Test Item	Modulation Type	Bandwidth	RB Size	Channel
Conducted Power	A, B, C	All	1, Half, Full	L, M, H
EIRP	A, B, C	All	1, Half, Full	L, M, H
PAR	A, B, C	20 MHz	Full	M
Bandwidth	A, B, C	All	Full	M
ACLR, Mask	A, B, C	All	1RB Full	L, M, H
CSE	A	All	1RB	L, M, H
Frequency Stability	A	10 MHz	Full	M
RSE	A	20 MHz	1RB	L, M, H

Remark:

1. Evaluated all the transmitter signal and reporting worst-case configuration among all modulation types.
2. The device is investigated from 30MHz to 10 times of fundamental signal for radiated spurious emission test under different RB size/offset and modulations in exploratory test. Subsequently, only the worst-case emissions are reported.
3. One representative bandwidth is selected to perform PAR and frequency stability.

2.2 Connection Diagram of Test System

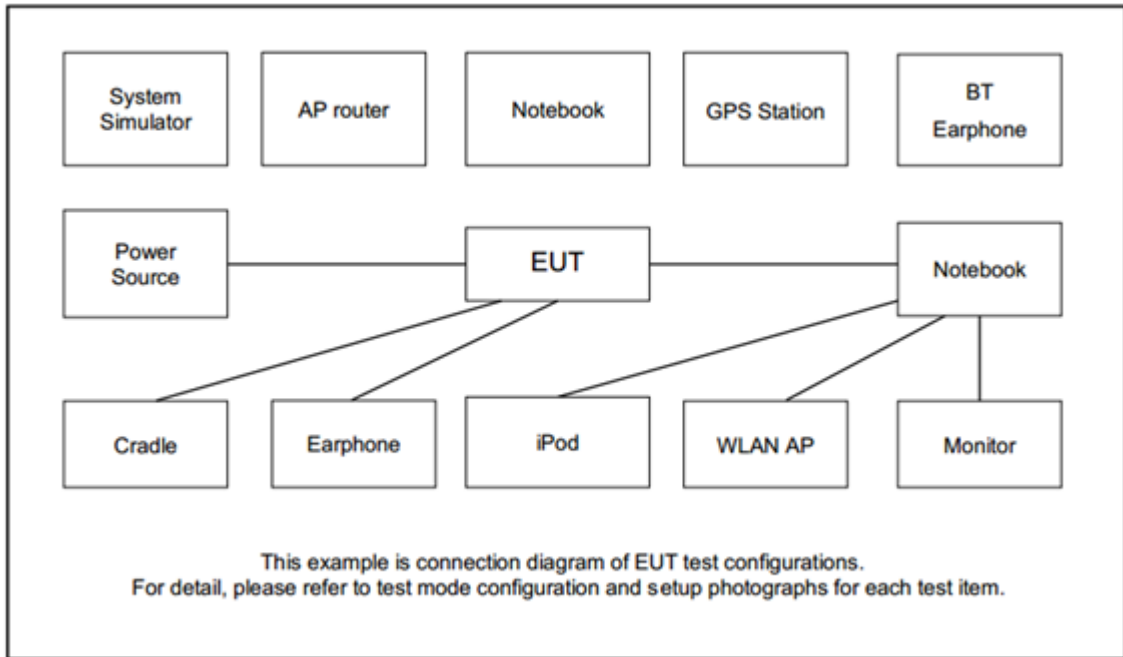

2.3 Support Unit used in test configuration

Item	Equipment	Brand Name	Model No.	FCC ID	Data Cable	Power Cord
1.	System Simulator	Anritsu	MT8821C	N/A	N/A	Unshielded, 1.8 m



2.4 Measurement Results Explanation Example

For all conducted test items:

The offset level is set in the spectrum analyzer to compensate the RF cable loss and attenuator factor between EUT conducted output port and spectrum analyzer. With the offset compensation, the spectrum analyzer reading level is exactly the EUT RF output level.

The spectrum analyzer offset is derived from RF cable loss and attenuator factor.

$$\text{Offset} = \text{RF cable loss} + \text{attenuator factor}.$$

Following shows an offset computation example with cable loss 4.2 dB and 10dB attenuator.

Example :

$$\begin{aligned} \text{Offset(dB)} &= \text{RF cable loss(dB)} + \text{attenuator factor(dB)}. \\ &= 4.2 + 10 = 14.2 \text{ (dB)} \end{aligned}$$

2.5 Frequency List of Low/Middle/High Channels

LTE Band 48 Channel and Frequency List				
BW [MHz]	Channel/Frequency(MHz)	Lowest	Middle	Highest
20	Channel	55340	55990	56640
	Frequency	3560.0	3625.0	3690.0
15	Channel	55315	55990	56665
	Frequency	3557.5	3625.0	3692.5
10	Channel	55290	55990	56690
	Frequency	3555.0	3625.0	3695.0
5	Channel	55265	55990	56715
	Frequency	3552.5	3625.0	3697.5



LTE Band 48C Channel and Frequency List_CA					
BW [MHz]	Channel/Frequency(MHz)		Lowest	Middle	Highest
20 + 20	PCC	Channel	55340	55891	56442
		Frequency	3560	3615.1	3670.2
	SCC	Channel	55538	56089	56640
		Frequency	3579.8	3634.9	3690
20 + 15	PCC	Channel	55340	55916	56491
		Frequency	3560	3617.6	3675.1
	SCC	Channel	55511	56087	56662
		Frequency	3577.1	3634.7	3692.2
15 + 20	PCC	Channel	55318	55893	56469
		Frequency	3557.8	3615.3	3672.9
	SCC	Channel	55489	56064	56640
		Frequency	3574.9	3632.4	3690
20 + 10	PCC	Channel	55340	55941	56541
		Frequency	3560	3620.1	3680.1
	SCC	Channel	55484	56085	56685
		Frequency	3574.4	3634.5	3694.5
10 + 20	PCC	Channel	55295	55896	56496
		Frequency	3555.5	3615.6	3675.6
	SCC	Channel	55439	56040	56640
		Frequency	3569.9	3630	3690
20 + 5	PCC	Channel	55340	55965	56590
		Frequency	3560	3622.5	3685
	SCC	Channel	55457	56082	56707
		Frequency	3571.7	3634.2	3696.7
5 + 20	PCC	Channel	55273	55898	56523
		Frequency	3553.3	3615.8	3678.3
	SCC	Channel	55390	56015	56640
		Frequency	3565	3627.5	3690

3 Conducted Test Items

3.1 Measuring Instruments

See list of measuring instruments of this test report.

3.1.1 Test Setup

3.1.2 Conducted Output Power



3.1.3 Peak-to-Average Ratio, Occupied Bandwidth, Conducted Band Edge and Conducted Spurious Emission



3.1.4 Frequency Stability

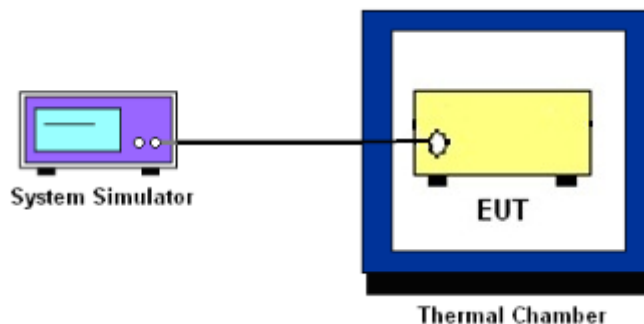

3.1.5 Test Result of Conducted Test

Please refer to Appendix A.



3.2 Conducted Output Power

3.2.1 Description of the Conducted Output Power Measurement

A system simulator was used to establish communication with the EUT. Its parameters were set to force the EUT transmitting at maximum output power. The measured power in the radio frequency on the transmitter output terminals shall be reported.

3.2.2 Test Procedures

1. The transmitter output port was connected to the system simulator.
2. Set EUT at maximum power through the system simulator.
3. Select lowest, middle, and highest channels for each band and different modulation.
4. Measure and record the power level from the system simulator.



3.3 Peak-to-Average Ratio

3.3.1 Description of the PAR Measurement

Power Complementary Cumulative Distribution Function (CCDF) curves provide a means for characterizing the power peaks of a digitally modulated signal on a statistical basis. A CCDF curve depicts the probability of the peak signal amplitude exceeding the average power level. Most contemporary measurement instrumentation include the capability to produce CCDF curves for an input signal provided that the instrument's resolution bandwidth can be set wide enough to accommodate the entire input signal bandwidth. In measuring transmissions in this band using an average power technique, the peak-to-average ratio (PAR) of the transmission may not exceed 13 dB.

3.3.2 Test Procedures

The testing follows ANSI C63.26-2015 Section 5.2.6

1. The EUT was connected to spectrum and system simulator via a power divider.
2. Set the CCDF (Complementary Cumulative Distribution Function) option in spectrum analyzer.
3. The highest RF powers were measured and recorded the maximum PAPR level associated with a probability of 0.1 %.
4. Record the deviation as Peak to Average Ratio



3.4 EIRP

3.4.1 Description of the EIRP Measurement

The EIRP of mobile transmitters must not exceed 23 dBm /10 megahertz for LTE Band 48.

The testing follows ANSI C63.26-2015 Section 5.2.5.5

According to KDB 412172 D01 Power Approach,

$EIRP = PT + GT - LC$, where

PT = transmitter output power in dBm

GT = gain of the transmitting antenna in dBi

LC = signal attenuation in the connecting cable between the transmitter and antenna in dB

Device	Maximum EIRP (dBm/10 MHz)	Maximum PSD (dBm/MHz)
End User Device	23	n/a

Remark: Total channel power is complied with EIRP limit 23dBm/10MHz.

3.4.2 Test Procedures

The testing follows procedure in Section 5.2 of ANSI C63.26-2015 and KDB 940660 D01 Part 96 CBRS Eqpt v03 Section 3.2(b)(2)

Determine the EIRP by adding the effective antenna gain to the measured average conducted power level.



3.5 Occupied Bandwidth

3.5.1 Description of Occupied Bandwidth Measurement

The occupied bandwidth is the width of a frequency band such that, below the lower and above the upper frequency limits, the mean powers emitted are each equal to a specified percentage 0.5% of the total mean transmitted power.

The 26 dB emission bandwidth is defined as the frequency range between two points, one above and one below the carrier frequency, at which the spectral density of the emission is attenuated 26 dB below the maximum in-band spectral density of the modulated signal. Spectral density (power per unit bandwidth) is to be measured with a detector of resolution bandwidth equal to approximately 1.0% of the emission bandwidth.

3.5.2 Test Procedures

The testing follows ANSI C63.26-2015 Section 5.4.3 (26dB) and Section 5.4.4 (99OB)

1. The EUT was connected to spectrum analyzer and system simulator via a power divider.
2. The spectrum analyzer center frequency is set to the nominal EUT channel center frequency. The span range for the spectrum analyzer shall be between two and five times the anticipated OBW.
3. The nominal resolution bandwidth (RBW) shall be in the range of 1 to 5 % of the anticipated OBW, and the VBW shall be at least 3 times the RBW.
4. Set the detection mode to peak, and the trace mode to max hold.
5. Determine the reference value: Set the EUT to transmit a modulated signal. Allow the trace to stabilize. Set the spectrum analyzer marker to the highest level of the displayed trace.
(this is the reference value)
6. Determine the “-26 dB down amplitude” as equal to (Reference Value – X).
7. Place two markers, one at the lowest and the other at the highest frequency of the envelope of the spectral display such that each marker is at or slightly below the “-X dB down amplitude” determined in step 6. If a marker is below this “-X dB down amplitude” value it shall be placed as close as possible to this value. The OBW is the positive frequency difference between the two markers.
8. Use the 99 % power bandwidth function of the spectrum analyzer and report the measured bandwidth.



3.6 Conducted Band Edge

3.6.1 Description of Conducted Band Edge Measurement

The conducted power of any End User Device emission outside the fundamental emission (whether in or outside of the authorized band) shall not exceed -13 dBm/MHz within 0 to B megahertz (where B is the bandwidth in megahertz of the assigned channel or multiple contiguous channels of the End User Device) above the upper CBSD-assigned channel edge and within 0 to B megahertz below the lower CBSD-assigned channel edge. At all frequencies greater than B megahertz above the upper CBSD assigned channel edge and less than B megahertz below the lower CBSD-assigned channel edge, the conducted power of any End User Device emission shall not exceed -25 dBm/MHz. Notwithstanding the emission limits in this paragraph, the Adjacent Channel Leakage Ratio for End User Devices shall be at least 30 dB.

3.6.2 Test Procedures

The testing follows FCC KDB 971168 D01 v03r01 Section 6.1.

1. The EUT was connected to spectrum analyzer and system simulator via a power divider.
2. The band edges of low and high channels for the highest RF powers were measured.
3. Set RBW \geq 1% EBW in the 1MHz band immediately outside and adjacent to the band edge.
4. Beyond the 1 MHz band from the band edge, RBW=1MHz was used
5. Set spectrum analyzer with RMS detector.
6. The RF fundamental frequency should be excluded against the limit line in the operating frequency band.

For Adjacent Channel Leakage Ratio (ACLR) measurement,

1. The Adjacent Channel Leakage Ratio (ACLR) is the ratio of the average power in the assigned aggregated channel bandwidth to the average power over the equivalent adjacent channel bandwidth.
2. The option ACLR of spectrum analyzer is used and measures the ACLR ratio by setting equivalent channel bandwidth.
3. The measured ACLR ratio shall be at least 30 dB.



3.7 Conducted Spurious Emission

3.7.1 Description of Conducted Spurious Emission Measurement

96.41 (e)(2)

The conducted power of any emissions below 3530 MHz or above 3720 MHz shall not exceed -40dBm/MHz.

3.7.2 Test Procedures

The testing follows FCC KDB 971168 D01 v03r01 Section 6.1.

1. The EUT was connected to spectrum analyzer and system simulator via a power divider.
2. The RF output of EUT was connected to the spectrum analyzer by RF cable and attenuator. The path loss was compensated to the results for each measurement.
3. The middle channel for the highest RF power within the transmitting frequency was measured.
4. The conducted spurious emission for the whole frequency range was taken.
5. Make the measurement with the spectrum analyzer's RBW = 1MHz, VBW = 3MHz.
6. Set spectrum analyzer with RMS detector.
7. Taking the record of maximum spurious emission.
8. The RF fundamental frequency should be excluded against the limit line in the operating frequency band.
9. The limit line is -40dBm/MHz.



3.8 Frequency Stability

3.8.1 Description of Frequency Stability Measurement

The frequency stability shall be measured by variation of ambient temperature and variation of primary supply voltage to ensure that the fundamental emission stays within the authorized frequency block.

3.8.2 Test Procedures for Temperature Variation

The testing follows FCC KDB 971168 D01 v03r01 Section 9.0.

1. The EUT was set up in the thermal chamber and connected with the system simulator.
2. With power OFF, the temperature was decreased to -30°C and the EUT was stabilized before testing. Power was applied and the maximum change in frequency was recorded within one minute.
3. With power OFF, the temperature was raised in 10°C step up to 50°C. The EUT was stabilized at each step for at least half an hour. Power was applied and the maximum frequency change was recorded within one minute.

3.8.3 Test Procedures for Voltage Variation

The testing follows FCC KDB 971168 D01 v03r01 Section 9.0.

1. The EUT was placed in a temperature chamber at 25±5° C and connected with the system simulator.
2. The power supply voltage to the EUT was varied from 85% to 115% of the nominal value measured at the input to the EUT.
3. The variation in frequency was measured for the worst case.

4 Radiated Test Items

4.1 Measuring Instruments

See list of measuring instruments of this test report.

4.2 Test Setup

For radiated emissions below 30MHz

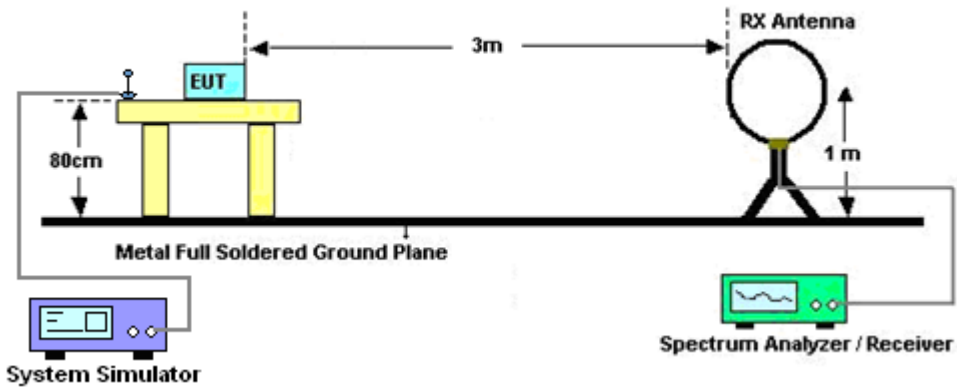

For radiated emissions from 30MHz to 1GHz

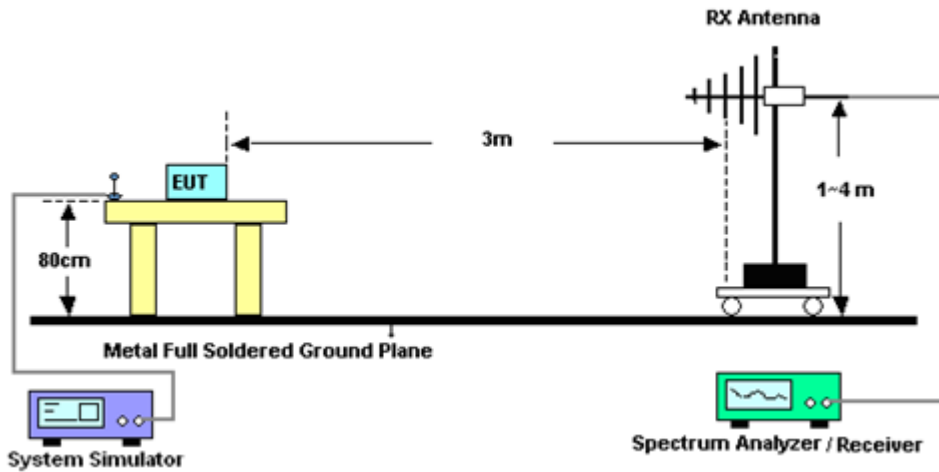

For radiated emissions from 1GHz to 18GHz

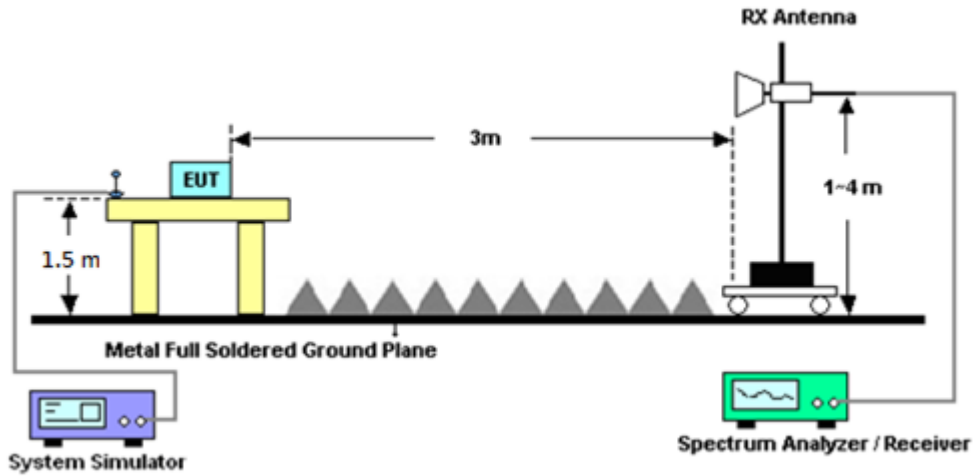

For radiated emissions above 18GHz

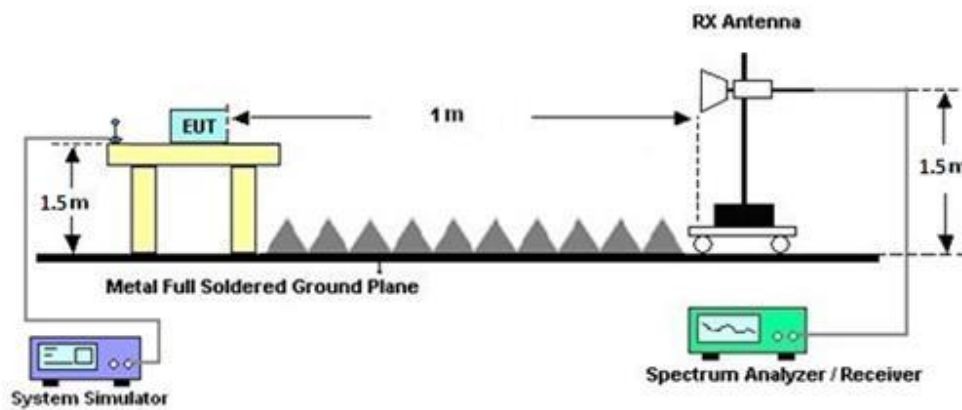

4.3 Test Result of Radiated Test

Please refer to Appendix B.

Note:

The low frequency, which started from 9 kHz to 30MHz, was pre-scanned and the result which was 20dB lower than the limit line was not reported.

There is adequate comparison measurement of both open-field test site and alternative test site - semi-Anechoic chamber according to 414788 D01 Radiated Test Site v01r01, and the result came out very similar.



4.4 Radiated Spurious Emission

4.4.1 Description of Radiated Spurious Emission Measurement

The radiated spurious emission was measured by substitution method according to ANSI / TIA-603-E. The power of any emission outside of the authorized operating frequency ranges must be attenuated below the transmitter power (P) by a factor of at least -40dBm / MHz .

The spectrum is scanned from 30 MHz up to a frequency including its 10th harmonic.

4.4.2 Test Procedures

The testing follows FCC KDB 971168 D01 v03r01 Section 7 and ANSI C63.26-2015 section 5.5.4 Radiated measurement using the field strength method.

1. The EUT was placed on a turntable with 0.8 meter height for frequency below 1GHz and 1.5 meter height for frequency above 1GHz respectively above ground.
2. The EUT was set 3 meters from the receiving antenna mounted on the antenna tower.
3. The table was rotated 360 degrees to determine the position of the highest spurious emission.
4. The height of the receiving antenna is varied between 1m to 4m to search the maximum spurious emission for both horizontal and vertical polarizations.
5. During the measurement, the system simulator parameters were set to force the EUT transmitting at maximum output power.
6. To convert spectrum reading E(dBuV/m) to EIRP(dBm)
 $EIRP(dBm) = Level (dBuV/m) + 20\log(d) - 104.77$, where d is the distance at which field strength limit is specified in the rules.
7. $Field\ Strength\ Level\ (dBm) = Spectrum\ Reading\ (dBm) + Antenna\ Factor + Cable\ Loss + Read\ Level - Preamp\ Factor.$
8. $ERP\ (dBm) = EIRP\ (dBm) - 2.15$
9. The RF fundamental frequency should be excluded against the limit line in the operating frequency band.



5 List of Measuring Equipment

Instrument	Brand Name	Model No.	Serial No.	Characteristics	Calibration Date	Test Date	Due Date	Remark
LOOP Antenna	Rohde & Schwarz	HFH2-Z2	100488	9 kHz~30 MHz	Sep. 12, 2023	Feb. 16, 2024~ Feb. 20, 2024	Sep. 11, 2024	Radiation (03CH21-HY)
Bilog Antenna	TESEQ	CBL 6111D&00802N1 D01N-06	55606 & 08	30MHz~1GHz	Oct. 15, 2023	Feb. 16, 2024~ Feb. 20, 2024	Oct. 14, 2024	Radiation (03CH21-HY)
Double Ridged Guide Horn Antenna	RFSPIN	DRH18-E	LE2C03A18EN	1GHz~18GHz	Jul. 12, 2023	Feb. 16, 2024~ Feb. 20, 2024	Jul. 11, 2024	Radiation (03CH21-HY)
SHF-EHF Horn Antenna	SCHWARZBE CK	BBHA 9170	1223	18GHz~40GHz	Jul. 10, 2023	Feb. 16, 2024~ Feb. 20, 2024	Jul. 09, 2024	Radiation (03CH21-HY)
Amplifier	SONOMA	310N	421580	30MHz~1GHz	Jul. 15, 2023	Feb. 16, 2024~ Feb. 20, 2024	Jul. 14, 2024	Radiation (03CH21-HY)
Amplifier	EMEC	EM01G18GA	060876	1GHz~18GHz	Sep. 28, 2023	Feb. 16, 2024~ Feb. 20, 2024	Sep. 27, 2024	Radiation (03CH21-HY)
Preamplifier	EMEC	EM18G40G	060871	18GHz~40GHz	Aug. 30, 2023	Feb. 16, 2024~ Feb. 20, 2024	Aug. 29, 2024	Radiation (03CH21-HY)
Spectrum Analyzer	Keysight	N9010B	MY62170358	10Hz~44GHz	Aug. 28, 2023	Feb. 16, 2024~ Feb. 20, 2024	Aug. 27, 2024	Radiation (03CH21-HY)
RF Cable	HUBER + SUHNER	SUCOFLEX 102	804397/2,8046 12/2,804614/2	30MHz~40GHz	Oct. 24, 2023	Feb. 16, 2024~ Feb. 20, 2024	Oct. 23, 2024	Radiation (03CH21-HY)
Hygrometer	TECPEL	DTM-303A	TP211568	N/A	Nov. 30, 2023	Feb. 16, 2024~ Feb. 20, 2024	Nov. 29, 2024	Radiation (03CH21-HY)
Controller	EMEC	EM 1000	N/A	Control Turn table & Ant Mast	N/A	Feb. 16, 2024~ Feb. 20, 2024	N/A	Radiation (03CH21-HY)
Antenna Mast	EMEC	AM-BS-4500-B	N/A	1~4m	N/A	Feb. 16, 2024~ Feb. 20, 2024	N/A	Radiation (03CH21-HY)
Turn Table	EMEC	TT 2000	N/A	0~360 Degree	N/A	Feb. 16, 2024~ Feb. 20, 2024	N/A	Radiation (03CH21-HY)
Software	Audix	E3 6.2009-8-24	RK-001053	N/A	N/A	Feb. 16, 2024~ Feb. 20, 2024	N/A	Radiation (03CH21-HY)
Radio Communication Analyzer	Anritsu	MT8821C	6262025353	LTE FDD/TDD LTE-2CC DLCA/ULCA	Oct. 03, 2023	Dec. 28, 2023~ Mar. 08, 2024	Oct. 02, 2024	Conducted (TH03-HY)
Spectrum Analyzer	Rohde & Schwarz	FSV40	101906	10Hz~40GHz	Jul. 25, 2023	Dec. 28, 2023~ Mar. 08, 2024	Jul. 24, 2024	Conducted (TH03-HY)
Thermal Chamber	ESPEC	SU-241	92003713	-30℃ ~95℃	May 17, 2023	Dec. 28, 2023~ Mar. 08, 2024	May 16, 2024	Conducted (TH03-HY)
DC Power Supply	GW Instek	GPP-2323	GES906037	0V~64V ; 0A~6A	Nov. 28, 2023	Dec. 28, 2023~ Mar. 08, 2024	Nov. 27, 2024	Conducted (TH03-HY)
Coupler	Warison	20dB 25W SMA Directional Coupler	#A	1-18GHz	Jan. 03, 2023	Dec. 28, 2023~ Jan. 01, 2024	Jan. 02, 2024	Conducted (TH03-HY)
Coupler	Warison	20dB 25W SMA Directional Coupler	#A	1-18GHz	Jan. 02, 2024	Jan. 02, 2024~ Mar. 08, 2024	Jan. 01, 2025	Conducted (TH03-HY)



6 Measurement Uncertainty

Uncertainty of Radiated Emission Measurement (30 MHz ~ 1000 MHz)

Measuring Uncertainty for a Level of Confidence of 95% ($U = 2Uc(y)$)	3.04 dB
---	---------

Uncertainty of Radiated Emission Measurement (1 GHz ~ 18 GHz)

Measuring Uncertainty for a Level of Confidence of 95% ($U = 2Uc(y)$)	3.33 dB
---	---------

Uncertainty of Radiated Emission Measurement (18 GHz ~ 40 GHz)

Measuring Uncertainty for a Level of Confidence of 95% ($U = 2Uc(y)$)	3.68 dB
---	---------



Appendix A. Test Results of Conducted Test

Conducted Output Power(Average power & EIRP)

LTE Band 48 Maximum Average Power [dBm] (GT - LC = 1 dB)								
BW [MHz]	RB Size	RB Offset	Mod	Lowest	Middle	Highest	EIRP (dBm)	EIRP (W)
20	1	0	QPSK	21.67	21.69	21.75	22.75	0.1884
20	1	49		21.64	21.46	21.62		
20	1	99		21.56	21.47	21.53		
20	50	0		20.66	20.62	20.68		
20	50	24		20.78	20.70	20.63		
20	50	50		20.73	20.69	20.52		
20	100	0		20.74	20.65	20.59		
20	1	0	16-QAM	20.84	20.74	20.80	21.84	0.1528
20	1	49		20.61	20.73	20.67		
20	1	99		20.83	20.73	20.67		
20	50	0		19.75	19.82	19.65		
20	50	24		19.66	19.78	19.72		
20	50	50		19.82	19.67	19.62		
20	100	0		19.73	19.74	19.68		
20	1	0	64-QAM	19.52	19.61	19.57	20.61	0.1151
20	1	49		19.50	19.50	19.34		
20	1	99		19.40	19.40	19.35		
20	50	0		18.70	18.74	18.70		
20	50	24		18.83	18.73	18.66		
20	50	50		18.77	18.62	18.65		
20	100	0		18.79	18.68	18.63		
Limit	EIRP < 23dBm/10MHz			Result			Pass	

Total EIRP power is less than partial EIRP limit 23 dBm/10MHz.



LTE Band 48 Maximum Average Power [dBm] (GT - LC = 1 dB)								
BW [MHz]	RB Size	RB Offset	Mod	Lowest	Middle	Highest	EIRP (dBm)	EIRP (W)
15	1	0	QPSK	21.54	21.61	21.62	22.62	0.1828
15	1	37		21.57	21.44	21.55		
15	1	74		21.52	21.40	21.51		
15	36	0		20.56	20.61	20.51		
15	36	20		20.67	20.54	20.46		
15	36	39		20.56	20.59	20.35		
15	75	0		20.60	20.50	20.47		
15	1	0	16-QAM	20.66	20.69	20.72	21.73	0.1489
15	1	37		20.50	20.73	20.58		
15	1	74		20.71	20.68	20.66		
15	36	0		19.70	19.78	19.49		
15	36	20		19.64	19.58	19.64		
15	36	39		19.76	19.59	19.56		
15	75	0		19.55	19.64	19.51		
15	1	0	64-QAM	19.35	19.45	19.46	20.46	0.1112
15	1	37		19.36	19.40	19.33		
15	1	74		19.33	19.24	19.31		
15	36	0		18.61	18.63	18.60		
15	36	20		18.79	18.70	18.65		
15	36	39		18.64	18.46	18.47		
15	75	0		18.63	18.53	18.48		
Limit	EIRP < 23dBm/10MHz			Result			Pass	

Total EIRP power is less than partial EIRP limit 23 dBm/10MHz.



LTE Band 48 Maximum Average Power [dBm] (GT - LC = 1 dB)								
BW [MHz]	RB Size	RB Offset	Mod	Lowest	Middle	Highest	EIRP (dBm)	EIRP (W)
10	1	0	QPSK	21.48	21.58	21.66	22.66	0.1845
10	1	25		21.53	21.40	21.61		
10	1	49		21.40	21.40	21.48		
10	25	0		20.56	20.58	20.52		
10	25	12		20.65	20.66	20.63		
10	25	25		20.69	20.61	20.49		
10	50	0		20.56	20.54	20.56		
10	1	0	16-QAM	20.66	20.72	20.75	21.79	0.1510
10	1	25		20.54	20.54	20.54		
10	1	49		20.79	20.64	20.66		
10	25	0		19.55	19.73	19.51		
10	25	12		19.48	19.65	19.60		
10	25	25		19.70	19.63	19.44		
10	50	0		19.53	19.65	19.57		
10	1	0	64-QAM	19.37	19.46	19.39	20.47	0.1114
10	1	25		19.47	19.43	19.34		
10	1	49		19.38	19.39	19.24		
10	25	0		18.55	18.60	18.65		
10	25	12		18.76	18.61	18.46		
10	25	25		18.61	18.45	18.53		
10	50	0		18.77	18.64	18.58		
Limit	EIRP < 23dBm/10MHz			Result			Pass	

Total EIRP power is less than partial EIRP limit 23 dBm/10MHz.



LTE Band 48 Maximum Average Power [dBm] (GT - LC = 1 dB)								
BW [MHz]	RB Size	RB Offset	Mod	Lowest	Middle	Highest	EIRP (dBm)	EIRP (W)
5	1	0	QPSK	21.66	21.52	21.73	22.73	0.1875
5	1	12		21.44	21.40	21.53		
5	1	24		21.40	21.27	21.37		
5	12	0		20.63	20.59	20.56		
5	12	7		20.78	20.58	20.43		
5	12	13		20.60	20.50	20.49		
5	25	0		20.61	20.55	20.45		
5	1	0	16-QAM	20.81	20.72	20.61	21.81	0.1517
5	1	12		20.51	20.70	20.51		
5	1	24		20.69	20.56	20.65		
5	12	0		19.71	19.72	19.59		
5	12	7		19.60	19.63	19.65		
5	12	13		19.74	19.63	19.58		
5	25	0		19.65	19.61	19.65		
5	1	0	64-QAM	19.42	19.58	19.38	20.58	0.1143
5	1	12		19.31	19.43	19.29		
5	1	24		19.20	19.37	19.19		
5	12	0		18.70	18.66	18.68		
5	12	7		18.63	18.69	18.52		
5	12	13		18.77	18.54	18.60		
5	25	0		18.68	18.52	18.56		
Limit	EIRP < 23dBm/10MHz			Result			Pass	

Total EIRP power is less than partial EIRP limit 23 dBm/10MHz.



LTE Band 48C_CA Maximum Average Power [dBm] (GT - LC = 1 dB)										
BW [MHz]	PCC		SCC		Mod	Lowest	Middle	Highest	EIRP (dBm)	EIRP (W)
	RB Size	RB Offset	RB Size	RB Offset						
20+20	100	0	100	0	QPSK	18.43	18.49	18.50	21.97	0.1574
20+20	1	0	1	99		11.07	11.02	10.95		
20+20	1	99	1	0		20.97	20.96	20.94		
20+20	100	0	100	0	16-QAM	18.46	18.55	18.50	22.64	0.1837
20+20	1	0	1	99		10.91	10.95	10.99		
20+20	1	99	1	0		21.54	21.54	21.64		
20+20	100	0	100	0	64-QAM	19.52	19.60	19.56	20.73	0.1183
20+20	1	0	1	99		11.09	11.14	11.14		
20+20	1	99	1	0		19.57	19.65	19.73		
20+15	100	0	75	0	QPSK	18.52	18.51	18.43	21.97	0.1574
20+15	1	0	1	74		11.04	11.01	10.97		
20+15	1	74	1	0		20.92	20.97	20.94		
20+15	100	0	75	0	16-QAM	18.54	18.57	18.49	22.55	0.1799
20+15	1	0	1	74		10.94	10.91	10.91		
20+15	1	74	1	0		21.51	21.54	21.55		
20+15	100	0	75	0	64-QAM	19.57	19.58	19.53	20.62	0.1153
20+15	1	0	1	74		11.12	11.10	11.05		
20+15	1	74	1	0		19.62	19.58	19.54		
15+20	75	0	100	0	QPSK	18.61	18.53	18.61	22.09	0.1618
15+20	1	0	1	99		11.08	11.04	11.05		
15+20	1	74	1	0		20.95	20.97	21.09		
15+20	75	0	100	0	16-QAM	18.67	18.59	18.66	22.59	0.1816
15+20	1	0	1	99		10.89	11.04	11.07		
15+20	1	74	1	0		21.46	21.46	21.59		
15+20	75	0	100	0	64-QAM	19.69	19.62	19.62	20.75	0.1189
15+20	1	0	1	99		11.28	11.28	11.23		
15+20	1	74	1	0		19.75	19.75	19.75		
Limit	EIRP < 23dBm/10MHz					Result			Pass	

Total EIRP power is less than partial EIRP limit 23 dBm/10MHz.



LTE Band 48C_CA Maximum Average Power [dBm] (GT - LC = 1 dB)										
BW [MHz]	PCC		SCC		Mod	Lowest	Middle	Highest	EIRP (dBm)	EIRP (W)
	RB Size	RB Offset	RB Size	RB Offset						
20+10	100	0	50	0	QPSK	18.57	18.51	18.72	22.09	0.1618
20+10	1	0	1	49		11.07	11.05	11.08		
20+10	1	99	1	0		20.99	21.09	21.06		
20+10	100	0	50	0	16-QAM	18.67	18.58	18.72	22.64	0.1837
20+10	1	0	1	49		10.92	11.05	10.96		
20+10	1	99	1	0		21.56	21.60	21.64		
20+10	100	0	50	0	64-QAM	19.66	19.60	19.72	20.85	0.1216
20+10	1	0	1	49		11.23	11.25	11.34		
20+10	1	99	1	0		19.82	19.70	19.85		
10+20	50	0	100	0	QPSK	18.43	18.52	18.57	22.12	0.1629
10+20	1	0	1	99		11.05	11.03	11.06		
10+20	1	49	1	0		21.00	21.01	21.12		
10+20	50	0	100	0	16-QAM	18.50	18.60	18.68	22.67	0.1849
10+20	1	0	1	99		10.89	10.97	11.07		
10+20	1	49	1	0		21.59	21.59	21.67		
10+20	50	0	100	0	64-QAM	19.52	19.60	19.64	20.81	0.1205
10+20	1	0	1	99		11.04	11.15	11.19		
10+20	1	49	1	0		19.61	19.61	19.81		
20+5	100	0	25	0	QPSK	18.45	18.52	18.48	21.83	0.1524
20+5	1	0	1	24		9.17	9.39	9.66		
20+5	1	99	1	0		20.83	20.71	20.49		
20+5	100	0	25	0	16-QAM	18.51	18.57	18.53	22.35	0.1718
20+5	1	0	1	24		8.77	8.95	9.33		
20+5	1	99	1	0		21.35	21.03	21.33		
20+5	100	0	25	0	64-QAM	19.55	19.59	19.44	21.07	0.1279
20+5	1	0	1	24		9.01	9.14	9.82		
20+5	1	99	1	0		20.04	19.90	20.07		
Limit	EIRP < 23dBm/10MHz					Result			Pass	

LTE Band 48C_CA Maximum Average Power [dBm] (GT - LC = 1 dB)										
BW [MHz]	PCC		SCC		Mod	Lowest	Middle	Highest	EIRP (dBm)	EIRP (W)
	RB Size	RB Offset	RB Size	RB Offset						
5+20	25	0	100	0	QPSK	18.56	18.49	18.52	22.12	0.1629
5+20	1	0	1	99		10.97	11.04	11.01		
5+20	1	24	1	0		21.00	21.00	21.12		
5+20	25	0	100	0	16-QAM	18.63	18.56	18.59	22.67	0.1849
5+20	1	0	1	99		10.85	10.99	11.01		
5+20	1	24	1	0		21.49	21.60	21.67		
5+20	25	0	100	0	64-QAM	19.61	19.63	19.58	20.74	0.1186
5+20	1	0	1	99		11.17	11.14	11.13		
5+20	1	24	1	0		19.74	19.69	19.70		
Limit	EIRP < 23dBm/10MHz					Result			Pass	

Total EIRP power is less than partial EIRP limit 23 dBm/10MHz.



LTE Band 48

Peak-to-Average Ratio

Mode	LTE Band 48 / 20MHz				
Mod.	QPSK	16QAM	64QAM	256QAM	Limit: 13dB
RB Size	Full RB	Full RB	Full RB	Full RB	Result
Middle CH	5.59	6.61	6.75	-	PASS

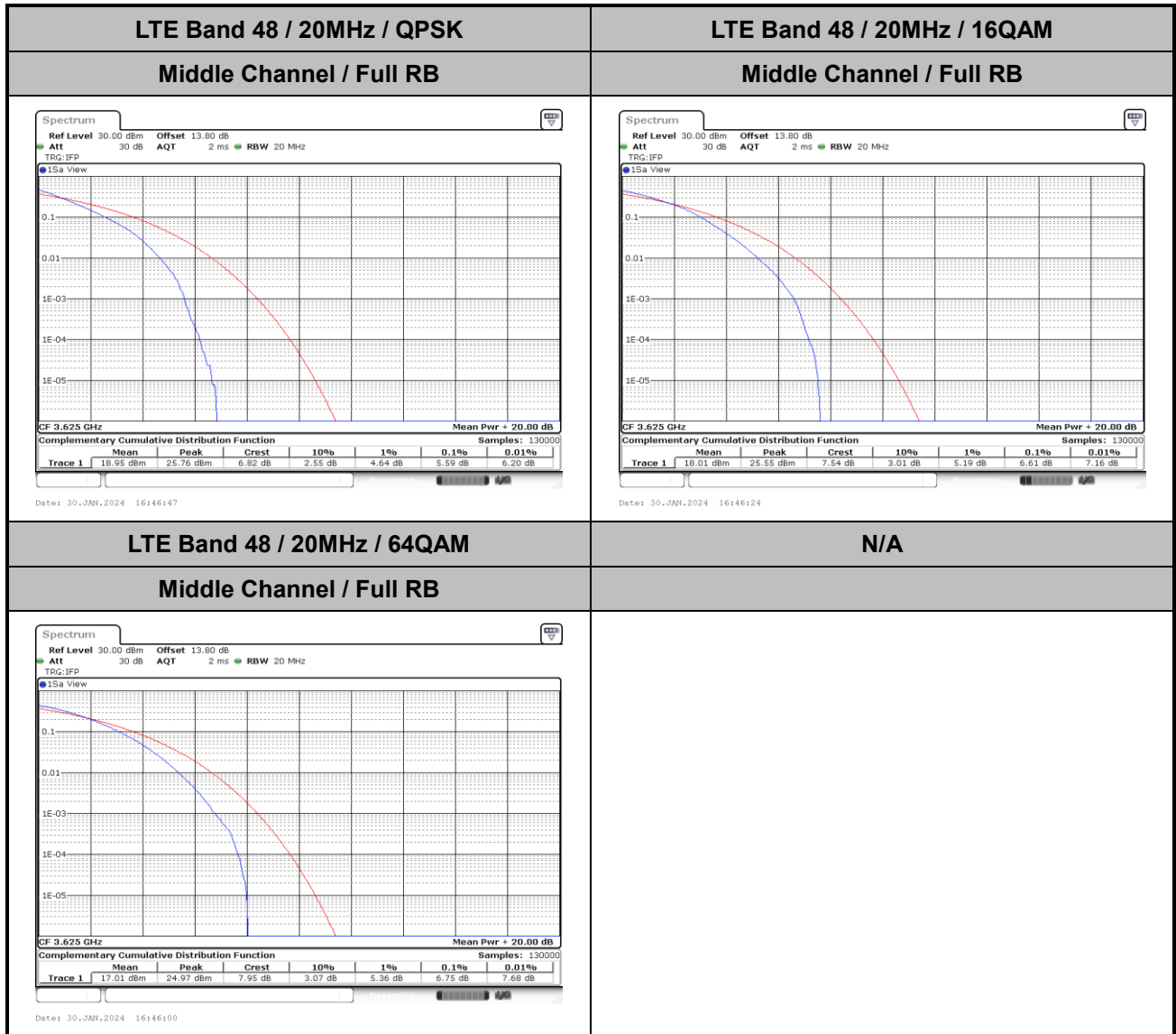



26dB Bandwidth

Mode	LTE Band 48 : 26dB BW(MHz)											
BW	1.4MHz		3MHz		5MHz		10MHz		15MHz		20MHz	
Mod.	QPSK	16QAM	QPSK	16QAM	QPSK	16QAM	QPSK	16QAM	QPSK	16QAM	QPSK	16QAM
Middle CH	-	-	-	-	4.86	4.86	9.66	9.68	14.35	14.23	18.78	18.82
Mode	LTE Band 48 : 26dB BW(MHz)											
BW	1.4MHz		3MHz		5MHz		10MHz		15MHz		20MHz	
Mod.	64QAM	256QAM	64QAM	256QAM	64QAM	256QAM	64QAM	256QAM	64QAM	256QAM	64QAM	256QAM
Middle CH	-	-	-	-	4.85	-	9.73	-	14.47	-	18.90	-



LTE Band 48

Middle Channel / 5MHz / QPSK

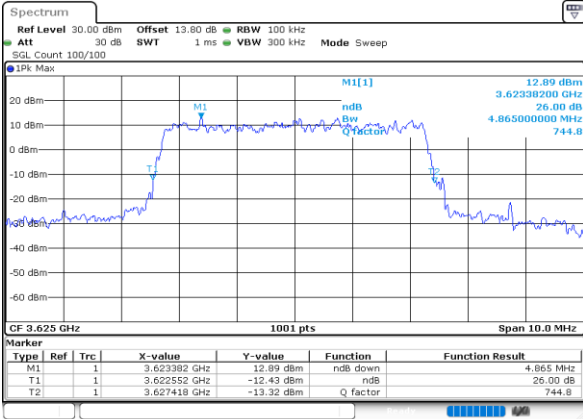

Date: 30_JAN_2024 16:19:03

Middle Channel / 5MHz / 16QAM

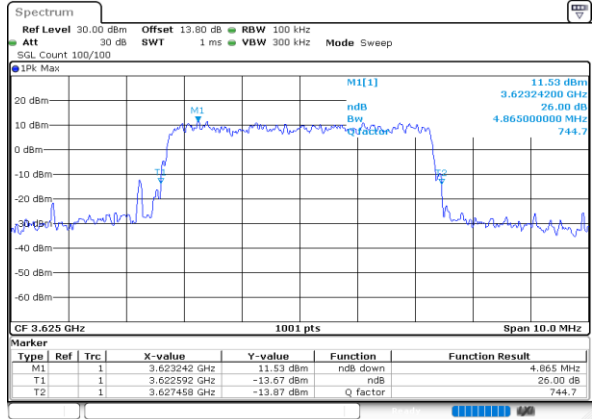

Date: 30_JAN_2024 16:19:25

Middle Channel / 10MHz / QPSK

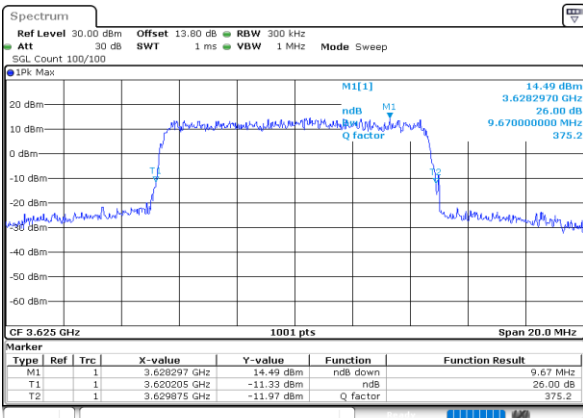

Date: 30_JAN_2024 16:27:36

Middle Channel / 10MHz / 16QAM

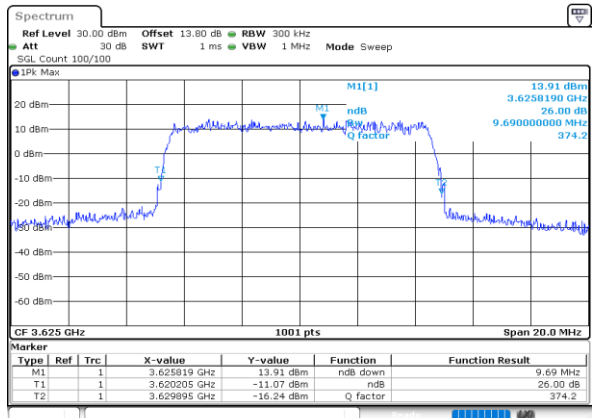

Date: 30_JAN_2024 16:27:59

Middle Channel / 15MHz / QPSK

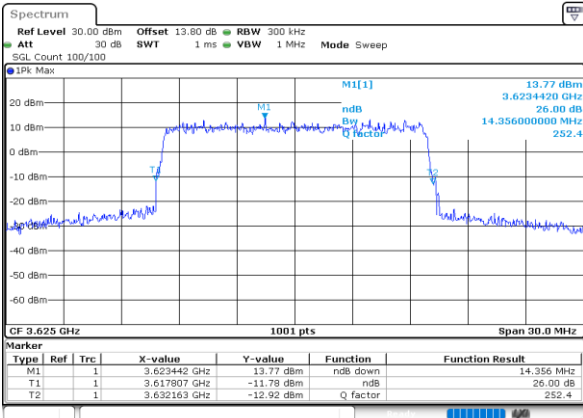

Date: 30_JAN_2024 16:36:03

Middle Channel / 15MHz / 16QAM

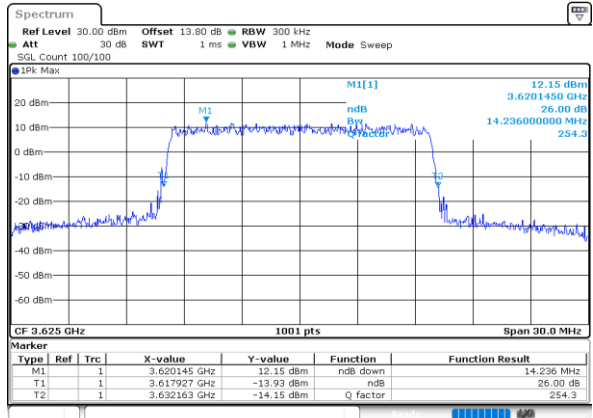

Date: 30_JAN_2024 16:36:25



LTE Band 48

Middle Channel / 20MHz / QPSK

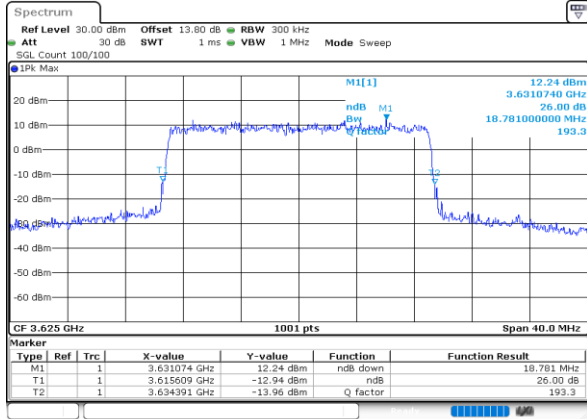

Date: 30_JAN_2024 16:44:29

Middle Channel / 20MHz / 16QAM

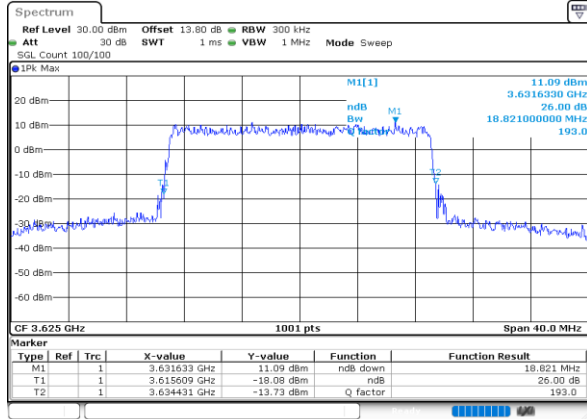

Date: 30_JAN_2024 16:44:52

Middle Channel / 5MHz / 64QAM

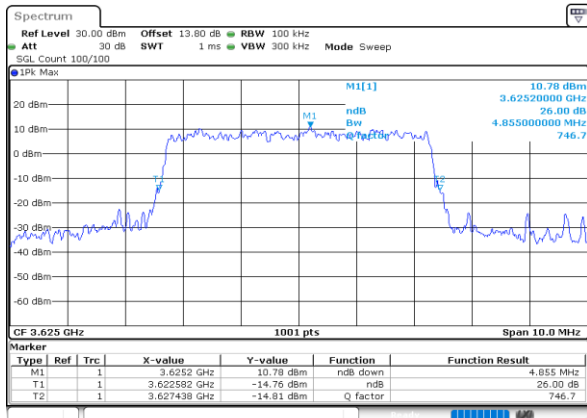

Date: 30_JAN_2024 16:20:10

Middle Channel / 10MHz / 64QAM

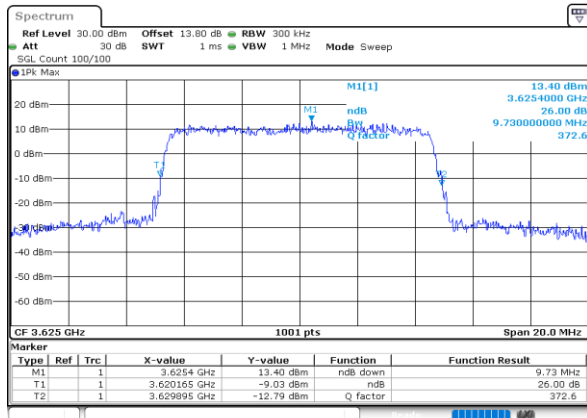

Date: 30_JAN_2024 16:28:44

Middle Channel / 15MHz / 64QAM

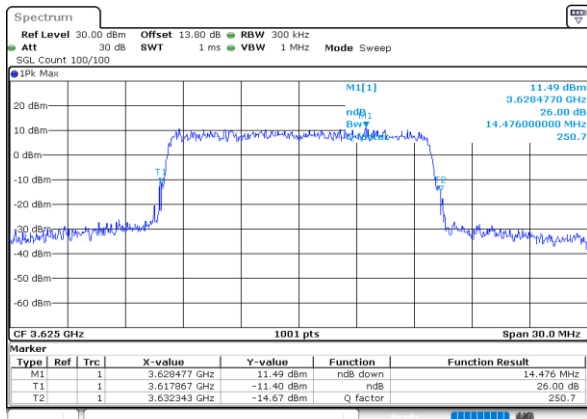

Date: 30_JAN_2024 16:37:10

Middle Channel / 20MHz / 64QAM

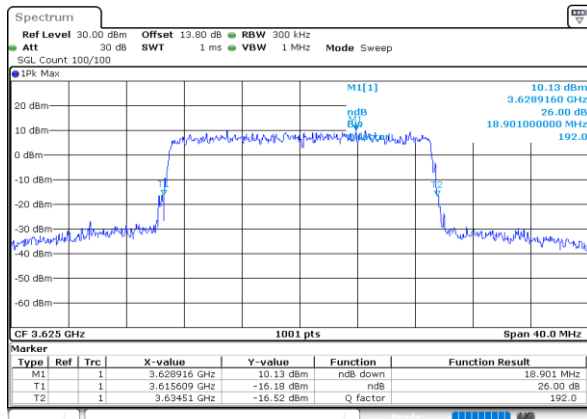

Date: 30_JAN_2024 16:45:37



Occupied Bandwidth

Mode	LTE Band 48 : 99%OBW(MHz)											
BW	1.4MHz		3MHz		5MHz		10MHz		15MHz		20MHz	
Mod.	QPSK	16QAM	QPSK	16QAM	QPSK	16QAM	QPSK	16QAM	QPSK	16QAM	QPSK	16QAM
Middle CH	-	-	-	-	4.50	4.49	9.03	9.03	13.45	13.45	17.94	17.86
Mode	LTE Band 48 : 99%OBW(MHz)											
BW	1.4MHz		3MHz		5MHz		10MHz		15MHz		20MHz	
Mod.	64QAM	256QAM	64QAM	256QAM	64QAM	256QAM	64QAM	256QAM	64QAM	256QAM	64QAM	256QAM
Middle CH	-	-	-	-	4.49	-	9.01	-	13.39	-	17.86	-



LTE Band 48

Middle Channel / 5MHz / QPSK

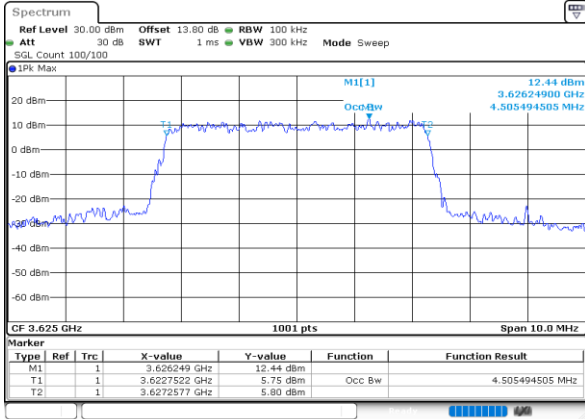

Date: 30.JAN.2024 16:18:17

Middle Channel / 5MHz / 16QAM

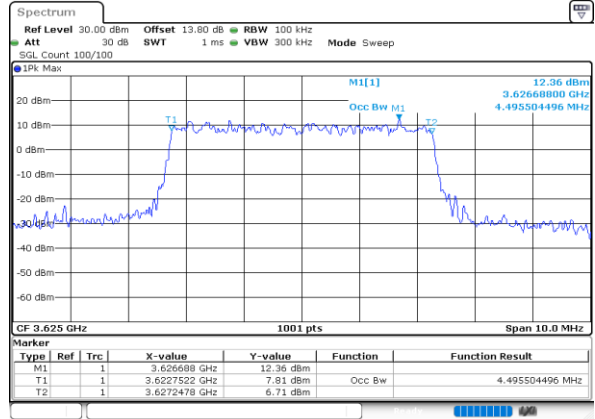

Date: 30.JAN.2024 16:18:40

Middle Channel / 10MHz / QPSK

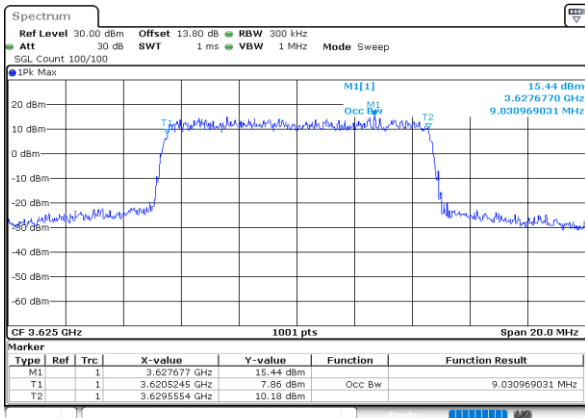

Date: 30.JAN.2024 16:26:51

Middle Channel / 10MHz / 16QAM

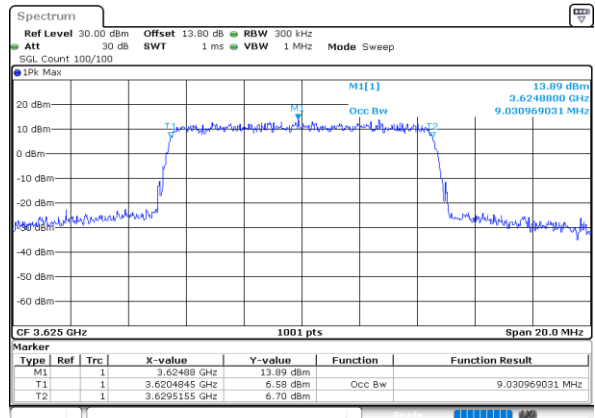

Date: 30.JAN.2024 16:27:14

Middle Channel / 15MHz / QPSK

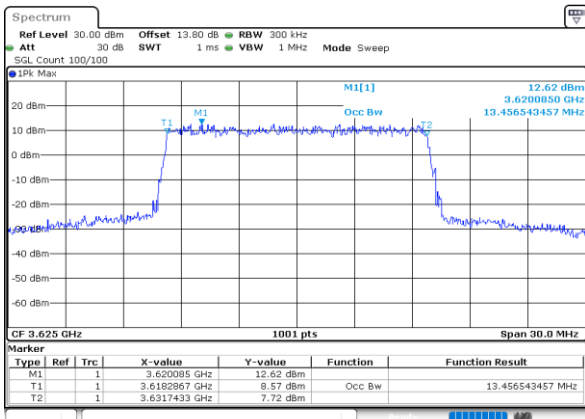

Date: 30.JAN.2024 16:35:18

Middle Channel / 15MHz / 16QAM

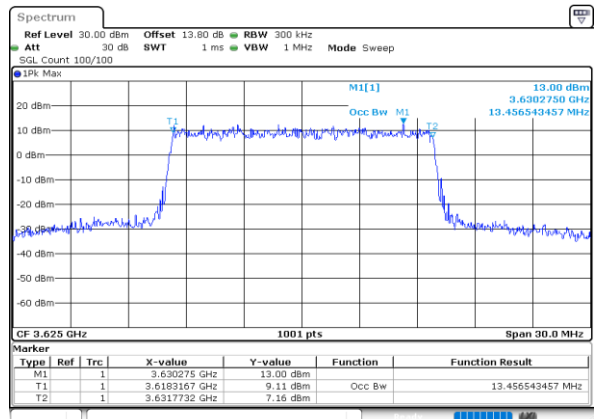

Date: 30.JAN.2024 16:35:40



LTE Band 48

Middle Channel / 20MHz / QPSK

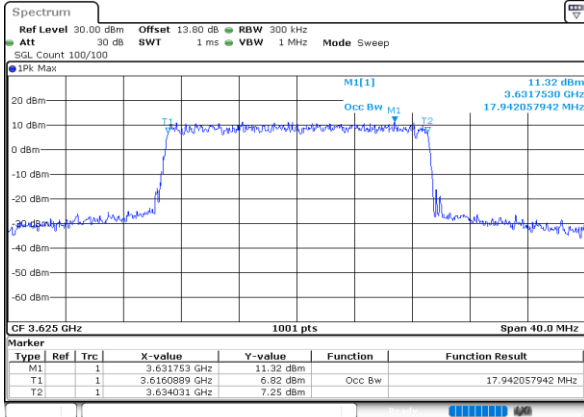

Date: 30_JAN.2024 16:43:44

Middle Channel / 20MHz / 16QAM

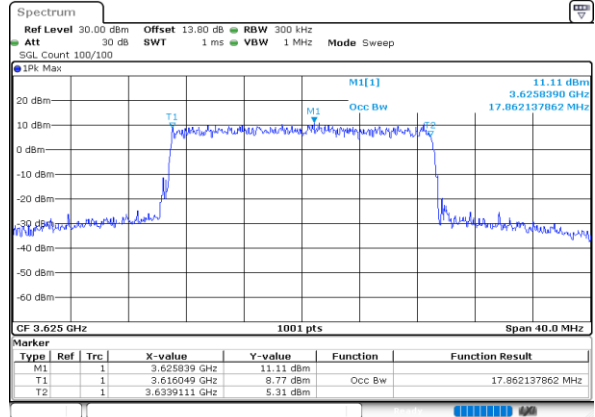

Date: 30_JAN.2024 16:44:06

Middle Channel / 5MHz / 64QAM

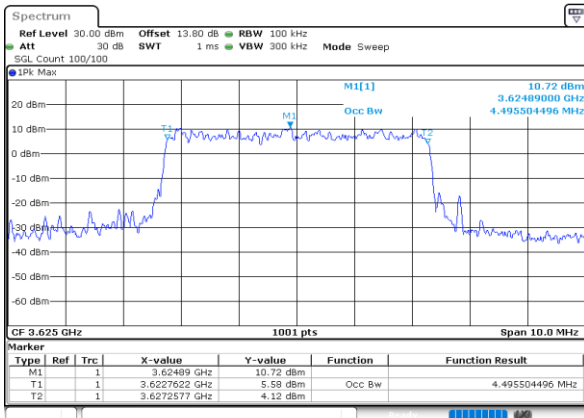

Date: 30_JAN.2024 16:19:40

Middle Channel / 10MHz / 64QAM

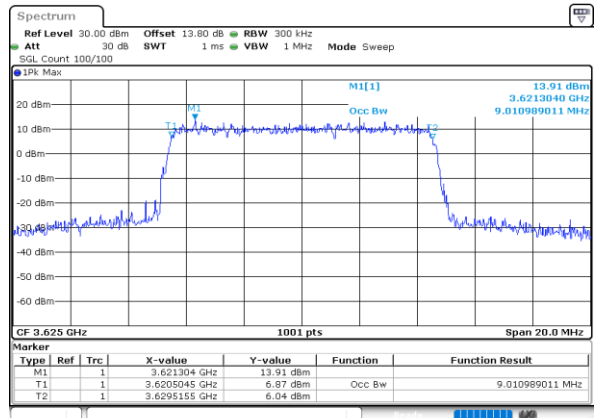

Date: 30_JAN.2024 16:28:21

Middle Channel / 15MHz / 64QAM

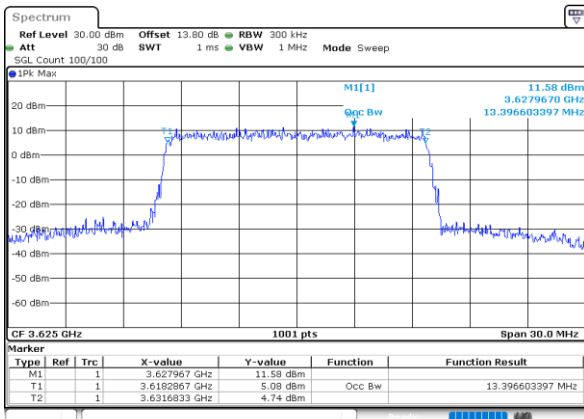

Date: 30_JAN.2024 16:36:40

Middle Channel / 20MHz / 64QAM

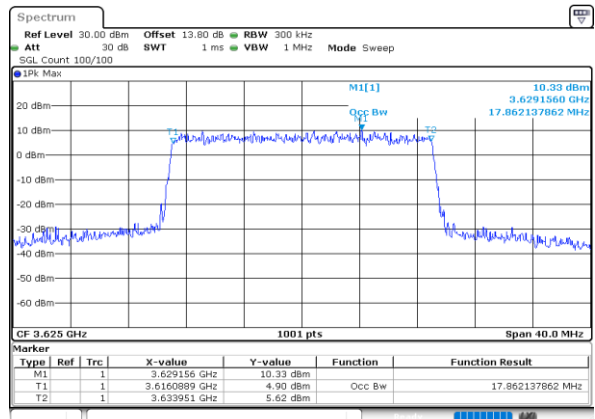

Date: 30_JAN.2024 16:45:14



ACLR

LTE Band 48 / 5MHz

QPSK

Lowest Channel / 1RB0

Lowest Channel / 1RBmax

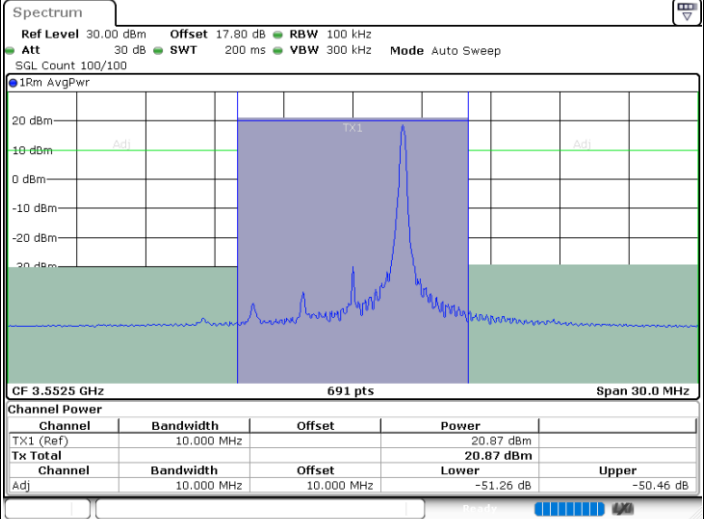
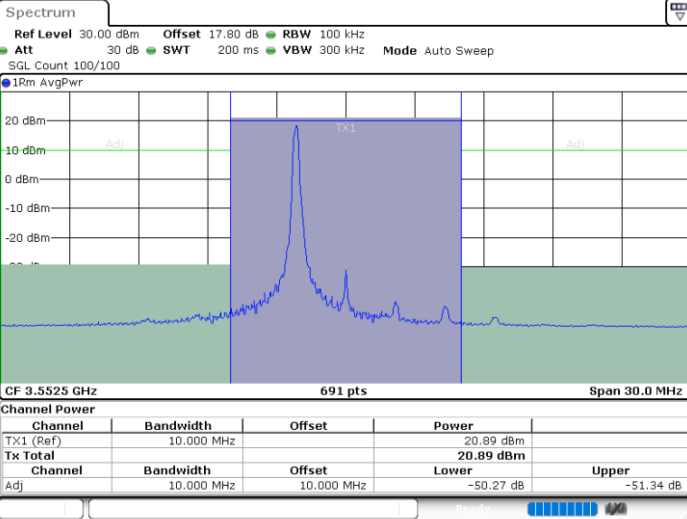

Date: 30.JAN.2024 15:59:43

Date: 30.JAN.2024 16:12:18

Lowest Channel / FullIRB

N/A

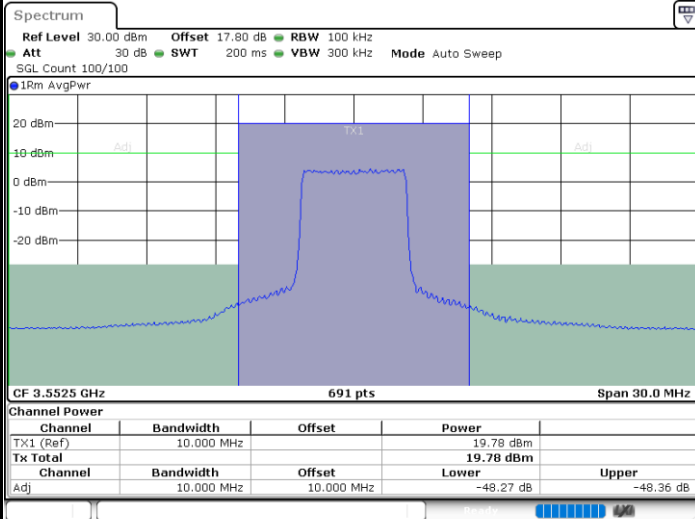

Date: 30.JAN.2024 16:06:01

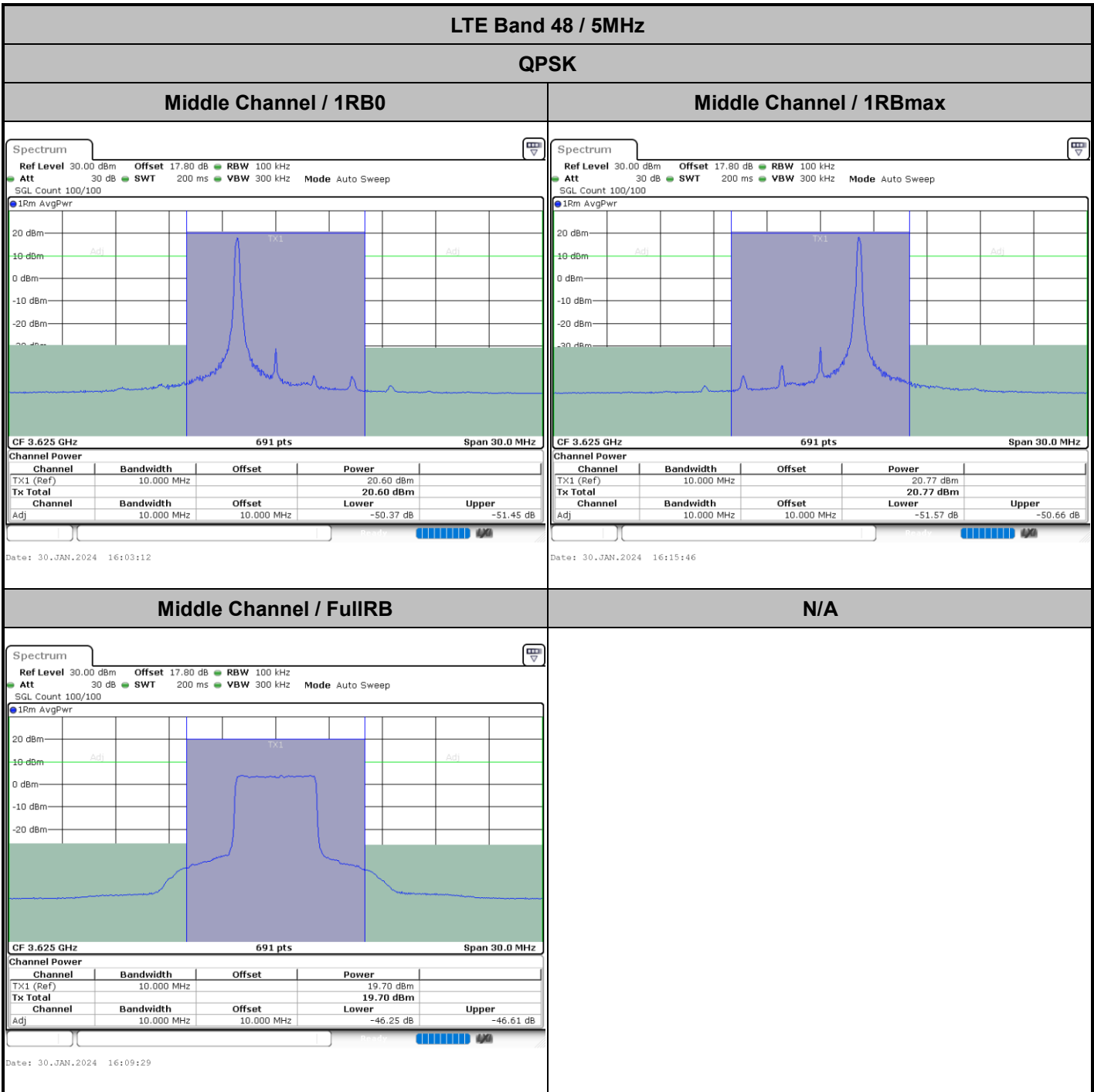



LTE Band 48 / 5MHz

QPSK

Highest Channel / 1RB0

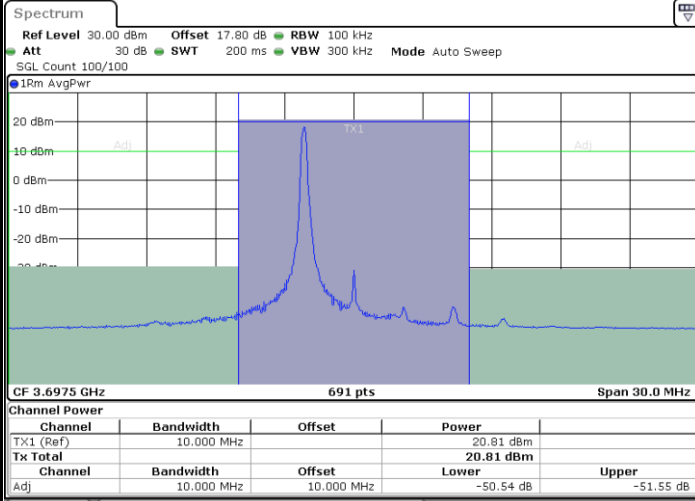

Date: 30.JAN.2024 16:03:54

Highest Channel / 1RBmax

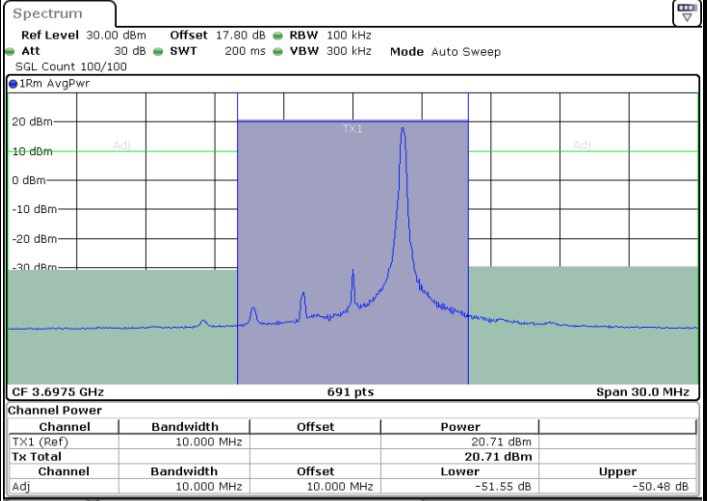

Date: 30.JAN.2024 16:16:29

Highest Channel / FullIRB

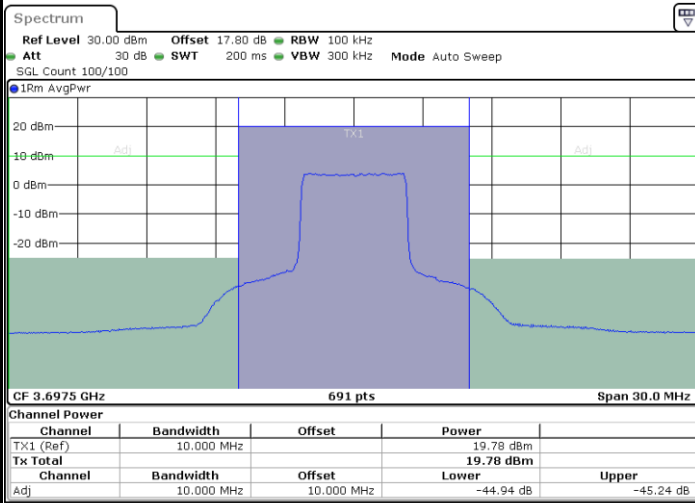

Date: 30.JAN.2024 16:10:12

N/A

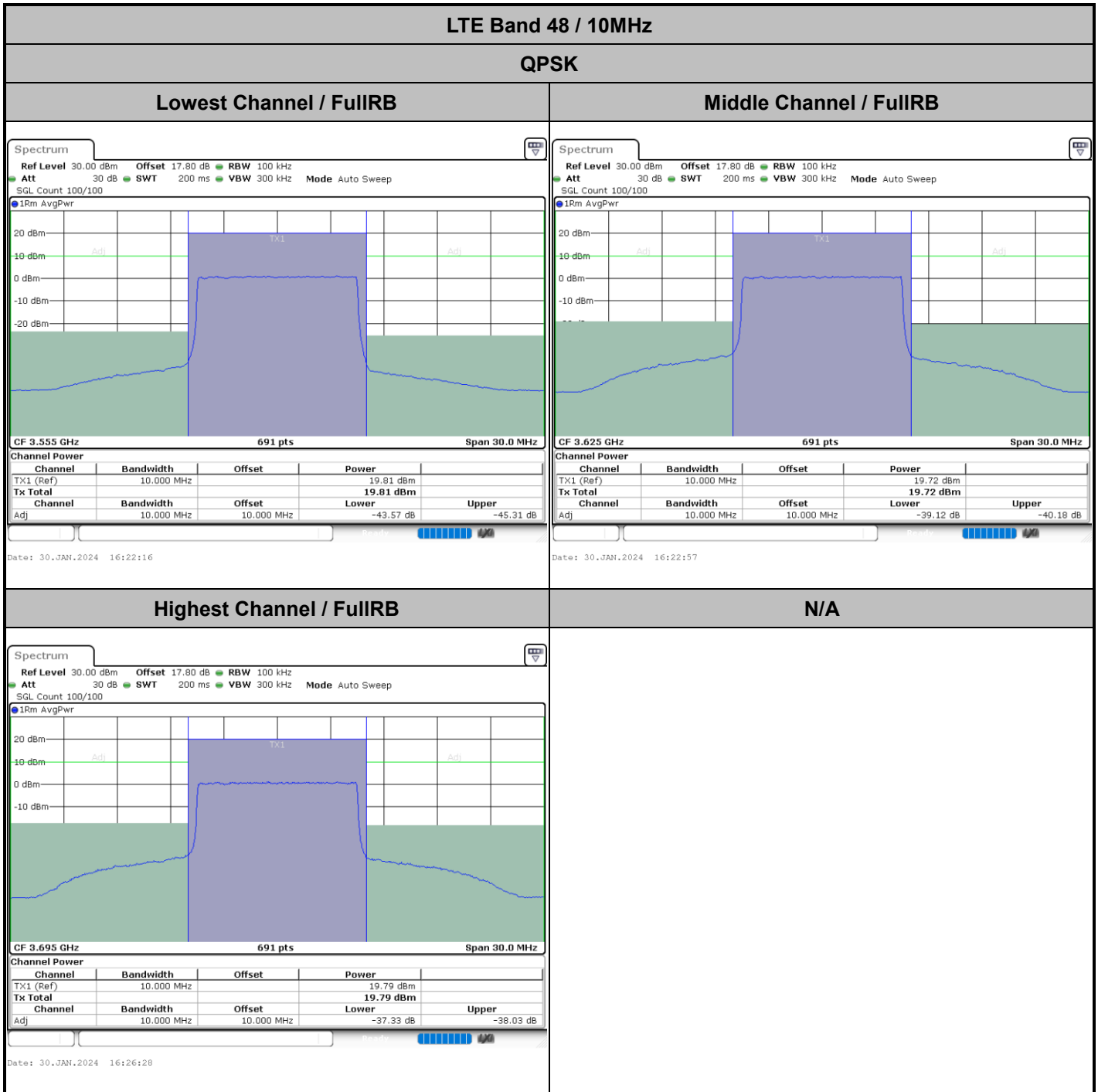

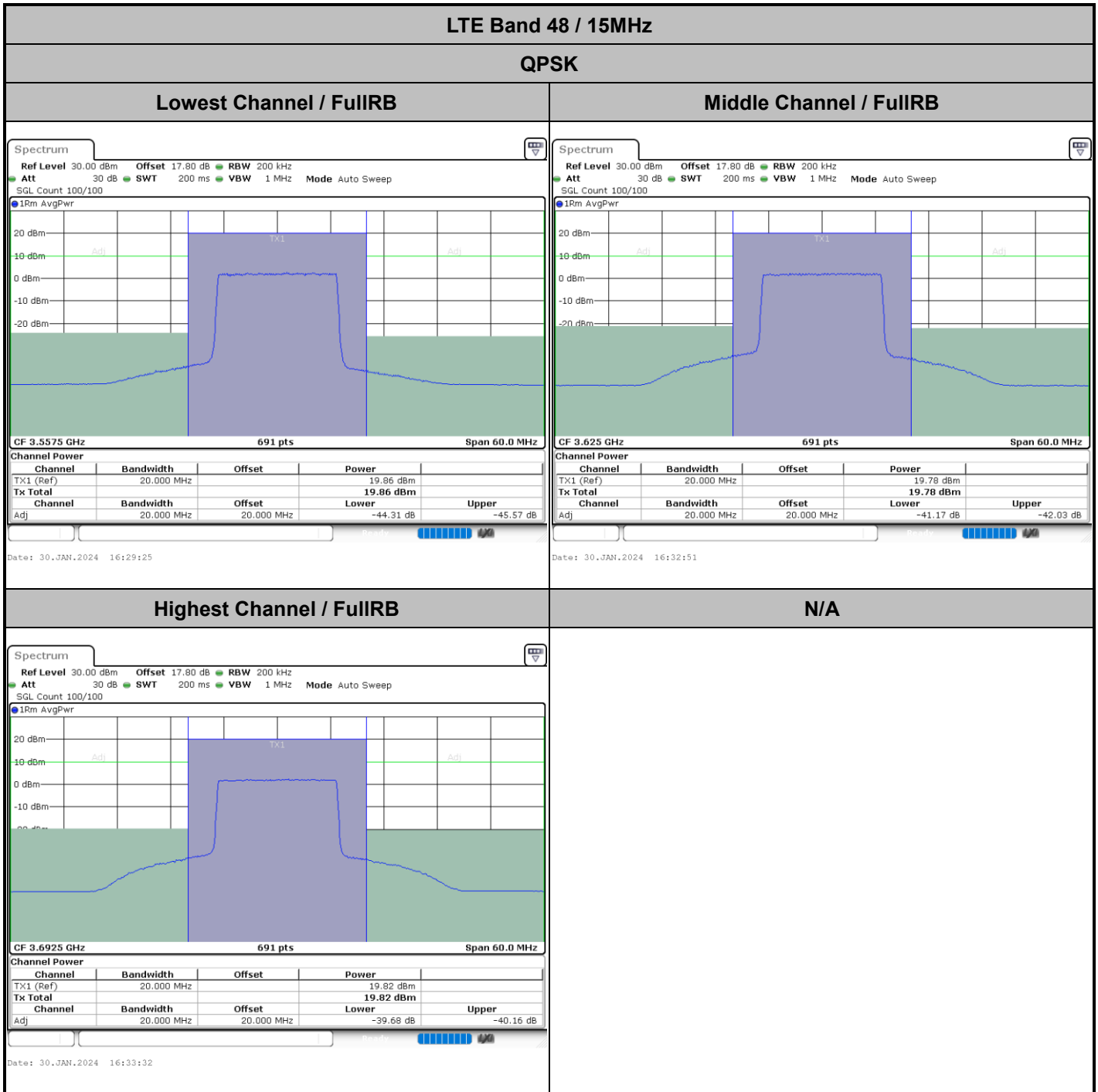

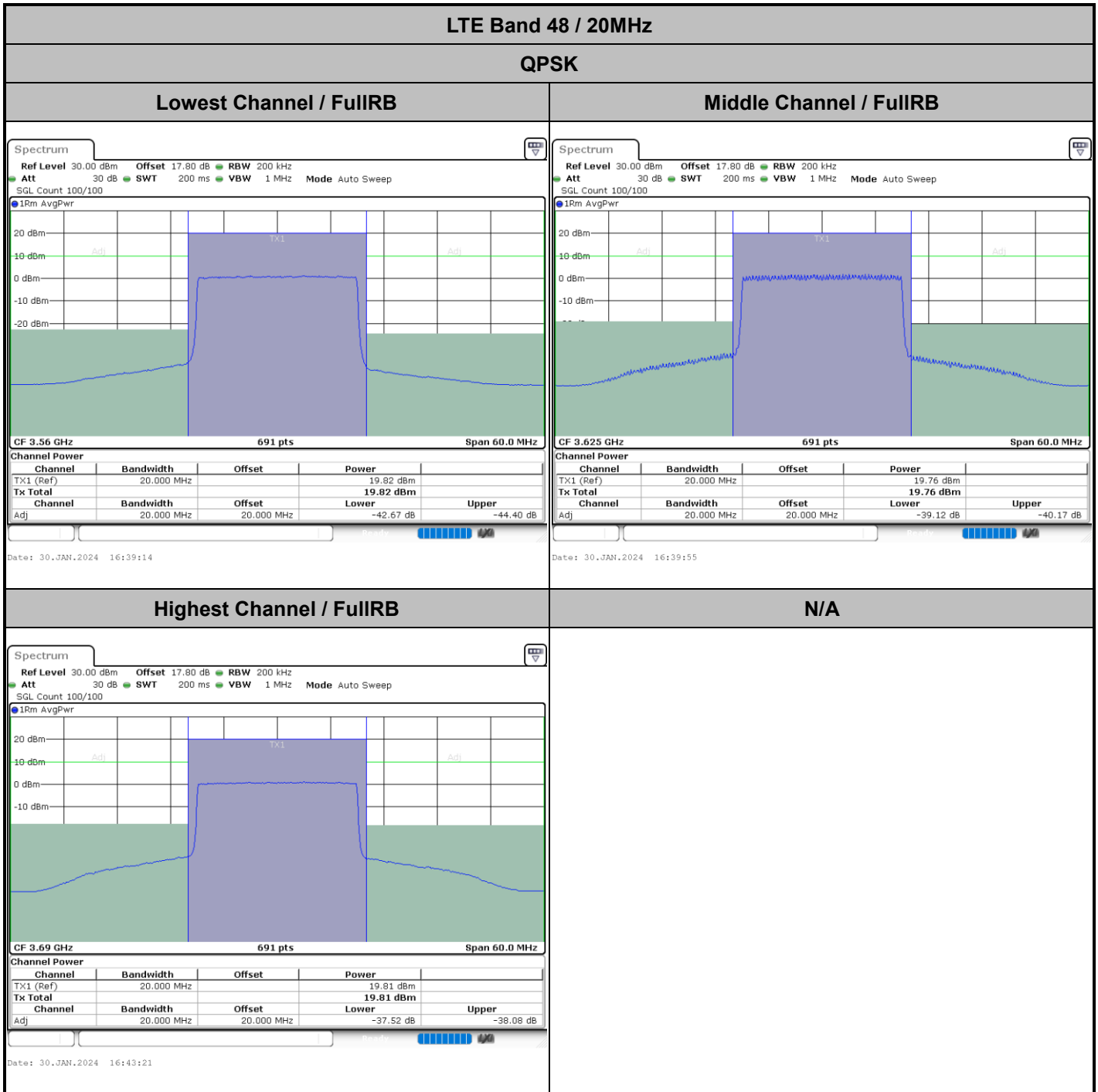

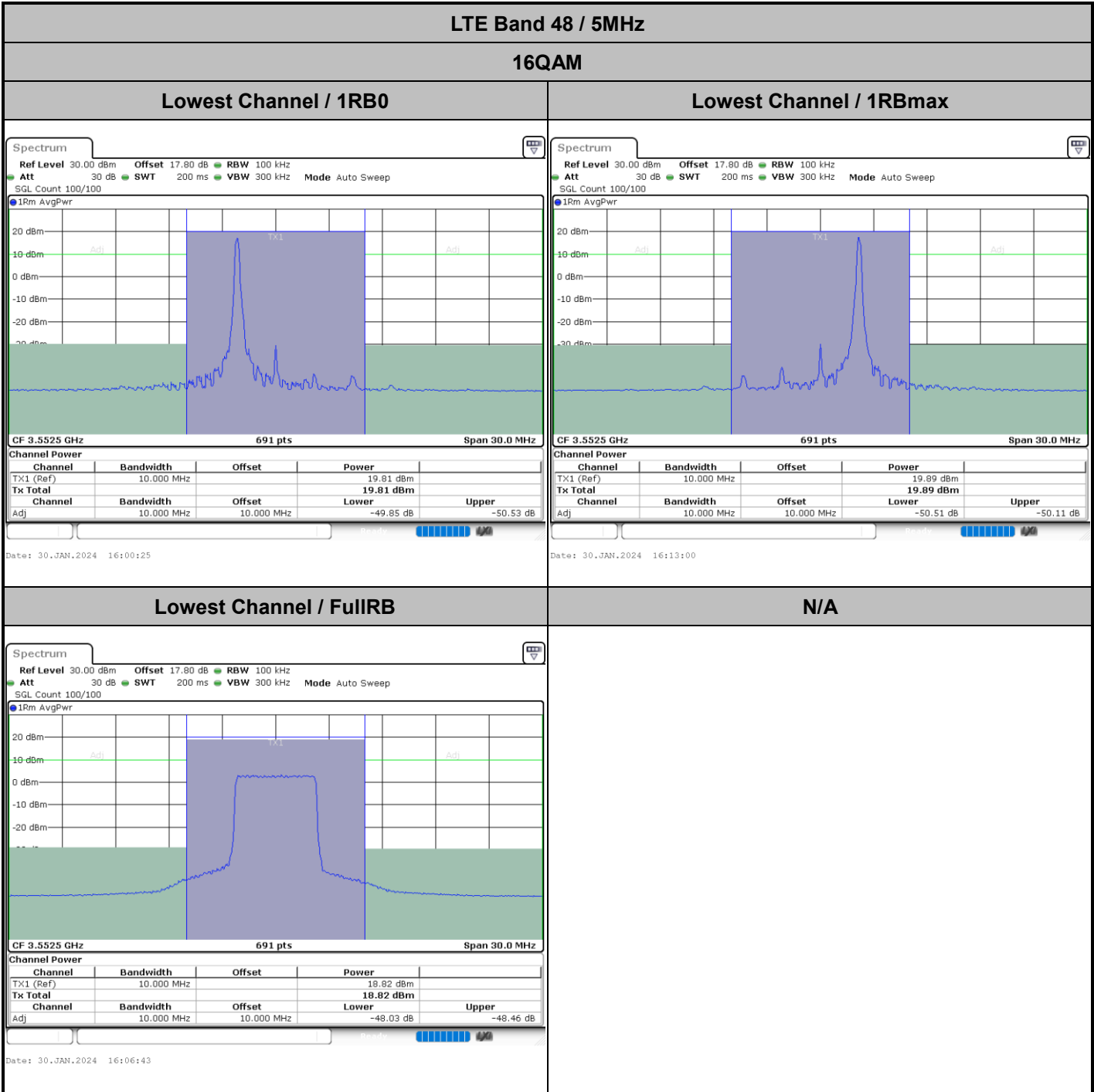



LTE Band 48 / 5MHz

16QAM

Middle Channel / 1RB0

Middle Channel / 1RBmax

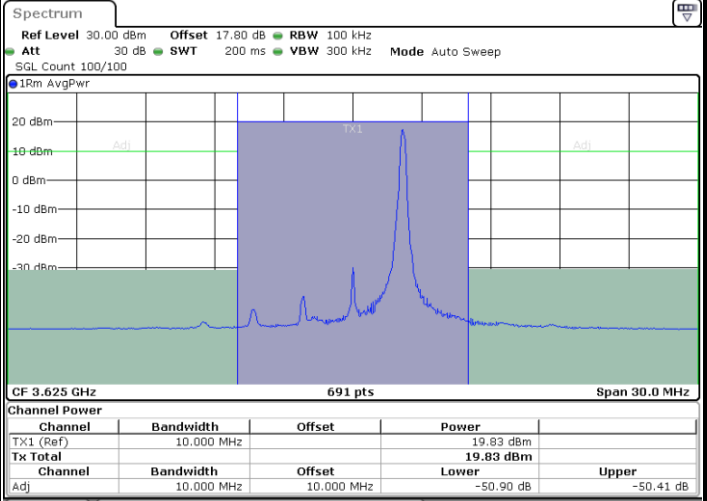
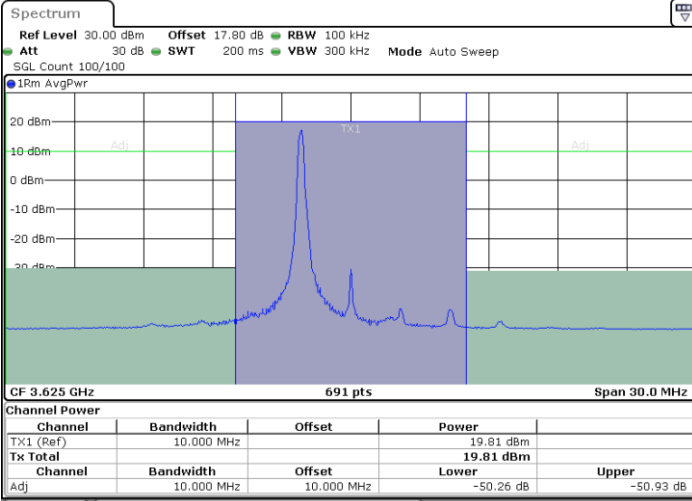

Date: 30.JAN.2024 16:02:30

Date: 30.JAN.2024 16:15:05

Middle Channel / FullIRB

N/A

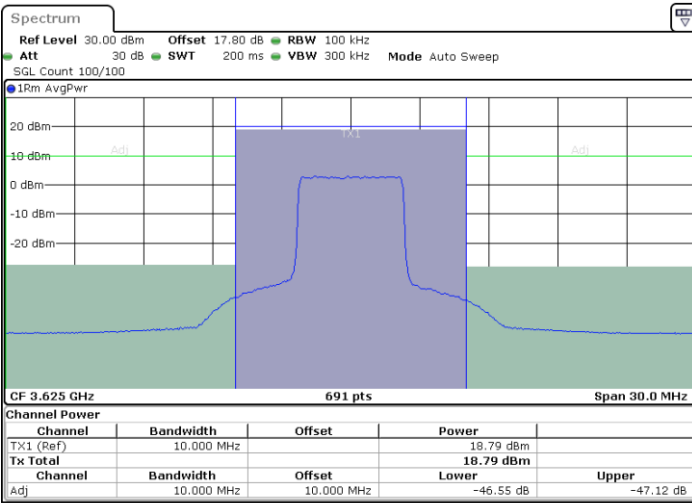

Date: 30.JAN.2024 16:08:48



LTE Band 48 / 5MHz

16QAM

Highest Channel / 1RB0

Highest Channel / 1RBmax

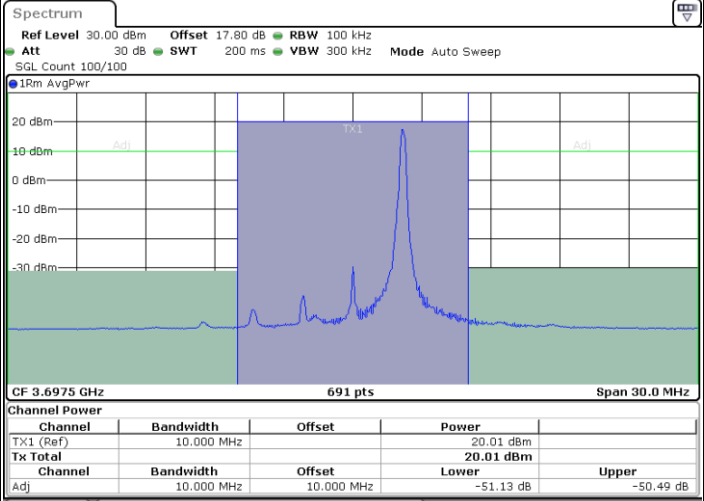
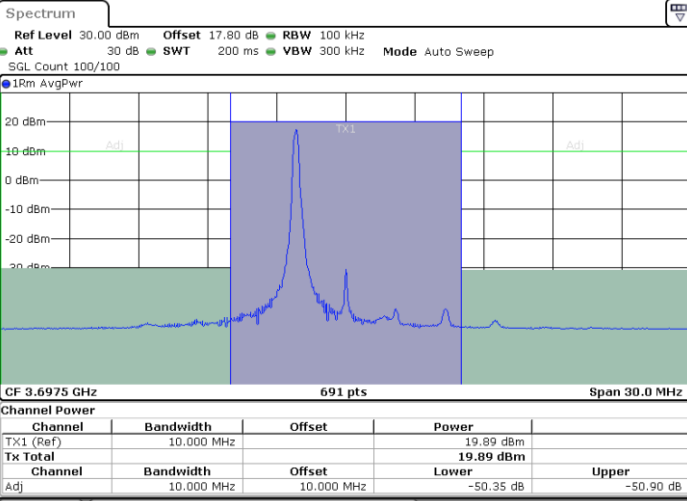

Date: 30.JAN.2024 16:04:36

Date: 30.JAN.2024 16:17:11

Highest Channel / FullIRB

N/A

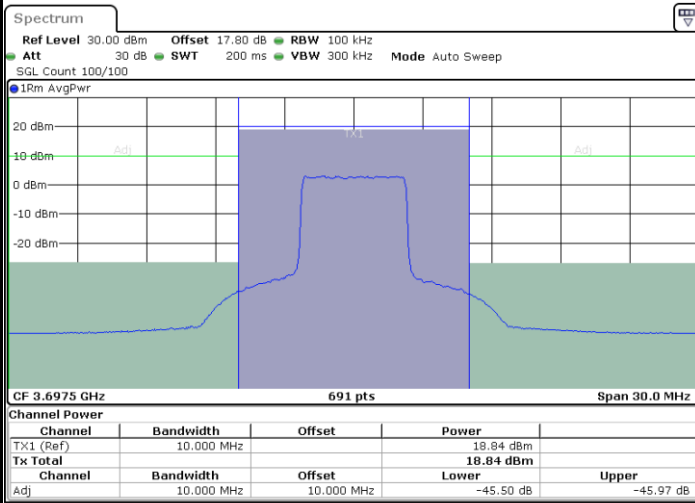

Date: 30.JAN.2024 16:10:54

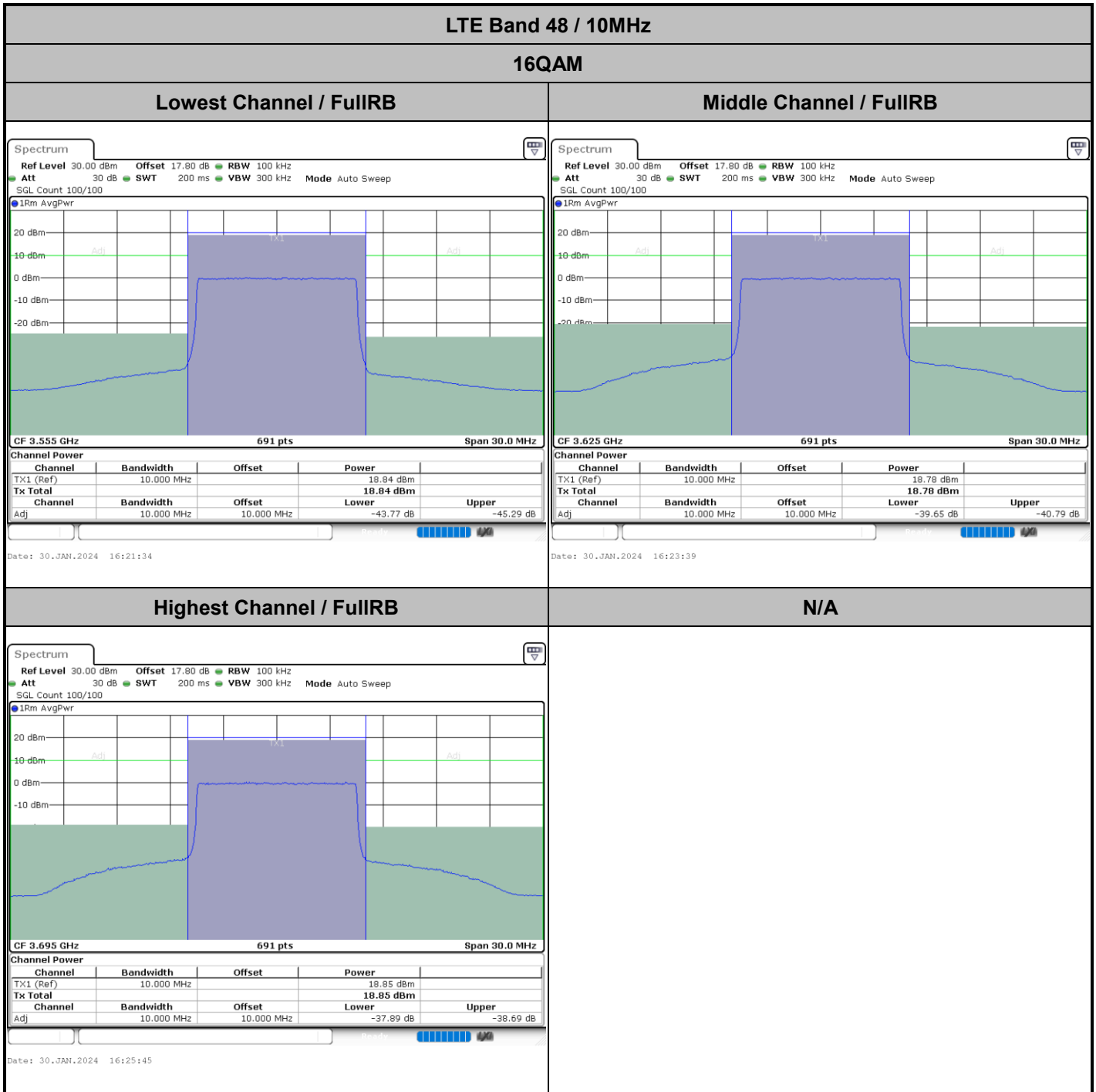



LTE Band 48 / 15MHz

16QAM

Lowest Channel / FullIRB

Middle Channel / FullIRB

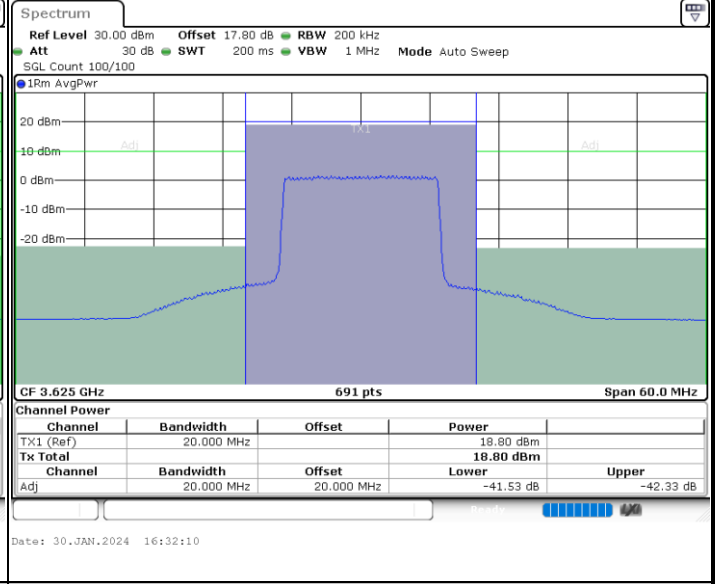
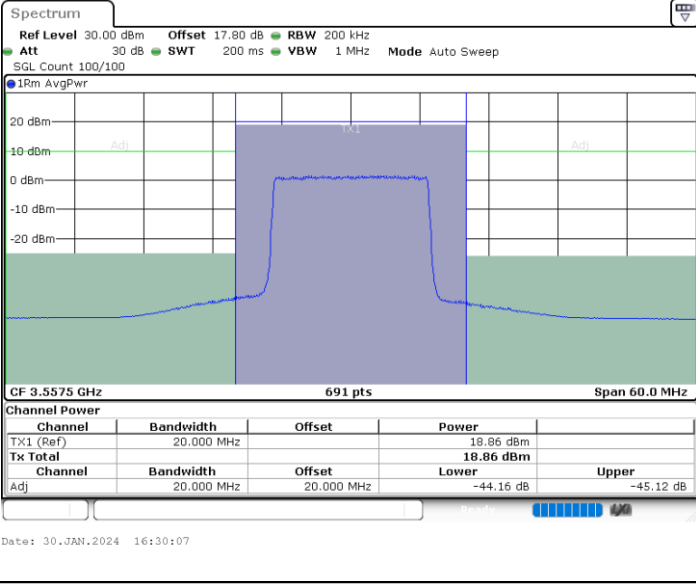

Highest Channel / FullIRB

N/A

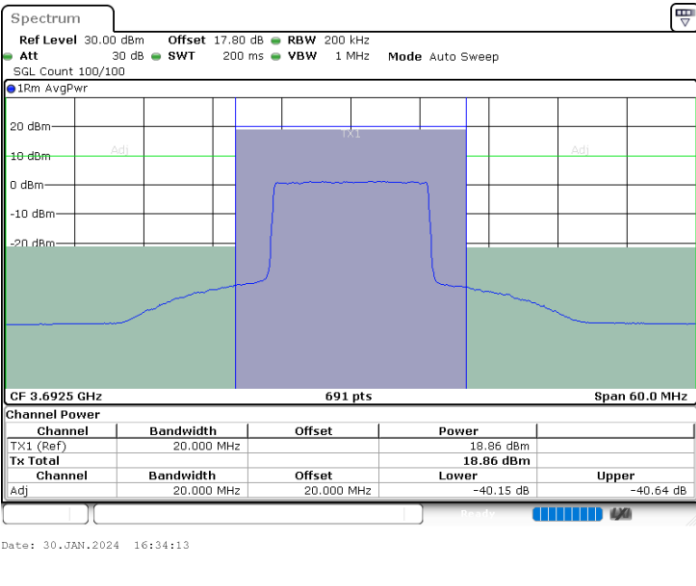

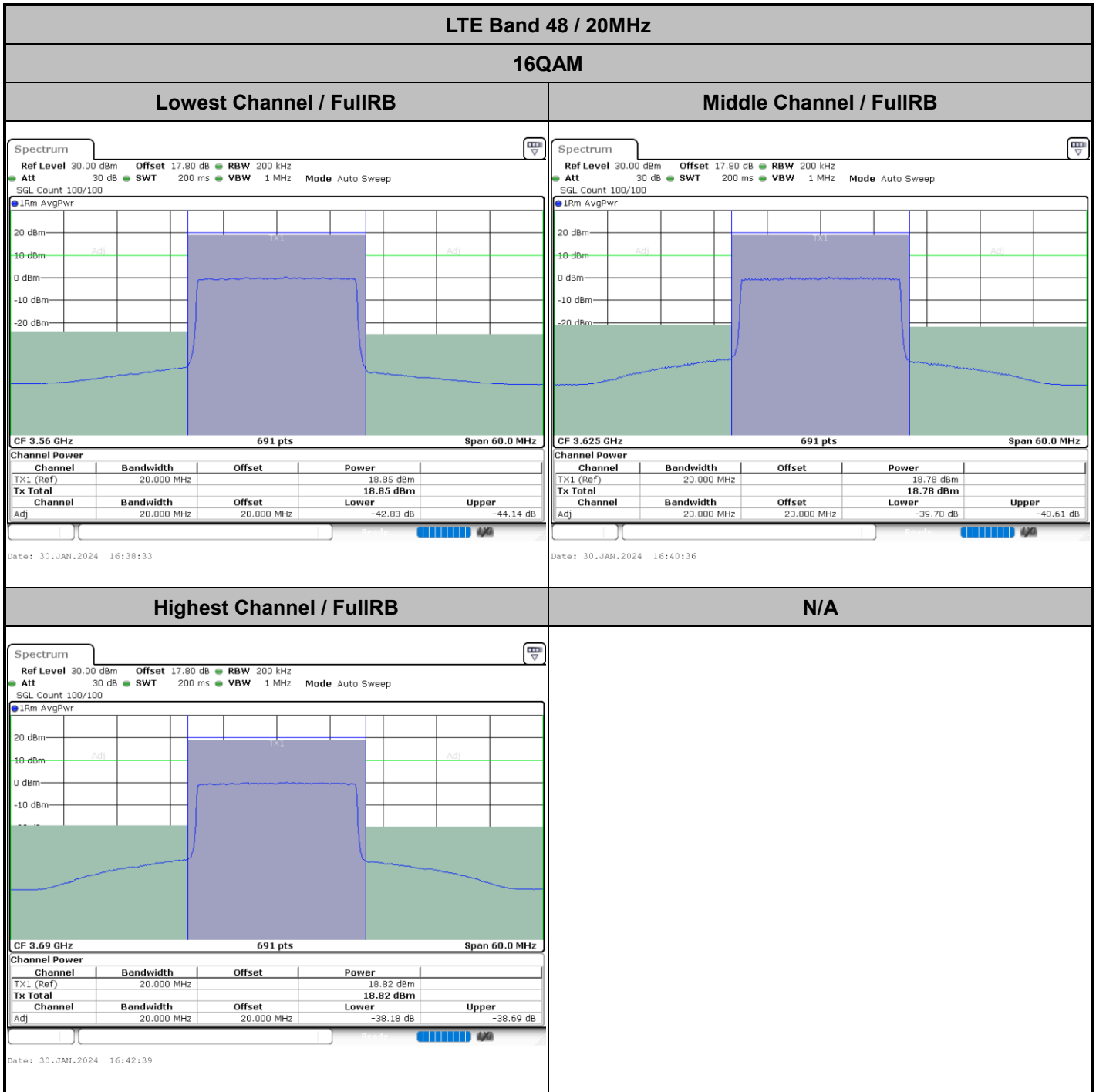



LTE Band 48 / 5MHz

64QAM

Lowest Channel / 1RB0

Lowest Channel / 1RBmax

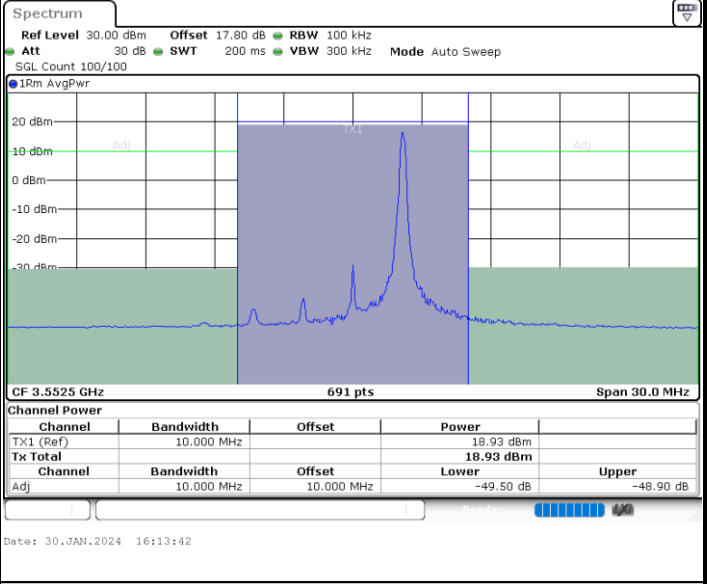
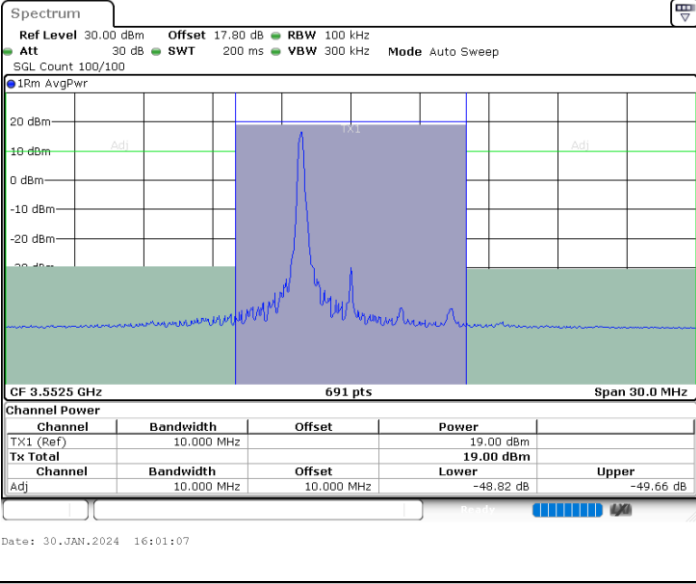

Lowest Channel / FullIRB

N/A

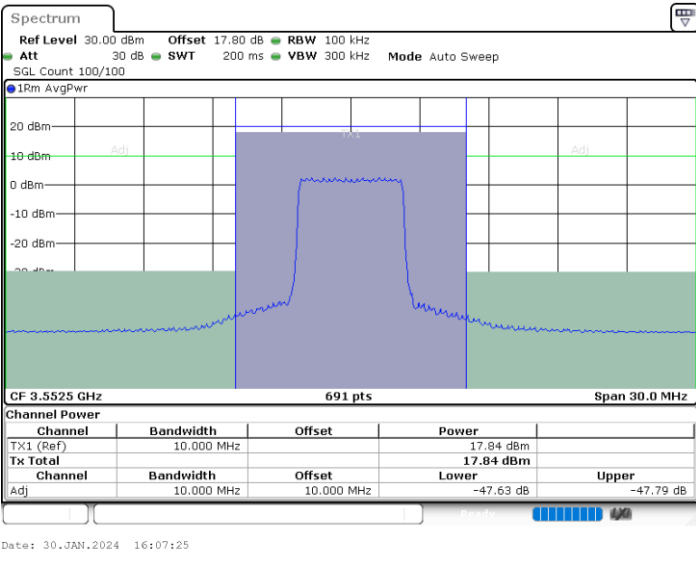

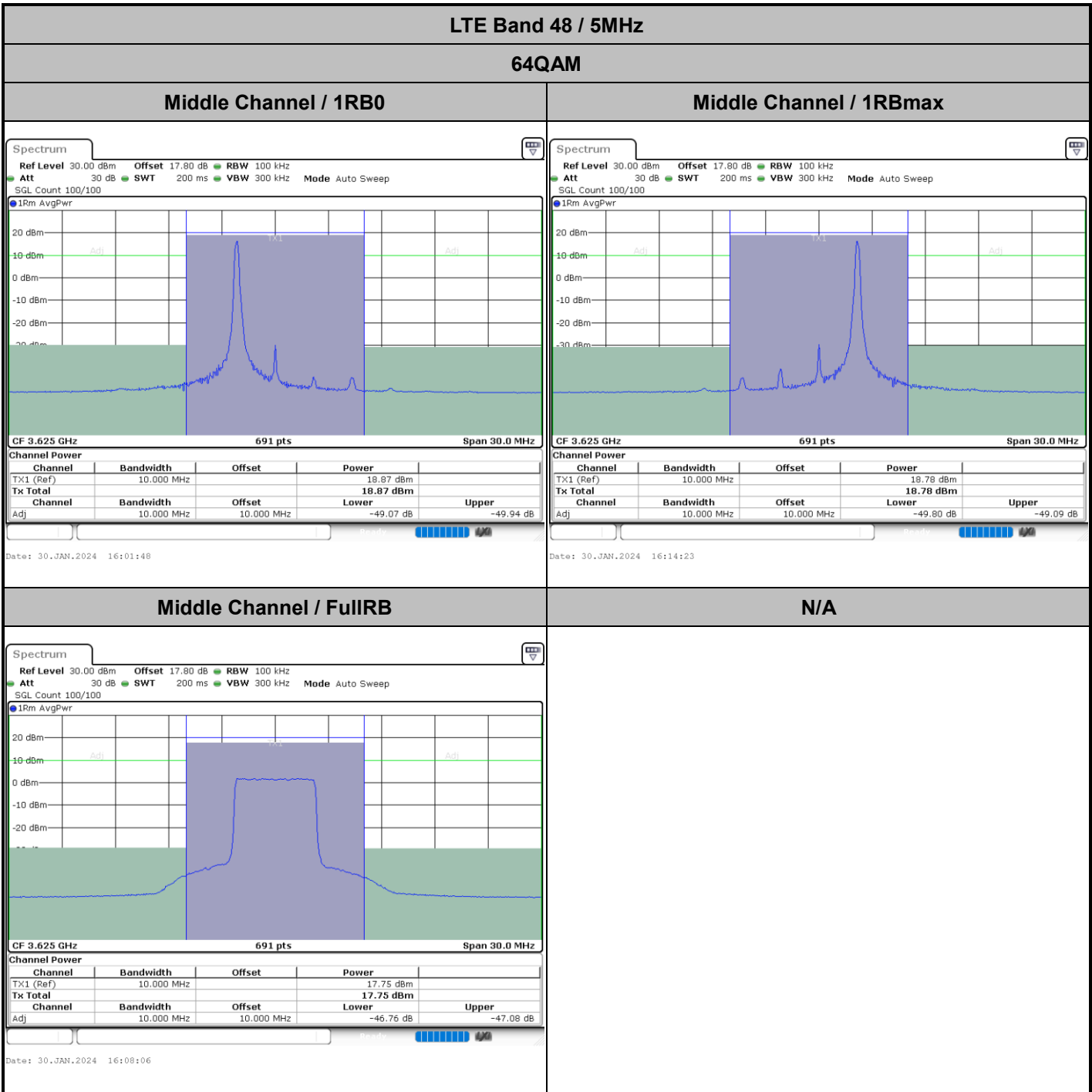

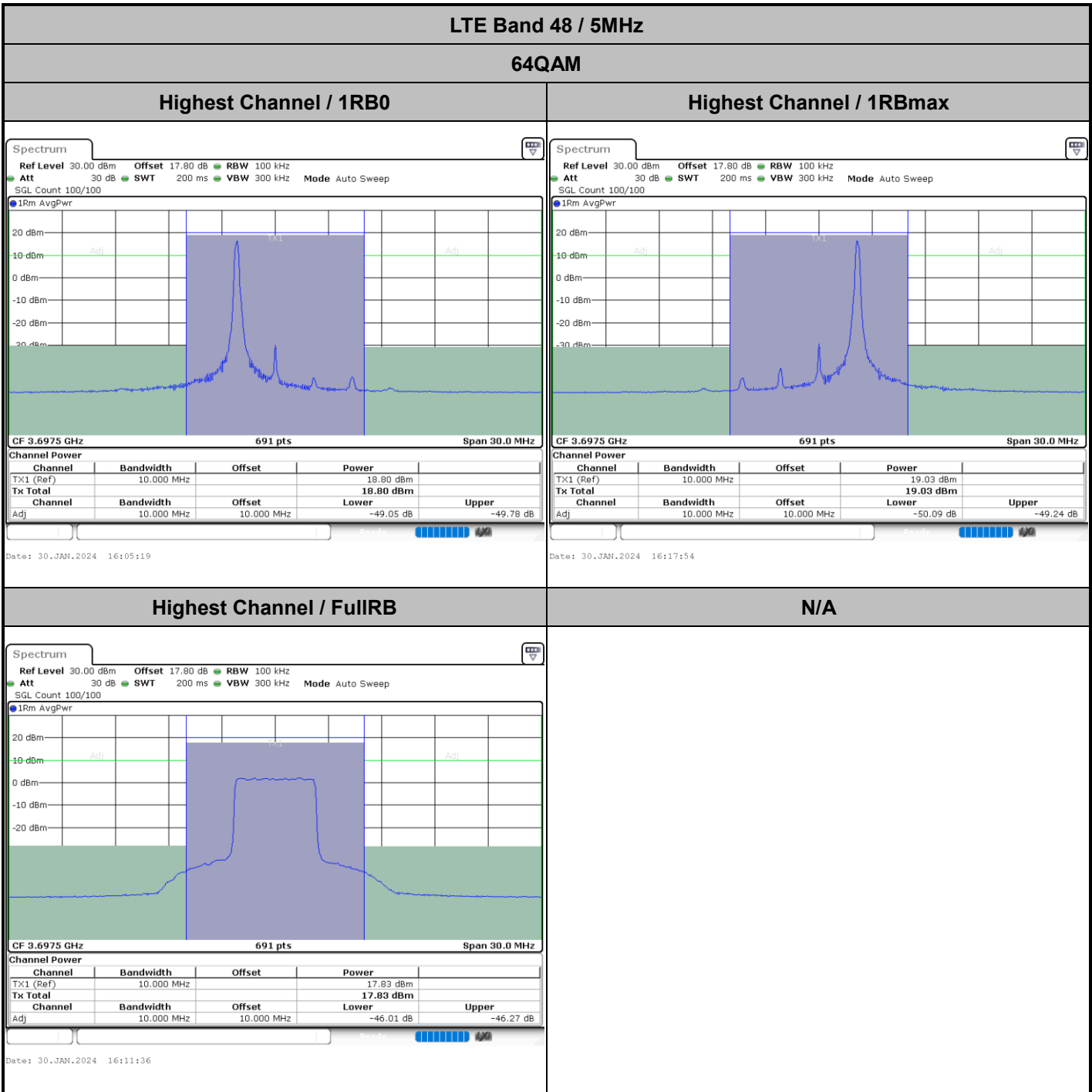



LTE Band 48 / 10MHz

64QAM

Lowest Channel / FullIRB

Middle Channel / FullIRB

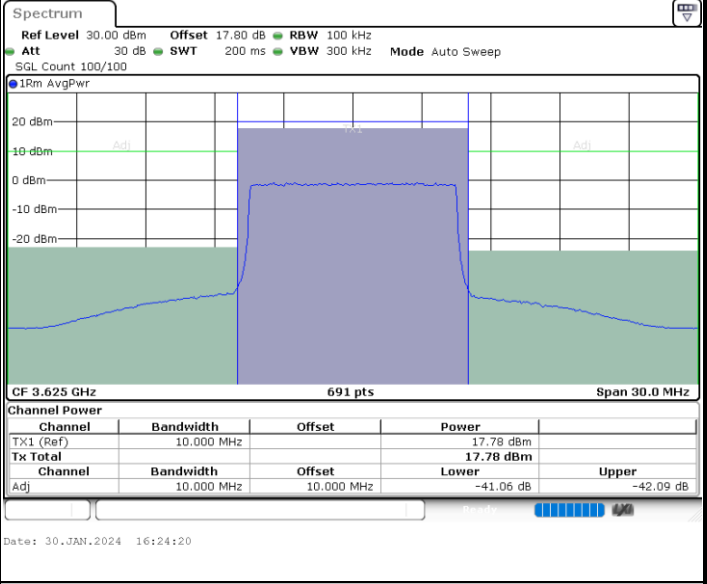

Highest Channel / FullIRB

N/A

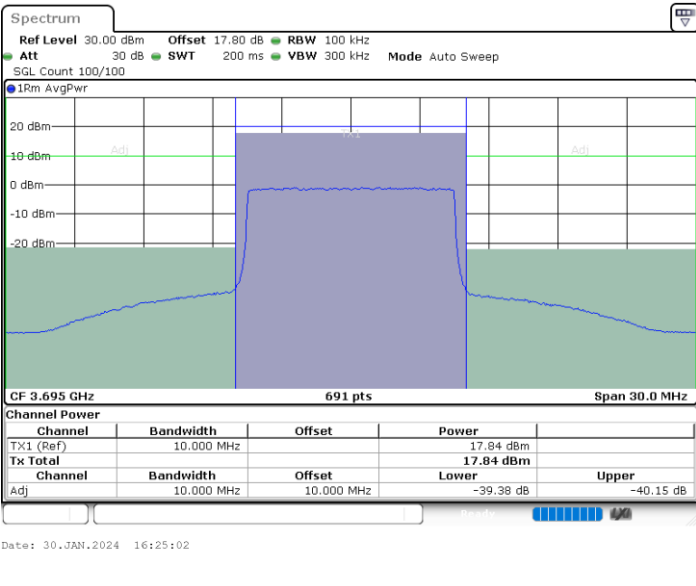

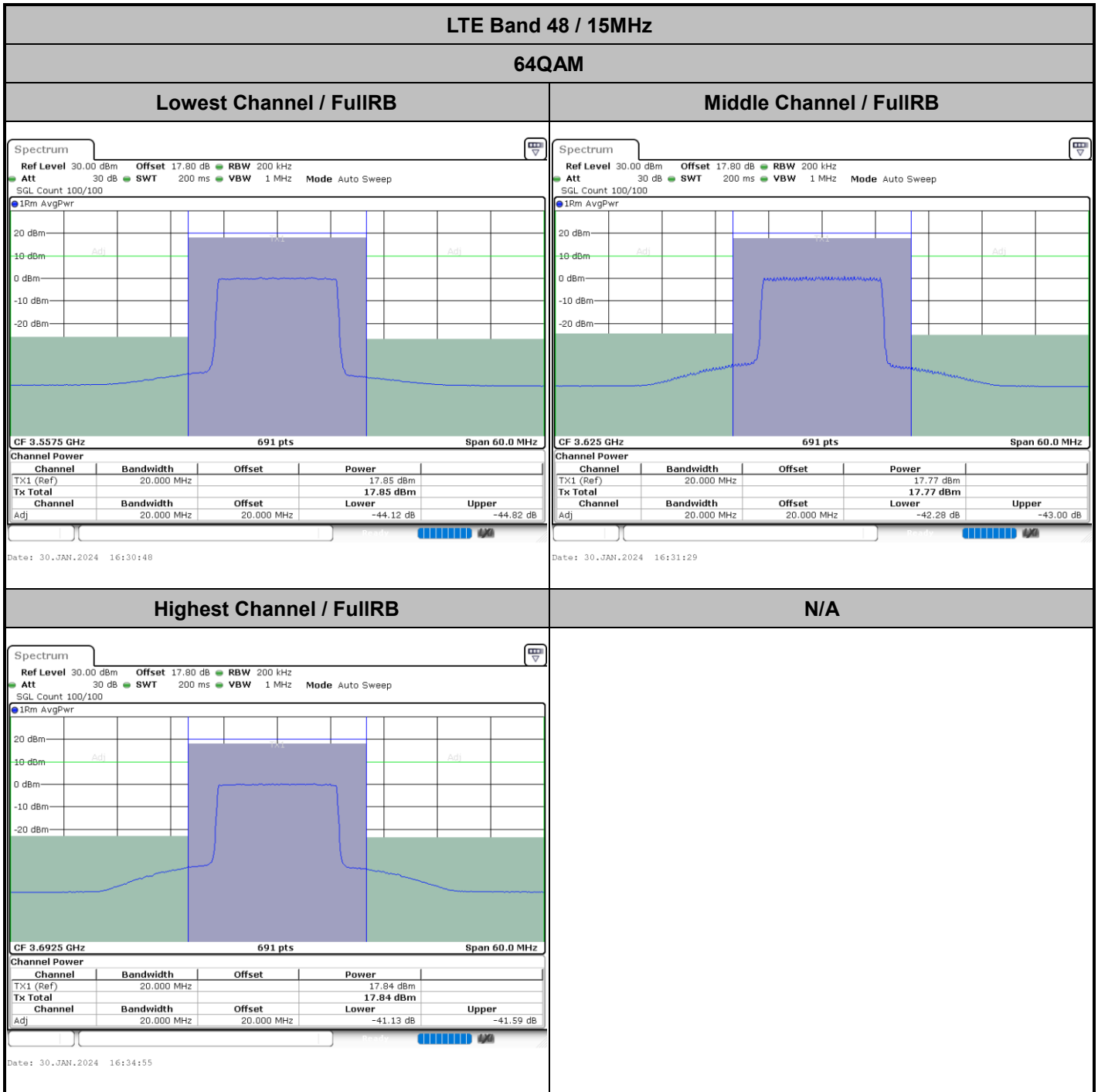

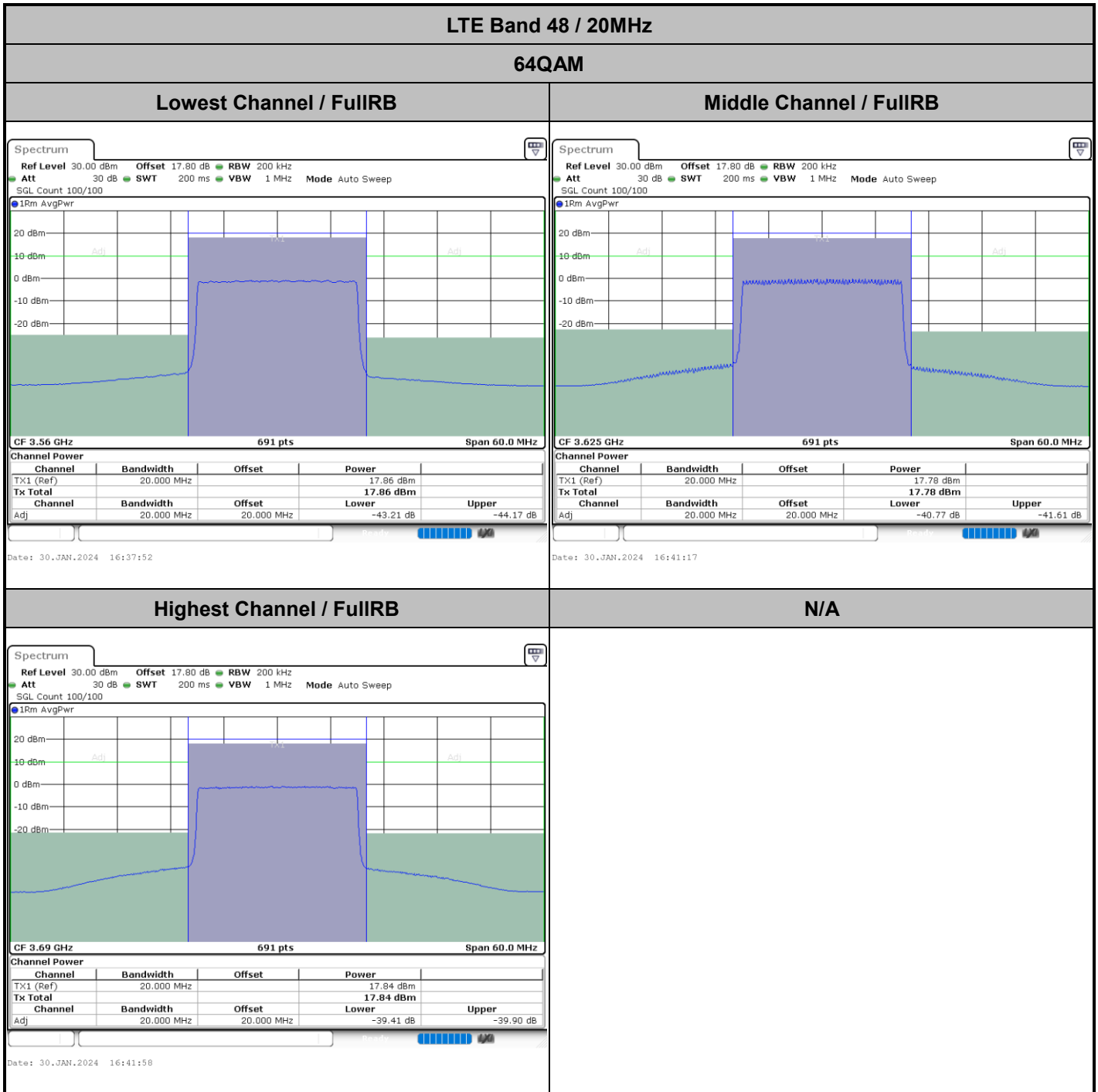



Conducted Band Edge

