



RF TEST REPORT

Applicant Compal Electronics, Inc.
FCC ID GKREXCN1
Product 4G LCC Module
Brand COMPAL
Model EXC-N1
Report No. R2209A0845-R3V2
Issue Date October 20, 2022

TA Technology (Shanghai) Co., Ltd. tested the above equipment in accordance with the requirements in **FCC CFR47 Part 2 (2021)/ FCC CFR47 Part 27C (2021)**. The test results show that the equipment tested is capable of demonstrating compliance with the requirements as documented in this report.

Prepared by: Xu Ying

Approved by: Xu Kai

TA Technology (Shanghai) Co., Ltd.

Building 3, No.145, Jintang Rd, Tangzhen Industry Park, Pudong Shanghai, China

TEL: +86-021-50791141/2/3

FAX: +86-021-50791141/2/3-8000



TABLE OF CONTENT

1	Test Laboratory	5
1.1	Notes of the Test Report	5
1.2.	Test facility	5
1.3	Testing Location	5
2	General Description of Equipment under Test	6
2.1	Applicant and Manufacturer Information	6
2.2	General information	6
3	Applied Standards	8
4	Test Configuration	9
5	Test Case	12
5.1	RF Power Output and Effective Isotropic Radiated Power	12
5.2	Occupied Bandwidth	14
5.3	Band Edge	15
5.4	Peak-to-Average Power Ratio (PAPR)	18
5.5	Frequency Stability	19
5.6	Spurious Emissions at Antenna Terminals	20
5.7	Radiates Spurious Emission	22
6	Test Results	26
6.1	RF Power Output and Effective Isotropic Radiated Power	26
6.2	Occupied Bandwidth	36
6.3	Band Edge	59
6.4	Peak-to-Average Power Ratio (PAPR)	93
6.5	Frequency Stability	97
6.6	Spurious Emissions at Antenna Terminals	101
6.7	Radiates Spurious Emission	121
7	Main Test Instruments	128
	ANNEX A: The EUT Appearance and Change declaration letter	129
	ANNEX B: Test Setup Photos	130



Version	Revision description	Issue Date
Rev.0	Initial issue of report.	September 28, 2022
Rev.1	Update information.	October 19, 2022
Rev.2	Update description.	October 20, 2022

Note: This revised report (Report No. R2209A0845-R3V2) supersedes and replaces the previously issued report (Report No. R2209A0845-R3V1). Please discard or destroy the previously issued report and dispose of it accordingly.



Summary of Measurement Results

Number	Test Case	Clause in FCC rules	Verdict
1	RF Power Output and Effective Isotropic Radiated Power	2.1046 27.50(d)(4) /27.50(b)(10) /27.50(c)(10)	PASS
2	Occupied Bandwidth	2.1049	PASS
3	Band Edge	27.53(h) /27.53(g) /27.53(f) /27.53(c) /27.53(m)	PASS
4	Peak-to-Average Power Ratio	27.50(d)/KDB971168 D01(5.7)	PASS
5	Frequency Stability	2.1055 / 27.54	PASS
6	Spurious Emissions at Antenna Terminals	2.1051 /27.53(h) /27.53(g) /27.53(f) /27.53(c) /27.53(m)	PASS
7	Radiates Spurious Emission	2.1053 /27.53(h) /27.53(g) /27.53(m) /27.53(f) /27.53(c)	PASS
Date of Testing: September 3, 2019 ~ September 24, 2019			
Date of Sample Received: (R2208A0783): August 25, 2022			
<p>Note: 1. PASS: The EUT complies with the essential requirements in the standard. FAIL: The EUT does not comply with the essential requirements in the standard.</p> <p>All indications of Pass/Fail in this report are opinions expressed by TA Technology (Shanghai) Co., Ltd. based on interpretations and/or observations of test results. Measurement Uncertainties were not taken into account and are published for informational purposes only.</p> <p>2. All test values duplicated from the report (Report No.: R2208A0783-R3).</p>			



1 Test Laboratory

1.1 Notes of the Test Report

This report shall not be reproduced in full or partial, without the written approval of **TA technology (shanghai) co., Ltd.** The results documented in this report apply only to the tested sample, under the conditions and modes of operation as described herein .Measurement Uncertainties were not taken into account and are published for informational purposes only. This report is written to support regulatory compliance of the applicable standards stated above.

1.2. Test facility

FCC (Designation number: CN1179, Test Firm Registration Number: 446626)

TA Technology (Shanghai) Co., Ltd. has been listed on the US Federal Communications Commission list of test facilities recognized to perform measurements.

A2LA (Certificate Number: 3857.01)

TA Technology (Shanghai) Co., Ltd. has been listed by American Association for Laboratory Accreditation to perform measurement.

1.3 Testing Location

Company: TA Technology (Shanghai) Co., Ltd.
Address: Building 3, No.145, Jintang Rd, Tangzhen Industry Park, Pudong Shanghai, China
City: Shanghai
Post code: 201201
Country: P. R. China
Contact: Xu Kai
Telephone: +86-021-50791141/2/3
Fax: +86-021-50791141/2/3-8000
Website: <http://www.ta-shanghai.com>
E-mail: xukai@ta-shanghai.com

2 General Description of Equipment under Test

2.1 Applicant and Manufacturer Information

Applicant	Compal Electronics, Inc.
Applicant address	No.581 & 581-1, Ruiguang Rd., Neihu District, Taipei, (114) Taiwan
Manufacturer	Compal Electronics, Inc.
Manufacturer address	No.581 & 581-1, Ruiguang Rd., Neihu District, Taipei, (114) Taiwan

2.2 General information

EUT Description		
Model	EXC-N1	
IMEI	863879041726491	
Hardware Version	EXC-N1_MB_V1.01	
Software Version	EXC-N1_4.71.5_EQ101	
Power Supply	External Power Supply	
Antenna Type	The EUT don't have standard Antenna. The Antenna used for testing in this report is the after-market accessory.	
Antenna Gain	WCDMA IV :2.5dBi LTE Band 4:2.5dBi LTE Band 12:1.8dBi LTE Band 13:1.8dBi LTE Band 17:1.8dBi LTE Band 41:3.9dBi	
Test Mode(s)	WCDMA Band IV; LTE Band 4/12/13/17/41	
Test Modulation	(WCDMA) BPSK, QPSK, (LTE)QPSK 16QAM;	
HSDPA UE Category	12	
HSUPA UE Category	8	
LTE Category	4	
Maximum E.I.R.P./ E.R.P.	WCDMA Band IV:	25.47dBm
	LTE Band 4:	25.20dBm
	LTE Band 12:	23.34dBm
	LTE Band 13:	22.96dBm
	LTE Band 17	23.13dBm
	LTE Band 41:	26.62dBm
Rated Power Supply Voltage:	3.8V	
Operating Voltage	Minimum: 3.3V Maximum: 4.2V	
Operating Temperature	Lowest: -40°C Highest: +85°C	



Testing Temperature	Lowest: -40°C Highest: +90°C		
Operating Frequency Range(s)	Mode	Tx (MHz)	Rx (MHz)
	WCDMA Band IV	1710 ~ 1755	2110 ~ 2155
	LTE Band 4	1710 ~ 1755	2110 ~ 2155
	LTE Band 12	699 ~ 716	729 ~ 746
	LTE Band 13	777 ~ 787	746 ~ 756
	LTE Band 17	704 ~ 716	734 ~ 746
	LTE Band 41	2496 ~ 2690	2496 ~ 2690
Note: The EUT is sent from the applicant to TA and the information of the EUT is declared by the applicant.			



3 Applied Standards

According to the specifications of the manufacturer, it must comply with the requirements of the following standards:

Test standards:

FCC CFR47 Part 27C (2021)

FCC CFR47 Part 2 (2021)

Reference standard:

ANSI C63.26-2015

KDB 971168 D01 Power Meas License Digital Systems v03r01

4 Test Configuration

Radiated measurements are performed by rotating the EUT in three different orthogonal test planes. EUT stand-up position (Z axis), lie-down position (X, Y axis). Receiver antenna polarization (horizontal and vertical), the worst emission was found in position (X axis, vertical polarization) and the worst case was recorded.

All mode and data rates and positions and RB size and modulations were investigated.

Subsequently, only the worst case emissions are reported.

The following testing in WCDMA/LTE is set based on the maximum RF Output Power.

The following testing in different Bandwidth is set to detail in the following table:

Test modes are chosen to be reported as the worst case configuration below for WCDMA Band IV:

Test items	Modes/Modulation
	WCDMA Band IV
RF power output	RMC HSDPA/HSUPA DC-HSDPA
Effective Isotropic Radiated power	RMC
Occupied Bandwidth	RMC
Band Edge	RMC
Peak-to-Average Power Ratio	RMC
Frequency Stability	RMC
Spurious Emissions at Antenna Terminals	RMC
Radiates Spurious Emission	RMC



Test modes are chosen to be reported as the worst case configuration below for LTE Band 4/12/13/17/41:

Test items	Modes	Bandwidth (MHz)						Modulation		RB			Test Channel		
		1.4	3	5	10	15	20	QPSK	16QAM	1	50%	100%	L	M	H
RF power output	LTE 4	0	0	0	0	0	0	0	0	0	0	0	0	0	0
	LTE 12	0	0	0	0	-	-	0	0	0	0	0	0	0	0
	LTE 13	-	-	0	0	-	-	0	0	0	0	0	0	0	0
	LTE 17	-	-	0	0	-	-	0	0	0	0	0	0	0	0
	LTE 41	-	-	0	0	0	0	0	0	0	0	0	0	0	0
Effective Isotropic Radiated power	LTE 4	0	0	0	0	0	0	0	0	0	0	0	0	0	0
	LTE 12	0	0	0	0	-	-	0	0	0	0	0	0	0	0
	LTE 13	-	-	0	0	-	-	0	0	0	0	0	0	0	0
	LTE 17	-	-	0	0	-	-	0	0	0	0	0	0	0	0
	LTE 41	-	-	0	0	0	0	0	0	0	0	0	0	0	0
Occupied Bandwidth	LTE 4	0	0	0	0	0	0	0	0	-	-	0	0	0	0
	LTE 12	0	0	0	0	-	-	0	0	-	-	0	0	0	0
	LTE 13	-	-	0	0	-	-	0	0	-	-	0	0	0	0
	LTE 17	-	-	0	0	-	-	0	0	-	-	0	0	0	0
	LTE 41	-	-	0	0	0	0	0	0	-	-	0	0	0	0
Band Edge	LTE 4	0	0	0	0	0	0	0	0	0	-	0	0	-	0
	LTE 12	0	0	0	0	-	-	0	0	0	-	0	0	-	0
	LTE 13	-	-	0	0	-	-	0	0	0	-	0	0	-	0
	LTE 17	-	-	0	0	-	-	0	0	0	-	0	0	-	0
	LTE 41	-	-	0	0	0	0	0	0	0	-	0	0	-	0
Peak-to-Average Power Ratio	LTE 4	0	0	0	0	0	0	0	0	-	-	0	0	0	0
	LTE 12	0	0	0	0	-	-	0	0	-	-	0	0	0	0
	LTE 13	-	-	0	0	-	-	0	0	-	-	0	0	0	0
	LTE 17	-	-	0	0	-	-	0	0	-	-	0	0	0	0
	LTE 41	-	-	0	0	0	0	0	0	-	-	0	0	0	0
Frequency Stability	LTE 4	0	0	0	0	0	0	0	0	0	0	0	0	0	0
	LTE 12	0	0	0	0	-	-	0	0	0	0	0	0	0	0
	LTE 13	-	-	0	0	-	-	0	0	0	0	0	0	0	0
	LTE 17	-	-	0	0	-	-	0	0	0	0	0	0	0	0
	LTE 41	-	-	0	0	0	0	0	0	0	0	0	0	0	0
Spurious Emissions at Antenna Terminals	LTE 4	0	0	0	0	0	0	0	-	0	-	-	0	0	0
	LTE 12	0	0	0	0	-	-	0	-	0	-	-	0	0	0
	LTE 13	-	-	0	0	-	-	0	-	0	-	-	0	0	0
	LTE 17	-	-	0	0	-	-	0	-	0	-	-	0	0	0
	LTE 41	-	-	0	0	0	0	0	-	0	-	-	0	0	0



	LTE 41	-	-	O	O	O	O	O	-	O	-	-	O	O	O
Radiates Spurious Emission	LTE 4	O	-	O	-	-	O	O	-	O	-	-	O	O	O
	LTE 12	O	-	O	O	-	-	O	-	O	-	-	-	O	-
	LTE 13	-	-	O	O	-	-	O	-	O	-	-	-	O	-
	LTE 17	-	-	O	O	-	-	O	-	O	-	-	-	O	-
	LTE 41	-	-	O	O	-	O	O	-	O	-	-	-	O	-
Note	<p>1. The mark "O" means that this configuration is chosen for testing.</p> <p>2. The mark "-" means that this configuration is not testing.</p>														

5 Test Case

5.1 RF Power Output and Effective Isotropic Radiated Power

Ambient condition

Temperature	Relative humidity	Pressure
23°C ~25°C	45%~50%	101.5kPa

Methods of Measurement

During the process of the testing, The EUT was connected to the Base Station Simulator with a known loss. The EUT is controlled by the Base Station Simulator test set to ensure max power transmission with proper modulation.

ERP can then be calculated as follows:

$$\text{EIRP (dBm)} = \text{Output Power (dBm)} - \text{Losses (dB)} + \text{Antenna Gain (dBi)}$$

where:dBd refers to gain relative to an ideal dipole.

$$\text{EIRP (dBm)} = \text{ERP (dBm)} + 2.15 \text{ (dB.)}$$

Test Setup

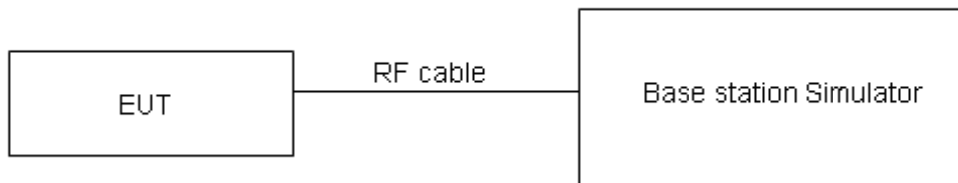

Limits

No specific RF power output requirements in part 2.1046.

Rule Part 27.50(b) (10) specifies that “Portable stations (hand-held devices) transmitting in the 746-757 MHz, 776-788 MHz, and 805-806 MHz bands are limited to 3 watts ERP”

Rule Part 27.50(d) (4) specifies that “Fixed, mobile and portable (hand-held) stations operating in the 1710–1755 MHz band are limited to 1 watt EIRP”

Rule Part 27.50(h) (2) specifies that “Mobile and other user stations. Mobile stations are limited to 2.0 watts EIRP. All user stations are limited to 2.0 watts transmitter output power.”



Part 27.50(b)(10)	$\leq 3 \text{ W}$ (34.77 dBm)
Part 27.50(c)(10)	$\leq 3 \text{ W}$ (34.77 dBm)
Part 27.50(d)(4)	$\leq 1 \text{ W}$ (30 dBm)
Part 27.50(h)(2)	$\leq 2 \text{ W}$ (33 dBm)

Measurement Uncertainty

The assessed measurement uncertainty to ensure 95% confidence level for the normal distribution is with the coverage factor $k = 2$, $U=0.4$ dB for RF power output, $k = 2$, $U= 1.19$ dB for ERP/EIRP.

Test Results

Refer to the section 6.1 of this report for test data.

5.2 Occupied Bandwidth

Ambient condition

Temperature	Relative humidity	Pressure
23°C ~25°C	45%~50%	101.5kPa

Method of Measurement

The EUT was connected to Spectrum Analyzer and Base Station Simulator via power Splitter. The occupied bandwidth is measured using spectrum analyzer.

RBW is set to $\geq 1\%EBW$, VBW is set to 3x RBW.

99% power and -26dBc occupied bandwidths are recorded. Spectrum analyzer plots are included on the following pages.

Test Setup

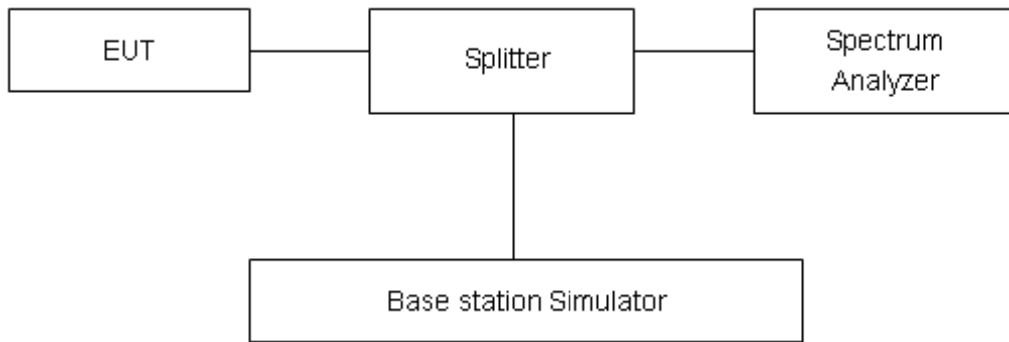

Limits

No specific occupied bandwidth requirements in part 2.1049.

Measurement Uncertainty

The assessed measurement uncertainty to ensure 95% confidence level for the normal distribution is with the coverage factor $k = 2$, $U=624\text{Hz}$.

Test Results

Refer to the section 6.2 of this report for test data.

5.3 Band Edge

Ambient condition

Temperature	Relative humidity	Pressure
23°C ~25°C	45%~50%	101.5kPa

Method of Measurement

The EUT was connected to Spectrum Analyzer and Base Station Simulator via power Splitter. The band edge of the lowest and highest channels were measured.

The testing follows KDB 971168 D01 v03r01 Section 6.0

The EUT was connected to spectrum analyzer and system simulator via a power divider.

The band edges of low and high channels for the highest RF powers were measured.

For LTE Band 41 the middle channel, high channel set RBW \geq 1% EBW in the 1MHz band immediately outside and adjacent to the band edge. Beyond the 1 MHz band from the band edge, RBW=1MHz was used; Low channel set RBW \geq 2% EBW in the 1MHz band immediately outside and adjacent to the band edge. Beyond the 1 MHz band from the band edge, RBW=1MHz was used. RBW is set to \geq 1%EBW, VBW is set to 3x RBW on spectrum analyzer.

Set spectrum analyzer with RMS detector.

The RF fundamental frequency should be excluded against the limit line in the operating frequency band.

Checked that all the results comply with the emission limit line.

Test Setup

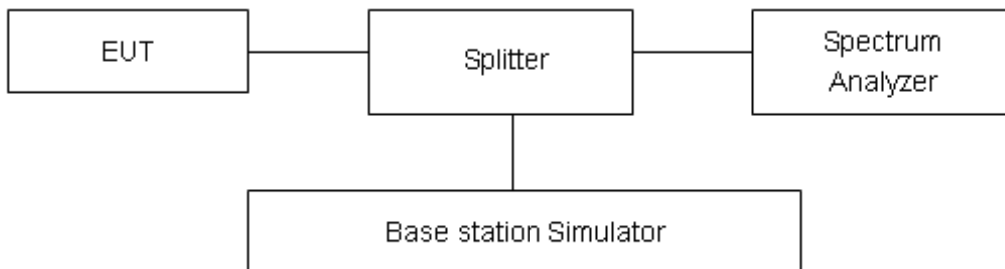

Limits

Rule Part 27.53(i) By a factor of not less than $43 + 10 \log (P)$ dB on all frequencies between 2305 and 2320 MHz.

Rule Part 27.53(h) specifies that “ for operations in the 1695-1710 MHz, 1710-1755 MHz, 1755-1780 MHz, 1915-1920 MHz, 1995-2000 MHz, 2000-2020 MHz, 2110-2155 MHz, 2155-2180 MHz, and 2180-2200 bands, the power of any emission outside a licensee's frequency block shall be attenuated below the transmitter power (P) in watts by at least $43 + 10 \log_{10} (P)$ dB”

Rule Part 27.53(g) For operations in the 600 MHz band and the 698-746 MHz band, the power of any emission outside a licensee's frequency band(s) of operation shall be attenuated below the



transmitter power (P) within the licensed band(s) of operation, measured in watts, by at least $43 + 10 \log (P)$ dB. Compliance with this provision is based on the use of measurement instrumentation employing a resolution bandwidth of 100 kilohertz or greater. However, in the 100 kilohertz bands immediately outside and adjacent to a licensee's frequency block, a resolution bandwidth of at least 30 kHz may be employed.

Rule Part 27.53(m) (4) specifies that "for BRS and EBS stations. For mobile digital stations, the attenuation factor shall be not less than $40 + 10 \log (P)$ dB on all frequencies between the channel edge and 5 megahertz from the channel edge, $43 + 10 \log (P)$ dB on all frequencies between 5 megahertz and X megahertz from the channel edge, and $55 + 10 \log (P)$ dB on all frequencies more than X megahertz from the channel edge, where X is the greater of 6 megahertz or the actual emission bandwidth as defined in paragraph (m)(4) of this section. In addition, the attenuation factor shall not be less that $43 + 10 \log (P)$ dB on all frequencies between 2490.5 MHz and 2496 MHz and $55 + 10 \log (P)$ dB at or below 2490.5 MHz. Mobile Satellite Service licensees operating on frequencies below 2495 MHz may also submit a documented interference complaint against BRS licensees operating on channel BRS Channel 1 on the same terms and conditions as adjacent channel BRS or EBS licensees.

Example:

The limit line is derived from $43 + 10 \log (P)$ dB below the transmitter power P(Watts)

= $P(W) - [43 + 10 \log (P)]$ (dB)

= $[30 + 10 \log (P)]$ (dBm) - $[43 + 10 \log (P)]$ (dB) = -13dBm.

Rule Part 27.53(f) For operations in the 746-758 MHz, 775-788 MHz, and 805-806 MHz bands, emissions in the band 1559-1610 MHz shall be limited to -70 dBW/MHz equivalent isotropically radiated power (EIRP) for wideband signals, and -80 dBW EIRP for discrete emissions of less than 700 Hz bandwidth. For the purpose of equipment authorization, a transmitter shall be tested with an antenna that is representative of the type that will be used with the equipment in normal operation.

Rule Part 27.53 (c) For operations in the 746-758 MHz band and the 776-788 MHz band, the power of any emission outside the licensee's frequency band(s) of operation shall be attenuated below the transmitter power (P) within the licensed band(s) of operation, measured in watts, in accordance with the following:

- (1) On any frequency outside the 746-758 MHz band, the power of any emission shall be attenuated outside the band below the transmitter power (P) by at least $43 + 10 \log (P)$ dB;
- (2) On any frequency outside the 776-788 MHz band, the power of any emission shall be attenuated outside the band below the transmitter power (P) by at least $43 + 10 \log (P)$ dB;
- (3) On all frequencies between 763-775 MHz and 793-805 MHz, by a factor not less than $76 + 10 \log (P)$ dB in a 6.25 kHz band segment, for base and fixed stations;
- (4) On all frequencies between 763-775 MHz and 793-805 MHz, by a factor not less than $65 + 10 \log (P)$ dB in a 6.25 kHz band segment, for mobile and portable stations;
- (5) Compliance with the provisions of paragraphs (c)(1) and (c)(2) of this section is based on the use of measurement instrumentation employing a resolution bandwidth of 100 kHz or greater. However, in the 100 kHz bands immediately outside and adjacent to the frequency block, a resolution bandwidth of at least 30 kHz may be employed;



Measurement Uncertainty

The assessed measurement uncertainty to ensure 95% confidence level for the normal distribution is with the coverage factor $k = 1.96$, $U=0.684\text{dB}$.

Test Results

Refer to the section 6.3 of this report for test data.

5.4 Peak-to-Average Power Ratio (PAPR)

Ambient condition

Temperature	Relative humidity	Pressure
23°C ~25°C	45%~50%	101.5kPa

Methods of Measurement

Measure the total peak power and record as PPk. And measure the total average power and record as PAvg. Both the peak and average power levels must be expressed in the same logarithmic units (e.g., dBm). Determine the PAPR from:

$$PAPR (dB) = PPk (dBm) - PAvg (dBm).$$

Test Setup

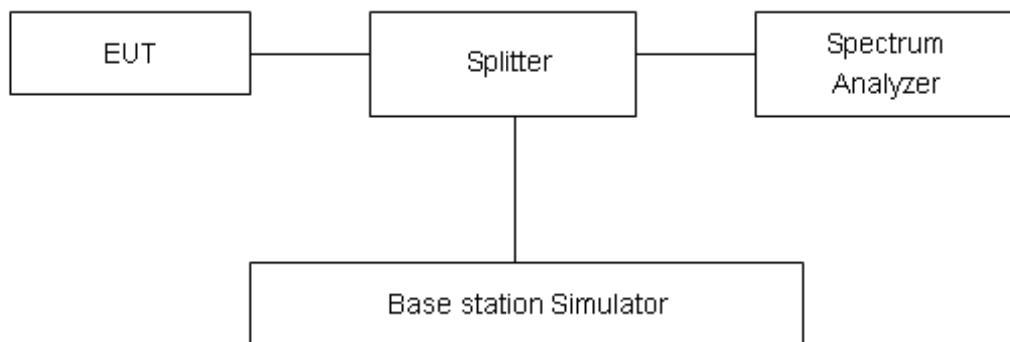

Limits

Rule Part 27.50(d)(5) Equipment employed must be authorized in accordance with the provisions of 24.51. Power measurements for transmissions by stations authorized under this section may be made either in accordance with a Commission-approved average power technique or in compliance with paragraph (d)(6) of this section. In measuring transmissions in this band using an average power technique, the peak-to-average ratio (PAR) of the transmission may not exceed 13 dB.

Measurement Uncertainty

The assessed measurement uncertainty to ensure 95% confidence level for the normal distribution is with the coverage factor $k = 2$, $U = 0.4$ dB.

Test Results

Refer to the section 6.4 of this report for test data.

5.5 Frequency Stability

Ambient condition

Temperature	Relative humidity	Pressure
23°C ~25°C	45%~50%	101.5kPa

Method of Measurement

Frequency Stability (Temperature Variation)

The temperature inside the climate chamber is varied from -40°C to +85°C in 10°C step size.

(1)With all power removed, the temperature was decreased to -10°C and permitted to stabilize for three hours.

(2)Measure the carrier frequency with the test equipment in a “call mode”. These measurements should be made within 1 minute of powering up the mobile station, to prevent significant self warming.

(3) Repeat the above measurements at 10°C increments from -40°C to +85°C. Allow at least 1.5 hours at each temperature, un-powered, before making measurements.

Frequency Stability (Voltage Variation)

The frequency stability shall be measured with variation of primary supply voltage as follows:

Primary Supply Voltage: The primary supply voltage is varied from 85% to 115% of the nominal value for non hand-carried battery and AC powered equipment. For hand-carried, battery-powered equipment, primary supply voltage is reduced to the battery operating end point which shall be specified by the manufacturer.

This transceiver is specified to operate with an input voltage of between 3.3 V and 4.2 V, with a nominal voltage of 3.8V.

Test setup

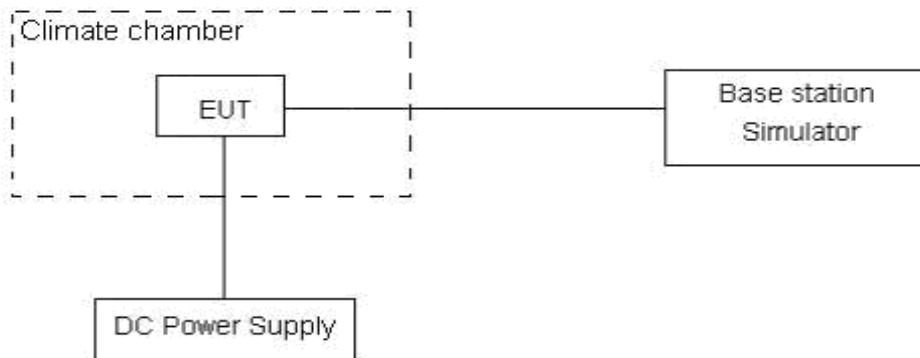

Limits

The frequency stability shall be sufficient to ensure that the fundamental emissions stay within the authorized bands of operation.

Measurement Uncertainty

The assessed measurement uncertainty to ensure 99.75% confidence level for the normal distribution is with the coverage factor $k = 3, U=0.01\text{ppm}$.

Test Results

Refer to the section 6.5 of this report for test data.

5.6 Spurious Emissions at Antenna Terminals

Ambient condition

Temperature	Relative humidity	Pressure
23°C ~25°C	45%~50%	101.5kPa

Method of Measurement

The EUT was connected to Spectrum Analyzer and Base Station Simulator via power Splitter. The measurement is carried out using a spectrum analyzer. The spectrum analyzer scans from 9kHz to the 10th harmonic of the carrier. The peak detector is used.

RBW is set to 100kHz, VBW is set to 300kHz for 30MHz~1GHz

RBW is set to 1MHz, VBW is set to 3MHz for above 1GHz, Sweep is set to ATUO.

Of those disturbances below (limit – 20 dB), the mark is not required for the EUT.

The modulation mode and RB allocation refer to section 5.1, using the maximum output power configuration.

Test setup

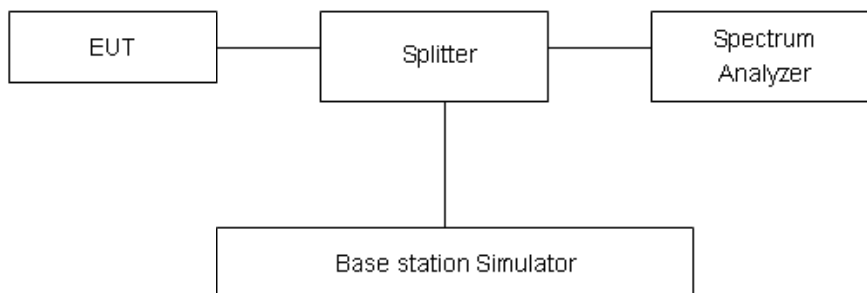

Limits

Rule Part 27.53(h) specifies that “for operations in the 1695-1710 MHz, 1710-1755 MHz, 1755-1780 MHz, 1915-1920 MHz, 1995-2000 MHz, 2000-2020 MHz, 2110-2155 MHz, 2155-2180 MHz, and 2180-2200 bands, the power of any emission outside a licensee's frequency block shall be attenuated below the transmitter power (P) in watts by at least $43 + 10 \log_{10}(P)$ dB..”

Rule Part 27.53 (g) For operations in the 600 MHz band and the 698-746 MHz band, the power of any emission outside a licensee's frequency band(s) of operation shall be attenuated below the transmitter power (P) within the licensed band(s) of operation, measured in watts, by at least $43 + 10 \log(P)$ dB. Compliance with this provision is based on the use of measurement instrumentation employing a resolution bandwidth of 100 kilohertz or greater. However, in the 100 kilohertz bands immediately outside and adjacent to a licensee's frequency block, a resolution bandwidth of at least 30 kHz may be employed.

Rule Part 27.53(f) For operations in the 746-758 MHz, 775-788 MHz, and 805-806 MHz bands, emissions in the band 1559-1610 MHz shall be limited to -70 dBW/MHz equivalent isotropically



radiated power (EIRP) for wideband signals, and -80 dBW EIRP for discrete emissions of less than 700 Hz bandwidth. For the purpose of equipment authorization, a transmitter shall be tested with an antenna that is representative of the type that will be used with the equipment in normal operation.

Rule Part 27.53(m) $55 + 10 \log (P)$ dB on all frequencies more than X megahertz from the channel edge, where X is the greater of 6 megahertz or the actual emission bandwidth as defined in paragraph (m)(4) of this section.

Part 27.53 (c) For operations in the 746-758 MHz band and the 776-788 MHz band, the power of any emission outside the licensee's frequency band(s) of operation shall be attenuated below the transmitter power (P) within the licensed band(s) of operation, measured in watts, in accordance with the following:

- (1) On any frequency outside the 746-758 MHz band, the power of any emission shall be attenuated outside the band below the transmitter power (P) by at least $43 + 10 \log (P)$ dB;
- (2) On any frequency outside the 776-788 MHz band, the power of any emission shall be attenuated outside the band below the transmitter power (P) by at least $43 + 10 \log (P)$ dB;
- (3) On all frequencies between 763-775 MHz and 793-805 MHz, by a factor not less than $76 + 10 \log (P)$ dB in a 6.25 kHz band segment, for base and fixed stations;
- (4) On all frequencies between 763-775 MHz and 793-805 MHz, by a factor not less than $65 + 10 \log (P)$ dB in a 6.25 kHz band segment, for mobile and portable stations;
- (5) Compliance with the provisions of paragraphs (c)(1) and (c)(2) of this section is based on the use of measurement instrumentation employing a resolution bandwidth of 100 kHz or greater. However, in the 100 kHz bands immediately outside and adjacent to the frequency block, a resolution bandwidth of at least 30 kHz may be employed;

Part 27.53(a)/(h)/(g) Limit		-13 dBm
Part 27.53(f) Limit	Limit out of the band 1559-1610 MHz	-13 dBm
	Limit in the band 1559-1610 MHz	-40 dBm
Part 27.53(m) Limit		-25 dBm

Measurement Uncertainty

The assessed measurement uncertainty to ensure 99.75% confidence level for the normal distribution is with the coverage factor $k = 1.96$.

Frequency	Uncertainty
9kHz-1GHz	0.684 dB
1GHz-27GHz	1.407 dB

Test Results

Refer to the section 6.6 of this report for test data.



5.7 Radiates Spurious Emission

Ambient condition

Temperature	Relative humidity	Pressure
23°C ~25°C	45%~50%	101.5kPa

Method of Measurement

- The testing follows FCC KDB 971168 D01 v03r01 Section 5.8 and ANSI C63.26-2015.
- Below 1GHz: The EUT is placed on a turntable 0.8 meters above the ground in the chamber, 3 meter away from the antenna. The maximal emission value is acquired by adjusting the antenna height, polarisation and turntable azimuth. Normally, the height range of antenna is 1 m to 4 m, the azimuth range of turntable is 0° to 360°, and the receive antenna has two polarizations Vertical (V) and Horizontal (H). Above 1GHz: (Note: the FCC's permission to use 1.5m as an alternative per TCBC Conf call of Dec. 2, 2014.) The EUT is placed on a turntable 1.5 meters above the ground in the chamber, 3 meter away from the antenna. The maximal emission value is acquired by adjusting the antenna height, polarisation and turntable azimuth. Normally, the height range of antenna is 1 m to 4 m, the azimuth range of turntable is 0° to 360°, and the receive antenna has two polarizations Vertical (V) and Horizontal (H).
- A loop antenna, A log-periodic antenna or horn antenna shall be substituted in place of the EUT. The log-periodic antenna will be driven by a signal generator and the level will be adjusted till the same power value on the spectrum analyzer or receiver. The level of the spurious emissions can be calculated through the level of the signal generator, cable loss, the gain of the substitution antenna and the reading of the spectrum analyzer or receiver.
- The EUT is then put into continuously transmitting mode at its maximum power level during the test. Set Test Receiver or Spectrum RBW=100kHz, VBW=300kHz for 30MHz to 1GHz and RBW=1MHz, VBW=3MHz for above 1GHz, and the maximum value of the receiver should be recorded as (Pr).
- The EUT shall be replaced by a substitution antenna. In the chamber, an substitution antenna for the frequency band of interest is placed at the reference point of the chamber. An RF Signal source for the frequency band of interest is connected to the substitution antenna with a cable that has been constructed to not interfere with the radiation pattern of the antenna. A power (PMea) is applied to the input of the substitution antenna, and adjust the level of the signal generator output until the value of the receiver reach the previously recorded (Pr). The power of signal source (PMea) is recorded. The test should be performed by rotating the test item and adjusting the receiving antenna polarization.
- A amplifier should be connected to the Signal Source output port. And the cable should be connect between the Amplifier and the Substitution Antenna. The cable loss (Pcl) ,the Substitution Antenna Gain (Ga) and the Amplifier Gain (PAg) should be recorded after test.
- The measurement results are obtained as described below:

$$\text{Power(EIRP)} = \text{PMea} - \text{PAg} - \text{Pcl} + \text{Ga}$$
 The measurement results are amend as described below:

$$\text{Power(EIRP)} = \text{PMea} - \text{Pcl} + \text{Ga}$$
- This value is EIRP since the measurement is calibrated using an antenna of known gain (2.15 dB) and known input power. ERP can be calculated from EIRP by subtracting the gain of the dipole, $\text{ERP} = \text{EIRP} - 2.15\text{dB}$.

The modulation mode and RB allocation refer to section 5.1, using the maximum output power configuration.

Test setup

9KHz~ 30MHz

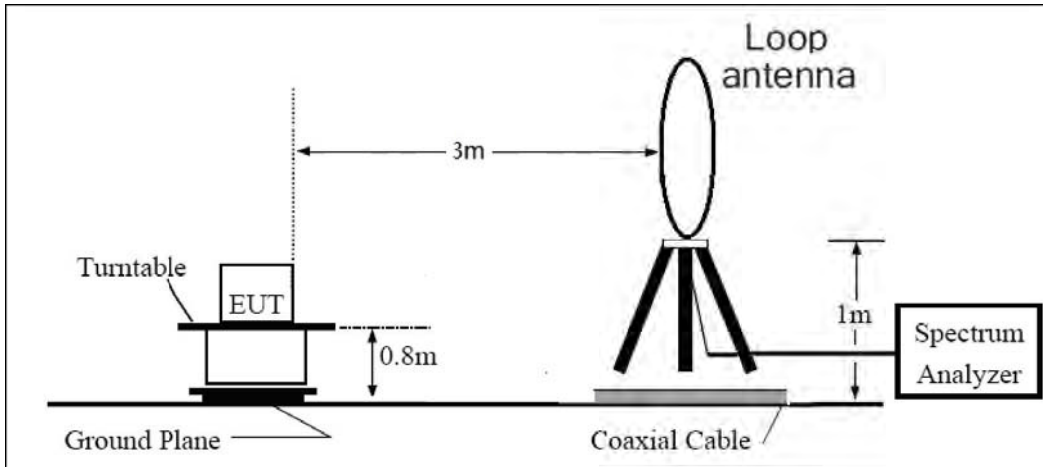

30MHz~ 1GHz

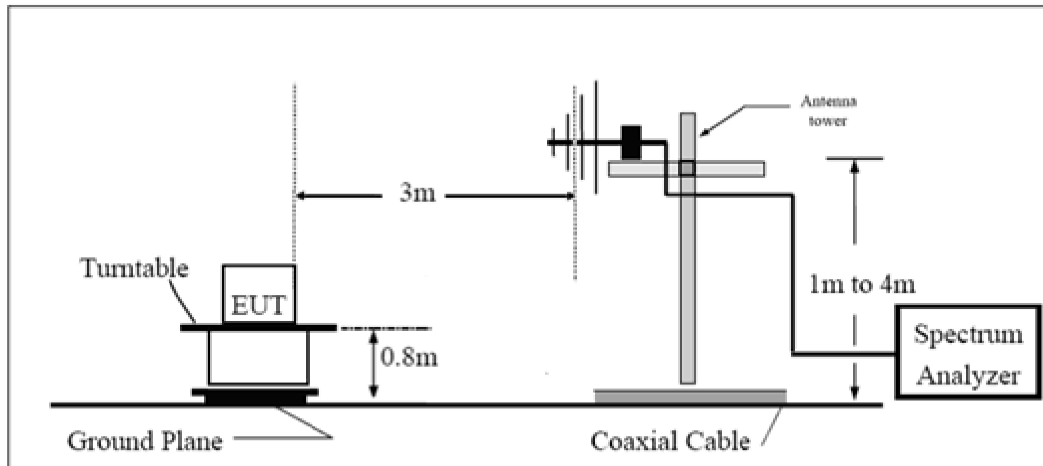

Above 1GHz

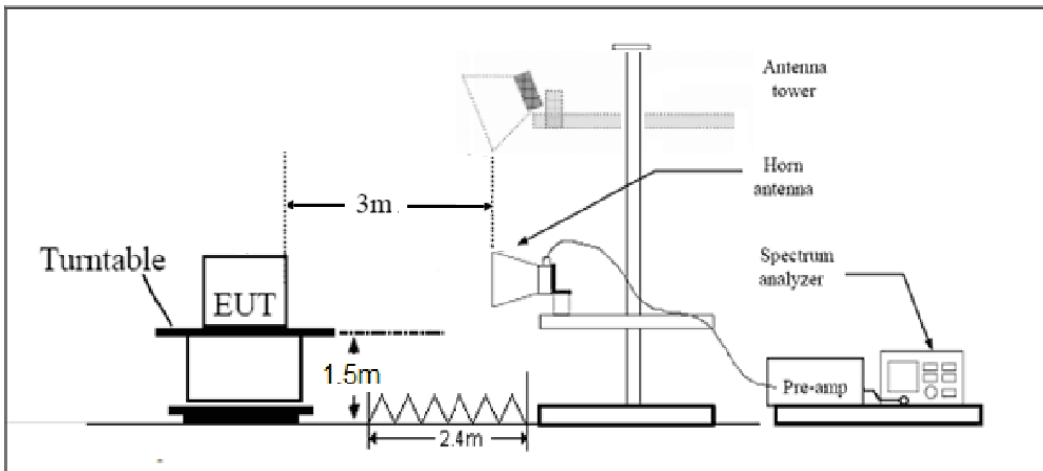

Note: Area side:2.4mX3.6m



Limits

Rule Part 27.53(h) specifies that “for operations in the 1695-1710 MHz, 1710-1755 MHz, 1755-1780 MHz, 1915-1920 MHz, 1995-2000 MHz, 2000-2020 MHz, 2110-2155 MHz, 2155-2180 MHz, and 2180-2200 bands, the power of any emission outside a licensee's frequency block shall be attenuated below the transmitter power (P) in watts by at least $43 + 10 \log_{10} (P)$ dB.”

Rule Part 27.53 (g) For operations in the 600 MHz band and the 698-746 MHz band, the power of any emission outside a licensee's frequency band(s) of operation shall be attenuated below the transmitter power (P) within the licensed band(s) of operation, measured in watts, by at least $43 + 10 \log (P)$ dB. Compliance with this provision is based on the use of measurement instrumentation employing a resolution bandwidth of 100 kilohertz or greater. However, in the 100 kilohertz bands immediately outside and adjacent to a licensee's frequency block, a resolution bandwidth of at least 30 kHz may be employed.

Rule Part 27.53(f) For operations in the 746-758 MHz, 775-788 MHz, and 805-806 MHz bands, emissions in the band 1559-1610 MHz shall be limited to -70 dBW/MHz equivalent isotropically radiated power (EIRP) for wideband signals, and -80 dBW EIRP for discrete emissions of less than 700 Hz bandwidth. For the purpose of equipment authorization, a transmitter shall be tested with an antenna that is representative of the type that will be used with the equipment in normal operation.

Rule Part 27.53(m) $55 + 10 \log (P)$ dB on all frequencies more than X megahertz from the channel edge, where X is the greater of 6 megahertz or the actual emission bandwidth as defined in paragraph (m)(4) of this section.

Part 27.53 (c) For operations in the 746-758 MHz band and the 776-788 MHz band, the power of any emission outside the licensee's frequency band(s) of operation shall be attenuated below the transmitter power (P) within the licensed band(s) of operation, measured in watts, in accordance with the following:

- (1) On any frequency outside the 746-758 MHz band, the power of any emission shall be attenuated outside the band below the transmitter power (P) by at least $43 + 10 \log (P)$ dB;
- (2) On any frequency outside the 776-788 MHz band, the power of any emission shall be attenuated outside the band below the transmitter power (P) by at least $43 + 10 \log (P)$ dB;
- (3) On all frequencies between 763-775 MHz and 793-805 MHz, by a factor not less than $76 + 10 \log (P)$ dB in a 6.25 kHz band segment, for base and fixed stations;
- (4) On all frequencies between 763-775 MHz and 793-805 MHz, by a factor not less than $65 + 10 \log (P)$ dB in a 6.25 kHz band segment, for mobile and portable stations;
- (5) Compliance with the provisions of paragraphs (c)(1) and (c)(2) of this section is based on the use of measurement instrumentation employing a resolution bandwidth of 100 kHz or greater. However, in the 100 kHz bands immediately outside and adjacent to the frequency block, a resolution bandwidth of at least 30 kHz may be employed;



Part 27.53(a)/(h)/(g) Limit		-13 dBm
Part 27.53(f) Limit	Limit out of the band 1559-1610 MHz	-13 dBm
	Limit in the band 1559-1610 MHz	-40 dBm
Part 27.53(m) Limit		-25 dBm

Measurement Uncertainty

The assessed measurement uncertainty to ensure 95% confidence level for the normal distribution is with the coverage factor $k = \pm 1.96$, $U = \pm 3.55$ dB.

Test Results

Refer to the section 6.7 of this report for test data.

6 Test Results

6.1 RF Power Output and Effective Isotropic Radiated Power

WCDMA Band IV		Maximum Output Power (dBm)			EIRP (dBm)		
		Channel 1312	Channel 1413	Channel 1513	Channel 1312	Channel 1413	Channel 1513
		1712.4 (MHz)	1732.6 (MHz)	1752.6 (MHz)	1712.4 (MHz)	1732.6 (MHz)	1752.6 (MHz)
RMC		22.97	22.94	22.87	25.47	25.44	25.37
HSDPA	Sub - Test 1	22.43	22.36	22.31	24.93	24.86	24.81
	Sub - Test 2	22.42	22.38	22.28	24.92	24.88	24.78
	Sub - Test 3	21.89	21.88	21.80	24.39	24.38	24.30
	Sub - Test 4	21.90	21.89	21.78	24.40	24.39	24.28
HSUPA	Sub - Test 1	22.39	22.35	22.26	24.89	24.85	24.76
	Sub - Test 2	21.38	21.33	21.25	23.88	23.83	23.75
	Sub - Test 3	21.85	21.81	21.74	24.35	24.31	24.24
	Sub - Test 4	21.31	21.30	21.22	23.81	23.80	23.72
	Sub - Test 5	22.32	22.28	22.20	24.82	24.78	24.70
DC-HSDPA	Sub - Test 1	22.31	22.30	22.21	24.81	24.80	24.71
	Sub - Test 2	22.30	22.29	22.20	24.80	24.79	24.70
	Sub - Test 3	21.88	21.78	21.71	24.38	24.28	24.21
	Sub - Test 4	21.87	21.77	21.70	24.37	24.27	24.20



LTE Band 4				Maximum Output Power(dBm)			EIRP (dBm)		
BW	Modulation	RB size	RB offset	Channel/Frequency(MHz)					
				19957/ 1710.7	20175/ 1732.5	20393/ 1754.3	19957/ 1710.7	20175/ 1732.5	20393/ 1754.3
1.4MHz	QPSK	1	0	22.13	22.38	22.63	24.63	24.88	25.13
		1	2	22.34	22.20	22.65	24.84	24.70	25.15
		1	5	22.29	22.25	22.55	24.79	24.75	25.05
		3	0	21.01	21.15	21.41	23.51	23.65	23.91
		3	2	21.06	21.19	21.35	23.56	23.69	23.85
		3	3	21.18	21.22	21.29	23.68	23.72	23.79
		6	0	21.14	21.25	21.36	23.64	23.75	23.86
	16QAM	1	0	21.10	21.96	21.94	23.60	24.46	24.44
		1	2	21.09	22.12	21.90	23.59	24.62	24.40
		1	5	20.99	22.00	21.63	23.49	24.50	24.13
		3	0	20.12	20.05	20.26	22.62	22.55	22.76
		3	2	20.11	20.04	20.23	22.61	22.54	22.73
		3	3	20.17	20.04	20.09	22.67	22.54	22.59
		6	0	20.31	20.36	20.21	22.81	22.86	22.71
BW	Modulation	RB size	RB offset	Channel/Frequency(MHz)					
				19965/ 1711.5	20175/ 1732.5	20385/ 1753.5	19965/ 1711.5	20175/ 1732.5	20385/ 1753.5
3MHz	QPSK	1	0	22.15	22.42	22.66	24.65	24.92	25.16
		1	7	22.37	22.25	22.69	24.87	24.75	25.19
		1	14	22.32	22.30	22.59	24.82	24.80	25.09
		8	0	21.09	21.25	21.52	23.59	23.75	24.02
		8	4	21.16	21.27	21.45	23.66	23.77	23.95
		8	7	21.26	21.31	21.37	23.76	23.81	23.87
		15	0	21.17	21.29	21.39	23.67	23.79	23.89
	16QAM	1	0	21.13	21.98	21.97	23.63	24.48	24.47
		1	7	21.12	22.17	21.94	23.62	24.67	24.44
		1	14	21.01	22.04	21.66	23.51	24.54	24.16
		8	0	20.21	20.16	20.36	22.71	22.66	22.86
		8	4	20.20	20.15	20.33	22.70	22.65	22.83
		8	7	20.25	20.14	20.20	22.75	22.64	22.70
		15	0	20.34	20.40	20.24	22.84	22.90	22.74



BW	Modulation	RB size	RB offset	Channel/Frequency(MHz)					
				19975/1712.5	20175/1732.5	20375/1752.5	19975/1712.5	20175/1732.5	20375/1752.5
5MHz	QPSK	1	0	22.12	22.40	22.62	24.62	24.90	25.12
		1	13	22.35	22.21	22.66	24.85	24.71	25.16
		1	24	22.29	22.25	22.55	24.79	24.75	25.05
		12	0	21.06	21.20	21.48	23.56	23.70	23.98
		12	6	21.14	21.23	21.40	23.64	23.73	23.90
		12	13	21.24	21.29	21.33	23.74	23.79	23.83
		25	0	21.15	21.28	21.37	23.65	23.78	23.87
	16QAM	1	0	21.10	21.94	21.94	23.60	24.44	24.44
		1	13	21.09	22.15	21.91	23.59	24.65	24.41
		1	24	20.98	22.02	21.62	23.48	24.52	24.12
		12	0	20.19	20.12	20.33	22.69	22.62	22.83
		12	6	20.17	20.10	20.29	22.67	22.60	22.79
		12	13	20.22	20.09	20.16	22.72	22.59	22.66
		25	0	20.32	20.36	20.19	22.82	22.86	22.69
BW	Modulation	RB size	RB offset	Channel/Frequency(MHz)					
				20000/1715	20175/1732.5	20350/1750	20000/1715	20175/1732.5	20350/1750
10MHz	QPSK	1	0	22.14	22.41	22.65	24.64	24.91	25.15
		1	25	22.38	22.26	22.70	24.88	24.76	25.20
		1	49	22.31	22.29	22.58	24.81	24.79	25.08
		25	0	21.09	21.25	21.52	23.59	23.75	24.02
		25	13	21.17	21.28	21.44	23.67	23.78	23.94
		25	25	21.26	21.33	21.38	23.76	23.83	23.88
		50	0	21.23	21.30	21.41	23.73	23.80	23.91
	16QAM	1	0	21.12	21.97	21.96	23.62	24.47	24.46
		1	25	21.12	22.19	21.94	23.62	24.69	24.44
		1	49	21.01	22.04	21.65	23.51	24.54	24.15
		25	0	20.22	20.17	20.37	22.72	22.67	22.87
		25	13	20.19	20.14	20.32	22.69	22.64	22.82
		25	25	20.25	20.14	20.20	22.75	22.64	22.70
		50	0	20.35	20.41	20.23	22.85	22.91	22.73
BW	Modulation	RB size	RB offset	Channel/Frequency(MHz)					
				20025/1717.5	20175/1732.5	20325/1747.5	20025/1717.5	20175/1732.5	20325/1747.5
15MHz	QPSK	1	0	22.13	22.37	22.63	24.63	24.87	25.13



		1	38	22.36	22.25	22.67	24.86	24.75	25.17
		1	74	22.28	22.24	22.54	24.78	24.74	25.04
		36	0	21.07	21.21	21.49	23.57	23.71	23.99
		36	18	21.14	21.23	21.40	23.64	23.73	23.90
		36	39	21.23	21.30	21.34	23.73	23.80	23.84
		75	0	21.21	21.26	21.36	23.71	23.76	23.86
		1	0	21.07	21.95	21.94	23.57	24.45	24.44
	16QAM	1	38	21.10	22.16	21.92	23.60	24.66	24.42
		1	74	20.98	22.00	21.62	23.48	24.50	24.12
		36	0	20.19	20.15	20.34	22.69	22.65	22.84
		36	18	20.16	20.09	20.28	22.66	22.59	22.78
		36	39	20.23	20.10	20.17	22.73	22.60	22.67
		75	0	20.32	20.36	20.19	22.82	22.86	22.69
BW	Modulation	RB size	RB offset	Channel/Frequency(MHz)					
				20050/1720	20175/1732.5	20300/1745	20050/1720	20175/1732.5	20300/1745
20MHz	QPSK	1	0	22.10	22.33	22.60	24.60	24.83	25.10
		1	50	22.35	22.21	22.65	24.85	24.71	25.15
		1	99	22.26	22.23	22.51	24.76	24.73	25.01
		50	0	21.04	21.16	21.45	23.54	23.66	23.95
		50	25	21.12	21.19	21.37	23.62	23.69	23.87
		50	50	21.20	21.25	21.30	23.70	23.75	23.8
		100	0	21.18	21.21	21.32	23.68	23.71	23.82
	16QAM	1	0	21.05	21.91	21.89	23.55	24.41	24.39
		1	50	21.06	22.14	21.88	23.56	24.64	24.38
		1	99	20.96	21.97	21.60	23.46	24.47	24.1
		50	0	20.16	20.11	20.31	22.66	22.61	22.81
		50	25	20.13	20.07	20.25	22.63	22.57	22.75
		50	50	20.20	20.05	20.13	22.70	22.55	22.63
		100	0	20.30	20.32	20.16	22.80	22.82	22.66

LTE Band 12				Maximum Output Power(dBm)			ERP (dBm)		
BW	Modulation	RB size	RB offset	Channel/Frequency(MHz)					
				23017/699.7	23095/707.5	23173/715.3	23017/699.7	23095/707.5	23173/715.3
1.4MHz	QPSK	1	0	23.37	23.27	23.06	23.02	22.92	22.71



		1	2	23.24	23.22	23.65	22.89	22.87	23.30
		1	5	23.35	23.35	23.07	23.00	23.00	22.72
		3	0	22.39	22.19	22.32	22.04	21.84	21.97
		3	2	22.35	22.25	22.28	22.00	21.90	21.93
		3	3	22.24	22.40	22.27	21.89	22.05	21.92
		6	0	22.31	22.37	22.38	21.96	22.02	22.03
	16QAM	1	0	22.53	22.86	21.76	22.18	22.51	21.41
		1	2	22.84	22.21	22.42	22.49	21.86	22.07
		1	5	22.40	22.92	21.84	22.05	22.57	21.49
		3	0	21.47	21.46	21.56	21.12	21.11	21.21
		3	2	21.40	21.44	21.52	21.05	21.09	21.17
		3	3	21.31	21.41	21.49	20.96	21.06	21.14
		6	0	21.41	22.33	21.35	21.06	21.98	21.00
BW	Modulation	RB size	RB offset	Channel/Frequency(MHz)					
				23025/ 700.5	23095/ 707.5	23165/ 714.5	23025/ 700.5	23095/ 707.5	23165/ 714.5
3MHz	QPSK	1	0	23.39	23.28	23.09	23.04	22.93	22.74
		1	7	23.27	23.27	23.69	22.92	22.92	23.34
		1	14	23.37	23.39	23.10	23.02	23.04	22.75
		8	0	22.42	22.24	22.36	22.07	21.89	22.01
		8	4	22.38	22.30	22.32	22.03	21.95	21.97
		8	7	22.26	22.44	22.32	21.91	22.09	21.97
		15	0	22.39	22.39	22.42	22.04	22.04	22.07
	16QAM	1	0	22.55	22.89	21.78	22.20	22.54	21.43
		1	7	22.87	22.25	22.45	22.52	21.90	22.10
		1	14	22.43	22.94	21.87	22.08	22.59	21.52
		8	0	21.50	21.51	21.60	21.15	21.16	21.25
		8	4	21.42	21.48	21.55	21.07	21.13	21.20
		8	7	21.34	21.46	21.53	20.99	21.11	21.18
		15	0	21.44	22.38	21.39	21.09	22.03	21.04
BW	Modulation	RB size	RB offset	Channel/Frequency(MHz)					
				23035/ 701.5	23095/ 707.5	23155/ 713.5	23035/ 701.5	23095/ 707.5	23155/ 713.5
5MHz	QPSK	1	0	23.38	23.24	23.07	23.03	22.89	22.72
		1	13	23.25	23.26	23.66	22.90	22.91	23.31
		1	24	23.34	23.34	23.06	22.99	22.99	22.71
		12	0	22.40	22.20	22.33	22.05	21.85	21.98



BW	Modulation	RB size	RB offset	Channel/Frequency(MHz)						
				23060/704	23095/707.5	23130/711	23060/704	23095/707.5	23130/711	
10MHz	16QAM	12	6	22.35	22.25	22.28	22.00	21.90	21.93	
		12	13	22.23	22.41	22.28	21.88	22.06	21.93	
		25	0	22.37	22.35	22.37	22.02	22.00	22.02	
		1	0	22.50	22.87	21.76	22.15	22.52	21.41	
		1	13	22.85	22.22	22.43	22.50	21.87	22.08	
		1	24	22.40	22.90	21.84	22.05	22.55	21.49	
		12	0	21.47	21.49	21.57	21.12	21.14	21.22	
		12	6	21.39	21.43	21.51	21.04	21.08	21.16	
	12	13	21.32	21.42	21.50	20.97	21.07	21.15		
	25	0	21.41	22.33	21.35	21.06	21.98	21.00		
	10MHz	QPSK	1	0	23.35	23.20	23.04	23.00	22.85	22.69
			1	25	23.24	23.22	23.64	22.89	22.87	23.29
			1	49	23.32	23.33	23.03	22.97	22.98	22.68
			25	0	22.37	22.15	22.29	22.02	21.80	21.94
			25	13	22.33	22.21	22.25	21.98	21.86	21.90
			25	25	22.20	22.36	22.24	21.85	22.01	21.89
50			0	22.34	22.30	22.33	21.99	21.95	21.98	
16QAM			1	0	22.48	22.83	21.71	22.13	22.48	21.36
		1	25	22.81	22.20	22.39	22.46	21.85	22.04	
		1	49	22.38	22.87	21.82	22.03	22.52	21.47	
		25	0	21.44	21.45	21.54	21.09	21.10	21.19	
		25	13	21.36	21.41	21.48	21.01	21.06	21.13	
		25	25	21.29	21.37	21.46	20.94	21.02	21.11	
		50	0	21.39	22.29	21.32	21.04	21.94	20.97	

LTE Band 13				Maximum Output Power(dBm)			ERP (dBm)		
BW	Modulation	RB size	RB offset	Channel/Frequency(MHz)					
				23205/779.5	23230/782	23255/784.5	23205/779.5	23230/782	23255/784.5
5MHz	QPSK	1	0	22.95	23.13	23.22	22.60	22.78	22.87
		1	13	23.01	23.11	23.11	22.66	22.76	22.76
		1	24	23.18	23.21	23.31	22.83	22.86	22.96
		12	0	22.15	22.11	22.29	21.80	21.76	21.94



		12	6	22.06	22.17	22.25	21.71	21.82	21.90
		12	13	22.07	22.31	22.29	21.72	21.96	21.94
		25	0	21.89	22.20	22.28	21.54	21.85	21.93
	16QAM	1	0	22.35	21.57	21.81	22.00	21.22	21.46
		1	13	22.28	21.72	22.16	21.93	21.37	21.81
		1	24	22.49	21.61	21.66	22.14	21.26	21.31
		12	0	21.11	21.14	21.19	20.76	20.79	20.84
		12	6	21.03	21.24	21.21	20.68	20.89	20.86
		12	13	20.92	21.31	21.28	20.57	20.96	20.93
25	0	21.18	21.28	21.26	20.83	20.93	20.91		
BW	Modulation	RB size	RB offset	Channel/Frequency(MHz)					
				/	23230/ 782	/	/	23230/ 782	/
10MHz	QPSK	1	0	/	23.17	/	/	22.82	/
		1	25	/	23.31	/	/	22.96	/
		1	49	/	23.11	/	/	22.76	/
		25	0	/	22.08	/	/	21.73	/
		25	13	/	22.05	/	/	21.70	/
		25	25	/	22.04	/	/	21.69	/
		50	0	/	22.23	/	/	21.88	/
	16QAM	1	0	/	21.62	/	/	21.27	/
		1	25	/	21.69	/	/	21.34	/
		1	49	/	21.70	/	/	21.35	/
		25	0	/	21.17	/	/	20.82	/
		25	13	/	21.23	/	/	20.88	/
		25	25	/	21.32	/	/	20.97	/
		50	0	/	21.16	/	/	20.81	/

LTE Band 17				Maximum Output Power(dBm)			ERP (dBm)		
BW	Modulation	RB size	RB offset	Channel/Frequency(MHz)					
				23755/ 706.5	23790/ 710	23825/ 713.5	23755/ 706.5	23790/ 710	23825/ 713.5
5MHz	QPSK	1	0	23.38	23.40	23.29	23.03	23.05	22.94
		1	13	23.46	23.31	23.48	23.11	22.96	23.13
		1	24	23.36	23.21	23.28	23.01	22.86	22.93
		12	0	22.44	22.39	22.36	22.09	22.04	22.01
		12	6	22.38	22.41	22.36	22.03	22.06	22.01



BW	Modulation	RB size	RB offset	Channel/Frequency(MHz)					
				23780/709	23790/710	23800/711	23780/709	23790/710	23800/711
	16QAM	12	13	22.29	22.52	22.50	21.94	22.17	22.15
		25	0	22.45	22.34	22.49	22.10	21.99	22.14
		1	0	22.29	22.65	22.90	21.94	22.30	22.55
		1	13	22.17	23.14	22.95	21.82	22.79	22.60
		1	24	22.04	22.41	23.12	21.69	22.06	22.77
		12	0	21.58	21.52	21.37	21.23	21.17	21.02
		12	6	21.30	21.45	21.40	20.95	21.10	21.05
		12	13	21.58	21.58	21.46	21.23	21.23	21.11
		25	0	21.45	21.59	21.50	21.10	21.24	21.15
		10MHz	QPSK	1	0	23.35	23.36	23.26	23.00
1	25			23.45	23.27	23.46	23.10	22.92	23.11
1	49			23.34	23.20	23.25	22.99	22.85	22.9
25	0			22.41	22.34	22.32	22.06	21.99	21.97
25	13			22.36	22.37	22.33	22.01	22.02	21.98
25	25			22.26	22.47	22.46	21.91	22.12	22.11
50	0			22.42	22.29	22.45	22.07	21.94	22.10
16QAM	1		0	22.27	22.61	22.85	21.92	22.26	22.50
	1		25	22.13	23.12	22.91	21.78	22.77	22.56
	1		49	22.02	22.38	23.10	21.67	22.03	22.75
	25		0	21.55	21.48	21.34	21.20	21.13	20.99
	25		13	21.27	21.43	21.37	20.92	21.08	21.02
	25		25	21.55	21.53	21.42	21.20	21.18	21.07
	50		0	21.43	21.55	21.47	21.08	21.20	21.12

LTE Band 41				Maximum Output Power(dBm)			EIRP (dBm)		
BW	Modulation	RB size	RB offset	Channel/Frequency(MHz)					
				39675/2498.5	40620/2593	41565/2687.5	39675/2498.5	40620/2593	41565/2687.5
5MHz	QPSK	1	0	22.36	22.44	21.73	26.26	26.34	25.63
		1	13	22.69	22.43	22.19	26.59	26.33	26.09
		1	24	22.23	22.28	21.98	26.13	26.18	25.88
		12	0	21.37	21.23	21.16	25.27	25.13	25.06
		12	6	21.35	21.26	21.19	25.25	25.16	25.09



		12	13	21.36	21.35	21.24	25.26	25.25	25.14
		25	0	21.33	21.29	21.34	25.23	25.19	25.24
	16QAM	1	0	21.05	21.65	21.59	24.95	25.55	25.49
		1	13	21.19	21.93	21.98	25.09	25.83	25.88
		1	24	20.74	21.54	21.52	24.64	25.44	25.42
		12	0	20.53	20.12	20.33	24.43	24.02	24.23
		12	6	20.52	20.11	20.30	24.42	24.01	24.20
		12	13	20.46	20.17	20.25	24.36	24.07	24.15
		25	0	20.47	20.29	20.27	24.37	24.19	24.17
BW	Modulation	RB size	RB offset	Channel/Frequency(MHz)					
				39700/ 2501	40620/ 2593	41540/ 2685	39700/ 2501	40620/ 2593	41540/ 2685
10MHz	QPSK	1	0	22.38	22.45	21.76	26.28	26.35	25.66
		1	25	22.72	22.48	22.23	26.62	26.38	26.13
		1	49	22.25	22.32	22.01	26.15	26.22	25.91
		25	0	21.40	21.28	21.20	25.30	25.18	25.10
		25	13	21.38	21.31	21.23	25.28	25.21	25.13
		25	25	21.38	21.39	21.29	25.28	25.29	25.19
		50	0	21.41	21.31	21.38	25.31	25.21	25.28
	16QAM	1	0	21.07	21.68	21.61	24.97	25.58	25.51
		1	25	21.22	21.97	22.01	25.12	25.87	25.91
		1	49	20.77	21.56	21.55	24.67	25.46	25.45
		25	0	20.56	20.17	20.37	24.46	24.07	24.27
		25	13	20.54	20.15	20.33	24.44	24.05	24.23
		25	25	20.49	20.22	20.29	24.39	24.12	24.19
		50	0	20.50	20.34	20.31	24.40	24.24	24.21
BW	Modulation	RB size	RB offset	Channel/Frequency(MHz)					
				39725/ 2503.5	40620/ 2593	41515/ 2682.5	39725/ 2503.5	40620/ 2593	41515/ 2682.5
15MHz	QPSK	1	0	22.37	22.41	21.74	26.27	26.31	25.64
		1	38	22.70	22.47	22.20	26.60	26.37	26.10
		1	74	22.22	22.27	21.97	26.12	26.17	25.87
		36	0	21.38	21.24	21.17	25.28	25.14	25.07
		36	18	21.35	21.26	21.19	25.25	25.16	25.09
		36	39	21.35	21.36	21.25	25.25	25.26	25.15
		75	0	21.39	21.27	21.33	25.29	25.17	25.23
	16QAM	1	0	21.02	21.66	21.59	24.92	25.56	25.49



BW	Modulation	RB size	RB offset	Channel/Frequency(MHz)					
				39750/2506	40620/2593	41490/2680	39750/2506	40620/2593	41490/2680
20MHz	QPSK	1	38	21.20	21.94	21.99	25.10	25.84	25.89
		1	74	20.74	21.52	21.52	24.64	25.42	25.42
		36	0	20.53	20.15	20.34	24.43	24.05	24.24
		36	18	20.51	20.10	20.29	24.41	24.00	24.19
		36	39	20.47	20.18	20.26	24.37	24.08	24.16
		75	0	20.47	20.29	20.27	24.37	24.19	24.17
	16QAM	1	0	22.34	22.37	21.71	26.24	26.27	25.61
		1	50	22.69	22.43	22.18	26.59	26.33	26.08
		1	99	22.20	22.26	21.94	26.10	26.16	25.84
		50	0	21.35	21.19	21.13	25.25	25.09	25.03
		50	25	21.33	21.22	21.16	25.23	25.12	25.06
		50	50	21.32	21.31	21.21	25.22	25.21	25.11
		100	0	21.36	21.22	21.29	25.26	25.12	25.19
		100	0	21.00	21.62	21.54	24.90	25.52	25.44
16QAM	1	50	21.16	21.92	21.95	25.06	25.82	25.85	
	1	99	20.72	21.49	21.50	24.62	25.39	25.40	
	50	0	20.50	20.11	20.31	24.40	24.01	24.21	
	50	25	20.48	20.08	20.26	24.38	23.98	24.16	
	50	50	20.44	20.13	20.22	24.34	24.03	24.12	
	100	0	20.45	20.25	20.24	24.35	24.15	24.14	



6.2 Occupied Bandwidth

Mode	Channel	Frequency (MHz)	99% Power Bandwidth(MHz)	-26dBc Bandwidth(MHz)
WCDMA Band IV (RMC)	1312	1712.4	4.1161	4.676
	1413	1732.6	4.1231	4.688
	1513	1752.6	4.1251	4.668

LTE Band 4							
RB	Modulation	Bandwidth (MHz)	Channel	Frequency (MHz)	99% Power Bandwidth(MHz)	-26dBc Bandwidth(MHz)	
100%	QPSK	1.4	19957	1710.7	1.1217	1.350	
			20175	1732.5	1.1224	1.350	
			20393	1754.3	1.1218	1.330	
		3	19965	1711.5	2.7431	3.078	
			20175	1732.5	2.7522	3.071	
			20385	1753.5	2.7369	3.069	
		5	19975	1712.5	4.5377	5.034	
			20175	1732.5	4.5192	5.013	
			20375	1752.5	4.5084	4.999	
		10	20000	1715	9.0159	10.020	
			20175	1732.5	9.014	9.962	
			20350	1750	9.0374	9.990	
		15	20025	1717.5	13.465	14.840	
			20175	1732.5	13.405	14.610	
			20325	1747.5	13.405	14.660	
		20	20050	1720	17.88	19.280	
			20175	1732.5	17.824	19.090	
			20300	1745	17.862	19.250	
		16QAM	1.4	19957	1710.7	1.124	1.335
				20175	1732.5	1.1231	1.318
				20393	1754.3	1.1184	1.342
			3	19965	1711.5	2.7471	3.061
				20175	1732.5	2.7359	3.055
				20385	1753.5	2.7337	3.038
			5	19975	1712.5	4.5201	4.976
				20175	1732.5	4.5258	5.003
				20375	1752.5	4.5315	4.971



		10	20000	1715	9.0049	9.973
			20175	1732.5	9.0265	10.020
			20350	1750	8.9865	9.899
		15	20025	1717.5	13.467	14.640
			20175	1732.5	13.417	13.700
			20325	1747.5	13.456	14.620
		20	20050	1720	17.846	19.230
			20175	1732.5	17.877	19.260
			20300	1745	17.863	19.200

LTE Band 12							
RB	Modulation	Bandwidth (MHz)	Channel	Frequency (MHz)	99% Power Bandwidth(MHz)	-26dBc Bandwidth(MHz)	
100%	QPSK	1.4	23017	699.7	1.0977	1.321	
			23095	707.5	1.1205	1.302	
			23173	715.3	1.1097	1.326	
		3	23025	700.5	2.7417	3.068	
			23095	707.5	2.7441	3.052	
			23165	714.5	2.743	3.056	
		5	23035	701.5	4.5229	4.987	
			23095	707.5	4.509	4.959	
			23155	713.5	4.5031	4.978	
		10	23060	704	9.0312	10.07	
			23095	707.5	9.021	10.01	
			23130	711	9.0044	9.88	
		16QAM	1.4	23017	699.7	1.115	1.328
				23095	707.5	1.1173	1.327
				23173	715.3	1.1236	1.327
	3		23025	700.5	2.7363	3.019	
			23095	707.5	2.7362	3.044	
			23165	714.5	2.7442	3.05	
	5		23035	701.5	4.5056	4.905	
			23095	707.5	4.5276	5.009	
			23155	713.5	4.5064	5.019	
	10		23060	704	8.9843	9.974	
			23095	707.5	9.0323	9.916	
			23130	711	8.9865	9.939	



LTE Band 13							
RB	Modulation	Bandwidth (MHz)	Channel	Frequency (MHz)	99% Power Bandwidth(MHz)	-26dBc Bandwidth(MHz)	
100%	QPSK	5	23205	779.5	4.5146	5.013	
			23230	782	4.5118	4.968	
			23255	784.5	4.5097	5.019	
	16QAM	10	5	23230	782	9.028	10.09
				23205	779.5	4.5292	5.029
				23230	782	4.5272	5.058
		10	5	23255	784.5	4.5001	4.955
				23230	782	9.0337	9.946
				23230	782	9.0337	9.946

LTE Band 17							
RB	Modulation	Bandwidth (MHz)	Channel	Frequency (MHz)	99% Power Bandwidth(MHz)	-26dBc Bandwidth(MHz)	
100%	QPSK	5	23755	706.5	4.507	5.017	
			23790	710	4.5013	4.979	
			23825	713.5	4.5253	4.975	
		10	5	23780	709	9.0302	10.08
				23790	710	9.0221	9.964
				23800	711	8.9966	10.06
	16QAM	5	5	23755	706.5	4.5251	4.996
				23790	710	4.5319	5.036
				23825	713.5	4.4966	5.015
		10	5	23780	709	9.0464	10.01
				23790	710	9.0162	10.04
				23800	711	9.0052	10.00



LTE Band 41						
RB	Modulation	Bandwidth (MHz)	Channel	Frequency (MHz)	99% Power Bandwidth(MHz)	-26dBc Bandwidth(MHz)
100%	QPSK	5	39675	2498.5	4.5114	4.95
			40620	2593	4.4991	4.909
			41565	2687.5	4.5071	4.978
		10	39700	2501	9.0199	10.03
			40620	2593	9.0304	9.914
			41540	2685	9.0344	10
		15	39725	2503.5	13.431	14.56
			40620	2593	13.444	15.05
			41515	2682.5	13.415	14.55
		20	39750	2506	17.867	19.03
			40620	2593	17.869	19.08
			41490	2680	17.836	19.1
	16QAM	5	39675	2498.5	4.5031	5.004
			40620	2593	4.495	5.005
			41565	2687.5	4.5047	4.968
		10	39700	2501	8.9819	9.938
			40620	2593	9.0224	9.88
			41540	2685	9.0292	9.929
		15	39725	2503.5	13.452	14.84
			40620	2593	13.417	14.54
			41515	2682.5	13.459	14.62
		20	39750	2506	17.881	19.16
			40620	2593	17.853	19.82
			41490	2680	17.821	19.24

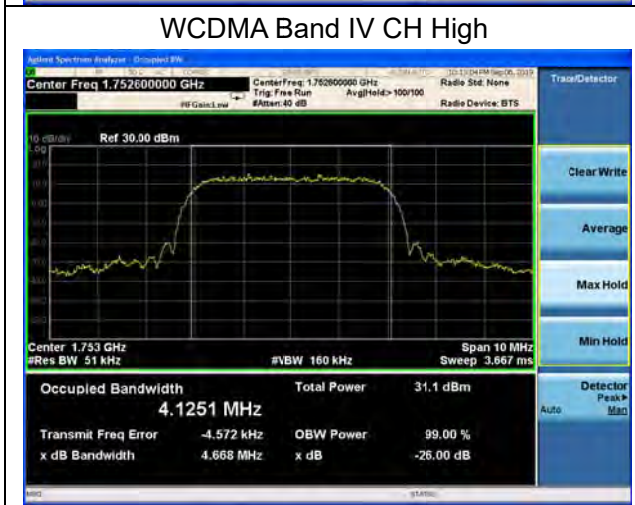
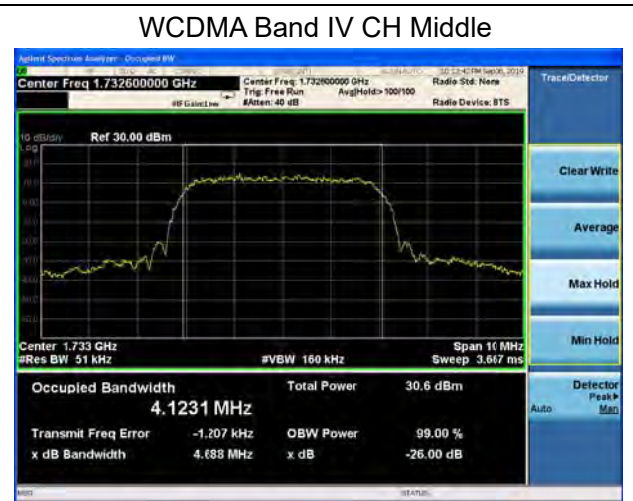
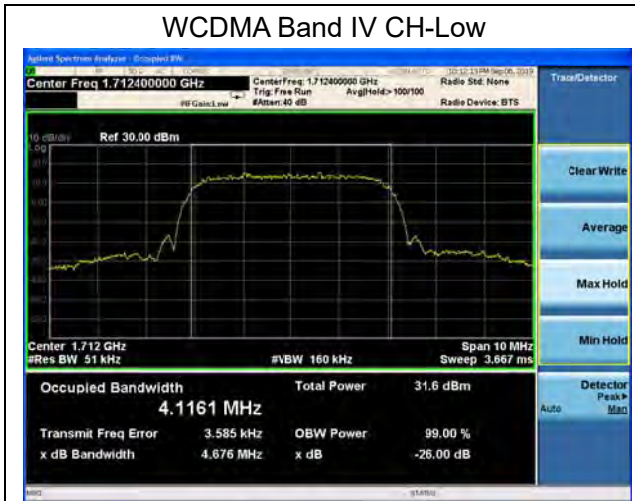



LTE Band 4 QPSK 1.4MHz CH-Low

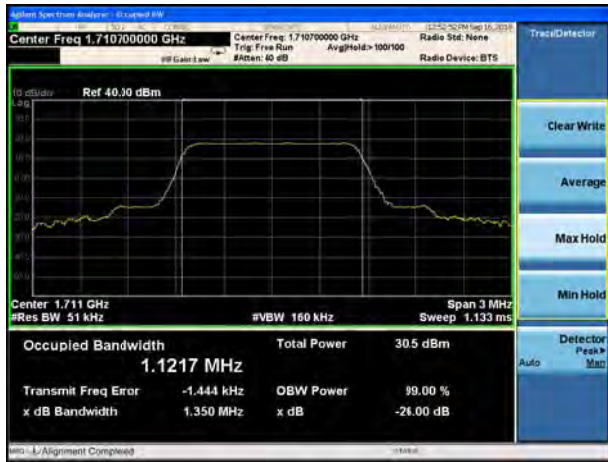

LTE Band 4 QPSK 3MHz CH-Low

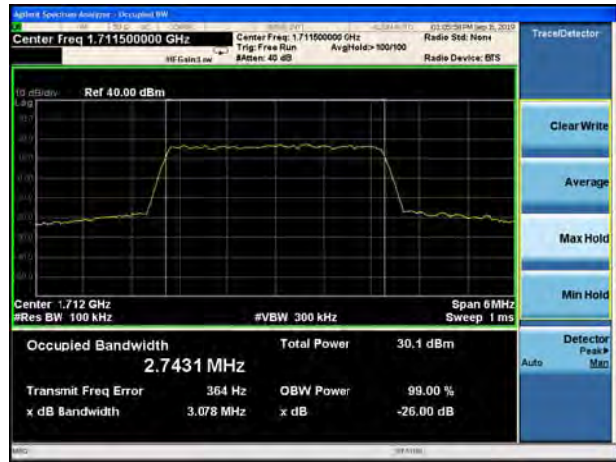

LTE Band 4 QPSK 1.4MHz CH-Middle



LTE Band 4 QPSK 3MHz CH-Middle



LTE Band 4 QPSK 1.4MHz CH-High



LTE Band 4 QPSK 3MHz CH-High





LTE Band 4 QPSK 5MHz CH-Low

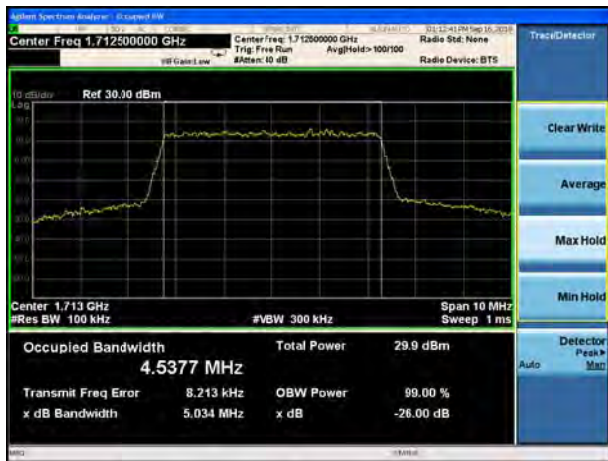

LTE Band 4 QPSK 10MHz CH-Low



LTE Band 4 QPSK 5MHz CH-Middle

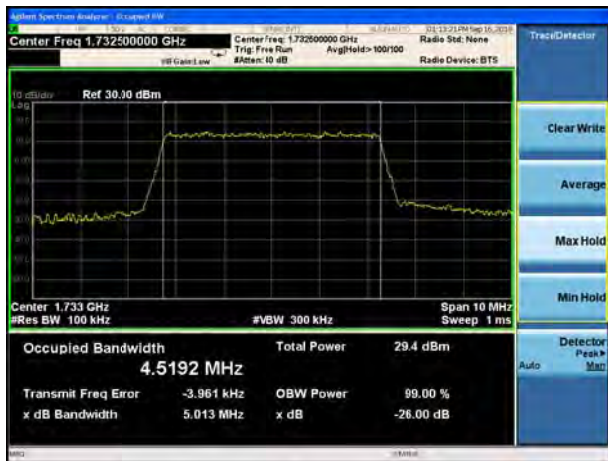

LTE Band 4 QPSK 10MHz CH-Middle

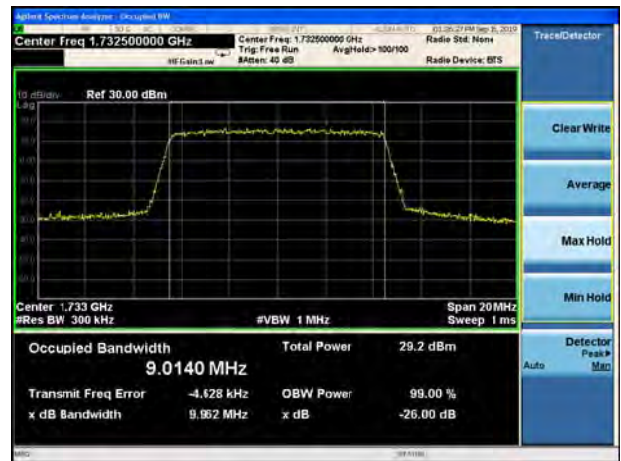

LTE Band 4 QPSK 5MHz CH-High

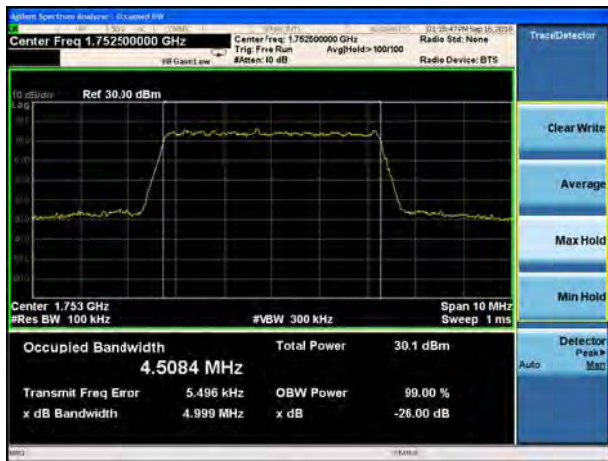

LTE Band 4 QPSK 10MHz CH-High

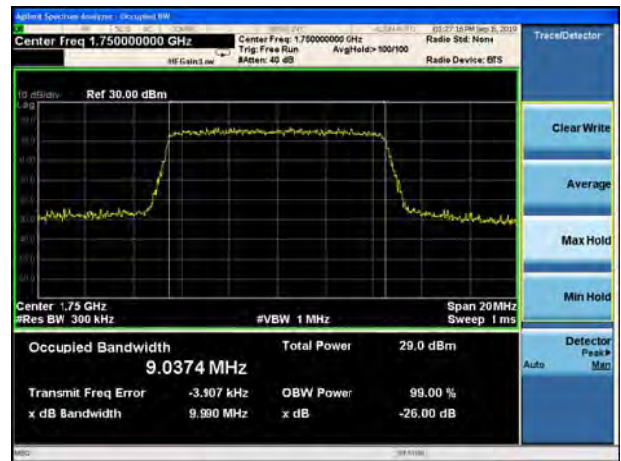



LTE Band 4 QPSK 15MHz CH-Low



LTE Band 4 QPSK 20MHz CH-Low



LTE Band 4 QPSK 15MHz CH-Middle

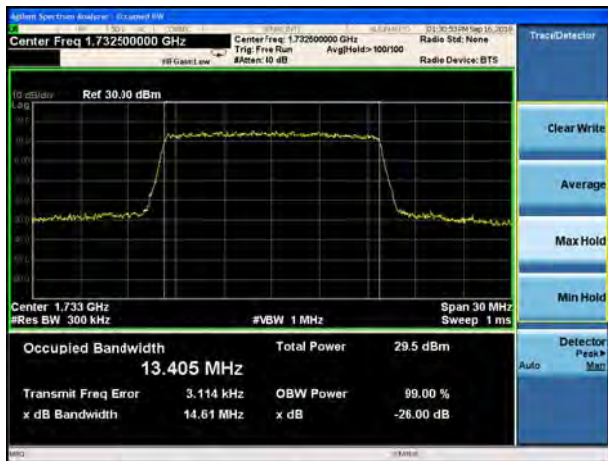

LTE Band 4 QPSK 20MHz CH-Middle



LTE Band 4 QPSK 15MHz CH-High

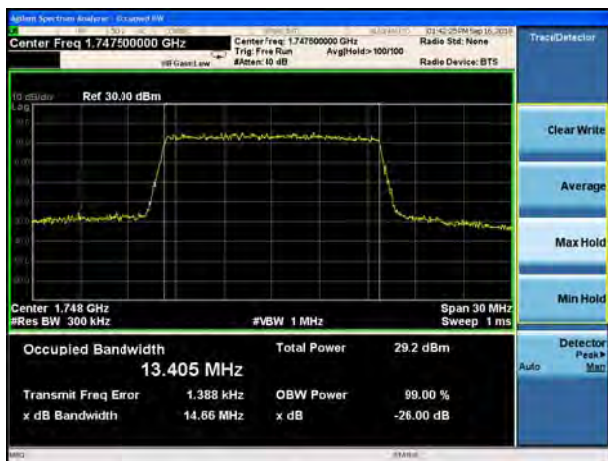

LTE Band 4 QPSK 20MHz CH-High

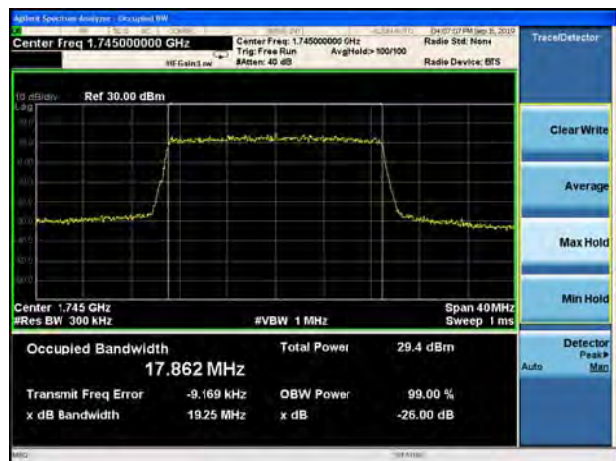



LTE Band 4 16QAM 1.4MHz CH-Low

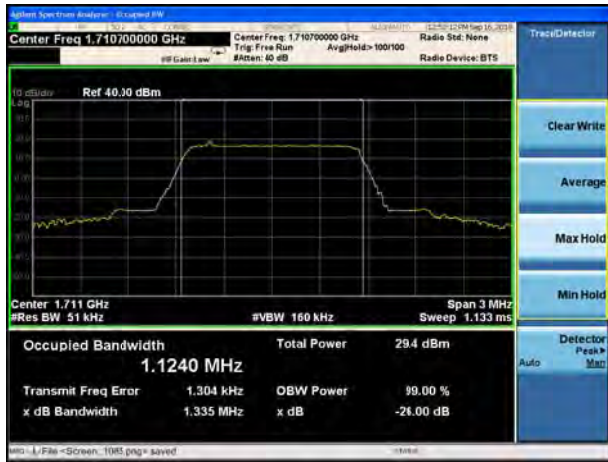

LTE Band 4 16QAM 3MHz CH-Low



LTE Band 4 16QAM 1.4MHz CH-Middle



LTE Band 4 16QAM 3MHz CH-Middle



LTE Band 4 16QAM 1.4MHz CH-High



LTE Band 4 16QAM 3MHz CH-High





LTE Band 4 16QAM 5MHz CH-Low

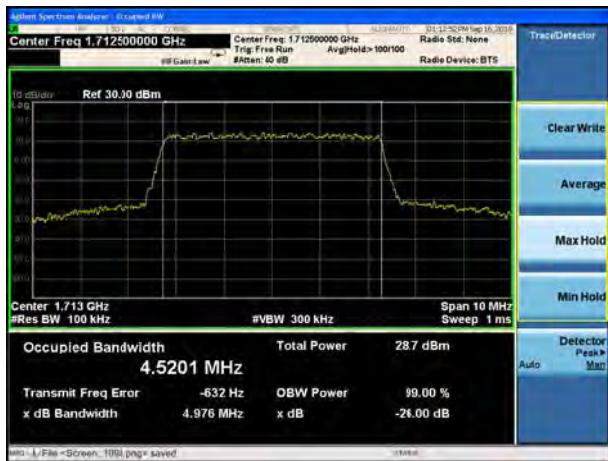

LTE Band 4 16QAM 10MHz CH-Low



LTE Band 4 16QAM 5MHz CH-Middle

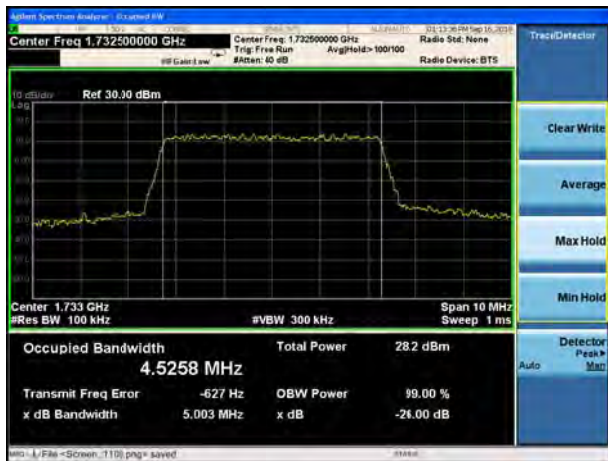

LTE Band 4 16QAM 10MHz CH-Middle

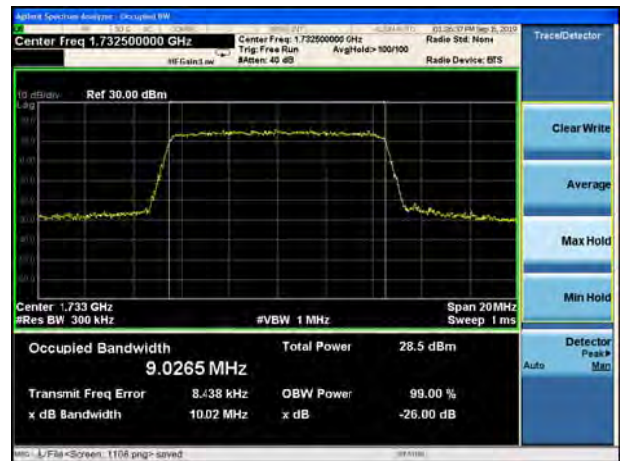

LTE Band 4 16QAM 5MHz CH-High

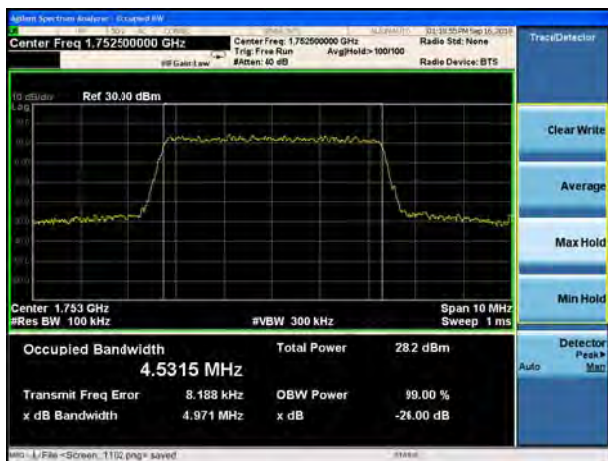

LTE Band 4 16QAM 10MHz CH-High





LTE Band 4 16QAM 15MHz CH-Low



LTE Band 4 16QAM 20MHz CH-Low

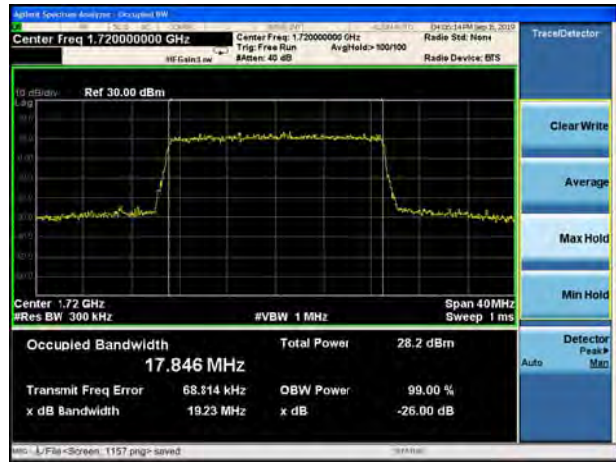

LTE Band 4 16QAM 15MHz CH-Middle

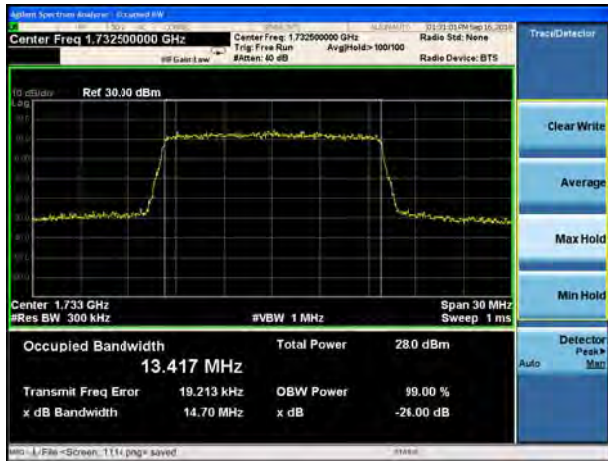

LTE Band 4 16QAM 20MHz CH-Middle



LTE Band 4 16QAM 15MHz CH-High



LTE Band 4 16QAM 20MHz CH-High





LTE Band 12 QPSK 1.4MHz CH-Low



LTE Band 12 QPSK 3MHz CH-Low

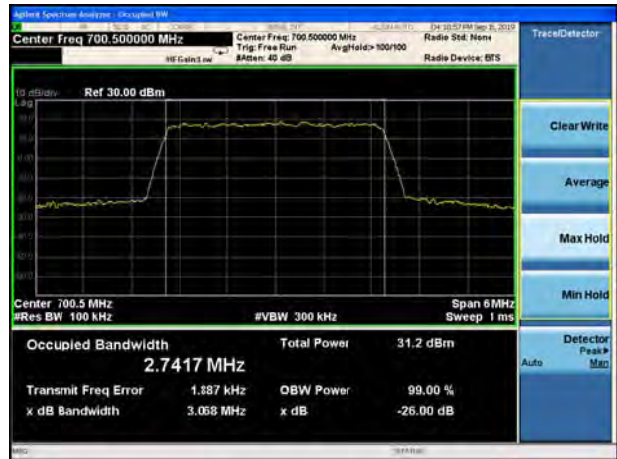

LTE Band 12 QPSK 1.4MHz CH-Middle



LTE Band 12 QPSK 3MHz CH-Middle

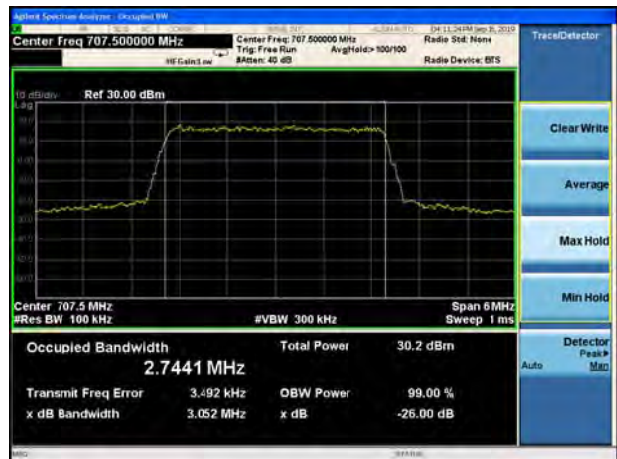

LTE Band 12 QPSK 1.4MHz CH-High



LTE Band 12 QPSK 3MHz CH-High

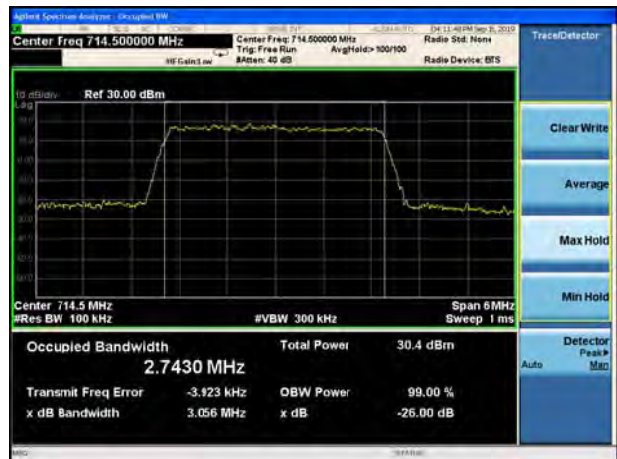



LTE Band 12 QPSK 5MHz CH-Low



LTE Band 12 QPSK 10MHz CH-Low



LTE Band 12 QPSK 5MHz CH-Middle



LTE Band 12 QPSK 10MHz CH-Middle



LTE Band 12 QPSK 5MHz CH-High

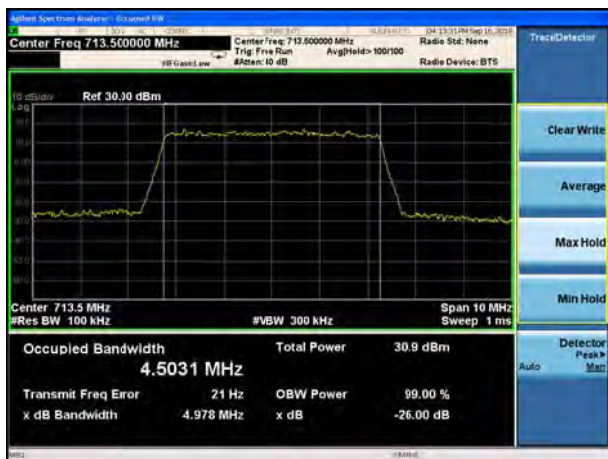

LTE Band 12 QPSK 10MHz CH-High





LTE Band 12 16QAM 1.4MHz CH-Low



LTE Band 12 16QAM 3MHz CH-Low



LTE Band 12 16QAM 1.4MHz CH-Middle



LTE Band 12 16QAM 3MHz CH-Middle



LTE Band 12 16QAM 1.4MHz CH-High



LTE Band 12 16QAM 3MHz CH-High





LTE Band 12 16QAM 5MHz CH-Low



LTE Band 12 16QAM 10MHz CH-Low



LTE Band 12 16QAM 5MHz CH-Middle



LTE Band 12 16QAM 10MHz CH-Middle



LTE Band 12 16QAM 5MHz CH-High



LTE Band 12 16QAM 10MHz CH-High





LTE Band 13 QPSK 5MHz CH-Low

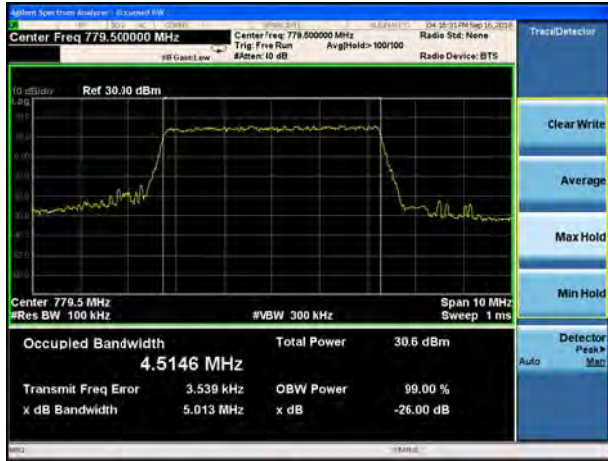

LTE Band 13 QPSK 10MHz CH-Middle



LTE Band 13 QPSK 5MHz CH-Middle



LTE Band 13 QPSK 5MHz CH-High





LTE Band 13 16QAM 5MHz CH-Low



LTE Band 13 16QAM 10MHz CH-Middle



LTE Band 13 16QAM 5MHz CH-Middle



LTE Band 13 16QAM 5MHz CH-High

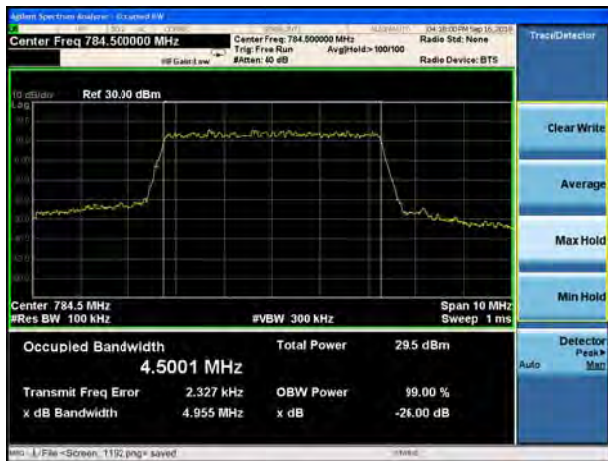



LTE Band 17 QPSK 5MHz CH-Low

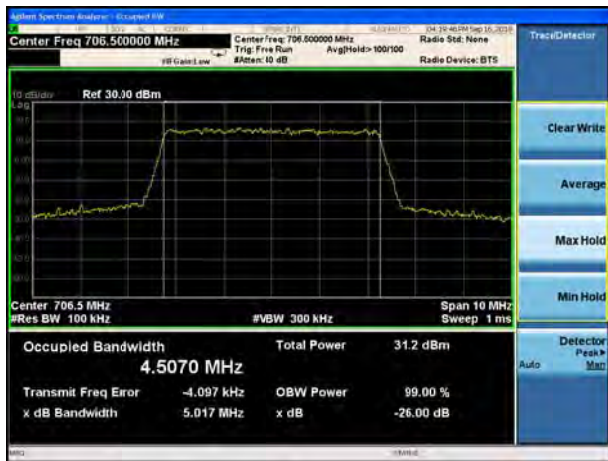

LTE Band 17 QPSK 10MHz CH-Low

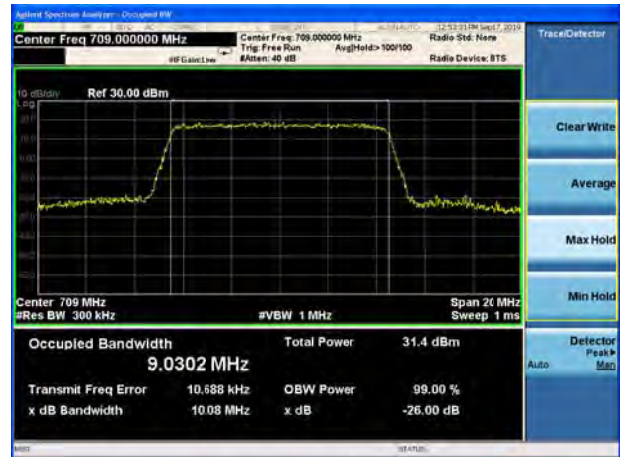

LTE Band 17 QPSK 5MHz CH-Middle

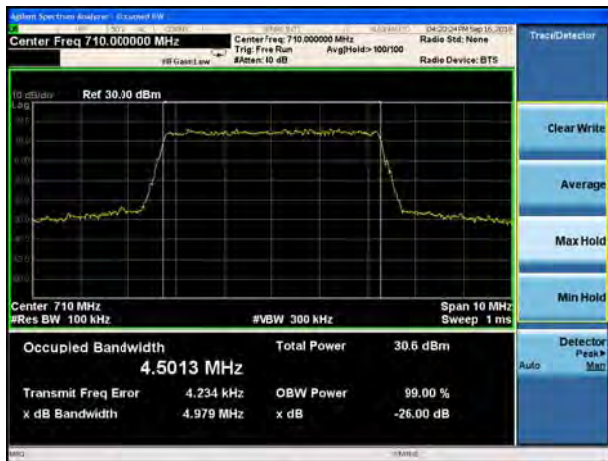

LTE Band 17 QPSK 10MHz CH-Middle

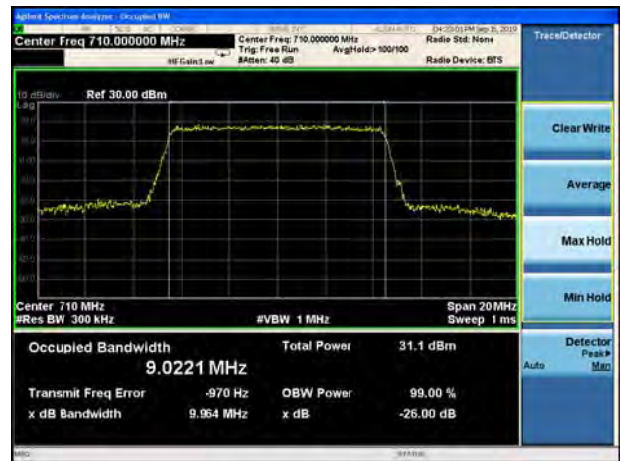

LTE Band 17 QPSK 5MHz CH-High

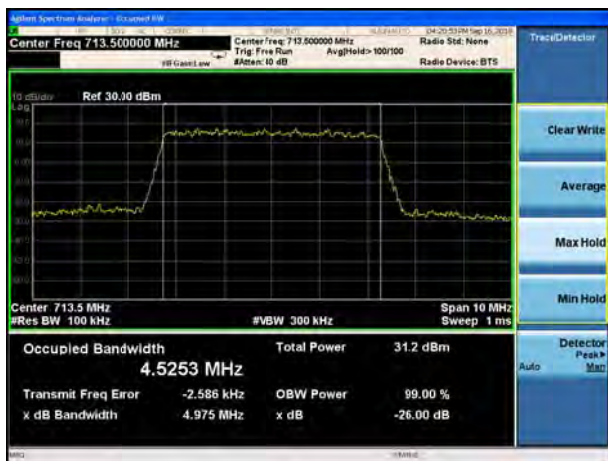

LTE Band 17 QPSK 10MHz CH-High





LTE Band 17 16QAM 5MHz CH-Low



LTE Band 17 16QAM 10MHz CH-Low



LTE Band 17 16QAM 5MHz CH-Middle

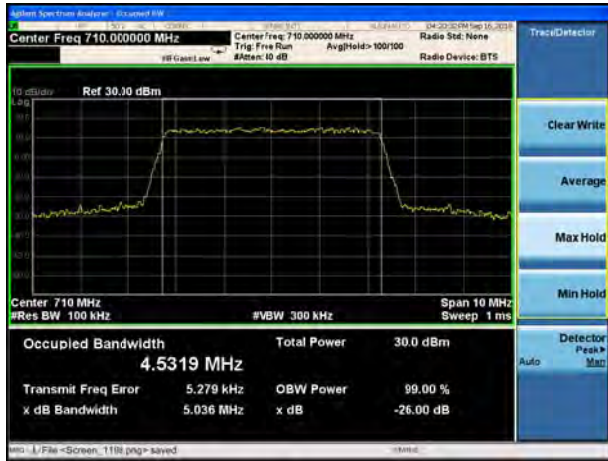

LTE Band 17 16QAM 10MHz CH-Middle

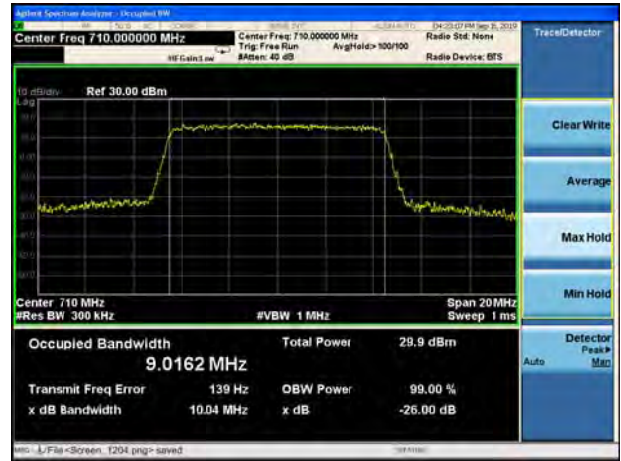

LTE Band 17 16QAM 5MHz CH-High

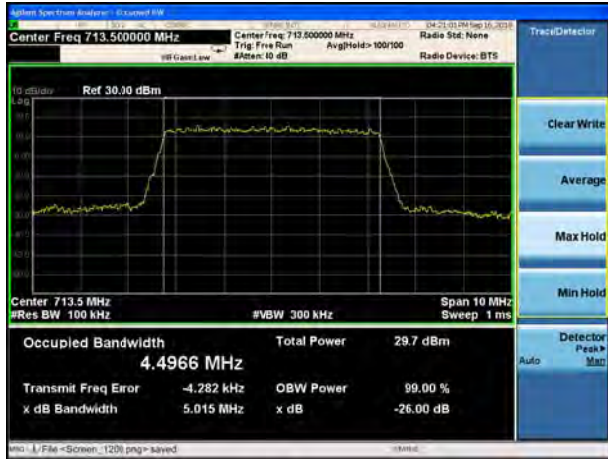

LTE Band 17 16QAM 10MHz CH-High



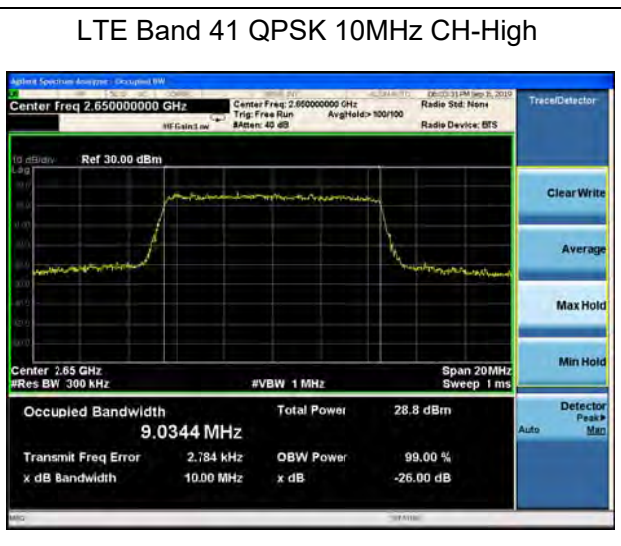
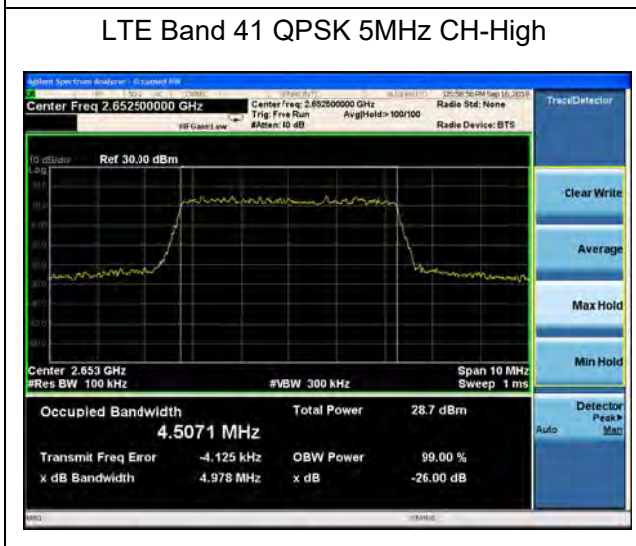
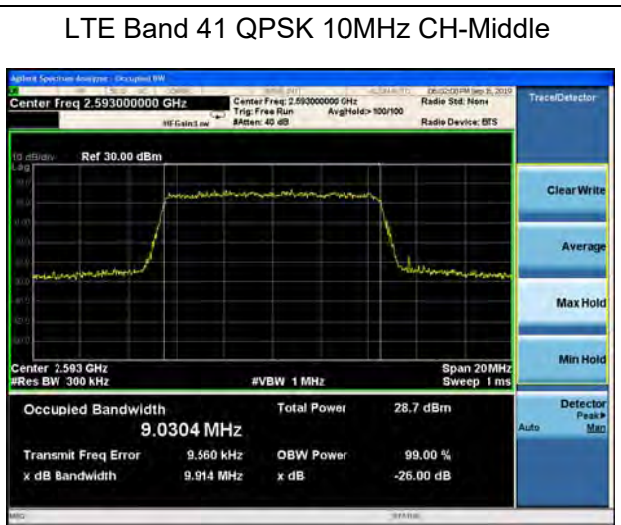
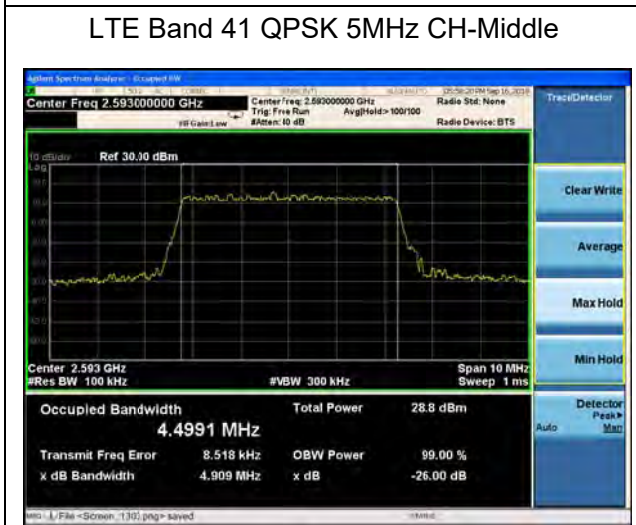
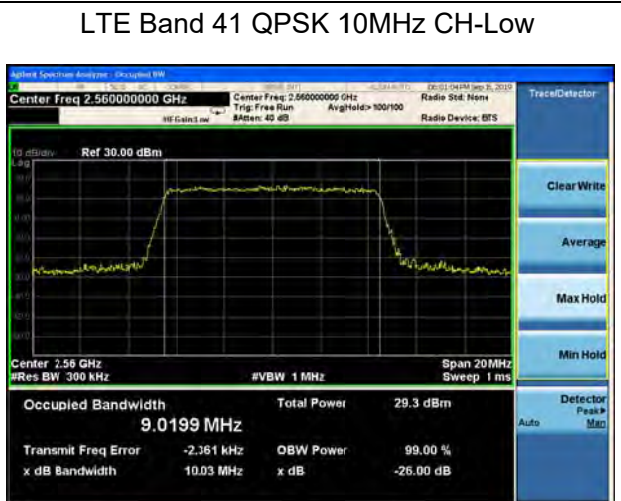
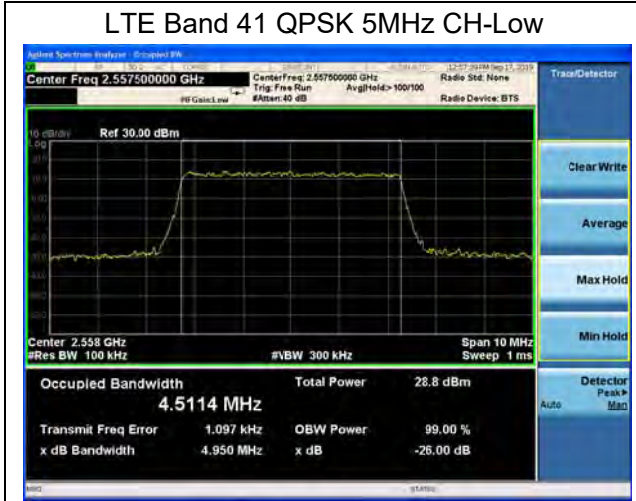



LTE Band 41 QPSK 15MHz CH-Low

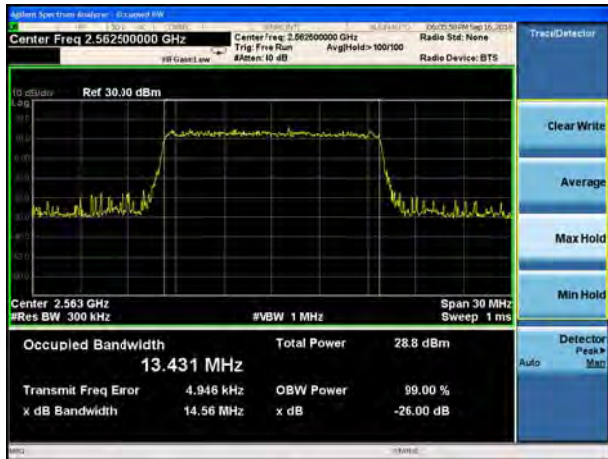

LTE Band 41 QPSK 20MHz CH-Low



LTE Band 41 QPSK 15MHz CH-Middle

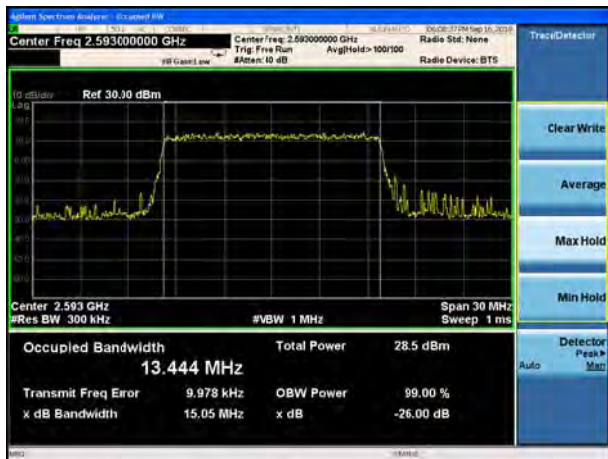

LTE Band 41 QPSK 20MHz CH-Middle

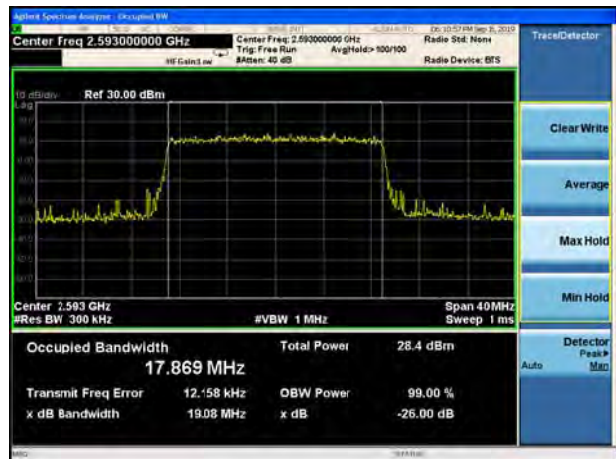

LTE Band 41 QPSK 15MHz CH-High

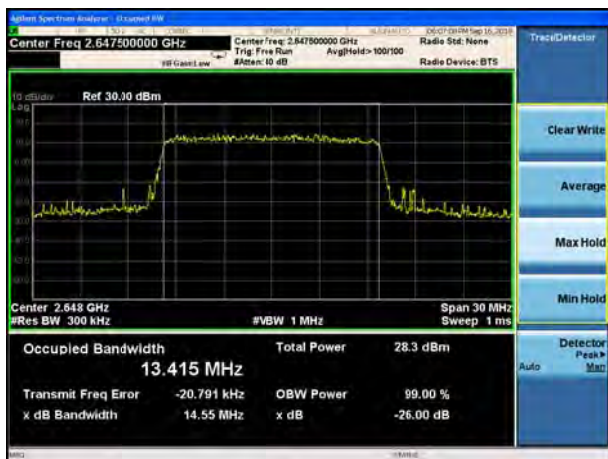

LTE Band 41 QPSK 20MHz CH-High

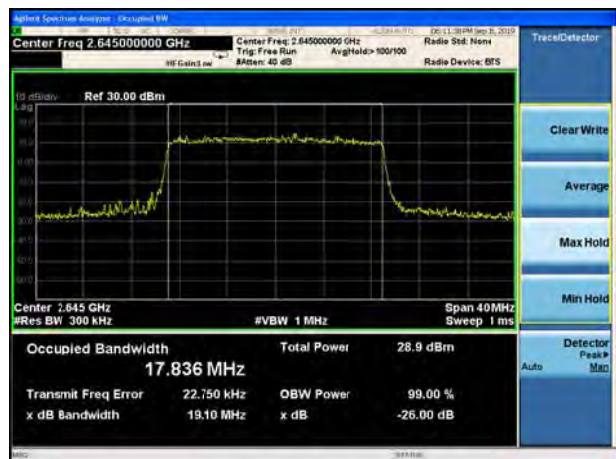



LTE Band 41 16QAM 5MHz CH-Low

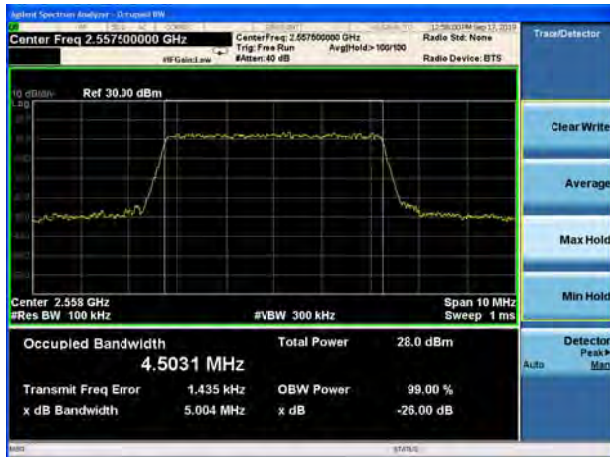

LTE Band 41 16QAM 10MHz CH-Low

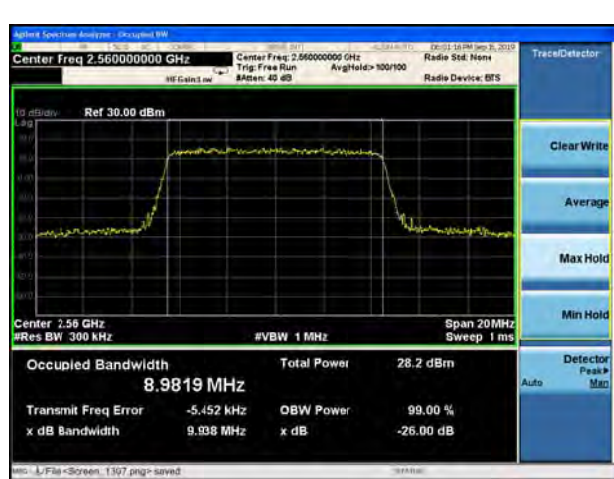

LTE Band 41 16QAM 5MHz CH-Middle



LTE Band 41 16QAM 10MHz CH-Middle



LTE Band 41 16QAM 5MHz CH-High



LTE Band 41 16QAM 10MHz CH-High





LTE Band 41 16QAM 15MHz CH-Low

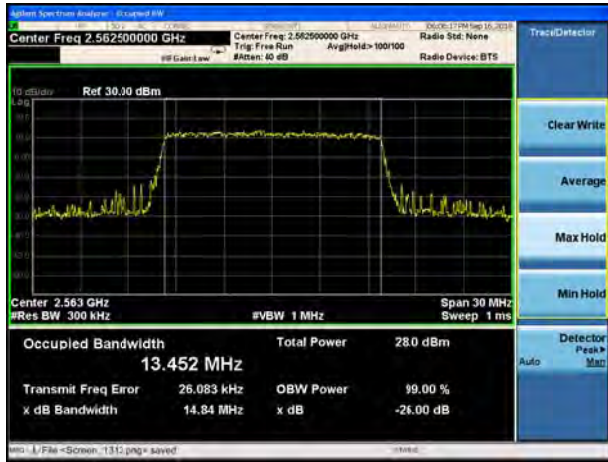

LTE Band 41 16QAM 20MHz CH-Low

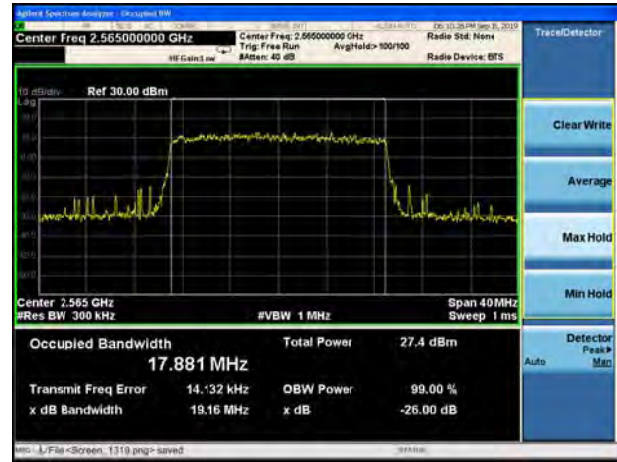

LTE Band 41 16QAM 15MHz CH-Middle

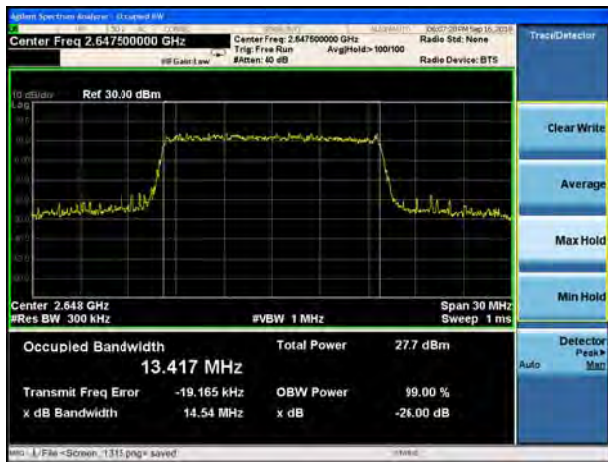

LTE Band 41 16QAM 20MHz CH-Middle

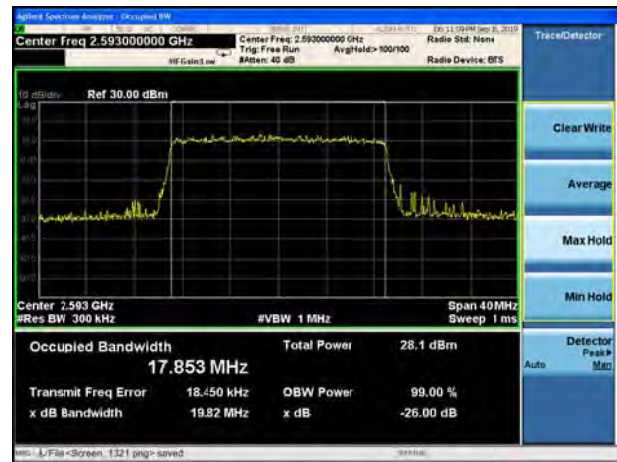

LTE Band 41 16QAM 15MHz CH-High

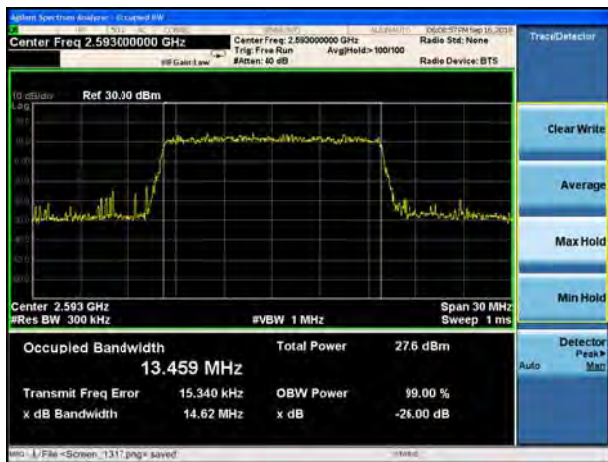

LTE Band 41 16QAM 20MHz CH-High



6.3 Band Edge

All the test traces in the plots shows the test results clearly.





LTE Band 4 QPSK 1.4MHz CH-Low, 1 RB



LTE Band 4 QPSK 1.4MHz CH-High, 1 RB

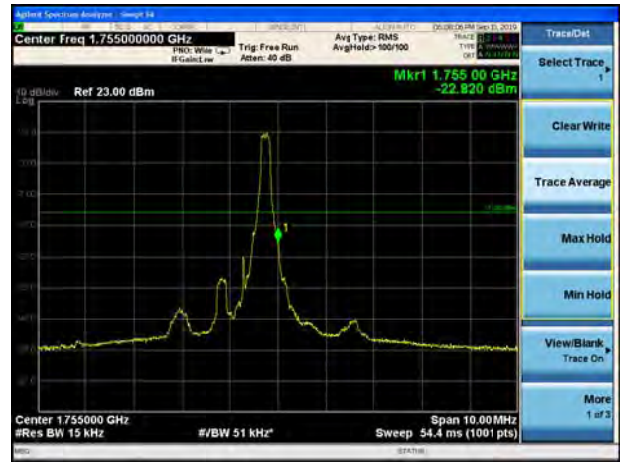

LTE Band 4 QPSK 1.4MHz CH-Low, 100%RB

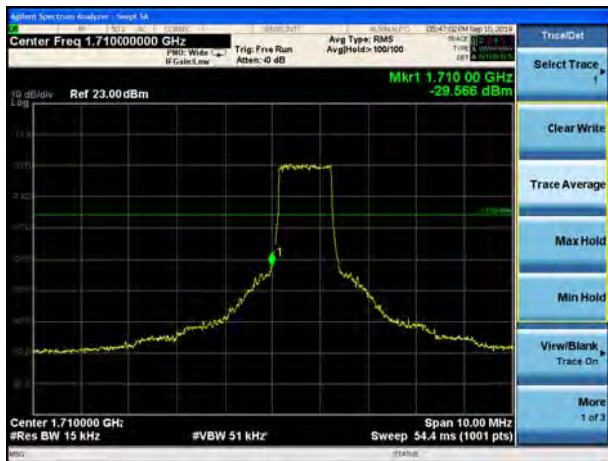

LTE Band 4 QPSK 1.4MHz CH-High, 100%RB

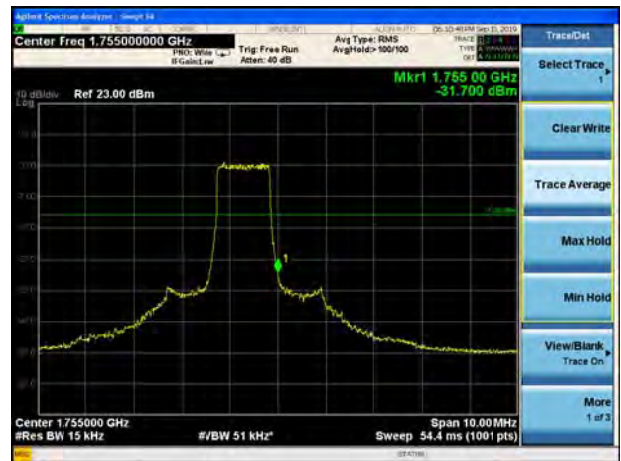

LTE Band 4 QPSK 3MHz CH-Low, 1 RB

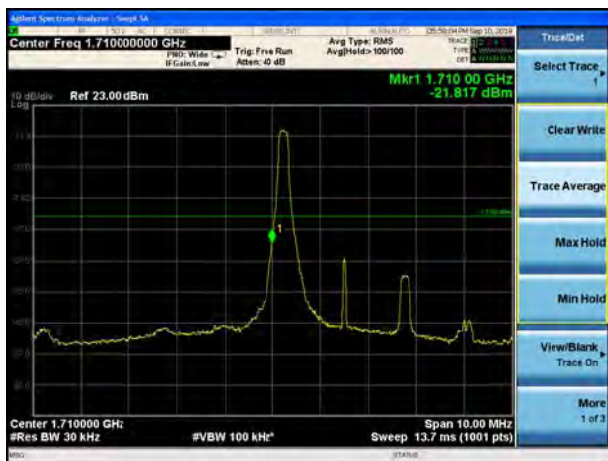

LTE Band 4 QPSK 3MHz CH-High, 1 RB

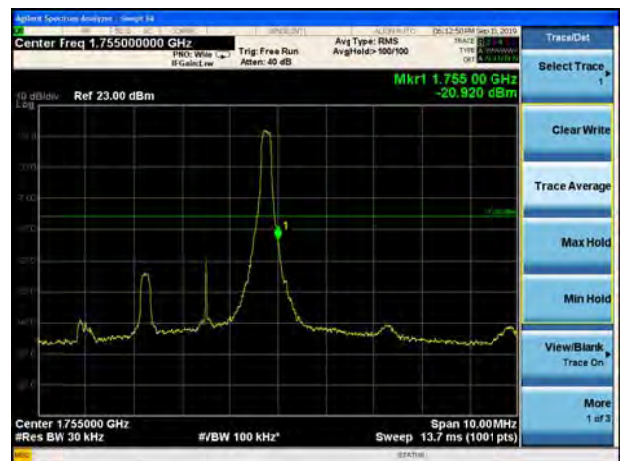



LTE Band 4 QPSK 3MHz CH-Low, 100%RB



LTE Band 4 QPSK 3MHz CH-High, 100%RB



LTE Band 4 QPSK 5MHz CH-Low, 1 RB

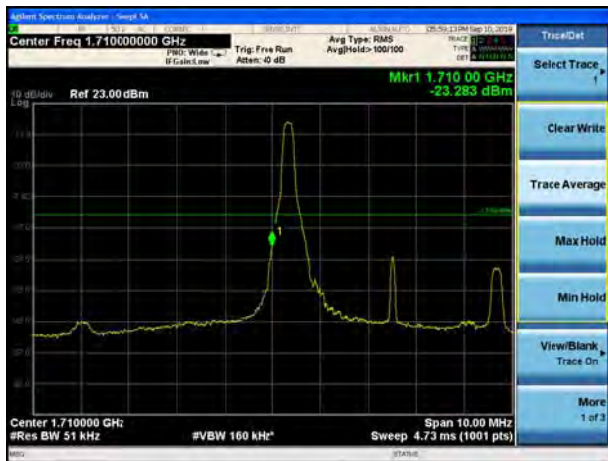

LTE Band 4 QPSK 5MHz CH-High, 1 RB

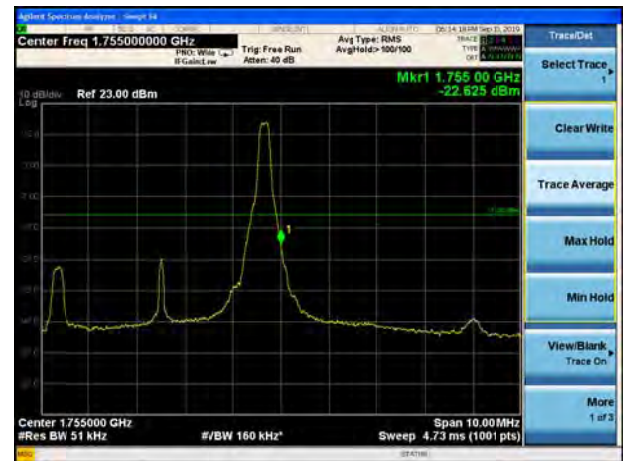

LTE Band 4 QPSK 5MHz CH-Low, 100%RB

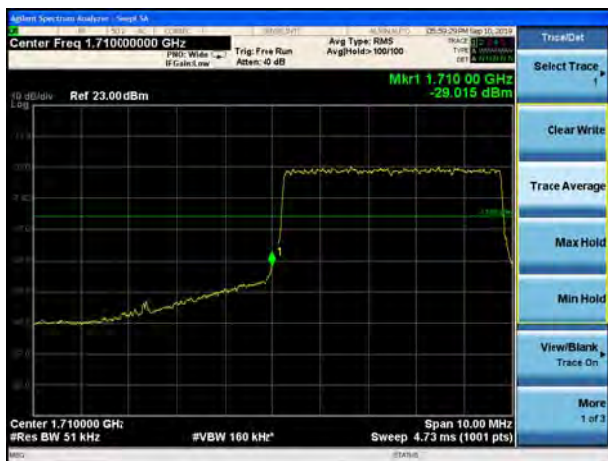

LTE Band 4 QPSK 5MHz CH-High, 100%RB





LTE Band 4 QPSK 10MHz CH-Low, 1 RB

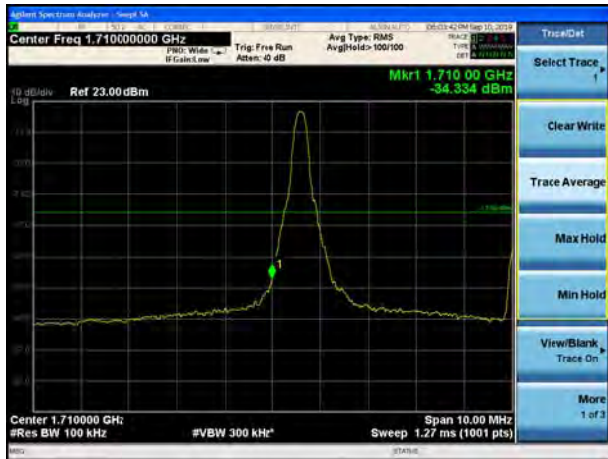

LTE Band 4 QPSK 10MHz CH-High, 1 RB

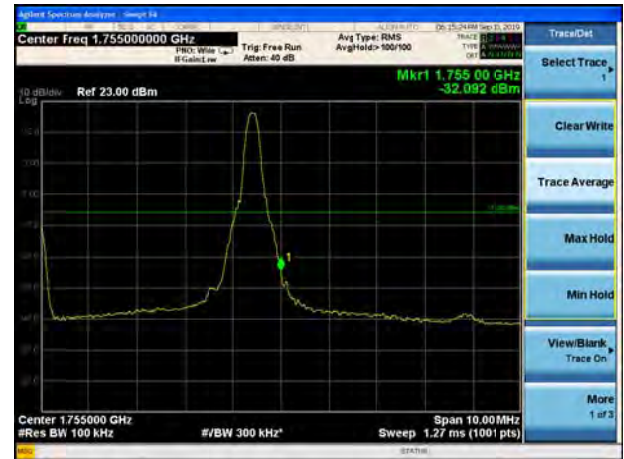

LTE Band 4 QPSK 10MHz CH-Low, 100%RB



LTE Band 4 QPSK 10MHz CH-High, 100%RB

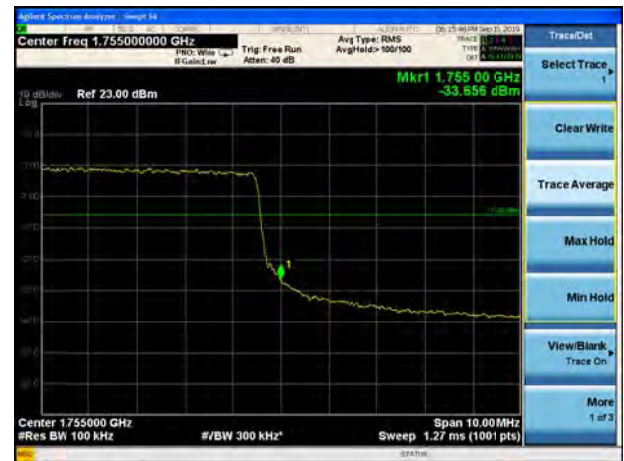

LTE Band 4 QPSK 15MHz CH-Low, 1 RB

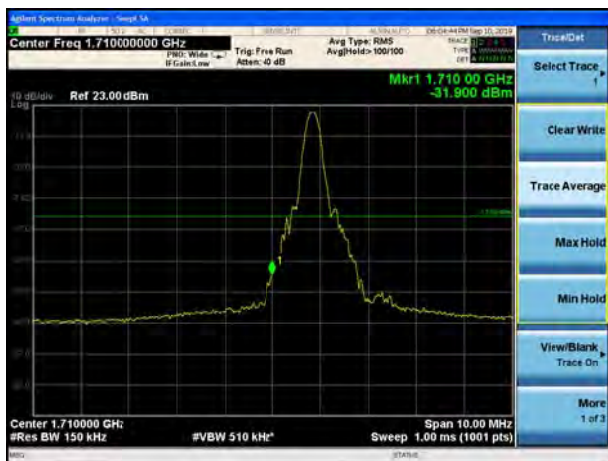

LTE Band 4 QPSK 15MHz CH-High, 1 RB

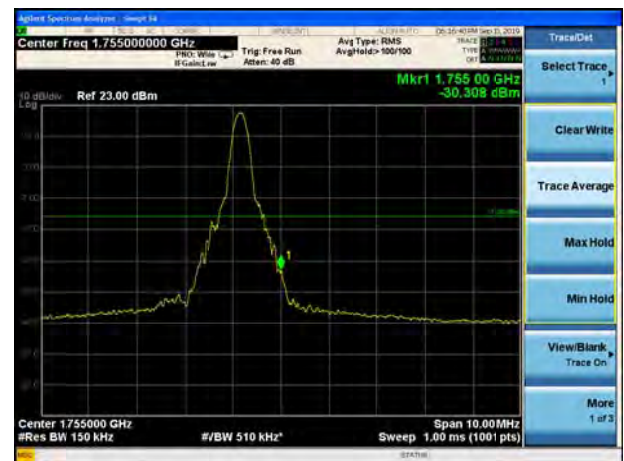



LTE Band 4 QPSK 15MHz CH-Low, 100%RB



LTE Band 4 QPSK 15MHz CH-High, 100%RB



LTE Band 4 QPSK 20MHz CH-Low, 1 RB

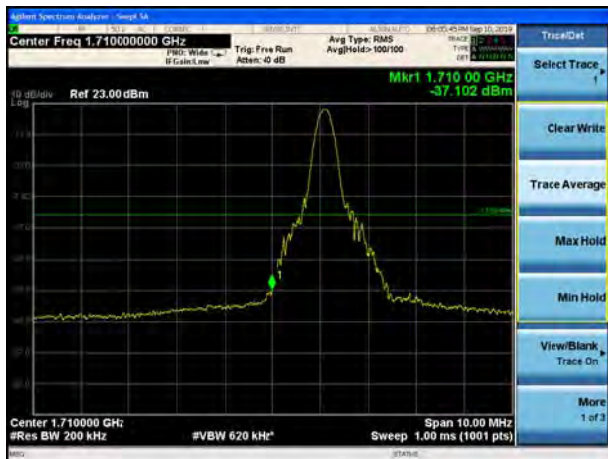

LTE Band 4 QPSK 20MHz CH-High, 1 RB

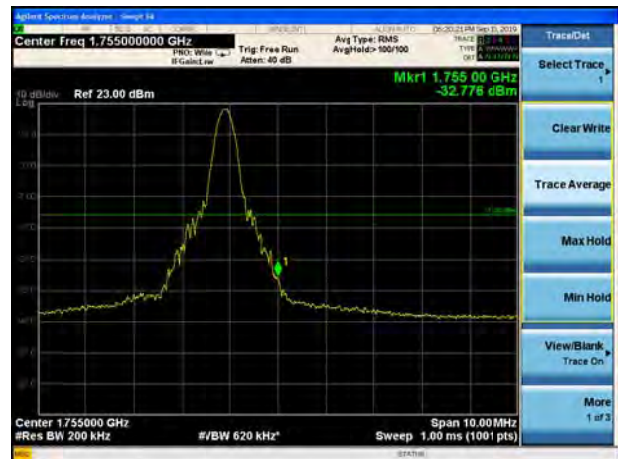

LTE Band 4 QPSK 20MHz CH-Low, 100%RB

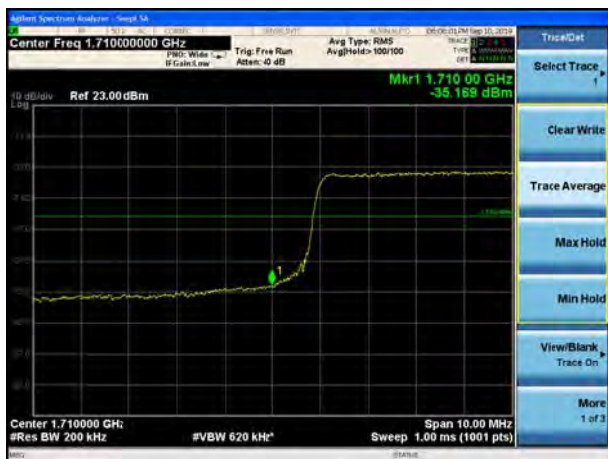

LTE Band 4 QPSK 20MHz CH-High, 100%RB





LTE Band 4 16QAM 1.4MHz CH-Low, 1 RB

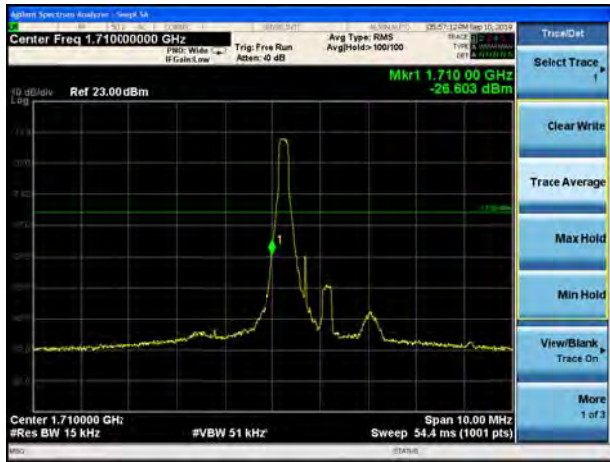

LTE Band 4 16QAM 1.4MHz CH-High, 1 RB



LTE Band 4 16QAM 1.4MHz CH-Low, 100%RB

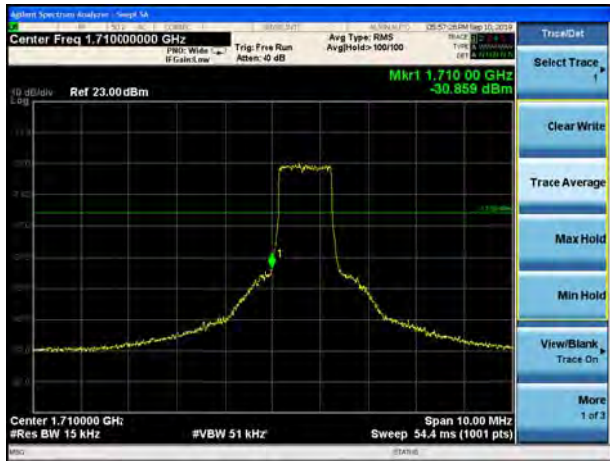

LTE Band 4 16QAM 1.4MHz CH-High, 100%RB

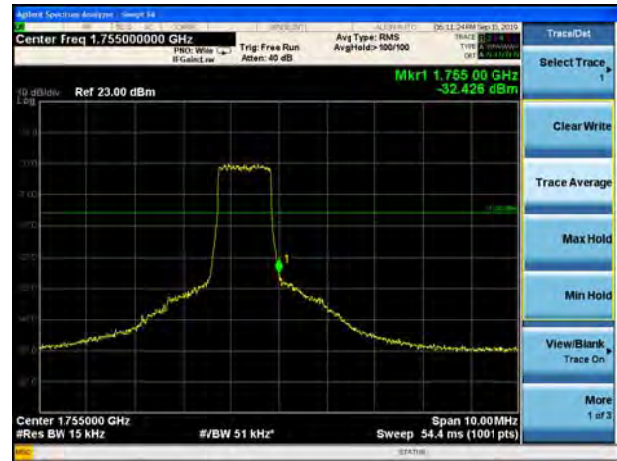

LTE Band 4 16QAM 3MHz CH-Low, 1 RB

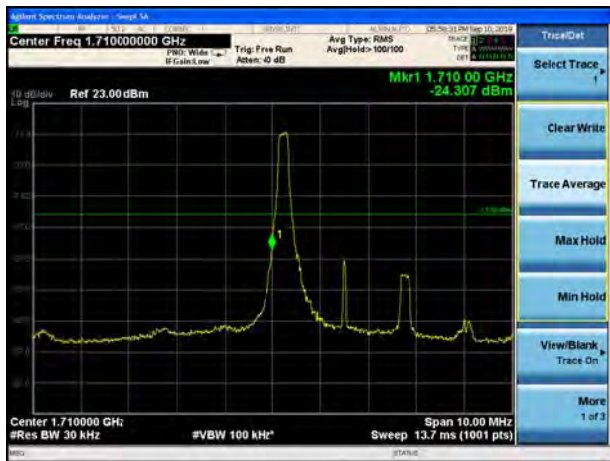

LTE Band 4 16QAM 3MHz CH-High, 1 RB





LTE Band 4 16QAM 3MHz CH-Low, 100%RB



LTE Band 4 16QAM 3MHz CH-High, 100%RB



LTE Band 4 16QAM 5MHz CH-Low, 1 RB



LTE Band 4 16QAM 5MHz CH-High, 1 RB

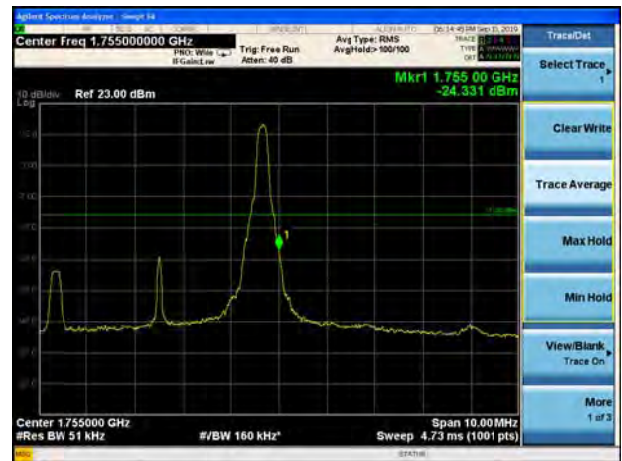

LTE Band 4 16QAM 5MHz CH-Low, 100%RB



LTE Band 4 16QAM 5MHz CH-High, 100%RB





LTE Band 4 16QAM 10MHz CH-Low, 1 RB

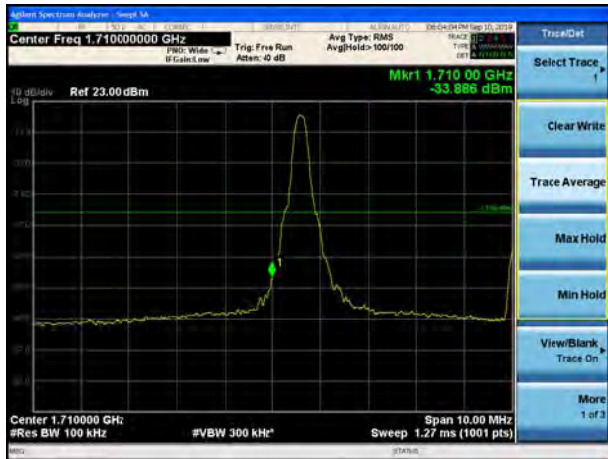

LTE Band 4 16QAM 10MHz CH-High, 1 RB

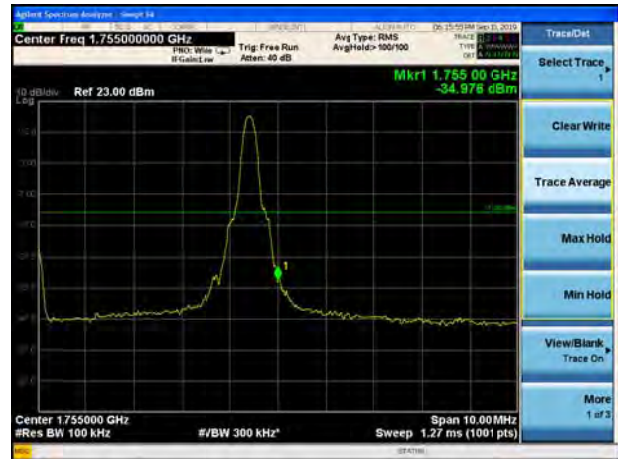

LTE Band 4 16QAM 10MHz CH-Low, 100%RB

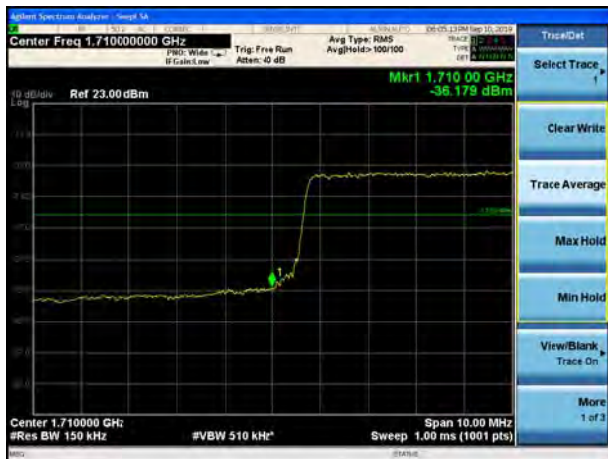

LTE Band 4 16QAM 10MHz CH-High, 100%RB



LTE Band 4 16QAM 15MHz CH-Low, 1 RB

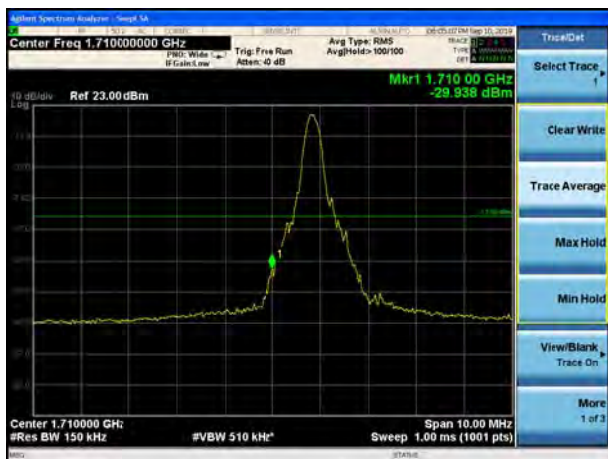

LTE Band 4 16QAM 15MHz CH-High, 1 RB

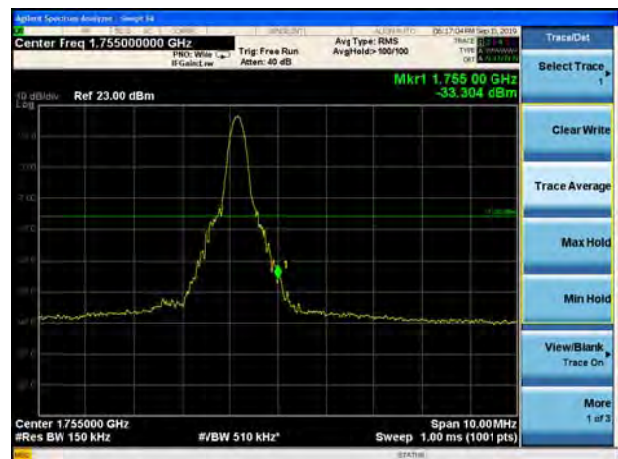



LTE Band 4 16QAM 15MHz CH-Low, 100%RB

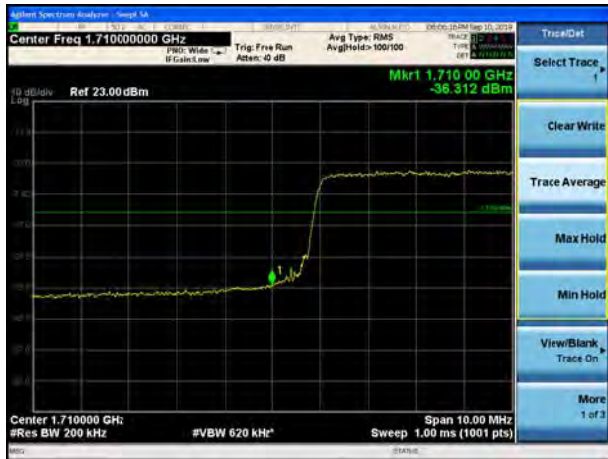

LTE Band 4 16QAM 15MHz CH-High, 100%RB



LTE Band 4 16QAM 20MHz CH-Low, 1 RB

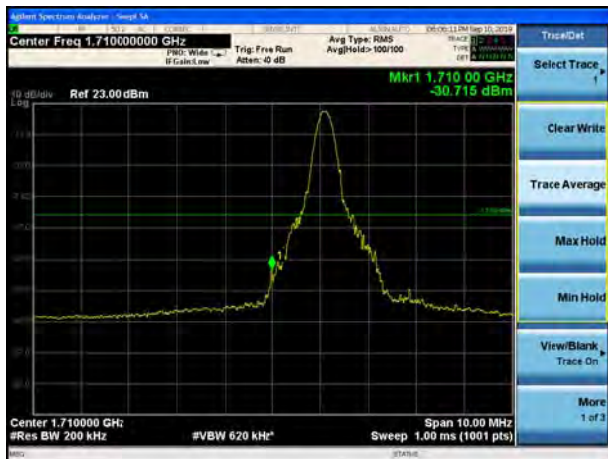

LTE Band 4 16QAM 20MHz CH-High, 1 RB



LTE Band 4 16QAM 20MHz CH-Low, 100%RB

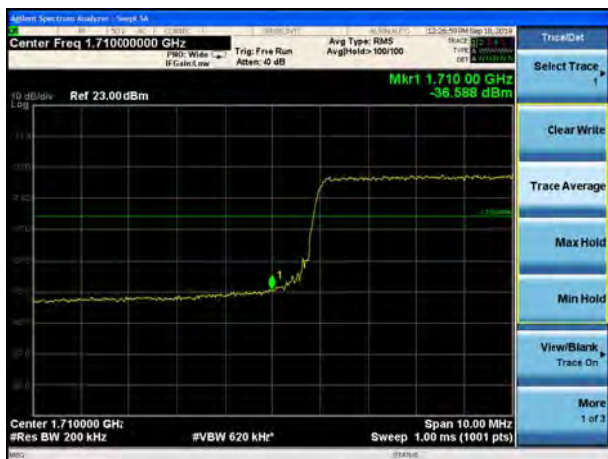

LTE Band 4 16QAM 20MHz CH-High, 100%RB





LTE Band 12 QPSK 1.4MHz CH-Low, 1 RB

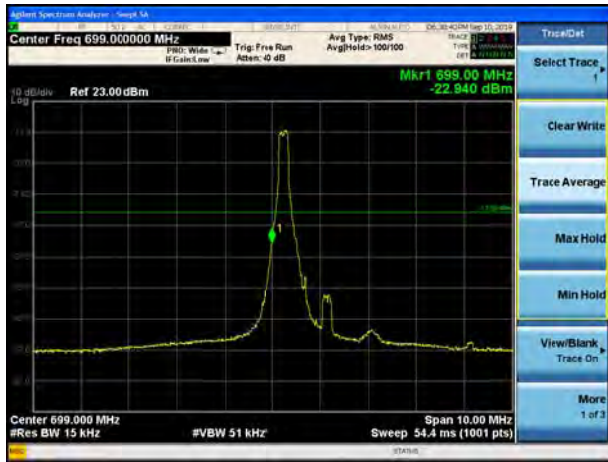

LTE Band 12 QPSK 1.4MHz CH-High, 1 RB

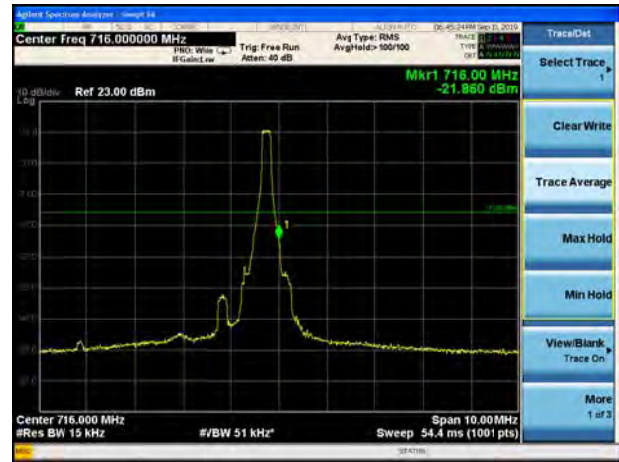

LTE Band 12 QPSK 1.4MHz CH-Low, 100%RB

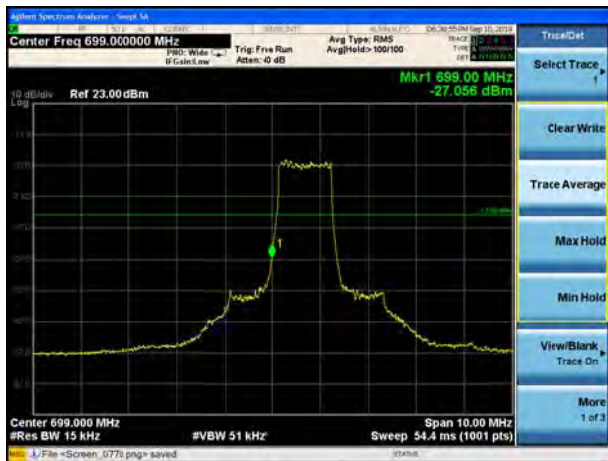

LTE Band 12 QPSK 1.4MHz CH-High, 100%RB

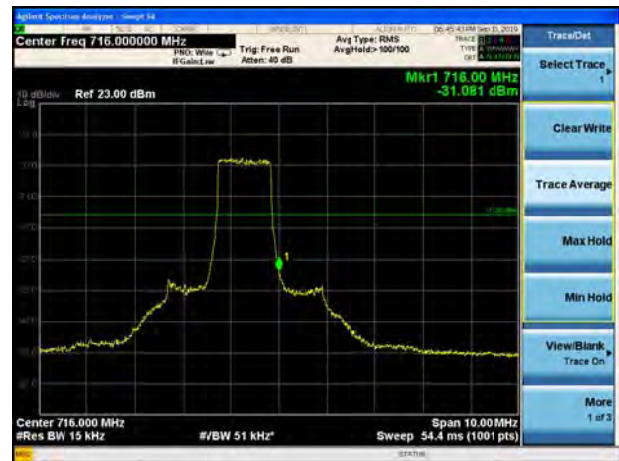

LTE Band 12 QPSK 3MHz CH-Low, 1 RB

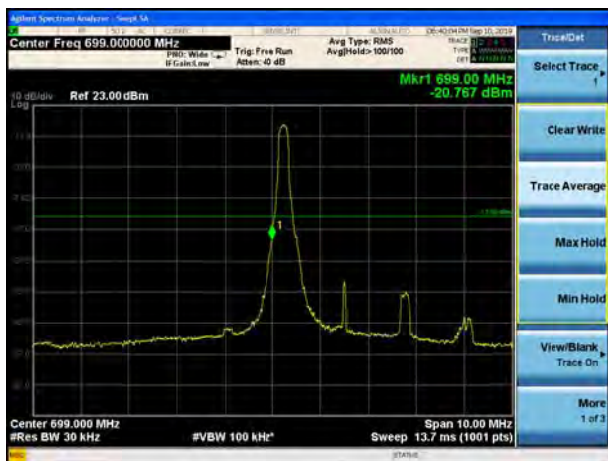

LTE Band 12 QPSK 3MHz CH-High, 1 RB

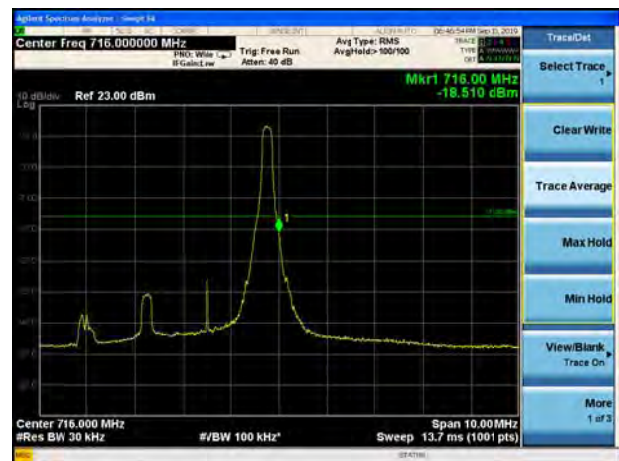



LTE Band 12 QPSK 3MHz CH-Low, 100%RB



LTE Band 12 QPSK 3MHz CH-High, 100%RB



LTE Band 12 QPSK 5MHz CH-Low, 1 RB

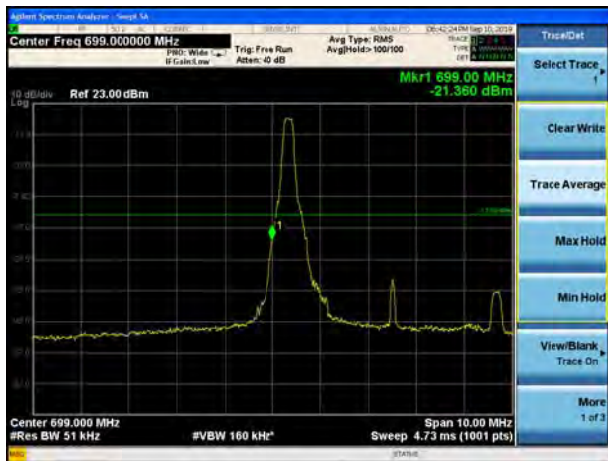

LTE Band 12 QPSK 5MHz CH-High, 1 RB

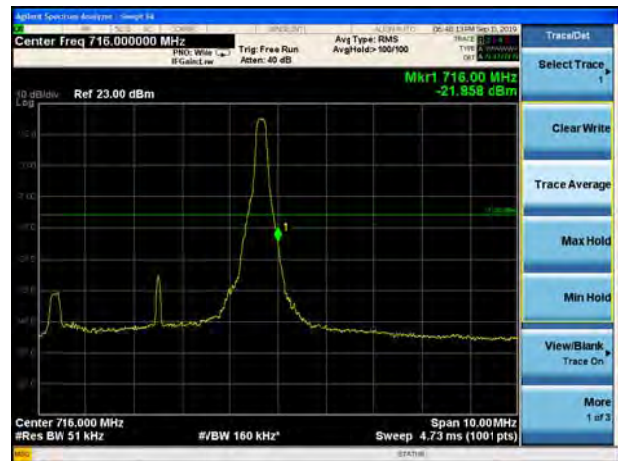

LTE Band 12 QPSK 5MHz CH-Low, 100%RB



LTE Band 12 QPSK 5MHz CH-High, 100%RB





LTE Band 12 QPSK 10MHz CH-Low, 1 RB

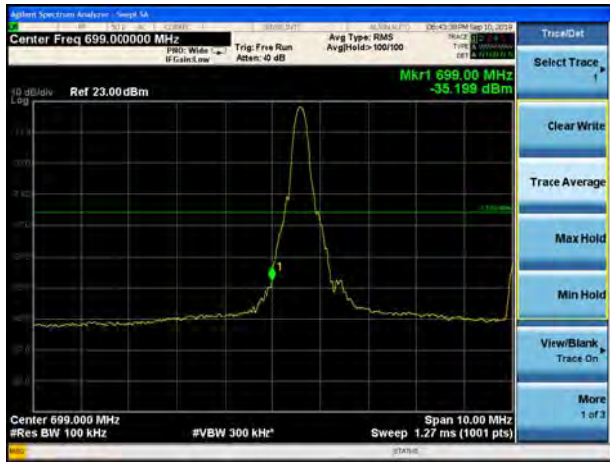

LTE Band 12 QPSK 10MHz CH-High, 1 RB

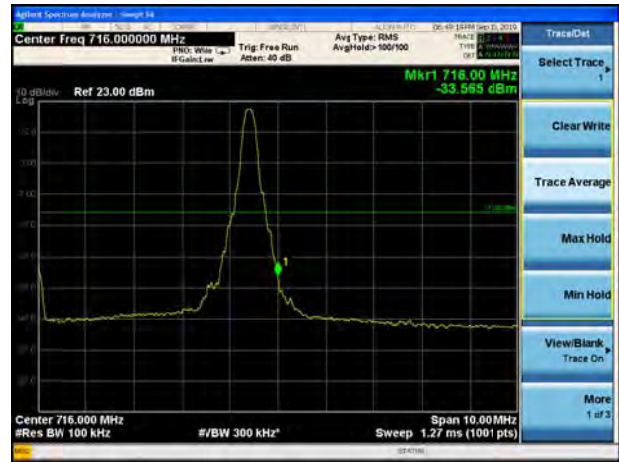

LTE Band 12 QPSK 10MHz CH-Low, 100%RB

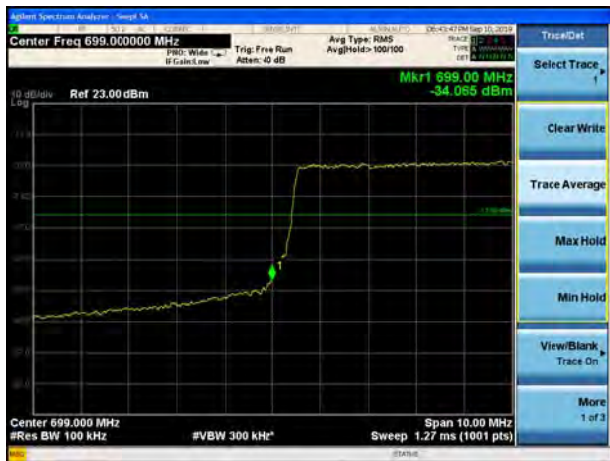

LTE Band 12 QPSK 10MHz CH-High, 100%RB

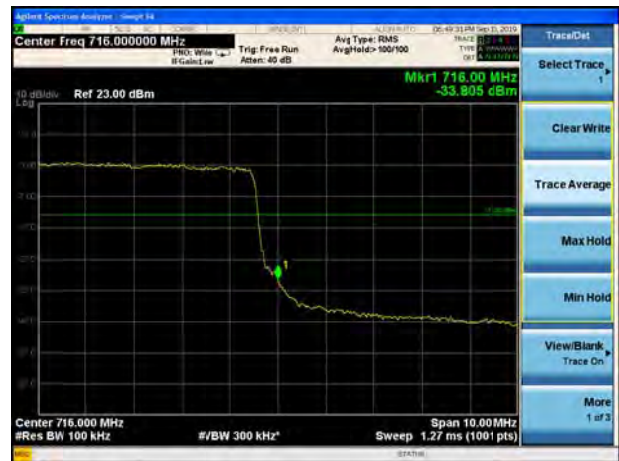

LTE Band 12 16QAM 1.4MHz CH-Low, 1 RB

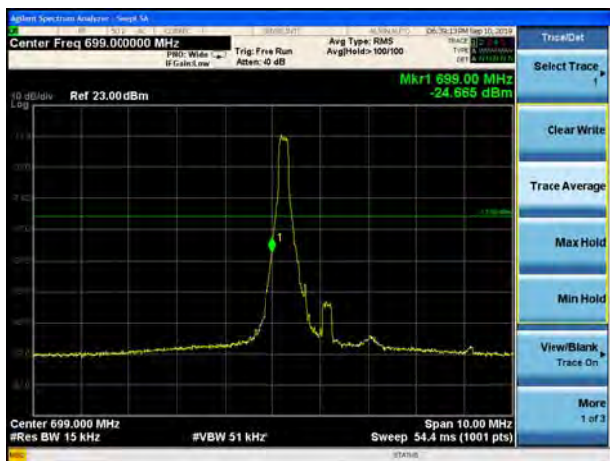

LTE Band 12 16QAM 1.4MHz CH-High, 1 RB

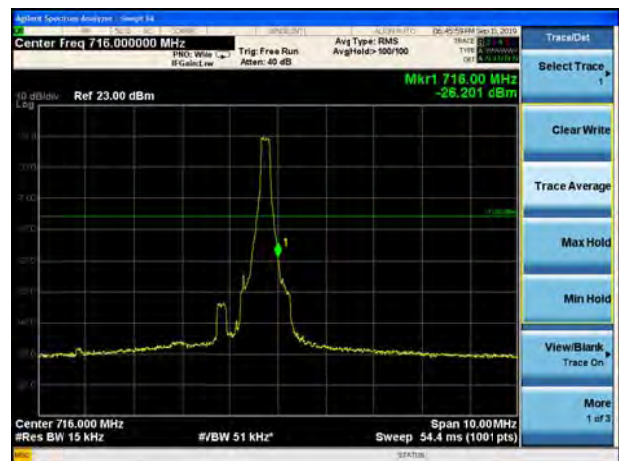



LTE Band 12 16QAM 1.4MHz CH-Low, 100%RB

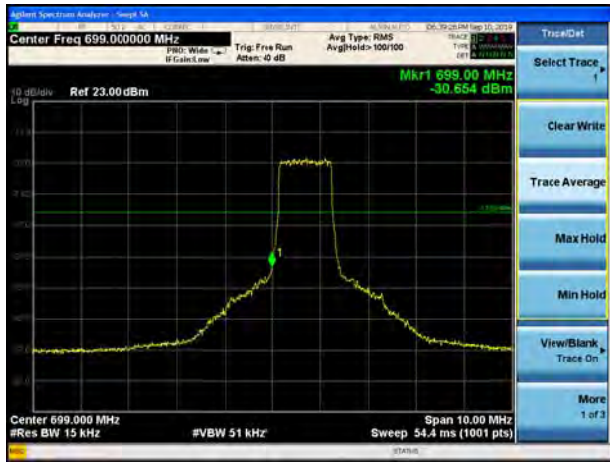

LTE Band 12 16QAM 1.4MHz CH-High, 100%RB

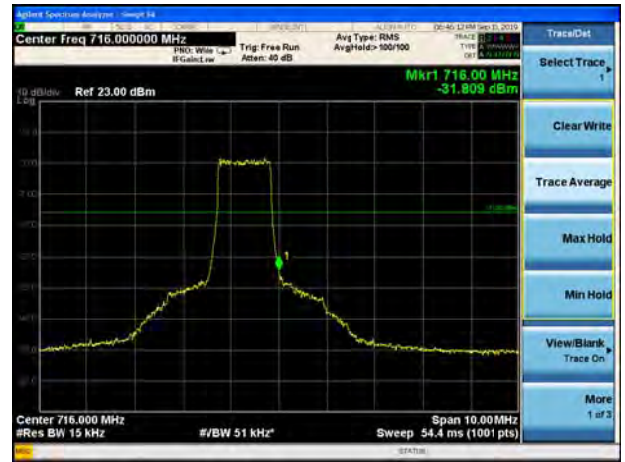

LTE Band 12 16QAM 3MHz CH-Low, 1 RB

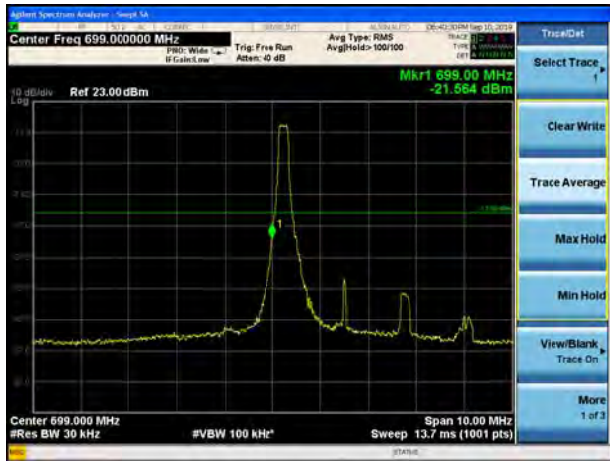

LTE Band 12 16QAM 3MHz CH-High, 1 RB

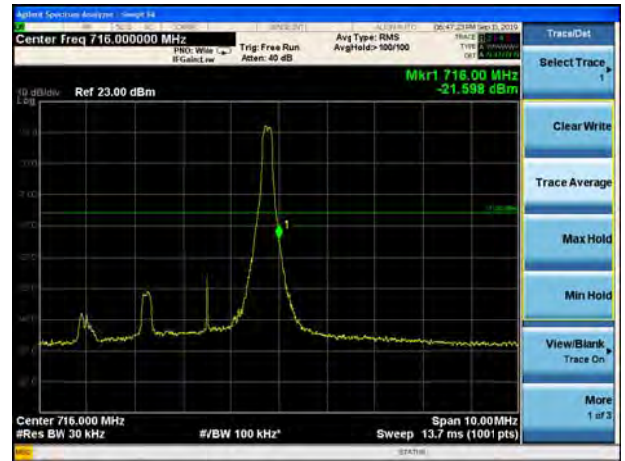

LTE Band 12 16QAM 3MHz CH-Low, 100%RB



LTE Band 12 16QAM 3MHz CH-High, 100%RB

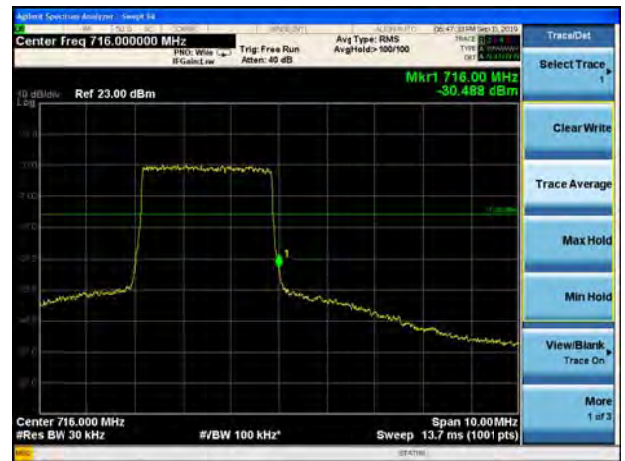



LTE Band 12 16QAM 5MHz CH-Low, 1 RB

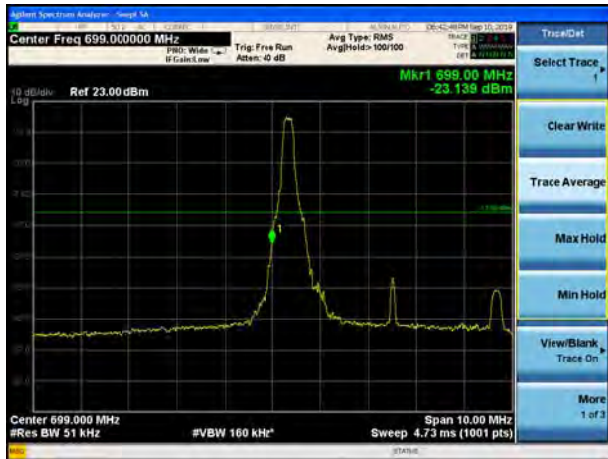

LTE Band 12 16QAM 5MHz CH-High, 1 RB

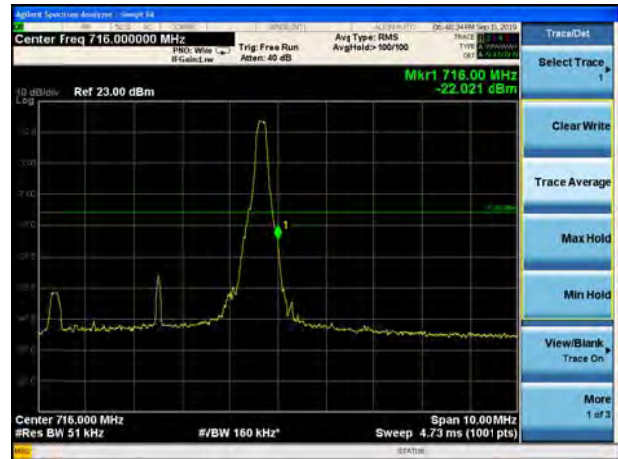

LTE Band 12 16QAM 5MHz CH-Low, 100%RB

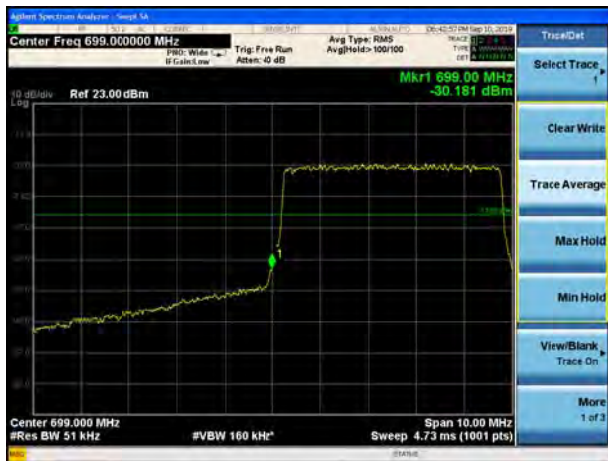

LTE Band 12 16QAM 5MHz CH-High, 100%RB



LTE Band 12 16QAM 10MHz CH-Low, 1 RB

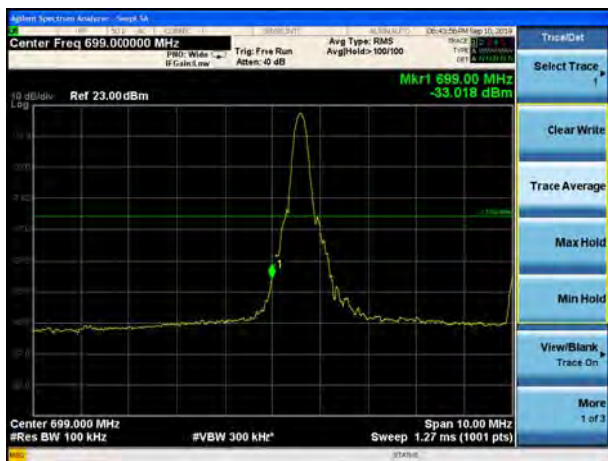

LTE Band 12 16QAM 10MHz CH-High, 1 RB

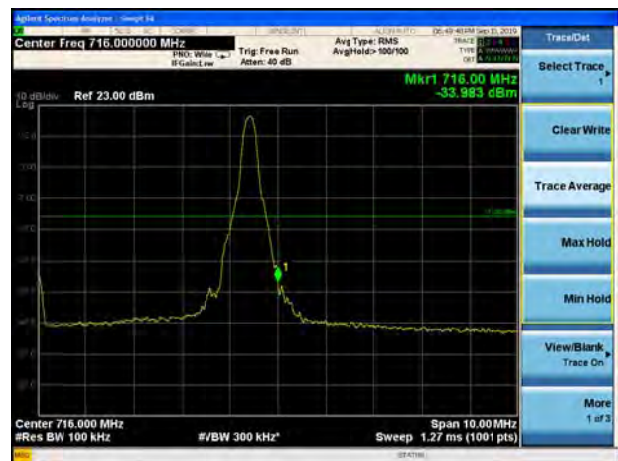



LTE Band 12 16QAM 10MHz CH-Low, 100%RB



LTE Band 12 16QAM 10MHz CH-High, 100%RB



LTE Band 13 QPSK 5MHz CH-Low, 1 RB

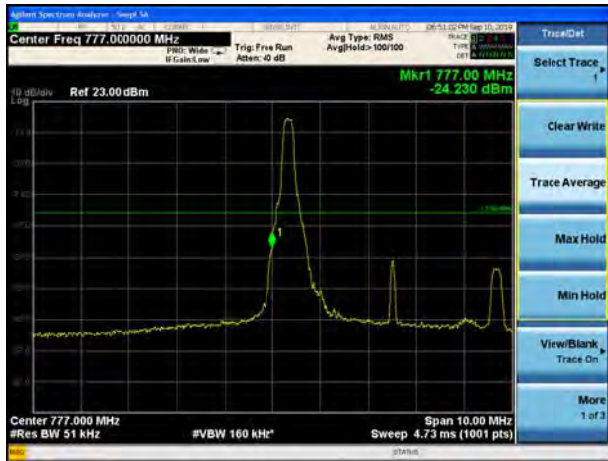

LTE Band 13 QPSK 5MHz CH-High, 1 RB

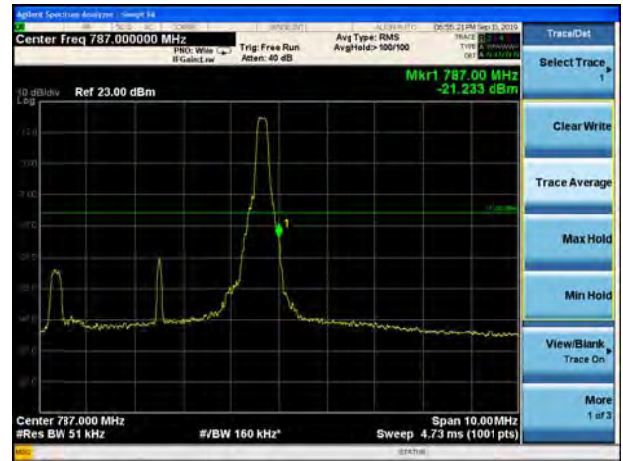

LTE Band 13 QPSK 5MHz CH-Low, 100%RB



LTE Band 13 QPSK 5MHz CH-High, 100%RB

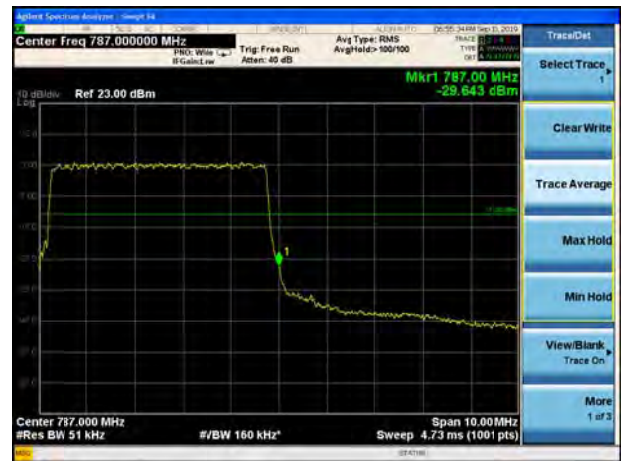



LTE Band 13 QPSK 10MHz CH-Low, 1 RB

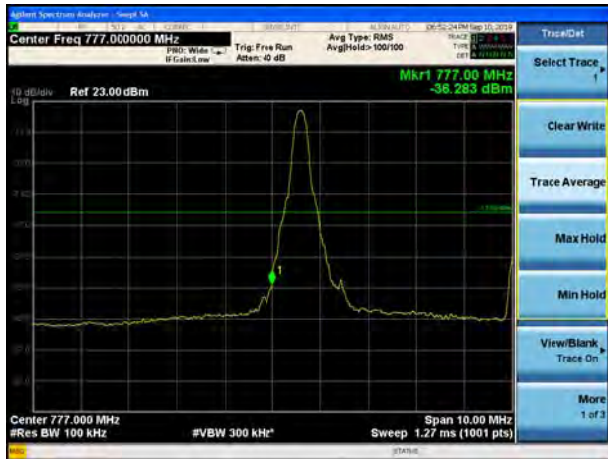

LTE Band 13 QPSK 10MHz CH-High, 1 RB

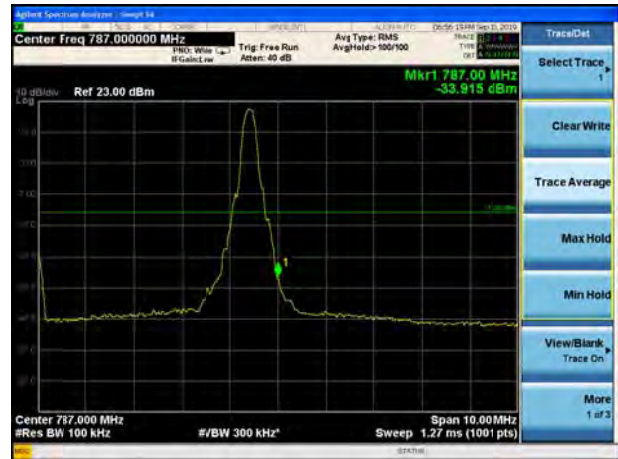

LTE Band 13 QPSK 10MHz CH-Low, 100%RB



LTE Band 13 QPSK 10MHz CH-High, 100%RB

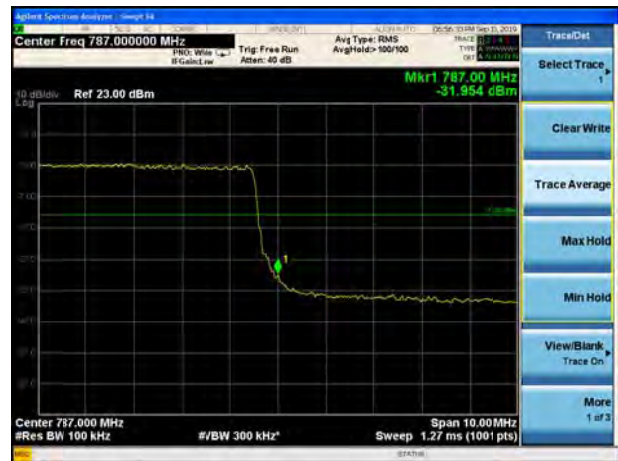

LTE Band 13 16QAM 5MHz CH-Low, 1 RB

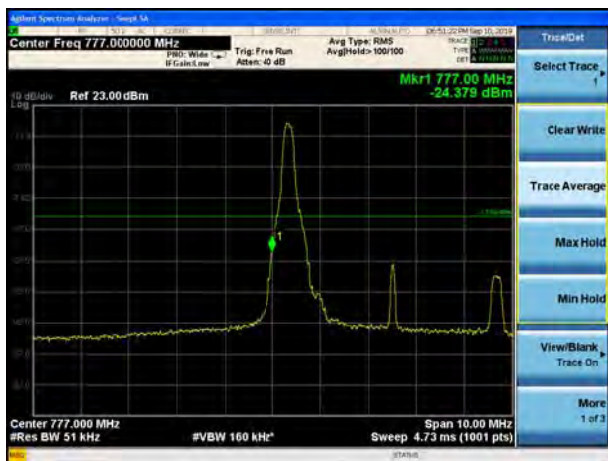

LTE Band 13 16QAM 5MHz CH-High, 1 RB

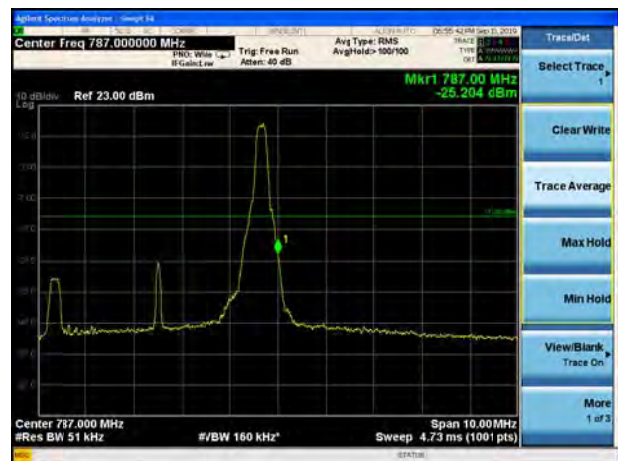



LTE Band 13 16QAM 5MHz CH-Low, 100%RB



LTE Band 13 16QAM 5MHz CH-High, 100%RB



LTE Band 13 16QAM 10MHz CH-Low, 1 RB

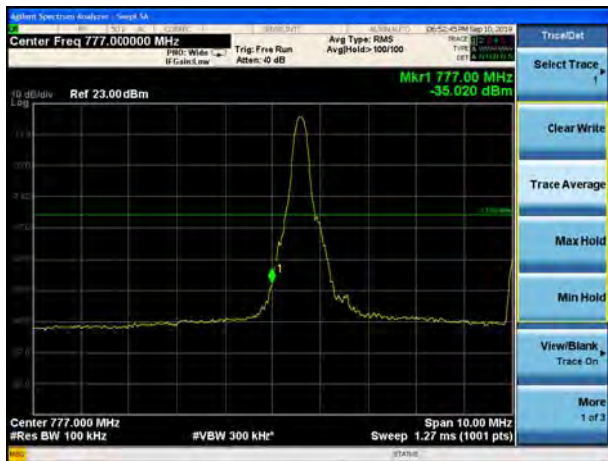

LTE Band 13 16QAM 10MHz CH-High, 1 RB

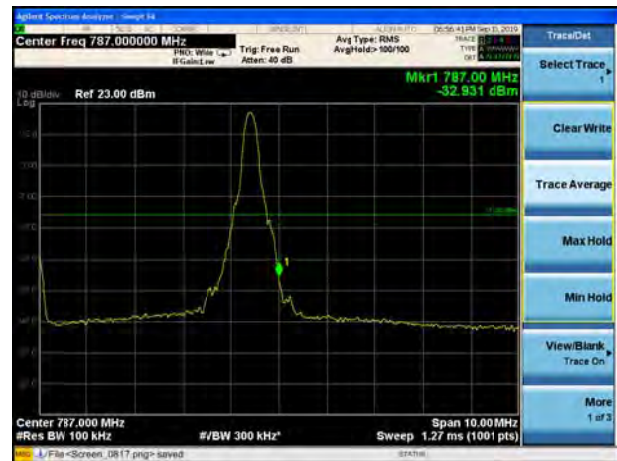

LTE Band 13 16QAM 10MHz CH-Low, 100%RB

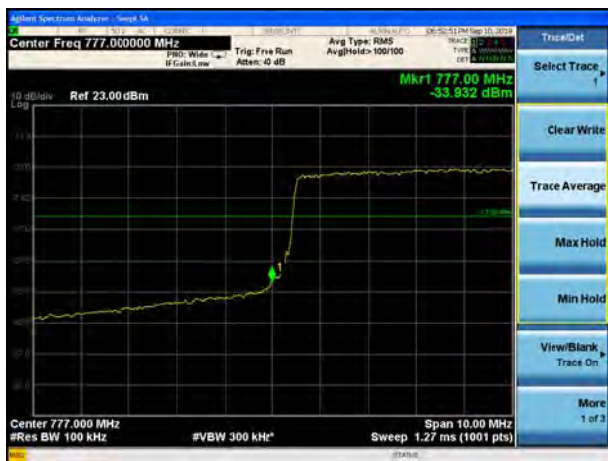

LTE Band 13 16QAM 10MHz CH-High, 100%RB





LTE Band 13 QPSK 5MHz CH-Low, 1 RB
(763MHz ~775MHz)



LTE Band 13 QPSK 5MHz CH-Low, 1 RB
(775MHz ~777MHz)

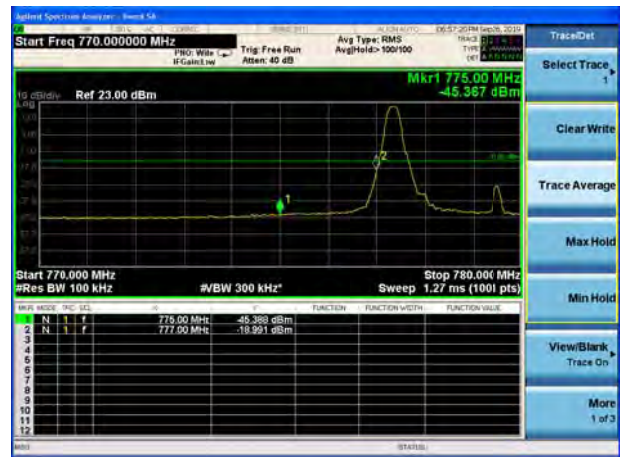

LTE Band 13 QPSK 5MHz CH-High, 1 RB
(787MHz ~793MHz)

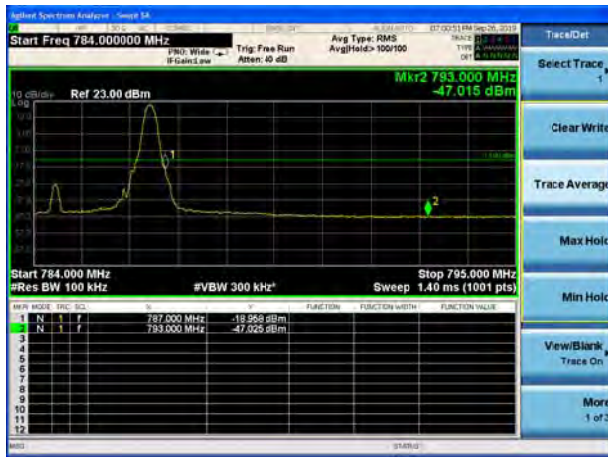

LTE Band 13 QPSK 5MHz CH-High, 1 RB
(793MHz ~805MHz)





LTE Band 13 QPSK 5MHz CH-Low, 100%RB (763MHz ~775MHz)



LTE Band 13 QPSK 5MHz CH-Low, 100%RB (775MHz ~777MHz)



LTE Band 13 QPSK 5MHz CH-High, 100%RB (787MHz ~793MHz)



LTE Band 13 QPSK 5MHz CH-High, 100%RB (793MHz ~805MHz)





LTE Band 13 QPSK 10MHz CH-Low, 1 RB
(763MHz ~775MHz)



LTE Band 13 QPSK 10MHz CH-Low, 1 RB
(775MHz ~777MHz)

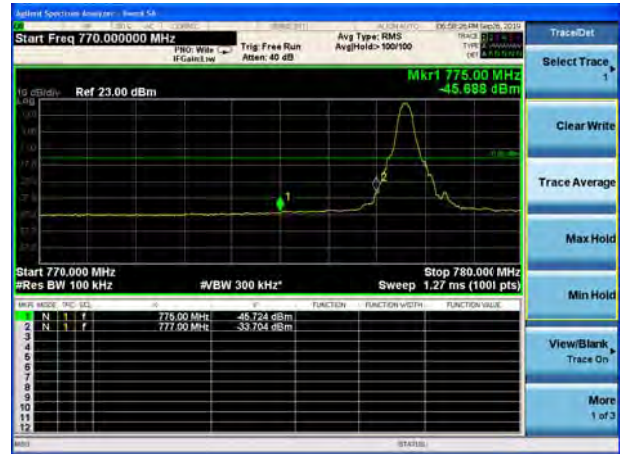

LTE Band 13 QPSK 10MHz CH-High, 1 RB
(787MHz ~793MHz)

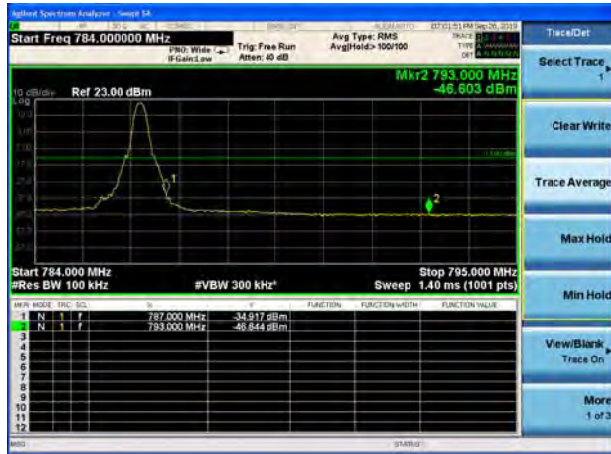

LTE Band 13 QPSK 10MHz CH-High, 1 RB
(793MHz ~805MHz)





LTE Band 13 QPSK 10MHz CH-Low, 100%RB (763MHz ~775MHz)



LTE Band 13 QPSK 10MHz CH-Low, 100%RB (775MHz ~777MHz)



LTE Band 13 QPSK 10MHz CH-High, 100%RB (787MHz ~793MHz)



LTE Band 13 QPSK 10MHz CH-High, 100%RB (793MHz ~805MHz)





LTE Band 13 16QAM 5MHz CH-Low, 1 RB
(763MHz ~775MHz)

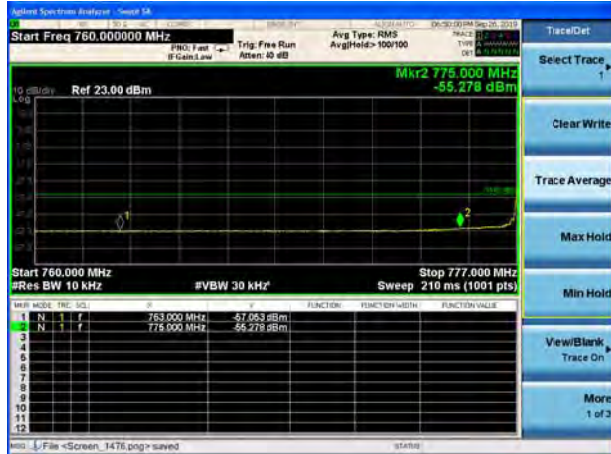

LTE Band 13 16QAM 5MHz CH-Low, 1 RB
(775MHz ~777MHz)

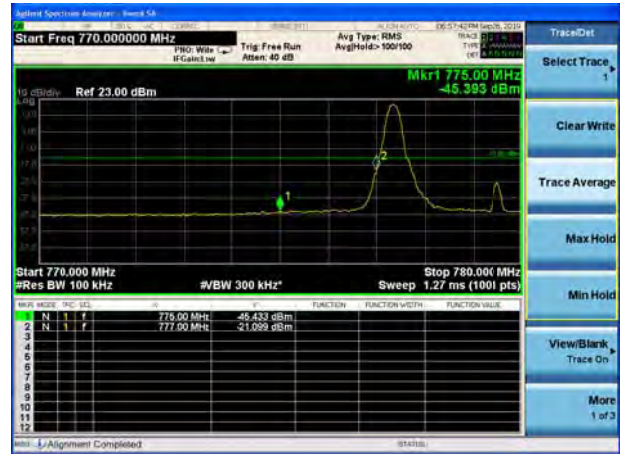

LTE Band 13 16QAM 5MHz CH-High, 1 RB
(787MHz ~793MHz)

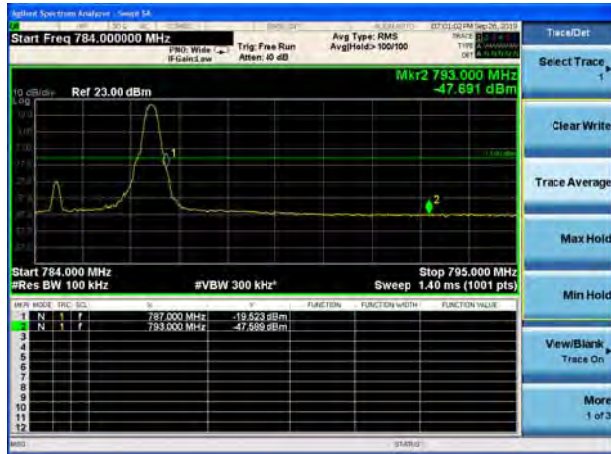

LTE Band 13 16QAM 5MHz CH-High, 1 RB
(793MHz ~805MHz)





LTE Band 13 16QAM 5MHz CH-Low, 100%RB (763MHz ~775MHz)



LTE Band 13 16QAM 5MHz CH-Low, 100%RB (775MHz ~777MHz)



LTE Band 13 16QAM 5MHz CH-High, 100%RB (787MHz ~793MHz)



LTE Band 13 16QAM 5MHz CH-High, 100%RB (793MHz ~805MHz)





LTE Band 13 16QAM 10MHz CH-Low, 1 RB
(763MHz ~775MHz)



LTE Band 13 16QAM 10MHz CH-Low, 1 RB
(775MHz ~777MHz)

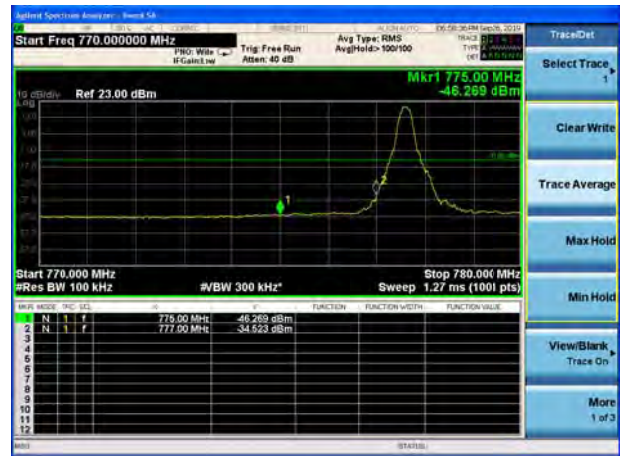

LTE Band 13 16QAM 10MHz CH-High, 1 RB
(787MHz ~793MHz)

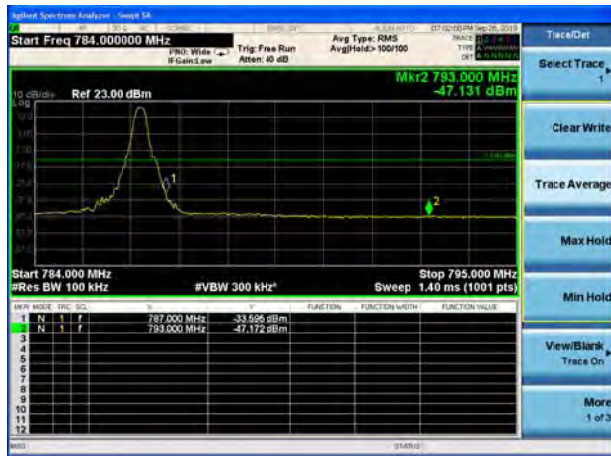

LTE Band 13 16QAM 10MHz CH-High, 1 RB
(793MHz ~805MHz)





LTE Band 13 16QAM 10MHz CH-Low, 100%RB (763MHz ~775MHz)



LTE Band 13 16QAM 10MHz CH-Low, 100%RB (775MHz ~777MHz)



LTE Band 13 16QAM 10MHz CH-High, 100%RB (787MHz ~793MHz)

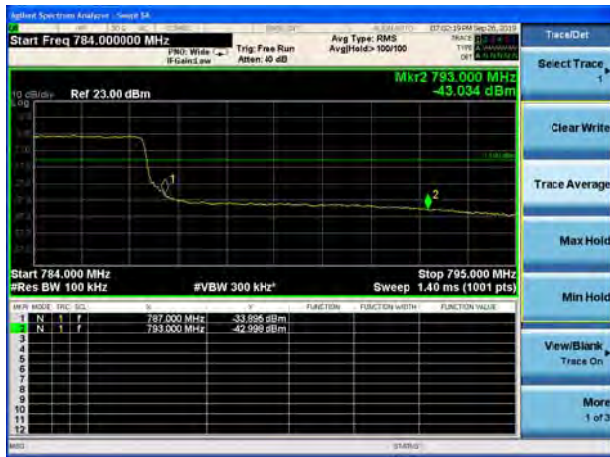

LTE Band 13 16QAM 10MHz CH-High, 100%RB (793MHz ~805MHz)





LTE Band 17 QPSK 5MHz CH-Low, 1 RB



LTE Band 17 QPSK 5MHz CH-High, 1 RB

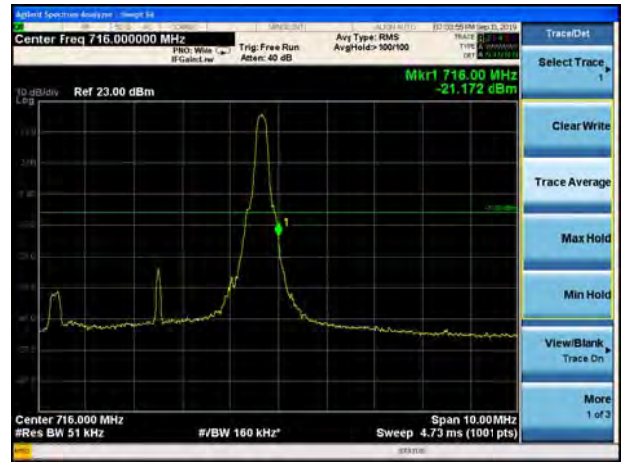

LTE Band 17 QPSK 5MHz CH-Low, 100%RB

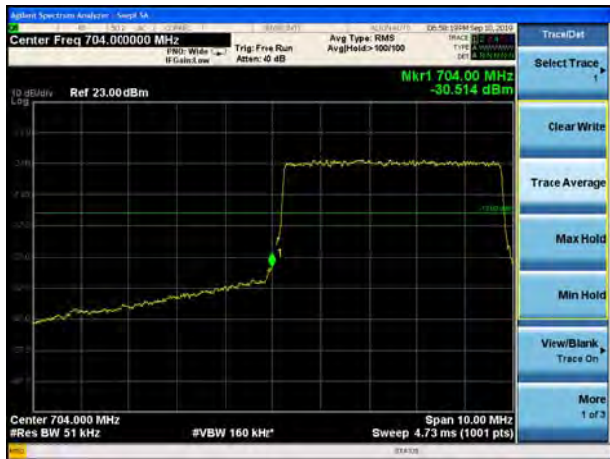

LTE Band 17 QPSK 5MHz CH-High, 100%RB

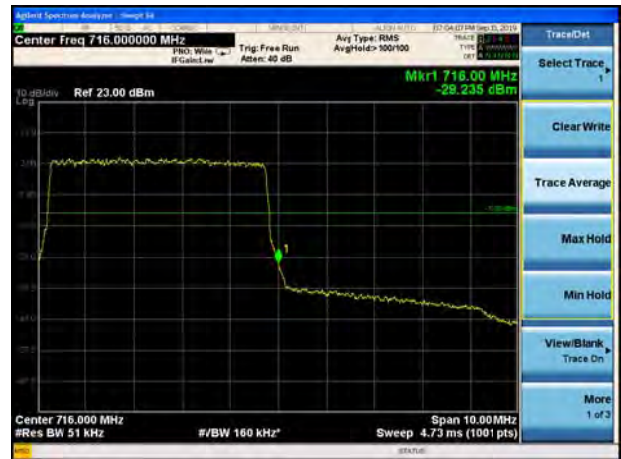

LTE Band 17 QPSK 10MHz CH-Low, 1 RB

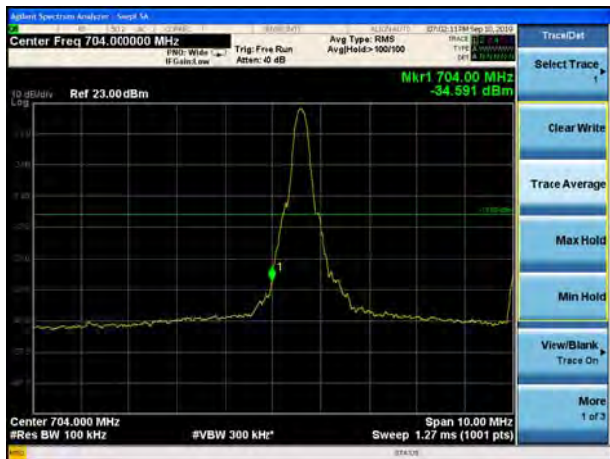

LTE Band 17 QPSK 10MHz CH-High, 1 RB

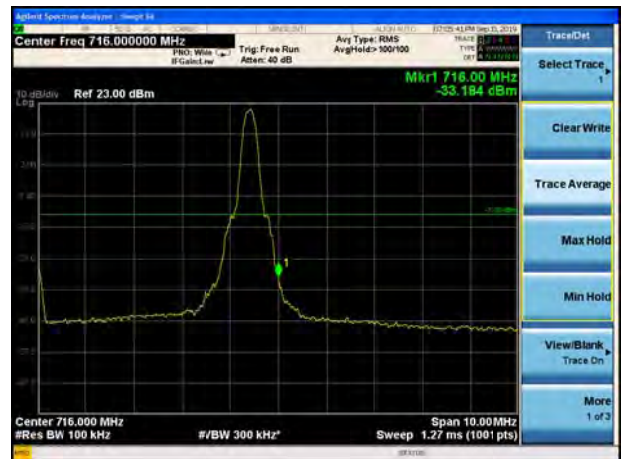



LTE Band 17 QPSK 10MHz CH-Low, 100%RB



LTE Band 17 QPSK 10MHz CH-High, 100%RB



LTE Band 17 16QAM 5MHz CH-Low, 1 RB

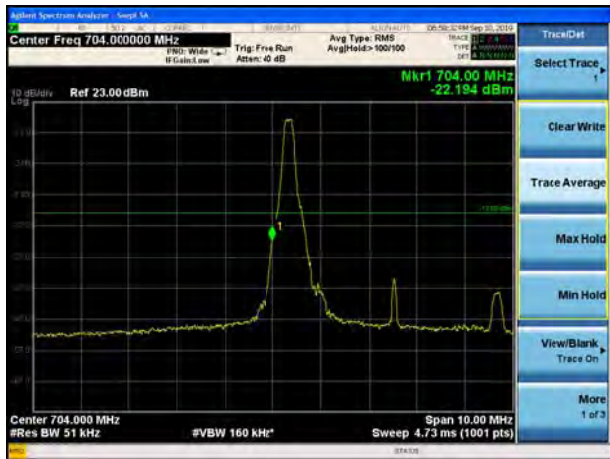

LTE Band 17 16QAM 5MHz CH-High, 1 RB

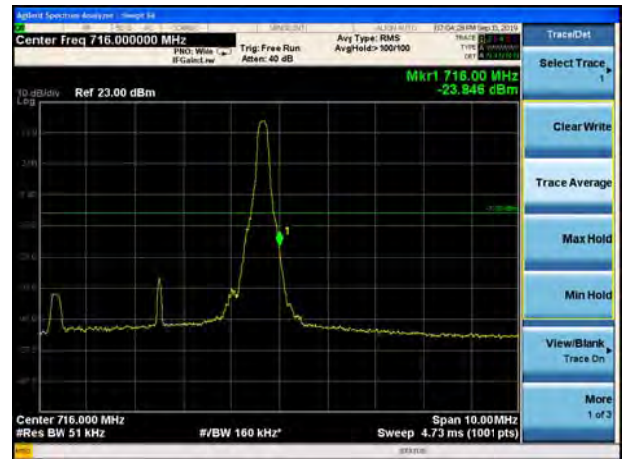

LTE Band 17 16QAM 5MHz CH-Low, 100%RB



LTE Band 17 16QAM 5MHz CH-High, 100%RB

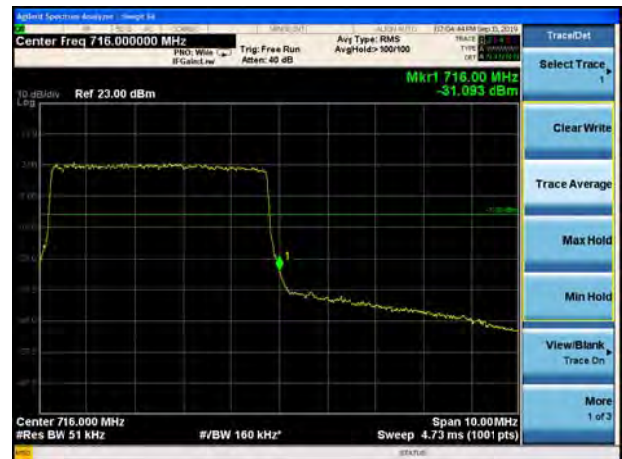



LTE Band 17 16QAM 10MHz CH-Low, 1 RB

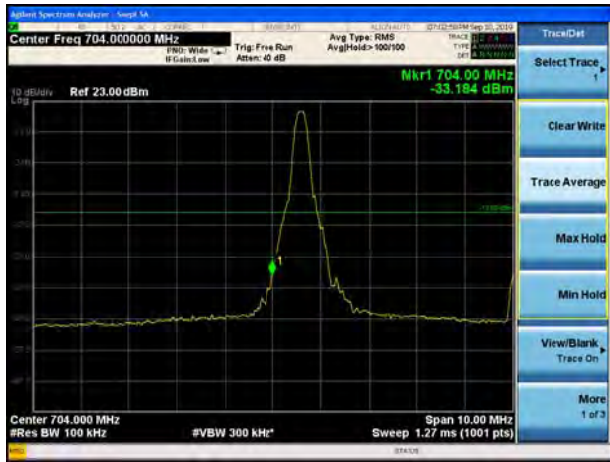

LTE Band 17 16QAM 10MHz CH-High, 1 RB

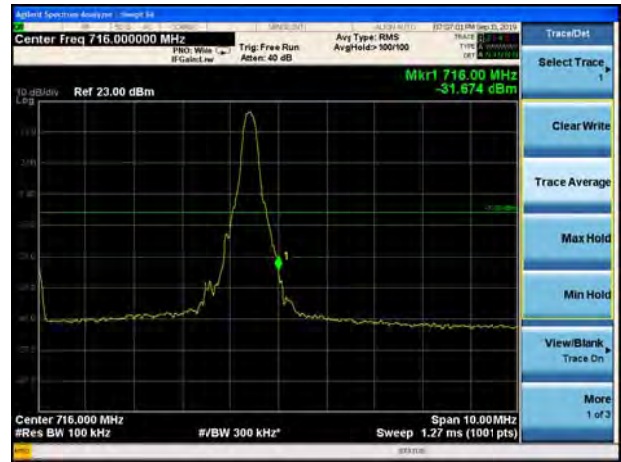

LTE Band 17 16QAM 10MHz CH-Low, 100%RB



LTE Band 17 16QAM 10MHz CH-High, 100%RB





LTE Band 41 QPSK 5MHz CH-Low, 1 RB

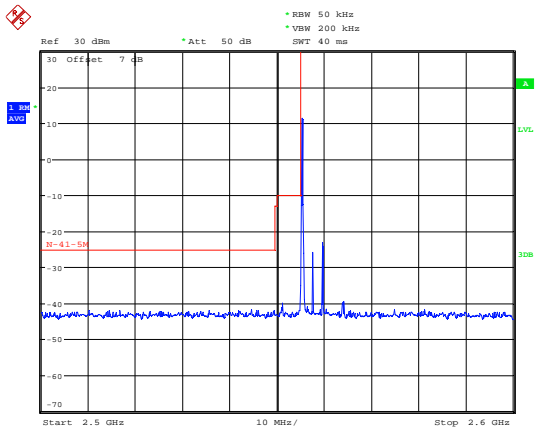

Date: 19.SEP.2019 12:31:51

LTE Band 41 QPSK 5MHz CH-High, 1 RB

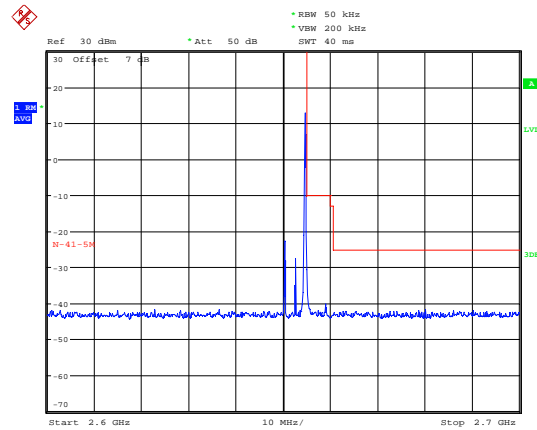

Date: 19.SEP.2019 12:43:29

LTE Band 41 QPSK 5MHz CH-Low, 100%RB

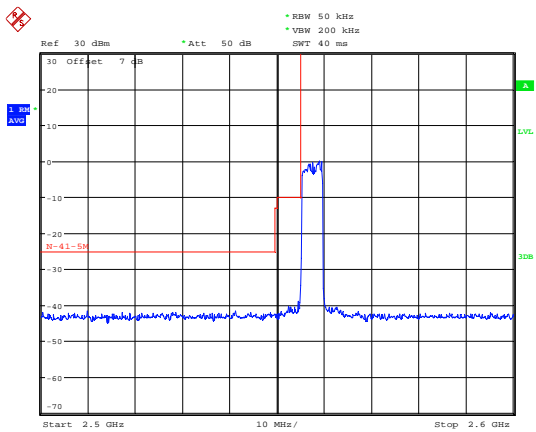

Date: 19.SEP.2019 12:32:54

LTE Band 41 QPSK 5MHz CH-High, 100%RB

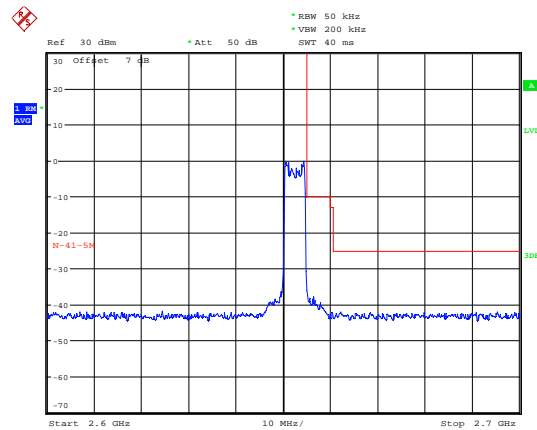

Date: 19.SEP.2019 12:43:42

LTE Band 41 QPSK 10MHz CH-Low, 1 RB

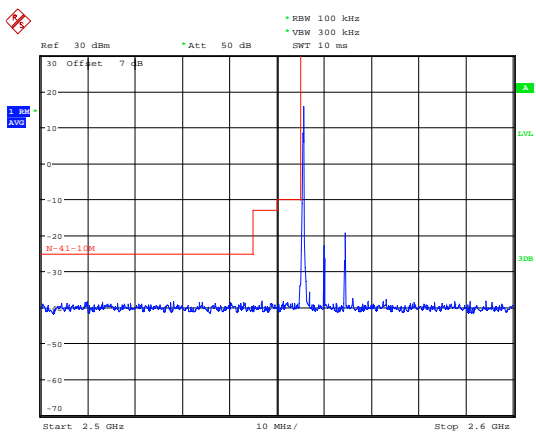

Date: 19.SEP.2019 12:45:36

LTE Band 41 QPSK 10MHz CH-High, 1 RB

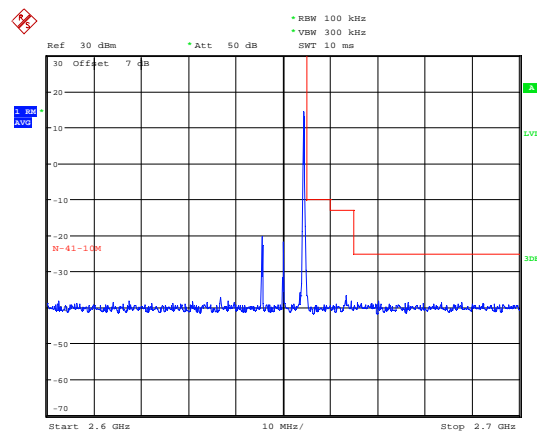

Date: 19.SEP.2019 12:47:20



LTE Band 41 QPSK 10MHz CH-Low, 100%RB

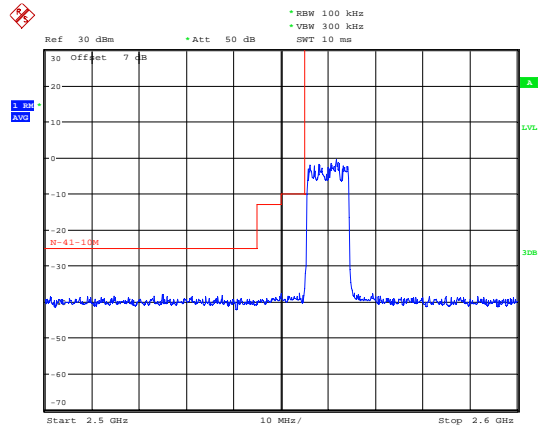

Date: 19.SEP.2019 12:46:02

LTE Band 41 QPSK 10MHz CH-High, 100%RB

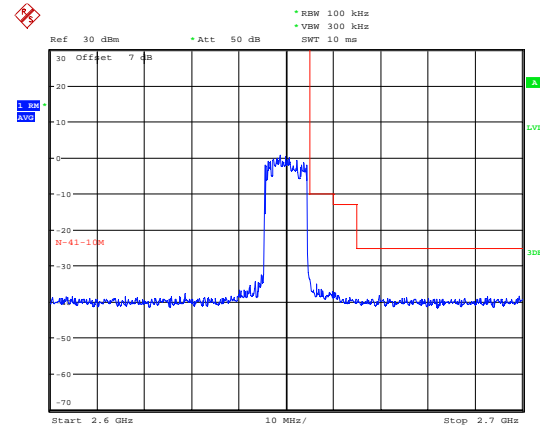

Date: 19.SEP.2019 12:47:32

LTE Band 41 QPSK 15MHz CH-Low, 1 RB

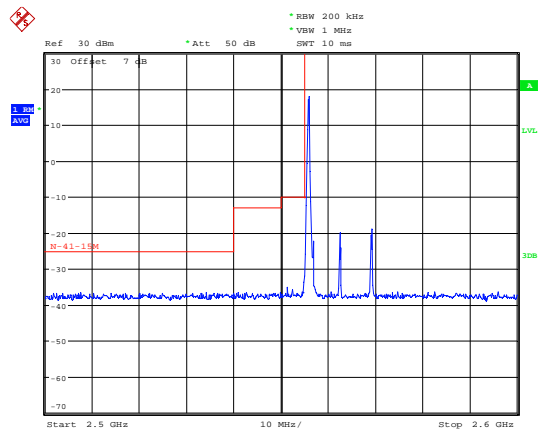

Date: 19.SEP.2019 12:49:13

LTE Band 41 QPSK 15MHz CH-High, 1 RB

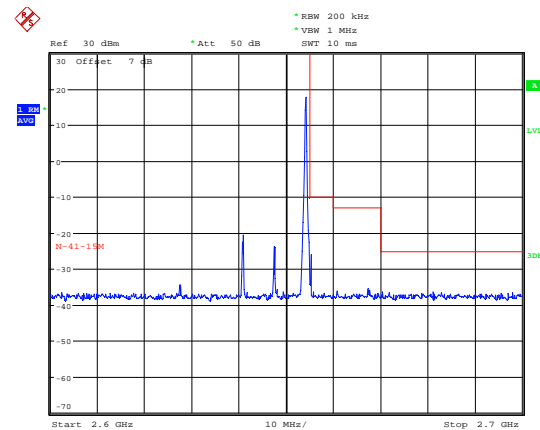

Date: 19.SEP.2019 12:50:32

LTE Band 41 QPSK 15MHz CH-Low, 100%RB

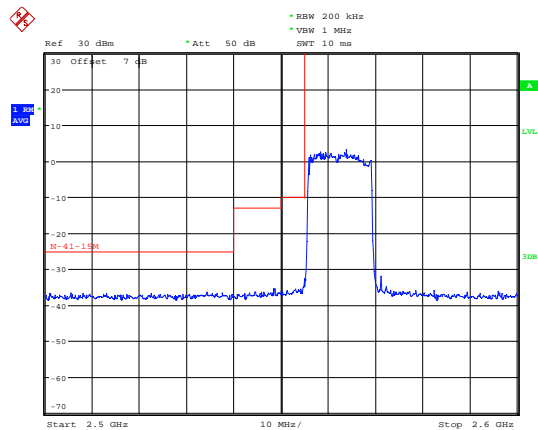

Date: 19.SEP.2019 12:49:23

LTE Band 41 QPSK 15MHz CH-High, 100%RB

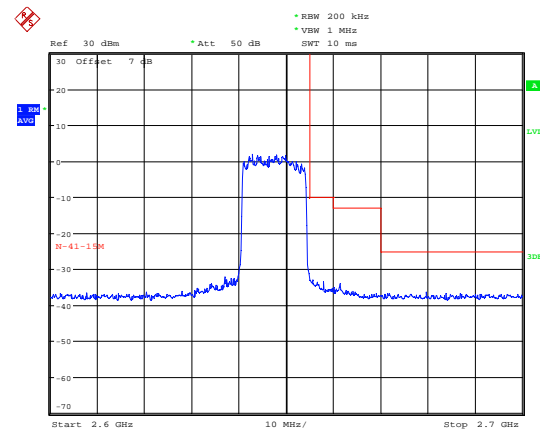

Date: 19.SEP.2019 12:50:42



LTE Band 41 QPSK 20MHz CH-Low, 1 RB

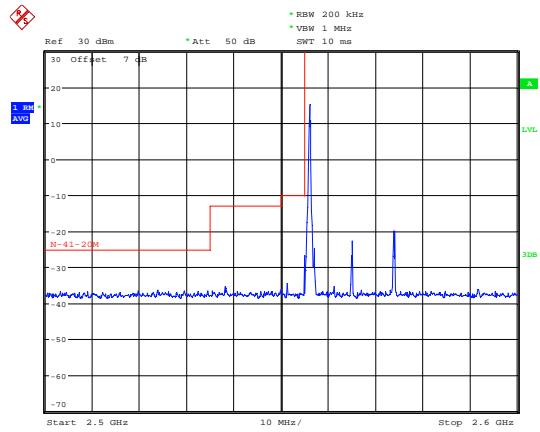

Date: 19.SEP.2019 12:51:55

LTE Band 41 QPSK 20MHz CH-High, 1 RB

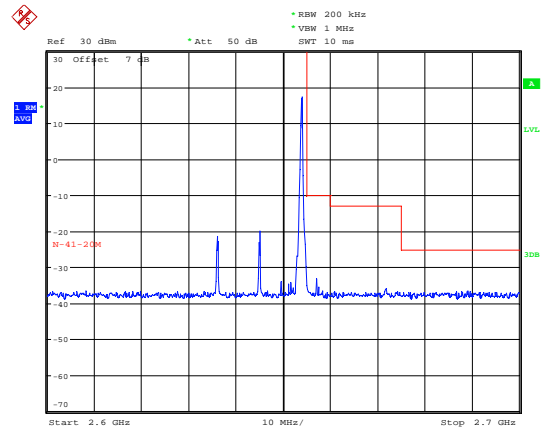

Date: 19.SEP.2019 12:53:00

LTE Band 41 QPSK 20MHz CH-Low, 100%RB

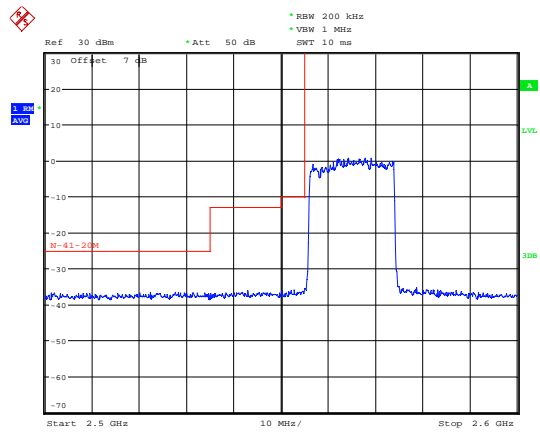

Date: 19.SEP.2019 12:52:08

LTE Band 41 QPSK 20MHz CH-High, 100%RB

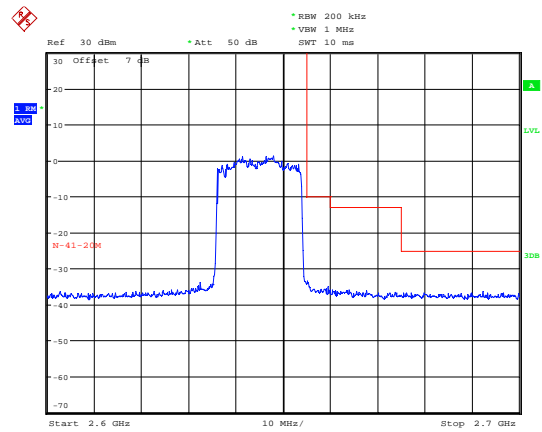

Date: 19.SEP.2019 12:53:09

LTE Band 41 16QAM 5MHz CH-Low, 1 RB

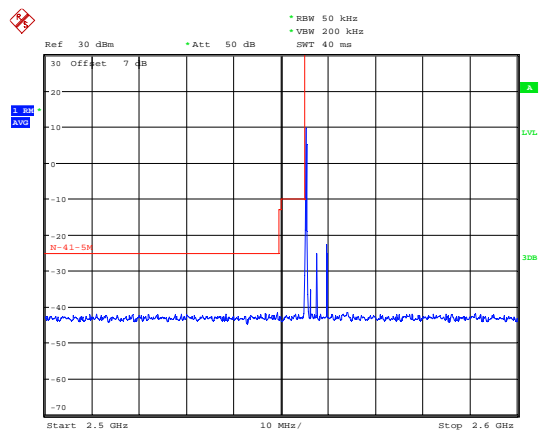

Date: 19.SEP.2019 12:40:11

LTE Band 41 16QAM 5MHz CH-High, 1 RB

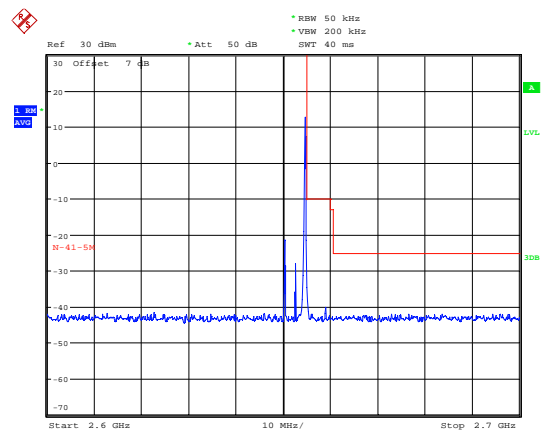

Date: 19.SEP.2019 12:43:55



LTE Band 41 16QAM 5MHz CH-Low, 100%RB

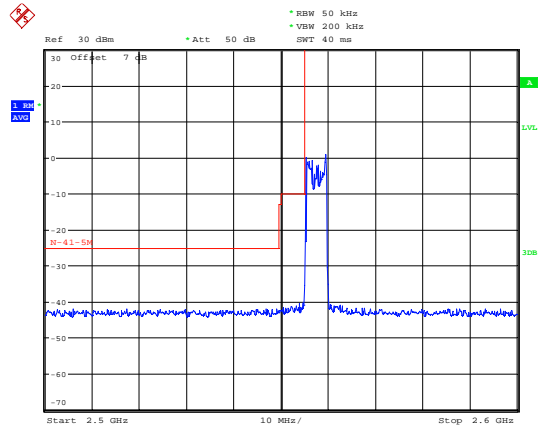

LTE Band 41 16QAM 5MHz CH-High, 100%RB

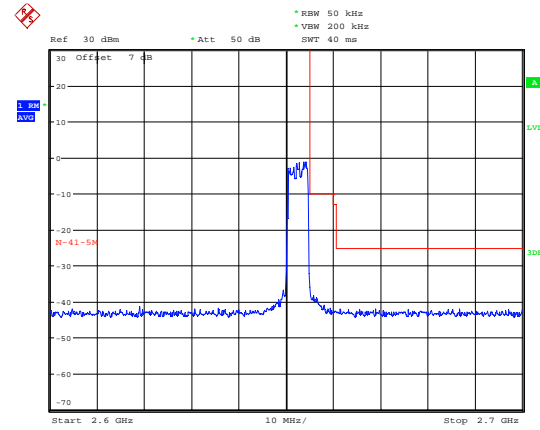

LTE Band 41 16QAM 10MHz CH-Low, 1 RB

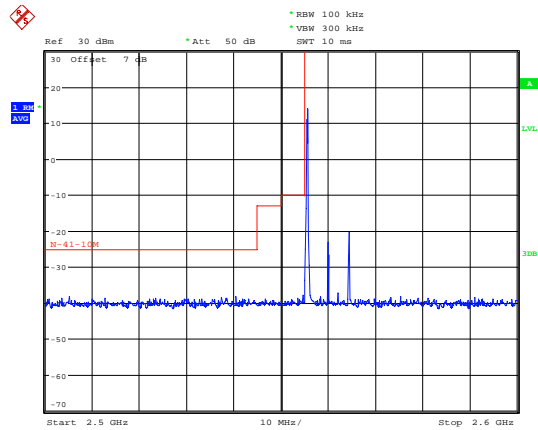

LTE Band 41 16QAM 10MHz CH-High, 1 RB

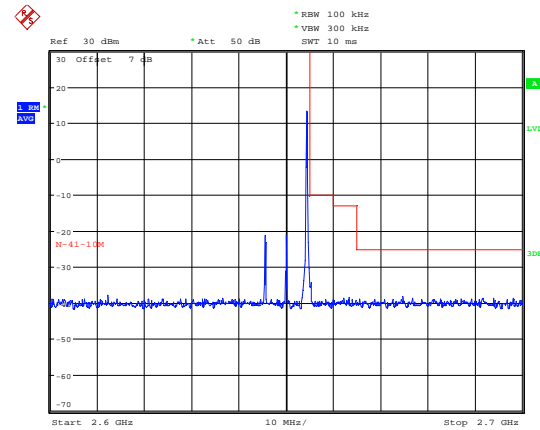

LTE Band 41 16QAM 10MHz CH-Low, 100%RB

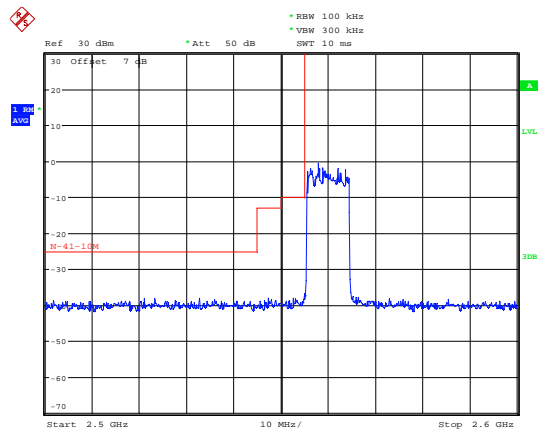

LTE Band 41 16QAM 10MHz CH-High, 100%RB

