

RADIO TEST REPORT

FCC 47 CFR PART 15 SUBPART E

INDUSTRY CANADA RSS-247

Test Standard	FCC Part 15.407+ RSS-247 issue 2 and RSS-GEN issue 5
Brand name	ICON/iFit
Product name	Tablet
Model No.	MP7-ARGON2X-C
Test Result	Pass
Statements of Conformity	Determination of compliance is based on the results of the compliance measurement, not taking into account measurement instrumentation uncertainty.

The test Result was tested by Compliance Certification Services Inc. The test data, data evaluation, test procedures, and equipment configurations shown in this report were given in ANSI C63.10: 2013 and compliance standards.

The test results of this report relate only to the tested sample (EUT) identified in this report.

The test Report of full or partial shall not copy. Without written approval of Compliance Certification Services Inc.(Wugu Laboratory)

Approved by:



Kevin Tsai
Deputy Manager

Unless otherwise stated the results shown in this test report refer only to the sample(s) tested and such sample(s) are retained for 90 days only.
除非另有說明，此報告結果僅對測試之樣品負責，同時此樣品僅保留90天。本報告未經本公司書面許可，不可部份複製。

This document is issued by the Company subject to its General Conditions of Service printed overleaf, available on request or accessible at <http://www.sgs.com.tw/Terms-and-Conditions> and, for electronic format documents, subject to Terms and Conditions for Electronic Documents at <http://www.sgs.com.tw/Terms-and-Conditions>. Attention is drawn to the limitation of liability, indemnification and jurisdiction issues defined therein. Any holder of this document is advised that information contained hereon reflects the Company's findings at the time of its intervention only and within the limits of client's instruction, if any. The Company's sole responsibility is to its Client and this document does not exonerate parties to a transaction from exercising all their rights and obligations under the transaction documents. This document cannot be reproduced, except in full, without prior written approval of the Company. Any unauthorized alteration, forgery or falsification of the content or appearance of this document is unlawful and offenders may be prosecuted to the fullest extent of the law.

Revision History

Rev.	Issue Date	Revisions	Effect Page	Revised By
00	October 5, 2021	Initial Issue	ALL	Allison Chen

Table of contents

1. GENERAL INFORMATION	4
1.1 EUT INFORMATION	4
1.2 EUT CHANNEL INFORMATION	5
1.3 ANTENNA INFORMATION	6
1.4 MEASUREMENT UNCERTAINTY	6
1.5 FACILITIES AND TEST LOCATION	7
1.6 INSTRUMENT CALIBRATION	7
1.7 SUPPORT AND EUT ACCESSORIES EQUIPMENT	8
1.8 TEST METHODOLOGY AND APPLIED STANDARDS	8
2. TEST SUMMARY	9
3. DESCRIPTION OF TEST MODES	10
3.1 THE EUT CHANNEL NUMBER OF OPERATING CONDITION	10
3.2 THE WORST MODE OF MEASUREMENT	11
4. TEST RESULT	12
4.1 RADIATION SPURIOUS EMISSION	12
4.2 OUTPUT POWER MEASUREMENT	21
4.3 TEST DATA RE-USE SUMMARY	25
APPENDIX-A TEST PHOTO	A-1
APPENDIX 1 - PHOTOGRAPHS OF EUT	

1. GENERAL INFORMATION

1.1 EUT INFORMATION

FCC Applicant	Compal Electronics Inc No.581 & 581-1, Ruiguang Rd., Neihu District, Taipei city, 11492 Taiwan
IC Applicant	COMPAL ELECTRONICS INC. No. 581 & 581-1, Ruiguang Rd., Neihu District Taipei R.O.C. 114 Taiwan
Manufacturer	Compal Electronics Inc No.581 & 581-1, Ruiguang Rd., Neihu District, Taipei city, 11492 Taiwan
Equipment	Tablet
Model No.	MP7-ARGON2X-C
Model Discrepancy	N/A
Trade Name	ICON/iFit
Received Date	July 30, 2021
Date of Test	September 17 ~ 22, 2021
Power Operation	EUT Power from Power Supply. (DC12V)
HW Version	LA-L511P
SW Version	Android 9
EUT Serial #	Conducted Emission: PP41D304791 Radiated Emission: PP41D304792

Remark:

1. For more details, refer to the User's manual of the EUT.
2. Disclaimer: Antenna information is provided by the applicant, test results of this report are applicable to the sample EUT received.

1.2 EUT CHANNEL INFORMATION

Frequency Range	UNII-1	
	IEEE 802.11a	5180 ~ 5240 MHz
	IEEE 802.11n HT 20 MHz	5180 ~ 5240 MHz
	IEEE 802.11n HT 40 MHz	5190 ~ 5230 MHz
	UNII-2a	
	IEEE 802.11a	5260 ~ 5320 MHz
	IEEE 802.11n HT 20 MHz	5260 ~ 5320 MHz
	IEEE 802.11n HT 40 MHz	5270 ~ 5310 MHz
	UNII-2c	
	IEEE 802.11a	5500 ~ 5700 MHz
	IEEE 802.11n HT 20 MHz	5500 ~ 5720 MHz
	IEEE 802.11n HT 40 MHz	5510 ~ 5710 MHz
	UNII-3	
	IEEE 802.11a	5745 ~ 5825 MHz
	IEEE 802.11n HT 20 MHz	5745 ~ 5825 MHz
IEEE 802.11n HT 40 MHz	5755 ~ 5795 MHz	
Modulation Type	1. IEEE 802.11a mode: OFDM 2. IEEE 802.11n HT 20 MHz mode: OFDM 3. IEEE 802.11n HT 40 MHz mode: OFDM	

Remark:

Refer as ANSI C63.10: 2013 clause 5.6.1 Table 4 for test channels

Number of frequencies to be tested		
Frequency range in which device operates	Number of frequencies	Location in frequency range of operation
<input type="checkbox"/> 1 MHz or less	1	Middle
<input type="checkbox"/> 1 MHz to 10 MHz	2	1 near top and 1 near bottom
<input checked="" type="checkbox"/> More than 10 MHz	3	1 near top, 1 near middle, and 1 near bottom

Report No.: T210730W05-RP4

1.3 ANTENNA INFORMATION

Antenna Type	<input checked="" type="checkbox"/> PIFA <input type="checkbox"/> PCB <input type="checkbox"/> Dipole <input type="checkbox"/> Coils	
Antenna Gain	Band	Gain (dBi)
	Band 1	5.09
	Band 2a	5.09
	Band 2c	3.12
	Band 3	2.74
Antenna Connector	IPEX	

Remark:

1.The antenna(s) of the EUT are permanently attached and there are no provisions for connection to an external antenna. So the EUT complies with the requirements of §15.203.

1.4 MEASUREMENT UNCERTAINTY

PARAMETER	UNCERTAINTY
AC Powerline Conducted Emission	+/- 1.2575
Emission bandwidth, 20dB bandwidth	+/- 0.0014
RF output power, conducted	+/- 1.14
Power density, conducted	+/- 1.40
3M Semi Anechoic Chamber / 30M~1G (Horizontally)	+/- 3.91
3M Semi Anechoic Chamber / 30M~1G (Vertically)	+/- 4.57
3M Semi Anechoic Chamber / 1G~6G	+/- 5.20
3M Semi Anechoic Chamber / 6G~18G	+/- 5.18
3M Semi Anechoic Chamber / 18G~40G	+/- 3.68

Remark:

1.This uncertainty represents an expanded uncertainty expressed at approximately the 95% confidence level using a coverage factor of k=2

2. ISO/IEC 17025 requires that an estimate of the measurement uncertainties associated with the emissions test results be included in the report.

Report No.: T210730W05-RP4

1.5 FACILITIES AND TEST LOCATION

All measurement facilities used to collect the measurement data are located at No.11, Wugong 6th Rd., Wugu Dist., New Taipei City, Taiwan. (R.O.C.)

Test site	Test Engineer	Remark
AC Conduction Room	N/A	Not applicable, because EUT doesn't connect to AC Main Source direct.
Radiation	Ray Li	-
RF Conducted	Lance Chen	-

Remark: The sites are constructed in conformance with the requirements of ANSI C63.7, ANSI C63.4 and CISPR Publication 22.

1.6 INSTRUMENT CALIBRATION

3M 966 Chamber Test Site					
Equipment	Manufacturer	Model	S/N	Cal Date	Cal Due
Bilog Antenna	Sunol Sciences	JB3	A030105	07/19/2021	07/18/2022
Coaxial Cable	HUBER SUHNER	SUCOFLEX 104PEA	20995	02/24/2021	02/23/2022
Coaxial Cable	EMCI	EMC105	190914+327109/4	09/17/2021	09/16/2022
Digital Thermo-Hygro Meter	WISEWIND	1206	D07	01/06/2021	01/05/2022
double Ridged Guide Horn Antenna	ETC	MCTD 1209	DRH13M02003	09/30/2020	09/29/2021
High Pass Filters	MICRO TRONICS	HPM13195	003	02/08/2021	02/07/2022
Horn Antenna	ETS LINDGREN	3116	00026370	12/11/2020	12/10/2021
K Type Cable	Huber+Suhner	SUCOFLEX 102	29406/2	12/09/2020	12/08/2021
K Type Cable	Huber+Suhner	SUCOFLEX 102	22470/2	12/09/2020	12/08/2021
Pre-Amplifier	EMEC	EM330	060609	02/24/2021	02/23/2022
Pre-Amplifier	HP	8449B	3008A00965	02/25/2021	02/24/2022
Pre-Amplifier	MITEQ	AMF-6F-18004000-37-8P	985646	08/31/2021	08/30/2022
Signal Analyzer	R&S	FSV 40	101073	09/15/2021	09/14/2022
Antenna Tower	CCS	CC-A-1F	N/A	N.C.R	N.C.R
Controller	CCS	CC-C-1F	N/A	N.C.R	N.C.R
Turn Table	CCS	CC-T-1F	N/A	N.C.R	N.C.R
Software	e3 6.11-20180419c				

Remark: Each piece of equipment is scheduled for calibration once a year.

RF Conducted Test Site					
Equipment	Manufacturer	Model	S/N	Cal Date	Cal Due
Coaxial Cable	Woken	WC12	CC003	06/28/2021	06/27/2022
Coaxial Cable	Woken	WC12	CC001	06/28/2021	06/27/2022
Power Meter	Anritsu	ML2487A	6K00003260	05/24/2021	05/23/2022
Power Seneor	Anritsu	MA2490A	032910	05/24/2021	05/23/2022
EXA Signal Analyzer	KEYSIGHT	N9010B	MY55460167	09/07/2020	09/06/2021
Software	Radio Test Software Ver. 21				

Remark: Each piece of equipment is scheduled for calibration once a year.

1.7 SUPPORT AND EUT ACCESSORIES EQUIPMENT

EUT Accessories Equipment					
No.	Equipment	Brand	Model	Series No.	FCC ID
	N/A				

Support Equipment					
No.	Equipment	Brand	Model	Series No.	FCC ID
1	Adapter	WEIHAI POWER	HAS060123-EA	N/A	N/A

1.8 TEST METHODOLOGY AND APPLIED STANDARDS

The test methodology, setups and results comply with all requirements in accordance with ANSI C63.10:2013, FCC Part 2, FCC Part 15.407, KDB 789033 D02, KDB 905462 D02, RSS-247 Issue 2 and RSS-GEN Issue 5.

2. TEST SUMMARY

FCC Standard Sec.	IC Standard Sec.	Chapter	Test Item	Result
15.203	RSS-Gen (6.8)	1.3	Antenna Requirement	Pass
15.407(b)	RSS-247(6.2.1.2) RSS-247(6.2.2.2) RSS-247(6.2.3.2) RSS-247(6.2.4.2)	4.1	Radiation Spurious Emission	Pass
15.407(a)	RSS-247(6.2.1.1) RSS-247(6.2.2.1) RSS-247(6.2.3.1) RSS-247(6.2.4.1)	4.2	Output Power Measurement	Pass

3. DESCRIPTION OF TEST MODES

3.1 THE EUT CHANNEL NUMBER OF OPERATING CONDITION

<p>Operation mode</p>	<p>1. IEEE 802.11a mode: 6Mbps 2. IEEE 802.11n HT 20 MHz mode: MCS0 3. IEEE 802.11n HT 40 MHz mode: MCS0</p>																															
<p>Operating Frequency</p>	<table border="1"> <thead> <tr> <th></th> <th>Mode</th> <th>Frequency Range (MHz)</th> </tr> </thead> <tbody> <tr> <td rowspan="3">U-NII-1</td> <td>IEEE 802.11a</td> <td>5180, 5220, 5240</td> </tr> <tr> <td>IEEE 802.11n HT 20 MHz</td> <td>5180, 5220, 5240</td> </tr> <tr> <td>IEEE 802.11n HT 40 MHz</td> <td>5190, 5230</td> </tr> <tr> <td rowspan="3">U-NII-2a</td> <td>IEEE 802.11a</td> <td>5260, 5280, 5320</td> </tr> <tr> <td>IEEE 802.11n HT 20 MHz</td> <td>5260, 5280, 5320</td> </tr> <tr> <td>IEEE 802.11n HT 40 MHz</td> <td>5270, 5310</td> </tr> <tr> <td rowspan="3">U-NII-2c</td> <td>IEEE 802.11a</td> <td>5500, 5580, 5720</td> </tr> <tr> <td>IEEE 802.11n HT 20 MHz</td> <td>5500, 5580, 5720</td> </tr> <tr> <td>IEEE 802.11n HT 40 MHz</td> <td>5510, 5550, 5710</td> </tr> <tr> <td rowspan="3">U-NII-3</td> <td>IEEE 802.11a</td> <td>5745, 5785, 5825</td> </tr> <tr> <td>IEEE 802.11n HT 20 MHz</td> <td>5745, 5785, 5825</td> </tr> <tr> <td>IEEE 802.11n HT 40 MHz</td> <td>5755, 5795</td> </tr> </tbody> </table>		Mode	Frequency Range (MHz)	U-NII-1	IEEE 802.11a	5180, 5220, 5240	IEEE 802.11n HT 20 MHz	5180, 5220, 5240	IEEE 802.11n HT 40 MHz	5190, 5230	U-NII-2a	IEEE 802.11a	5260, 5280, 5320	IEEE 802.11n HT 20 MHz	5260, 5280, 5320	IEEE 802.11n HT 40 MHz	5270, 5310	U-NII-2c	IEEE 802.11a	5500, 5580, 5720	IEEE 802.11n HT 20 MHz	5500, 5580, 5720	IEEE 802.11n HT 40 MHz	5510, 5550, 5710	U-NII-3	IEEE 802.11a	5745, 5785, 5825	IEEE 802.11n HT 20 MHz	5745, 5785, 5825	IEEE 802.11n HT 40 MHz	5755, 5795
	Mode	Frequency Range (MHz)																														
U-NII-1	IEEE 802.11a	5180, 5220, 5240																														
	IEEE 802.11n HT 20 MHz	5180, 5220, 5240																														
	IEEE 802.11n HT 40 MHz	5190, 5230																														
U-NII-2a	IEEE 802.11a	5260, 5280, 5320																														
	IEEE 802.11n HT 20 MHz	5260, 5280, 5320																														
	IEEE 802.11n HT 40 MHz	5270, 5310																														
U-NII-2c	IEEE 802.11a	5500, 5580, 5720																														
	IEEE 802.11n HT 20 MHz	5500, 5580, 5720																														
	IEEE 802.11n HT 40 MHz	5510, 5550, 5710																														
U-NII-3	IEEE 802.11a	5745, 5785, 5825																														
	IEEE 802.11n HT 20 MHz	5745, 5785, 5825																														
	IEEE 802.11n HT 40 MHz	5755, 5795																														

Remark:

1. EUT pre-scanned data rate of output power for each mode, the worst data rate were recorded in this report.
2. For Canada the EUT Frequency Range 5600~5650MHz will be disabled.



Report No.: T210730W05-RP4

Page: 11 / 26

Rev.: 00

3.2 THE WORST MODE OF MEASUREMENT

Radiated Emission Measurement Below 1G	
Test Condition	Radiated Emission Below 1G
Power supply Mode	Mode 1: EUT power by Power Supply (1st) Mode 2: EUT power by Power Supply (2nd)
Worst Mode	<input checked="" type="checkbox"/> Mode 1 <input type="checkbox"/> Mode 2 <input type="checkbox"/> Mode 3 <input type="checkbox"/> Mode 4

Remark:

1. The worst mode was record in this test report.
2. EUT pre-scanned in three axis ,X,Y, Z and two polarity, for radiated measurement. The worst case(Y-Plane) were recorded in this report

Report No.: T210730W05-RP4

4. TEST RESULT

4.1 RADIATION SPURIOUS EMISSION

4.1.1 Test Limit

According to §15.407, §15.209 and §15.205,
 According to RSS-247 section 6.2.1.2 and section 6.2.4.2

Below 30 MHz

Frequency	Field Strength (microvolts/m)	Magnetic H-Field (microamperes/m)	Measurement Distance (metres)
9-490 kHz	2,400/F (F in kHz)	2,400/F (F in kHz)	300
490-1,705 kHz	24,000/F (F in kHz)	24,000/F (F in kHz)	30
1.705-30 MHz	30	N/A	30

Above 30 MHz

Frequency (MHz)	Field Strength microvolts/m at 3 metres (watts, e.i.r.p.)	
	Transmitters	Receivers
30-88	100 (3 nW)	100 (3 nW)
88-216	150 (6.8 nW)	150 (6.8 nW)
216-960	200 (12 nW)	200 (12 nW)
Above 960	500 (75 nW)	500 (75 nW)

RSS-Gen Table 3 and Table 5 – General Field Strength Limits for Transmitters and Receivers at Frequencies Above 30 MHz ^(Note)

Frequency (MHz)	Field Strength microvolts/m at 3 metres (watts, e.i.r.p.)	
	Transmitters	Receivers
30-88	100 (3 nW)	100 (3 nW)
88-216	150 (6.8 nW)	150 (6.8 nW)
216-960	200 (12 nW)	200 (12 nW)
Above 960	500 (75 nW)	500 (75 nW)

Note: Measurements for compliance with the limits in table 3 may be performed at distances other than 3 metres, in accordance with Section 6.6.

RSS-Gen Table 6: General Field Strength Limits for Transmitters at Frequencies Below 30 MHz (Transmit)

Frequency	Magnetic field strength (H-Field) ($\mu\text{A/m}$)	Measurement Distance (m)
9-490 kHz ^{Note}	6.37/F (F in kHz)	300
490-1,705 kHz	63.7/F (F in kHz)	30
1.705-30 MHz	0.08	30

Note: The emission limits for the ranges 9-90 kHz and 110-490 kHz are based on measurements employing a linear average detector..

UNII-1 :

For transmitters operating in the band 5150-5250 MHz, all emissions outside the band 5150-5350 MHz shall not exceed -27 dBm/MHz e.i.r.p. However, any unwanted emissions that fall into the band 5250-5350 MHz must be 26 dBc, when measured using a resolution bandwidth between 1 and 5% of the occupied bandwidth, above 5.25 GHz. Otherwise, the transmission is considered as intentional and the devices shall implement dynamic frequency selection (DFS) and transmitter power control (TPC) as per the requirements for the band 5250-5350 MHz

UNII-2a and 2c :

For devices with operating frequencies in the band 5250-5350 MHz but having a channel bandwidth that overlaps the band 5150-5250 MHz, the devices' unwanted emission shall not exceed -27 dBm/MHz e.i.r.p. outside the band 5150-5350 MHz and its power shall comply with the spectral power density for operation within the band 5150-5250 MHz. The device shall be labelled "for indoor use only." Emissions outside the band 5470-5725 MHz shall not exceed -27 dBm/MHz e.i.r.p.

UNII-3:

For the band 5725-5850 MHz, emissions at frequencies from the band edges to 10 MHz above or below the band edges shall not exceed -17 dBm/MHz e.i.r.p.

For emissions at frequencies more than 10 MHz above or below the band edges, the emissions power shall not exceed -27 dBm/MHz

4.1.2 Test Procedure

Test method Refer as KDB 789033 D02.

1. The EUT is placed on a turntable, Above 1 GHz is 1.5m and below 1 GHz is 0.8m above ground plane. The EUT Configured un accordance with ANSI C63.10: 2013, and the EUT set in a continuous mode.
2. The turntable shall be rotated for 360 degrees to determine the position of maximum emission level. And EUT is set 3m away from the receiving antenna, which is scanned from 1m to 4m above the ground plane to find out the highest emissions. Measurement are made polarized in both the vertical and the horizontal positions with antenna.
3. Span shall wide enough to full capture the emission measured. The SA from 9kHz to 26.5GHz set to the low, Mid and High channels with the EUT transmit.
4. No emission found between lowest internal used/generated frequency to 30MHz (9KHz~30MHz)
5. The SA setting following :
 - (1) Below 1G : RBW = 100kHz, VBW $\geq 3 \times$ RBW, Sweep = Auto, Detector = Peak, Trace = Max hold.
 - (2) Above 1G :
 - (2.1) For Peak measurement : RBW = 1MHz, VBW ≥ 3 RBW, Sweep = Auto, Detector = Peak, Trace = Max hold.
 - (2.2) For Average measurement : RBW = 1MHz, VBW
 - If Duty Cycle $\geq 98\%$, VBW=10Hz.
 - If Duty Cycle $< 98\%$, VBW=1/T.

4.1.3 Test Setup

9kHz ~ 30MHz

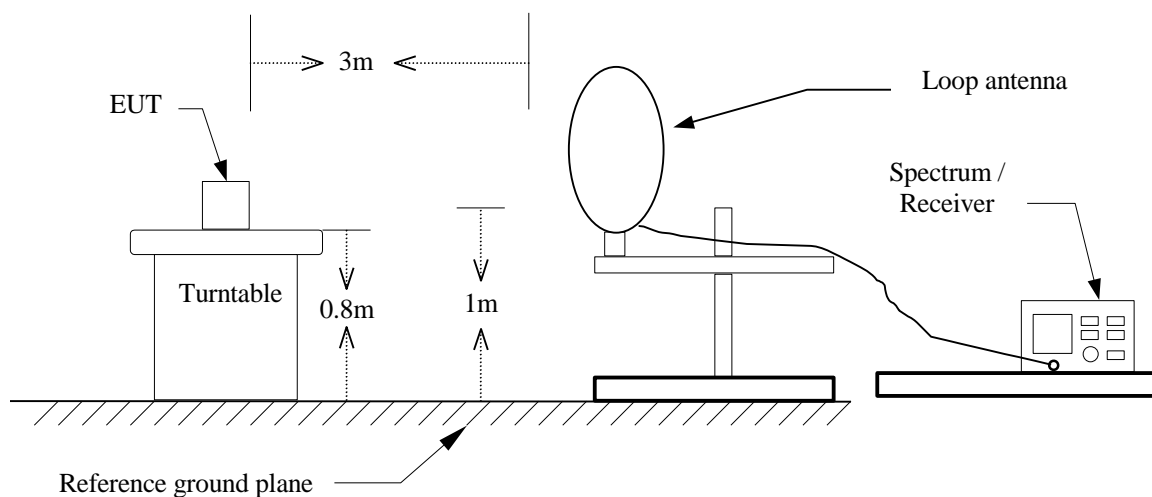

30MHz ~ 1GHz

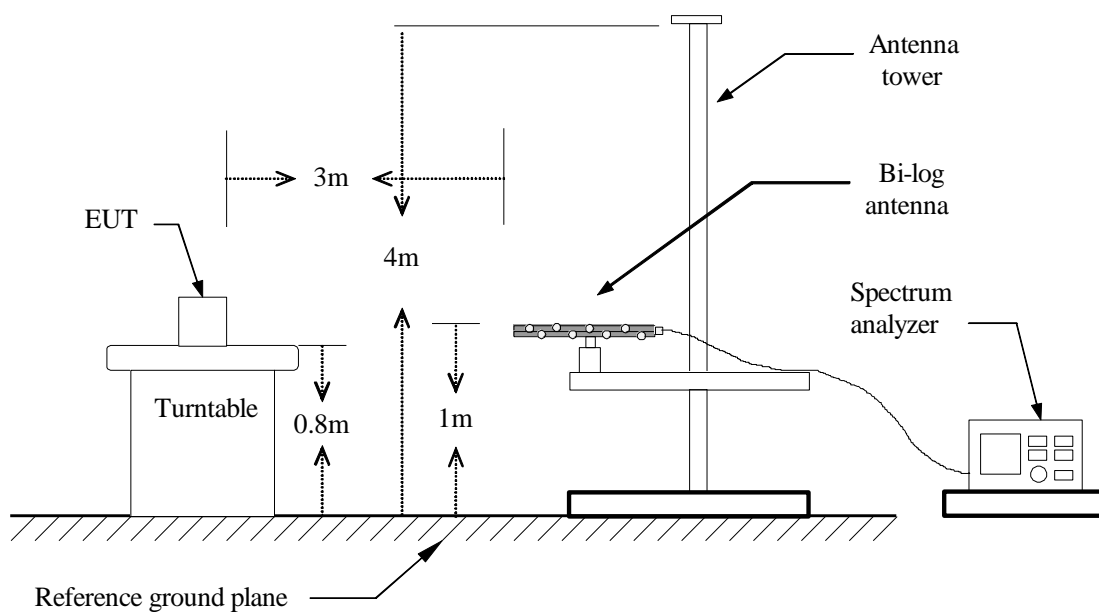

Above 1 GHz

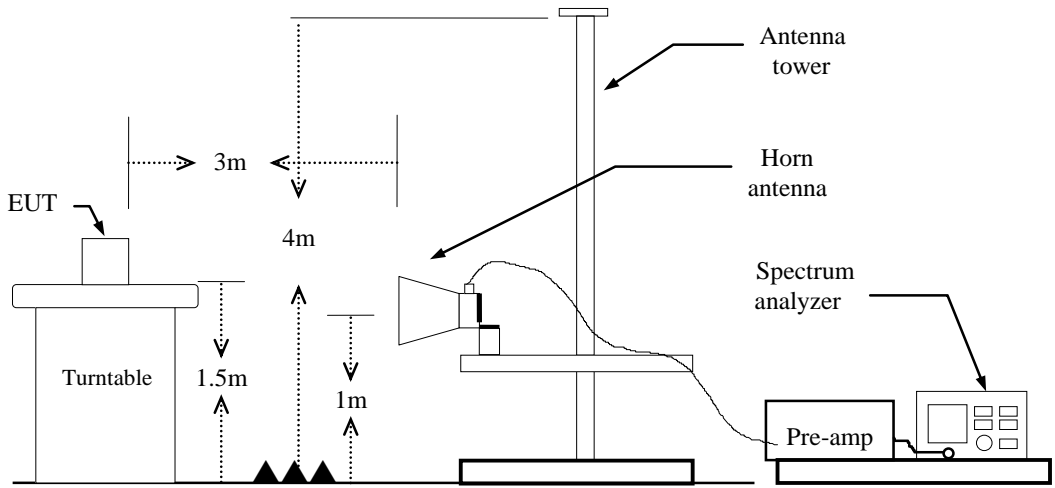

Report No.: T210730W05-RP4

4.1.4 Test Result

Below 1G Test Data

Test Mode	Mode 1	Temp/Hum	23.9(°C)/ 55%RH
Test Item	30MHz-1GHz	Test Date	September 22, 2021
Polarize	Vertical	Test Engineer	Ray Li
Detector	Peak		

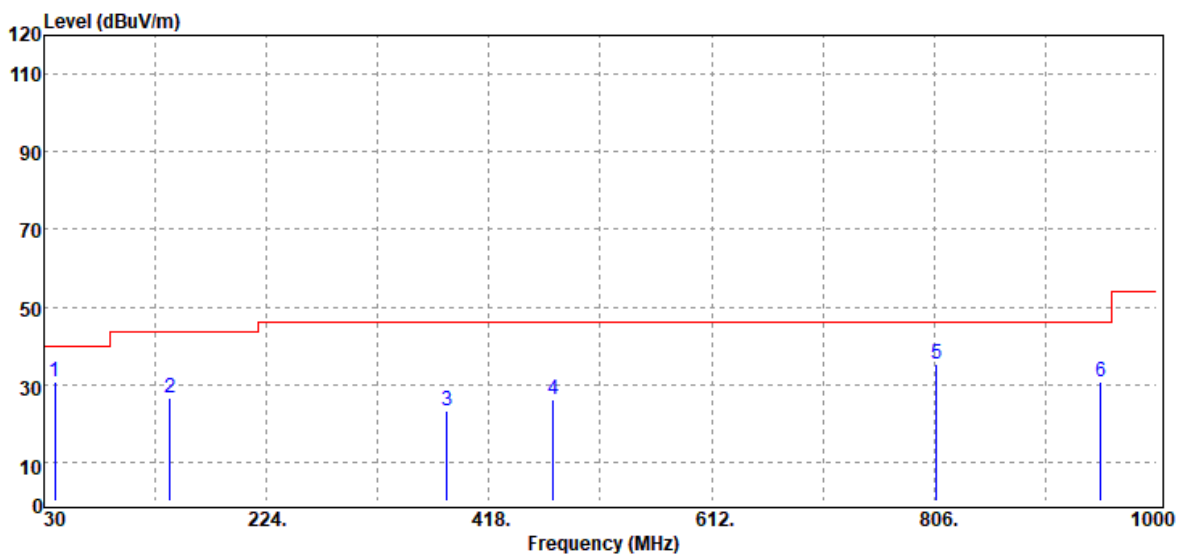

Freq. MHz	Detector Mode PK/QP/AV	Spectrum Reading Level dBμV	Factor dB	Actual FS dBμV/m	Limit @3m dBμV/m	Margin dB
39.70	Peak	40.16	-9.54	30.62	40.00	-9.38
139.61	Peak	36.53	-9.90	26.63	43.50	-16.87
381.14	Peak	29.77	-6.68	23.09	46.00	-22.91
474.26	Peak	29.46	-3.51	25.95	46.00	-20.05
807.94	Peak	33.57	1.72	35.29	46.00	-10.71
951.50	Peak	27.16	3.71	30.87	46.00	-15.13

Note: 1. No emission found between lowest internal used/generated frequency to 30MHz(9KHz~30MHz)
2. For below 1GHz, the EUT peak value was under average limit, therefore the Average value compliance with the average limit.

Report No.: T210730W05-RP4

Test Mode	Mode 1	Temp/Hum	23.9(°C)/ 55%RH
Test Item	30MHz-1GHz	Test Date	September 22, 2021
Polarize	Horizontal	Test Engineer	Ray Li
Detector	Peak		

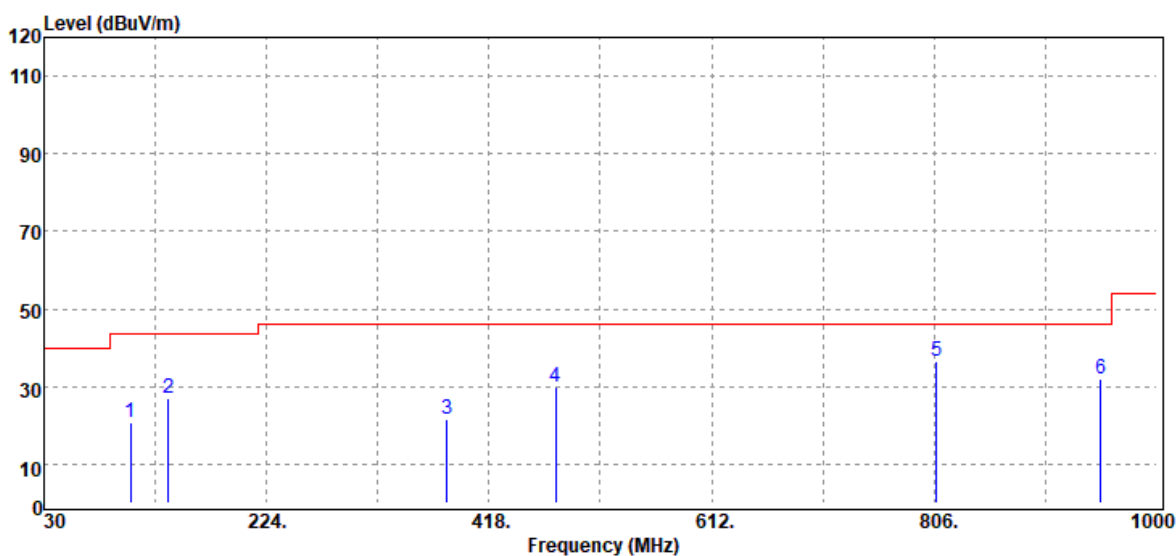

Freq. MHz	Detector Mode PK/QP/AV	Spectrum Reading Level dBµV	Factor dB	Actual FS dBµV/m	Limit @3m dBµV/m	Margin dB
105.66	Peak	32.03	-11.16	20.87	43.50	-22.63
138.64	Peak	36.75	-9.80	26.95	43.50	-16.55
381.14	Peak	28.42	-6.68	21.74	46.00	-24.26
476.20	Peak	33.30	-3.45	29.85	46.00	-16.15
807.94	Peak	34.89	1.72	36.61	46.00	-9.39
951.50	Peak	28.22	3.71	31.93	46.00	-14.07

Note: 1. No emission found between lowest internal used/generated frequency to 30MHz(9KHz~30MHz)
 2. For below 1GHz, the EUT peak value was under average limit, therefore the Average value compliance with the average limit.

Report No.: T210730W05-RP4

Test Mode:	IEEE 802.11a Mid CH / Band 1, 5220MHz	Temp/Hum	23.9(°C)/ 55%RH
Test Item	Harmonic	Test Date	September 22, 2021
Polarize	Vertical	Test Engineer	Ray Li
Detector	Peak		

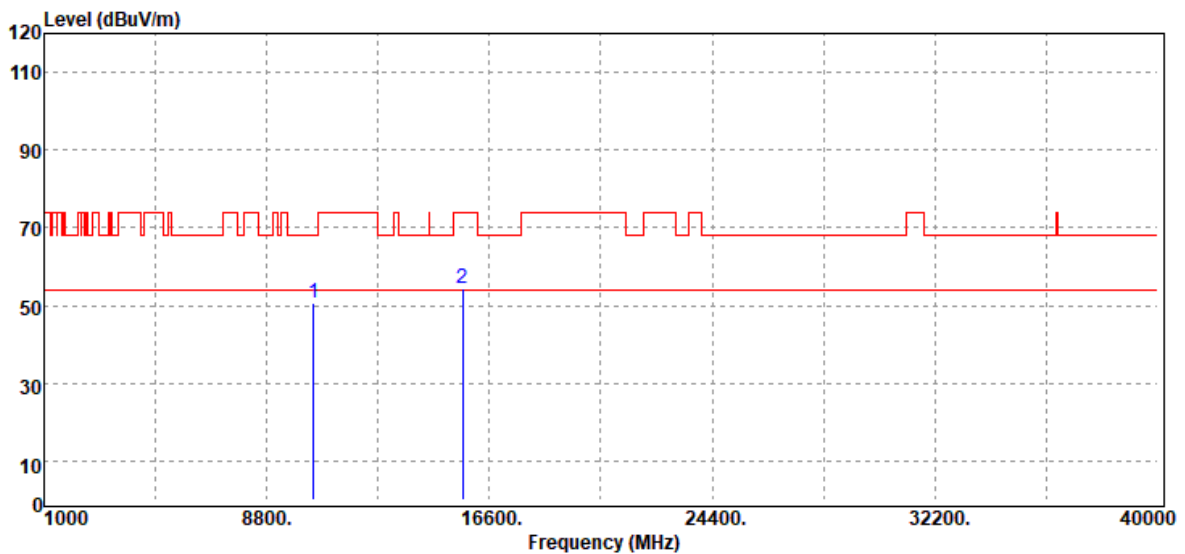

Freq. MHz	Detector Mode PK/QP/AV	Spectrum Reading Level dBuV	Factor dB	Actual FS dBuV/m	Limit @3m dBuV/m	Margin dB
10440.00	Peak	31.77	19.02	50.79	68.20	-17.41
15660.00	Peak	30.51	23.69	54.20	74.00	-19.80
N/A						

Remark:

1. Measuring frequencies from 1 GHz to the 10th harmonic of highest fundamental frequency.
2. For above 1GHz,the EUT peak value was under average limit, therefore the Average value compliance with the average limit

Report No.: T210730W05-RP4

Test Mode:	IEEE 802.11a Mid CH / Band 1, 5220MHz	Temp/Hum	23.9(°C)/ 55%RH
Test Item	Harmonic	Test Date	September 22, 2021
Polarize	Horizontal	Test Engineer	Ray Li
Detector	Peak		

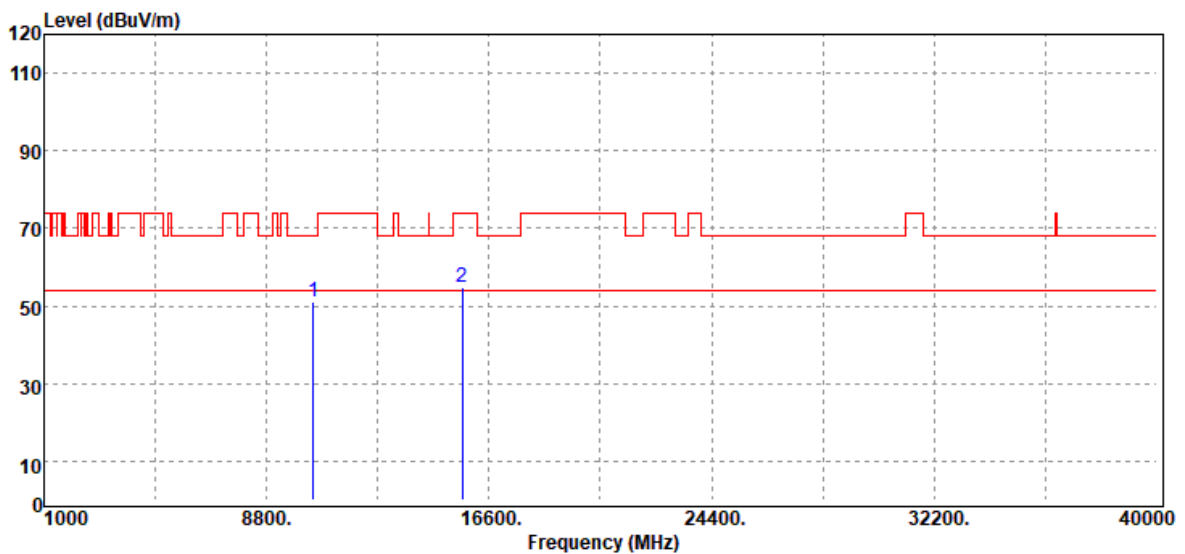

Freq. MHz	Detector Mode PK/QP/AV	Spectrum Reading Level dBµV	Factor dB	Actual FS dBµV/m	Limit @3m dBµV/m	Margin dB
10440.00	Peak	31.86	19.02	50.88	68.20	-17.32
15660.00	Peak	31.18	23.69	54.87	74.00	-19.13
N/A						

Remark:

1. Measuring frequencies from 1 GHz to the 10th harmonic of highest fundamental frequency.
2. For above 1GHz, the EUT peak value was under average limit, therefore the Average value compliance with the average limit

4.2 OUTPUT POWER MEASUREMENT

4.2.1 Test Limit

According to §15.407 (a)(1), 15.407(a)(2) and 15.407(a)(3), and RSS-247 section 6.2.1.1, section 6.2.2.1, section 6.2.3.1 and section 6.2.4.1

FCC:

UNII-1 :

For client devices in the 5.15-5.25 GHz band, the maximum conducted output power over the frequency band of operation shall not exceed 250 mW(24 dBm), whichever power is less. B is the 99% emission bandwidth in megahertz, provided the maximum antenna gain does not exceed 6 dBi. In addition, the maximum power spectral density shall not exceed 11 dBm in any 1 megahertz band. If transmitting antennas of directional gain greater than 6 dBi are used, both the maximum conducted output power and the maximum power spectral density shall be reduced by the amount in dB that the directional gain of the antenna exceeds 6 dBi.

UNII-2a and 2c:

the maximum conducted output power over the frequency bands of operation shall not exceed the lesser of 250 mW or 11 dBm + 10 log B, where B is the 26 dB emission bandwidth in megahertz. In addition, the maximum power spectral density shall not exceed 11 dBm in any 1 megahertz band. and The maximum e.i.r.p. shall not exceed 1.0 W or 17 + 10 Log₁₀ B, dBm, whichever power is less. B is the 99% emission bandwidth in MHz. If transmitting antennas of directional gain greater than 6 dBi are used, both the maximum conducted output power and the maximum power spectral density shall be reduced by the amount in dB that the directional gain of the antenna exceeds 6 dBi.

UNII-3:

For the band 5.725-5.85 GHz, the maximum conducted output power over the frequency band of operation shall not exceed 1 W. In addition, the maximum power spectral density shall not exceed 30 dBm in any 500-kHz band. If transmitting antennas of directional gain greater than 6 dBi are used, both the maximum conducted output power and the maximum power spectral density shall be reduced by the amount in dB that the directional gain of the antenna exceeds 6 dBi.

Report No.: T210730W05-RP4

IC:

UNII-1 :

For OEM devices installed in vehicles, the maximum e.i.r.p. shall not exceed 30 mW or $1.76 + 10 \log_{10}B$, dBm, whichever is less. Devices shall implement transmitter power control (TPC) in order to have the capability to operate at least 3 dB below the maximum permitted e.i.r.p. of 30 mW.

For other devices, the maximum e.i.r.p. shall not exceed 200 mW or $10 + 10 \log_{10}B$, dBm, whichever power is less. B is the 99% emission bandwidth in megahertz. The e.i.r.p. spectral density shall not exceed 10 dBm in any 1.0 MHz band.

UNII-2a and 2c:

For OEM devices installed in vehicles, the maximum e.i.r.p. shall not exceed 30 mW or $1.76 + 10 \log_{10}B$, dBm, whichever is less. Devices shall implement TPC in order to have the capability to operate at least 3 dB below the maximum permitted e.i.r.p. of 30 mW.

Devices, other than devices installed in vehicles, shall comply with the following:

The maximum conducted output power shall not exceed 250 mW or $11 + 10 \log_{10}B$, dBm, whichever is less. The power spectral density shall not exceed 11 dBm in any 1.0 MHz band;

The maximum e.i.r.p. shall not exceed 1.0 W or $17 + 10 \log_{10}B$, dBm, whichever is less. B is the 99% emission bandwidth in megahertz. Note that devices with a maximum e.i.r.p. greater than 500 mW shall implement TPC in order to have the capability to operate at least 6 dB below the maximum permitted e.i.r.p. of 1 W.

UNII-2c (5470-5600 MHz and 5650-5725 MHz)

The maximum conducted output power shall not exceed 250 mW or $11 + 10 \log_{10}B$, dBm, whichever is less. The power spectral density shall not exceed 11 dBm in any 1.0 MHz band.

The maximum e.i.r.p. shall not exceed 1.0 W or $17 + 10 \log_{10}B$, dBm, whichever is less. B is the 99% emission bandwidth in megahertz. Note that devices with a maximum e.i.r.p. greater than 500 mW shall implement TPC in order to have the capability to operate at least 6 dB below the maximum permitted e.i.r.p. of 1 W.

UNII-3:

For the band 5.725-5.85 GHz, the maximum conducted output power over the frequency band of operation shall not exceed 1 W. In addition, the maximum power spectral density shall not exceed 30 dBm in any 500-kHz band. If transmitting antennas of directional gain greater than 6 dBi are used, both the maximum conducted output power and the maximum power spectral density shall be reduced by the amount in dB that the directional gain of the antenna exceeds 6 dBi.

Report No.: T210730W05-RP4

UNII-1 Limit	<input checked="" type="checkbox"/> Antenna not exceed 6 dBi : 24dBm <input type="checkbox"/> Antenna with DG greater than 6 dBi : [Limit = 24 – (DG – 6)]
UNII-2a Limit	<input checked="" type="checkbox"/> Antenna not exceed 6 dBi : 24dBm <input type="checkbox"/> Antenna with DG greater than 6 dBi : [Limit = 24 – (DG – 6)]
UNII-2c Limit	<input type="checkbox"/> Antenna not exceed 6 dBi : 24dBm <input checked="" type="checkbox"/> Antenna with DG greater than 6 dBi : [Limit = 24 – (DG – 6)]
UNII-3 Limit	<input type="checkbox"/> Antenna not exceed 6 dBi : 30dBm <input checked="" type="checkbox"/> Antenna with DG greater than 6 dBi : [Limit = 30 – (DG – 6)]

4.2.2 Test Procedure

Test method Refer as KDB 789033 D02, Section E.3.b for BW 20MHz and 40MHz, E.2.b for BW 80MHz.

1. The EUT RF output connected to the power meter or spectrum by RF cable.
2. Setting maximum power transmit of EUT.
3. The path loss was compensated to the results for each measurement.
4. Measure and record the result of Average output power. in the test report.

4.2.3 Test Setup

For BW 20MHz and 40MHz

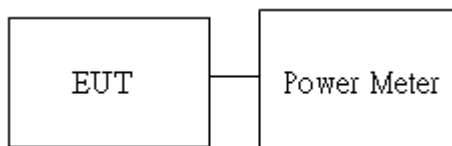

For BW 80MHz

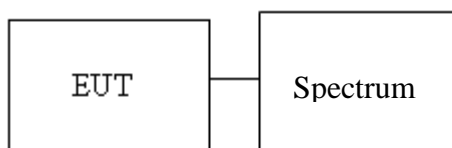

4.2.4 Test Result

Temperature: 24.9°C

Test date: September 17, 2021

Humidity: 58% RH

Tested by: Lance Chen

Average Power:

802.11a		Set	Average Power Output(dBm)	Average Power + factor(dBm)
5.2G/5.5G/5.8G			Data Rate (Mbps)	Data Rate (Mbps)
CH	Frequency (MHz)		6	6
36	5180	17	13.95	14.04
44	5220	17	14.06	14.15

4.3 TEST DATA RE-USE SUMMARY

Introduction Section:

The application re-uses data collected on a similar device. The subject device of this application (Model: MP7-ARGON2X-C, FCC ID: GKR436385, IC: 2533B-436385) is electrically identical to the reference device (Model: MP7-ARGON2-C, FCC ID: GKR425338, IC: 2533B-425338) for the portions of the circuitry corresponding to the data being re-used, as treated by KDB Publication 484596 D01.

Differences Brief Description:

The WLAN and Bluetooth hardware of this device are identical to the implementation in
FCC ID: GKR436385

IC: 2533B-436385

The Product Equality Declaration document includes detailed information about the changes between the devices. The data from that application has been verified through appropriate spot checks to demonstrate compliance for this device as shown in the summary table below.

Spot Check Verification Result Summary

Equipment Class	Reference FCC ID / IC No.	Folder Test	Report Title/ Section
DSS-NII	GKR425338 / 2533B-425338	T210413W01-RP4, T210413W01-RP5	All Section (Except for Radiation Spurious Emission below 1GHz)

Summery of the spot check for Unlicensed bands and Licensed bands

In order to confirm hardware similarity of the subject device with the reference device, we used same setting power to radiated emission measurement were performed on the subject device for the Band edge and Harmonic, the test result were similar with FCC ID: GKR425338 / IC: 2533B-425338.

WLAN-5GHz

Report	Test Item	Mode / CH.	Measured	GKR425338 / 2533B-425338			GKR436385 / 2533B-436385			Gap (dB)	
			Frequency (MHz)	Peak	Average	Ant. Pol.	Peak	Average	Ant. Pol.	Peak	Average
NII (WLAN)	Band edge	Band 1 / A / Low	5150	57.02	44.52	V	54.42	44.28	V	2.93	0.6
	Emission 1G~40G	Band 1 / A / Mid	10440	49.01	N/A	H	50.88	N/A	H	-1.87	N/A
			15660	54.13	N/A	H	54.87	N/A	H	-0.74	N/A

Report	Test Item	Mode / CH.	Ant. Pol.	Measured	GKR425338 / 2533B-425338		Measured	GKR436385 / 2533B-436385		Gap (dB)	
				Frequency (MHz)	Peak	Average	Frequency (MHz)	Peak	Average	Peak	Average
NII (WLAN)	LF	Band 1 / A / Mid	H	51.34	36.47	-	807.94	36.61	-	-0.14	-

- End of Test Report -