

# RADIO TEST REPORT

## FCC 47 CFR PART 15 SUBPART C

### INDUSTRY CANADA RSS-247

<b>Test Standard</b>	<b>FCC Part 15.247</b> <b>IC RSS-247 issue 2 and IC RSS-GEN issue 5</b>
<b>Product name</b>	<b>Tablet</b>
<b>Brand Name</b>	<b>ICON/iFit</b>
<b>Model No.</b>	<b>MP21-ARGON-C</b>
<b>Test Result</b>	<b>Pass</b>
<b>Statements of Conformity</b>	<b>Determination of compliance is based on the results of the compliance measurement, not taking into account measurement instrumentation uncertainty.</b>

The test Result was tested by Compliance Certification Services Inc. The test data, data evaluation, test procedures, and equipment configurations shown in this report were given in ANSI C63.10: 2013 and compliance standards.

The test results of this report relate only to the tested sample (EUT) identified in this report.

The test Report of full or partial shall not copy. Without written approval of Compliance Certification Services Inc.( Wugu Laboratory)

Approved by:



---

Kevin Tsai  
Deputy Manager

Unless otherwise stated the results shown in this test report refer only to the sample(s) tested and such sample(s) are retained for 90 days only.  
除非另有說明，此報告結果僅對測試之樣品負責，同時此樣品僅保留90天。本報告未經本公司書面許可，不可部份複製。

This document is issued by the Company subject to its General Conditions of Service printed overleaf, available on request or accessible at <http://www.sgs.com.tw/Terms-and-Conditions> and, for electronic format documents, subject to Terms and Conditions for Electronic Documents at <http://www.sgs.com.tw/Terms-and-Conditions>. Attention is drawn to the limitation of liability, indemnification and jurisdiction issues defined therein. Any holder of this document is advised that information contained hereon reflects the Company's findings at the time of its intervention only and within the limits of client's instruction, if any. The Company's sole responsibility is to its Client and this document does not exonerate parties to a transaction from exercising all their rights and obligations under the transaction documents. This document cannot be reproduced, except in full, without prior written approval of the Company. Any unauthorized alteration, forgery or falsification of the content or appearance of this document is unlawful and offenders may be prosecuted to the fullest extent of the law.

## Revision History

Rev.	Issue Date	Revisions	Effect Page	Revised By
00	July 8, 2020	Initial Issue	ALL	Allison Chen
01	July 10, 2020	See the following note Rev.(01)	P.55	Allison Chen
02	July 13, 2020	See the following note Rev.(02)	P.10	Allison Chen

**Rev.(01)**

1. Revised description for summary of spot check.

**Rev.(02)**

1. Revised test summary for Antenna Requirement section.

## Table of contents

<b>1. GENERAL INFORMATION .....</b>	<b>4</b>
<b>1.1 EUT INFORMATION .....</b>	<b>4</b>
<b>1.2 INFORMATION ABOUT THE FHSS CHARACTERISTICS.....</b>	<b>5</b>
<b>1.3 EUT CHANNEL INFORMATION .....</b>	<b>6</b>
<b>1.4 ANTENNA INFORMATION .....</b>	<b>6</b>
<b>1.5 MEASUREMENT UNCERTAINTY .....</b>	<b>7</b>
<b>1.6 FACILITIES AND TEST LOCATION.....</b>	<b>8</b>
<b>1.7 INSTRUMENT CALIBRATION.....</b>	<b>8</b>
<b>1.8 SUPPORT AND EUT ACCESSORIES EQUIPMENT.....</b>	<b>9</b>
<b>1.9 TEST METHODOLOGY AND APPLIED STANDARDS .....</b>	<b>9</b>
<b>2. TEST SUMMARY .....</b>	<b>10</b>
<b>3. DESCRIPTION OF TEST MODES .....</b>	<b>11</b>
<b>3.1 THE WORST MODE OF OPERATING CONDITION.....</b>	<b>11</b>
<b>3.2 THE WORST MODE OF MEASUREMENT .....</b>	<b>12</b>
<b>3.3 EUT DUTY CYCLE .....</b>	<b>13</b>
<b>4. TEST RESULT .....</b>	<b>14</b>
<b>4.1 AC POWER LINE CONDUCTED EMISSION.....</b>	<b>14</b>
<b>4.2 OUTPUT POWER MEASUREMENT.....</b>	<b>17</b>
<b>4.3 RADIATION BANDEDGE AND SPURIOUS EMISSION .....</b>	<b>19</b>
<b>4.4 TEST DATA RE-USE SUMMARY.....</b>	<b>54</b>
<b>APPENDIX 1 - PHOTOGRAPHS OF EUT</b>	

## 1. GENERAL INFORMATION

### 1.1 EUT INFORMATION

FCC Applicant	Compal Electronics Inc No.581 & 581-1, Ruiguang Rd., Neihu District, Taipei city, 11492 Taiwan
IC Applicant	COMPAL ELECTRONICS INC. No. 581 & 581-1, Ruiguang Rd., Neihu District Taipei R.O.C. 114 Taiwan
Manufacturer	Compal Electronics Inc No.581 & 581-1, Ruiguang Rd., Neihu District, Taipei city, 11492 Taiwan
Equipment	Tablet
Model No.	MP21-ARGON-C
Model Discrepancy	N/A
Trade Name	ICON/iFit
Received Date	May 21, 2020
Date of Test	June 2 ~ July 7, 2020
Power Operation	EUT Power from Host device (DC12V)
HW Version	LA-J301P
SW Version	Android 8

## 1.2 INFORMATION ABOUT THE FHSS CHARACTERISTICS

### 1.2.1 Pseudorandom Frequency Hopping Sequence

The channel is represented by a pseudo-random hopping sequence hopping through the 79 RF channels. The hopping sequence is unique for the piconet and is determined by the Bluetooth device address of the master; the phase in the hopping sequence is determined by the Bluetooth clock of the master. The channel is divided into time slots where each slot corresponds to an RF hop frequency. Consecutive hops correspond to different RF hop frequencies. The nominal hop rate is 1 600 hops/s.

### 1.2.2 Equal Hopping Frequency Use

The channels of this system will be used equally over the long-term distribution of the hopsets.

### 1.2.3 Example of a 79 hopping sequence in data mode:

02, 05, 31, 24, 20, 10, 43, 36, 30, 23, 40, 06, 21, 50, 44, 09, 71, 78, 01, 13, 73, 07, 70, 72, 35, 62, 42, 11, 41, 08, 16, 29, 60, 15, 34, 61, 58, 04, 67, 12, 22, 53, 57, 18, 27, 76, 39, 32, 17, 77, 52, 33, 56, 46, 37, 47, 64, 49, 45, 38, 69, 14, 51, 26, 79, 19, 28, 65, 75, 54, 48, 03, 25, 66, 05, 16, 68, 74, 59, 63, 55

### 1.2.4 System Receiver Input Bandwidth

Each channel bandwidth is 1MHz.

The system receivers have input bandwidths that match the hopping channel bandwidths of their corresponding transmitters and shift frequencies in synchronization with the transmitted signals.

### 1.2.5 Equipment Description

RSS-247, 5.1 (a): The system shall hop to channel frequencies that are selected at the system hopping rate from a pseudo randomly ordered list of hopping frequencies. The system receivers shall have input bandwidths that match the hopping channel bandwidths of their corresponding transmitters and shall shift frequencies in synchronization with the transmitted signals.

Report No.: T200521W01-RP1

### 1.3 EUT CHANNEL INFORMATION

Frequency Range	2402MHz-2480MHz
Modulation Type	1. GFSK for BDR-1Mbps 2. $\pi/4$ -DQPSK for EDR-2Mbps 3. 8DPSK for EDR-3Mbps
Number of channel	79 Channels

**Remark:**

Refer as ANSI C63.10: 2013 clause 5.6.1 Table 4 and RSS-GEN Table 1 for test channels

Number of frequencies to be tested		
Frequency range in which device operates	Number of frequencies	Location in frequency range of operation
<input type="checkbox"/> 1 MHz or less	1	Middle
<input type="checkbox"/> 1 MHz to 10 MHz	2	1 near top and 1 near bottom
<input checked="" type="checkbox"/> More than 10 MHz	3	1 near top, 1 near middle, and 1 near bottom

### 1.4 ANTENNA INFORMATION

Antenna Type	<input checked="" type="checkbox"/> PIFA <input type="checkbox"/> PCB <input type="checkbox"/> Dipole <input type="checkbox"/> Coils
Antenna Gain	1.37 dBi
Antenna Connector	IPEX

## 1.5 MEASUREMENT UNCERTAINTY

PARAMETER	UNCERTAINTY
AC Powerline Conducted Emission	+/- 1.2575
Emission bandwidth, 20dB bandwidth	+/- 0.0014
RF output power, conducted	+/- 1.14
Power density, conducted	+/- 1.40
3M Semi Anechoic Chamber / 30M~200M	+/- 4.12
3M Semi Anechoic Chamber / 200M~1000M	+/- 4.68
3M Semi Anechoic Chamber / 1G~8G	+/- 5.18
3M Semi Anechoic Chamber / 8G~18G	+/- 5.47
3M Semi Anechoic Chamber / 18G~26G	+/- 3.81
3M Semi Anechoic Chamber / 26G~40G	+/- 3.87

**Remark:**

1. This uncertainty represents an expanded uncertainty expressed at approximately the 95% confidence level using a coverage factor of  $k=2$
2. ISO/IEC 17025 requires that an estimate of the measurement uncertainties associated with the emissions test results be included in the report.

Report No.: T200521W01-RP1

## 1.6 FACILITIES AND TEST LOCATION

All measurement facilities used to collect the measurement data are located at  
 No.11, Wugong 6th Rd., Wugu Dist., New Taipei City, Taiwan. (R.O.C.)

Test site	Test Engineer	Remark
AC Conduction Room	Dally Hong	-
Radiation	Jerry Chang	-
RF Conducted	Jane Wang	-

**Remark:** The sites are constructed in conformance with the requirements of ANSI C63.7, ANSI C63.4 and CISPR Publication 22.

## 1.7 INSTRUMENT CALIBRATION

3M 966 Chamber Test Site					
Equipment	Manufacturer	Model	S/N	Cal Date	Cal Due
Band Reject Filters	MICRO TRONICS	BRM 50702	120	02/25/2020	02/24/2021
Bilog Antenna	Sunol Sciences	JB3	A030105	07/26/2019	07/25/2020
Coaxial Cable	HUBER SUHNER	SUCOFLEX 104PEA	20995	02/25/2020	02/24/2021
Coaxial Cable	EMCI	EMC105	190914+25111	09/20/2019	09/19/2020
Digital Thermo-Hygro Meter	WISEWIND	1206	D07	01/15/2020	01/14/2021
double Ridged Guide Horn Antenna	ETC	MCTD 1209	DRH13M02003	10/04/2019	10/03/2020
Loop Ant	COM-POWER	AL-130	121051	03/27/2020	03/26/2021
Pre-Amplifier	EMEC	EM330	060609	02/25/2020	02/24/2021
Pre-Amplifier	HP	8449B	3008A00965	02/25/2020	02/24/2021
Signal Analyzer	R&S	FSV 40	101073	09/25/2019	09/24/2020
Antenna Tower	CCS	CC-A-1F	N/A	N.C.R	N.C.R
Controller	CCS	CC-C-1F	N/A	N.C.R	N.C.R
Turn Table	CCS	CC-T-1F	N/A	N.C.R	N.C.R
Software	e3 6.11-20180413				

Conducted Emission Room # B					
Name of Equipment	Manufacturer	Model	Serial Number	Calibration Date	Calibration Due
CABLE	EMCI	CFD300-NL	CERF	06/27/2019	06/26/2020
EMI Test Receiver	R&S	ESCI	100064	07/26/2019	07/25/2020
LISN	SCHAFFNER	NNB 41	03/10013	02/13/2020	02/12/2021
Software	EZ-EMC(CCS-3A1-CE)				

**Remark:** Each piece of equipment is scheduled for calibration once a year.



RF Conducted Test Site					
Name of Equipment	Manufacturer	Model	Serial Number	Calibration Date	Calibration Due
Coaxial Cable	Woken	WC12	CC001	06/28/2019	06/27/2020
Signal Analyzer	R&S	FSV 40	101073	09/25/2019	09/24/2020
Power Meter	Anritsu	ML2487A	6K00003260	05/21/2020	05/20/2021
Power Seneor	Anritsu	MA2490A	032910	05/21/2020	05/20/2021
Software	N/A				

**For Section 4.4: Test data re-use summary**

RF Conducted Test Site					
Name of Equipment	Manufacturer	Model	Serial Number	Calibration Date	Calibration Due
Coaxial Cable	Woken	WC12	CC001	06/29/2020	06/28/2021
Signal Analyzer	R&S	FSV 40	101073	09/25/2019	09/24/2020
Power Meter	Anritsu	ML2487A	6K00003260	05/21/2020	05/20/2021
Power Seneor	Anritsu	MA2490A	32910	05/21/2020	05/20/2021
Software	N/A				

**Remark:** Each piece of equipment is scheduled for calibration once a year.

## 1.8 SUPPORT AND EUT ACCESSORIES EQUIPMENT

EUT Accessories Equipment					
No.	Equipment	Brand	Model	Series No.	FCC ID
	N/A				

Support Equipment					
No.	Equipment	Brand	Model	Series No.	FCC ID
1.	Adapter	WEIHAI POWER	HAS060123-EA	N/A	N/A

## 1.9 TEST METHODOLOGY AND APPLIED STANDARDS

The test methodology, setups and results comply with all requirements in accordance with ANSI C63.10:2013, FCC Part 2, FCC Part 15.247, RSS-247 Issue 2 and RSS-GEN Issue 5.

## 2. TEST SUMMARY

FCC Standard Section	IC Standard Section	Report Section	Test Item	Result
15.203	-	1.4	Antenna Requirement	Pass
15.207(a)	RSS-GEN 8.8	4.1	AC Conducted Emission	Pass
15.247(b)(1)	RSS-247(5.4)(b)	4.2	Output Power Measurement	Pass
15.247(d)	RSS-GEN 8.9, 8.10	4.3	Radiation Band Edge	Pass
15.247(d)	RSS-GEN 8.9, 8.10	4.3	Radiation Spurious Emission	Pass

### 3. DESCRIPTION OF TEST MODES

#### 3.1 THE WORST MODE OF OPERATING CONDITION

<p>Operation mode</p>	<p>GFSK for BDR-1Mbps (DH5) 8DPSK for EDR-3Mbps (3DH5)</p>
<p>Test Channel Frequencies</p>	<p><b>GFSK for BDR-1Mbps:</b> 1.Lowest Channel: 2402MHz 2.Middle Channel: 2441MHz 3.Highest Channel: 2480MHz <b>8DPSK for EDR-3Mbps:</b> 1.Lowest Channel: 2402MHz 2.Middle Channel: 2441MHz 3.Highest Channel: 2480MHz</p>

*Remark:*

1. EUT pre-scanned data rate of output power for each mode, the worst data rate were recorded in this report.

Report No.: T200521W01-RP1

### 3.2 THE WORST MODE OF MEASUREMENT

AC Power Line Conducted Emission	
Test Condition	AC Power line conducted emission for line and neutral
Power supply Mode	Mode 1: EUT power by Host device.
Worst Mode	<input checked="" type="checkbox"/> Mode 1 <input type="checkbox"/> Mode 2 <input type="checkbox"/> Mode 3 <input type="checkbox"/> Mode 4

Radiated Emission Measurement Below 1G	
Test Condition	Radiated Emission Below 1G
Power supply Mode	Mode 1: EUT power by Host device.
Worst Mode	<input checked="" type="checkbox"/> Mode 1 <input type="checkbox"/> Mode 2 <input type="checkbox"/> Mode 3 <input type="checkbox"/> Mode 4

Radiated Emission Measurement Above 1G	
Test Condition	Radiated Emission Above 1G
Power supply Mode	Mode 1: EUT power by Host device.
Worst Mode	<input checked="" type="checkbox"/> Mode 1 <input type="checkbox"/> Mode 2 <input type="checkbox"/> Mode 3 <input type="checkbox"/> Mode 4
Worst Position	<input type="checkbox"/> Placed in fixed position. <input type="checkbox"/> Placed in fixed position at X-Plane (E2-Plane) <input checked="" type="checkbox"/> Placed in fixed position at Y-Plane (E1-Plane) <input type="checkbox"/> Placed in fixed position at Z-Plane (H-Plane)

Remark:

1. The worst mode was record in this test report.
2. EUT pre-scanned in three axis ,X,Y, Z and two polarity, for radiated measurement. The worst case(Y-Plane) were recorded in this report
3. AC power line conducted emission and for below 1G radiation emission were performed the EUT transmit at the highest output power channel as worse case.

Report No.: T200521W01-RP1

### 3.3 EUT DUTY CYCLE

Duty Cycle				
Configuration	Duty Cycle (%)	Duty Factor (dB) =10*log (1/Duty Cycle)	1/T (kHz)	VBW setting (kHz)
BDR-1Mbps	12.45%	9.05	2.16	3.00
EDR-3Mbps	7.00%	11.55	3.83	4.00

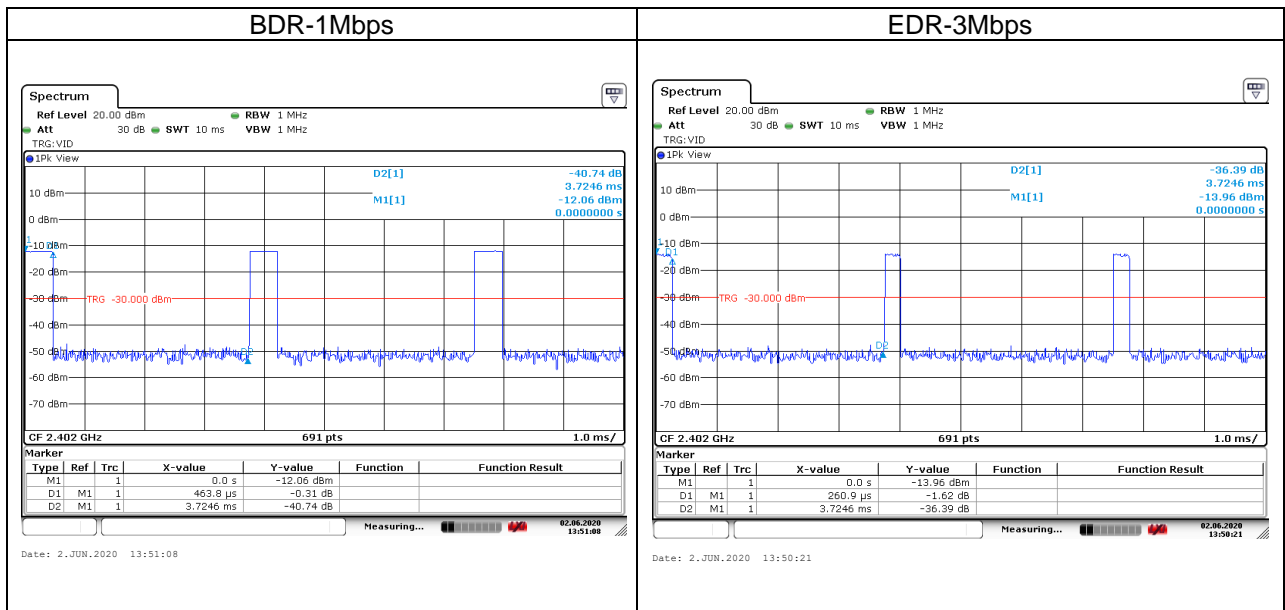

Report No.: T200521W01-RP1

## 4. TEST RESULT

### 4.1 AC POWER LINE CONDUCTED EMISSION

#### 4.1.1 Test Limit

According to §15.207(a) and RSS-GEN section 8.8,

Frequency Range (MHz)	Limits(dBμV)	
	Quasi-peak	Average
0.15 to 0.50	66 to 56*	56 to 46*
0.50 to 5	56	46
5 to 30	60	50

\* Decreases with the logarithm of the frequency.

#### 4.1.2 Test Procedure

Test method Refer as ANSI C63.10: 2013 clause 6.2,

1. The EUT was placed on a non-conducted table, which is 0.8m above horizontal ground plane and 0.4m above vertical ground plane.
2. EUT connected to the line impedance stabilization network (LISN)
3. Receiver set RBW of 9kHz and Detector Peak, and note as quasi-peak and average.
4. Maximum procedure was performed on the six highest emissions to ensure EUT compliance.
5. Recorded Line for Neutral and Line.

#### 4.1.3 Test Setup

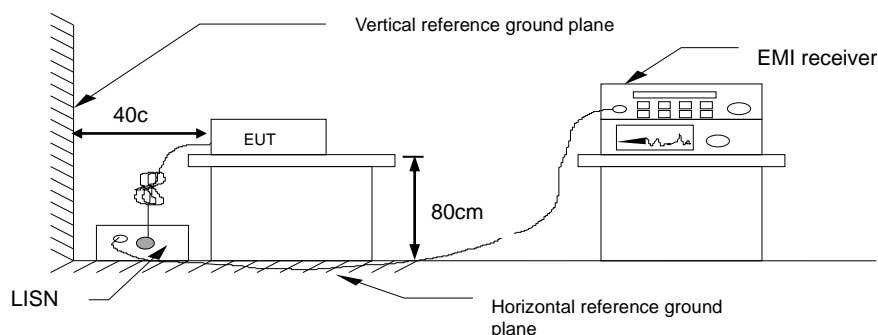

#### 4.1.4 Test Result

**PASS**

Report No.: T200521W01-RP1

### Test Data

Test Mode:	Mode 1	Temp/Hum	24(°C)/ 50%RH
Phase:	Line	Test Date	June 15, 2020
		Test Engineer	Dally Hong

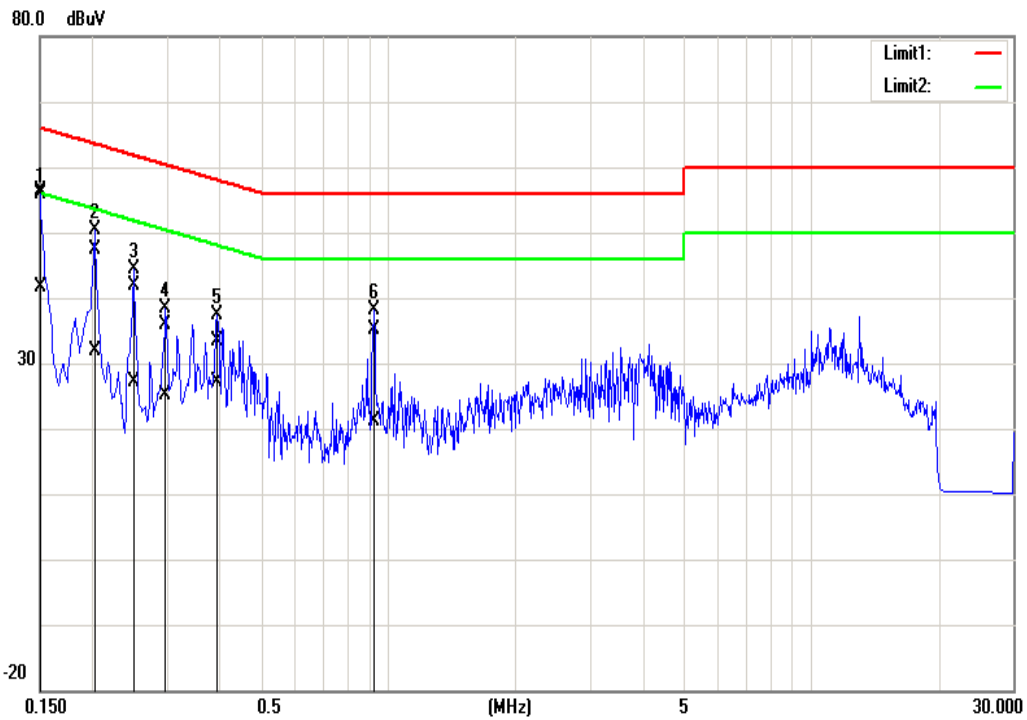

Frequency (MHz)	Quasi Peak reading (dBuV)	Average reading (d uV)	Correction factor (dB)	Quasi Peak result (dBuV)	Average result (dBuV)	Quasi Peak limit (dBuV)	Average limit (dBuV)	Quasi Peak margin (dB)	Average margin (dB)	Remark
0.1500	46.23	31.33	10.22	56.45	41.55	65.99	56.00	-9.54	-14.45	Pass
0.2020	37.09	21.75	10.21	47.30	31.96	63.52	53.53	-16.22	-21.57	Pass
0.2500	31.58	17.03	10.21	41.79	27.24	61.75	51.76	-19.96	-24.52	Pass
0.2980	25.55	14.93	10.21	35.76	25.14	60.30	50.30	-24.54	-25.16	Pass
0.3940	23.23	16.79	10.22	33.45	27.01	57.98	47.98	-24.53	-20.97	Pass
0.9260	24.98	10.95	10.24	35.22	21.19	56.00	46.00	-20.78	-24.81	Pass

Report No.: T200521W01-RP1

Test Mode:	Mode 1	Temp/Hum	24(°C)/ 50%RH
Phase:	Neutral	Test Date	June 15, 2020
		Test Engineer	Dally Hong

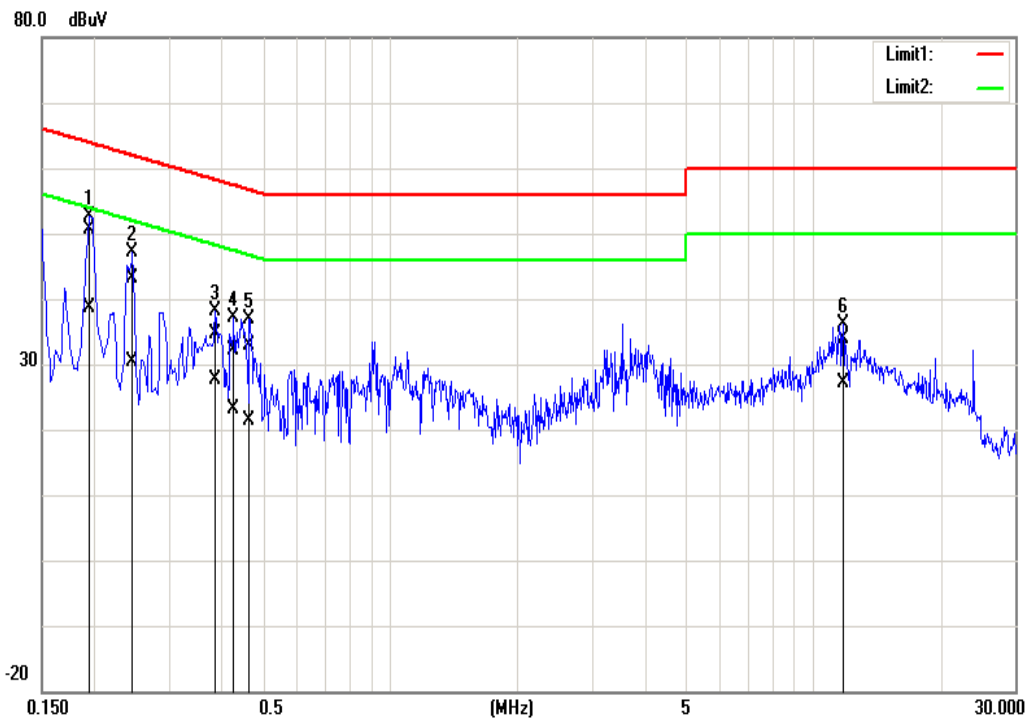

Frequency (MHz)	Quasi Peak reading (dBuV)	Average reading (dBuV)	Correction factor (dB)	Quasi Peak result (dBuV)	Average result (dBuV)	Quasi Peak limit (dBuV)	Average limit (dBuV)	Quasi Peak margin (dB)	Average margin (dB)	Remark
0.1940	40.48	28.37	10.19	50.67	38.56	63.86	53.86	-13.19	-15.30	Pass
0.2460	33.02	20.13	10.19	43.21	30.32	61.89	51.89	-18.68	-21.57	Pass
0.3860	24.46	17.44	10.19	34.65	27.63	58.15	48.15	-23.50	-20.52	Pass
0.4260	21.98	12.83	10.19	32.17	23.02	57.33	47.33	-25.16	-24.31	Pass
0.4660	22.61	11.22	10.19	32.80	21.41	56.58	46.58	-23.78	-25.17	Pass
11.7780	23.50	16.85	10.39	33.89	27.24	60.00	50.00	-26.11	-22.76	Pass



Report No.: T200521W01-RP1

## 4.2 OUTPUT POWER MEASUREMENT

### 4.2.1 Test Limit

According to §15.247(a)(1) and RSS-247 section 5.4(b)

**Peak output power** :

#### **FCC**

Alternatively, frequency hopping systems operating in the 2400-2483.5 MHz band may have hopping channel carrier frequencies that are separated by 25 kHz or two-thirds of the 20 dB bandwidth of the hopping channel, whichever is greater, provided the systems operate with an output power no greater than 125 mW.

#### **IC**

According to RSS-247 section 5.4(b), For FHSs operating in the band 2400-2483.5 MHz, the maximum peak conducted output power shall not exceed 1.0 W if the hopset uses 75 or more hopping channels; the maximum peak conducted output power shall not exceed 0.125 W if the hopset uses less than 75 hopping channels. The e.i.r.p. shall not exceed 4 W, except as provided in section 5.4(e).

Limit	<input checked="" type="checkbox"/> Antenna not exceed 6 dBi : 21dBm <input type="checkbox"/> Antenna with DG greater than 6 dBi : 21dBm [ Limit = 30 – (DG – 6)]
-------	--

**Average output power** : For reporting purposes only.

### 4.2.2 Test Procedure

1. The EUT RF output connected to the power meter by RF cable.
2. Setting maximum power transmit of EUT.
3. The path loss was compensated to the results for each measurement.
4. Measure and record the result of Peak output power and Average output power. in the test report.

### 4.2.3 Test Setup

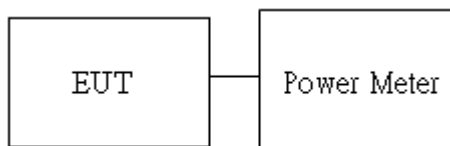

Report No.: T200521W01-RP1

### 4.2.4 Test Result

**Peak output power :**

BT										
Config.	CH	Freq. (MHz)	Power Setting	PK Power (dBm)	EIRP PK Power (dBm)	PK Power (W)	EIRP PK Power (W)	FCC/IC Limit (dBm)	IC EIRP Limit (dBm)	Antenna Gain (dBi)
GFSK BR-1Mbps (DH5)	0	2402	default	4.26	5.63	0.0027	0.0037	21	36	1.37
	39	2441	default	<b>4.33</b>	5.70	0.0027	0.0037			
	78	2480	default	4.02	5.39	0.0025	0.0035			
8DPSK EDR- 3Mbps (3DH5)	0	2402	default	3.47	4.84	0.0022	0.0030			
	39	2441	default	<b>5.42</b>	6.79	0.0035	0.0048			
	78	2480	default	4.81	6.18	0.0030	0.0041			

**Average output power :**

BT			
Config.	CH	Freq. (MHz)	AV Power (dBm)
GFSK BR-1Mbps (DH5)	0	2402	3.42
	39	2441	3.48
	78	2480	3.22
8DPSK EDR- 3Mbps (3DH5)	0	2402	2.61
	39	2441	2.74
	78	2480	2.43

## 4.3 RADIATION BANDEDGE AND SPURIOUS EMISSION

### 4.3.1 Test Limit

FCC according to §15.247(d), §15.209 and §15.205,

In any 100 kHz bandwidth outside the authorized frequency band, all harmonic and spurious must be least 20 dB below the highest emission level with the authorized frequency band. Radiation emission which fall in the restricted bands must also follow the FCC section 15.209 as below limit in table.

#### Below 30 MHz

Frequency	Field Strength (microvolts/m)	Magnetic H-Field (microamperes/m)	Measurement Distance (metres)
9-490 kHz	2,400/F (F in kHz)	2,400/F (F in kHz)	300
490-1,705 kHz	24,000/F (F in kHz)	24,000/F (F in kHz)	30
1.705-30 MHz	30	N/A	30

#### Above 30 MHz

Frequency (MHz)	Field Strength microvolts/m at 3 metres (watts, e.i.r.p.)	
	Transmitters	Receivers
30-88	100 (3 nW)	100 (3 nW)
88-216	150 (6.8 nW)	150 (6.8 nW)
216-960	200 (12 nW)	200 (12 nW)
Above 960	500 (75 nW)	500 (75 nW)

**Remark:**

Although these tests were performed other than open area test site, adequate comparison measurements were confirmed against 30 m open are test site. Therefore sufficient tests were made to demonstrate that the alternative site produces results that correlate with the ones of tests made in an open field based on KDB 414788.

Report No.: T200521W01-RP1

IC according to RSS-247 section 5.5, RSS-Gen, Section 8.9 and 8.10

**RSS-Gen Table 3 and Table 5 – General Field Strength Limits for Transmitters and Receivers at Frequencies Above 30 MHz** <sup>(Note)</sup>

Frequency (MHz)	Field Strength microvolts/m at 3 metres (watts, e.i.r.p.)	
	Transmitters	Receivers
30-88	100 (3 nW)	100 (3 nW)
88-216	150 (6.8 nW)	150 (6.8 nW)
216-960	200 (12 nW)	200 (12 nW)
Above 960	500 (75 nW)	500 (75 nW)

**Note:** Measurements for compliance with the limits in table 3 may be performed at distances other than 3 metres, in accordance with Section 6.6.

**RSS-Gen Table 6: General Field Strength Limits for Transmitters at Frequencies Below 30 MHz (Transmit)**

Frequency	Magnetic field strength (H-Field) (µA/m)	Measurement Distance (m)
9-490 kHz <sup>Note</sup>	6.37/F (F in kHz)	300
490-1,705 kHz	63.7/F (F in kHz)	30
1.705-30 MHz	0.08	30

**Note:** The emission limits for the ranges 9-90 kHz and 110-490 kHz are based on measurements employing a linear average detector.

### 4.3.2 Test Procedure

1. The EUT is placed on a turntable, Above 1 GHz is 1.5m and below 1 GHz is 0.8m above ground plane. The EUT Configured un accordance with ANSI C63.10: 2013, and the EUT set in a continuous mode.

2. The turntable shall be rotated for 360 degrees to determine the position of maximum emission level. And EUT is set 3m away from the receiving antenna, which is scanned from 1m to 4m above the ground plane to find out the highest emissions. Measurement are made polarized in both the vertical and the horizontal positions with antenna.

3. Span shall wide enough to full capture the emission measured. The SA from 9kHz to 26.5GHz set to the low, Mid and High channels with the EUT transmit.

Note: No emission found between lowest internal used/generated frequency to 30MHz(9KHz~30MHz)

4. For harmonic, the worst case of output power was BDR-1Mbps. Therefore only BDR-1Mbps record in the report.

5. The SA setting following :

(1) Below 1G : RBW = 100kHz, VBW  $\geq$  3 RBW, Sweep = Auto, Detector = Peak, Trace = Max hold.

(2) Above 1G :

(2.1) For Peak measurement : RBW = 1MHz, VBW  $\geq$  3 RBW, Sweep = Auto, Detector = Peak, Trace = Max hold.

(2.2) For Average measurement : RBW = 1MHz, VBW

·If Duty Cycle  $\geq$  98%, VBW=10Hz.

·If Duty Cycle < 98%, VBW $\geq$ 1/T.

## 4.3.3 Test Setup

### 9kHz ~ 30MHz

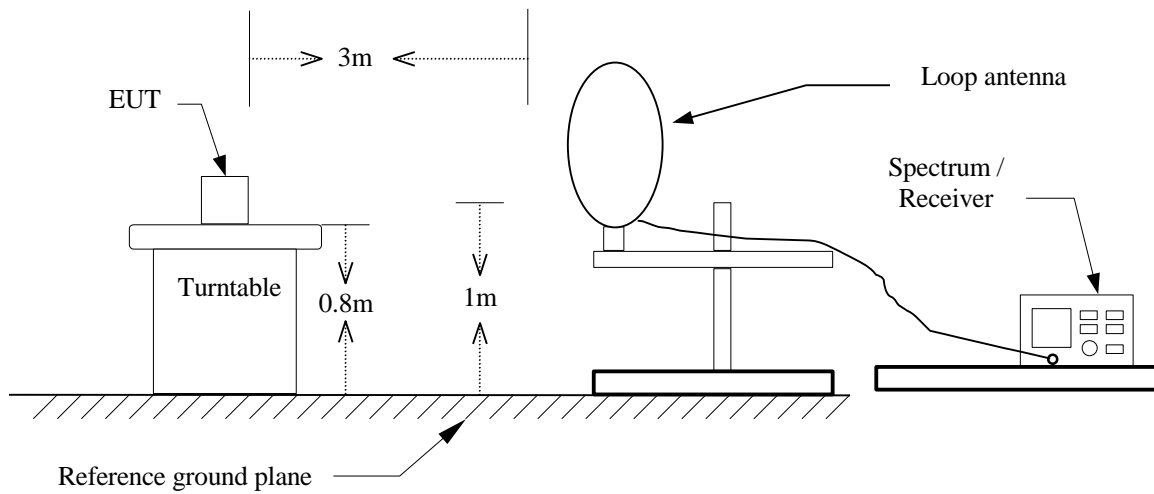

### 30MHz ~ 1GHz

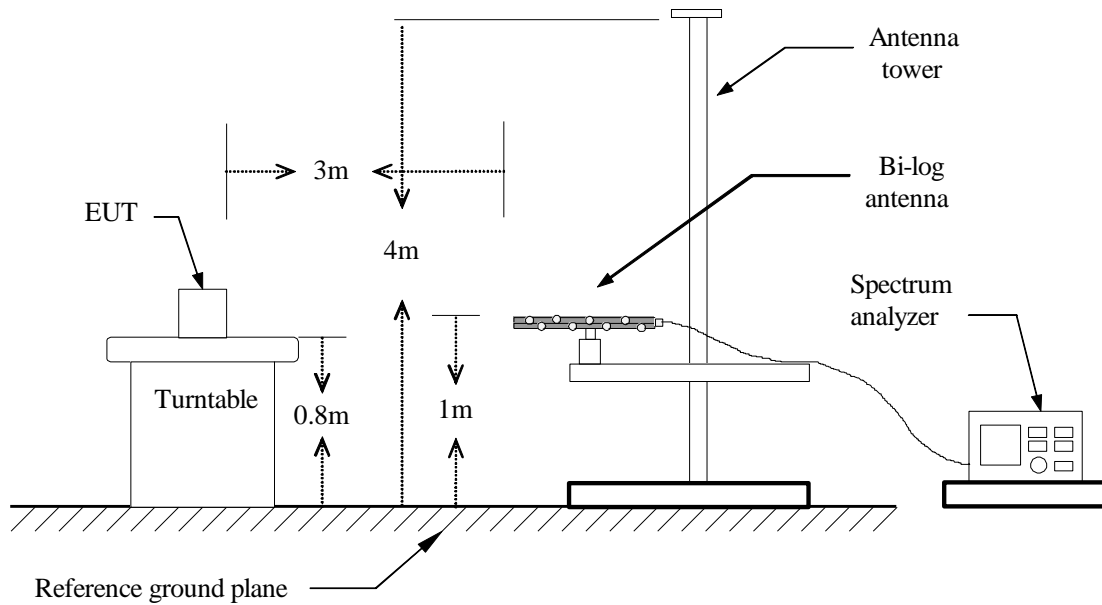

## Above 1 GHz

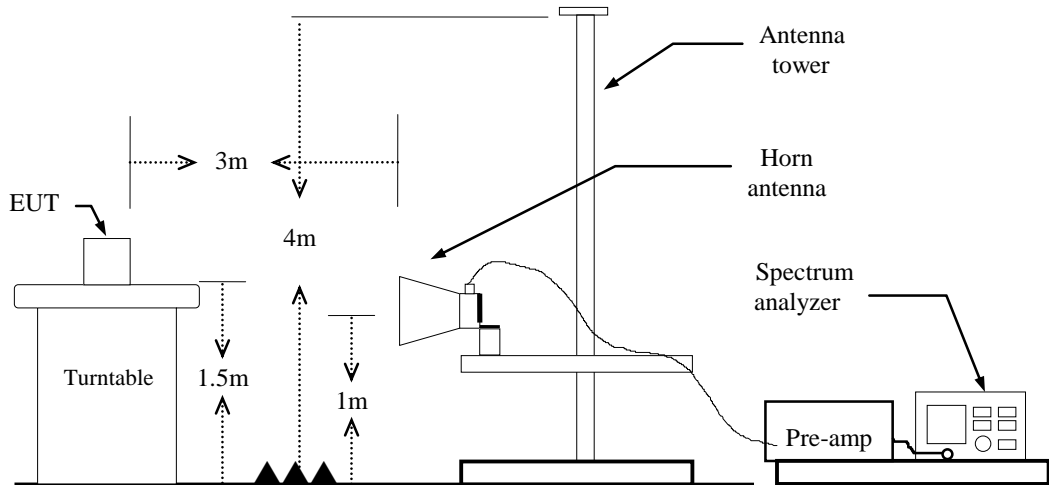

Report No.: T200521W01-RP1

### 4.3.4 Test Result

#### Band Edge Test Data

Test Mode:	GFSK_BDR-1Mbps Low CH	Temp/Hum	24.6(°C)/ 51%RH
Test Item	Band Edge	Test Date	June 3, 2020
Polarize	Vertical	Test Engineer	Jerry Chang
Detector	Peak / Average		

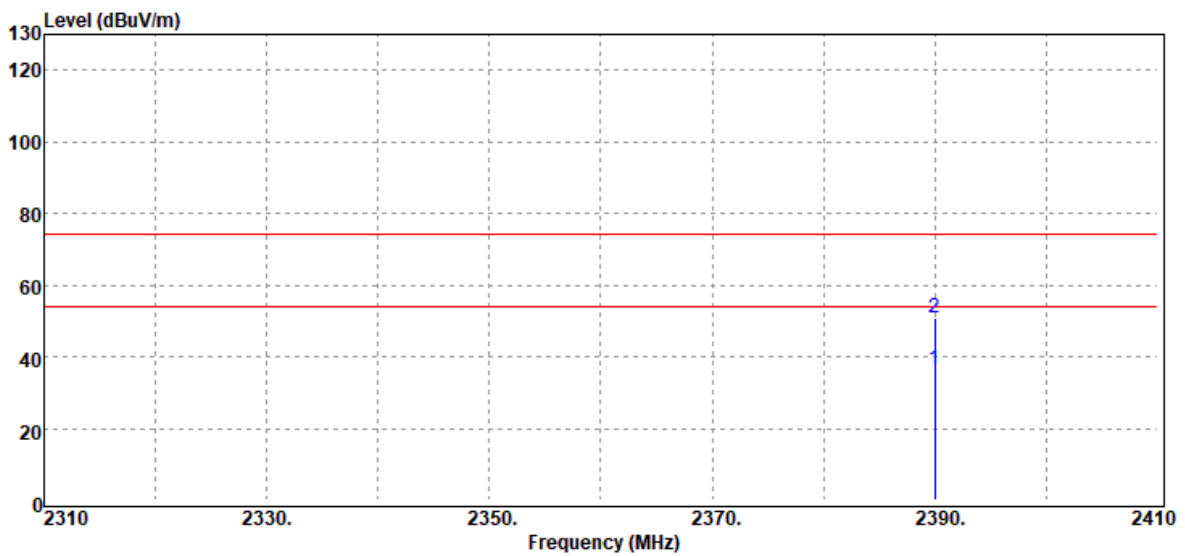

Freq. MHz	Detector Mode PK/QP/AV	Spectrum Reading Level dB $\mu$ V	Factor dB	Actual FS dB $\mu$ V/m	Limit @3m dB $\mu$ V/m	Margin dB
2390.00	Average	39.49	-3.17	36.32	54.00	-17.68
2390.00	Peak	53.96	-3.17	50.79	74.00	-23.21



Report No.: T200521W01-RP1

Test Mode:	GFSK_BDR-1Mbps Low CH	Temp/Hum	24.6(°C)/ 51%RH
Test Item	Band Edge	Test Date	June 3, 2020
Polarize	Horizontal	Test Engineer	Jerry Chang
Detector	Peak / Average		

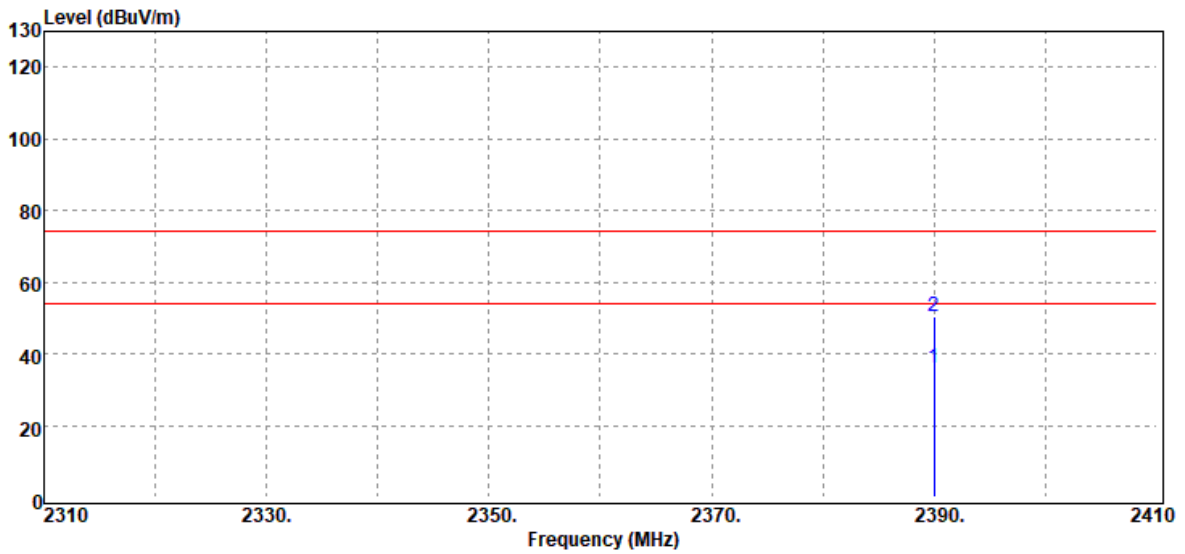

Freq. MHz	Detector Mode PK/QP/AV	Spectrum Reading Level dBµV	Factor dB	Actual FS dBµV/m	Limit @3m dBµV/m	Margin dB
2390.00	Average	39.38	-3.17	36.21	54.00	-17.79
2390.00	Peak	53.58	-3.17	50.41	74.00	-23.59

Report No.: T200521W01-RP1

Test Mode:	GFSK_BDR-1Mbps High CH	Temp/Hum	24.6(°C)/ 51%RH
Test Item	Band Edge	Test Date	June 3, 2020
Polarize	Vertical	Test Engineer	Jerry Chang
Detector	Peak / Average		

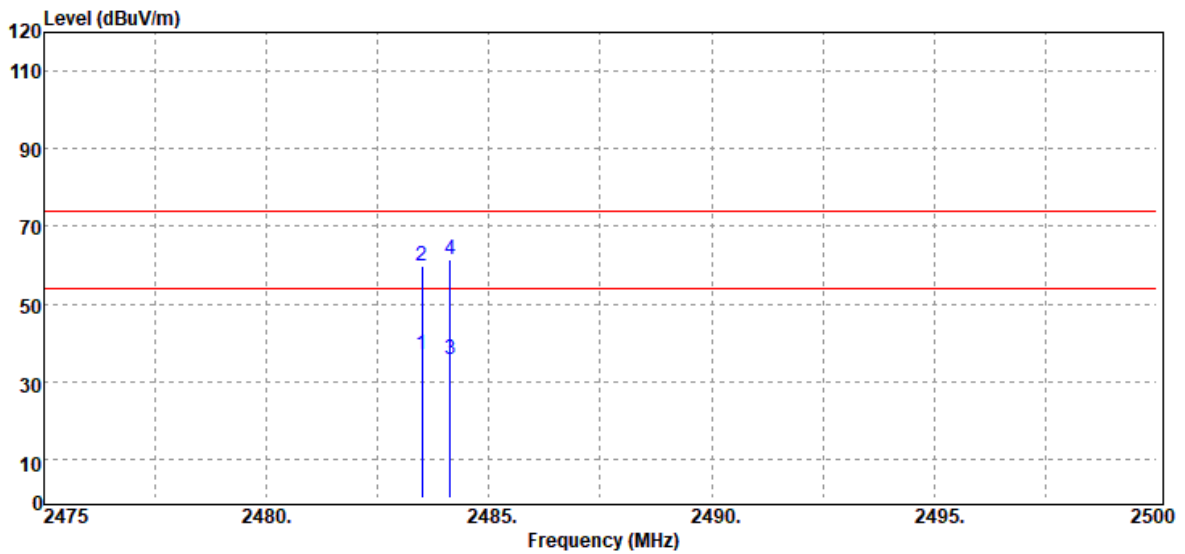

Freq. MHz	Detector Mode PK/QP/AV	Spectrum Reading Level dB $\mu$ V	Factor dB	Actual FS dB $\mu$ V/m	Limit @3m dB $\mu$ V/m	Margin dB
2483.50	Average	39.66	-2.71	36.95	54.00	-17.05
2483.50	Peak	62.64	-2.71	59.93	74.00	-14.07
2484.13	Average	38.24	-2.70	35.54	54.00	-18.46
2484.13	Peak	64.23	-2.70	61.53	74.00	-12.47

Test Mode:	GFSK_BDR-1Mbps High CH	Temp/Hum	24.6(°C)/ 51%RH
Test Item	Band Edge	Test Date	June 3, 2020
Polarize	Horizontal	Test Engineer	Jerry Chang
Detector	Peak / Average		

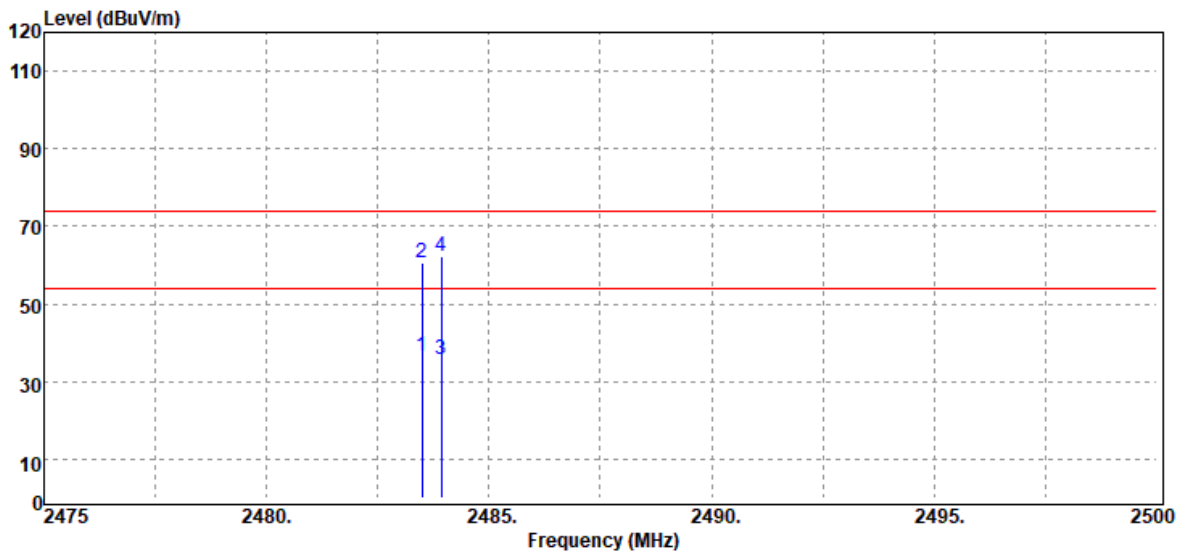

Freq. MHz	Detector Mode PK/QP/AV	Spectrum Reading Level dB $\mu$ V	Factor dB	Actual FS dB $\mu$ V/m	Limit @3m dB $\mu$ V/m	Margin dB
2483.50	Average	39.29	-2.71	36.58	54.00	-17.42
2483.50	Peak	63.15	-2.71	60.44	74.00	-13.56
2483.93	Average	38.51	-2.70	35.81	54.00	-18.19
2483.93	Peak	65.17	-2.70	62.47	74.00	-11.53

Report No.: T200521W01-RP1

Test Mode:	GFSK_BDR-1Mbps Low CH Hopping	Temp/Hum	24.6(°C)/ 51%RH
Test Item	Band Edge	Test Date	June 3, 2020
Polarize	Vertical	Test Engineer	Jerry Chang
Detector	Peak / Average		

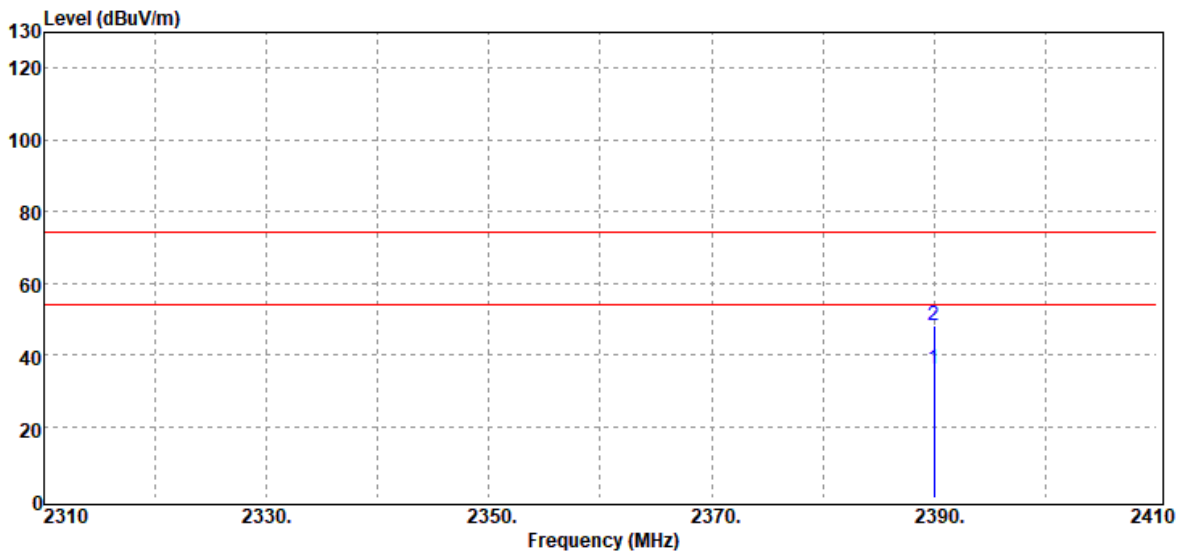

Freq. MHz	Detector Mode PK/QP/AV	Spectrum Reading Level dB $\mu$ V	Factor dB	Actual FS dB $\mu$ V/m	Limit @3m dB $\mu$ V/m	Margin dB
2390.00	Average	39.15	-3.17	35.98	54.00	-18.02
2390.00	Peak	51.17	-3.17	48.00	74.00	-26.00

Report No.: T200521W01-RP1

Test Mode:	GFSK_BDR-1Mbps Low CH Hopping	Temp/Hum	24.6(°C)/ 51%RH
Test Item	Band Edge	Test Date	June 4, 2020
Polarize	Horizontal	Test Engineer	Jerry Chang
Detector	Peak / Average		

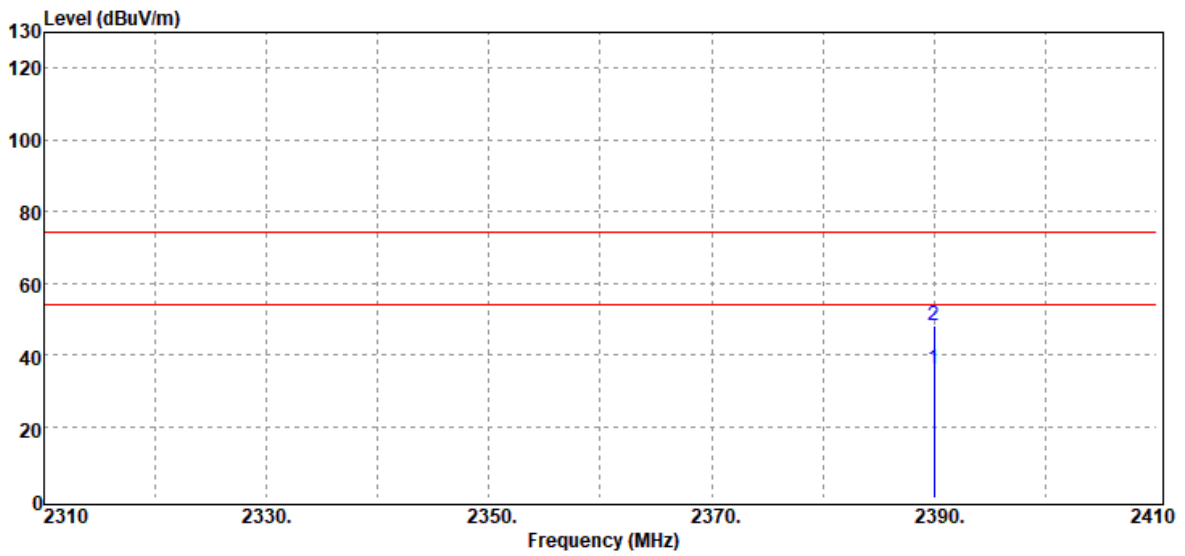

Freq. MHz	Detector Mode PK/QP/AV	Spectrum Reading Level dB $\mu$ V	Factor dB	Actual FS dB $\mu$ V/m	Limit @3m dB $\mu$ V/m	Margin dB
2390.00	Average	39.34	-3.17	36.17	54.00	-17.83
2390.00	Peak	51.14	-3.17	47.97	74.00	-26.03

Report No.: T200521W01-RP1

Test Mode:	GFSK_BDR-1Mbps High CH Hopping	Temp/Hum	24.6(°C)/ 51%RH
Test Item	Band Edge	Test Date	June 4, 2020
Polarize	Vertical	Test Engineer	Jerry Chang
Detector	Peak / Average		

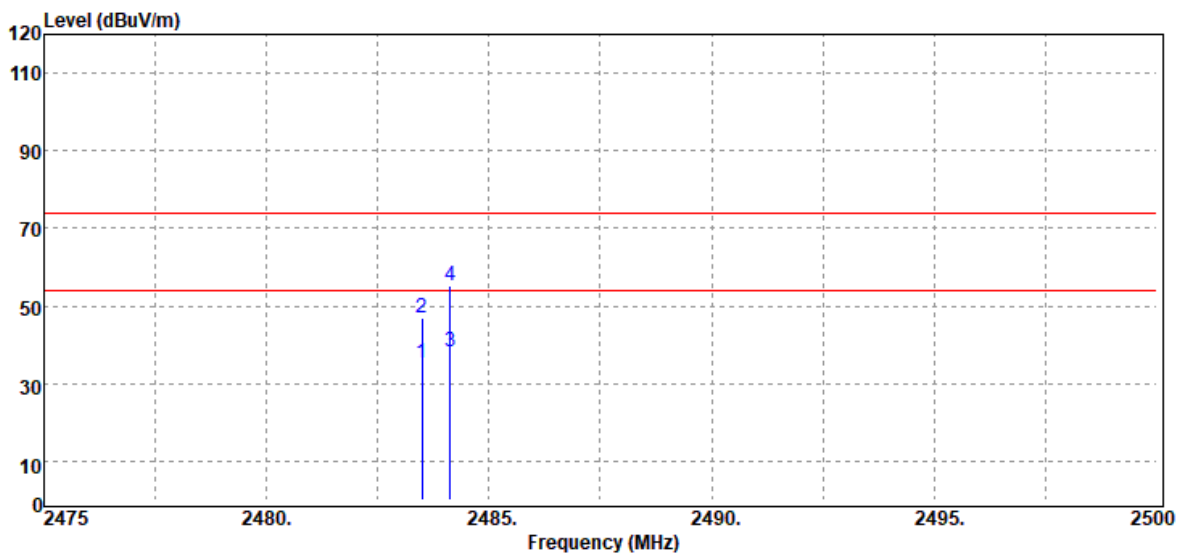

Freq. MHz	Detector Mode PK/QP/AV	Spectrum Reading Level dB $\mu$ V	Factor dB	Actual FS dB $\mu$ V/m	Limit @3m dB $\mu$ V/m	Margin dB
2483.50	Average	38.04	-2.71	35.33	54.00	-18.67
2483.50	Peak	49.47	-2.71	46.76	74.00	-27.24
2484.13	Average	40.89	-2.70	38.19	54.00	-15.81
2484.13	Peak	57.91	-2.70	55.21	74.00	-18.79

Report No.: T200521W01-RP1

Test Mode:	GFSK_BDR-1Mbps High CH Hopping	Temp/Hum	24.6(°C)/ 51%RH
Test Item	Band Edge	Test Date	June 4, 2020
Polarize	Horizontal	Test Engineer	Jerry Chang
Detector	Peak / Average		

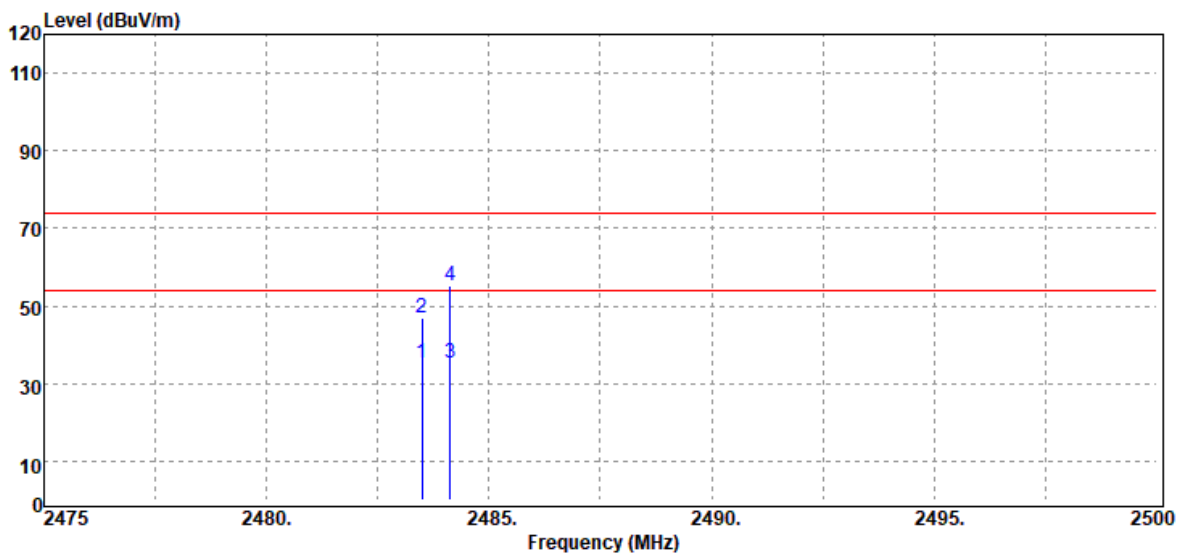

Freq. MHz	Detector Mode PK/QP/AV	Spectrum Reading Level dB $\mu$ V	Factor dB	Actual FS dB $\mu$ V/m	Limit @3m dB $\mu$ V/m	Margin dB
2483.50	Average	38.02	-2.71	35.31	54.00	-18.69
2483.50	Peak	49.47	-2.71	46.76	74.00	-27.24
2484.13	Average	37.80	-2.70	35.10	54.00	-18.90
2484.13	Peak	57.91	-2.70	55.21	74.00	-18.79

Report No.: T200521W01-RP1

Test Mode:	8DPSK_EDR-3Mbps Low CH	Temp/Hum	24.6(°C)/ 51%RH
Test Item	Band Edge	Test Date	June 4, 2020
Polarize	Vertical	Test Engineer	Jerry Chang
Detector	Peak / Average		

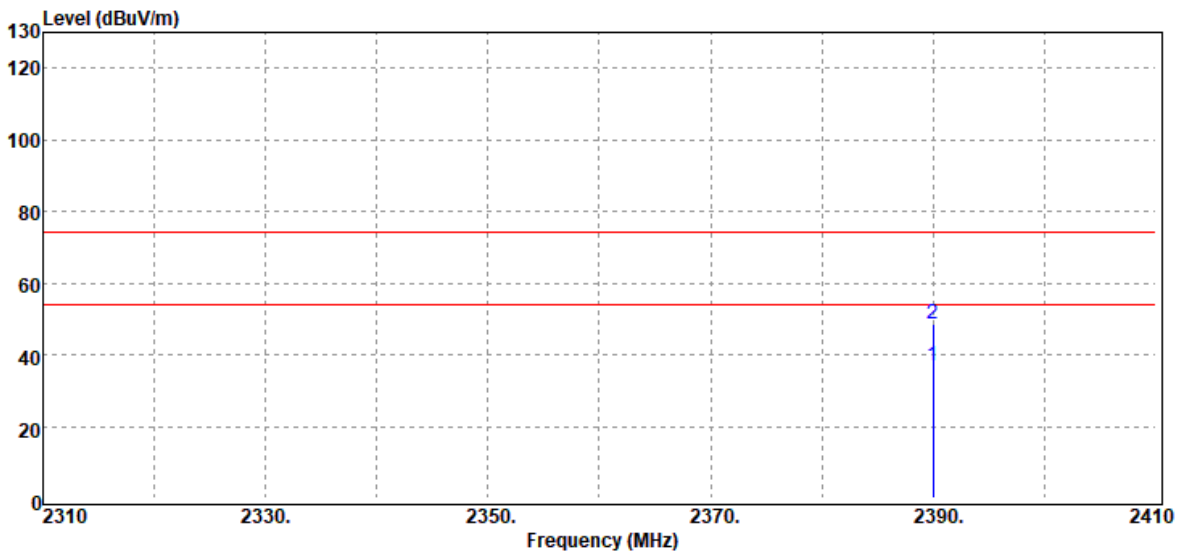

Freq. MHz	Detector Mode PK/QP/AV	Spectrum Reading Level dB $\mu$ V	Factor dB	Actual FS dB $\mu$ V/m	Limit @3m dB $\mu$ V/m	Margin dB
2390.00	Average	40.25	-3.17	37.08	54.00	-16.92
2390.00	Peak	51.86	-3.17	48.69	74.00	-25.31



Report No.: T200521W01-RP1

Test Mode:	8DPSK_EDR-3Mbps Low CH	Temp/Hum	24.6(°C)/ 51%RH
Test Item	Band Edge	Test Date	June 4, 2020
Polarize	Horizontal	Test Engineer	Jerry Chang
Detector	Peak / Average		

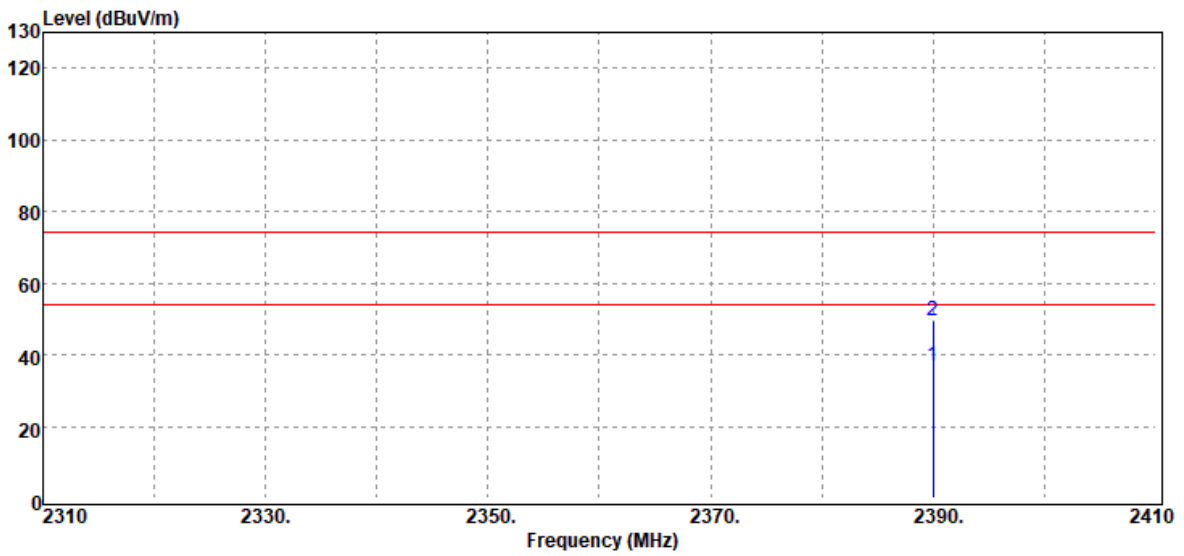

Freq. MHz	Detector Mode PK/QP/AV	Spectrum Reading Level dB $\mu$ V	Factor dB	Actual FS dB $\mu$ V/m	Limit @3m dB $\mu$ V/m	Margin dB
2390.00	Average	40.17	-3.17	37.00	54.00	-17.00
2390.00	Peak	52.64	-3.17	49.47	74.00	-24.53

Report No.: T200521W01-RP1

Test Mode:	8DPSK_EDR-3Mbps High CH	Temp/Hum	24.6(°C)/ 51%RH
Test Item	Band Edge	Test Date	June 4, 2020
Polarize	Vertical	Test Engineer	Jerry Chang
Detector	Peak / Average		

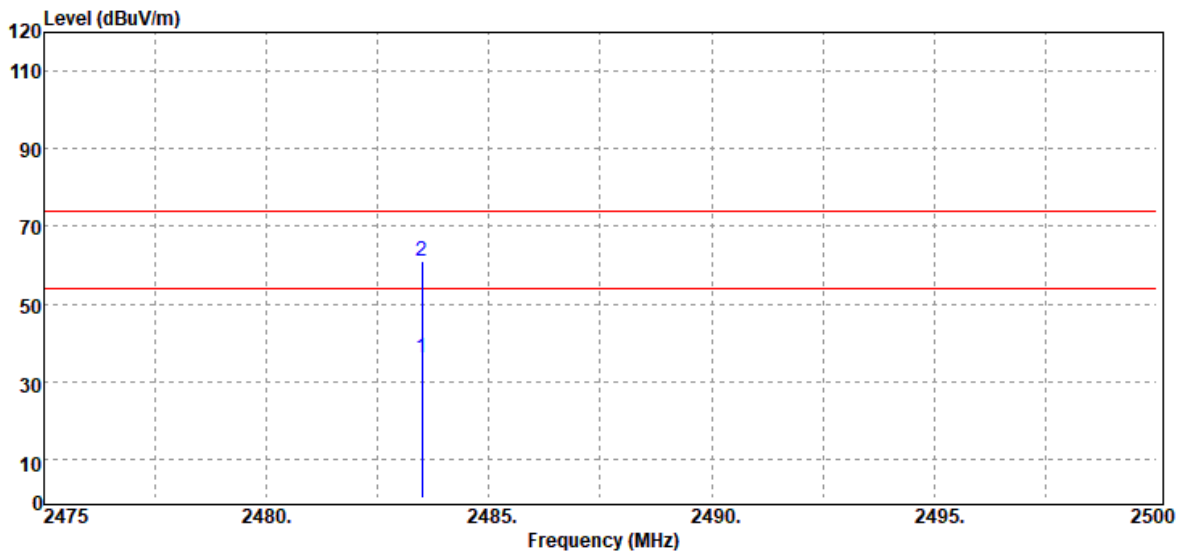

Freq. MHz	Detector Mode PK/QP/AV	Spectrum Reading Level dB $\mu$ V	Factor dB	Actual FS dB $\mu$ V/m	Limit @3m dB $\mu$ V/m	Margin dB
2483.50	Average	38.72	-2.71	36.01	54.00	-17.99
2483.50	Peak	63.66	-2.71	60.95	74.00	-13.05

Report No.: T200521W01-RP1

Test Mode:	8DPSK_EDR-3Mbps High CH	Temp/Hum	24.6(°C)/ 51%RH
Test Item	Band Edge	Test Date	June 4, 2020
Polarize	Horizontal	Test Engineer	Jerry Chang
Detector	Peak / Average		

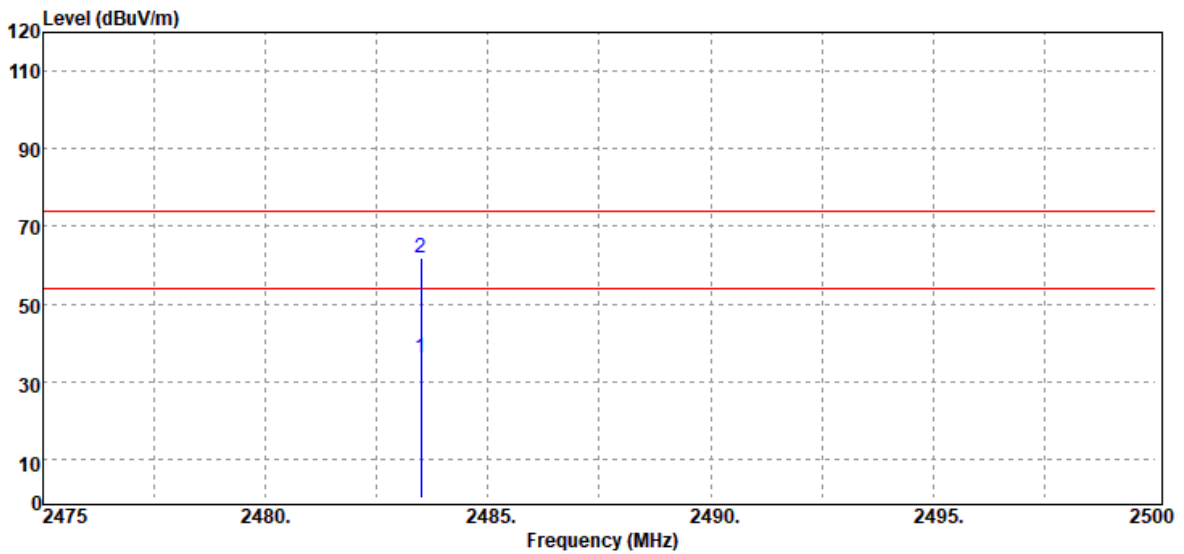

Freq. MHz	Detector Mode PK/QP/AV	Spectrum Reading Level dB $\mu$ V	Factor dB	Actual FS dB $\mu$ V/m	Limit @3m dB $\mu$ V/m	Margin dB
2483.50	Average	38.97	-2.71	36.26	54.00	-17.74
2483.50	Peak	64.52	-2.71	61.81	74.00	-12.19

Test Mode:	8DPSK_EDR-3Mbps Low CH Hopping	Temp/Hum	24.6(°C)/ 51%RH
Test Item	Band Edge	Test Date	June 4, 2020
Polarize	Vertical	Test Engineer	Jerry Chang
Detector	Peak / Average		

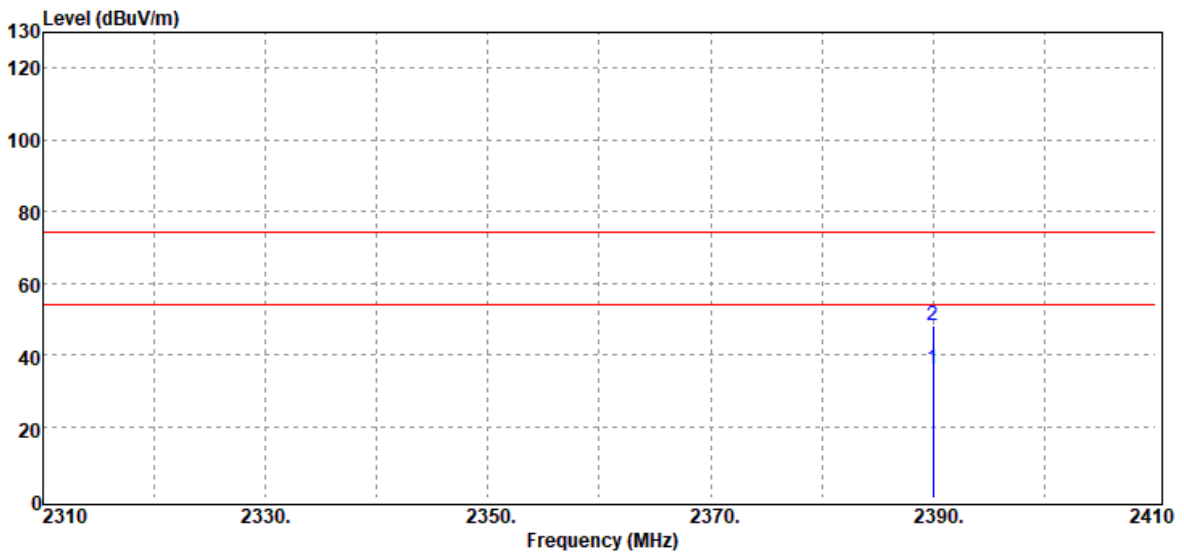

Freq. MHz	Detector Mode PK/QP/AV	Spectrum Reading Level dB $\mu$ V	Factor dB	Actual FS dB $\mu$ V/m	Limit @3m dB $\mu$ V/m	Margin dB
2390.00	Average	39.38	-3.17	36.21	54.00	-17.79
2390.00	Peak	51.41	-3.17	48.24	74.00	-25.76

Test Mode:	8DPSK_EDR-3Mbps Low CH Hopping	Temp/Hum	24.6(°C)/ 51%RH
Test Item	Band Edge	Test Date	June 4, 2020
Polarize	Horizontal	Test Engineer	Jerry Chang
Detector	Peak / Average		

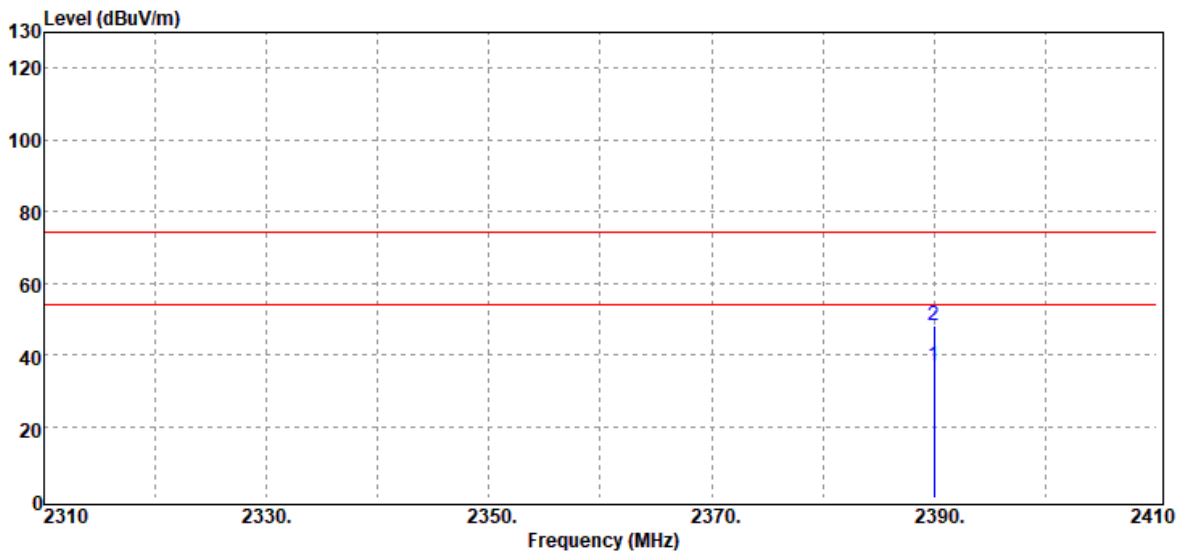

Freq. MHz	Detector Mode PK/QP/AV	Spectrum Reading Level dB $\mu$ V	Factor dB	Actual FS dB $\mu$ V/m	Limit @3m dB $\mu$ V/m	Margin dB
2390.00	Average	40.19	-3.17	37.02	54.00	-16.98
2390.00	Peak	51.36	-3.17	48.19	74.00	-25.81

Report No.: T200521W01-RP1

Test Mode:	8DPSK_EDR-3Mbps High CH Hopping	Temp/Hum	24.6(°C)/ 51%RH
Test Item	Band Edge	Test Date	June 4, 2020
Polarize	Vertical	Test Engineer	Jerry Chang
Detector	Peak / Average		

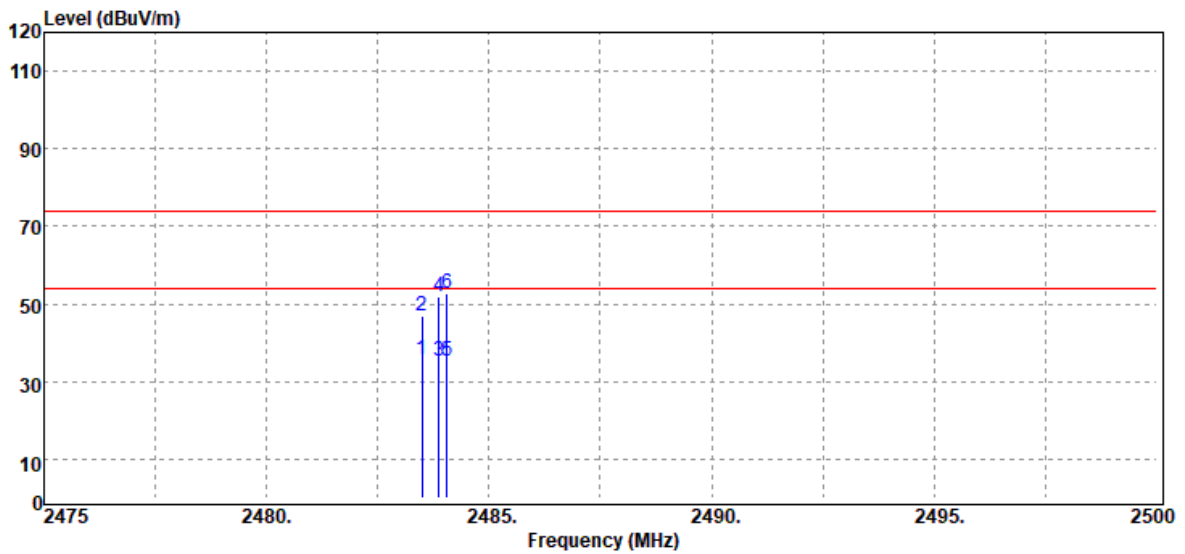

Freq. MHz	Detector Mode PK/QP/AV	Spectrum Reading Level dB $\mu$ V	Factor dB	Actual FS dB $\mu$ V/m	Limit @3m dB $\mu$ V/m	Margin dB
2483.50	Average	38.38	-2.71	35.67	54.00	-18.33
2483.50	Peak	49.50	-2.71	46.79	74.00	-27.21
2483.88	Average	38.06	-2.70	35.36	54.00	-18.64
2483.88	Peak	54.80	-2.70	52.10	74.00	-21.90
2484.05	Average	37.96	-2.70	35.26	54.00	-18.74
2484.05	Peak	55.53	-2.70	52.83	74.00	-21.17

Report No.: T200521W01-RP1

Test Mode:	8DPSK_EDR-3Mbps High CH Hopping	Temp/Hum	24.6(°C)/ 51%RH
Test Item	Band Edge	Test Date	June 4, 2020
Polarize	Horizontal	Test Engineer	Jerry Chang
Detector	Peak / Average		

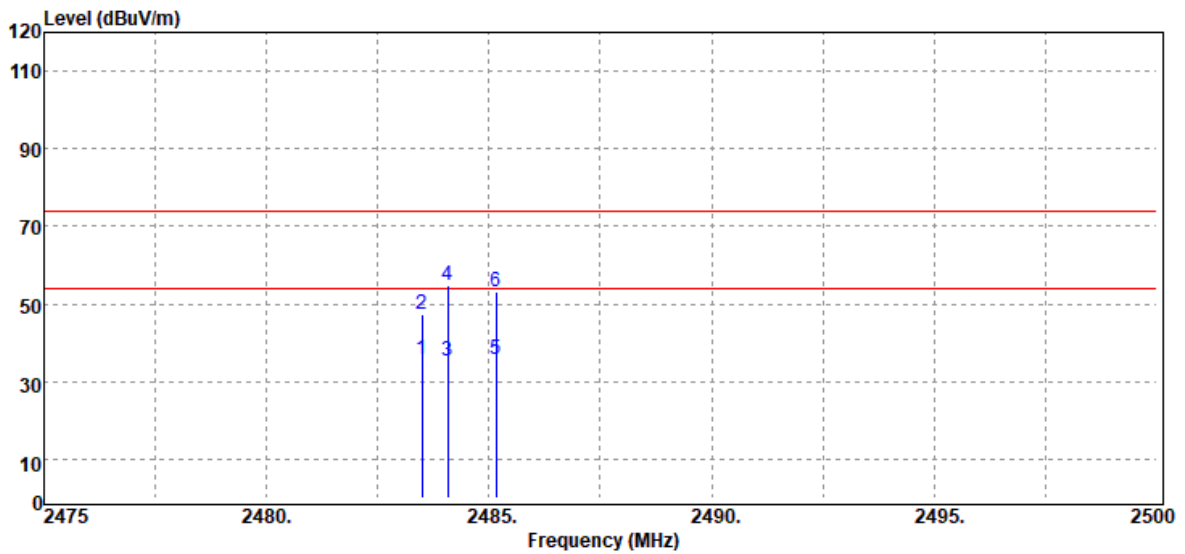

Freq. MHz	Detector Mode PK/QP/AV	Spectrum Reading Level dB $\mu$ V	Factor dB	Actual FS dB $\mu$ V/m	Limit @3m dB $\mu$ V/m	Margin dB
2483.50	Average	38.22	-2.71	35.51	54.00	-18.49
2483.50	Peak	49.97	-2.71	47.26	74.00	-26.74
2484.08	Average	38.20	-2.70	35.50	54.00	-18.50
2484.08	Peak	57.48	-2.70	54.78	74.00	-19.22
2485.15	Average	38.37	-2.70	35.67	54.00	-18.33
2485.15	Peak	56.00	-2.70	53.30	74.00	-20.70

Report No.: T200521W01-RP1

**Below 1G Test Data**

Test Mode:	BT Mode	Temp/Hum	24.6(°C)/ 51%RH
Test Item	30MHz-1GHz	Test Date	June 8, 2020
Polarize	Vertical	Test Engineer	Jerry Chang
Detector	Peak		

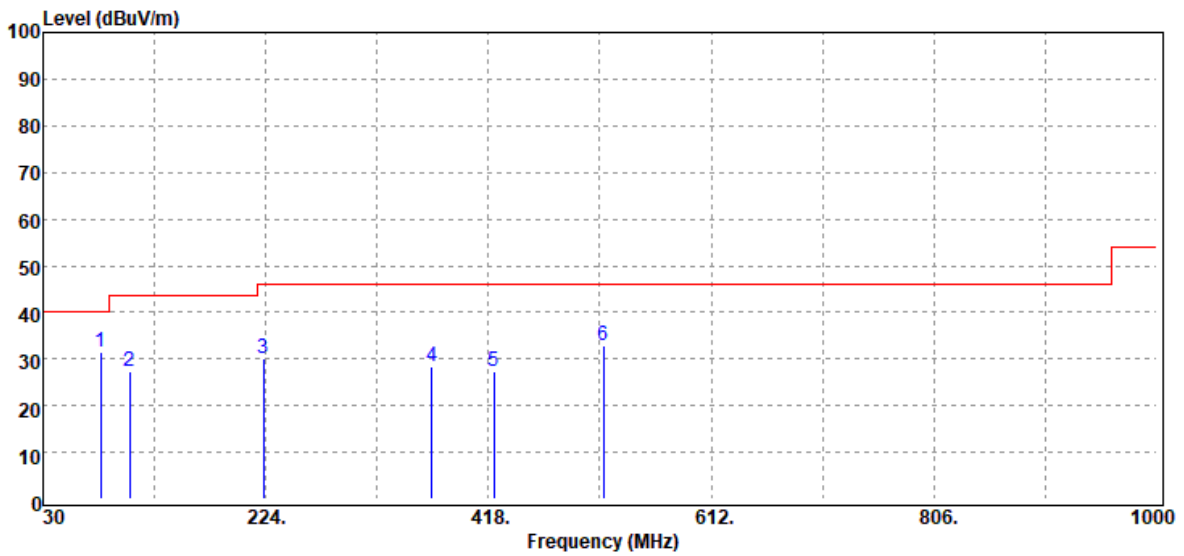

Freq. MHz	Detector Mode PK/QP/AV	Spectrum Reading Level dBμV	Factor dB	Actual FS dBμV/m	Limit @3m dBμV/m	Margin dB
80.44	Peak	47.03	-15.52	31.51	40.00	-8.49
105.66	Peak	38.60	-11.23	27.37	43.50	-16.13
222.06	Peak	41.75	-11.63	30.12	46.00	-15.88
368.53	Peak	35.17	-6.64	28.53	46.00	-17.47
422.85	Peak	32.40	-4.99	27.41	46.00	-18.59
517.91	Peak	36.03	-3.07	32.96	46.00	-13.04



Report No.: T200521W01-RP1

Test Mode:	BT Mode	Temp/Hum	24.6(°C)/ 51%RH
Test Item	30MHz-1GHz	Test Date	June 3, 2020
Polarize	Horizontal	Test Engineer	Jerry Chang
Detector	Peak		

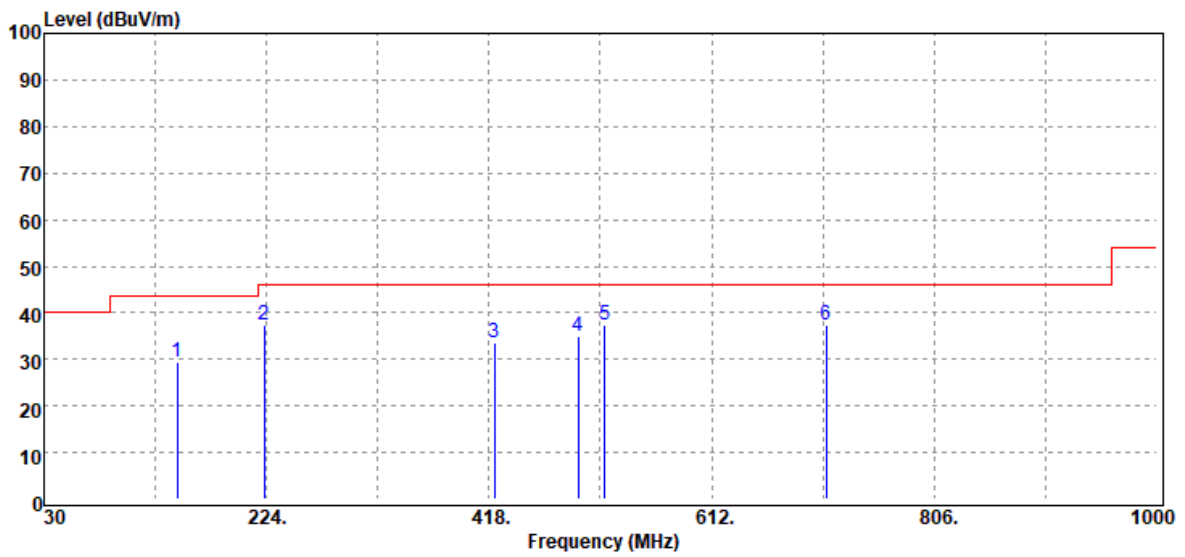

Freq. MHz	Detector Mode PK/QP/AV	Spectrum Reading Level dBμV	Factor dB	Actual FS dBμV/m	Limit @3m dBμV/m	Margin dB
146.40	Peak	39.77	-10.29	29.48	43.50	-14.02
222.06	Peak	49.01	-11.63	37.38	46.00	-8.62
422.85	Peak	38.54	-4.99	33.55	46.00	-12.45
495.60	Peak	38.04	-3.20	34.84	46.00	-11.16
518.88	Peak	40.34	-3.06	37.28	46.00	-8.72
711.91	Peak	37.02	0.38	37.40	46.00	-8.60

Report No.: T200521W01-RP1

**Above 1G Test Data**

Test Mode:	GFSK_BDR-1Mbps Low CH	Temp/Hum	24.6(°C)/ 51%RH
Test Item	Harmonic	Test Date	June 8, 2020
Polarize	Vertical	Test Engineer	Jerry Chang
Detector	Peak		

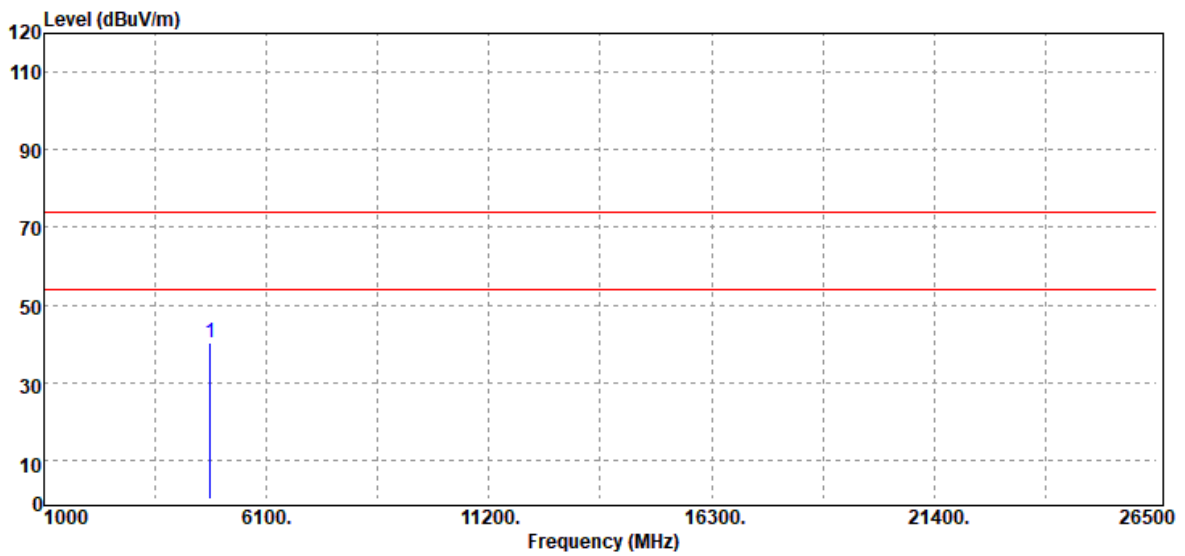

Freq. MHz	Detector Mode PK/QP/AV	Spectrum Reading Level dBuV	Factor dB	Actual FS dBuV/m	Limit @3m dBuV/m	Margin dB
4804.00	Peak	37.06	3.36	40.42	74.00	-33.58
N/A						

**Remark:**

1. Measuring frequencies from 1 GHz to the 10th harmonic of highest fundamental frequency.
2. For above 1GHz, the EUT peak value was under average limit, therefore the Average value compliance with the average limit

Report No.: T200521W01-RP1

Test Mode:	GFSK_BDR-1Mbps Low CH	Temp/Hum	24.6(°C)/ 51%RH
Test Item	Harmonic	Test Date	June 8, 2020
Polarize	Horizontal	Test Engineer	Jerry Chang
Detector	Peak		

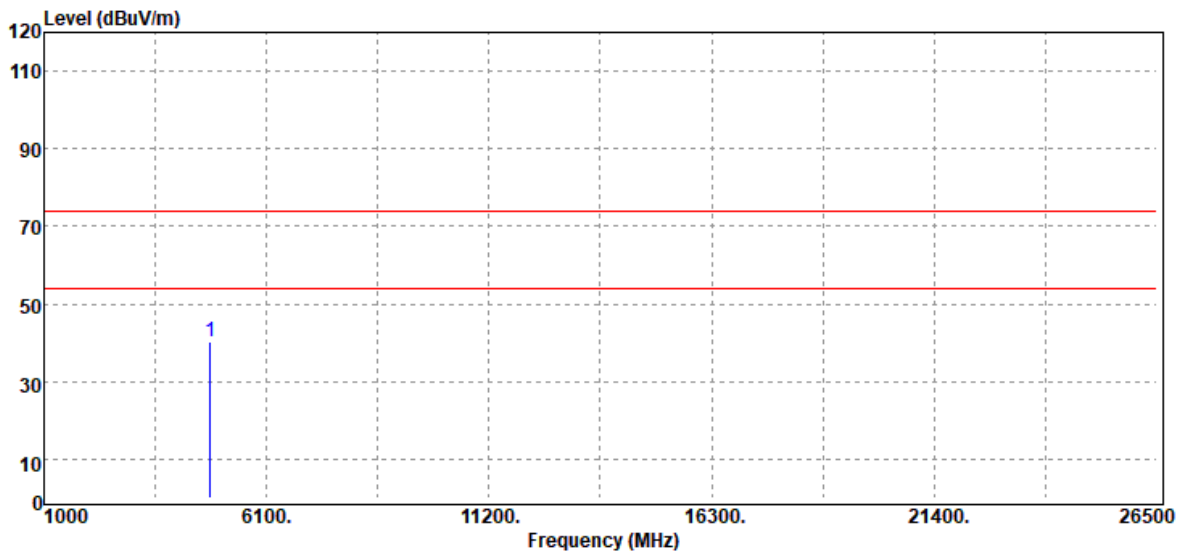

Freq. MHz	Detector Mode PK/QP/AV	Spectrum Reading Level dB $\mu$ V	Factor dB	Actual FS dB $\mu$ V/m	Limit @3m dB $\mu$ V/m	Margin dB
4804.00	Peak	37.00	3.36	40.36	74.00	-33.64
N/A						

**Remark:**

1. Measuring frequencies from 1 GHz to the 10<sup>th</sup> harmonic of highest fundamental frequency.
2. For above 1GHz, the EUT peak value was under average limit, therefore the Average value compliance with the average limit

Report No.: T200521W01-RP1

Test Mode:	GFSK_BDR-1Mbps Mid CH	Temp/Hum	24.6(°C)/ 51%RH
Test Item	Harmonic	Test Date	June 8, 2020
Polarize	Vertical	Test Engineer	Jerry Chang
Detector	Peak		

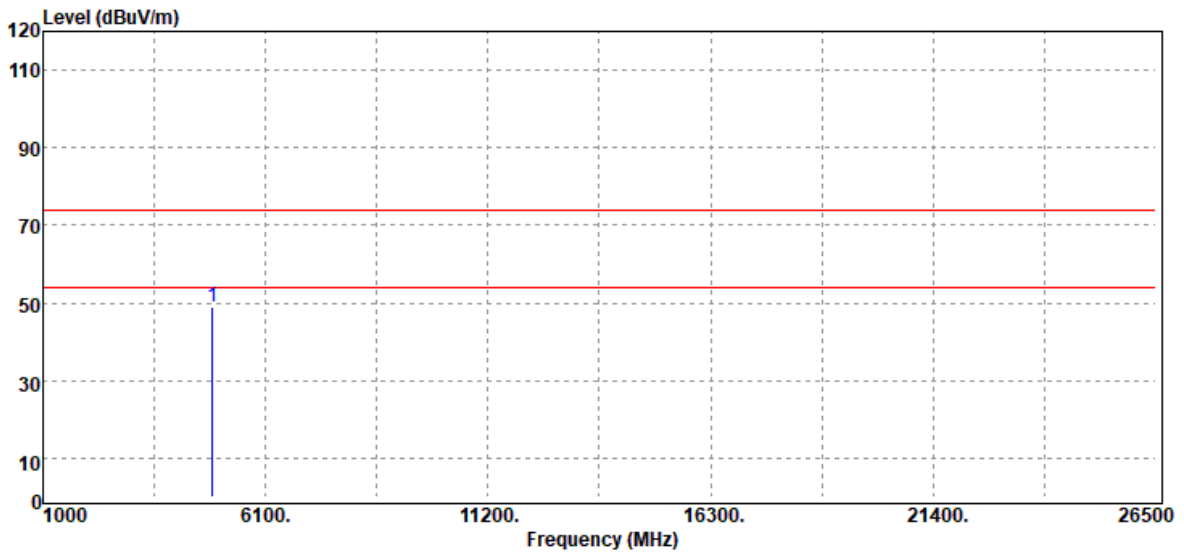

Freq. MHz	Detector Mode PK/QP/AV	Spectrum Reading Level dBuV	Factor dB	Actual FS dBuV/m	Limit @3m dBuV/m	Margin dB
4882.00	Peak	45.62	3.52	49.14	74.00	-24.86
N/A						

**Remark:**

1. Measuring frequencies from 1 GHz to the 10<sup>th</sup> harmonic of highest fundamental frequency.
2. For above 1GHz, the EUT peak value was under average limit, therefore the Average value compliance with the average limit

Report No.: T200521W01-RP1

Test Mode:	GFSK_BDR-1Mbps Mid CH	Temp/Hum	24.6(°C)/ 51%RH
Test Item	Harmonic	Test Date	June 8, 2020
Polarize	Horizontal	Test Engineer	Jerry Chang
Detector	Peak		

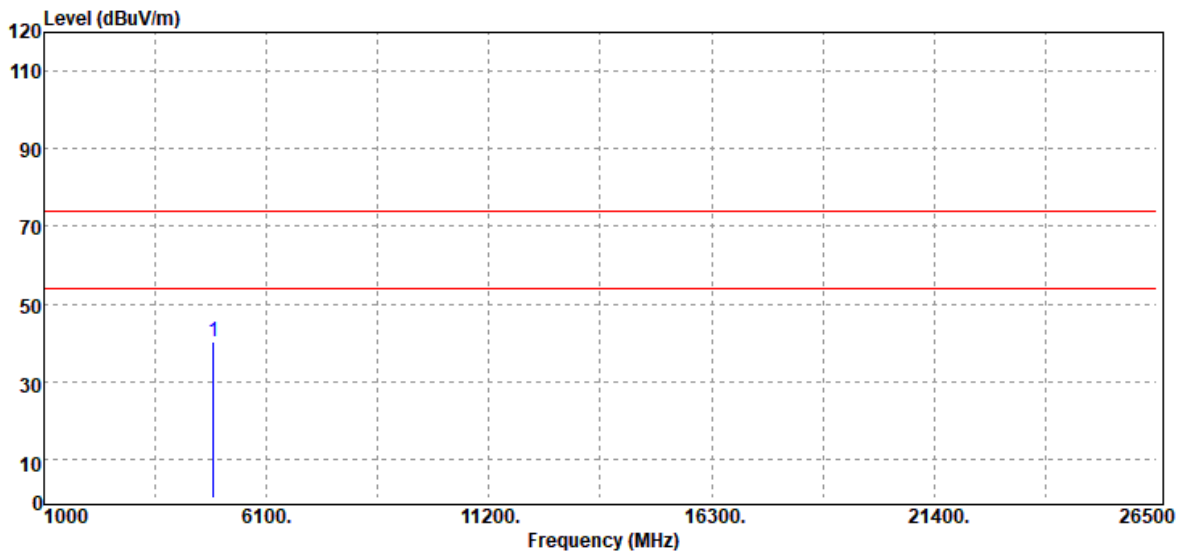

Freq. MHz	Detector Mode PK/QP/AV	Spectrum Reading Level dBuV	Factor dB	Actual FS dBuV/m	Limit @3m dBuV/m	Margin dB
4882.00	Peak	36.90	3.52	40.42	74.00	-33.58
N/A						

**Remark:**

1. Measuring frequencies from 1 GHz to the 10th harmonic of highest fundamental frequency.
2. For above 1GHz, the EUT peak value was under average limit, therefore the Average value compliance with the average limit

Report No.: T200521W01-RP1

Test Mode:	GFSK_BDR-1Mbps High CH	Temp/Hum	24.6(°C)/ 51%RH
Test Item	Harmonic	Test Date	June 8, 2020
Polarize	Vertical	Test Engineer	Jerry Chang
Detector	Peak		

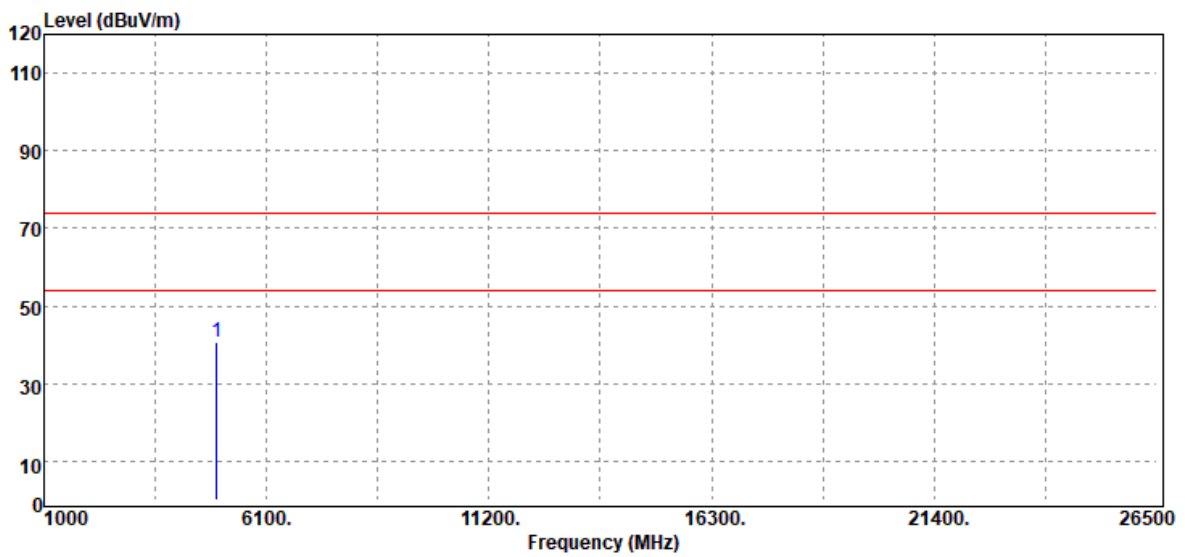

Freq. MHz	Detector Mode PK/QP/AV	Spectrum Reading Level dB $\mu$ V	Factor dB	Actual FS dB $\mu$ V/m	Limit @3m dB $\mu$ V/m	Margin dB
4960.00	Peak	36.21	4.46	40.67	74.00	-33.33
N/A						

**Remark:**

1. Measuring frequencies from 1 GHz to the 10th harmonic of highest fundamental frequency.
2. For above 1GHz, the EUT peak value was under average limit, therefore the Average value compliance with the average limit

Report No.: T200521W01-RP1

Test Mode:	GFSK_BDR-1Mbps High CH	Temp/Hum	24.6(°C)/ 51%RH
Test Item	Harmonic	Test Date	June 8, 2020
Polarize	Horizontal	Test Engineer	Jerry Chang
Detector	Peak		

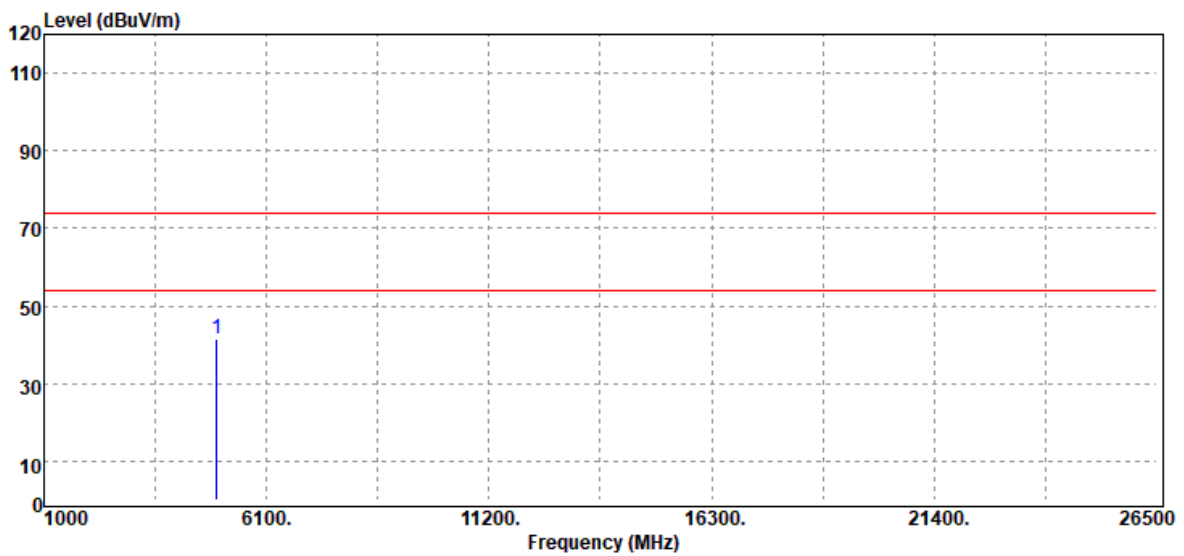

Freq. MHz	Detector Mode PK/QP/AV	Spectrum Reading Level dB $\mu$ V	Factor dB	Actual FS dB $\mu$ V/m	Limit @3m dB $\mu$ V/m	Margin dB
4960.00	Peak	36.94	4.46	41.40	74.00	-32.60
N/A						

**Remark:**

1. Measuring frequencies from 1 GHz to the 10th harmonic of highest fundamental frequency.
2. For above 1GHz, the EUT peak value was under average limit, therefore the Average value compliance with the average limit

Report No.: T200521W01-RP1

Test Mode	8DPSK_EDR-3Mbps Low CH	Temp/Hum	24.6(°C)/ 51%RH
Test Item	Harmonic	Test Date	June 8, 2020
Polarize	Vertical	Test Engineer	Jerry Chang
Detector	Peak		

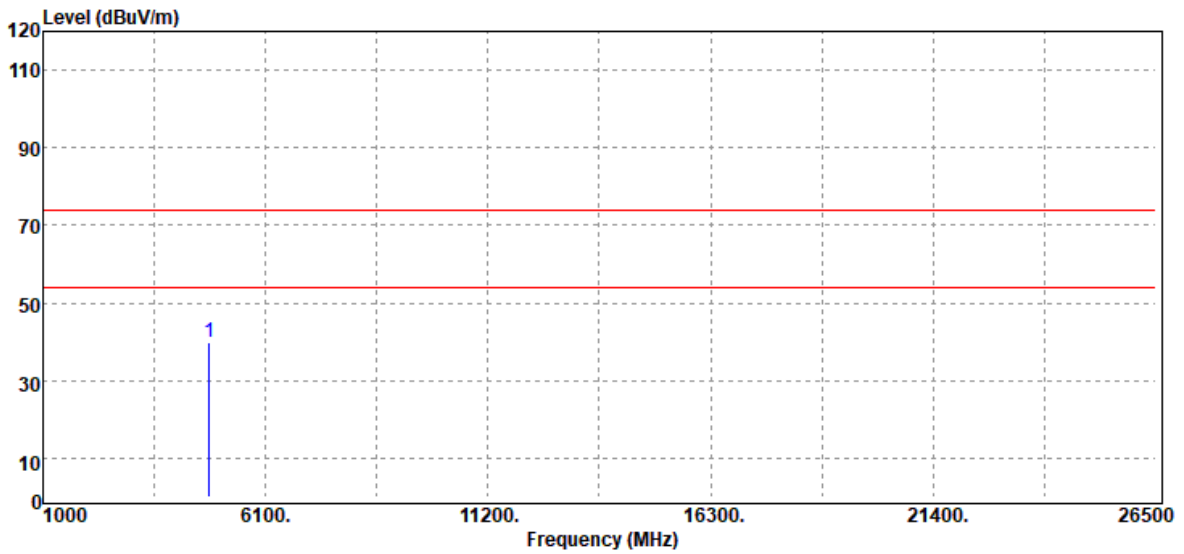

Freq. MHz	Detector Mode PK/QP/AV	Spectrum Reading Level dB $\mu$ V	Factor dB	Actual FS dB $\mu$ V/m	Limit @3m dB $\mu$ V/m	Margin dB
4804.00	Peak	36.42	3.36	39.78	74.00	-34.22
N/A						

**Remark:**

1. Measuring frequencies from 1 GHz to the 10<sup>th</sup> harmonic of highest fundamental frequency.
2. For above 1GHz, the EUT peak value was under average limit, therefore the Average value compliance with the average limit



Report No.: T200521W01-RP1

Test Mode	8DPSK_EDR-3Mbps Low CH	Temp/Hum	24.6(°C)/ 51%RH
Test Item	Harmonic	Test Date	June 8, 2020
Polarize	Horizontal	Test Engineer	Jerry Chang
Detector	Peak		

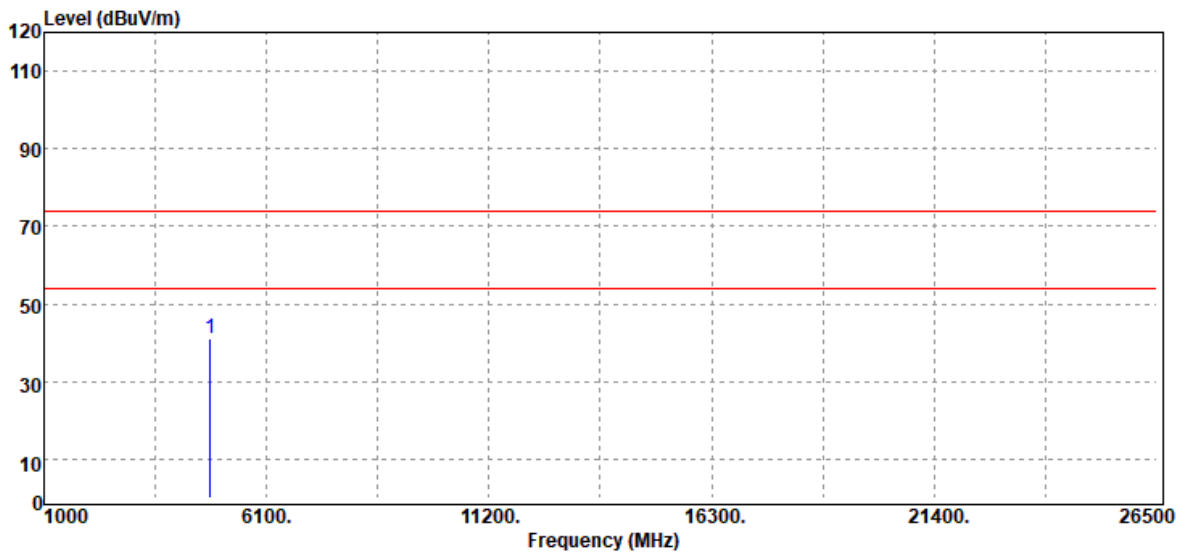

Freq. MHz	Detector Mode PK/QP/AV	Spectrum Reading Level dB $\mu$ V	Factor dB	Actual FS dB $\mu$ V/m	Limit @3m dB $\mu$ V/m	Margin dB
4804.00	Peak	37.84	3.36	41.20	74.00	-32.80
N/A						

**Remark:**

1. Measuring frequencies from 1 GHz to the 10th harmonic of highest fundamental frequency.
2. For above 1GHz, the EUT peak value was under average limit, therefore the Average value compliance with the average limit

Report No.: T200521W01-RP1

Test Mode	8DPSK_EDR-3Mbps Mid CH	Temp/Hum	24.6(°C)/ 51%RH
Test Item	Harmonic	Test Date	June 8, 2020
Polarize	Vertical	Test Engineer	Jerry Chang
Detector	Peak		

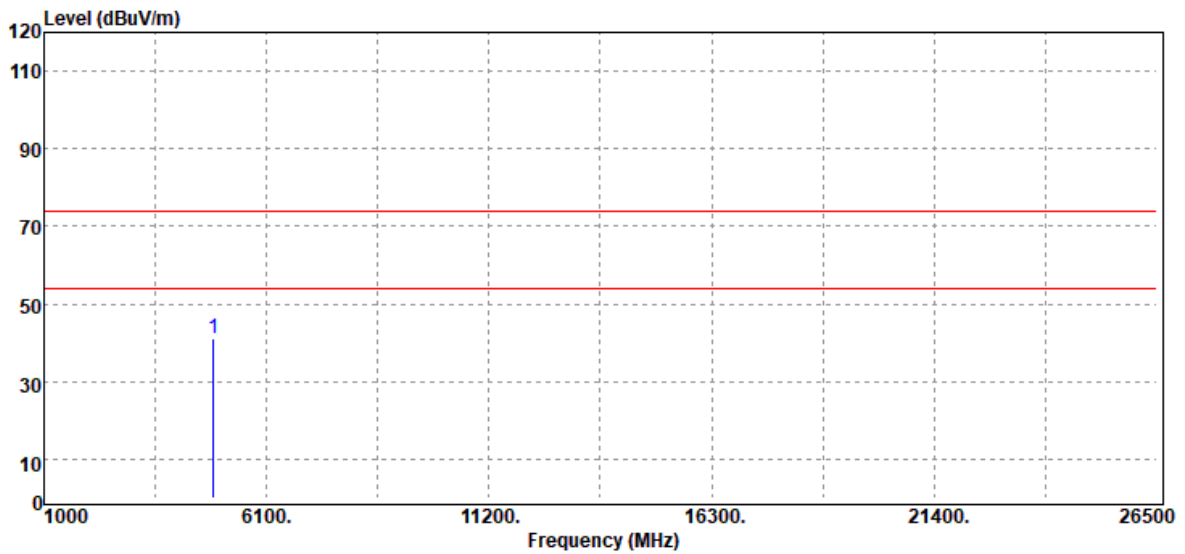

Freq. MHz	Detector Mode PK/QP/AV	Spectrum Reading Level dB $\mu$ V	Factor dB	Actual FS dB $\mu$ V/m	Limit @3m dB $\mu$ V/m	Margin dB
4882.00	Peak	37.59	3.52	41.11	74.00	-32.89
N/A						

**Remark:**

1. Measuring frequencies from 1 GHz to the 10<sup>th</sup> harmonic of highest fundamental frequency.
2. For above 1GHz, the EUT peak value was under average limit, therefore the Average value compliance with the average limit

Report No.: T200521W01-RP1

Test Mode	8DPSK_EDR-3Mbps Mid CH	Temp/Hum	24.6(°C)/ 51%RH
Test Item	Harmonic	Test Date	June 8, 2020
Polarize	Horizontal	Test Engineer	Jerry Chang
Detector	Peak		

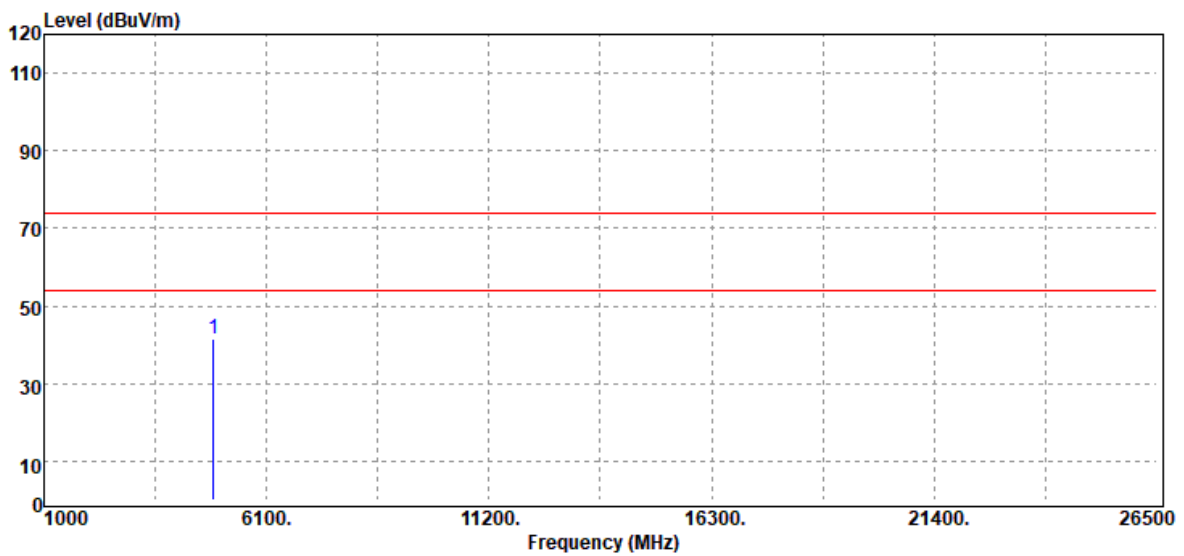

Freq. MHz	Detector Mode PK/QP/AV	Spectrum Reading Level dB $\mu$ V	Factor dB	Actual FS dB $\mu$ V/m	Limit @3m dB $\mu$ V/m	Margin dB
4882.00	Peak	38.17	3.52	41.69	74.00	-32.31
N/A						

**Remark:**

1. Measuring frequencies from 1 GHz to the 10th harmonic of highest fundamental frequency.
2. For above 1GHz, the EUT peak value was under average limit, therefore the Average value compliance with the average limit

Report No.: T200521W01-RP1

Test Mode	8DPSK_EDR-3Mbps High CH	Temp/Hum	24.6(°C)/ 51%RH
Test Item	Harmonic	Test Date	June 8, 2020
Polarize	Vertical	Test Engineer	Jerry Chang
Detector	Peak		

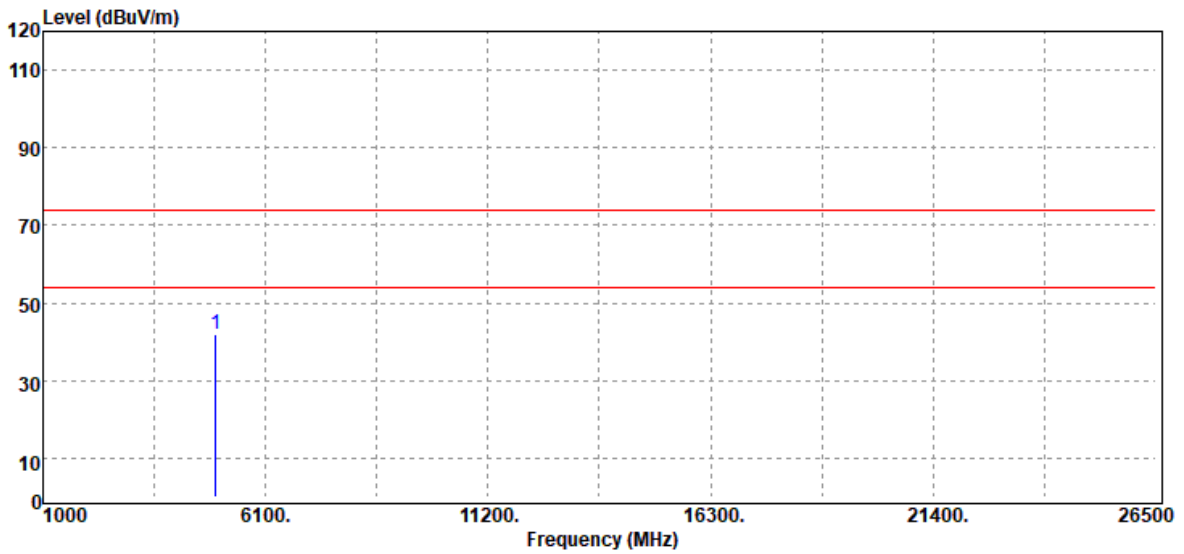

Freq. MHz	Detector Mode PK/QP/AV	Spectrum Reading Level dB $\mu$ V	Factor dB	Actual FS dB $\mu$ V/m	Limit @3m dB $\mu$ V/m	Margin dB
4960.00	Peak	37.43	4.46	41.89	74.00	-32.11
N/A						

**Remark:**

1. Measuring frequencies from 1 GHz to the 10th harmonic of highest fundamental frequency.
2. For above 1GHz, the EUT peak value was under average limit, therefore the Average value compliance with the average limit

Report No.: T200521W01-RP1

Test Mode	8DPSK_EDR-3Mbps High CH	Temp/Hum	24.6(°C)/ 51%RH
Test Item	Harmonic	Test Date	June 8, 2020
Polarize	Horizontal	Test Engineer	Jerry Chang
Detector	Peak		

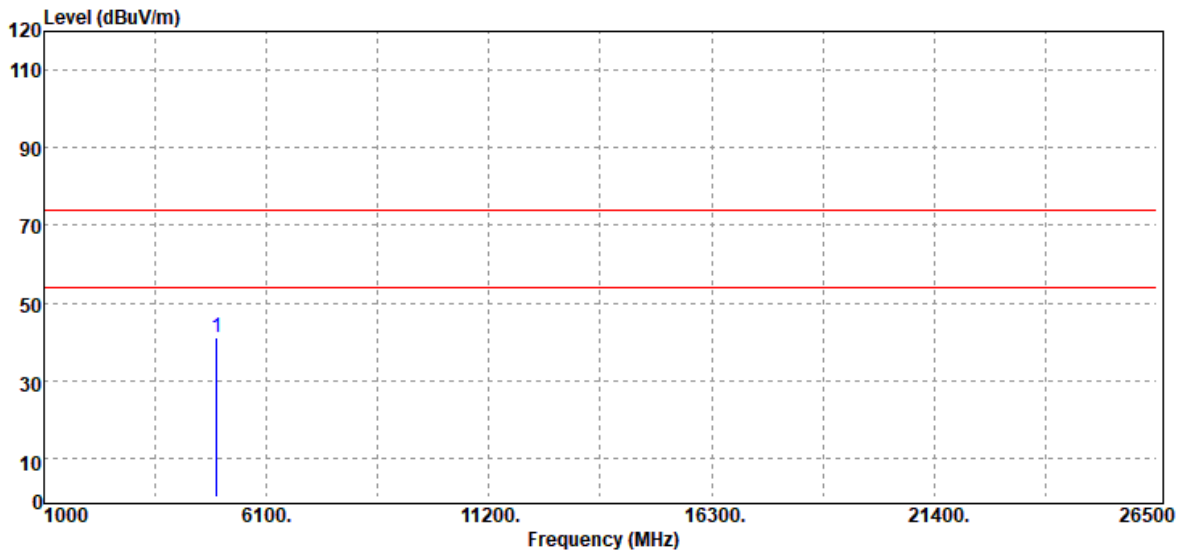

Freq. MHz	Detector Mode PK/QP/AV	Spectrum Reading Level dB $\mu$ V	Factor dB	Actual FS dB $\mu$ V/m	Limit @3m dB $\mu$ V/m	Margin dB
4960.00	Peak	36.60	4.46	41.06	74.00	-32.94
N/A						

**Remark:**

1. Measuring frequencies from 1 GHz to the 10th harmonic of highest fundamental frequency.
2. For above 1GHz, the EUT peak value was under average limit, therefore the Average value compliance with the average limit

## 4.4 TEST DATA RE-USE SUMMARY

### Introduction Section:

The application re-uses data collected on a similar device. The subject device of this application (Model: MP21-ARGON-C, FCC ID: GKR402550, IC: 2533B-402550) is electrically identical to the reference device (Model: MP10-ARGON-C, FCC ID: GKR402547, IC: 2533B-402547) for the portions of the circuitry corresponding to the data being re-used, as treated by KDB Publication 484596 D01.

### Differences Brief Description:

The WLAN, and BT hardware of this device are identical to the implementation in FCC ID: GKR402550.

IC: 2533B-402550

The Product Equality Declaration document includes detailed information about the changes between the devices. The data from that application has been verified through appropriate spot checks to demonstrate compliance for this device as shown in the summary table below.

### Spot Check Verification Result Summary

Equipment Class	Reference FCC ID / IC No.	Folder Test	Report Title/ Section
DSS	GKR402547 / 2533B-402547	T200505W01-RP1	All Section (Except for <i>AC Conducted Emission, Output Power Measurement, Radiation Band Edge, Radiation Spurious Emission</i> )

### Summary of the spot check for Unlicensed bands and Licensed bands

In order to confirm hardware similarity of the subject device with the reference device, we used same setting power to conducted measurement were performed on the subject device for the conducted band edge and conducted emission, the test result were similar with FCC ID: GKR402547 / IC: 2533B-402547.

#### WLAN

Report	Test Item	CH.	GKR402547 / 2533B-402547	GKR402550 / 2533B-402550	Gap (dB)
DSS	Conducted Bandedge	Low	-50.98	-49.12	-1.86
	Conducted Emission	Low	-55.55	-53.98	-1.57

**- End of Test Report -**