



FCC ID: GKR402546
Report No.: T200504W06-RP3

IC: 2533B-402546

Page: 1 / 94
Rev.: 00

RADIO TEST REPORT

FCC 47 CFR PART 15 SUBPART C

INDUSTRY CANADA RSS-247

Test Standard	FCC Part 15.247 IC RSS-247 issue 2 and IC RSS-GEN issue 5
Product name	Tablet
Brand Name	ICON/iFit
Model No.	MP7-ARGON-C
Test Result	Pass
Statements of Conformity	Determination of compliance is based on the results of the compliance measurement, not taking into account measurement instrumentation uncertainty.

The test Result was tested by Compliance Certification Services Inc. The test data, data evaluation, test procedures, and equipment configurations shown in this report were given in ANSI C63.10: 2013 and compliance standards.

The test results of this report relate only to the tested sample (EUT) identified in this report.

The test Report of full or partial shall not copy. Without written approval of Compliance Certification Services Inc. (Wugu Laboratory).

Approved by:

Kevin Tsai
Deputy Manager



Report No.: T200504W06-RP3

Page: 2 / 94

Rev.: 00

Revision History

Rev.	Issue Date	Revisions	Effect Page	Revised By
00	June 23, 2020	Initial Issue	ALL	Allison Chen

Table of contents

1.	GENERAL INFORMATION.....	4
1.1	EUT INFORMATION.....	4
1.2	EUT CHANNEL INFORMATION.....	5
1.3	ANTENNA INFORMATION.....	5
1.4	MEASUREMENT UNCERTAINTY.....	6
1.5	FACILITIES AND TEST LOCATION.....	7
1.6	INSTRUMENT CALIBRATION.....	7
1.7	SUPPORT AND EUT ACCESSORIES EQUIPMENT.....	8
1.8	TEST METHODOLOGY AND APPLIED STANDARDS.....	8
2.	TEST SUMMERY.....	9
3.	DESCRIPTION OF TEST MODES.....	10
3.1	THE WORST MODE OF OPERATING CONDITION.....	10
3.2	THE WORST MODE OF MEASUREMENT.....	11
4.	EUT DUTY CYCLE.....	12
5.	TEST RESULT.....	13
5.1	AC POWER LINE CONDUCTED EMISSION.....	13
5.2	6dB BANDWIDTH AND OCCUPIED BANDWIDTH(99%).....	16
5.3	OUTPUT POWER MEASUREMENT.....	26
5.4	POWER SPECTRAL DENSITY.....	29
5.5	CONDUCTED BANDEDGE AND SPURIOUS EMISSION.....	35
5.6	RADIATION BANDEDGE AND SPURIOUS EMISSION.....	48
APPENDIX 1 - PHOTOGRAPHS OF EUT		

1. GENERAL INFORMATION

1.1 EUT INFORMATION

FCC Applicant	Compal Electronics Inc No.581 & 581-1, Ruiguang Rd., Neihu District, Taipei city, 11492 Taiwan
IC Applicant	COMPAL ELECTRONICS INC. No. 581 & 581-1, Ruiguang Rd., Neihu District Taipei R.O.C. 114 Taiwan
Manufacturer	Compal Electronics Inc No.581 & 581-1, Ruiguang Rd., Neihu District, Taipei city, 11492 Taiwan
Equipment	Tablet
Model No.	MP7-ARGON-C
Model Discrepancy	N/A
Trade Name	ICON/iFit
Received Date	May 4, 2020
Date of Test	May 8 ~ 13, 2020
Power Supply	EUT Power from Host device (DC12V)
HW Version	LA-J301P
SW Version	Android 8

Report No.: T200504W06-RP3

1.2 EUT CHANNEL INFORMATION

Frequency Range	802.11b/g/n HT 20: 2412MHz ~ 2462MHz 802.11n HT 40: 2422MHz ~ 2452MHz
Modulation Type	1. IEEE 802.11b mode: CCK 2. IEEE 802.11g mode: OFDM 3. IEEE 802.11n HT 20 MHz mode : OFDM 4. IEEE 802.11n HT 40 MHz mode : OFDM
Number of channel	1. IEEE 802.11b mode: 11 Channels 2. IEEE 802.11g mode: 11 Channels 3. IEEE 802.11n HT 20 MHz mode : 11 Channels 4. IEEE 802.11n HT 40 MHz mode : 7 Channels

Remark:

Refer as ANSI C63.10: 2013 clause 5.6.1 Table 4 and RSS-GEN Table A1 for test channels

Number of frequencies to be tested		
Frequency range in which device operates	Number of frequencies	Location in frequency range of operation
<input type="checkbox"/> 1 MHz or less	1	Middle
<input type="checkbox"/> 1 MHz to 10 MHz	2	1 near top and 1 near bottom
<input checked="" type="checkbox"/> More than 10 MHz	3	1 near top, 1 near middle, and 1 near bottom

1.3 ANTENNA INFORMATION

Antenna Type	<input checked="" type="checkbox"/> PIFA <input type="checkbox"/> PCB <input type="checkbox"/> Dipole <input type="checkbox"/> Coils
Antenna Gain	0.67 dBi
Antenna Connector	IPEX

1.4 MEASUREMENT UNCERTAINTY

PARAMETER	UNCERTAINTY
AC Powerline Conducted Emission	+/- 1.2575
Emission bandwidth, 20dB bandwidth	+/- 0.0014
RF output power, conducted	+/- 1.14
Power density, conducted	+/- 1.40
3M Semi Anechoic Chamber / 30M~200M	+/- 4.12
3M Semi Anechoic Chamber / 200M~1000M	+/- 4.68
3M Semi Anechoic Chamber / 1G~8G	+/- 5.18
3M Semi Anechoic Chamber / 8G~18G	+/- 5.47
3M Semi Anechoic Chamber / 18G~26G	+/- 3.81
3M Semi Anechoic Chamber / 26G~40G	+/- 3.87

Remark:

1. This uncertainty represents an expanded uncertainty expressed at approximately the 95% confidence level using a coverage factor of $k=2$
2. ISO/IEC 17025 requires that an estimate of the measurement uncertainties associated with the emissions test results be included in the report.

Report No.: T200504W06-RP3

1.5 FACILITIES AND TEST LOCATION

All measurement facilities used to collect the measurement data are located at

No.11, Wugong 6th Rd., Wugu Dist., New Taipei City, Taiwan. (R.O.C.)

Test site	Test Engineer	Remark
AC Conduction Room	Dally Hong	-
Radiation	Jerry Chang	-
RF Conducted	Dally Hong	-

Remark: The sites are constructed in conformance with the requirements of ANSI C63.7, ANSI C63.4 and CISPR Publication 22.

1.6 INSTRUMENT CALIBRATION

RF Conducted Test Site					
Name of Equipment	Manufacturer	Model	Serial Number	Calibration Date	Calibration Due
Coaxial Cable	Woken	WC12	CC003	06/28/2019	06/27/2020
Coaxial Cable	Woken	WC12	CC001	06/28/2019	06/27/2020
EXA Signal Analyzer	KEYSIGHT	N9010B	MY55460167	07/31/2019	07/30/2020
Power Meter	Anritsu	ML2495A	1149001	05/23/2019	05/22/2020
Power Seneor	Anritsu	MA2491A	030982	05/23/2019	05/22/2020
Software	N/A				

3M 966 Chamber Test Site					
Equipment	Manufacturer	Model	S/N	Cal Date	Cal Due
Band Reject Filters	MICRO TRONICS	BRM 50702	120	02/25/2020	02/24/2021
Bilog Antenna	Sunol Sciences	JB3	A030105	07/26/2019	07/25/2020
Coaxial Cable	HUBER SUHNER	SUCOFLEX 104PEA	20995	02/25/2020	02/24/2021
Coaxial Cable	EMCI	EMC105	190914+25111	09/20/2019	09/19/2020
Digital Thermo-Hygro Meter	WISEWIND	1206	D07	01/15/2020	01/14/2021
double Ridged Guide Horn Antenna	ETC	MCTD 1209	DRH13M02003	10/04/2019	10/03/2020
Loop Ant	COM-POWER	AL-130	121051	03/27/2020	03/26/2021
Pre-Amplifier	EMEC	EM330	060609	02/25/2020	02/24/2021
Pre-Amplifier	HP	8449B	3008A00965	02/25/2020	02/24/2021
PSA Series Spectrum Analyzer	Agilent	E4446A	MY46180323	05/29/2019	05/28/2020
Antenna Tower	CCS	CC-A-1F	N/A	N.C.R	N.C.R
Controller	CCS	CC-C-1F	N/A	N.C.R	N.C.R
Turn Table	CCS	CC-T-1F	N/A	N.C.R	N.C.R
Software	e3 6.11-20180413				

Remark: Each piece of equipment is scheduled for calibration once a year.

Conducted Emission Room # B					
Name of Equipment	Manufacturer	Model	Serial Number	Calibration Date	Calibration Due
CABLE	EMCI	CFD300-NL	CERF	06/27/2019	06/26/2020
EMI Test Receiver	R&S	ESCI	100064	07/26/2019	07/25/2020
LISN	SCHAFFNER	NNB 41	03/10013	02/13/2020	02/12/2021
Software	EZ-EMC(CCS-3A1-CE)				

Remark: Each piece of equipment is scheduled for calibration once a year.

1.7 SUPPORT AND EUT ACCESSORIES EQUIPMENT

EUT Accessories Equipment					
No.	Equipment	Brand	Model	Series No.	FCC ID
	N/A				

Support Equipment					
No.	Equipment	Brand	Model	Series No.	FCC ID
1	Adapter	WEIHAI POWER	HAS060123-EA	N/A	N/A

1.8 TEST METHODOLOGY AND APPLIED STANDARDS

The test methodology, setups and results comply with all requirements in accordance with ANSI C63.10:2013, FCC Part 2, FCC Part 15.247, KDB 558074 D01, RSS-247 Issue 2 and RSS-GEN Issue 5.

2. TEST SUMMERY

FCC Standard Section	IC Standard Section	Report Section	Test Item	Result
15.203	-	1.3	Antenna Requirement	Pass
15.207(a)	RSS-GEN 8.8	4.1	AC Conducted Emission	Pass
15.247(a)(2)	RSS-247(5.2)(a)	4.2	6 dB Bandwidth	Pass
-	RSS-GEN 6.6	4.2	Occupied Bandwidth (99%)	Pass
15.247(b)(3)	RSS-247(5.4)(d)	4.3	Output Power Measurement	Pass
15.247(e)	RSS-247(5.2)(b)	4.4	Power Spectral Density	Pass
15.247(d)	RSS-247(5.5)	4.5	Conducted Band Edge	Pass
15.247(d)	RSS-247(5.5)	4.5	Conducted Emission	Pass
15.247(d)	RSS-GEN 8.9, 8.10	4.6	Radiation Band Edge	Pass
15.247(d)	RSS-GEN 8.9, 8.10	4.6	Radiation Spurious Emission	Pass

3. DESCRIPTION OF TEST MODES

3.1 THE WORST MODE OF OPERATING CONDITION

<p>Operation mode</p>	<p>IEEE 802.11b mode :1Mbps IEEE 802.11g mode :6Mbps IEEE 802.11n HT20 mode :MCS0 IEEE 802.11n HT40 mode :MCS0</p>
<p>Test Channel Frequencies</p>	<p>IEEE 802.11b mode : 1. Lowest Channel : 2412MHz 2. Middle Channel : 2437MHz 3. Highest Channel : 2462MHz IEEE 802.11g mode : 1. Lowest Channel : 2412MHz 2. Middle Channel : 2437MHz 3. Highest Channel : 2462MHz IEEE 802.11n HT20 mode : 1. Lowest Channel : 2412MHz 2. Middle Channel : 2437MHz 3. Highest Channel : 2462MHz IEEE 802.11n HT40 mode : 1. Lowest Channel : 2422MHz 2. Middle Channel : 2437MHz 3. Highest Channel : 2452MHz</p>
<p>Operation Transmitter</p>	<p>IEEE 802.11b mode :1T1R IEEE 802.11g mode :1T1R IEEE 802.11n HT20 mode : 1T1R IEEE 802.11n HT40 mode : 1T1R</p>

Remark:

1. EUT pre-scanned data rate of output power for each mode, the worst data rate were recorded in this report.

Report No.: T200504W06-RP3

3.2 THE WORST MODE OF MEASUREMENT

AC Power Line Conducted Emission	
Test Condition	AC Power line conducted emission for line and neutral
Power supply Mode	Mode 1: EUT power by Host Device.
Worst Mode	<input checked="" type="checkbox"/> Mode 1 <input type="checkbox"/> Mode 2 <input type="checkbox"/> Mode 3 <input type="checkbox"/> Mode 4

Radiated Emission Measurement Below 1G	
Test Condition	Radiated Emission Below 1G
Power supply Mode	Mode 1: EUT power by Host Device.
Worst Mode	<input checked="" type="checkbox"/> Mode 1 <input type="checkbox"/> Mode 2 <input type="checkbox"/> Mode 3 <input type="checkbox"/> Mode 4

Radiated Emission Measurement Above 1G	
Test Condition	Radiated Emission Above 1G
Power supply Mode	Mode 1: EUT power by Host Device.
Worst Mode	<input checked="" type="checkbox"/> Mode 1 <input type="checkbox"/> Mode 2 <input type="checkbox"/> Mode 3 <input type="checkbox"/> Mode 4
Worst Position	<input type="checkbox"/> Placed in fixed position. <input type="checkbox"/> Placed in fixed position at X-Plane (E2-Plane) <input checked="" type="checkbox"/> Placed in fixed position at Y-Plane (E1-Plane) <input type="checkbox"/> Placed in fixed position at Z-Plane (H-Plane)

Remark:

1. The worst mode was record in this test report.
2. EUT pre-scanned in three axis ,X,Y, Z and two polarity, for radiated measurement. The worst case(Y-Plane) were recorded in this report
3. AC power line conducted emission and for below 1G radiation emission were performed the EUT transmit at the highest output power channel as worse case.

Report No.: T200504W06-RP3

4. EUT DUTY CYCLE

Duty Cycle				
Configuration	Duty Cycle (%)	Duty Factor (dB) =10*log (1/Duty Cycle)	1/T (kHz)	VBW setting (kHz)
802.11b	99.67%	0.01	N/A	0.01
802.11g	97.48%	0.11	0.72	1.00
802.11n HT20	94.88%	0.23	1.50	2.00
802.11n HT40	90.77%	0.42	2.91	3.00



Report No.: T200504W06-RP3

5. TEST RESULT

5.1 AC POWER LINE CONDUCTED EMISSION

5.1.1 Test Limit

According to §15.207(a) and RSS-GEN section 8.8,

Frequency Range (MHz)	Limits(dBµV)	
	Quasi-peak	Average
0.15 to 0.50	66 to 56*	56 to 46*
0.50 to 5	56	46
5 to 30	60	50

* Decreases with the logarithm of the frequency.

5.1.2 Test Procedure

Test method Refer as ANSI C63.10: 2013 clause 6.2,

1. The EUT was placed on a non-conducted table, which is 0.8m above horizontal ground plane and 0.4m above vertical ground plane.
2. EUT connected to the line impedance stabilization network (LISN)
3. Receiver set RBW of 9kHz and Detector Peak, and note as quasi-peak and average.
4. Maximum procedure was performed on the six highest emissions to ensure EUT compliance.
5. Recorded Line for Neutral and Line.

5.1.3 Test Setup

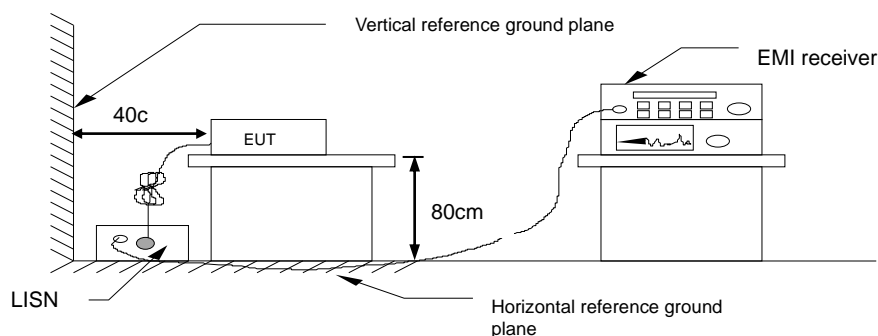

5.1.4 Test Result

Pass.

Report No.: T200504W06-RP3

Test Data

Test Mode:	Mode 1	Temp/Hum	24(°C)/ 50%RH
Phase:	Line	Test Date	May 11, 2020
		Test Engineer	Dally Hong

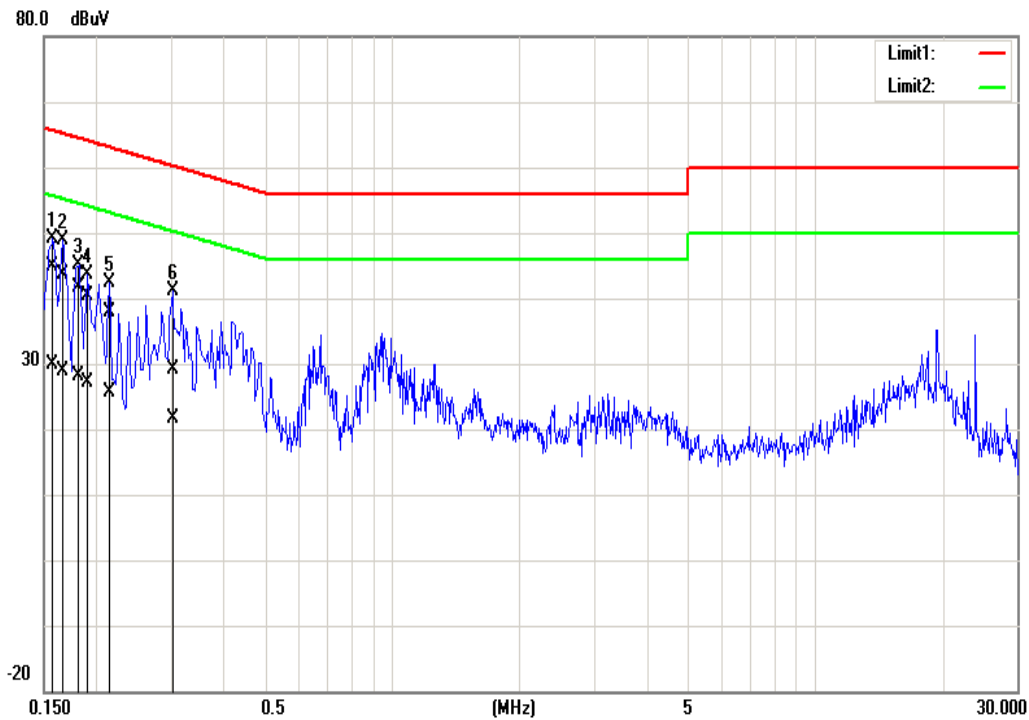

Frequency (MHz)	Quasi Peak reading (dBuV)	Average reading (d uV)	Correctio n factor (dB)	Quasi Peak result (dBuV)	Average result (dBuV)	Quasi Peak limit (dBuV)	Average limit (dBuV)	Quasi Peak margin (dB)	Average margin (dB)	Remark
0.1580	34.56	19.64	10.22	44.78	29.86	65.57	55.57	-20.79	-25.71	Pass
0.1660	33.44	18.69	10.22	43.66	28.91	65.16	55.16	-21.50	-26.25	Pass
0.1820	31.37	17.94	10.21	41.58	28.15	64.39	54.39	-22.81	-26.24	Pass
0.1900	30.15	16.82	10.21	40.36	27.03	64.04	54.04	-23.68	-27.01	Pass
0.2140	27.78	15.51	10.21	37.99	25.72	63.05	53.05	-25.06	-27.33	Pass
0.3020	19.01	11.46	10.22	29.23	21.68	60.19	50.19	-30.96	-28.51	Pass

Report No.: T200504W06-RP3

Test Mode:	Mode 1	Temp/Hum	24(°C)/ 50%RH
Phase:	Neutral	Test Date	May 11, 2020
		Test Engineer	Dally Hong

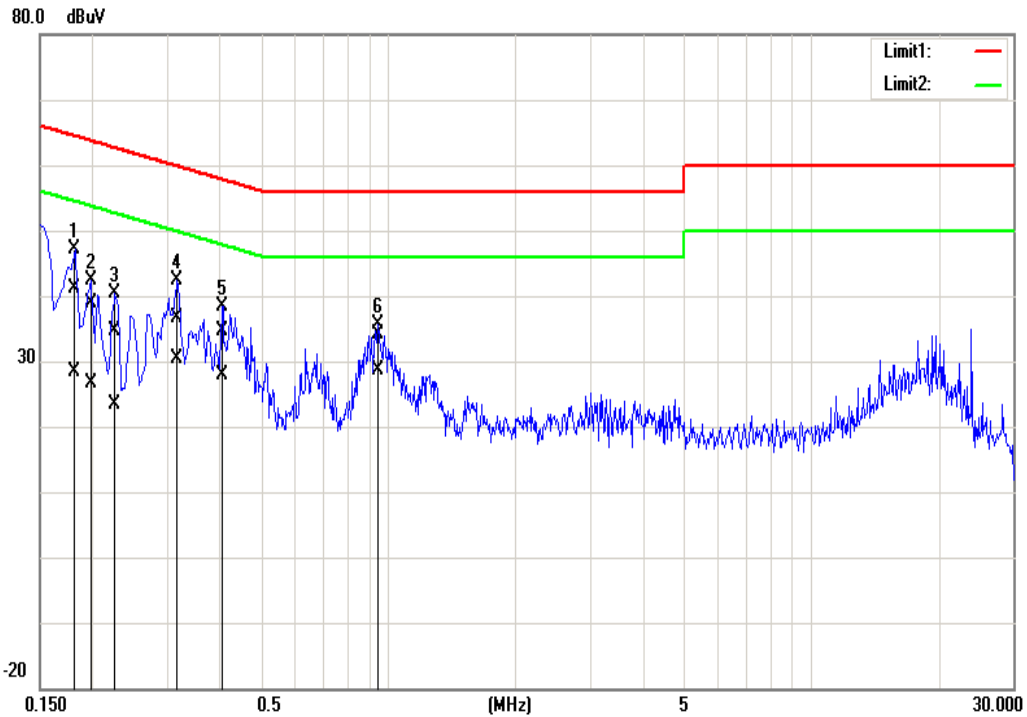

Frequency (MHz)	Quasi Peak reading (dBuV)	Average reading (dBuV)	Correction factor (dB)	Quasi Peak result (dBuV)	Average result (dBuV)	Quasi Peak limit (dBuV)	Average limit (dBuV)	Quasi Peak margin (dB)	Average margin (dB)	Remark
0.1820	31.03	18.16	10.19	41.22	28.35	64.39	54.39	-23.17	-26.04	Pass
0.1980	28.68	16.46	10.19	38.87	26.65	63.69	53.69	-24.82	-27.04	Pass
0.2260	24.46	13.19	10.19	34.65	23.38	62.60	52.60	-27.95	-29.22	Pass
0.3180	26.34	20.12	10.19	36.53	30.31	59.76	49.76	-23.23	-19.45	Pass
0.4060	24.33	17.59	10.19	34.52	27.78	57.73	47.73	-23.21	-19.95	Pass
0.9460	24.04	18.49	10.21	34.25	28.70	56.00	46.00	-21.75	-17.30	Pass

Report No.: T200504W06-RP3

5.2 6dB BANDWIDTH AND OCCUPIED BANDWIDTH(99%)

5.2.1 Test Limit

According to §15.247(a)(2) and RSS-247 section 5.2(a),

6 dB Bandwidth :

Limit	Shall be at least 500kHz
-------	--------------------------

Occupied Bandwidth(99%) : For reporting purposes only.

5.2.2 Test Procedure

Test method Refer as KDB 558074 D01 and ANSI C63.10: 2013 clause 6.9.2,

1. The EUT RF output connected to the spectrum analyzer by RF cable.
2. Setting maximum power transmit of EUT
3. SA set RBW = 100kHz, VBW = 300kHz and Detector = Peak, to measurement 6 dB Bandwidth.
4. SA set RBW = 1% ~ 5% OBW, VBW = three times the RBW and Detector = Peak, to measurement 99% Bandwidth
5. Measure and record the result of 6 dB Bandwidth and 99% Bandwidth. in the test report.

5.2.3 Test Setup

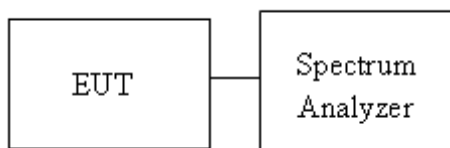

Report No.: T200504W06-RP3

5.2.4 Test Result

Test mode: IEEE 802.11b mode / 2412-2462 MHz						
Channel	Frequency (MHz)	Chain 0 OBW(99%) (MHz)	Chain 1 OBW(99%) (MHz)	Chain 0 6dB BW (MHz)	Chain 1 6dB BW (MHz)	6dB limit (kHz)
Low	2412	12.459	-	9.586	-	≥500
Mid	2437	12.530	-	10.03	-	
High	2462	12.708	-	10.04	-	

Test mode: IEEE 802.11g mode / 2412-2462 MHz						
Channel	Frequency (MHz)	Chain 0 OBW(99%) (MHz)	Chain 1 OBW(99%) (MHz)	Chain 0 6dB BW (MHz)	Chain 1 6dB BW (MHz)	6dB limit (kHz)
Low	2412	16.747	-	15.37	-	≥500
Mid	2437	16.806	-	15.16	-	
High	2462	16.816	-	15.16	-	

Test mode: IEEE 802.11n HT 20 MHz mode / 2412-2462 MHz						
Channel	Frequency (MHz)	Chain 0 OBW(99%) (MHz)	Chain 1 OBW(99%) (MHz)	Chain 0 6dB BW (MHz)	Chain 1 6dB BW (MHz)	6dB limit (kHz)
Low	2412	17.698	-	15.49	-	≥500
Mid	2437	17.734	-	15.16	-	
High	2462	17.761	-	15.17	-	

Test mode: IEEE 802.11n HT 40 MHz mode / 2422-2452 MHz						
Channel	Frequency (MHz)	Chain 0 OBW(99%) (MHz)	Chain 1 OBW(99%) (MHz)	Chain 0 6dB BW (MHz)	Chain 1 6dB BW (MHz)	6dB limit (kHz)
Low	2422	36.551	-	35.19	-	≥500
Mid	2437	36.439	-	35.19	-	
High	2452	36.615	-	35.19	-	

Report No.: T200504W06-RP3

Test Data

6dB BANDWIDTH

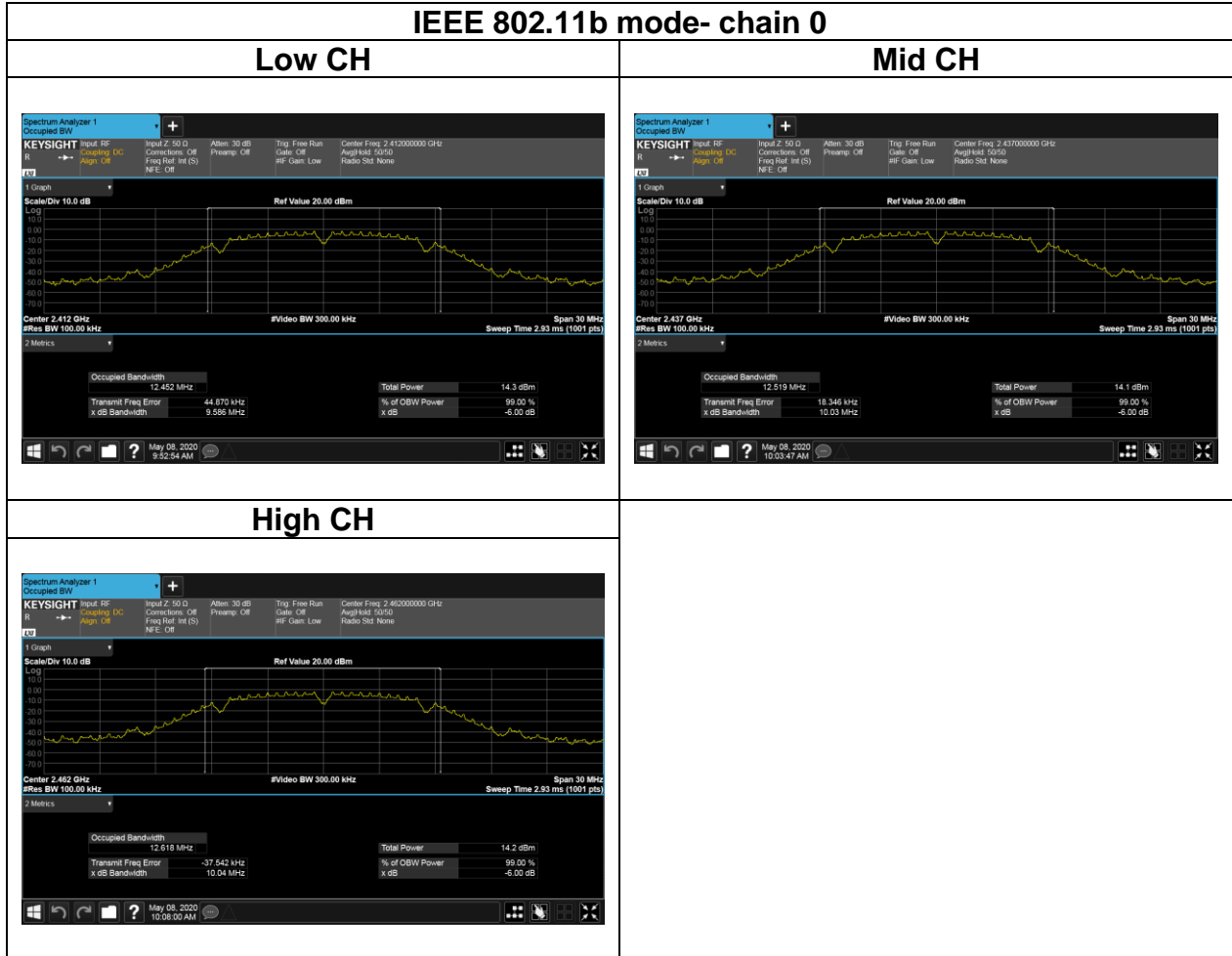

Report No.: T200504W06-RP3

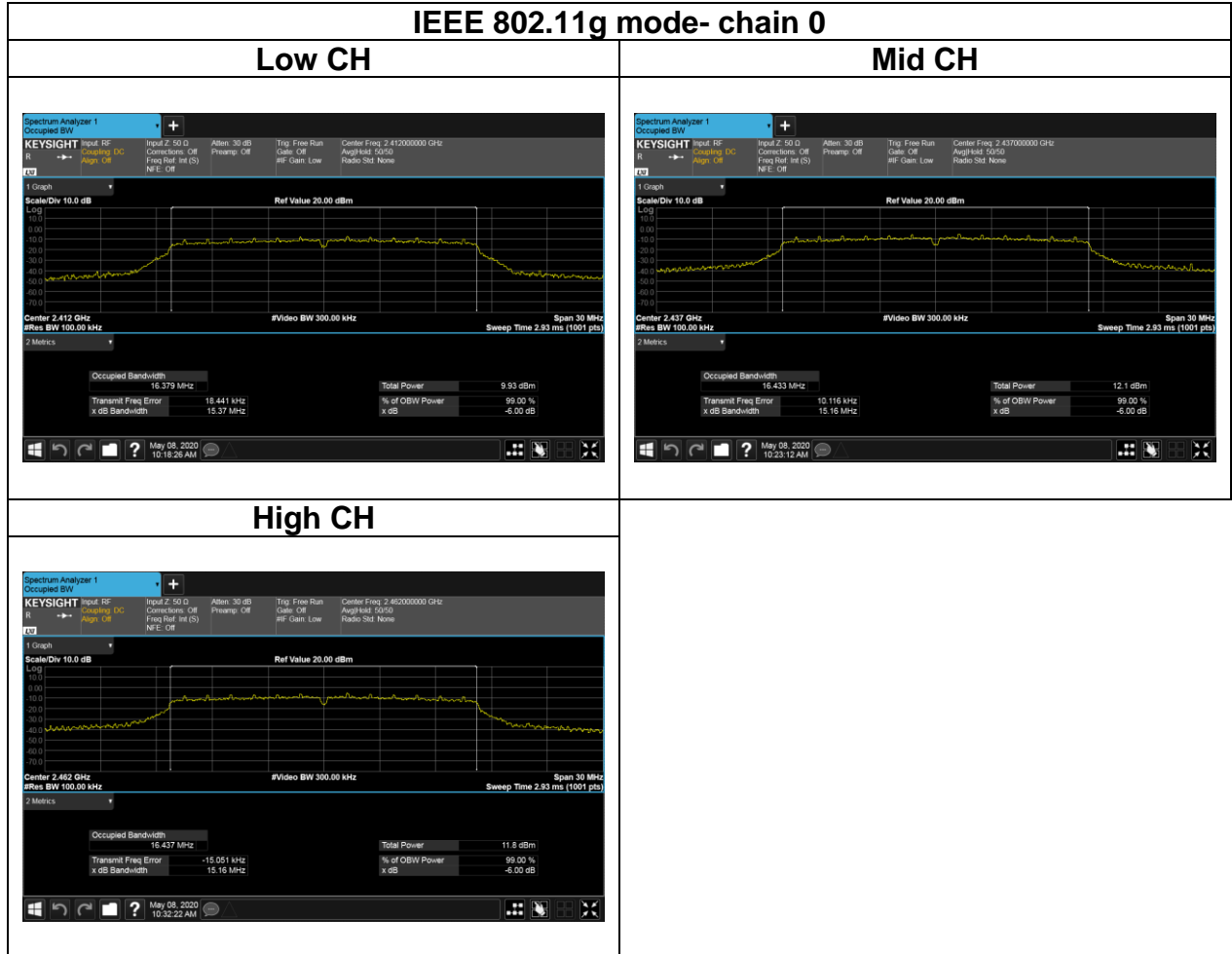

Report No.: T200504W06-RP3

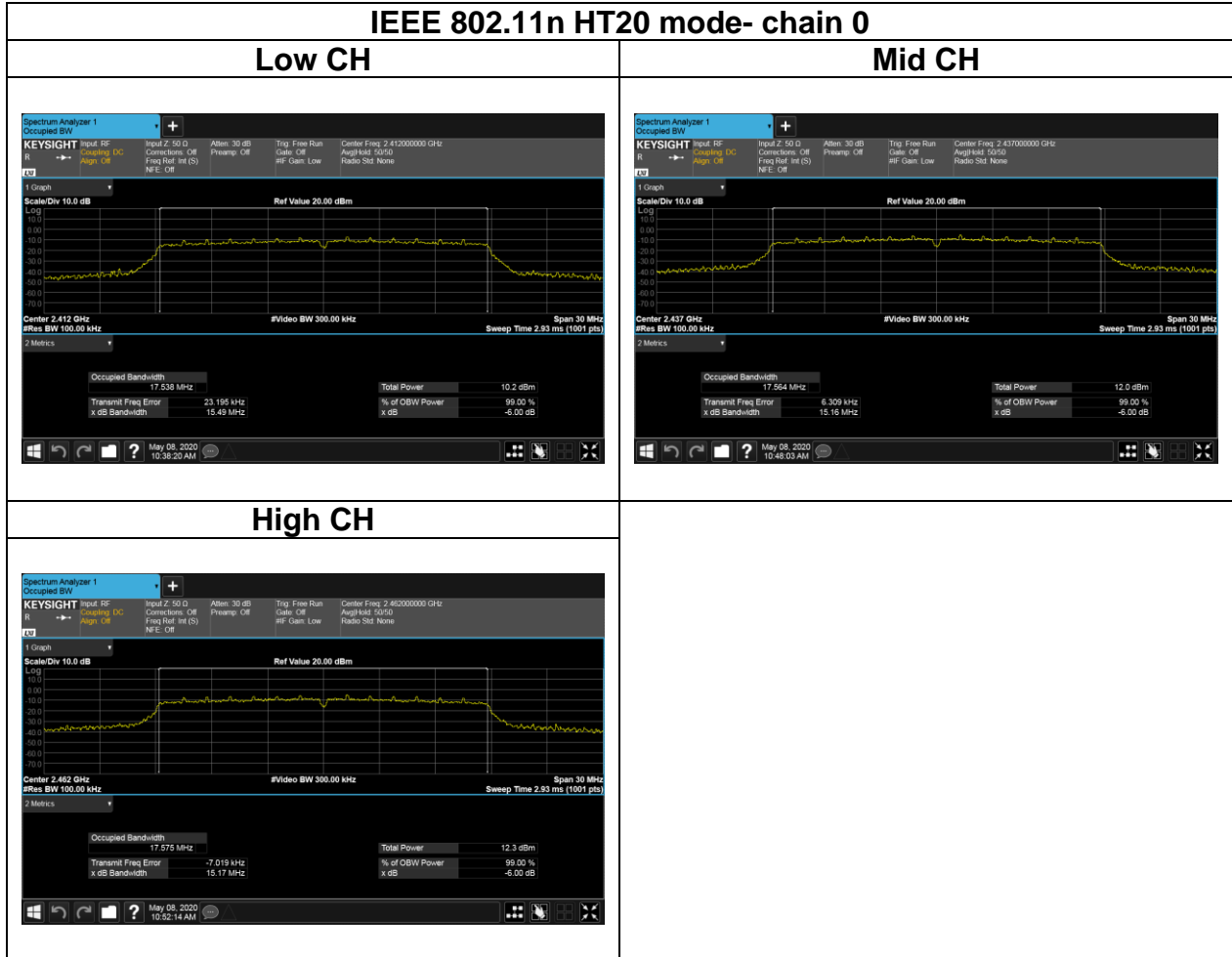

Report No.: T200504W06-RP3

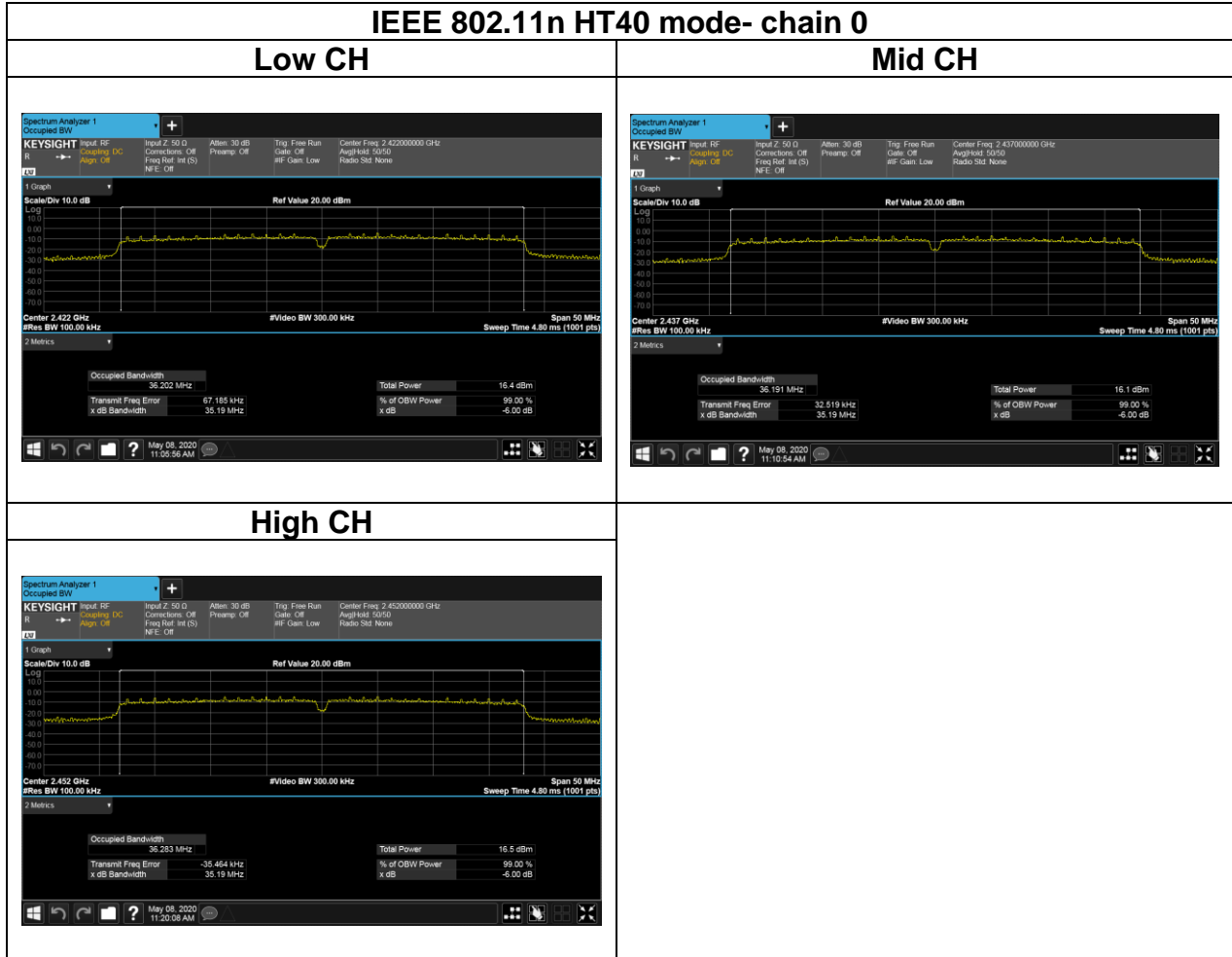

Report No.: T200504W06-RP3

Test Data

BANDWIDTH 99%

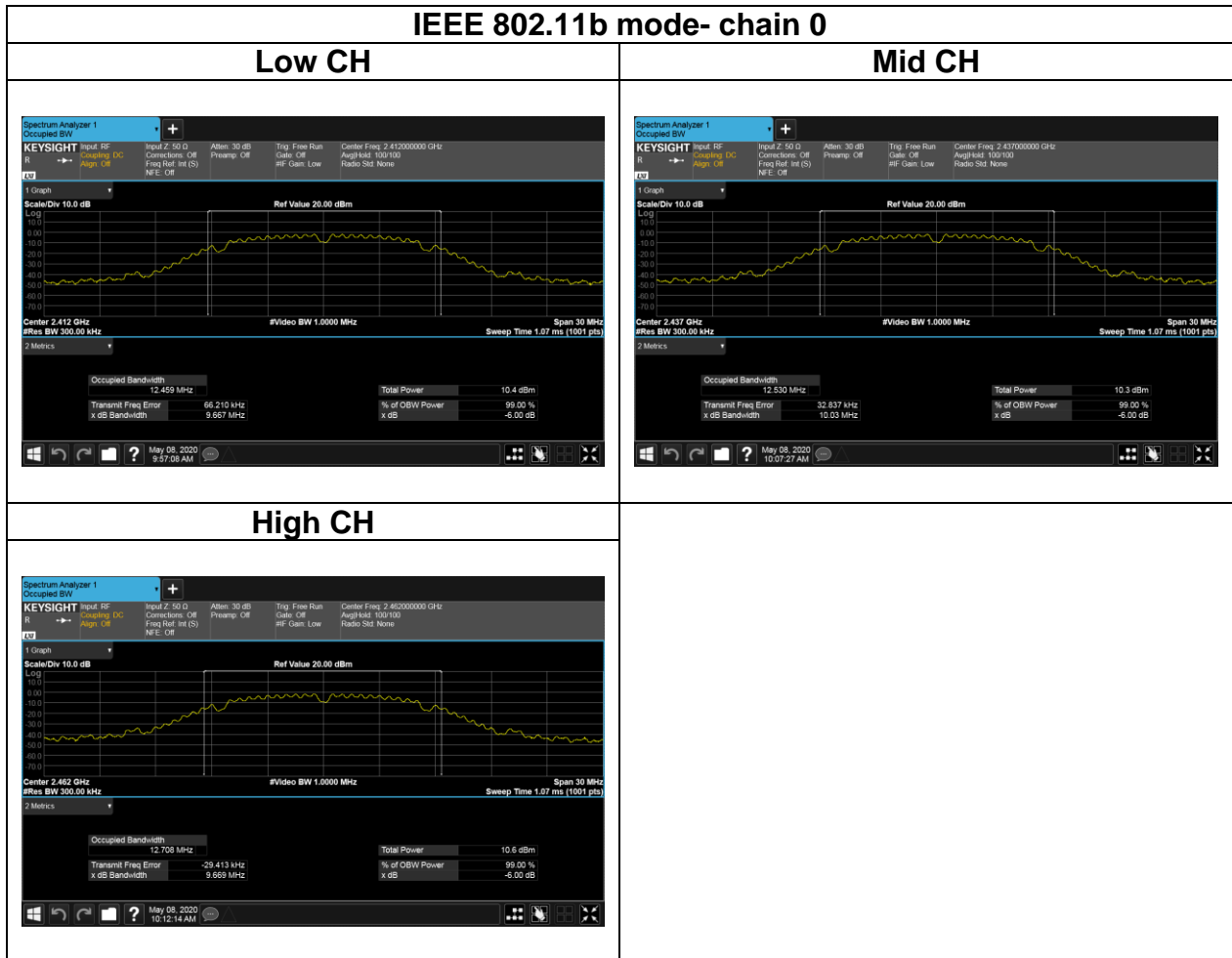

Report No.: T200504W06-RP3

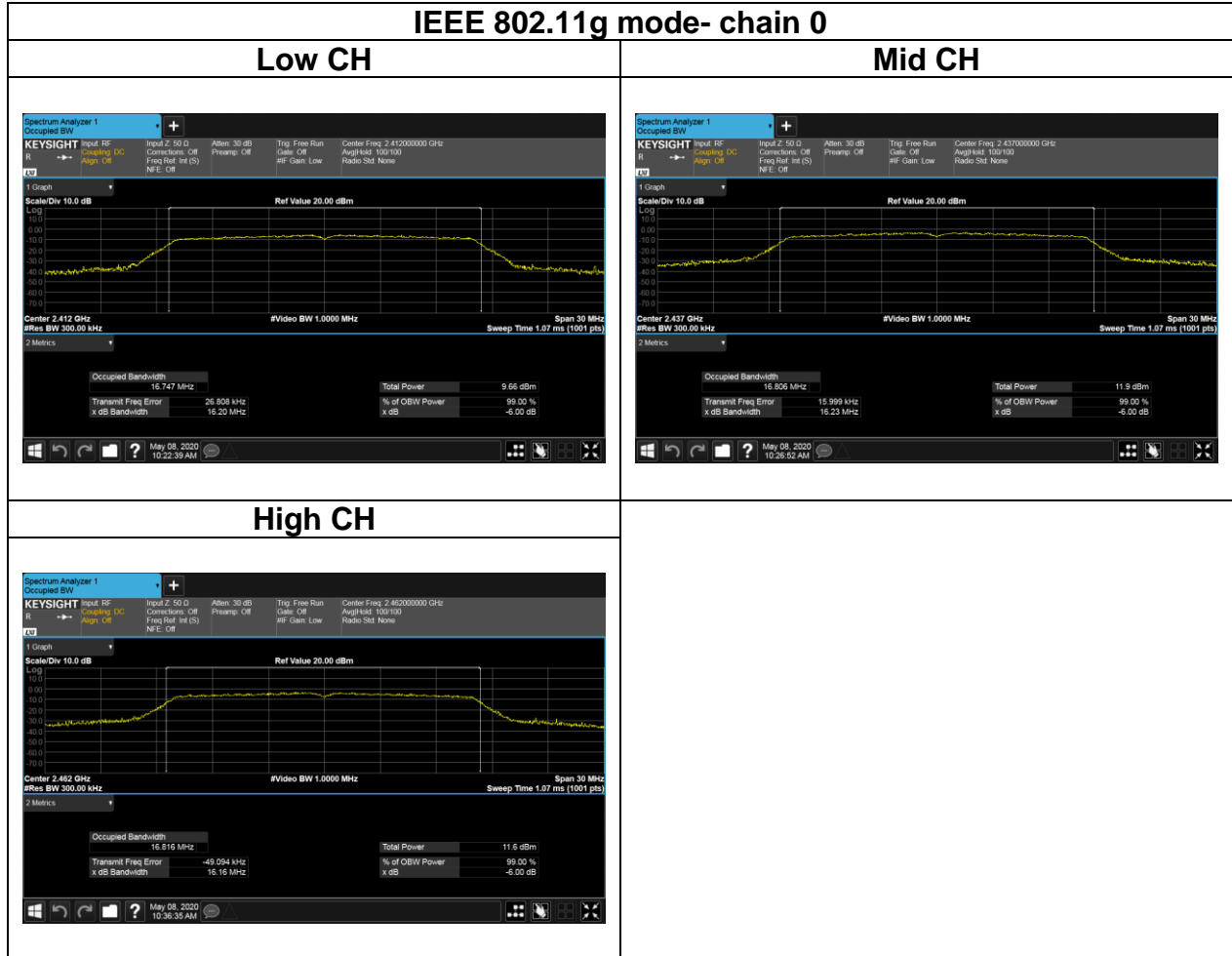

Report No.: T200504W06-RP3

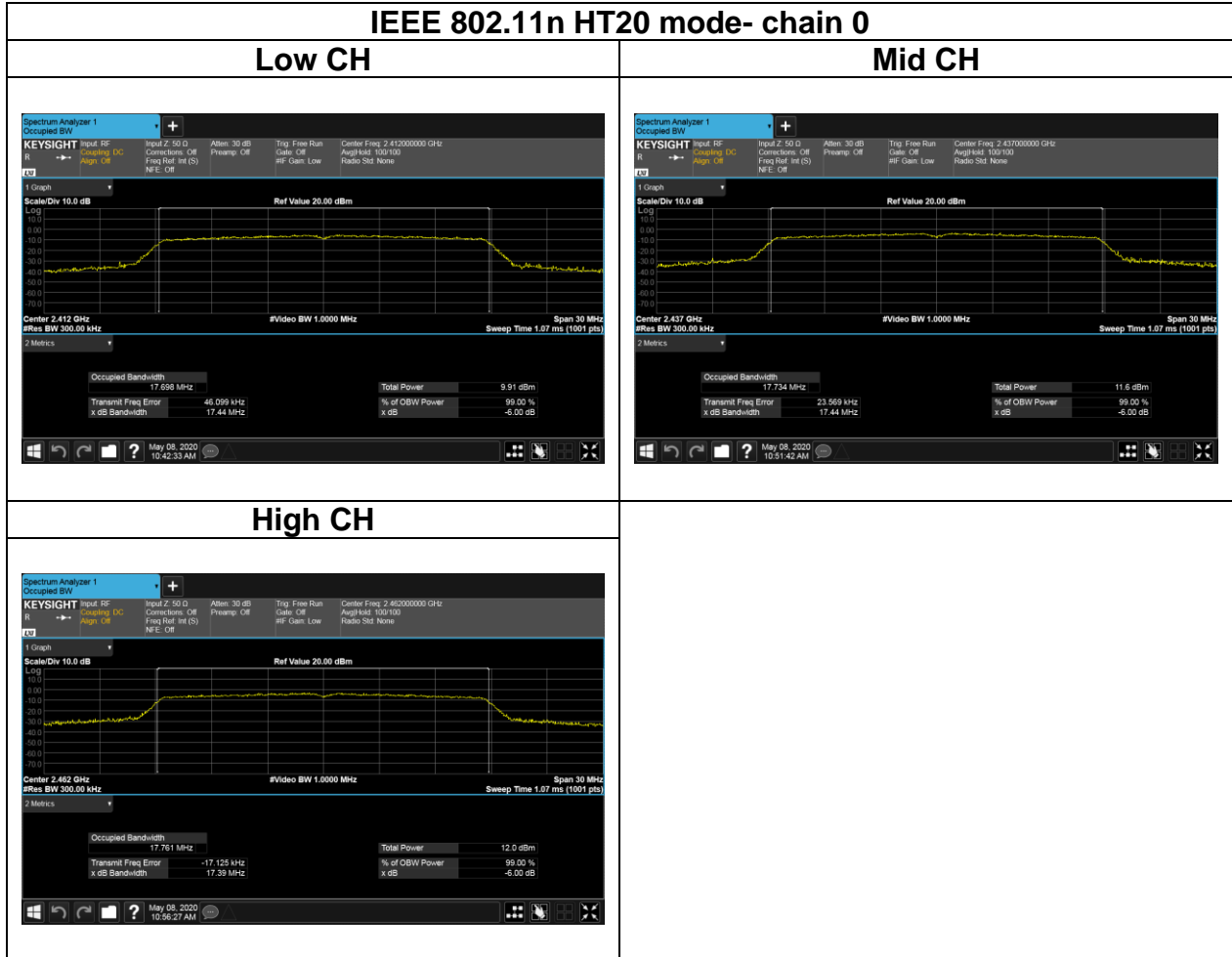

Report No.: T200504W06-RP3

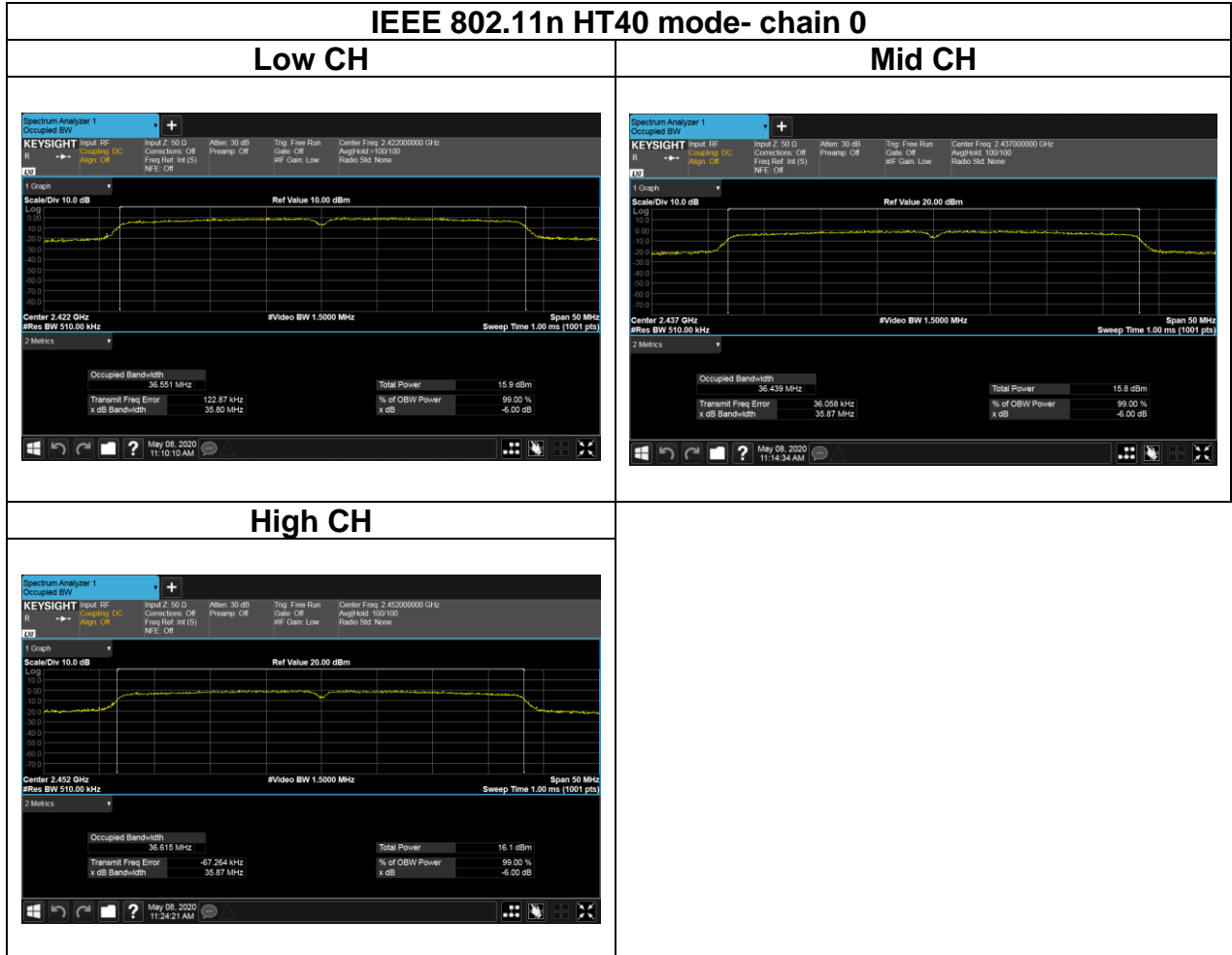

5.3 OUTPUT POWER MEASUREMENT

5.3.1 Test Limit

According to §15.247(b) (3) and RSS-247 section 5.4(d),

Peak output power :

For systems using digital modulation in the 2400-2483.5 MHz, and 5725-5850 MHz bands: 1 Watt(30 dBm) and the e.i.r.p. shall not exceed 4Watt(36 dBm), base on the use of antennas with directional gain not exceed 6 dBi If transmitting antennas of directional gain greater than 6dBi are used the peak output power the conducted output power from the intentional radiator shall be reduced by the amount in dB that the directional gain of the antenna exceeds 6 dBi. In case of point-to-point operation, the limit has to be reduced by 1dB for every 3 dB that the directional gain of the antenna exceeds 6 dBi.

Limit	<input checked="" type="checkbox"/> Antenna not exceed 6 dBi : 30dBm <input type="checkbox"/> Antenna with DG greater than 6 dBi : [Limit = 30 – (DG – 6)] <input type="checkbox"/> Point-to-point operation :
-------	---

Average output power : For reporting purposes only.

5.3.2 Test Procedure

Test method Refer as KDB 558074 D01.

1. The EUT RF output connected to the power meter by RF cable.
2. Setting maximum power transmit of EUT.
3. The path loss was compensated to the results for each measurement.
4. Measure and record the result of Peak output power and Average output power. in the test report.

5.3.3 Test Setup

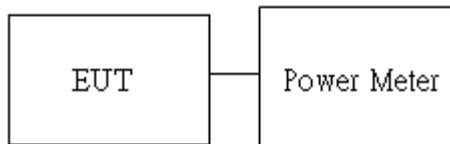

Report No.: T200504W06-RP3

5.3.4 Test Result

Peak output power :

Wifi 2.4G										
Config	CH	Freq. (MHz)	Power Setting	PK Power (dBm)	PK Power (W)	EIRP PK Power (dBm)	EIRP PK Power (W)	DG (dBi)	Limit (dBm)	EIRP Limit (dBm)
IEEE 802.11b Data rate: 1Mbps	Low	2412	19.0	21.48	0.1406	22.15	0.1641	0.67	30	36
	Mid	2437	19.0	21.28	0.1343	21.95	0.1567			
	High	2462	19.0	21.10	0.1288	21.77	0.1503			
IEEE 802.11g Data rate: 6Mbps	Low	2412	17.0	23.10	0.2042	23.77	0.2382			
	Mid	2437	17.0	23.23	0.2104	23.90	0.2455			
	High	2462	16.0	22.85	0.1928	23.52	0.2249			
IEEE 802.11n HT20 Data rate: MCS0	Low	2412	19.0	23.12	0.2051	23.79	0.2393			
	Mid	2437	19.0	24.30	0.2692	24.97	0.3141			
	High	2462	15.5	22.82	0.1914	23.49	0.2234			
IEEE 802.11n HT40 Data rate: MCS0	Low	2422	14.5	23.16	0.2070	23.83	0.2415			
	Mid	2437	20.0	24.27	0.2673	24.94	0.3119			
	High	2452	12.0	21.75	0.1496	22.42	0.1746			

Average output power :

Wifi 2.4G			
Config	CH	Freq. (MHz)	AV Power (dBm)
IEEE 802.11b Data rate: 1Mbps	Low	2412	18.46
	Mid	2437	18.27
	High	2462	17.99
IEEE 802.11g Data rate: 6Mbps	Low	2412	14.19
	Mid	2437	16.04
	High	2462	15.12
IEEE 802.11n HT20 Data rate: MCS0	Low	2412	14.33
	Mid	2437	17.97
	High	2462	14.78
IEEE 802.11n HT40 Data rate: MCS0	Low	2422	14.13
	Mid	2437	19.08
	High	2452	11.71

5.4 POWER SPECTRAL DENSITY

5.4.1 Test Limit

According to §15.247(e) and RSS-247 section 5.2(b),

For digitally modulated systems, the power spectral density conducted from the intentional radiator to the antenna shall not be greater than 8 dBm in any 3 kHz band during any time interval of continuous transmission.

Limit	<input checked="" type="checkbox"/> Antenna not exceed 6 dBi : 8dBm <input type="checkbox"/> Antenna with DG greater than 6 dBi : [Limit = 8 – (DG – 6)] <input type="checkbox"/> Point-to-point operation :
-------	---

5.4.2 Test Procedure

Test method Refer as KDB 558074 D01

1. The EUT RF output connected to the spectrum analyzer by RF cable.
2. Setting maximum power transmit of EUT
3. SA set RBW = 3kHz, VBW = 10kHz, Span = 1.5 times DTS Bandwidth (6 dB BW), Detector = Peak, Sweep Time = Auto and Trace = Max hold.
4. The path loss was compensated to the results for each measurement by SA.
5. Mark the maximum level.
6. Measure and record the result of power spectral density. in the test report.

5.4.3 Test Setup

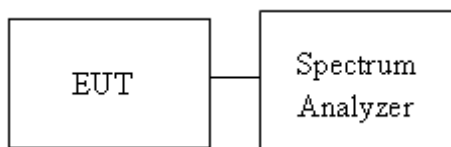

Report No.: T200504W06-RP3

5.4.4 Test Result

Test mode: IEEE 802.11b mode / 2412-2462 MHz					
Channel	Frequency (MHz)	Chain 0 PPSD (dBm)	Chain 1 PPSD (dBm)	Total PPSD (dBm)	Limit (dBm)
Low	2412	-4.497	-	-4.497	8
Mid	2437	-5.537	-	-5.537	
High	2462	-6.231	-	-6.231	

Test mode: IEEE 802.11g mode / 2412-2462 MHz					
Channel	Frequency (MHz)	Chain 0 PPSD (dBm)	Chain 1 PPSD (dBm)	Total PPSD (dBm)	Limit (dBm)
Low	2412	-11.35	-	-11.35	8
Mid	2437	-9.732	-	-9.732	
High	2462	-8.945	-	-8.945	

Test mode: IEEE 802.11n HT 20 MHz mode / 2412-2462 MHz					
Channel	Frequency (MHz)	Chain 0 PPSD (dBm)	Chain 1 PPSD (dBm)	Total PPSD (dBm)	Limit (dBm)
Low	2412	-11.88	-	-11.88	8
Mid	2437	-10.03	-	-10.03	
High	2462	-8.89	-	-8.89	

Test mode: IEEE 802.11n HT 40 MHz mode / 2422-2452 MHz					
Channel	Frequency (MHz)	Chain 0 PPSD (dBm)	Chain 1 PPSD (dBm)	Total PPSD (dBm)	Limit (dBm)
Low	2412	-9.905	-	-9.905	8
Mid	2437	-9.637	-	-9.637	
High	2462	-8.384	-	-8.384	

Report No.: T200504W06-RP3

Test Data

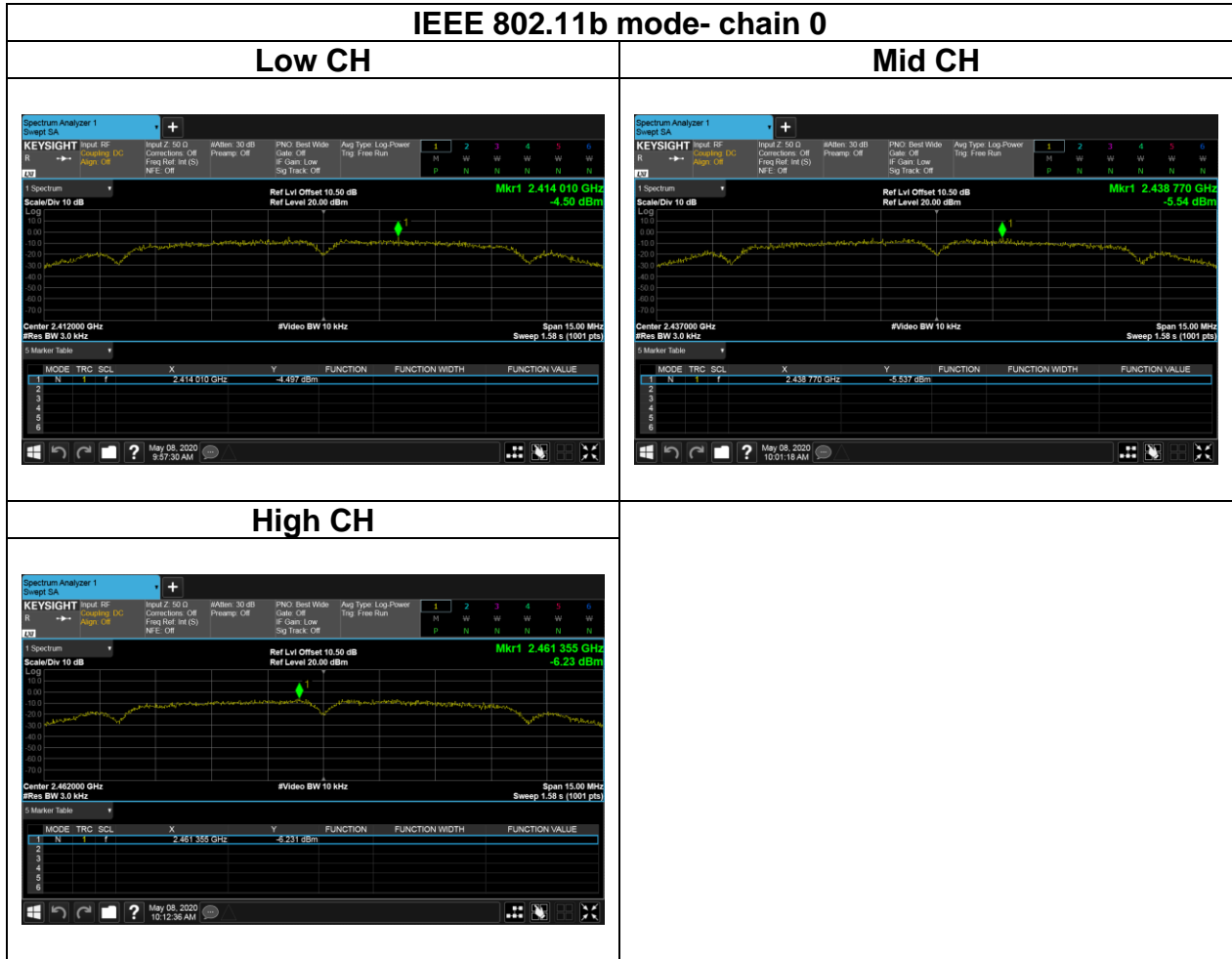

Report No.: T200504W06-RP3

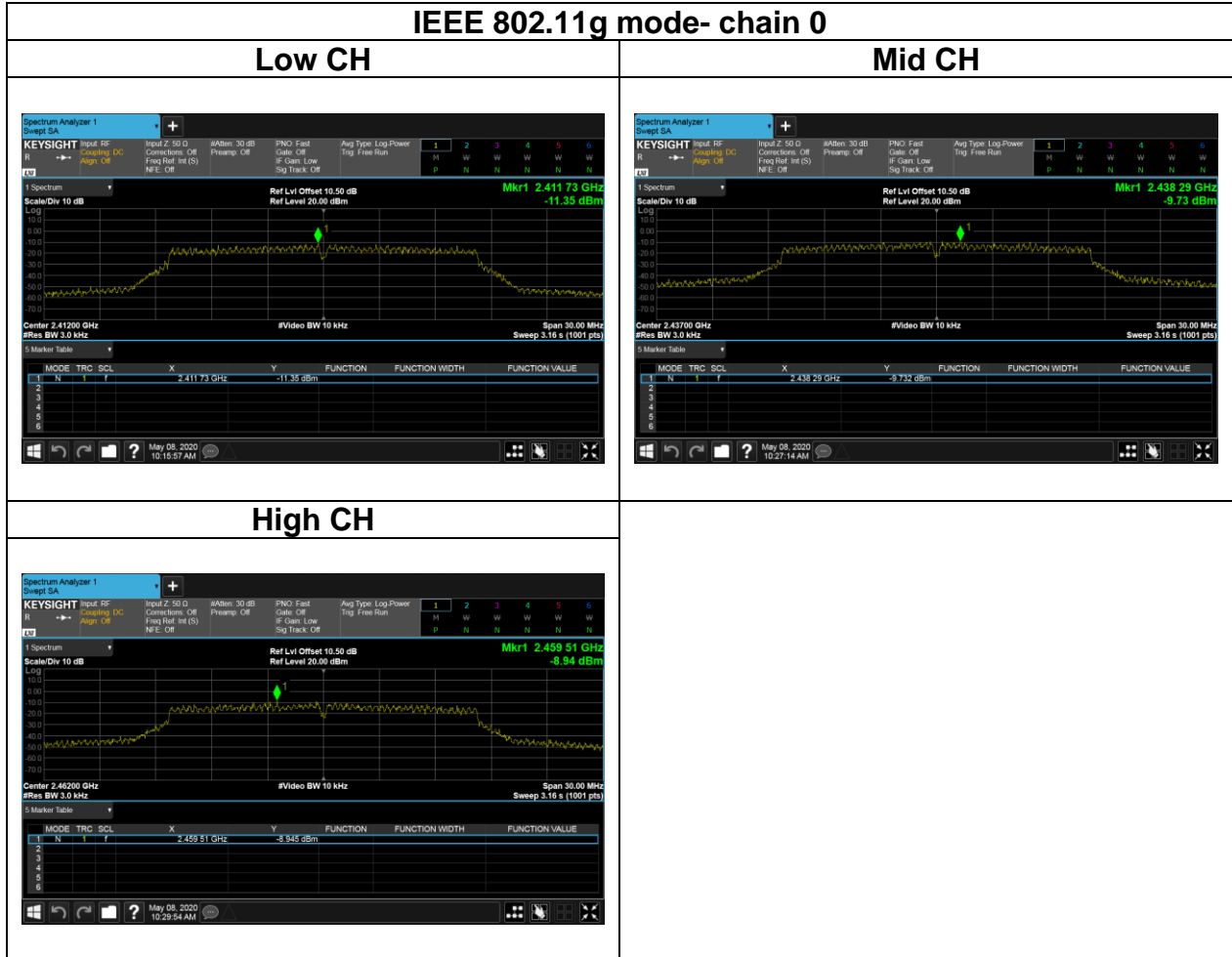

Report No.: T200504W06-RP3

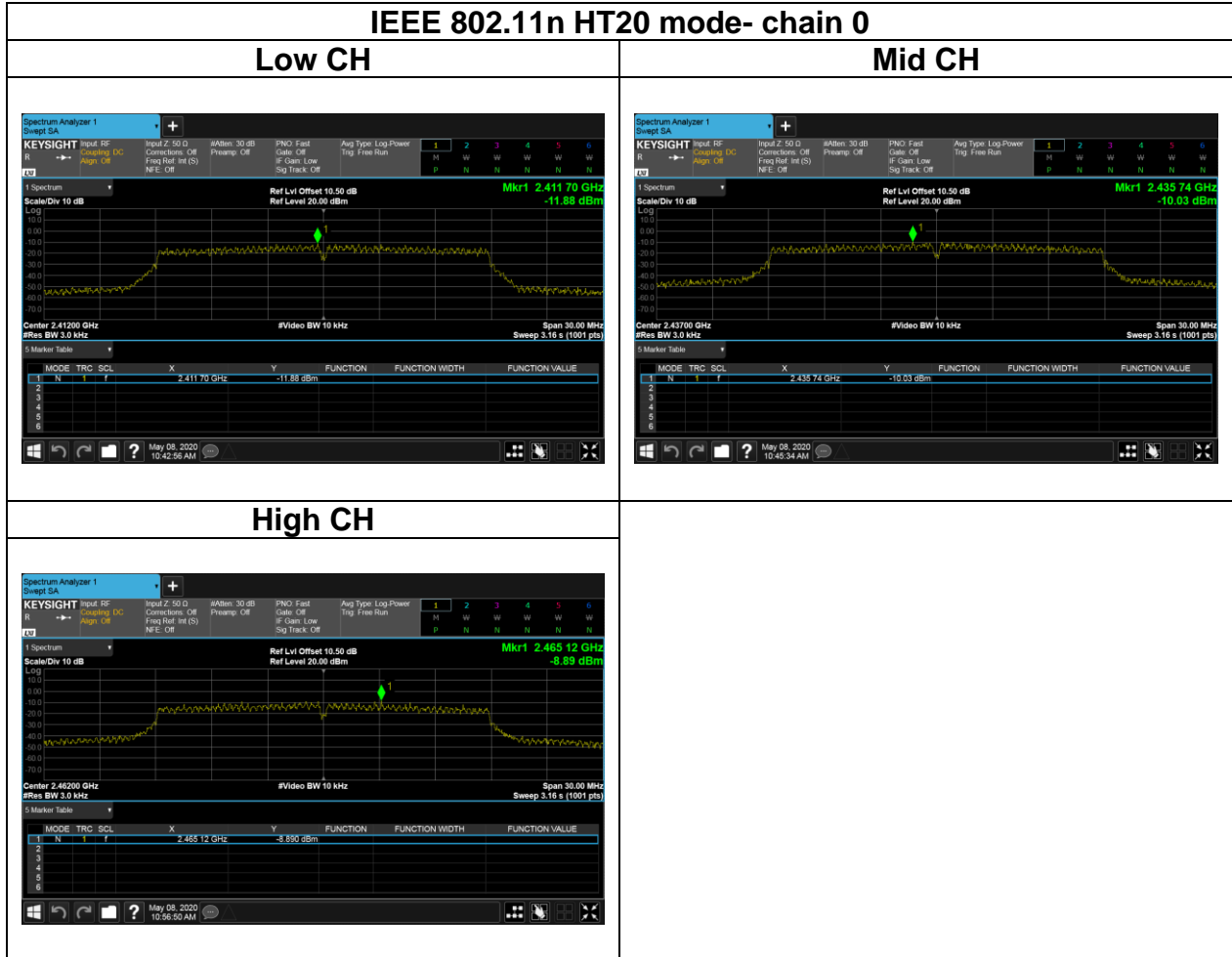

Report No.: T200504W06-RP3



5.5 CONDUCTED BANDEDGE AND SPURIOUS EMISSION

5.5.1 Test Limit

According to §15.247(d) and RSS-247 section 5.5,

In any 100 kHz bandwidth outside the authorized frequency band,

Non-restricted bands shall be attenuated at least 20 dB/30 dB relative to the maximum PSD level in 100 kHz by RF conducted or a radiated measurement which fall in the restricted bands, as defined in §15.205(a), must also comply with the radiated emission limits specified in §15.209(a).

5.5.2 Test Procedure

Test method Refer as KDB 558074 D01.

1. EUT RF output port connected to the SA by RF cable, and the path loss was compensated to result.
2. SA setting, RBW=100kHz, VBW=300kHz, Detector=Peak, Trace mode = max hold, SWT = Auto.
3. In any 100 kHz bandwidth outside the authorized frequency band, shall be attenuated at least 20 dB relative to the maximum in-band peak PSD level in 100 kHz when conducted power procedure is used. If the transmitter complies with the conducted power limits based on the use of RMS averaging over a time interval, the attenuation required under this paragraph shall be 30 dB instead of 20 dB.

5.5.3 Test Setup

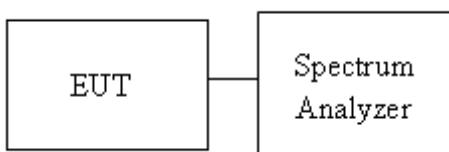

Report No.: T200504W06-RP3

5.5.4 Test Result

Test Data

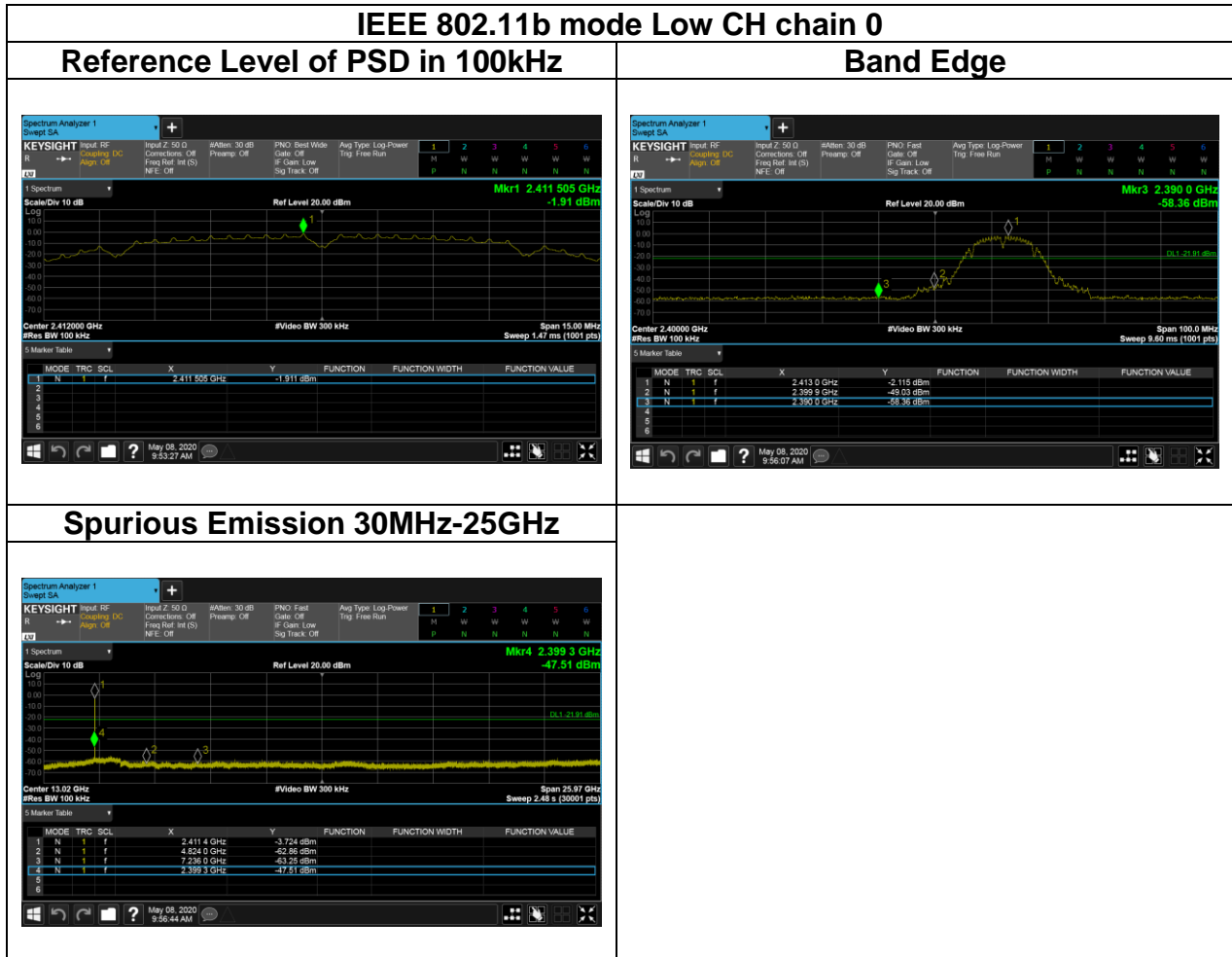

Report No.: T200504W06-RP3

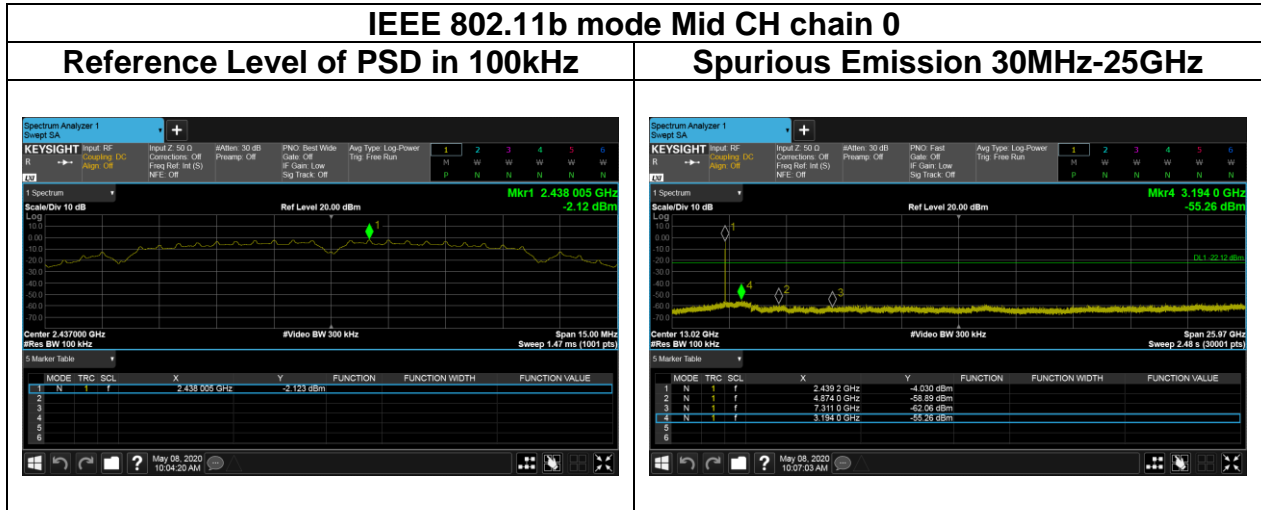

Report No.: T200504W06-RP3

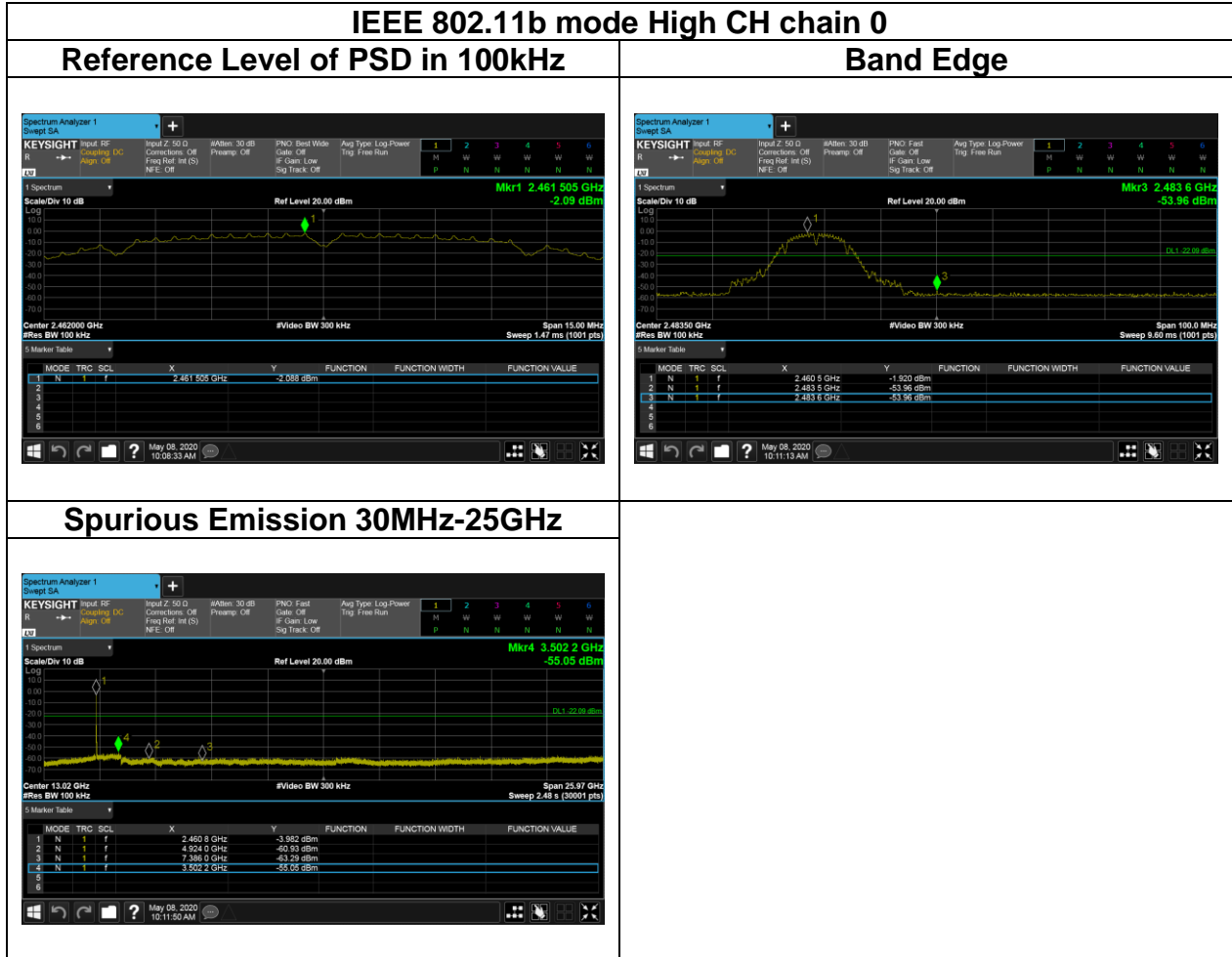

Report No.: T200504W06-RP3

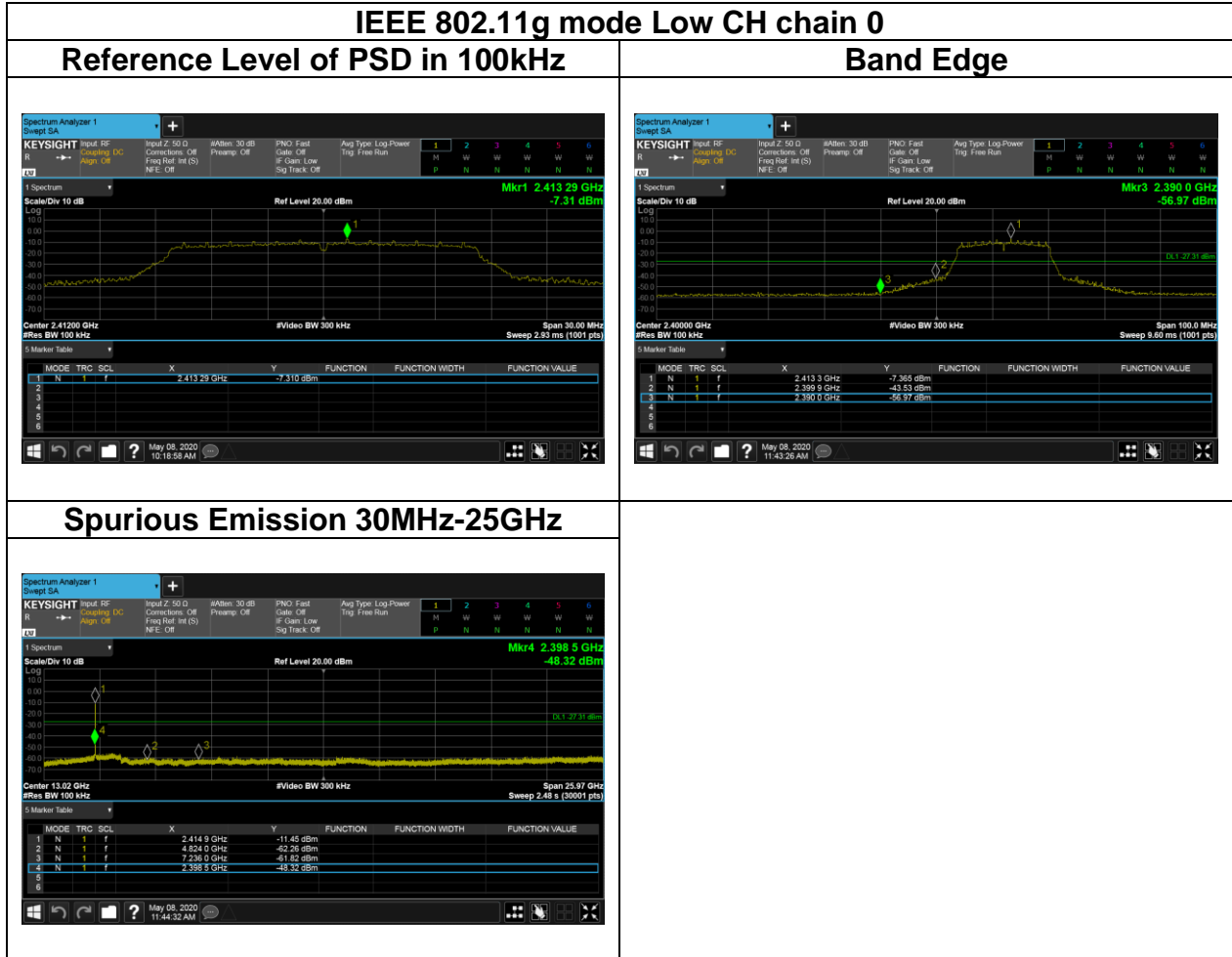

Report No.: T200504W06-RP3

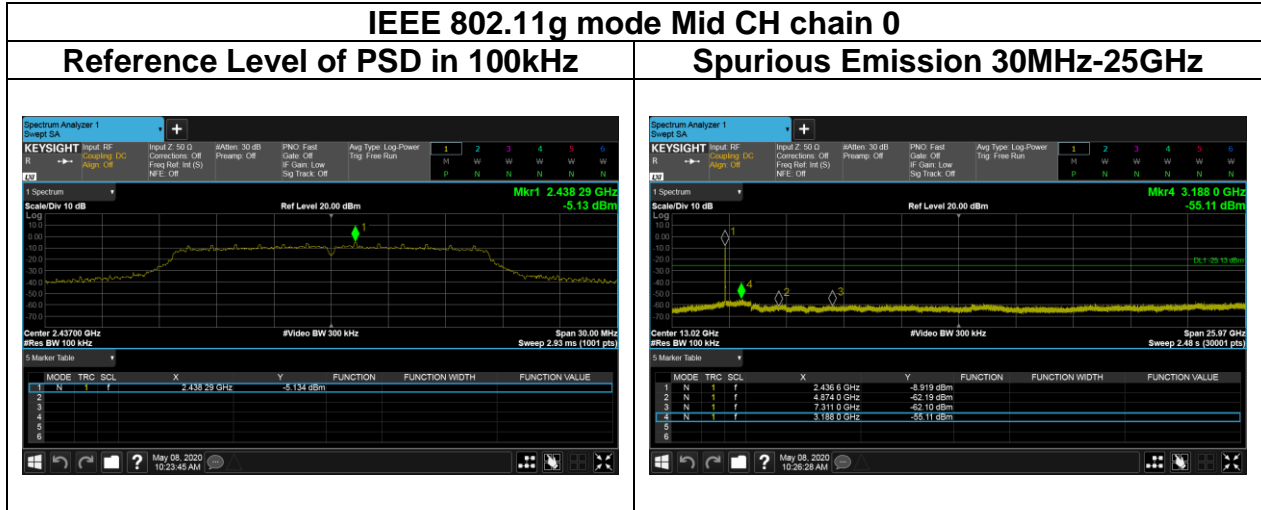

Report No.: T200504W06-RP3

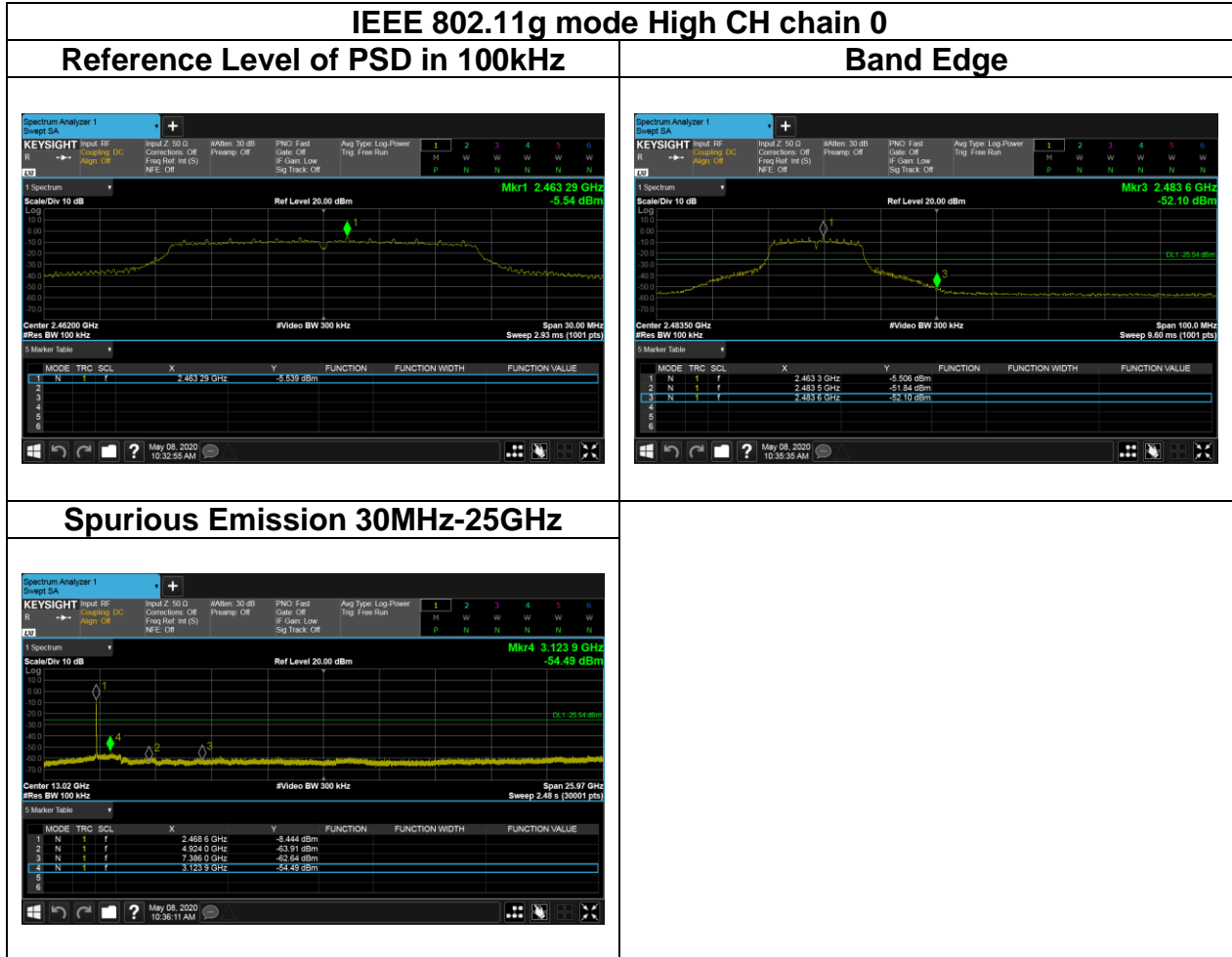

Report No.: T200504W06-RP3

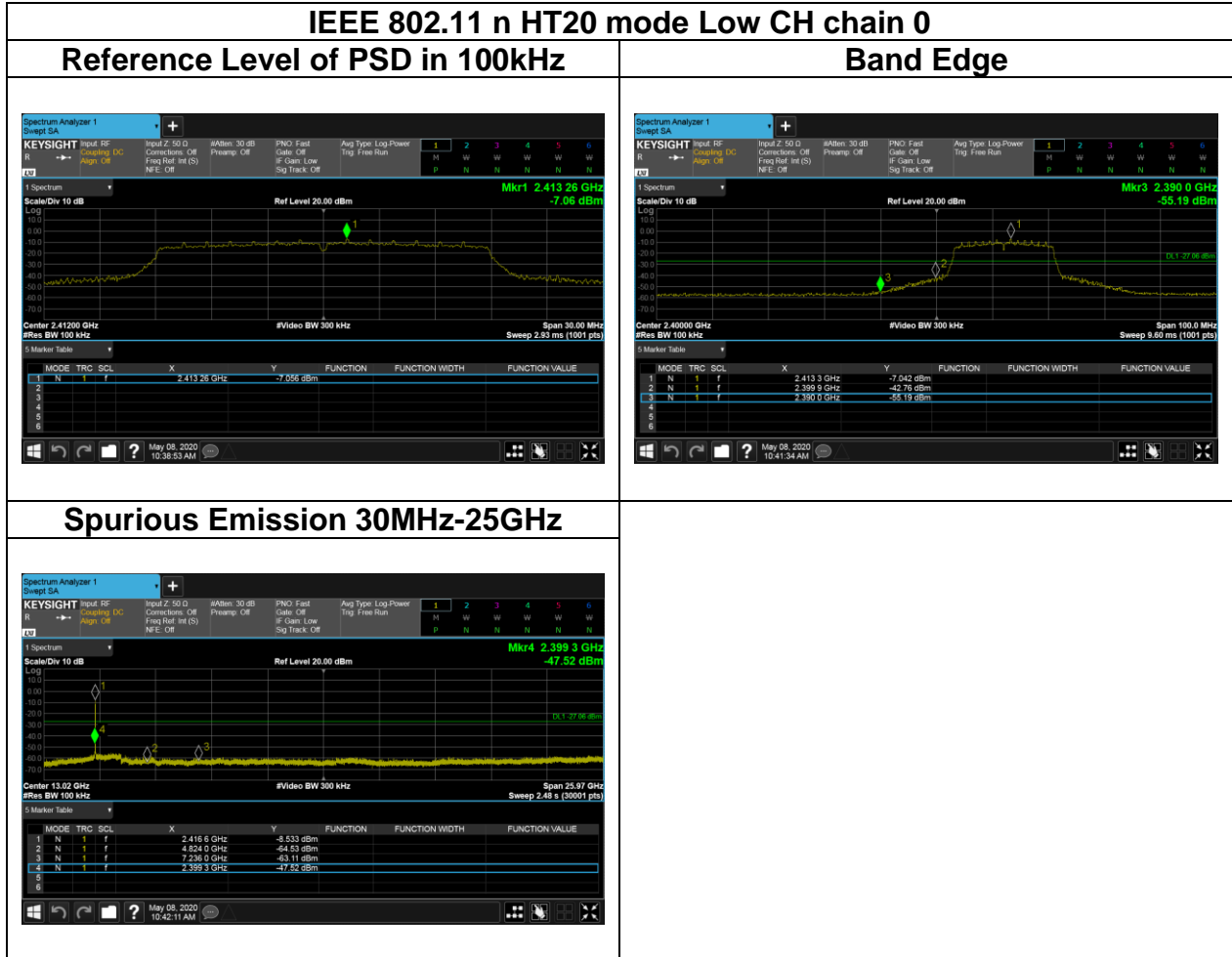

Report No.: T200504W06-RP3

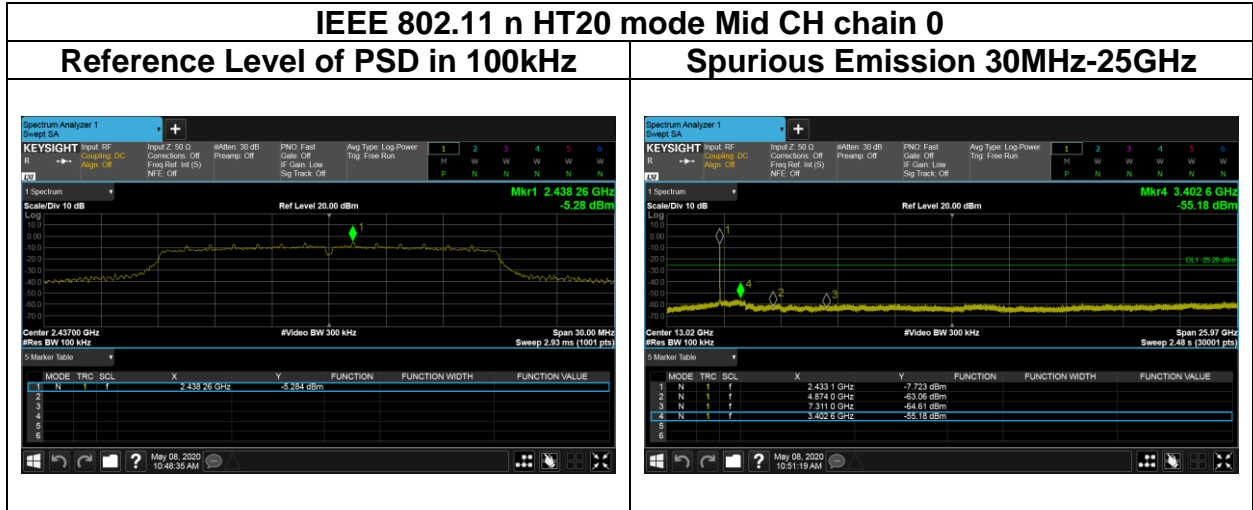

Report No.: T200504W06-RP3

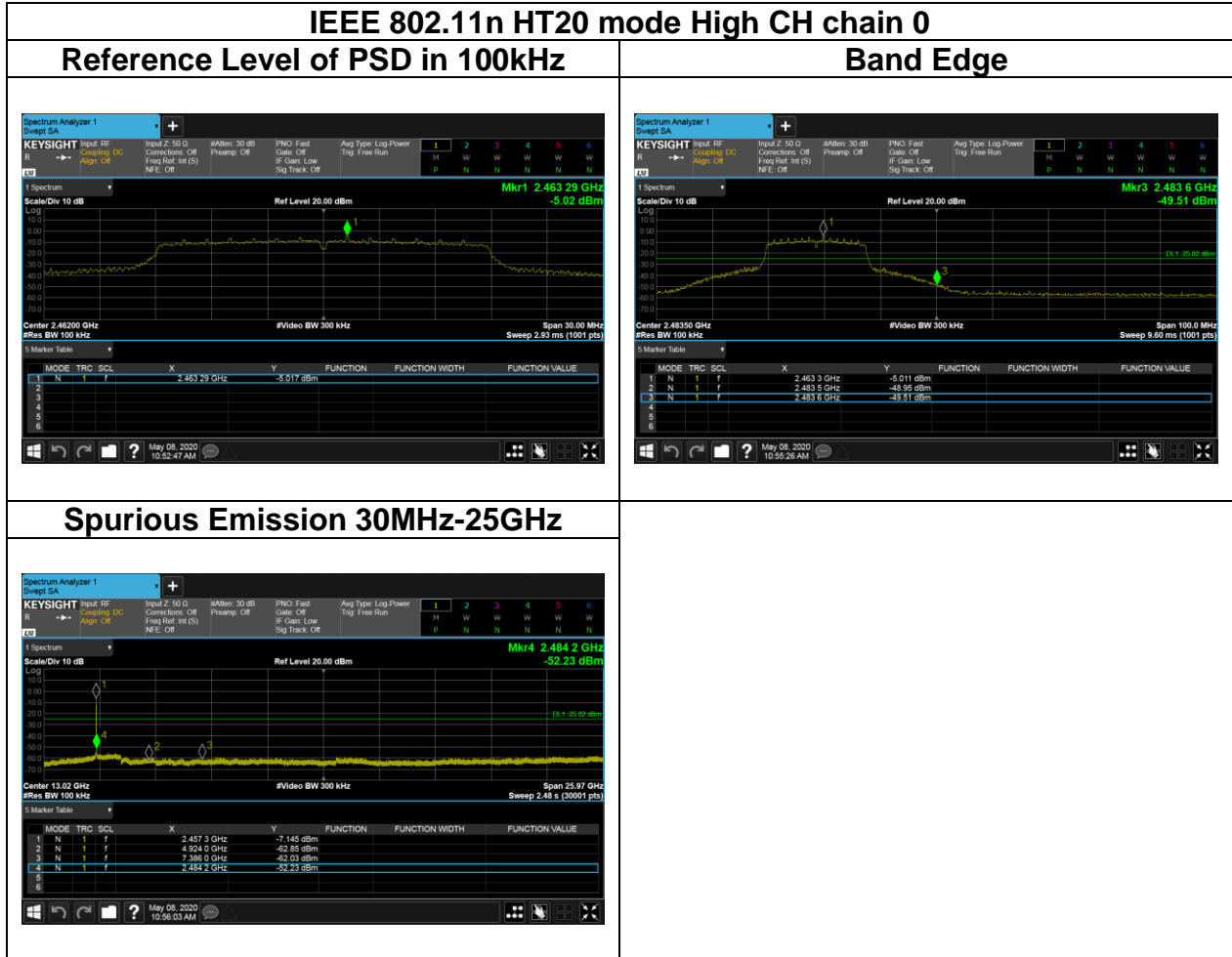

Report No.: T200504W06-RP3

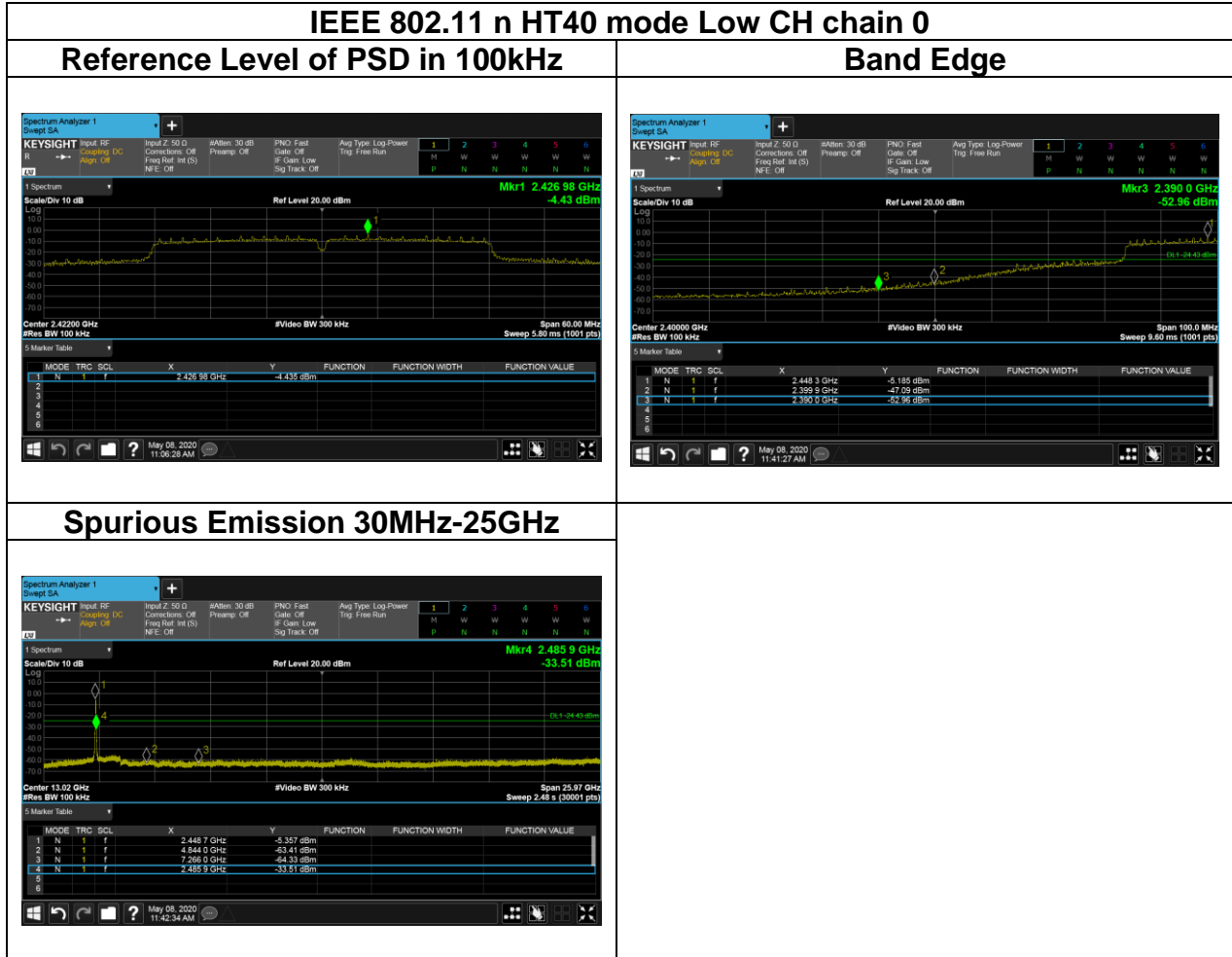

Report No.: T200504W06-RP3

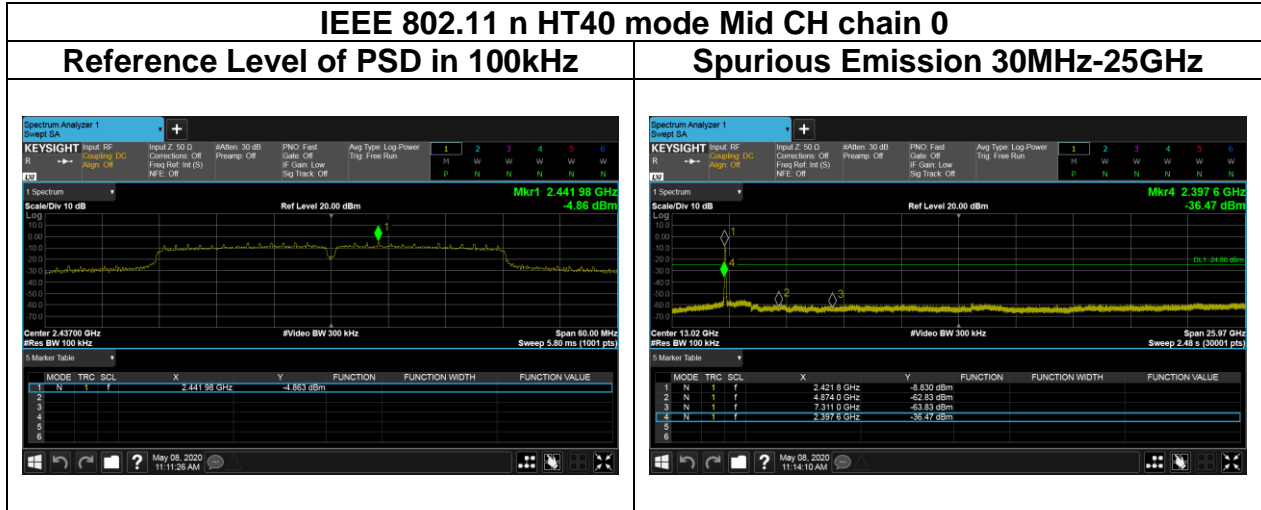

Report No.: T200504W06-RP3

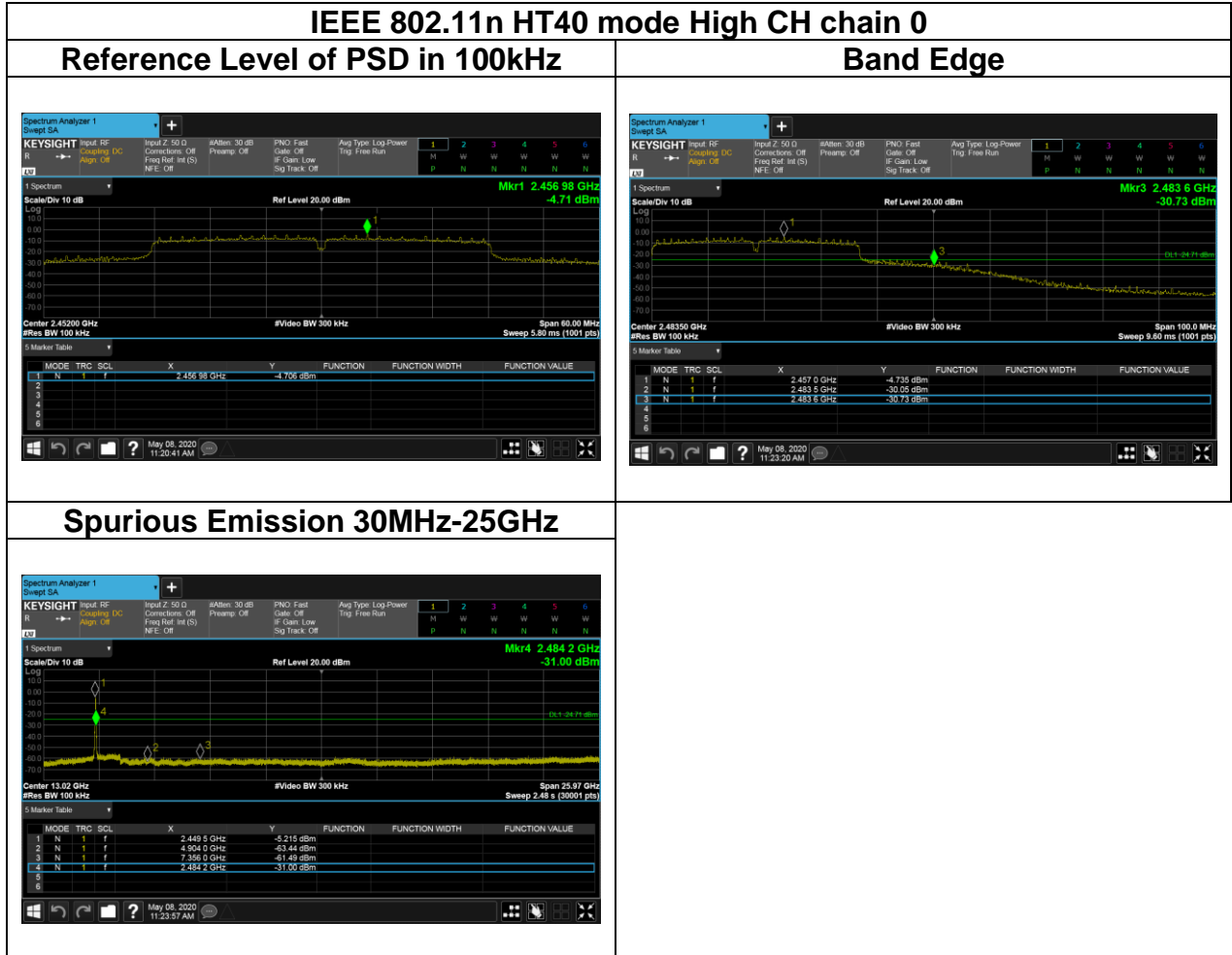

5.6 RADIATION BANDEDGE AND SPURIOUS EMISSION

5.6.1 Test Limit

FCC according to §15.247(d), §15.209 and §15.205,

IC according to RSS-247 section 5.5, RSS-Gen, Section 8.9 and 8.10

In any 100 kHz bandwidth outside the authorized frequency band, all harmonic and spurious must be least 20 dB below the highest emission level with the authorized frequency band. Radiation emission which fall in the restricted bands must also follow the FCC section 15.209 as below limit in table.

Below 30 MHz

Frequency	Field Strength (microvolts/m)	Magnetic H-Field (microamperes/m)	Measurement Distance (metres)
9-490 kHz	2,400/F (F in kHz)	2,400/F (F in kHz)	300
490-1,705 kHz	24,000/F (F in kHz)	24,000/F (F in kHz)	30
1.705-30 MHz	30	N/A	30

Above 30 MHz

Frequency	Field Strength (microvolts/m)	Measurement Distance (metres)
30-88	100	3
88-216	150	3
216-960	200	3
Above 960	500	3

Remark:

Although these tests were performed other than open area test site, adequate comparison measurements were confirmed against 30 m open are test site. Therefore sufficient tests were made to demonstrate that the alternative site produces results that correlate with the ones of tests made in an open field based on KDB 414788.

Report No.: T200504W06-RP3

IC according to RSS-247 section 5.5, RSS-Gen, Section 8.9 and 8.10

RSS-Gen Table 3 and Table 5 – General Field Strength Limits for Transmitters and Receivers at Frequencies Above 30 MHz ^(Note)

Frequency (MHz)	Field Strength microvolts/m at 3 metres (watts, e.i.r.p.)	
	Transmitters	Receivers
30-88	100 (3 nW)	100 (3 nW)
88-216	150 (6.8 nW)	150 (6.8 nW)
216-960	200 (12 nW)	200 (12 nW)
Above 960	500 (75 nW)	500 (75 nW)

Note: Measurements for compliance with the limits in table 3 may be performed at distances other than 3 metres, in accordance with Section 6.6.

RSS-Gen Table 6: General Field Strength Limits for Transmitters at Frequencies Below 30 MHz (Transmit)

Frequency	Magnetic field strength (H-Field) (µA/m)	Measurement Distance (m)
9-490 kHz ^{Note}	6.37/F (F in kHz)	300
490-1,705 kHz	63.7/F (F in kHz)	30
1.705-30 MHz	0.08	30

Note: The emission limits for the ranges 9-90 kHz and 110-490 kHz are based on measurements employing a linear average detector.

5.6.2 Test Procedure

Test method Refer as KDB 558074 D01.

1. The EUT is placed on a turntable, Above 1 GHz is 1.5m and below 1 GHz is 0.8m above ground plane. The EUT Configured un accordance with ANSI C63.10: 2013, and the EUT set in a continuous mode.

2. The turntable shall be rotated for 360 degrees to determine the position of maximum emission level. And EUT is set 3m away from the receiving antenna, which is scanned from 1m to 4m above the ground plane to find out the highest emissions. Measurement are made polarized in both the vertical and the horizontal positions with antenna.

3. Span shall wide enough to full capture the emission measured. The SA from 9kHz to 26.5GHz set to the low, Mid and High channels with the EUT transmit.

Note: No emission found between lowest internal used/generated frequency to 30MHz (9KHz~30MHz)

Remark:

Although these tests were performed other than open area test site, adequate comparison measurements were confirmed against 30 m open are test site. Therefore sufficient tests were made to demonstrate that the alternative site produces results that correlate with the ones of tests made in an open field based on KDB 414788.

4. The SA setting following :

(1) Below 1G : RBW = 100kHz, VBW \geq 3 RBW, Sweep = Auto, Detector = Peak, Trace = Max hold.

(2) Above 1G :

(2.1) For Peak measurement : RBW = 1MHz, VBW \geq 3 RBW, Sweep = Auto, Detector = Peak, Trace = Max hold.

(2.2) For Average measurement : RBW = 1MHz, VBW

'If Duty Cycle \geq 98%, VBW=10Hz.

'If Duty Cycle < 98%, VBW=1/T.

5.6.3 Test Setup

9kHz ~ 30MHz

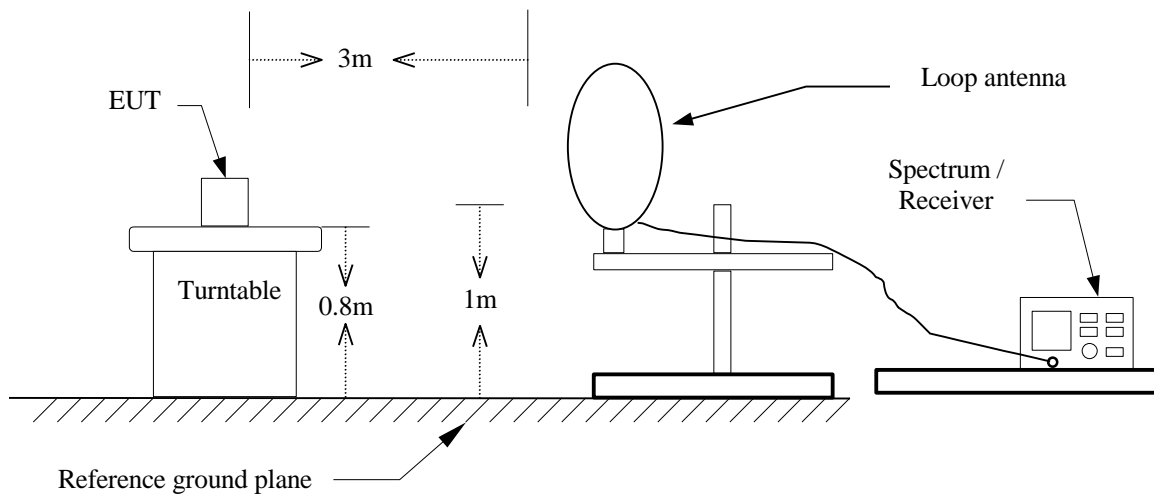

30MHz ~ 1GHz

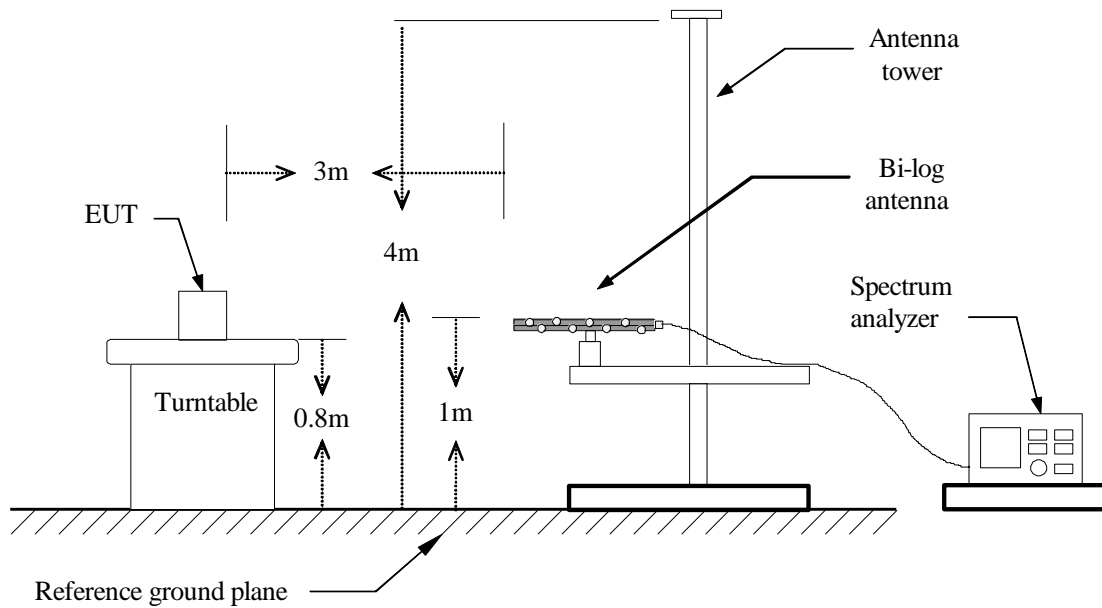

Above 1 GHz

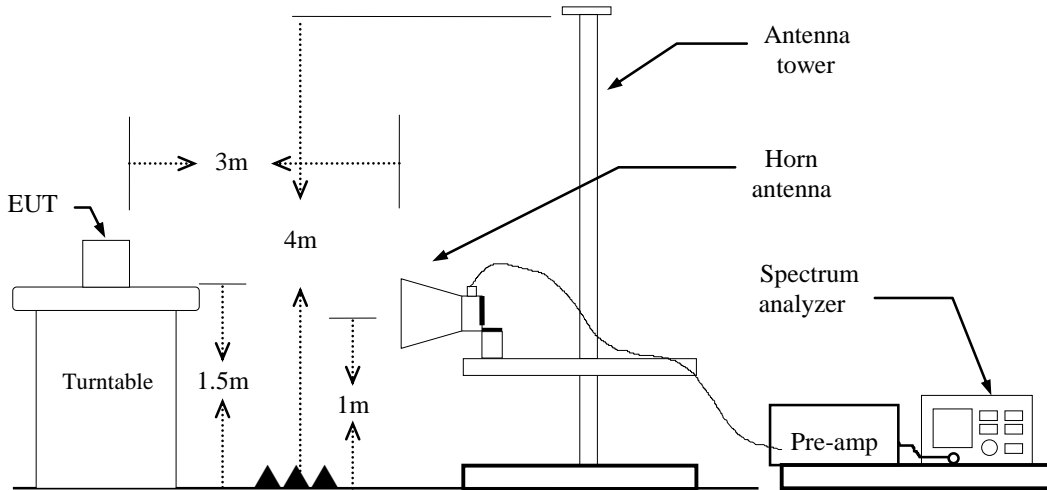

Report No.: T200504W06-RP3

5.6.4 Test Result

Band Edge Test Data

Test Mode	IEEE 802.11b Low CH 2412MHz	Temp/Hum	23.6(°C)/ 45%RH
Test Item	Band Edge	Test Date	May 13, 2020
Polarize	Vertical	Test Engineer	Jerry Chang
Detector	Peak / Average		

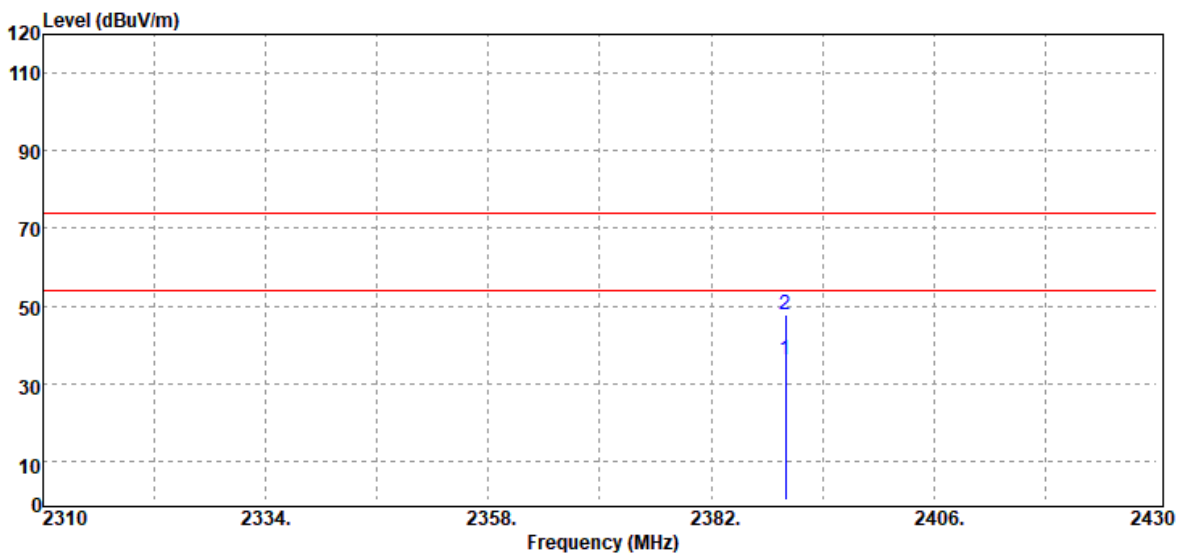

Frequency (MHz)	Detector Mode (PK/QP/AV)	Spectrum Reading Level (dBμV)	Factor (dB)	Actual FS (dBμV/m)	Limit @3m (dBμV/m)	Margin (dB)
2390.00	Average	39.34	-3.17	36.17	54.00	-17.83
2390.00	Peak	51.09	-3.17	47.92	74.00	-26.08

Report No.: T200504W06-RP3

Test Mode	IEEE 802.11b Low CH 2412MHz	Temp/Hum	23.6(°C)/ 45%RH
Test Item	Band Edge	Test Date	May 13, 2020
Polarize	Horizontal	Test Engineer	Jerry Chang
Detector	Peak & Average		

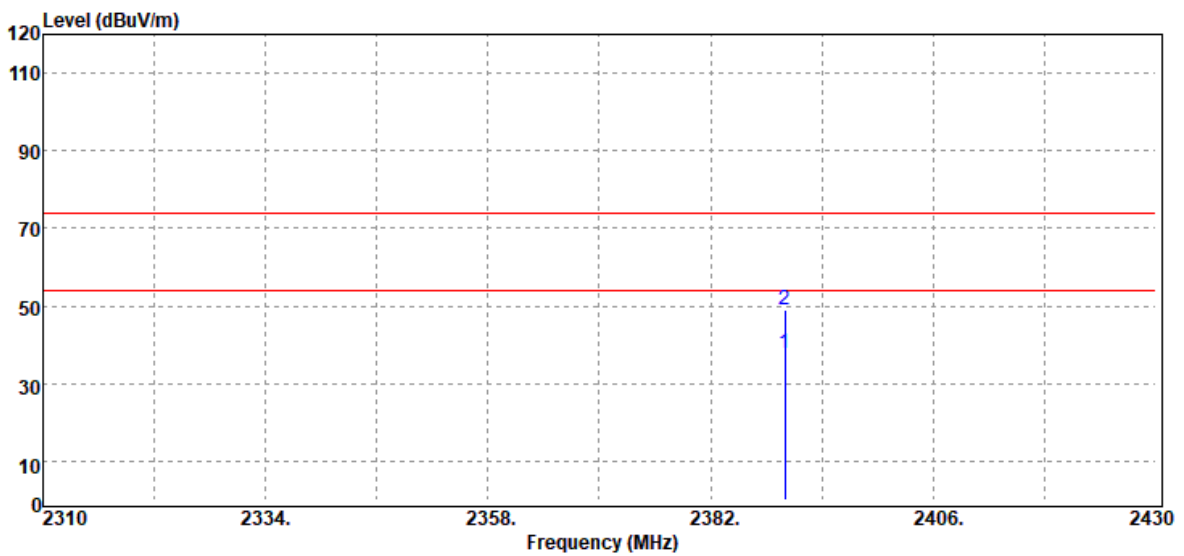

Frequency (MHz)	Detector Mode (PK/QP/AV)	Spectrum Reading Level (dBμV)	Factor (dB)	Actual FS (dBμV/m)	Limit @3m (dBμV/m)	Margin (dB)
2390.00	Average	41.07	-3.17	37.90	54.00	-16.10
2390.00	Peak	52.30	-3.17	49.13	74.00	-24.87

Report No.: T200504W06-RP3

Test Mode	IEEE 802.11b High CH 2462MHz	Temp/Hum	23.6(°C)/ 45%RH
Test Item	Band Edge	Test Date	May 13, 2020
Polarize	Vertical	Test Engineer	Jerry Chang
Detector	Peak / Average		

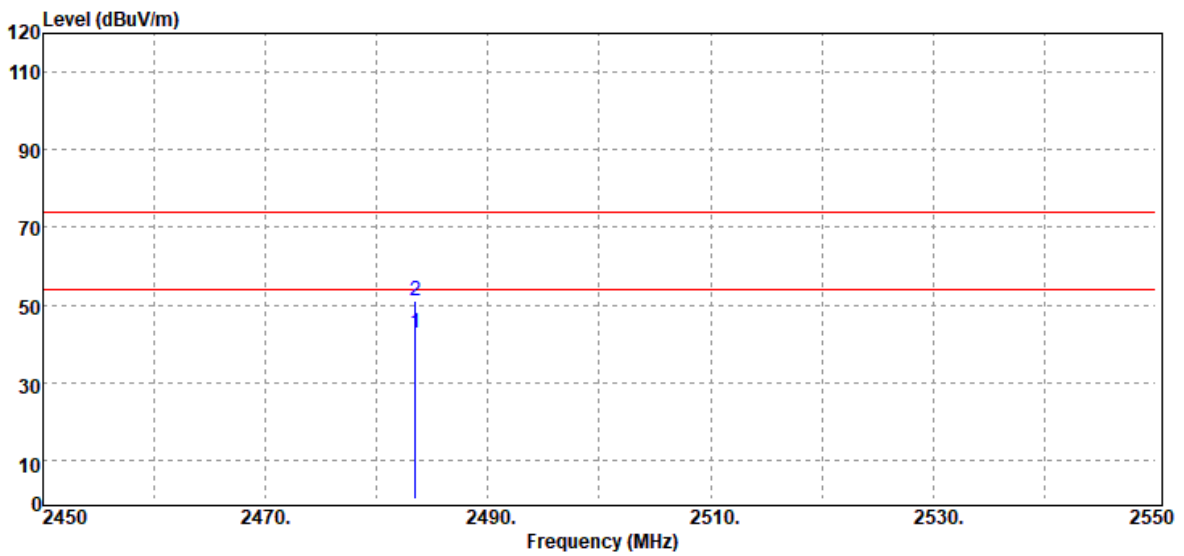

Frequency (MHz)	Detector Mode (PK/QP/AV)	Spectrum Reading Level (dBμV)	Factor (dB)	Actual FS (dBμV/m)	Limit @3m (dBμV/m)	Margin (dB)
2483.50	Average	45.41	-2.71	42.70	54.00	-11.30
2483.50	Peak	53.91	-2.71	51.20	74.00	-22.80

Report No.: T200504W06-RP3

Test Mode	IEEE 802.11b High CH 2462MHz	Temp/Hum	23.6(°C)/ 45%RH
Test Item	Band Edge	Test Date	May 13, 2020
Polarize	Horizontal	Test Engineer	Jerry Chang
Detector	Peak & Average		

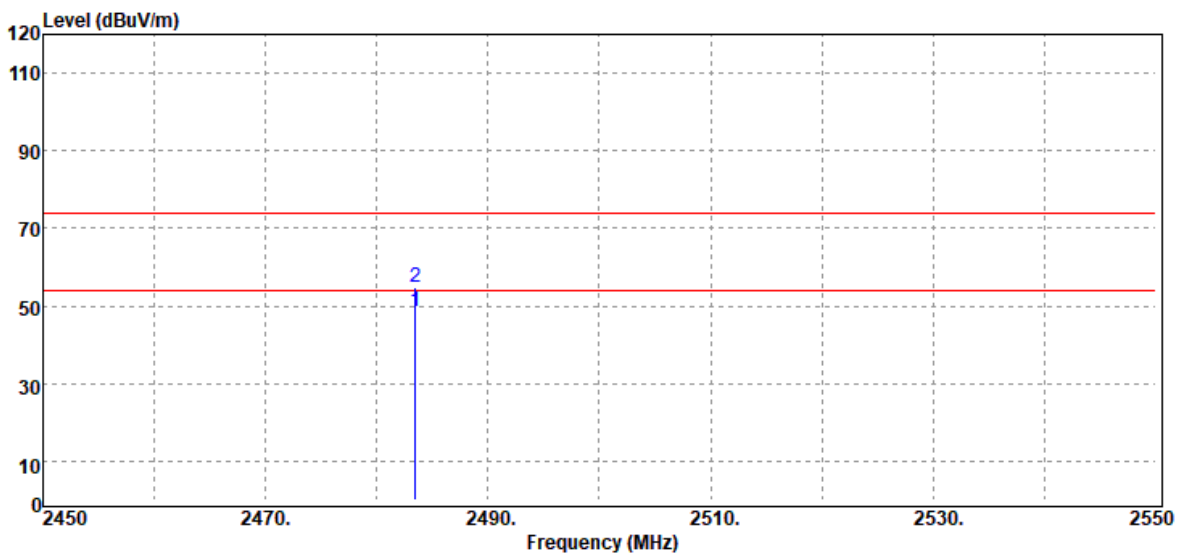

Frequency (MHz)	Detector Mode (PK/QP/AV)	Spectrum Reading Level (dBμV)	Factor (dB)	Actual FS (dBμV/m)	Limit @3m (dBμV/m)	Margin (dB)
2483.50	Average	51.34	-2.71	48.63	54.00	-5.37
2483.50	Peak	57.35	-2.71	54.64	74.00	-19.36

Report No.: T200504W06-RP3

Test Mode	IEEE 802.11g Low CH 2412MHz	Temp/Hum	23.6(°C)/ 45%RH
Test Item	Band Edge	Test Date	May 13, 2020
Polarize	Vertical	Test Engineer	Jerry Chang
Detector	Peak / Average		

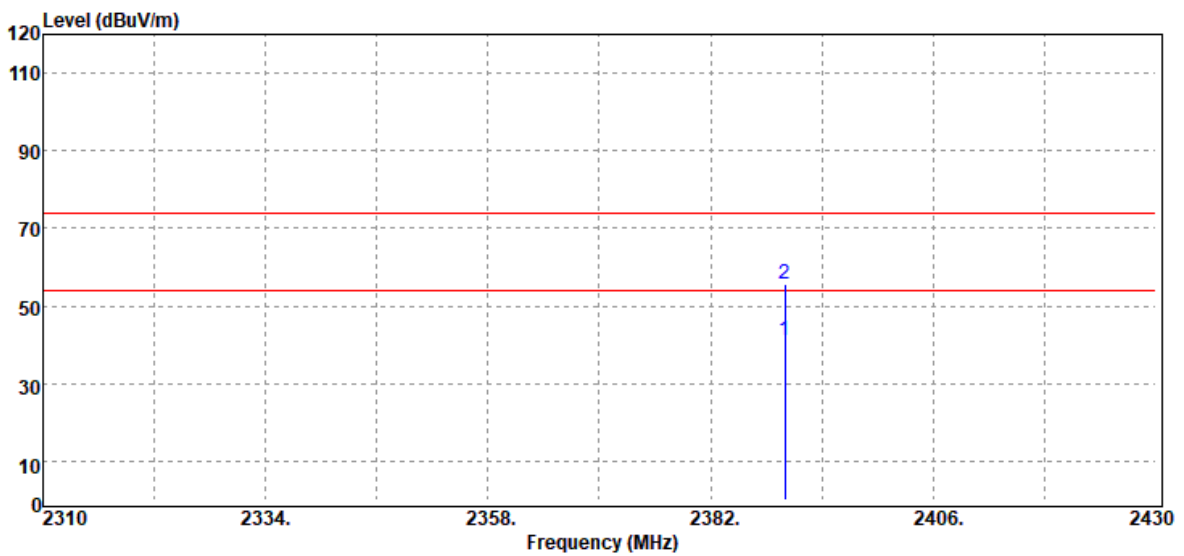

Frequency (MHz)	Detector Mode (PK/QP/AV)	Spectrum Reading Level (dBμV)	Factor (dB)	Actual FS (dBμV/m)	Limit @3m (dBμV/m)	Margin (dB)
2390.00	Average	44.08	-3.17	40.91	54.00	-13.09
2390.00	Peak	58.80	-3.17	55.63	74.00	-18.37

Report No.: T200504W06-RP3

Test Mode	IEEE 802.11g Low CH 2412MHz	Temp/Hum	23.6(°C)/ 45%RH
Test Item	Band Edge	Test Date	March 26, 2020
Polarize	Horizontal	Test Engineer	Jerry Chang
Detector	Peak & Average		

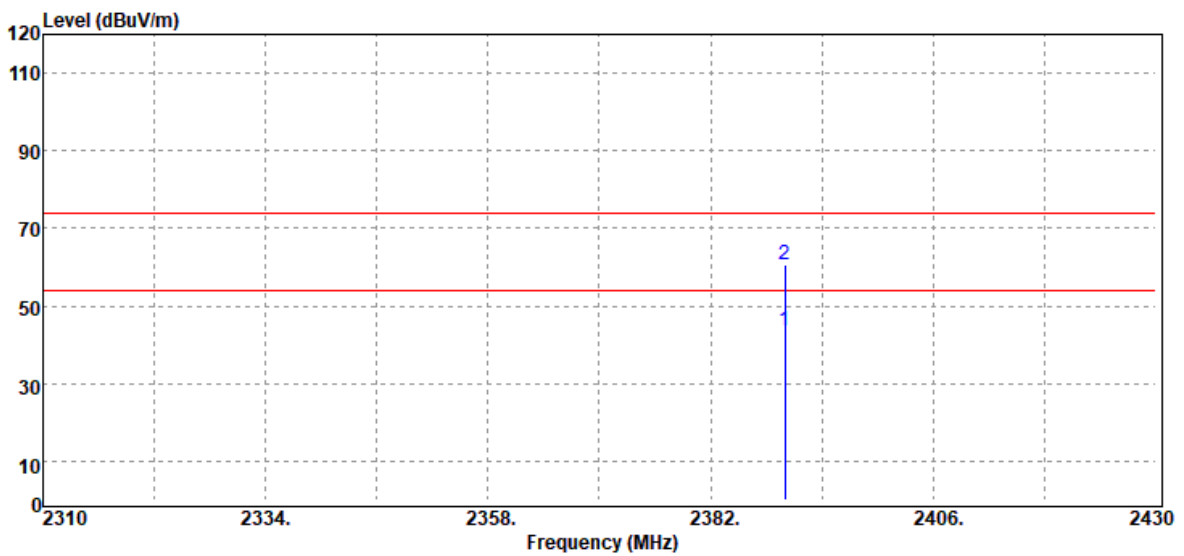

Frequency (MHz)	Detector Mode (PK/QP/AV)	Spectrum Reading Level (dBμV)	Factor (dB)	Actual FS (dBμV/m)	Limit @3m (dBμV/m)	Margin (dB)
2390.00	Average	46.59	-3.17	43.42	54.00	-10.58
2390.00	Peak	63.90	-3.17	60.73	74.00	-13.27

Report No.: T200504W06-RP3

Test Mode	IEEE 802.11g High CH 2462MHz	Temp/Hum	23.6(°C)/ 45%RH
Test Item	Band Edge	Test Date	May 13, 2020
Polarize	Vertical	Test Engineer	Jerry Chang
Detector	Peak / Average		

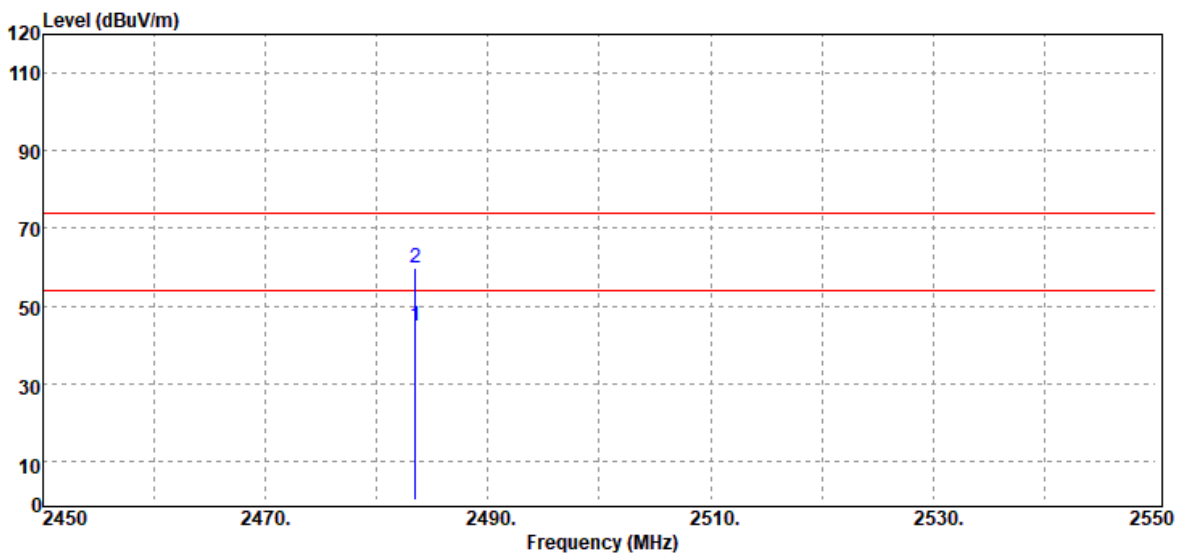

Frequency (MHz)	Detector Mode (PK/QP/AV)	Spectrum Reading Level (dB μ V)	Factor (dB)	Actual FS (dB μ V/m)	Limit @3m (dB μ V/m)	Margin (dB)
2483.50	Average	47.67	-2.71	44.96	54.00	-9.04
2483.50	Peak	62.46	-2.71	59.75	74.00	-14.25

Report No.: T200504W06-RP3

Test Mode	IEEE 802.11g High CH 2462MHz	Temp/Hum	23.6(°C)/ 45%RH
Test Item	Band Edge	Test Date	May 13, 2020
Polarize	Horizontal	Test Engineer	Jerry Chang
Detector	Peak & Average		

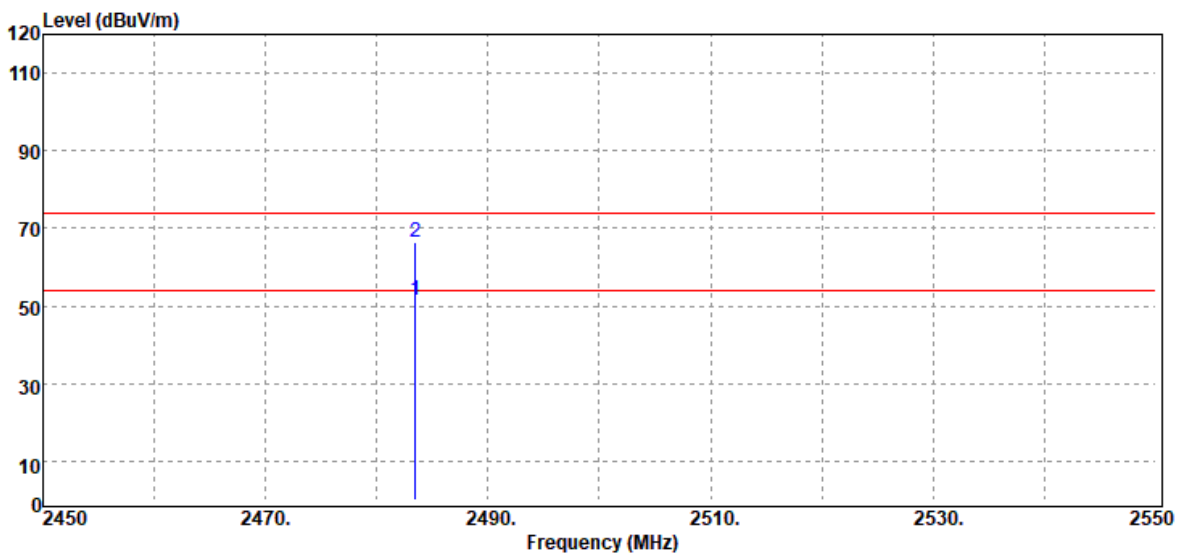

Frequency (MHz)	Detector Mode (PK/QP/AV)	Spectrum Reading Level (dB μ V)	Factor (dB)	Actual FS (dB μ V/m)	Limit @3m (dB μ V/m)	Margin (dB)
2483.50	Average	54.08	-2.71	51.37	54.00	-2.63
2483.50	Peak	69.25	-2.71	66.54	74.00	-7.46

Report No.: T200504W06-RP3

Test Mode	IEEE 802.11n HT20 Low CH 2412MHz	Temp/Hum	23.6(°C)/ 45%RH
Test Item	Band Edge	Test Date	May 13, 2020
Polarize	Vertical	Test Engineer	Jerry Chang
Detector	Peak / Average		

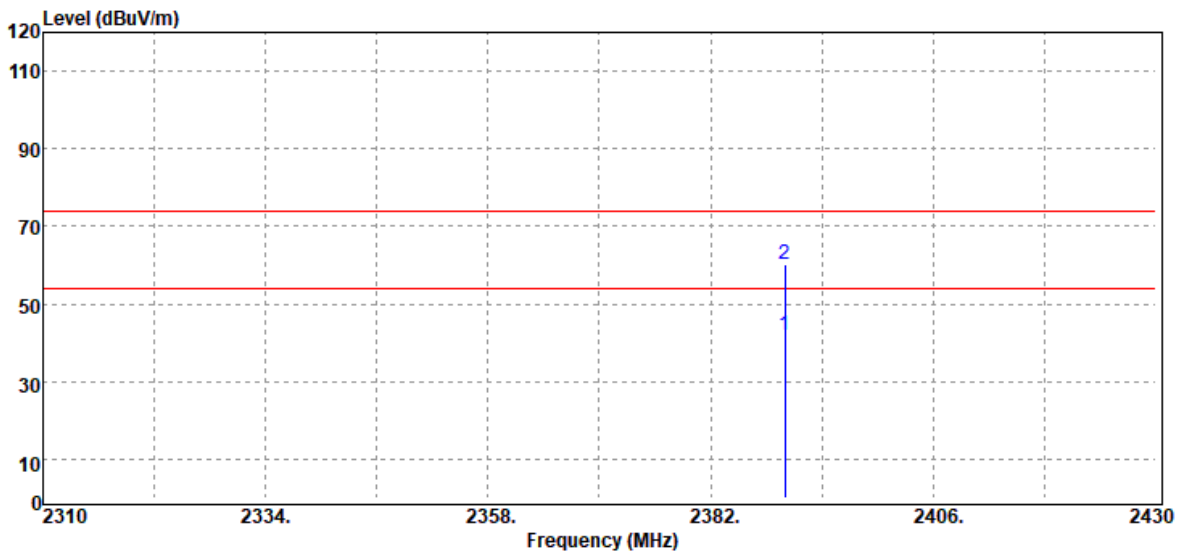

Frequency (MHz)	Detector Mode (PK/QP/AV)	Spectrum Reading Level (dB μ V)	Factor (dB)	Actual FS (dB μ V/m)	Limit @3m (dB μ V/m)	Margin (dB)
2390.00	Average	44.96	-3.17	41.79	54.00	-12.21
2390.00	Peak	63.40	-3.17	60.23	74.00	-13.77

Report No.: T200504W06-RP3

Test Mode	IEEE 802.11 n20 Low CH 2412MHz	Temp/Hum	23.6(°C)/ 45%RH
Test Item	Band Edge	Test Date	May 13, 2020
Polarize	Horizontal	Test Engineer	Jerry Chang
Detector	Peak & Average		

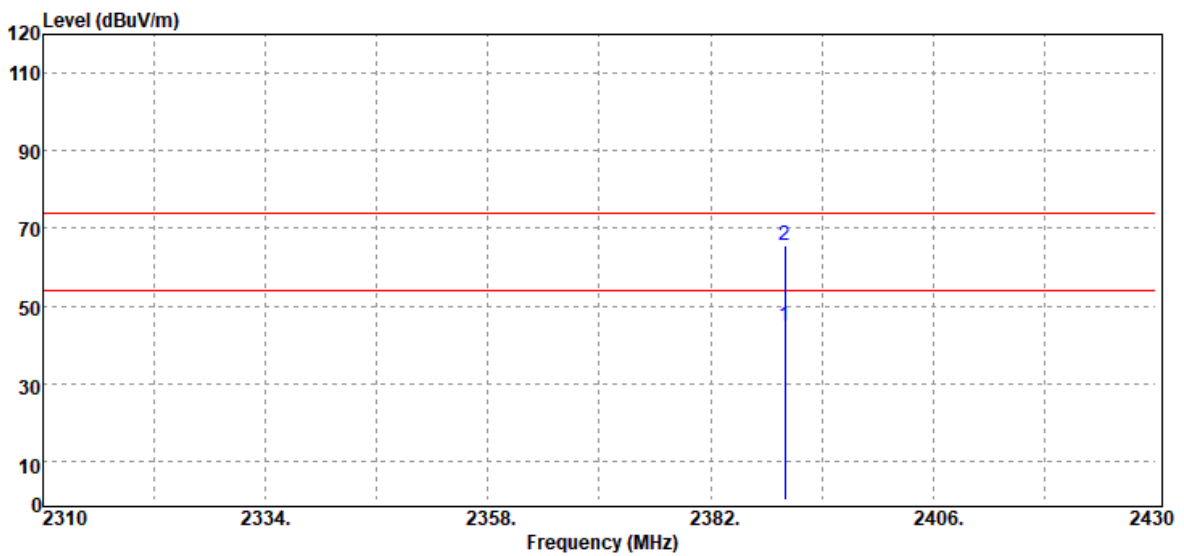

Frequency (MHz)	Detector Mode (PK/QP/AV)	Spectrum Reading Level (dBμV)	Factor (dB)	Actual FS (dBμV/m)	Limit @3m (dBμV/m)	Margin (dB)
2390.00	Average	47.91	-3.17	44.74	54.00	-9.26
2390.00	Peak	68.91	-3.17	65.74	74.00	-8.26

Report No.: T200504W06-RP3

Test Mode	IEEE 802.11n HT20 High CH 2462MHz	Temp/Hum	23.6(°C)/ 45%RH
Test Item	Band Edge	Test Date	May 13, 2020
Polarize	Vertical	Test Engineer	Jerry Chang
Detector	Peak / Average		

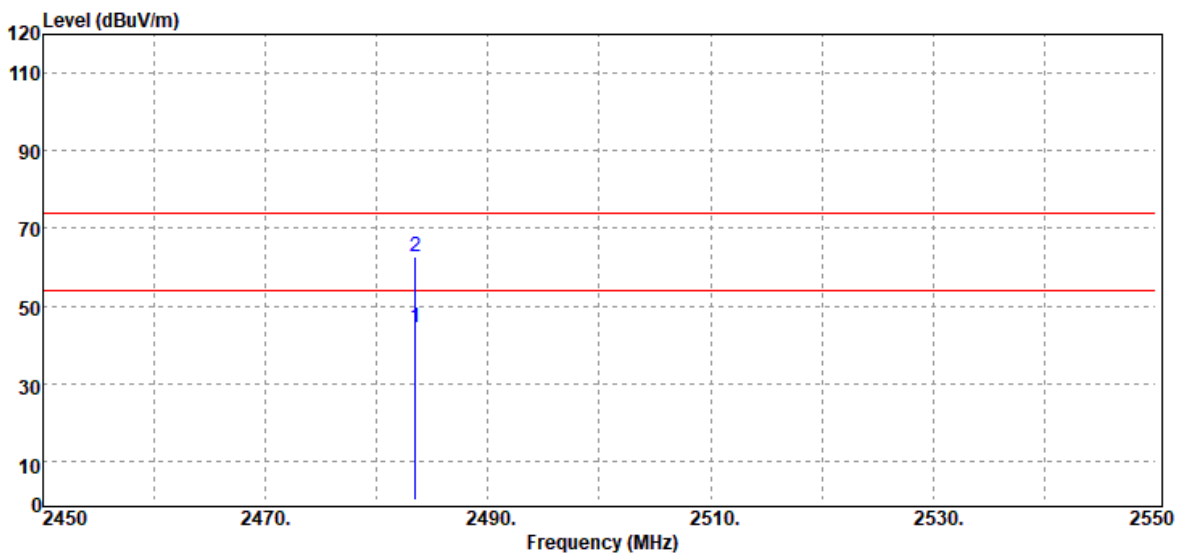

Frequency (MHz)	Detector Mode (PK/QP/AV)	Spectrum Reading Level (dBμV)	Factor (dB)	Actual FS (dBμV/m)	Limit @3m (dBμV/m)	Margin (dB)
2483.50	Average	47.31	-2.71	44.60	54.00	-9.40
2483.50	Peak	65.31	-2.71	62.60	74.00	-11.40

Report No.: T200504W06-RP3

Test Mode	IEEE 802.11n20 High CH 2462MHz	Temp/Hum	23.6(°C)/ 45%RH
Test Item	Band Edge	Test Date	May 13, 2020
Polarize	Horizontal	Test Engineer	Jerry Chang
Detector	Peak & Average		

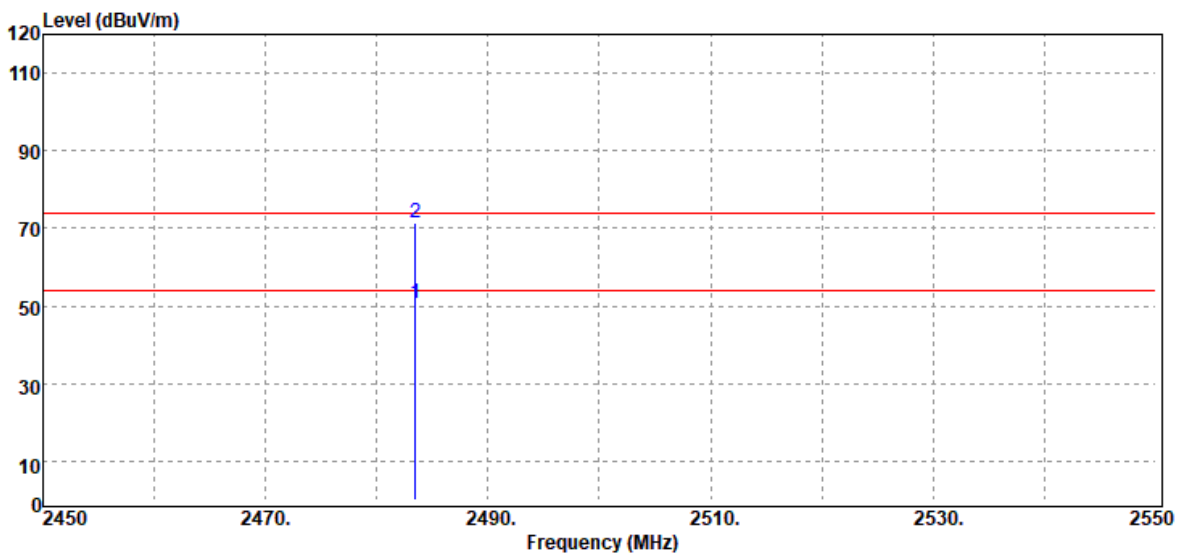

Frequency (MHz)	Detector Mode (PK/QP/AV)	Spectrum Reading Level (dB μ V)	Factor (dB)	Actual FS (dB μ V/m)	Limit @3m (dB μ V/m)	Margin (dB)
2483.50	Average	53.51	-2.71	50.80	54.00	-3.20
2483.50	Peak	74.00	-2.71	71.29	74.00	-2.71

Report No.: T200504W06-RP3

Test Mode	IEEE 802.11n HT40 Low CH 2422MHz	Temp/Hum	23.6(°C)/ 45%RH
Test Item	Band Edge	Test Date	May 13, 2020
Polarize	Vertical	Test Engineer	Jerry Chang
Detector	Peak / Average	Test Voltage	

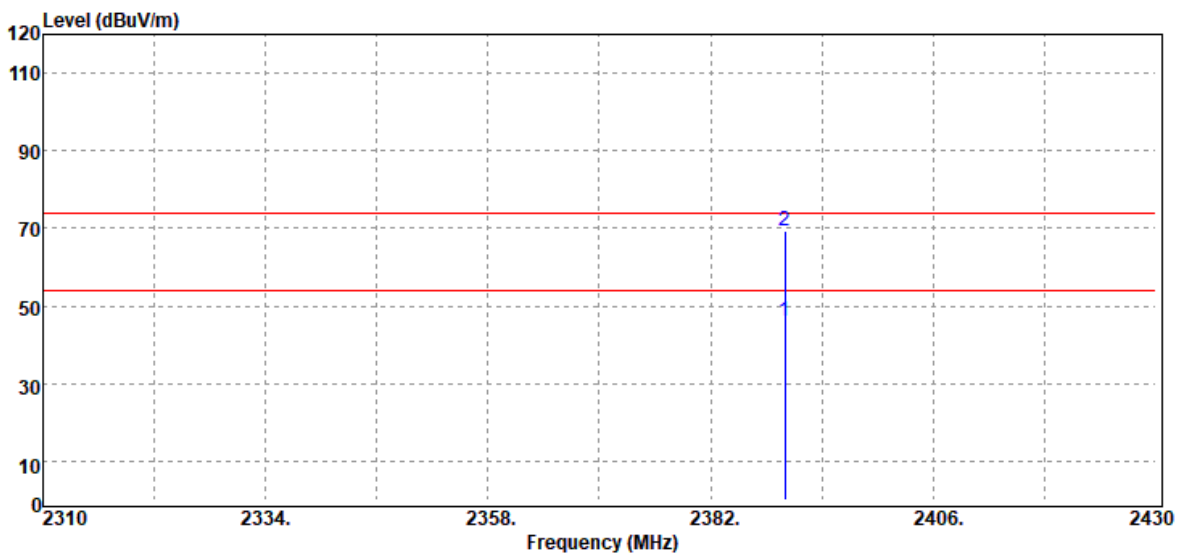

Frequency (MHz)	Detector Mode (PK/QP/AV)	Spectrum Reading Level (dB μ V)	Factor (dB)	Actual FS (dB μ V/m)	Limit @3m (dB μ V/m)	Margin (dB)
2390.00	Average	49.38	-3.17	46.21	54.00	-7.79
2390.00	Peak	72.32	-3.17	69.15	74.00	-4.85

Report No.: T200504W06-RP3

Test Mode	IEEE 802.11n HT40 Low CH 2422MHz	Temp/Hum	23.6(°C)/ 45%RH
Test Item	Band Edge	Test Date	May 13, 2020
Polarize	Horizontal	Test Engineer	Jerry Chang
Detector	Peak / Average	Test Voltage	

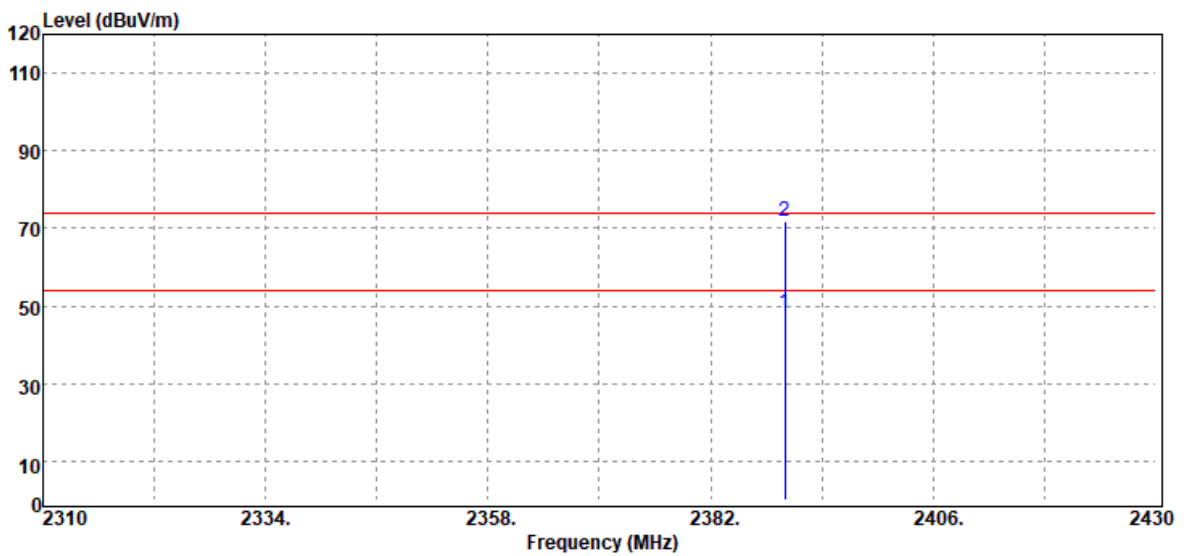

Frequency (MHz)	Detector Mode (PK/QP/AV)	Spectrum Reading Level (dB μ V)	Factor (dB)	Actual FS (dB μ V/m)	Limit @3m (dB μ V/m)	Margin (dB)
2390.00	Average	51.54	-3.17	48.37	54.00	-5.63
2390.00	Peak	75.11	-3.17	71.94	74.00	-2.06

Report No.: T200504W06-RP3

Test Mode	IEEE 802.11n HT40 High CH 2452MHz	Temp/Hum	23.6(°C)/ 45%RH
Test Item	Band Edge	Test Date	May 13, 2020
Polarize	Vertical	Test Engineer	Jerry Chang
Detector	Peak / Average	Test Voltage	

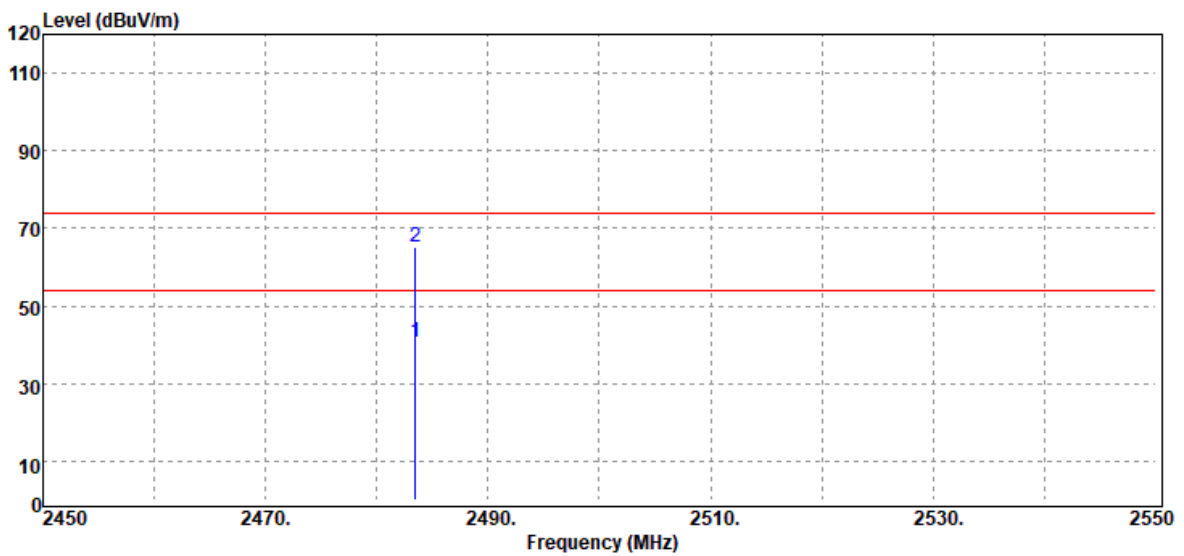

Frequency (MHz)	Detector Mode (PK/QP/AV)	Spectrum Reading Level (dBμV)	Factor (dB)	Actual FS (dBμV/m)	Limit @3m (dBμV/m)	Margin (dB)
2483.50	Average	43.48	-2.71	40.77	54.00	-13.23
2483.50	Peak	67.76	-2.71	65.05	74.00	-8.95

Report No.: T200504W06-RP3

Test Mode	IEEE 802.11n HT40 High CH 2452MHz	Temp/Hum	23.6(°C)/ 45%RH
Test Item	Band Edge	Test Date	May 13, 2020
Polarize	Horizontal	Test Engineer	Jerry Chang
Detector	Peak / Average	Test Voltage	

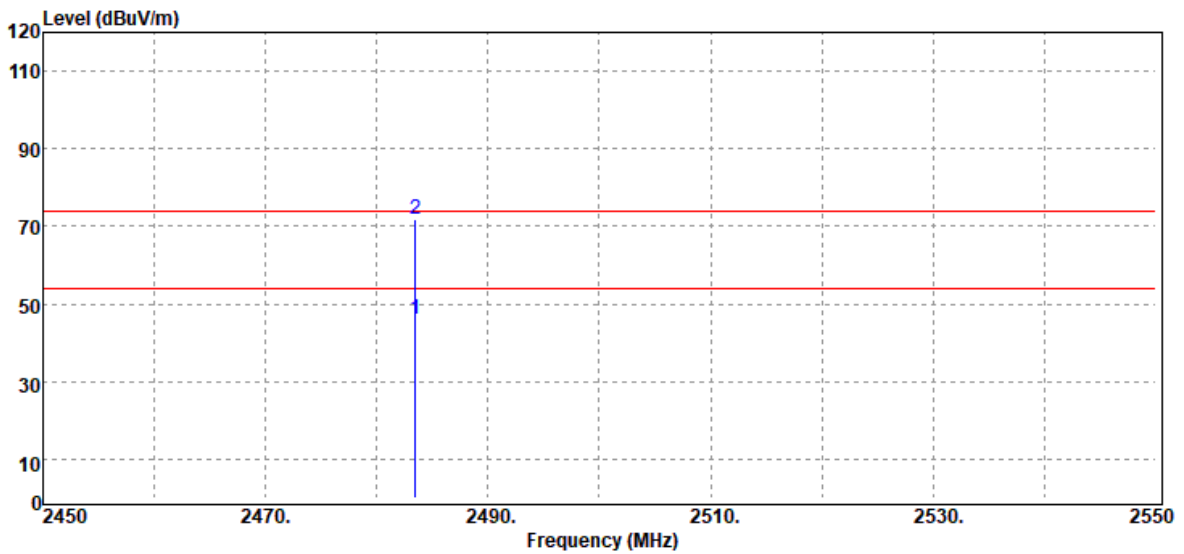

Frequency (MHz)	Detector Mode (PK/QP/AV)	Spectrum Reading Level (dBμV)	Factor (dB)	Actual FS (dBμV/m)	Limit @3m (dBμV/m)	Margin (dB)
2483.50	Average	48.82	-2.71	46.11	54.00	-7.89
2483.50	Peak	74.53	-2.71	71.82	74.00	-2.18

Report No.: T200504W06-RP3

Below 1G Test Data

Test Mode	Mode 1	Temp/Hum	23.6(°C)/ 45%RH
Test Item	30MHz-1GHz	Test Date	May 13, 2020
Polarize	Vertical	Test Engineer	Jerry Chang
Detector	Peak	Test Voltage	

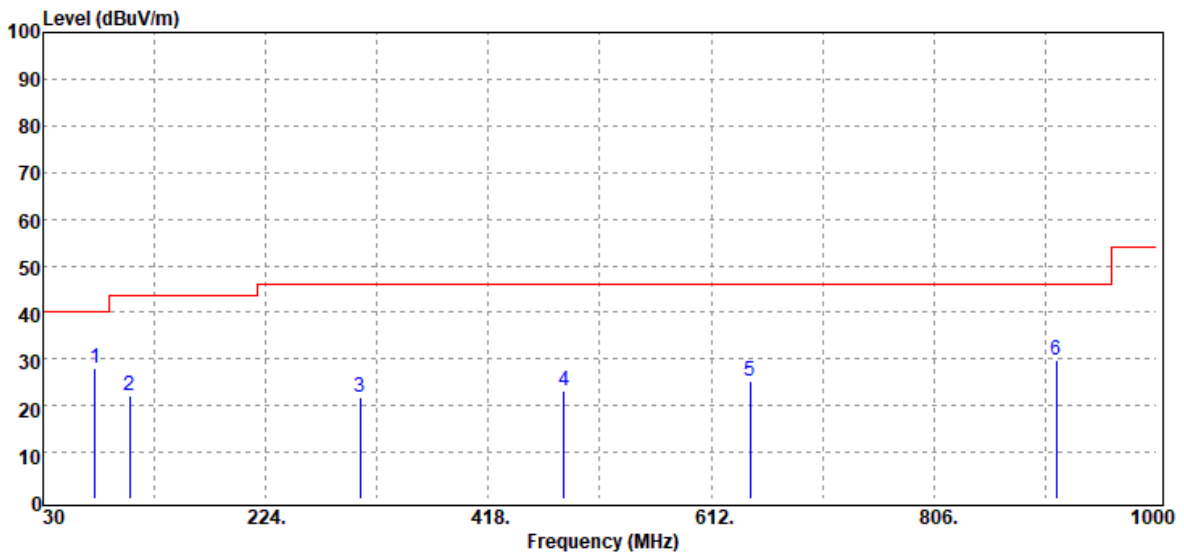

Freq. (MHz)	Detector Mode (PK/QP/AV)	Spectrum Reading Level (dBµV)	Factor (dB)	Actual FS (dBµV/m)	Limit @3m (dBµV/m)	Margin (dB)
75.59	Peak	43.18	-15.04	28.14	40.00	-11.86
105.66	Peak	33.54	-11.23	22.31	43.50	-21.19
306.45	Peak	30.02	-8.29	21.73	46.00	-24.27
483.96	Peak	26.44	-3.28	23.16	46.00	-22.84
645.95	Peak	25.83	-0.57	25.26	46.00	-20.74
912.70	Peak	26.36	3.54	29.90	46.00	-16.10

Note: No emission found between lowest internal used/generated frequency to 30MHz(9KHz~30MHz)

Report No.: T200504W06-RP3

Test Mode	Mode 1	Temp/Hum	23.6(°C)/ 45%RH
Test Item	30MHz-1GHz	Test Date	May 13, 2020
Polarize	Horizontal	Test Engineer	Jerry Chang
Detector	Peak	Test Voltage	

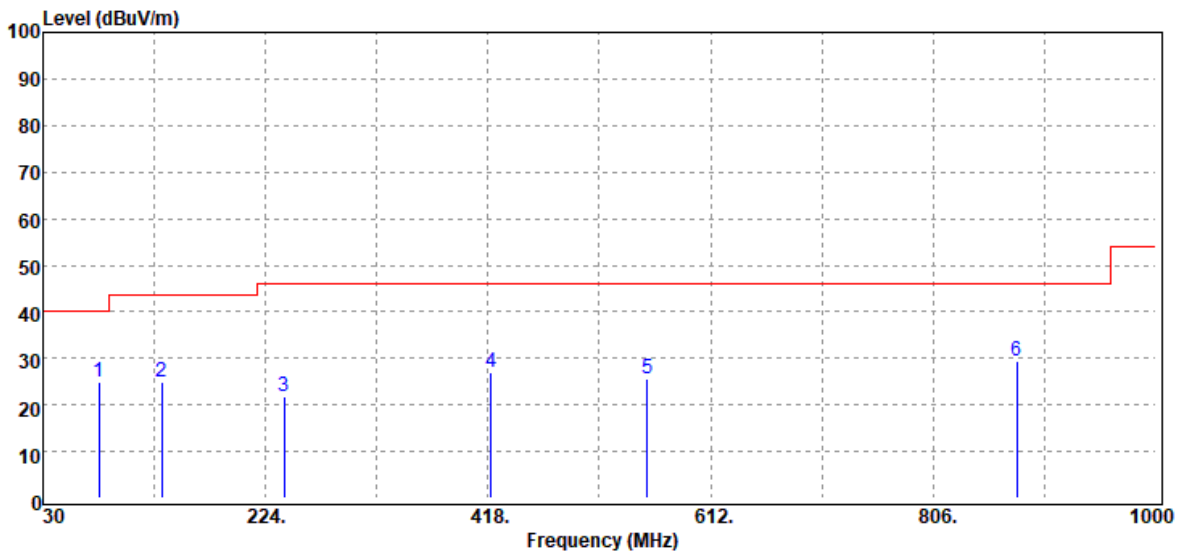

Freq. (MHz)	Detector Mode (PK/QP/AV)	Spectrum Reading Level (dBμV)	Factor (dB)	Actual FS (dBμV/m)	Limit @3m (dBμV/m)	Margin (dB)
78.50	Peak	40.38	-15.33	25.05	40.00	-14.95
133.79	Peak	34.34	-9.36	24.98	43.50	-18.52
240.49	Peak	32.26	-10.55	21.71	46.00	-24.29
420.91	Peak	32.16	-5.04	27.12	46.00	-18.88
556.71	Peak	28.06	-2.45	25.61	46.00	-20.39
878.75	Peak	26.34	2.99	29.33	46.00	-16.67

Note: No emission found between lowest internal used/generated frequency to 30MHz(9KHz~30MHz)

Above 1G Test Data

Test Mode	IEEE 802.11b Low CH	Temp/Hum	23.6(°C)/ 45%RH
Test Item	Harmonic	Test Date	May 13, 2020
Polarize	Vertical	Test Engineer	Jerry Chang
Detector	Peak		

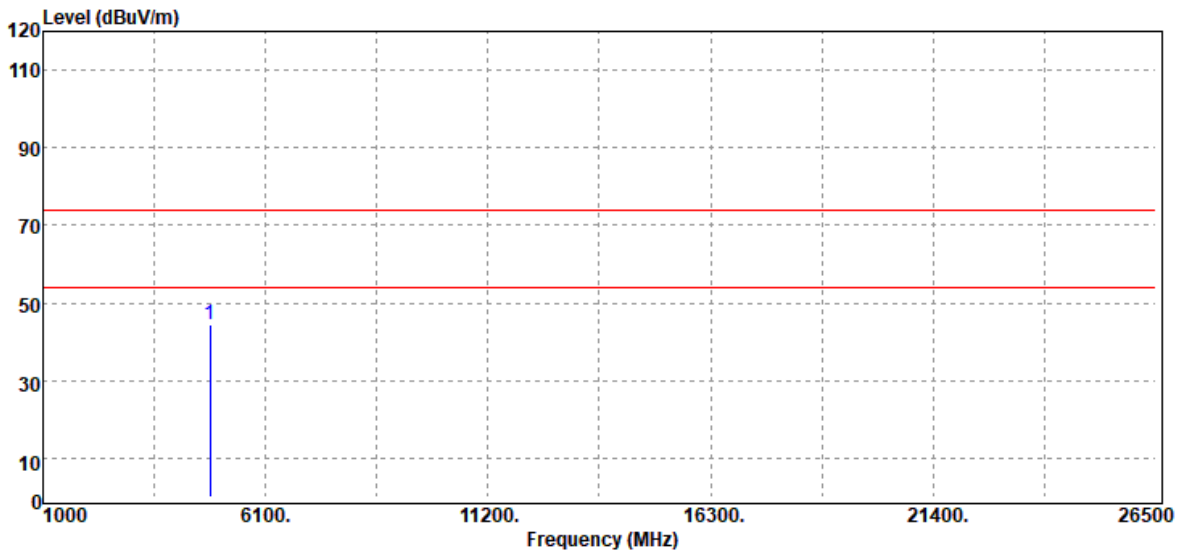

Freq. (MHz)	Detector Mode (PK/QP/AV)	Spectrum Reading Level (dBμV)	Factor (dB)	Actual FS (dBμV/m)	Limit @3m (dBμV/m)	Margin (dB)
4824.00	Peak	40.90	3.35	44.25	74.00	-29.75
N/A						

Remark:

1. Measuring frequencies from 1 GHz to the 10th harmonic of highest fundamental frequency.
2. For above 1GHz, the EUT peak value was under average limit, therefore the Average value compliance with the average limit

Report No.: T200504W06-RP3

Test Mode	IEEE 802.11b Low CH	Temp/Hum	23.6(°C)/ 45%RH
Test Item	Harmonic	Test Date	May 13, 2020
Polarize	Horizontal	Test Engineer	Jerry Chang
Detector	Peak		

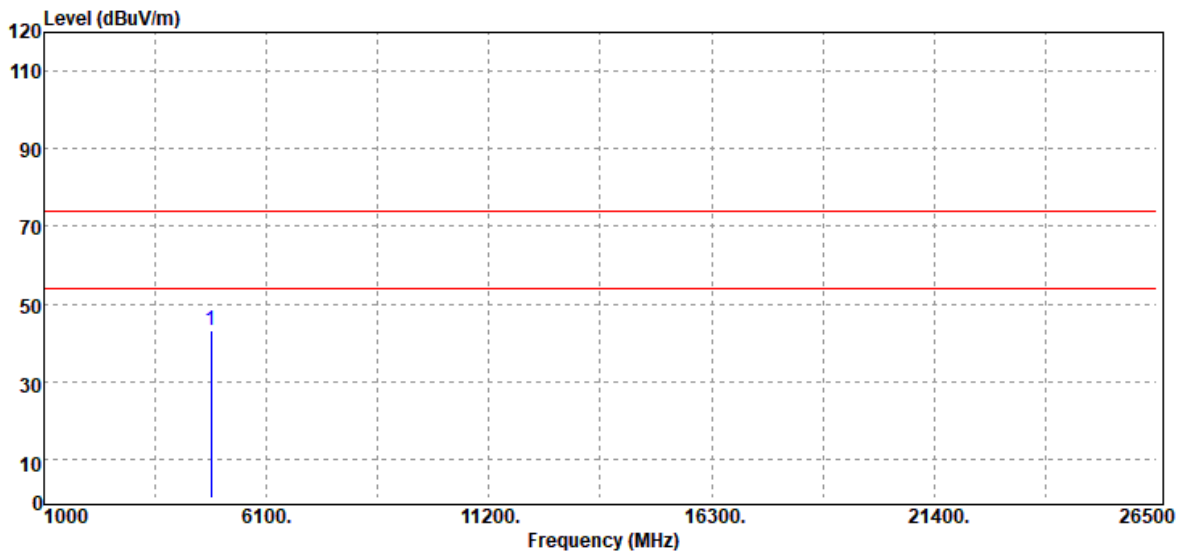

Freq. (MHz)	Detector Mode (PK/QP/AV)	Spectrum Reading Level (dBμV)	Factor (dB)	Actual FS (dBμV/m)	Limit @3m (dBμV/m)	Margin (dB)
4824.00	Peak	39.69	3.35	43.04	74.00	-30.96
N/A						

Remark:

1. Measuring frequencies from 1 GHz to the 10th harmonic of highest fundamental frequency.
2. For above 1GHz, the EUT peak value was under average limit, therefore the Average value compliance with the average limit

Report No.: T200504W06-RP3

Test Mode	IEEE 802.11b Mid CH	Temp/Hum	23.6(°C)/ 45%RH
Test Item	Harmonic	Test Date	May 13, 2020
Polarize	Vertical	Test Engineer	Jerry Chang
Detector	Peak		

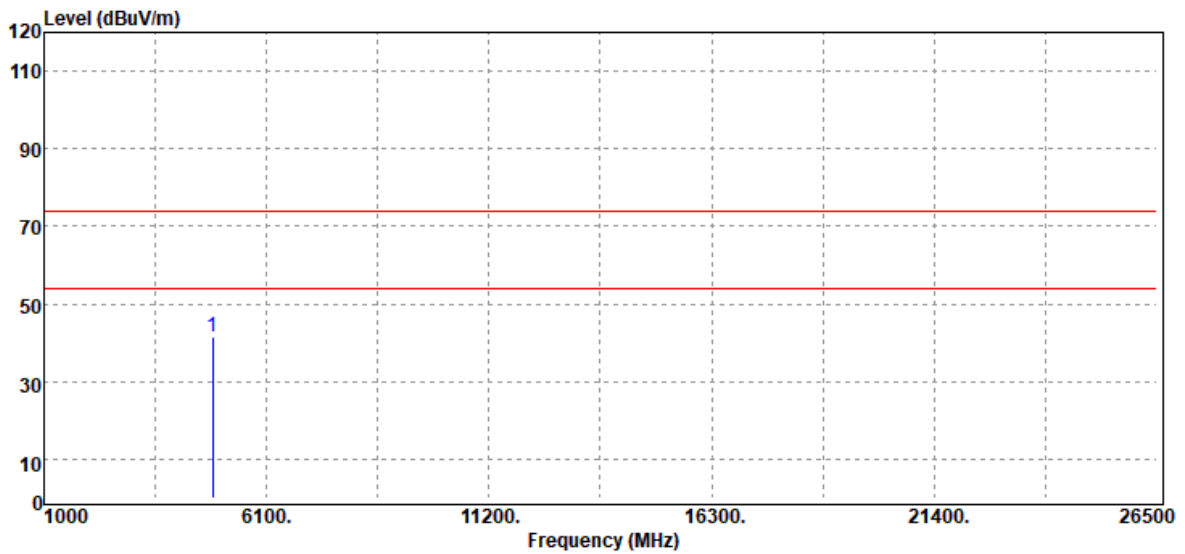

Freq. (MHz)	Detector Mode (PK/QP/AV)	Spectrum Reading Level (dB μ V)	Factor (dB)	Actual FS (dB μ V/m)	Limit @3m (dB μ V/m)	Margin (dB)
4874.00	Peak	38.24	3.48	41.72	74.00	-32.28
N/A						

Remark:

1. Measuring frequencies from 1 GHz to the 10th harmonic of highest fundamental frequency.
2. For above 1GHz, the EUT peak value was under average limit, therefore the Average value compliance with the average limit

Report No.: T200504W06-RP3

Test Mode	IEEE 802.11b Mid CH	Temp/Hum	23.6(°C)/ 45%RH
Test Item	Harmonic	Test Date	May 13, 2020
Polarize	Horizontal	Test Engineer	Jerry Chang
Detector	Peak		

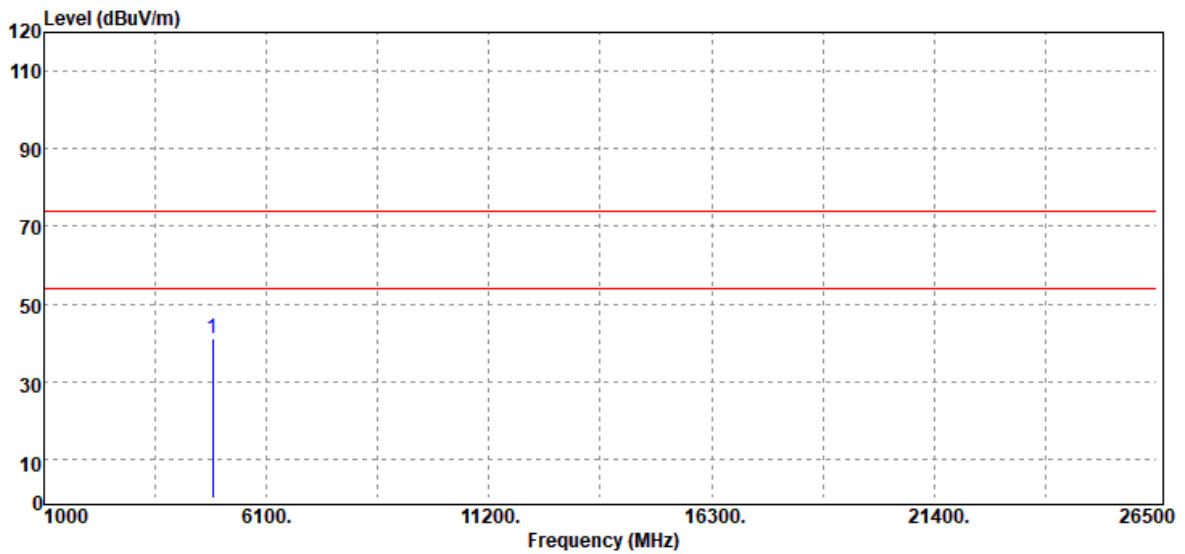

Freq. (MHz)	Detector Mode (PK/QP/AV)	Spectrum Reading Level (dB μ V)	Factor (dB)	Actual FS (dB μ V/m)	Limit @3m (dB μ V/m)	Margin (dB)
4874.00	Peak	37.80	3.48	41.28	74.00	-32.72
N/A						

Remark:

1. Measuring frequencies from 1 GHz to the 10th harmonic of highest fundamental frequency.
2. For above 1GHz, the EUT peak value was under average limit, therefore the Average value compliance with the average limit

Report No.: T200504W06-RP3

Test Mode	IEEE 802.11b High CH	Temp/Hum	23.6(°C)/ 45%RH
Test Item	Harmonic	Test Date	May 13, 2020
Polarize	Vertical	Test Engineer	Jerry Chang
Detector	Peak		

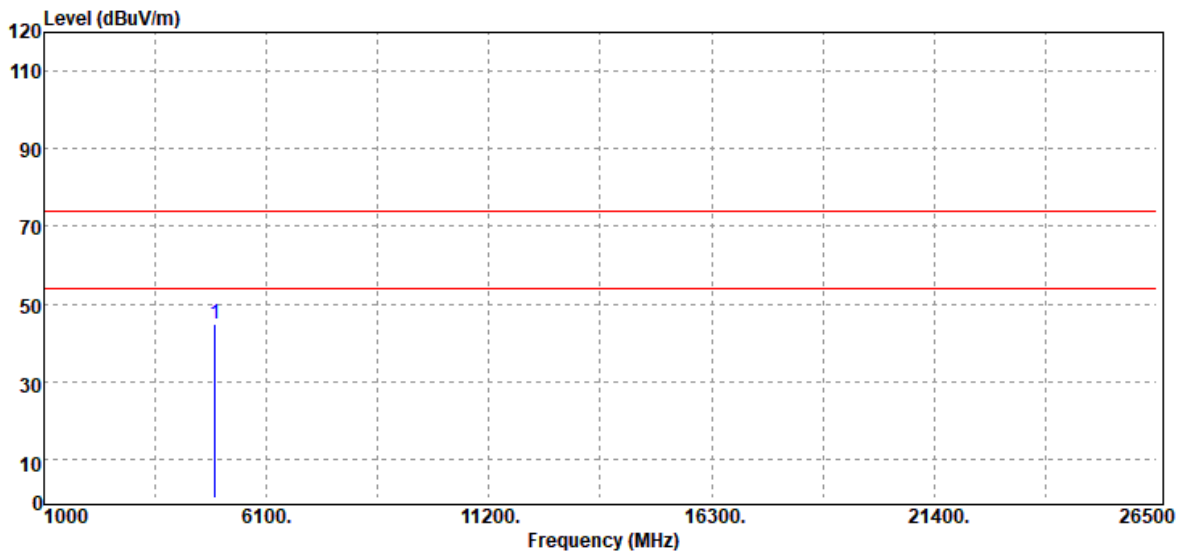

Freq. (MHz)	Detector Mode (PK/QP/AV)	Spectrum Reading Level (dB μ V)	Factor (dB)	Actual FS (dB μ V/m)	Limit @3m (dB μ V/m)	Margin (dB)
4924.00	Peak	40.94	4.01	44.95	74.00	-29.05
N/A						

Remark:

1. Measuring frequencies from 1 GHz to the 10th harmonic of highest fundamental frequency.
2. For above 1GHz, the EUT peak value was under average limit, therefore the Average value compliance with the average limit

Report No.: T200504W06-RP3

Test Mode	IEEE 802.11b High CH	Temp/Hum	23.6(°C)/ 45%RH
Test Item	Harmonic	Test Date	May 13, 2020
Polarize	Horizontal	Test Engineer	Jerry Chang
Detector	Peak		

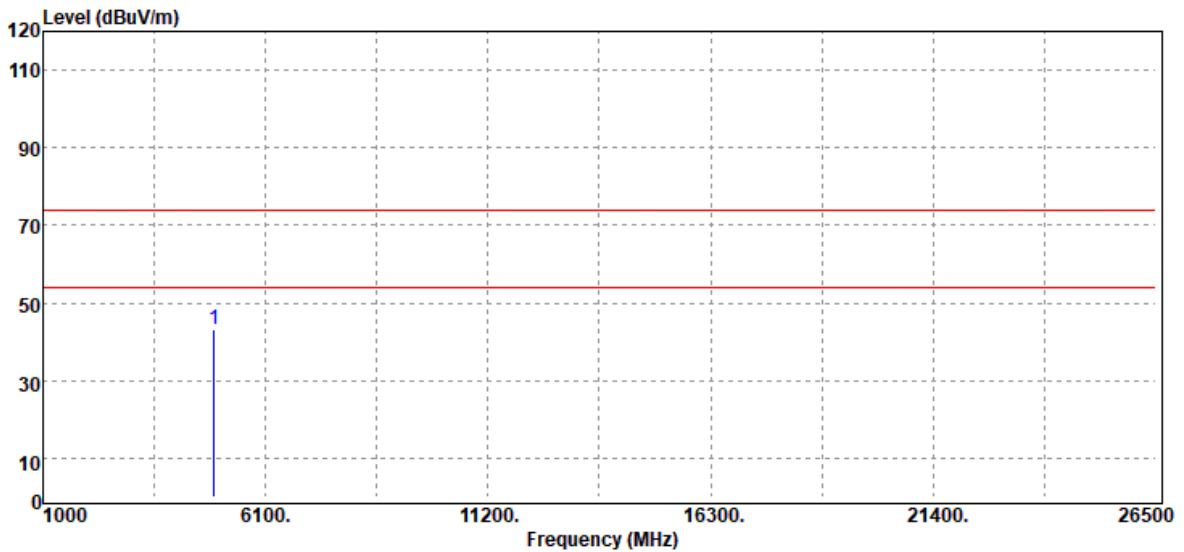

Freq. (MHz)	Detector Mode (PK/QP/AV)	Spectrum Reading Level (dB μ V)	Factor (dB)	Actual FS (dB μ V/m)	Limit @3m (dB μ V/m)	Margin (dB)
4924.00	Peak	39.09	4.01	43.10	74.00	-30.90
N/A						

Remark:

1. Measuring frequencies from 1 GHz to the 10th harmonic of highest fundamental frequency.
2. For above 1GHz, the EUT peak value was under average limit, therefore the Average value compliance with the average limit

Report No.: T200504W06-RP3

Test Mode	IEEE 802.11g Low CH	Temp/Hum	23.6(°C)/ 45%RH
Test Item	Harmonic	Test Date	May 13, 2020
Polarize	Vertical	Test Engineer	Jerry Chang
Detector	Peak		

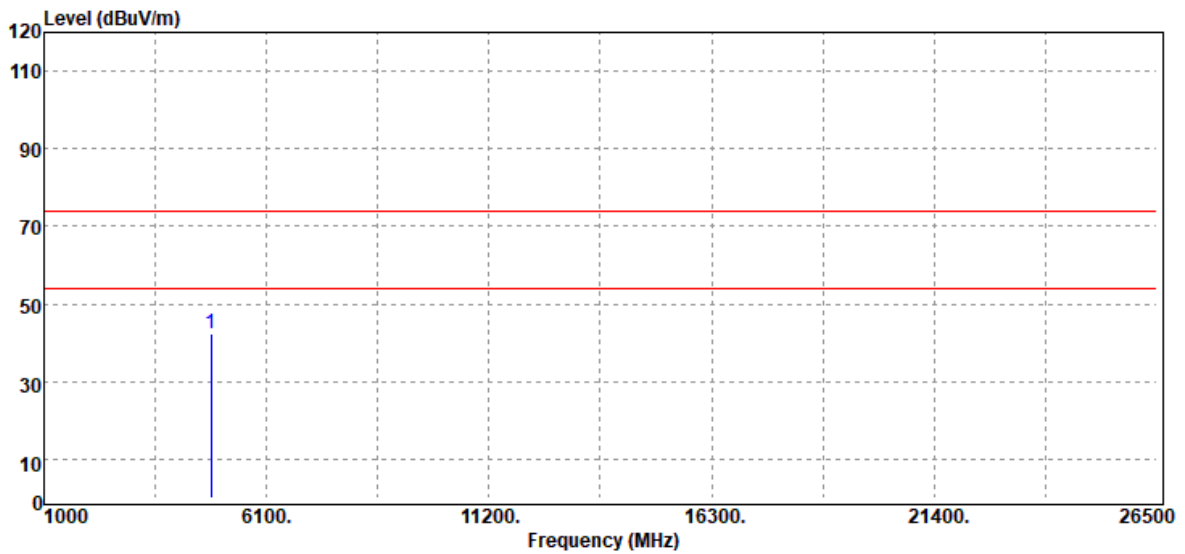

Freq. (MHz)	Detector Mode (PK/QP/AV)	Spectrum Reading Level (dBμV)	Factor (dB)	Actual FS (dBμV/m)	Limit @3m (dBμV/m)	Margin (dB)
4824.00	Peak	38.90	3.35	42.25	74.00	-31.75
N/A						

Remark:

1. Measuring frequencies from 1 GHz to the 10th harmonic of highest fundamental frequency.
2. For above 1GHz, the EUT peak value was under average limit, therefore the Average value compliance with the average limit

Report No.: T200504W06-RP3

Test Mode	IEEE 802.11g Low CH	Temp/Hum	23.6(°C)/ 45%RH
Test Item	Harmonic	Test Date	May 13, 2020
Polarize	Horizontal	Test Engineer	Jerry Chang
Detector	Peak		

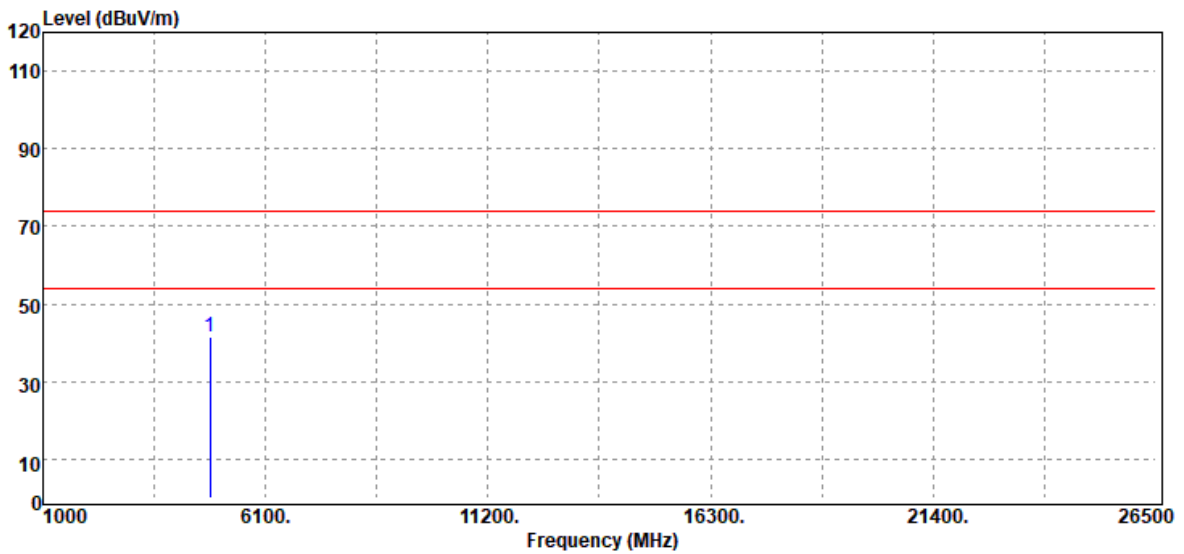

Freq. (MHz)	Detector Mode (PK/QP/AV)	Spectrum Reading Level (dBμV)	Factor (dB)	Actual FS (dBμV/m)	Limit @3m (dBμV/m)	Margin (dB)
4824.00	Peak	38.18	3.35	41.53	74.00	-32.47
N/A						

Remark:

1. Measuring frequencies from 1 GHz to the 10th harmonic of highest fundamental frequency.
2. For above 1GHz, the EUT peak value was under average limit, therefore the Average value compliance with the average limit

Report No.: T200504W06-RP3

Test Mode	IEEE 802.11g Mid CH	Temp/Hum	23.6(°C)/ 45%RH
Test Item	Harmonic	Test Date	May 13, 2020
Polarize	Vertical	Test Engineer	Jerry Chang
Detector	Peak		

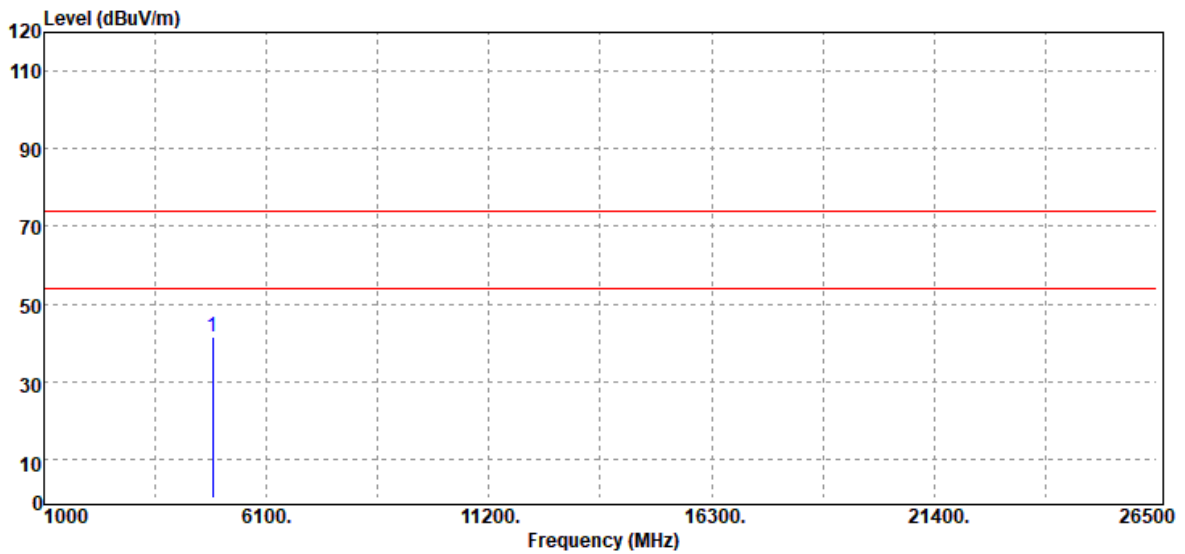

Freq. (MHz)	Detector Mode (PK/QP/AV)	Spectrum Reading Level (dBμV)	Factor (dB)	Actual FS (dBμV/m)	Limit @3m (dBμV/m)	Margin (dB)
4874.00	Peak	38.13	3.48	41.61	74.00	-32.39
N/A						

Remark:

1. Measuring frequencies from 1 GHz to the 10th harmonic of highest fundamental frequency.
2. For above 1GHz, the EUT peak value was under average limit, therefore the Average value compliance with the average limit

Report No.: T200504W06-RP3

Test Mode	IEEE 802.11g Mid CH	Temp/Hum	23.6(°C)/ 45%RH
Test Item	Harmonic	Test Date	May 13, 2020
Polarize	Horizontal	Test Engineer	Jerry Chang
Detector	Peak		

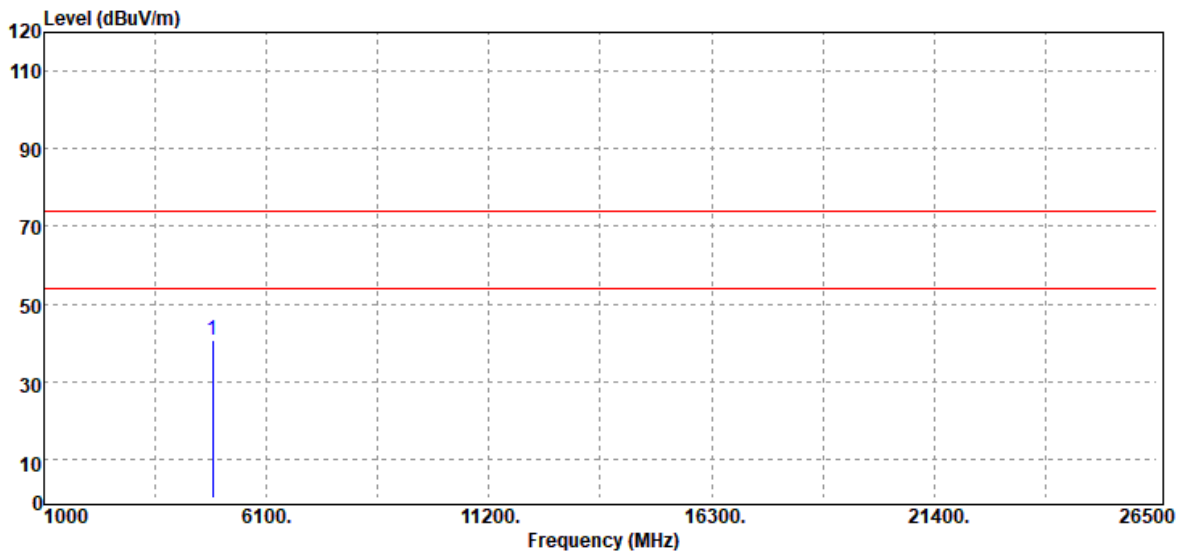

Freq. (MHz)	Detector Mode (PK/QP/AV)	Spectrum Reading Level (dB μ V)	Factor (dB)	Actual FS (dB μ V/m)	Limit @3m (dB μ V/m)	Margin (dB)
4874.00	Peak	37.33	3.48	40.81	74.00	-33.19
N/A						

Remark:

1. Measuring frequencies from 1 GHz to the 10th harmonic of highest fundamental frequency.
2. For above 1GHz, the EUT peak value was under average limit, therefore the Average value compliance with the average limit

Report No.: T200504W06-RP3

Test Mode	IEEE 802.11g High CH	Temp/Hum	23.6(°C)/ 45%RH
Test Item	Harmonic	Test Date	May 13, 2020
Polarize	Vertical	Test Engineer	Jerry Chang
Detector	Peak		

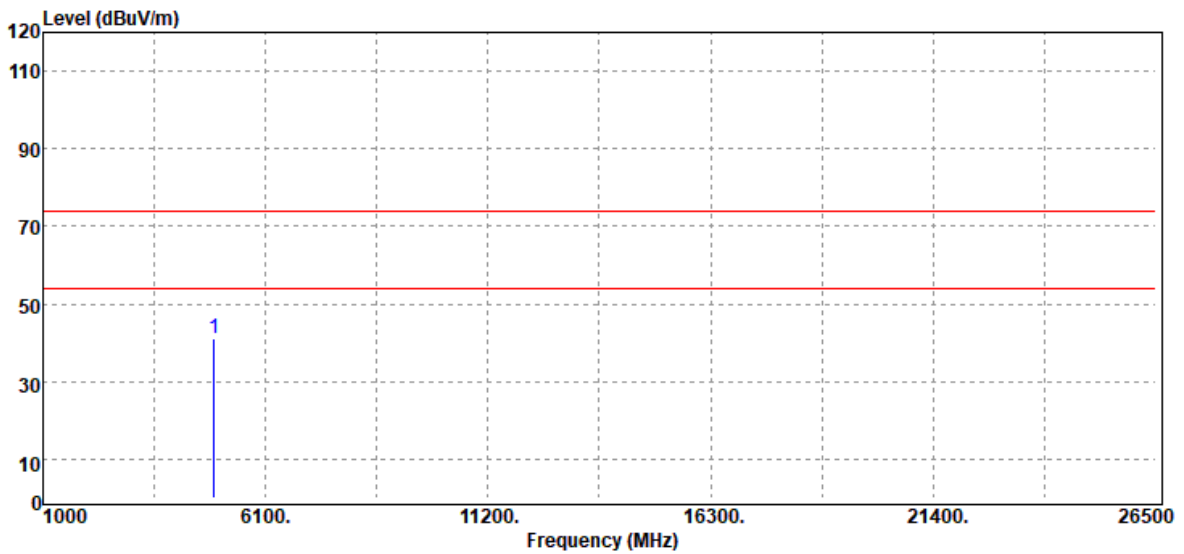

Freq. (MHz)	Detector Mode (PK/QP/AV)	Spectrum Reading Level (dBμV)	Factor (dB)	Actual FS (dBμV/m)	Limit @3m (dBμV/m)	Margin (dB)
4924.00	Peak	37.03	4.01	41.04	74.00	-32.96
N/A						

Remark:

1. Measuring frequencies from 1 GHz to the 10th harmonic of highest fundamental frequency.
2. For above 1GHz, the EUT peak value was under average limit, therefore the Average value compliance with the average limit

Report No.: T200504W06-RP3

Test Mode	IEEE 802.11g High CH	Temp/Hum	23.6(°C)/ 45%RH
Test Item	Harmonic	Test Date	May 13, 2020
Polarize	Horizontal	Test Engineer	Jerry Chang
Detector	Peak		

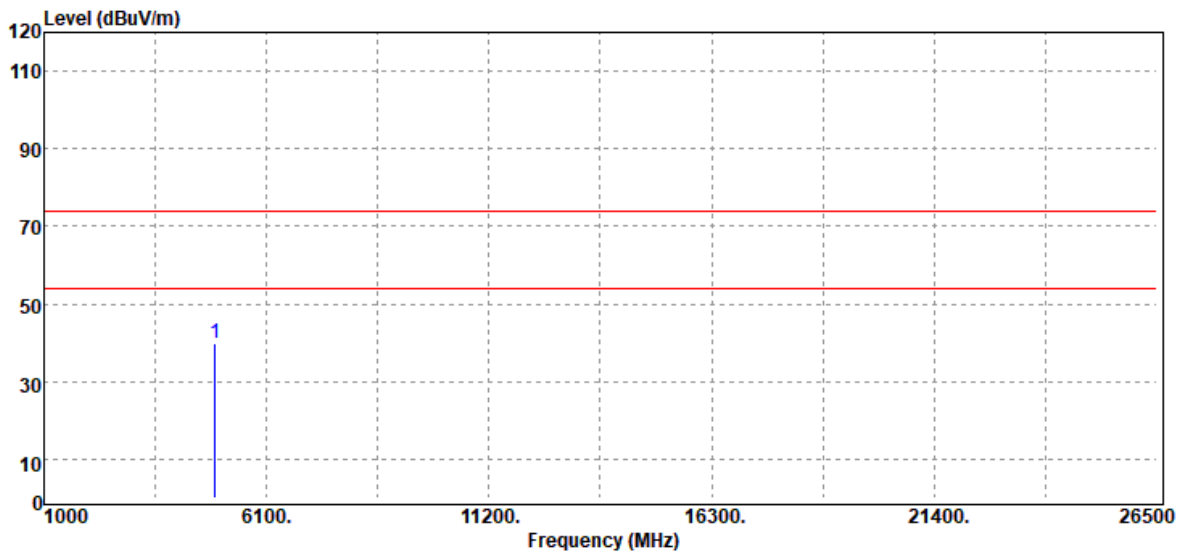

Freq. (MHz)	Detector Mode (PK/QP/AV)	Spectrum Reading Level (dBμV)	Factor (dB)	Actual FS (dBμV/m)	Limit @3m (dBμV/m)	Margin (dB)
4924.00	Peak	35.99	4.01	40.00	74.00	-34.00
N/A						

Remark:

1. Measuring frequencies from 1 GHz to the 10th harmonic of highest fundamental frequency.
2. For above 1GHz, the EUT peak value was under average limit, therefore the Average value compliance with the average limit

Report No.: T200504W06-RP3

Test Mode	IEEE 802.11n HT20 Low CH	Temp/Hum	23.6(°C)/ 45%RH
Test Item	Harmonic	Test Date	May 13, 2020
Polarize	Vertical	Test Engineer	Jerry Chang
Detector	Peak		

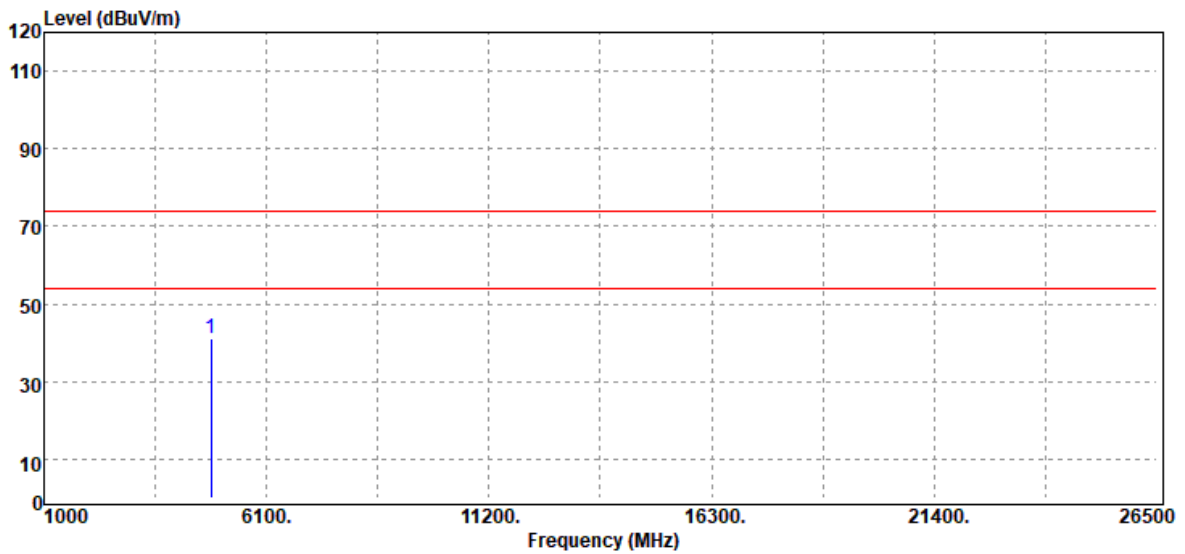

Freq. (MHz)	Detector Mode (PK/QP/AV)	Spectrum Reading Level (dBμV)	Factor (dB)	Actual FS (dBμV/m)	Limit @3m (dBμV/m)	Margin (dB)
4824.00	Peak	37.93	3.35	41.28	74.00	-32.72
N/A						

Remark:

1. Measuring frequencies from 1 GHz to the 10th harmonic of highest fundamental frequency.
2. For above 1GHz, the EUT peak value was under average limit, therefore the Average value compliance with the average limit

Report No.: T200504W06-RP3

Test Mode	IEEE 802.11n HT20 Low CH	Temp/Hum	23.6(°C)/ 45%RH
Test Item	Harmonic	Test Date	May 13, 2020
Polarize	Horizontal	Test Engineer	Jerry Chang
Detector	Peak		

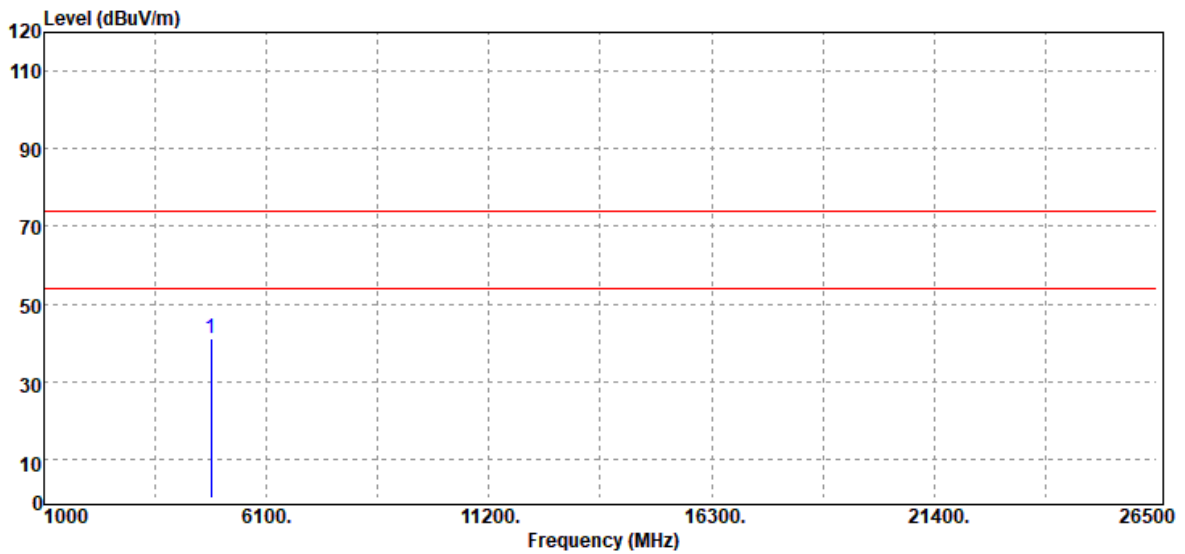

Freq. (MHz)	Detector Mode (PK/QP/AV)	Spectrum Reading Level (dB μ V)	Factor (dB)	Actual FS (dB μ V/m)	Limit @3m (dB μ V/m)	Margin (dB)
4824.00	Peak	37.75	3.35	41.10	74.00	-32.90
N/A						

Remark:

1. Measuring frequencies from 1 GHz to the 10th harmonic of highest fundamental frequency.
2. For above 1GHz, the EUT peak value was under average limit, therefore the Average value compliance with the average limit

Report No.: T200504W06-RP3

Test Mode	IEEE 802.11n HT20 Mid CH	Temp/Hum	23.6(°C)/ 45%RH
Test Item	Harmonic	Test Date	May 13, 2020
Polarize	Vertical	Test Engineer	Jerry Chang
Detector	Peak		

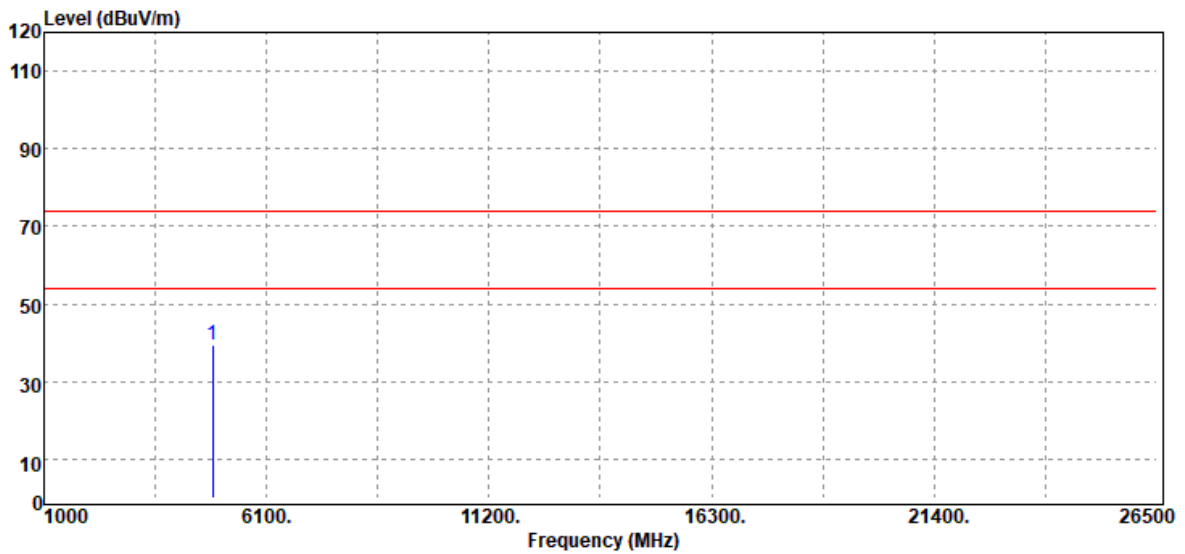

Freq. (MHz)	Detector Mode (PK/QP/AV)	Spectrum Reading Level (dBμV)	Factor (dB)	Actual FS (dBμV/m)	Limit @3m (dBμV/m)	Margin (dB)
4874.00	Peak	36.09	3.48	39.57	74.00	-34.43
N/A						

Remark:

1. Measuring frequencies from 1 GHz to the 10th harmonic of highest fundamental frequency.
2. For above 1GHz, the EUT peak value was under average limit, therefore the Average value compliance with the average limit

Report No.: T200504W06-RP3

Test Mode	IEEE 802.11n HT20 Mid CH	Temp/Hum	23.6(°C)/ 45%RH
Test Item	Harmonic	Test Date	May 13, 2020
Polarize	Horizontal	Test Engineer	Jerry Chang
Detector	Peak		

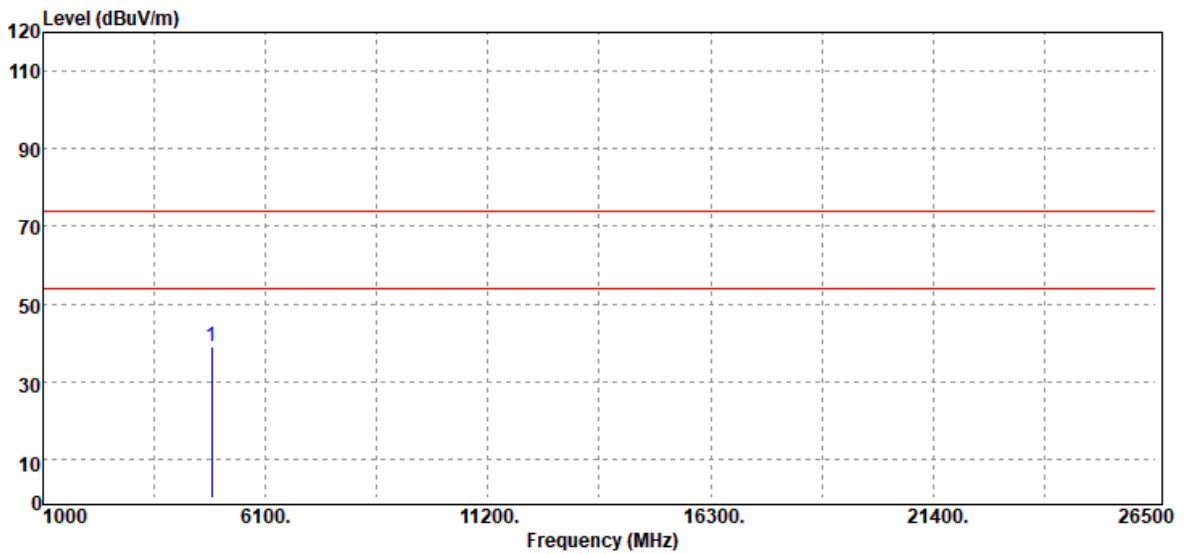

Freq. (MHz)	Detector Mode (PK/QP/AV)	Spectrum Reading Level (dB μ V)	Factor (dB)	Actual FS (dB μ V/m)	Limit @3m (dB μ V/m)	Margin (dB)
4874.00	Peak	35.41	3.48	38.89	74.00	-35.11
N/A						

Remark:

1. Measuring frequencies from 1 GHz to the 10th harmonic of highest fundamental frequency.
2. For above 1GHz, the EUT peak value was under average limit, therefore the Average value compliance with the average limit

Report No.: T200504W06-RP3

Test Mode	IEEE 802.11n HT20 High CH	Temp/Hum	23.6(°C)/ 45%RH
Test Item	Harmonic	Test Date	May 13, 2020
Polarize	Vertical	Test Engineer	Jerry Chang
Detector	Peak		

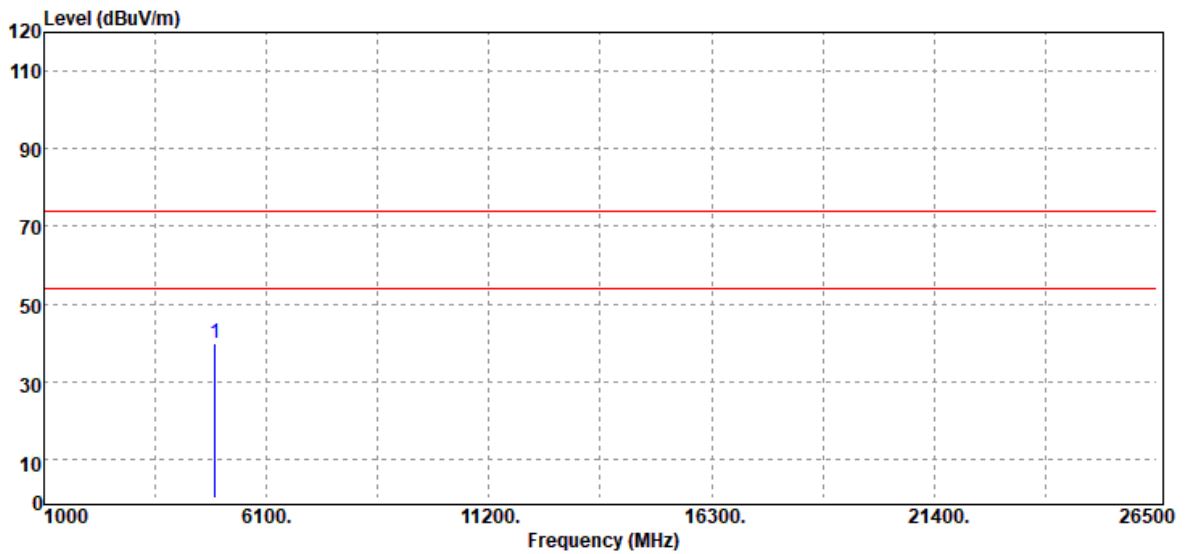

Freq. (MHz)	Detector Mode (PK/QP/AV)	Spectrum Reading Level (dBμV)	Factor (dB)	Actual FS (dBμV/m)	Limit @3m (dBμV/m)	Margin (dB)
4924.00	Peak	35.93	4.01	39.94	74.00	-34.06
N/A						

Remark:

1. Measuring frequencies from 1 GHz to the 10th harmonic of highest fundamental frequency.
2. For above 1GHz, the EUT peak value was under average limit, therefore the Average value compliance with the average limit

Report No.: T200504W06-RP3

Test Mode	IEEE 802.11n HT20 High CH	Temp/Hum	23.6(°C)/ 45%RH
Test Item	Harmonic	Test Date	May 13, 2020
Polarize	Horizontal	Test Engineer	Jerry Chang
Detector	Peak		

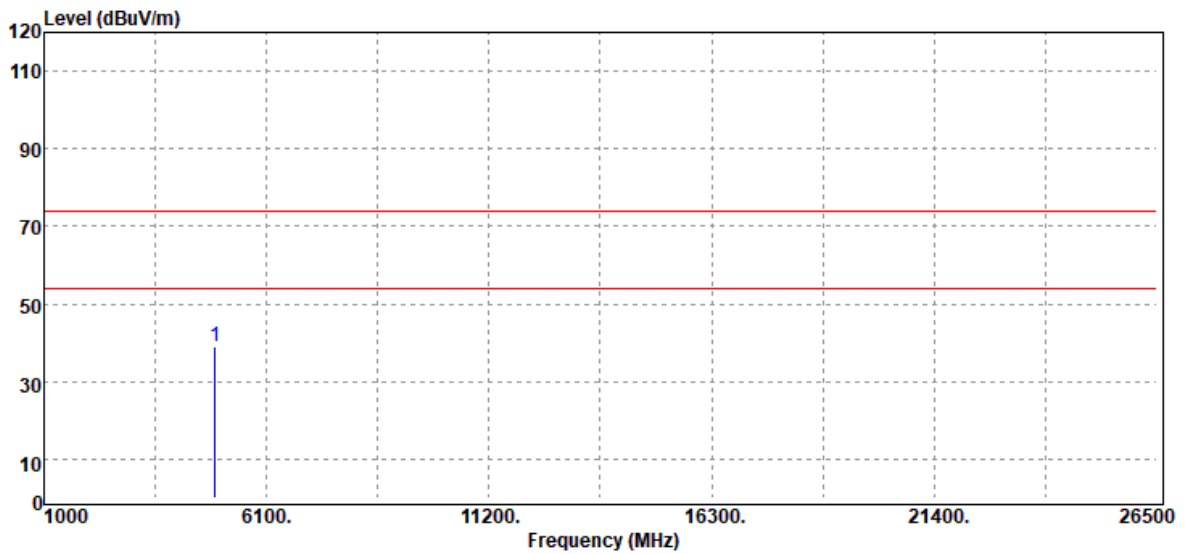

Freq. (MHz)	Detector Mode (PK/QP/AV)	Spectrum Reading Level (dBμV)	Factor (dB)	Actual FS (dBμV/m)	Limit @3m (dBμV/m)	Margin (dB)
4924.00	Peak	35.12	4.01	39.13	74.00	-34.87
N/A						

Remark:

1. Measuring frequencies from 1 GHz to the 10th harmonic of highest fundamental frequency.
2. For above 1GHz, the EUT peak value was under average limit, therefore the Average value compliance with the average limit

Report No.: T200504W06-RP3

Test Mode	IEEE 802.11n HT40 Low CH	Temp/Hum	23.6(°C)/ 45%RH
Test Item	Harmonic	Test Date	May 13, 2020
Polarize	Vertical	Test Engineer	Jerry Chang
Detector	Peak		

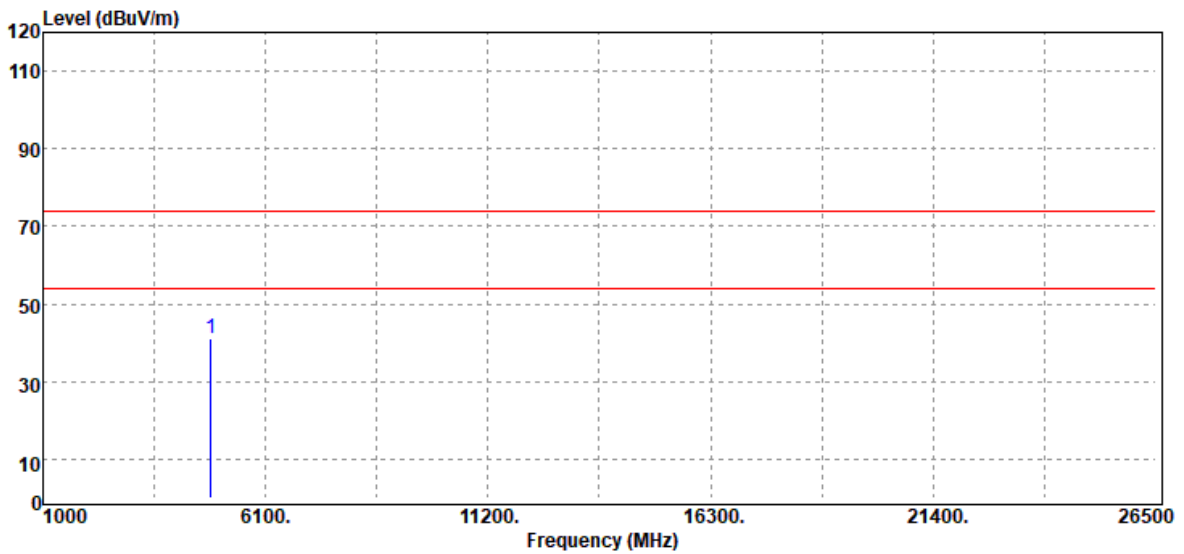

Freq. (MHz)	Detector Mode (PK/QP/AV)	Spectrum Reading Level (dB μ V)	Factor (dB)	Actual FS (dB μ V/m)	Limit @3m (dB μ V/m)	Margin (dB)
4844.00	Peak	37.68	3.35	41.03	74.00	-32.97
N/A						

Remark:

1. Measuring frequencies from 1 GHz to the 10th harmonic of highest fundamental frequency.
2. For above 1GHz, the EUT peak value was under average limit, therefore the Average value compliance with the average limit

Report No.: T200504W06-RP3

Test Mode	IEEE 802.11n HT40 Low CH	Temp/Hum	23.6(°C)/ 45%RH
Test Item	Harmonic	Test Date	May 13, 2020
Polarize	Horizontal	Test Engineer	Jerry Chang
Detector	Peak		

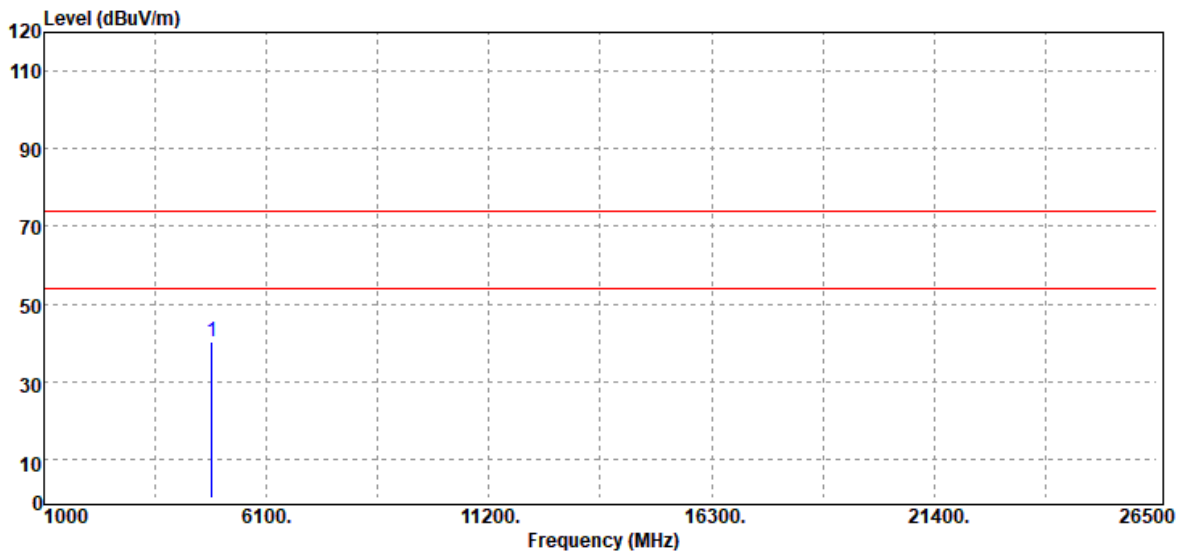

Freq. (MHz)	Detector Mode (PK/QP/AV)	Spectrum Reading Level (dB μ V)	Factor (dB)	Actual FS (dB μ V/m)	Limit @3m (dB μ V/m)	Margin (dB)
4844.00	Peak	36.81	3.35	40.16	74.00	-33.84
N/A						

Remark:

1. Measuring frequencies from 1 GHz to the 10th harmonic of highest fundamental frequency.
2. For above 1GHz, the EUT peak value was under average limit, therefore the Average value compliance with the average limit

Report No.: T200504W06-RP3

Test Mode	IEEE 802.11n HT40 Mid CH	Temp/Hum	23.6(°C)/ 45%RH
Test Item	Harmonic	Test Date	May 13, 2020
Polarize	Vertical	Test Engineer	Jerry Chang
Detector	Peak		

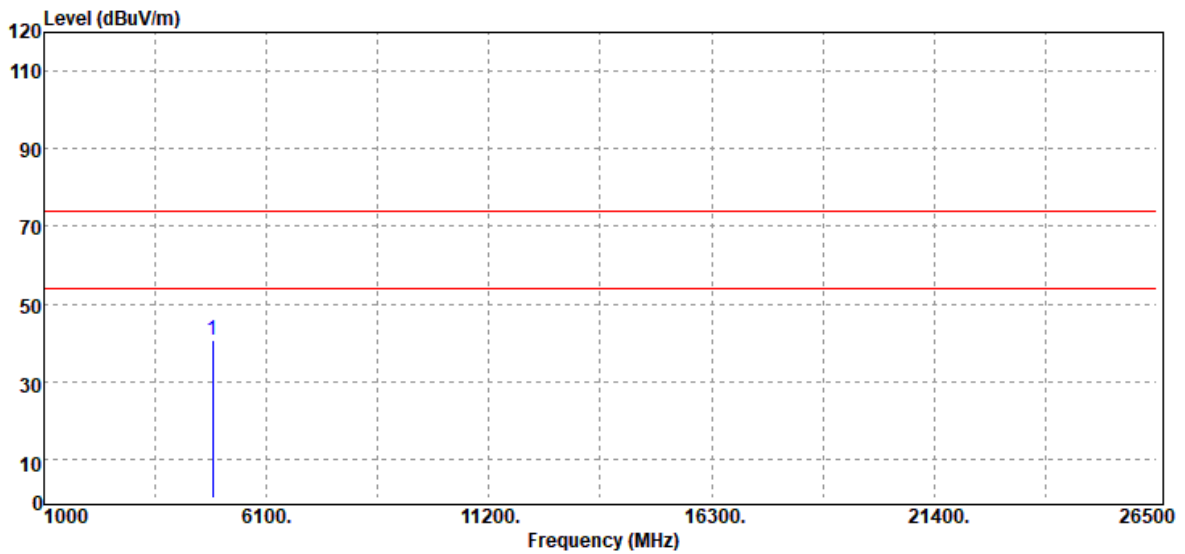

Freq. (MHz)	Detector Mode (PK/QP/AV)	Spectrum Reading Level (dB μ V)	Factor (dB)	Actual FS (dB μ V/m)	Limit @3m (dB μ V/m)	Margin (dB)
4874.00	Peak	37.38	3.48	40.86	74.00	-33.14
N/A						

Remark:

1. Measuring frequencies from 1 GHz to the 10th harmonic of highest fundamental frequency.
2. For above 1GHz, the EUT peak value was under average limit, therefore the Average value compliance with the average limit

Report No.: T200504W06-RP3

Test Mode	IEEE 802.11n HT40 Mid CH	Temp/Hum	23.6(°C)/ 45%RH
Test Item	Harmonic	Test Date	May 13, 2020
Polarize	Horizontal	Test Engineer	Jerry Chang
Detector	Peak		

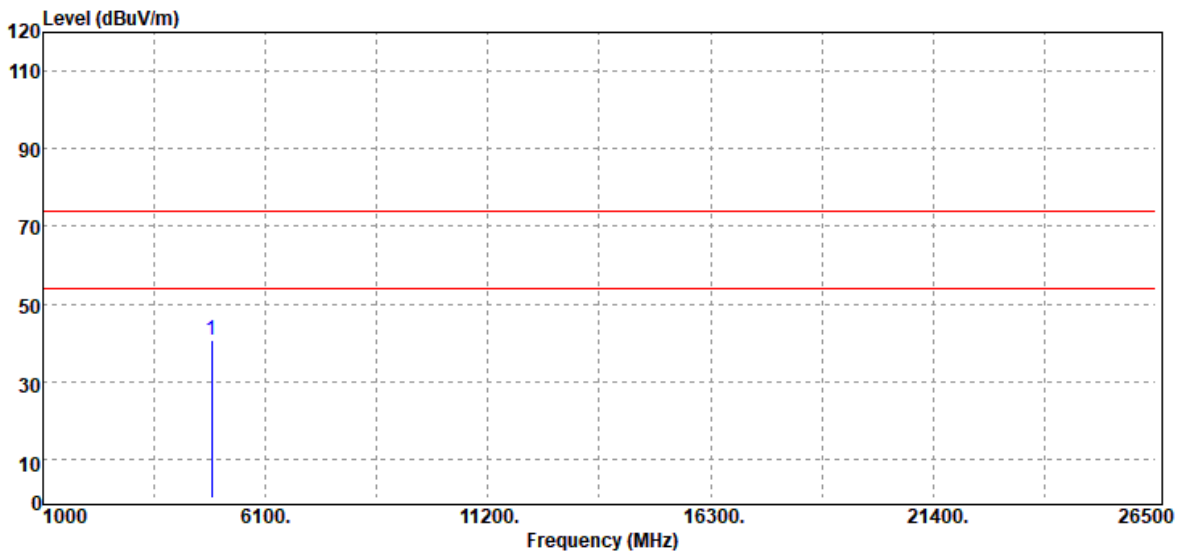

Freq. (MHz)	Detector Mode (PK/QP/AV)	Spectrum Reading Level (dBμV)	Factor (dB)	Actual FS (dBμV/m)	Limit @3m (dBμV/m)	Margin (dB)
4874.00	Peak	37.08	3.48	40.56	74.00	-33.44
N/A						

Remark:

1. Measuring frequencies from 1 GHz to the 10th harmonic of highest fundamental frequency.
2. For above 1GHz, the EUT peak value was under average limit, therefore the Average value compliance with the average limit

Report No.: T200504W06-RP3

Test Mode	IEEE 802.11n HT40 High CH	Temp/Hum	23.6(°C)/ 45%RH
Test Item	Harmonic	Test Date	May 13, 2020
Polarize	Vertical	Test Engineer	Jerry Chang
Detector	Peak		

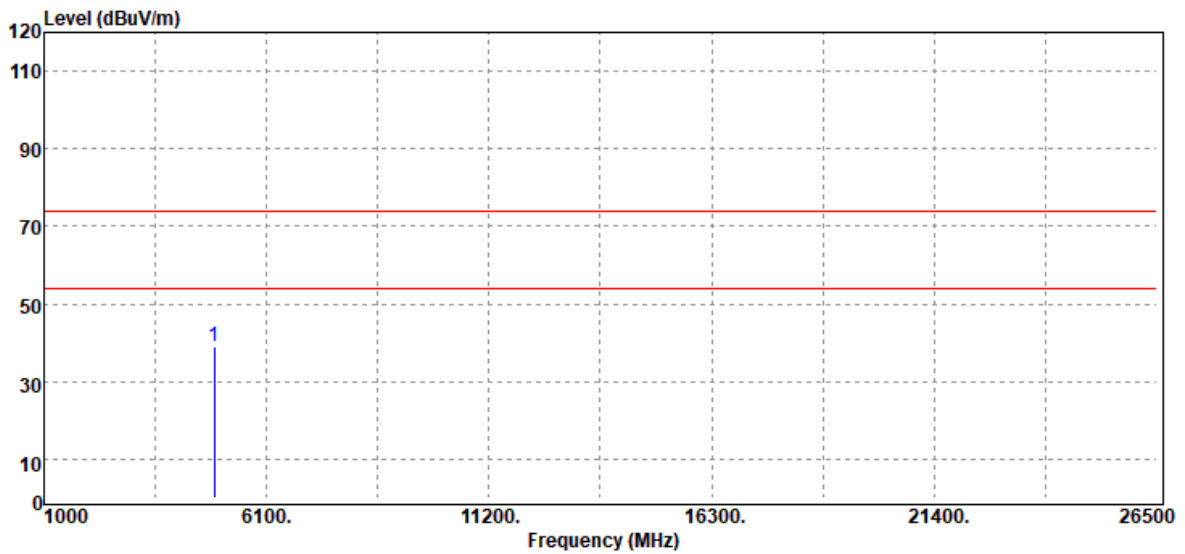

Freq. (MHz)	Detector Mode (PK/QP/AV)	Spectrum Reading Level (dB μ V)	Factor (dB)	Actual FS (dB μ V/m)	Limit @3m (dB μ V/m)	Margin (dB)
4904.00	Peak	35.33	3.69	39.02	74.00	-34.98
N/A						

Remark:

1. Measuring frequencies from 1 GHz to the 10th harmonic of highest fundamental frequency.
2. For above 1GHz, the EUT peak value was under average limit, therefore the Average value compliance with the average limit

Report No.: T200504W06-RP3

Test Mode	IEEE 802.11n HT40 High CH	Temp/Hum	23.6(°C)/ 45%RH
Test Item	Harmonic	Test Date	May 13, 2020
Polarize	Horizontal	Test Engineer	Jerry Chang
Detector	Peak		

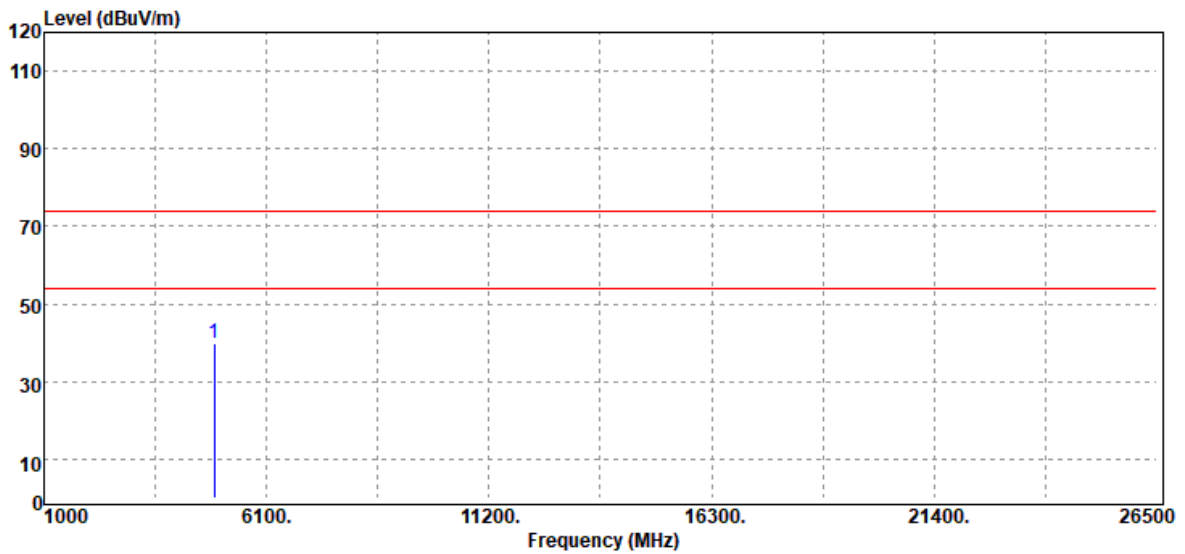

Freq. (MHz)	Detector Mode (PK/QP/AV)	Spectrum Reading Level (dBμV)	Factor (dB)	Actual FS (dBμV/m)	Limit @3m (dBμV/m)	Margin (dB)
4904.00	Peak	35.99	3.69	39.68	74.00	-34.32
N/A						

Remark:

1. Measuring frequencies from 1 GHz to the 10th harmonic of highest fundamental frequency.
2. For above 1GHz, the EUT peak value was under average limit, therefore the Average value compliance with the average limit

- End of Test Report -