

RF Exposure Lab

802 N. Twin Oaks Valley Road, Suite 105 • San Marcos, CA 92069 • U.S.A.

TEL (760) 471-2100 • FAX (760) 471-2121

<http://www.rfexposurelab.com>

CERTIFICATE OF COMPLIANCE SAR EVALUATION

Intel Mobile Communication
100 Center Point Circle, Suite 200
Columbia, SC 29210

Dates of Test: August 17-20, 2015
Test Report Number: SAR.20150810

FCC ID:	PD98260NGU (Contains Model 8260NGW & 8260NGW NB)
IC Certificate:	1000M-8260NG (Contains Model 8260NGW & 8260NGW NB)
Model(s):	Lenovo TP00078A PC
Contains WLAN Model(s):	Intel® Dual Band Wireless-AC 8260 (Model 8260NGW & 8260NGW NB)
Test Sample:	Engineering Unit Same as Production
Serial Number:	MP-07KVJ5, MP-07KV47, MP-08F114 & MP-08F100
Equipment Type:	Wireless Module Installed in Notebook/Tablet
Classification:	Portable Transmitter Next to Body
TX Frequency Range:	2412 – 2462 MHz; 5180 – 5320 MHz; 5500 – 5700 MHz; 5745 – 5825 MHz
Frequency Tolerance:	± 2.5 ppm
Maximum RF Output:	2450 MHz (b) – 17.50 dB, 2450 MHz (g) – 17.50 dB, 2450 MHz (n20) – 17.50 dB, 2450 MHz (n40) – 17.50 dB, 5250 MHz (a) – 16.00 dB, 5250 MHz (n20) – 16.00 dB, 5250 MHz (n40) – 16.00 dB, 5250 MHz (ac) – 16.00 dB, 5600 MHz (a) – 16.00 dB, 5600 MHz (n20) – 16.00 dB, 5600 MHz (n40) – 16.00 dB, 5600 MHz (ac) – 16.00 dB, 5800 MHz (a) – 16.00 dB, 5800 MHz (n20) – 16.00 dB, 5800 MHz (n40) – 16.00 dB, 5800 MHz (ac) – 16.00 dB Conducted
Signal Modulation:	DSSS, OFDM
Antenna Type:	HighTek, P/N DC33001RQ00 (Tx1) & DC33001RQ10 (Tx2) and Ethertronics, P/N 5002022 (Tx1) & 5002030 (Tx2); PIFA Antenna
Application Type:	Certification
FCC Rule Parts:	Part 2, 15C, 15E
KDB Test Methodology:	KDB 447498 D01 v05r02, KDB 248227 v02, KDB 616217 D04 v01
Industry Canada:	RSS-102 Issue 5, Safety Code 6
Maximum SAR Value:	1.20 W/kg Reported
Max. Simultaneous SAR:	0.04 W/kg Separation Ratio
Separation Distance:	6.6 mm

This wireless mobile and/or portable device has been shown to be compliant for localized specific absorption rate (SAR) for uncontrolled environment/general exposure limits specified in ANSI/IEEE Std. C95.1-1992 and had been tested in accordance with the measurement procedures specified in IEEE 1528-2013 and IEC 62209-2:2010 (See test report).

I attest to the accuracy of the data. All measurements were performed by myself or were made under my supervision and are correct to the best of my knowledge and belief. I assume full responsibility for the completeness of these measurements and vouch for the qualifications of all persons taking them.

RF Exposure Lab, LLC certifies that no party to this application is subject to a denial of Federal benefits that includes FCC benefits pursuant to Section 5301 of the Anti-Drug Abuse Act of 1988, 21 U.S.C. 853(a).



Jay M. Moulton
Vice President



Testing Cert. # 2387.01

Table of Contents

1.	Introduction	3
	SAR Definition [5].....	4
2.	SAR Measurement Setup.....	5
	Robotic System.....	5
	System Hardware.....	5
	System Electronics.....	6
	Probe Measurement System.....	6
3.	Probe and Dipole Calibration.....	14
4.	Phantom & Simulating Tissue Specifications.....	15
	Head & Body Simulating Mixture Characterization	15
5.	ANSI/IEEE C95.1 – 1992 RF Exposure Limits [2].....	16
	Uncontrolled Environment	16
	Controlled Environment.....	16
6.	Measurement Uncertainty	17
7.	System Validation.....	18
	Tissue Verification.....	18
	Test System Verification.....	18
8.	SAR Test Data Summary	19
	Procedures Used To Establish Test Signal	19
	Device Test Condition	19
	SAR Data Summary – 2450 MHz Body 802.11b & BT	72
	SAR Data Summary – 5250 MHz Body 802.11a	73
	SAR Data Summary – 5600 MHz Body 802.11a	74
	SAR Data Summary – 5800 MHz Body 802.11a	75
	SAR Data Summary – Simultaneous Evaluation	76
9.	Test Equipment List.....	77
10.	Conclusion	78
11.	References.....	79
	Appendix A – System Validation Plots and Data	80
	Appendix B – SAR Test Data Plots	90
	Appendix C – SAR Test Setup Photos	95
	Appendix D – Probe Calibration Data Sheets.....	101
	Appendix E – Dipole Calibration Data Sheets	113
	Appendix F – Phantom Calibration Data Sheets	136
	Appendix G – Validation Summary.....	138

1. Introduction

This measurement report shows compliance of the Intel Mobile Communications Model 8260NGW including sub-model(s) 8260NGW NB installed in Lenovo Model Lenovo TP00078A PC FCC ID: PD98260NGU with FCC Part 2, 1093, ET Docket 93-62 Rules for mobile and portable devices and IC Certificate: 1000M-8260NG with RSS102 Issue 5 & Safety Code 6. The FCC have adopted the guidelines for evaluating the environmental effects of radio frequency radiation in ET Docket 93-62 on August 6, 1996 to protect the public and workers from the potential hazards of RF emissions due to FCC regulated portable devices. [1], [6]

The test results recorded herein are based on a single type test of Intel Mobile Communications Model 8260NGW including sub-model(s) 8260NGW NB installed in Lenovo Model Lenovo TP00078A PC and therefore apply only to the tested sample.

The test procedures, as described in ANSI C95.1 – 1999 Standard for Safety Levels with Respect to Human Exposure to Radio Frequency Electromagnetic Fields, 3 kHz to 300 GHz [2], ANSI C95.3 – 2002 Recommended Practice for the Measurement of Potentially Hazardous Electromagnetic Fields [3], IEEE Std.1528 – 2003 Recommended Practice [4], and Industry Canada Safety Code 6 Limits of Human Exposure to Radiofrequency Electromagnetic Fields in the Frequency Range from 3kHz to 300 GHz were employed.

The following table indicates all the wireless technologies operating in the 8260NGW including sub-model(s) 8260NGW NB installed in Lenovo Model Lenovo TP00078A PC wireless modem. The table also shows the tolerance for the power level for each mode.

Band	Technology	3GPP Nominal Power dBm	Setpoint Nominal Power dBm	Tolerance dBm	Lower Tolerance dBm	Upper Tolerance dBm
WLAN – 2.4 GHz	802.11b	N/A	16	±1.5	14.5	17.5
WLAN – 2.4 GHz	802.11g/n(Ch. 6)	N/A	16	±1.5	14.5	17.5
WLAN – 5 GHz Band I, II, III, IV	802.11a	N/A	14.5	±1.5	13.0	16.0

SAR Definition [5]

Specific Absorption Rate is defined as the time derivative (rate) of the incremental energy (dW) absorbed by (dissipated in) an incremental mass (dm) contained in a volume element (dV) of a given density (ρ).

$$SAR = \frac{d}{dt} \left(\frac{dW}{dm} \right) = \frac{d}{dt} \left(\frac{dW}{\rho dV} \right)$$

SAR is expressed in units of watts per kilogram (W/kg). SAR can be related to the electric field at a point by

$$SAR = \frac{\sigma |E|^2}{\rho}$$

where:

σ = conductivity of the tissue (S/m)

ρ = mass density of the tissue (kg/m³)

E = rms electric field strength (V/m)

2. SAR Measurement Setup

Robotic System

These measurements are performed using the DASY52 automated dosimetric assessment system. The DASY52 is made by Schmid & Partner Engineering AG (SPEAG) in Zurich, Switzerland and consists of high precision robotics system (Staubli), robot controller, Intel Core2 computer, near-field probe, probe alignment sensor, and the generic twin phantom containing the brain equivalent material. The robot is a six-axis industrial robot performing precise movements to position the probe to the location (points) of maximum electromagnetic field (EMF) (see Fig. 2.1).

System Hardware

A cell controller system contains the power supply, robot controller teach pendant (Joystick), and a remote control used to drive the robot motors. The PC consists of the HP Intel Core2 computer with Windows XP system and SAR Measurement Software DASY52, A/D interface card, monitor, mouse, and keyboard. The Staubli Robot is connected to the cell controller to allow software manipulation of the robot. A data acquisition electronic (DAE) circuit that performs the signal amplification, signal multiplexing, AD-conversion, offset measurements, mechanical surface detection, collision detection, etc. is connected to the Electro-optical coupler (EOC). The EOC performs the conversion from the optical into digital electric signal of the DAE and transfers data to the PC plug-in card.

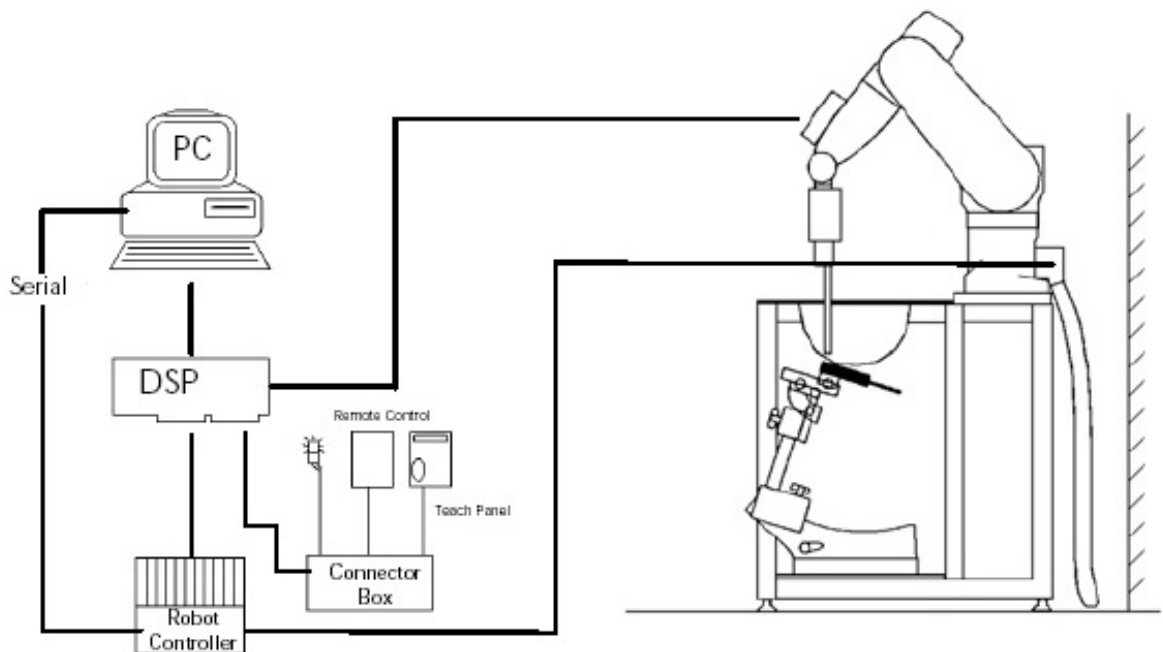

Figure 2.1 SAR Measurement System Setup

System Electronics

The DAE4 consists of a highly sensitive electrometer-grade preamplifier with auto-zeroing, a channel and gain-switching multiplexer, a fast 16 bit AD-converter and a command decoder and control logic unit. Transmission to the PC-card is accomplished through an optical downlink for data and status information and an optical uplink for commands and clock lines. The mechanical probe mounting device includes two different sensor systems for frontal and sidewise probe contacts. They are also used for mechanical surface detection and probe collision detection. The robot uses its own controller with a built in VME-bus computer. The system is described in detail in.

Probe Measurement System

The SAR measurements were conducted with the dosimetric probe EX3DV4, designed in the classical triangular configuration (see Fig. 2.2) and optimized for dosimetric evaluation. The probe is constructed using the thick film technique; with printed resistive lines on ceramic substrates. The probe is equipped with an optical multi fiber line ending at the front of the probe tip. (see Fig. 2.3) It is connected to the EOC box on the robot arm and provides an automatic detection of the phantom surface. Half of the fibers are connected to a pulsed infrared transmitter, the other half to a synchronized receiver. As the probe approaches the surface, the reflection from the surface produces a coupling from the transmitting to the receiving fibers. This reflection increases first during the approach, reaches maximum and then decreases. If the probe is flatly touching the surface, the coupling is zero. The distance of the coupling maximum to the surface is independent of the surface reflectivity and largely independent of the surface to probe angle. The DASY52 software reads the reflection during a software approach and looks for the maximum using a 2nd order fitting. The approach is stopped at reaching the maximum.



DAE System

Probe Specifications

Calibration: In air from 10 MHz to 6.0 GHz
In brain and muscle simulating tissue at Frequencies of 450 MHz, 835 MHz, 1750 MHz, 1900 MHz, 2450 MHz, 2600 MHz, 3500 MHz, 5200 MHz, 5300 MHz, 5600 MHz, 5800 MHz

Frequency: 10 MHz to 6 GHz

Linearity: ± 0.2 dB (30 MHz to 6 GHz)

Dynamic: 10 mW/kg to 100 W/kg

Range: Linearity: ± 0.2 dB

Dimensions: Overall length: 330 mm

Tip length: 20 mm

Body diameter: 12 mm

Tip diameter: 2.5 mm

Distance from probe tip to sensor center: 1 mm

Application: SAR Dosimetry Testing
Compliance tests of wireless device



Figure 2.2 Triangular Probe Configurations



Figure 2.3 Probe Thick-Film Technique

Probe Calibration Process

Dosimetric Assessment Procedure

Each probe is calibrated according to a dosimetric assessment procedure described in with accuracy better than +/- 10%. The spherical isotropy was evaluated with the procedure described in and found to be better than +/-0.25dB. The sensitivity parameters (Norm X, Norm Y, Norm Z), the diode compression parameter (DCP) and the conversion factor (Conv F) of the probe is tested.

Free Space Assessment

The free space E-field from amplified probe outputs is determined in a test chamber. This is performed in a TEM cell for frequencies below 1 GHz, and in a waveguide above 1GHz for free space. For the free space calibration, the probe is placed in the volumetric center of the cavity at the proper orientation with the field. The probe is then rotated 360 degrees until the three channels show the maximum reading. The power density readings equates to 1 mW/cm².

Temperature Assessment *

E-field temperature correlation calibration is performed in a flat phantom filled with the appropriate simulated brain tissue. The measured free space E-field in the medium, correlates to temperature rise in a dielectric medium. For temperature correlation calibration a RF transparent thermistor based temperature probe is used in conjunction with the E-field probe

$$SAR = C \frac{\Delta T}{\Delta t}$$

$$SAR = \frac{|E|^2 \cdot \sigma}{\rho}$$

where:

where:

Δt = exposure time (30 seconds),

σ = simulated tissue conductivity,

C = heat capacity of tissue (brain or muscle),

ρ = Tissue density (1.25 g/cm³ for brain tissue)

ΔT = temperature increase due to RF exposure.

SAR is proportional to $\Delta T / \Delta t$, the initial rate of tissue heating, before thermal diffusion takes place.

Now it's possible to quantify the electric field in the simulated tissue by equating the thermally derived SAR to the E- field;



Figure 2.4 E-Field and Temperature Measurements at 900MHz

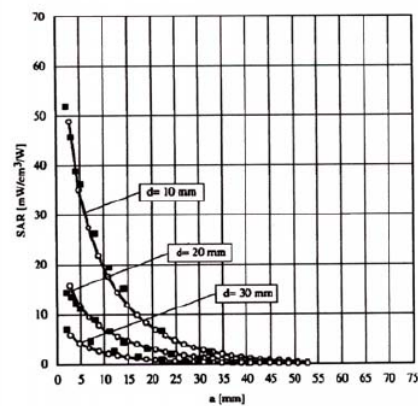

Figure 2.5 E-Field and Temperature Measurements at 1800MHz

Data Extrapolation

The DASY52 software automatically executes the following procedures to calculate the field units from the microvolt readings at the probe connector. The first step of the evaluation is a linearization of the filtered input signal to account for the compression characteristics of the detector diode. The compensation depends on the input signal, the diode type and the DC-transmission factor from the diode to the evaluation electronics. If the exciting field is pulsed, the crest factor of the signal must be known to correctly compensate for peak power. The formula for each channel can be given like below;

$$V_i = U_i + U_i^2 \cdot \frac{cf}{dcp_i}$$

with V_i = compensated signal of channel i (i=x,y,z)
 U_i = input signal of channel i (i=x,y,z)
 cf = crest factor of exciting field (DASY parameter)
 dcp_i = diode compression point (DASY parameter)

From the compensated input signals the primary field data for each channel can be evaluated:

E-field probes:

$$E_i = \sqrt{\frac{V_i}{Norm_i \cdot ConvF}}$$

with V_i = compensated signal of channel i (i = x,y,z)
 $Norm_i$ = sensor sensitivity of channel i (i = x,y,z)
 $\mu V/(V/m)^2$ for E-field probes
 $ConvF$ = sensitivity of enhancement in solution
 E_i = electric field strength of channel i in V/m

The RSS value of the field components gives the total field strength (Hermetian magnitude):

$$E_{tot} = \sqrt{E_x^2 + E_y^2 + E_z^2}$$

The primary field data are used to calculate the derived field units.

$$SAR = E_{tot}^2 \cdot \frac{\sigma}{\rho \cdot 1000}$$

with SAR = local specific absorption rate in W/g
 E_{tot} = total field strength in V/m
 σ = conductivity in [mho/m] or [Siemens/m]
 ρ = equivalent tissue density in g/cm³

The power flow density is calculated assuming the excitation field to be a free space field.

$$P_{free} = \frac{E_{tot}^2}{3770}$$

with P_{pwe} = equivalent power density of a plane wave in W/cm²
 E_{tot} = total electric field strength in V/m

Scanning procedure

- The DASY installation includes predefined files with recommended procedures for measurements and system check. They are read-only document files and destined as fully defined but unmeasured masks. All test positions (head or body-worn) are tested with the same configuration of test steps differing only in the grid definition for the different test positions.
- The „reference“ and „drift“ measurements are located at the beginning and end of the batch process. They measure the field drift at one single point in the liquid over the complete procedure. The indicated drift is mainly the variation of the DUT's output power and should vary max. +/- 5 %.
- The highest integrated SAR value is the main concern in compliance test applications. These values can mostly be found at the inner surface of the phantom and cannot be measured directly due to the sensor offset in the probe. To extrapolate the surface values, the measurement distances to the surface must be known accurately. A distance error of 0.5mm could produce SAR errors of 6% at 1800 MHz. Using predefined locations for measurements is not accurate enough. Any shift of the phantom (e.g., slight deformations after filling it with liquid) would produce high uncertainties. For an automatic and accurate detection of the phantom surface, the DASY5 system uses the mechanical surface detection. The detection is always at touch, but the probe will move backward from the surface the indicated distance before starting the measurement.
- The „area scan“ measures the SAR above the DUT or verification dipole on a parallel plane to the surface. It is used to locate the approximate location of the peak SAR with 2D spline interpolation. The robot performs a stepped movement along one grid axis while the local electrical field strength is measured by the probe. The probe is touching the surface of the SAM during acquisition of measurement values. The scan uses different grid spacings for different frequency measurements. Standard grid spacing for head measurements in frequency ranges ≤ 2 GHz is 15 mm in x - and y- dimension. For higher frequencies a finer resolution is needed, thus for the grid spacing is reduced according the following table:

Area scan grid spacing for different frequency ranges	
Frequency range	Grid spacing
≤ 2 GHz	≤ 15 mm
2 – 4 GHz	≤ 12 mm
4 – 6 GHz	≤ 10 mm

Grid spacing and orientation have no influence on the SAR result. For special applications where the standard scan method does not find the peak SAR within the grid, e.g. mobile phones with flip cover, the grid can be adapted in orientation. Results of this coarse scan are shown in annex B.

- A „zoom scan“ measures the field in a volume around the 2D peak SAR value acquired in the previous „coarse“ scan. It uses a fine meshed grid where the robot moves the probe in steps along all the 3 axis (x,y and z-axis) starting at the bottom of the Phantom. The grid spacing for the cube measurement is varied according to the measured frequency range, the dimensions are given in the following table:

Zoom scan grid spacing and volume for different frequency ranges			
Frequency range	Grid spacing for x, y axis	Grid spacing for z axis	Minimum zoom scan volume
≤ 2 GHz	≤ 8 mm	≤ 5 mm	≥ 30 mm
2 – 3 GHz	≤ 5 mm	≤ 5 mm	≥ 28 mm
3 – 4 GHz	≤ 5 mm	≤ 4 mm	≥ 28 mm
4 – 5 GHz	≤ 4 mm	≤ 3 mm	≥ 25 mm
5 – 6 GHz	≤ 4 mm	≤ 2 mm	≥ 22 mm

DASY is also able to perform repeated zoom scans if more than 1 peak is found during area scan. In this document, the evaluated peak 1g and 10g averaged SAR values are shown in the 2D-graphics in annex B. Test results relevant for the specified standard (see section 3) are shown in table form in section 7.

Spatial Peak SAR Evaluation

The spatial peak SAR - value for 1 and 10 g is evaluated after the Cube measurements have been done. The basis of the evaluation are the SAR values measured at the points of the fine cube grid consisting of all points in the three directions x, y and z. The algorithm that finds the maximal averaged volume is separated into three different stages.

- The data between the dipole center of the probe and the surface of the phantom are extrapolated. This data cannot be measured since the center of the dipole is 1 to 2.7 mm away from the tip of the probe and the distance between the surface and the lowest measuring point is about 1 mm (see probe calibration sheet). The extrapolated data from a cube measurement can be visualized by selecting 'Graph Evaluated'.
- The maximum interpolated value is searched with a straight-forward algorithm. Around this maximum the SAR - values averaged over the spatial volumes (1g or 10 g) are computed using the 3d-spline interpolation algorithm. If the volume cannot be evaluated (i.e., if a part of the grid was cut off by the boundary of the measurement area) the evaluation will be started on the corners of the bottom plane of the cube.
- All neighboring volumes are evaluated until no neighboring volume with a higher average value is found.

Extrapolation

The extrapolation is based on a least square algorithm [W. Gander, Computermathematik, p.168-180]. Through the points in the first 3 cm along the z-axis, polynomials of order four are calculated. These polynomials are then used to evaluate the points between the surface and the probe tip. The points, calculated from the surface, have a distance of 1 mm from each other.

Interpolation

The interpolation of the points is done with a 3d-Spline. The 3d-Spline is composed of three one-dimensional splines with the "Not a knot"-condition [W. Gander, Computermathematik, p.141-150] (x, y and z -direction) [Numerical Recipes in C, Second Edition, p.123ff].

Volume Averaging

At First the size of the cube is calculated. Then the volume is integrated with the trapezoidal algorithm. 8000 points (20x20x20) are interpolated to calculate the average.

Advanced Extrapolation

DASY uses the advanced extrapolation option which is able to compensate boundary effects on E-field probes.

SAM PHANTOM

The SAM Twin Phantom V4.0 is constructed of a fiberglass shell integrated in a wooden table. The shape of the shell is based on data from an anatomical study designed to determine the maximum exposure in at least 90% of all users. It enables the dosimetric evaluation of left and right hand phone usage as well as body mounted usage at the flat phantom region. A cover prevents the evaporation of the liquid. Reference markings on the Phantom allow the complete setup of all predefined phantom positions and measurement grids by manually teaching three points in the robot. (see Fig. 2.6)

Phantom Specification

Phantom: SAM Twin Phantom (V4.0)
Shell Material: Vivac Composite
Thickness: 2.0 ± 0.2 mm

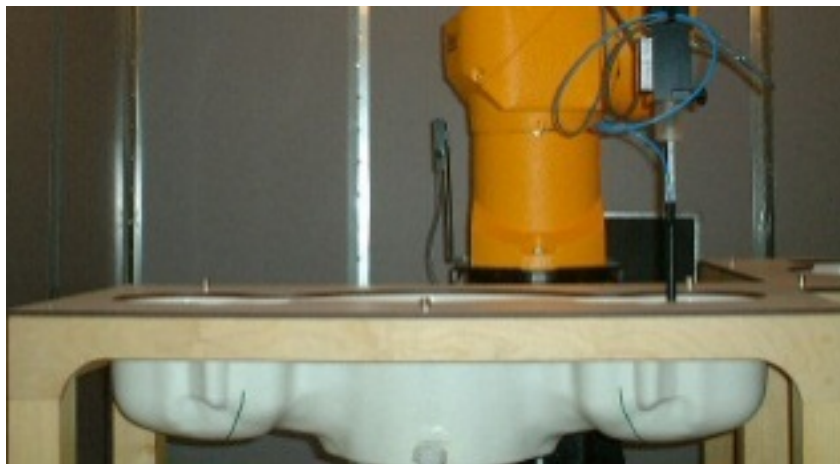

Figure 2.6 SAM Twin Phantom

Device Holder for Transmitters

In combination with the SAM Twin Phantom V4.0 the Mounting Device (see Fig. 2.7), enables the rotation of the mounted transmitter in spherical coordinates whereby the rotation point is the ear opening. The devices can be easily, accurately, and repeatedly positioned according to the FCC, CENELEC, IEC and IEEE specifications. The device holder can be locked at different phantom locations (left head, right head, flat phantom).



Figure 2.7 Mounting Device

Note: A simulating human hand is not used due to the complex anatomical and geometrical structure of the hand that may produce infinite number of configurations. To produce the worst-case condition (the hand absorbs antenna output power), the hand is omitted during the tests.

3. Probe and Dipole Calibration

See Appendix D and E.

4. Phantom & Simulating Tissue Specifications

Head & Body Simulating Mixture Characterization

The head and body mixtures consist of the material based on the table listed below. The mixture is calibrated to obtain proper dielectric constant (permittivity) and conductivity of the desired tissue. Body tissue parameters that have not been specified in IEEE1528-2013 are derived from the issue dielectric parameters computed from the 4-Cole-Cole equations.

Table 4.1 Typical Composition of Ingredients for Tissue

Ingredients	Simulating Tissue				
	2450 MHz Body	5250 MHz Body	5600 MHz Body	5785 MHz Body	
Mixing Percentage					
Water	73.20	Proprietary Mixture Procured from Speag			
Sugar	0.00				
Salt	0.04				
HEC	0.00				
Bactericide	0.00				
DGBE	26.70				
Dielectric Constant	Target	52.70	48.96	48.47	48.25
Conductivity (S/m)	Target	1.95	5.35	5.77	5.96

5. ANSI/IEEE C95.1 – 1992 RF Exposure Limits [2]

Uncontrolled Environment

Uncontrolled Environments are defined as locations where there is the exposure of individuals who have no knowledge or control of their exposure. The general population/uncontrolled exposure limits are applicable to situations in which the general public may be exposed or in which persons who are exposed as a consequence of their employment may not be made fully aware of the potential for exposure or cannot exercise control over their exposure. Members of the general public would come under this category when exposure is not employment-related; for example, in the case of a wireless transmitter that exposes persons in its vicinity.

Controlled Environment

Controlled Environments are defined as locations where there is exposure that may be incurred by persons who are aware of the potential for exposure, (i.e. as a result of employment or occupation). In general, occupational/controlled exposure limits are applicable to situations in which persons are exposed as a consequence of their employment, who have been made fully aware of the potential for exposure and can exercise control over their exposure. This exposure category is also applicable when the exposure is of a transient nature due to incidental passage through a location where the exposure levels may be higher than the general population/uncontrolled limits, but the exposed person is fully aware of the potential for exposure and can exercise control over his or her exposure by leaving the area or by some other appropriate means.

Table 5.1 Human Exposure Limits

	UNCONTROLLED ENVIRONMENT General Population (W/kg) or (mW/g)	CONTROLLED ENVIROMENT Professional Population (W/kg) or (mW/g)
SPATIAL PEAK SAR ¹ Head	1.60	8.00
SPATIAL AVERAGE SAR ² Whole Body	0.08	0.40
SPATIAL PEAK SAR ³ Hands, Feet, Ankles, Wrists	4.00	20.00

¹ The Spatial Peak value of the SAR averaged over any 1 gram of tissue (defined as a tissue volume in the shape of a cube) and over the appropriate averaging time.

² The Spatial Average value of the SAR averaged over the whole body.

³ The Spatial Peak value of the SAR averaged over any 10 grams of tissue (defined as a tissue volume in the shape of a cube) and over the appropriate averaging time.

6. Measurement Uncertainty

Measurement uncertainty table is not required per KDB 865664 D01 v01 section 2.8.2 page 12. SAR measurement uncertainty analysis is required in the SAR report only when the highest measured SAR in a frequency band is ≥ 1.5 W/kg for 1-g SAR. The equivalent ratio (1.5/1.6) should be applied to extremity and occupational exposure conditions. The highest reported value is less than 1.5 W/kg. Therefore, the measurement uncertainty table is not required.

7. System Validation

Tissue Verification

Table 7.1 Measured Tissue Parameters

		2450 MHz Body		5200 MHz Body	
Date(s)		Aug. 20, 2015		Aug. 17, 2015	
Liquid Temperature (°C)	20.0	Target	Measured	Target	Measured
Dielectric Constant: ϵ		52.70	52.53	49.01	48.94
Conductivity: σ		1.95	1.96	5.30	5.31
		5600 MHz Body		5800 MHz Body	
Date(s)		Aug. 17, 2015		Aug. 17, 2015	
Liquid Temperature (°C)	20.0	Target	Measured	Target	Measured
Dielectric Constant: ϵ		48.47	48.38	48.20	48.10
Conductivity: σ		5.77	5.78	6.00	6.01

See Appendix A for data printout.

Test System Verification

Prior to assessment, the system is verified to the $\pm 10\%$ of the specifications at the test frequency by using the system kit. Power is normalized to 1 watt. (Graphic Plots Attached)

Table 7.2 System Dipole Validation Target & Measured

	Test Frequency	Targeted SAR _{1g} (W/kg)	Measure SAR _{1g} (W/kg)	Tissue Used for Verification	Deviation Target and Fast SAR to SAR (%)	Plot Number
20-Aug-2015	2450 MHz	51.50	52.20	Body	+ 1.36	1
17-Aug-2015	5200 MHz	73.40	73.90	Body	+ 0.68	2
17-Aug-2015	5600 MHz	79.10	79.80	Body	+ 0.88	3
17-Aug-2015	5800 MHz	72.90	72.40	Body	- 0.69	4

See Appendix A for data plots.5

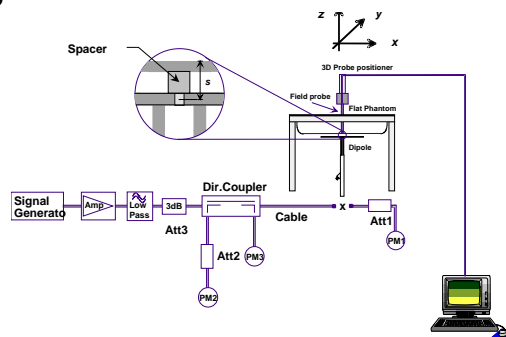

Figure 7.1 Dipole Validation Test Setup

8. SAR Test Data Summary

See Measurement Result Data Pages

See Appendix B for SAR Test Data Plots.
See Appendix C for SAR Test Setup Photos.

Procedures Used To Establish Test Signal

The device was either placed into simulated transmit mode using the manufacturer's test codes or the actual transmission is activated through a base station simulator or similar equipment. See data pages for actual procedure used in measurement.

Device Test Condition

In order to verify that the device was tested at full power, conducted output power measurements were performed before and after each SAR measurement to confirm the output power unless otherwise noted. If a conducted power deviation of more than 5% occurred, the test was repeated. The power drift of each test is measured at the start of the test and again at the end of the test. The drift percentage is calculated by the formula $((\text{end}/\text{start})-1)*100$ and rounded to three decimal places. The drift percentage is calculated into the resultant SAR value on the data sheet for each test.

The EUT was tested in the tablet configuration of the device. The EUT was tested in on all sides of the device where the antenna was within 25 mm of that side. All measurements for the tablet condition were conducted with the side of the device in direct contact with the phantom. For sides of the antenna which were not measured in this report, the SAR was conducted on the module in the modular approval with the maximum distance of 8 mm on all six sides of the antenna. Therefore, the requirements mentioned in RSS-102 Supplementary Procedures (SPR)-001 – SAR Testing Requirements with Regards to Bystanders for Laptop Type Computers with Antennas Built-In on Display Screen (Laptop/Tablet Mode) are covered.

The Bluetooth transmitter does simultaneously transmit with the WiFi transmitter. When the BT is turned on, it transmits on Main and the WiFi transmits on Aux. Simultaneous transmission is evaluated on page 76.

The main antenna was evaluated for stand-alone SAR per RSS-102 Issue 5 for BT. Please see data sheet summary on page 72.

The data rates used when evaluating the WiFi transmitter were the lowest data rates for each mode. The device was operating at its maximum output power at the lowest data rate for all measurements.

The tablet was using the Intel test utility DRTU Version 1.8.1-01336 and the device driver was version 18.10.0.19.

The antenna was on a minimum of 10 cm of Styrofoam during each test. The following is a pictorial drawing of the locations and separation distances.

Location and Separation Distances Laptop Mode Diagrams

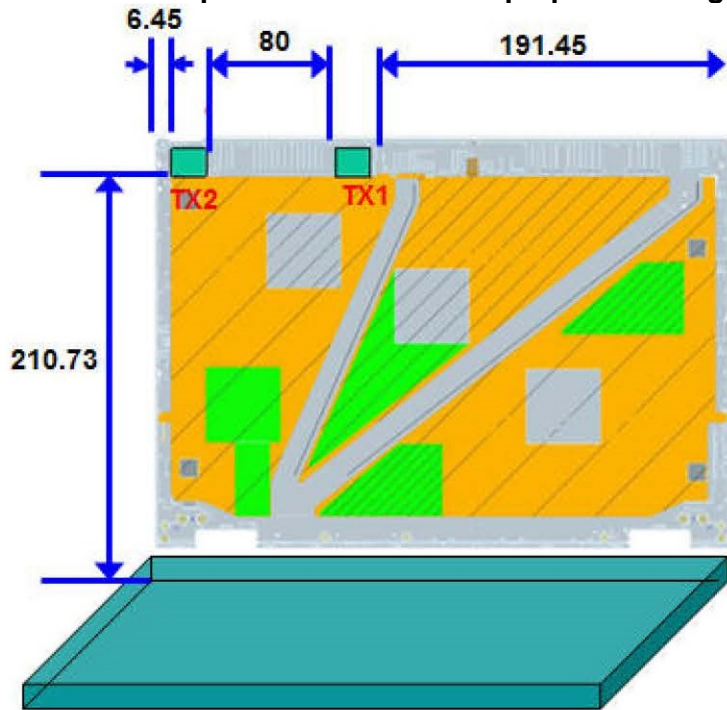

Location and Separation Distances Tablet Mode Diagrams

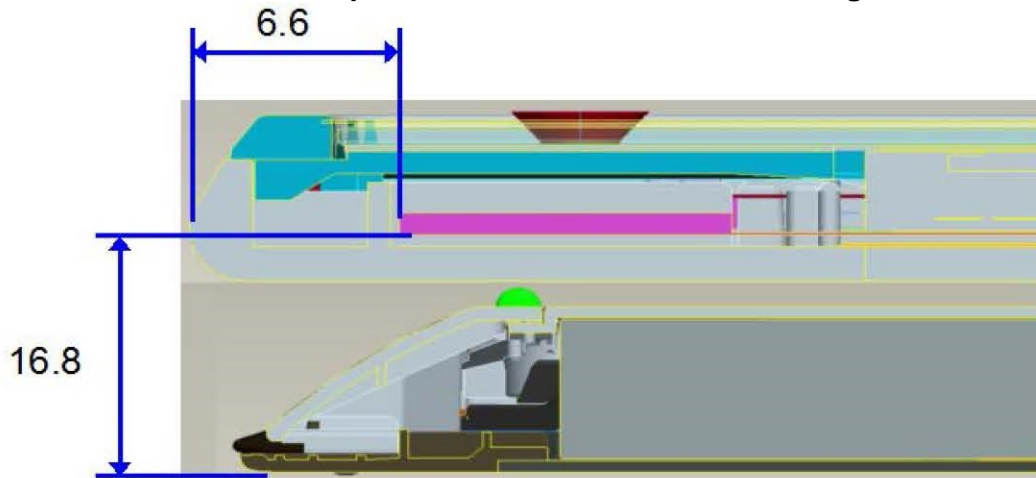

Band	Mode	Bandwidth (MHz)	Channel	Frequency (MHz)	Data Rate	Antenna	Power (dBm)
2450 MHz	802.11b	20	1	2412	1 Mbps	Chain A	17.41
			6	2437			17.50
			11	2462			17.46
			1	2412		Chain B	17.45
			6	2437			17.48
			11	2462			17.36
	802.11g	20	1	2412	6 Mbps	Chain A	17.43
			6	2437			17.48
			11	2462			17.46
			1	2412		Chain B	17.45
			6	2437			17.49
			11	2462			17.42
	802.11n	20	1	2412	HT4	Chain A	17.40
			6	2437			17.47
			11	2462			17.39
			1	2412		Chain B	17.41
6			2437	17.42			
11			2462	17.46			
802.11n	40	3	2422	HT4	Chain A	17.42	
		6	2437			17.45	
		9	2452			17.48	
		3	2422		Chain B	17.41	
		6	2437			17.46	
		9	2452			17.47	
5.15-5.25 GHz	802.11a	20	36	5180	6 Mbps	Chain A	15.92
			40	5200			15.97
			44	5220			16.00
			48	5240			15.96
			36	5180		Chain B	15.96
			40	5200			15.92
			44	5220			16.00
			48	5240			15.99
	802.11n	20	36	5180	HT4	Chain A	15.89
			40	5200			15.93
			44	5220			15.96
			48	5240			15.92
			36	5180		Chain B	15.88
			40	5200			15.85
			44	5220			15.93
			48	5240			15.90
802.11n	40	38	5190	HT4	Chain A	15.86	
		46	5230		Chain A	15.89	
		38	5190	HT4	Chain B	15.85	
		46	5230		Chain B	15.88	
802.11ac	80	42	5210	VHT6	Chain A	15.87	
					Chain B	15.84	
5.25-5.35 GHz	802.11a	20	52	5260	6 Mbps	Chain A	15.98
			56	5280			15.96
			60	5300			16.00
			64	5320			15.86
			52	5260		Chain B	15.94
			56	5280			15.95
			60	5300			16.00
			64	5320			15.92
	802.11n	20	52	5260	HT4	Chain A	15.91
			56	5280			15.87
			60	5300			15.89
			64	5320			15.83
			52	5260		Chain B	15.91
			56	5280			15.88
			60	5300			15.96
			64	5320			15.90
802.11n	40	54	5270	HT4	Chain A	15.92	
		62	5310		Chain A	15.89	
		54	5270	HT4	Chain B	15.85	
		62	5310		Chain B	15.87	
802.11ac	80	58	5290	VHT6	Chain A	15.91	
					Chain B	15.85	

Band	Mode	Bandwidth (MHz)	Channel	Frequency (MHz)	Data Rate	Antenna	Power (dBm)	
5600 MHz	802.11a	20	100	5500	6 Mbps	Chain A	15.96	
			104	5520			15.89	
			108	5540			15.92	
			112	5560			15.91	
			116	5580			16.00	
			120	5600			15.94	
			124	5620			16.00	
			128	5640		15.92		
			132	5660		16.00		
			136	5680		15.93		
			140	5700		15.90		
			100	5500		15.94		
			104	5520		15.92		
			108	5540		15.90		
	112	5560	16.00					
	116	5580	15.95					
	120	5600	15.89					
	124	5620	16.00					
	128	5640	15.92					
	132	5660	16.00					
	136	5680	15.91					
	140	5700	15.94					
	802.11n	20	20	100	5500	HT4	Chain A	15.95
				104	5520			15.90
				108	5540			15.89
				112	5560			15.87
				116	5580			15.88
				120	5600			15.90
				124	5620			15.94
				128	5640		15.85	
				132	5660		15.82	
				136	5680		15.87	
				140	5700		15.83	
				100	5500		15.84	
				104	5520		15.96	
				108	5540		15.92	
	112	5560	15.90					
	116	5580	15.93					
	120	5600	15.97					
	124	5620	15.89					
	128	5640	15.87					
	132	5660	15.94					
	136	5680	15.82					
	140	5700	15.91					
	802.11n	40	40	102	5510	HT4	Chain A	15.92
				110	5550			15.91
				118	5580			15.87
				126	5610			15.89
134				5670	15.90			
102				5510	15.91			
110				5550	15.90			
118				5580	15.84			
126	5610	15.81						
134	5670	15.89						
802.11ac	20	20	144	5720	VHT0	Chain A	15.88	
			Chain B	15.96				
	40	40	142	5710	VHT0	Chain A	15.94	
			Chain B	15.90				
	80	80	80	106	5530	VHT6	Chain A	15.87
				122	5610			15.93
				138	5690		15.91	
				106	5530		15.84	
122	5610	15.90						
138	5690	15.93						

Band	Mode	Bandwidth (MHz)	Channel	Frequency (MHz)	Data Rate	Antenna	Power (dBm)	
5800 MHz	802.11a	20	149	5745	6 Mbps	Chain A	15.92	
			153	5765			15.98	
			157	5785			16.00	
			161	5805			15.94	
			165	5825			15.90	
			149	5745		Chain B	15.96	
			153	5765			15.91	
			157	5785			16.00	
			161	5805			15.95	
			165	5825			15.93	
	802.11n	20	20	149	5745	HT8	Chain A	15.91
				153	5765			15.90
				157	5785			15.89
				161	5805			15.93
				165	5825			15.88
				149	5745		Chain B	15.96
				153	5765			15.91
				157	5785			15.90
				161	5805			15.93
				165	5825			15.97
	802.11n	40	40	151	5755	HT8	Chain A	15.89
				159	5795		Chain B	15.85
				151	5755		Chain B	15.84
	802.11ac	80	80	155	5775	VHT6	Chain A	15.83
							Chain B	15.86

Figure 8.1 Test Reduction Table – 2.4 GHz Main Black Case HighTek

Mode	Side	Required Channel	Tested/Reduced
802.11b	Back	1 – 2412 MHz	Reduced ¹
		6 – 2437 MHz	Reduced ¹
		11 – 2462 MHz	Reduced ¹
	Front Edge	1 – 2412 MHz	Reduced ¹
		6 – 2437 MHz	Tested
		11 – 2462 MHz	Reduced ¹
	Right	1 – 2412 MHz	Reduced ⁴
		6 – 2437 MHz	Reduced ⁴
		11 – 2462 MHz	Reduced ⁴
	Left, Bottom	1 – 2412 MHz	Reduced ⁴
		6 – 2437 MHz	Reduced ⁴
		11 – 2462 MHz	Reduced ⁴
802.11g	Back	1 – 2412 MHz	Reduced ³
		6 – 2437 MHz	Reduced ³
		11 – 2462 MHz	Reduced ³
	Front Edge	1 – 2412 MHz	Reduced ³
		6 – 2437 MHz	Reduced ³
		11 – 2462 MHz	Reduced ³
	Right	1 – 2412 MHz	Reduced ³
		6 – 2437 MHz	Reduced ³
		11 – 2462 MHz	Reduced ³
	Left, Bottom	1 – 2412 MHz	Reduced ³
		6 – 2437 MHz	Reduced ³
		11 – 2462 MHz	Reduced ³
802.11n	Back	1 – 2412 MHz	Reduced ³
		6 – 2437 MHz	Reduced ³
		11 – 2462 MHz	Reduced ³
	Front Edge	1 – 2412 MHz	Reduced ³
		6 – 2437 MHz	Reduced ³
		11 – 2462 MHz	Reduced ³
	Right	1 – 2412 MHz	Reduced ³
		6 – 2437 MHz	Reduced ³
		11 – 2462 MHz	Reduced ³
	Left, Bottom	1 – 2412 MHz	Reduced ³
		6 – 2437 MHz	Reduced ³
		11 – 2462 MHz	Reduced ³

Reduced¹ – When the reported SAR is ≤ 0.4 W/kg, SAR is not required for the remaining test configuration per KDB 248227 D01 v02 section 5.1.1 1) page 9.

Reduced² – When the reported SAR is >0.8 W/kg, test the next highest configuration until the SAR value is ≤ 1.2 W/kg per KDB 248227 D01 v02 section 5.1.1 3) page 9.

Reduced³ – When the highest reported SAR for DSSS is adjusted by the ratio of OFDM to DSSS specified maximum output power and the adjusted SAR is ≤ 1.2 W/kg, SAR is not required per KDB 248227 D01 v02 section 5.2.2 2) page 10.

Reduced⁴ – When the antenna is more than 25 mm from a side, the test can be reduced per KDB447498 D01 v05r02 section 4.3.1 1) page 11. See below for calculations.

Calculations for test exclusion for Bottom, Right and Left side.

Maximum power: 56.2 mW
 Bottom Edge distance: 210.73 mm
 Left Side distance: 191.45 mm
 Right Side distance: 101.45 mm

The closest distance is from the right side. Therefore, if the right side is excluded the bottom and left side would also be excluded.

$$[{\{(3.0)/(\sqrt{2.462})\} * 50 \text{ mm}}] + [101.45 - 50 \text{ mm}] * 10 = 610 \text{ mW}$$

which is greater than 56.2 mW

Figure 8.2 Test Reduction Table – 2.4 GHz Aux Black Case HighTek

Mode	Side	Required Channel	Tested/Reduced
802.11b	Back	1 – 2412 MHz	Reduced ¹
		6 – 2437 MHz	Reduced ¹
		11 – 2462 MHz	Reduced ¹
	Front Edge	1 – 2412 MHz	Reduced ¹
		6 – 2437 MHz	Tested
		11 – 2462 MHz	Reduced ¹
	Right	1 – 2412 MHz	Reduced ¹
		6 – 2437 MHz	Tested
		11 – 2462 MHz	Reduced ¹
	Left, Bottom	1 – 2412 MHz	Reduced ⁴
		6 – 2437 MHz	Reduced ⁴
		11 – 2462 MHz	Reduced ⁴
802.11g	Back	1 – 2412 MHz	Reduced ³
		6 – 2437 MHz	Reduced ³
		11 – 2462 MHz	Reduced ³
	Front Edge	1 – 2412 MHz	Reduced ³
		6 – 2437 MHz	Reduced ³
		11 – 2462 MHz	Reduced ³
	Right	1 – 2412 MHz	Reduced ³
		6 – 2437 MHz	Reduced ³
		11 – 2462 MHz	Reduced ³
	Left, Bottom	1 – 2412 MHz	Reduced ³
		6 – 2437 MHz	Reduced ³
		11 – 2462 MHz	Reduced ³
802.11n	Back	1 – 2412 MHz	Reduced ³
		6 – 2437 MHz	Reduced ³
		11 – 2462 MHz	Reduced ³
	Front Edge	1 – 2412 MHz	Reduced ³
		6 – 2437 MHz	Reduced ³
		11 – 2462 MHz	Reduced ³
	Right	1 – 2412 MHz	Reduced ³
		6 – 2437 MHz	Reduced ³
		11 – 2462 MHz	Reduced ³
	Left, Bottom	1 – 2412 MHz	Reduced ³
		6 – 2437 MHz	Reduced ³
		11 – 2462 MHz	Reduced ³

Reduced¹ – When the reported SAR is ≤ 0.4 W/kg, SAR is not required for the remaining test configuration per KDB 248227 D01 v02 section 5.1.1 1) page 9.

Reduced² – When the reported SAR is >0.8 W/kg, test the next highest configuration until the SAR value is ≤ 1.2 W/kg per KDB 248227 D01 v02 section 5.1.1 3) page 9.

Reduced³ – When the highest reported SAR for DSSS is adjusted by the ratio of OFDM to DSSS specified maximum output power and the adjusted SAR is ≤ 1.2 W/kg, SAR is not required per KDB 248227 D01 v02 section 5.2.2 2) page 10.

Reduced⁴ – When the antenna is more than 25 mm from a side, the test can be reduced per KDB447498 D01 v05r02 section 4.3.1 1) page 11. See below for calculations.

Calculations for test exclusion for Bottom and Left side.

Maximum power: 56.2 mW
 Bottom Edge distance: 210.73 mm
 Left Side distance: 286.45 mm

The closest distance is from the bottom side. Therefore, if the bottom side is excluded the right and laptop would also be excluded.

$$[[(3.0)/(\sqrt{2.462})]^2 * 50 \text{ mm}] + [(210.73 - 50 \text{ mm})^2 * 10] = 1702 \text{ mW}$$

which is greater than 56.2 mW

**Figure 8.3 Test Reduction Table – 2.4 GHz Main Black Case
Ethertronics**

Mode	Side	Required Channel	Tested/Reduced
802.11b	Back	1 – 2412 MHz	Reduced ¹
		6 – 2437 MHz	Reduced ¹
		11 – 2462 MHz	Reduced ¹
	Front Edge	1 – 2412 MHz	Reduced ¹
		6 – 2437 MHz	Tested
		11 – 2462 MHz	Reduced ¹
	Right	1 – 2412 MHz	Reduced ⁴
		6 – 2437 MHz	Reduced ⁴
		11 – 2462 MHz	Reduced ⁴
	Left, Bottom	1 – 2412 MHz	Reduced ⁴
		6 – 2437 MHz	Reduced ⁴
		11 – 2462 MHz	Reduced ⁴
802.11g	Back	1 – 2412 MHz	Reduced ³
		6 – 2437 MHz	Reduced ³
		11 – 2462 MHz	Reduced ³
	Front Edge	1 – 2412 MHz	Reduced ³
		6 – 2437 MHz	Reduced ³
		11 – 2462 MHz	Reduced ³
	Right	1 – 2412 MHz	Reduced ³
		6 – 2437 MHz	Reduced ³
		11 – 2462 MHz	Reduced ³
	Left, Bottom	1 – 2412 MHz	Reduced ³
		6 – 2437 MHz	Reduced ³
		11 – 2462 MHz	Reduced ³
802.11n	Back	1 – 2412 MHz	Reduced ³
		6 – 2437 MHz	Reduced ³
		11 – 2462 MHz	Reduced ³
	Front Edge	1 – 2412 MHz	Reduced ³
		6 – 2437 MHz	Reduced ³
		11 – 2462 MHz	Reduced ³
	Right	1 – 2412 MHz	Reduced ³
		6 – 2437 MHz	Reduced ³
		11 – 2462 MHz	Reduced ³
	Left, Bottom	1 – 2412 MHz	Reduced ³
		6 – 2437 MHz	Reduced ³
		11 – 2462 MHz	Reduced ³

- Reduced¹ – When the reported SAR is ≤ 0.4 W/kg, SAR is not required for the remaining test configuration per KDB 248227 D01 v02 section 5.1.1 1) page 9.
- Reduced² – When the reported SAR is >0.8 W/kg, test the next highest configuration until the SAR value is ≤ 1.2 W/kg per KDB 248227 D01 v02 section 5.1.1 3) page 9.
- Reduced³ – When the highest reported SAR for DSSS is adjusted by the ratio of OFDM to DSSS specified maximum output power and the adjusted SAR is ≤ 1.2 W/kg, SAR is not required per KDB 248227 D01 v02 section 5.2.2 2) page 10.
- Reduced⁴ – When the antenna is more than 25 mm from a side, the test can be reduced per KDB447498 D01 v05r02 section 4.3.1 1) page 11. See below for calculations.

Calculations for test exclusion for Bottom, Right and Left side.

Maximum power: 56.2 mW
 Bottom Edge distance: 210.73 mm
 Left Side distance: 191.45 mm
 Right Side distance: 101.45 mm

The closest distance is from the right side. Therefore, if the right side is excluded the bottom and left side would also be excluded.

$$[{\{(3.0)/(\sqrt{2.462})\} * 50 \text{ mm}}] + [101.45 - 50 \text{ mm}] * 10 = 610 \text{ mW}$$

which is greater than 56.2 mW

**Figure 8.4 Test Reduction Table – 2.4 GHz Aux Black Case
Ethertronics**

Mode	Side	Required Channel	Tested/Reduced
802.11b	Back	1 – 2412 MHz	Reduced ¹
		6 – 2437 MHz	Reduced ¹
		11 – 2462 MHz	Reduced ¹
	Front Edge	1 – 2412 MHz	Reduced ¹
		6 – 2437 MHz	Tested
		11 – 2462 MHz	Reduced ¹
	Right	1 – 2412 MHz	Reduced ¹
		6 – 2437 MHz	Tested
		11 – 2462 MHz	Reduced ¹
	Left, Bottom	1 – 2412 MHz	Reduced ⁴
		6 – 2437 MHz	Reduced ⁴
		11 – 2462 MHz	Reduced ⁴
802.11g	Back	1 – 2412 MHz	Reduced ³
		6 – 2437 MHz	Reduced ³
		11 – 2462 MHz	Reduced ³
	Front Edge	1 – 2412 MHz	Reduced ³
		6 – 2437 MHz	Reduced ³
		11 – 2462 MHz	Reduced ³
	Right	1 – 2412 MHz	Reduced ³
		6 – 2437 MHz	Reduced ³
		11 – 2462 MHz	Reduced ³
	Left, Bottom	1 – 2412 MHz	Reduced ³
		6 – 2437 MHz	Reduced ³
		11 – 2462 MHz	Reduced ³
802.11n	Back	1 – 2412 MHz	Reduced ³
		6 – 2437 MHz	Reduced ³
		11 – 2462 MHz	Reduced ³
	Front Edge	1 – 2412 MHz	Reduced ³
		6 – 2437 MHz	Reduced ³
		11 – 2462 MHz	Reduced ³
	Right	1 – 2412 MHz	Reduced ³
		6 – 2437 MHz	Reduced ³
		11 – 2462 MHz	Reduced ³
	Left, Bottom	1 – 2412 MHz	Reduced ³
		6 – 2437 MHz	Reduced ³
		11 – 2462 MHz	Reduced ³

Reduced¹ – When the reported SAR is ≤ 0.4 W/kg, SAR is not required for the remaining test configuration per KDB 248227 D01 v02 section 5.1.1 1) page 9.

Reduced² – When the reported SAR is >0.8 W/kg, test the next highest configuration until the SAR value is ≤ 1.2 W/kg per KDB 248227 D01 v02 section 5.1.1 3) page 9.

Reduced³ – When the highest reported SAR for DSSS is adjusted by the ratio of OFDM to DSSS specified maximum output power and the adjusted SAR is ≤ 1.2 W/kg, SAR is not required per KDB 248227 D01 v02 section 5.2.2 2) page 10.

Reduced⁴ – When the antenna is more than 25 mm from a side, the test can be reduced per KDB447498 D01 v05r02 section 4.3.1 1) page 11. See below for calculations.

Calculations for test exclusion for Bottom and Left side.

Maximum power: 56.2 mW
 Bottom Edge distance: 210.73 mm
 Left Side distance: 286.45 mm

The closest distance is from the bottom side. Therefore, if the bottom side is excluded the right and laptop would also be excluded.

$$[[(3.0)/(\sqrt{2.462}) * 50 \text{ mm}]] + [(210.73 - 50 \text{ mm}) * 10] = 1702 \text{ mW which is greater than } 56.2 \text{ mW}$$

Figure 8.5 Test Reduction Table – 2.4 GHz Main Silver Case HighTek

Mode	Side	Required Channel	Tested/Reduced
802.11b	Back	1 – 2412 MHz	Reduced ¹
		6 – 2437 MHz	Reduced ¹
		11 – 2462 MHz	Reduced ¹
	Front Edge	1 – 2412 MHz	Reduced ¹
		6 – 2437 MHz	Tested
		11 – 2462 MHz	Reduced ¹
	Right	1 – 2412 MHz	Reduced ⁴
		6 – 2437 MHz	Reduced ⁴
		11 – 2462 MHz	Reduced ⁴
	Left, Bottom	1 – 2412 MHz	Reduced ⁴
		6 – 2437 MHz	Reduced ⁴
		11 – 2462 MHz	Reduced ⁴
802.11g	Back	1 – 2412 MHz	Reduced ³
		6 – 2437 MHz	Reduced ³
		11 – 2462 MHz	Reduced ³
	Front Edge	1 – 2412 MHz	Reduced ³
		6 – 2437 MHz	Reduced ³
		11 – 2462 MHz	Reduced ³
	Right	1 – 2412 MHz	Reduced ³
		6 – 2437 MHz	Reduced ³
		11 – 2462 MHz	Reduced ³
	Left, Bottom	1 – 2412 MHz	Reduced ³
		6 – 2437 MHz	Reduced ³
		11 – 2462 MHz	Reduced ³
802.11n	Back	1 – 2412 MHz	Reduced ³
		6 – 2437 MHz	Reduced ³
		11 – 2462 MHz	Reduced ³
	Front Edge	1 – 2412 MHz	Reduced ³
		6 – 2437 MHz	Reduced ³
		11 – 2462 MHz	Reduced ³
	Right	1 – 2412 MHz	Reduced ³
		6 – 2437 MHz	Reduced ³
		11 – 2462 MHz	Reduced ³
	Left, Bottom	1 – 2412 MHz	Reduced ³
		6 – 2437 MHz	Reduced ³
		11 – 2462 MHz	Reduced ³

Reduced¹ – When the reported SAR is ≤ 0.4 W/kg, SAR is not required for the remaining test configuration per KDB 248227 D01 v02 section 5.1.1 1) page 9.

Reduced² – When the reported SAR is >0.8 W/kg, test the next highest configuration until the SAR value is ≤ 1.2 W/kg per KDB 248227 D01 v02 section 5.1.1 3) page 9.

Reduced³ – When the highest reported SAR for DSSS is adjusted by the ratio of OFDM to DSSS specified maximum output power and the adjusted SAR is ≤ 1.2 W/kg, SAR is not required per KDB 248227 D01 v02 section 5.2.2 2) page 10.

Reduced⁴ – When the antenna is more than 25 mm from a side, the test can be reduced per KDB447498 D01 v05r02 section 4.3.1 1) page 11. See below for calculations.

Calculations for test exclusion for Bottom, Right and Left side.

Maximum power: 56.2 mW
 Bottom Edge distance: 210.73 mm
 Left Side distance: 191.45 mm
 Right Side distance: 101.45 mm

The closest distance is from the right side. Therefore, if the right side is excluded the bottom and left side would also be excluded.

$$[{\{(3.0)/(\sqrt{2.462})\} * 50 \text{ mm}}] + [101.45 - 50 \text{ mm}] * 10 = 610 \text{ mW}$$

which is greater than 56.2 mW

Figure 8.6 Test Reduction Table – 2.4 GHz Aux Silver Case HighTek

Mode	Side	Required Channel	Tested/Reduced
802.11b	Back	1 – 2412 MHz	Reduced ¹
		6 – 2437 MHz	Reduced ¹
		11 – 2462 MHz	Reduced ¹
	Front Edge	1 – 2412 MHz	Reduced ¹
		6 – 2437 MHz	Tested
		11 – 2462 MHz	Reduced ¹
	Right	1 – 2412 MHz	Reduced ¹
		6 – 2437 MHz	Tested
		11 – 2462 MHz	Reduced ¹
	Left, Bottom	1 – 2412 MHz	Reduced ⁴
		6 – 2437 MHz	Reduced ⁴
		11 – 2462 MHz	Reduced ⁴
802.11g	Back	1 – 2412 MHz	Reduced ³
		6 – 2437 MHz	Reduced ³
		11 – 2462 MHz	Reduced ³
	Front Edge	1 – 2412 MHz	Reduced ³
		6 – 2437 MHz	Reduced ³
		11 – 2462 MHz	Reduced ³
	Right	1 – 2412 MHz	Reduced ³
		6 – 2437 MHz	Reduced ³
		11 – 2462 MHz	Reduced ³
	Left, Bottom	1 – 2412 MHz	Reduced ³
		6 – 2437 MHz	Reduced ³
		11 – 2462 MHz	Reduced ³
802.11n	Back	1 – 2412 MHz	Reduced ³
		6 – 2437 MHz	Reduced ³
		11 – 2462 MHz	Reduced ³
	Front Edge	1 – 2412 MHz	Reduced ³
		6 – 2437 MHz	Reduced ³
		11 – 2462 MHz	Reduced ³
	Right	1 – 2412 MHz	Reduced ³
		6 – 2437 MHz	Reduced ³
		11 – 2462 MHz	Reduced ³
	Left, Bottom	1 – 2412 MHz	Reduced ³
		6 – 2437 MHz	Reduced ³
		11 – 2462 MHz	Reduced ³

Reduced¹ – When the reported SAR is ≤ 0.4 W/kg, SAR is not required for the remaining test configuration per KDB 248227 D01 v02 section 5.1.1 1) page 9.

Reduced² – When the reported SAR is >0.8 W/kg, test the next highest configuration until the SAR value is ≤ 1.2 W/kg per KDB 248227 D01 v02 section 5.1.1 3) page 9.

Reduced³ – When the highest reported SAR for DSSS is adjusted by the ratio of OFDM to DSSS specified maximum output power and the adjusted SAR is ≤ 1.2 W/kg, SAR is not required per KDB 248227 D01 v02 section 5.2.2 2) page 10.

Reduced⁴ – When the antenna is more than 25 mm from a side, the test can be reduced per KDB447498 D01 v05r02 section 4.3.1 1) page 11. See below for calculations.

Calculations for test exclusion for Bottom and Left side.

Maximum power: 56.2 mW
 Bottom Edge distance: 210.73 mm
 Left Side distance: 286.45 mm

The closest distance is from the bottom side. Therefore, if the bottom side is excluded the right and laptop would also be excluded.

$$[[(3.0)/(\sqrt{2.462})]^2 * 50 \text{ mm}] + [(210.73 - 50 \text{ mm})^2 * 10] = 1702 \text{ mW}$$

which is greater than 56.2 mW

**Figure 8.7 Test Reduction Table – 2.4 GHz Main Silver Case
Ethertronics**

Mode	Side	Required Channel	Tested/Reduced
802.11b	Back	1 – 2412 MHz	Reduced ¹
		6 – 2437 MHz	Reduced ¹
		11 – 2462 MHz	Reduced ¹
	Front Edge	1 – 2412 MHz	Reduced ¹
		6 – 2437 MHz	Tested
		11 – 2462 MHz	Reduced ¹
	Right	1 – 2412 MHz	Reduced ⁴
		6 – 2437 MHz	Reduced ⁴
		11 – 2462 MHz	Reduced ⁴
	Left, Bottom	1 – 2412 MHz	Reduced ⁴
		6 – 2437 MHz	Reduced ⁴
		11 – 2462 MHz	Reduced ⁴
802.11g	Back	1 – 2412 MHz	Reduced ³
		6 – 2437 MHz	Reduced ³
		11 – 2462 MHz	Reduced ³
	Front Edge	1 – 2412 MHz	Reduced ³
		6 – 2437 MHz	Reduced ³
		11 – 2462 MHz	Reduced ³
	Right	1 – 2412 MHz	Reduced ³
		6 – 2437 MHz	Reduced ³
		11 – 2462 MHz	Reduced ³
	Left, Bottom	1 – 2412 MHz	Reduced ³
		6 – 2437 MHz	Reduced ³
		11 – 2462 MHz	Reduced ³
802.11n	Back	1 – 2412 MHz	Reduced ³
		6 – 2437 MHz	Reduced ³
		11 – 2462 MHz	Reduced ³
	Front Edge	1 – 2412 MHz	Reduced ³
		6 – 2437 MHz	Reduced ³
		11 – 2462 MHz	Reduced ³
	Right	1 – 2412 MHz	Reduced ³
		6 – 2437 MHz	Reduced ³
		11 – 2462 MHz	Reduced ³
	Left, Bottom	1 – 2412 MHz	Reduced ³
		6 – 2437 MHz	Reduced ³
		11 – 2462 MHz	Reduced ³

- Reduced¹ – When the reported SAR is ≤ 0.4 W/kg, SAR is not required for the remaining test configuration per KDB 248227 D01 v02 section 5.1.1 1) page 9.
- Reduced² – When the reported SAR is >0.8 W/kg, test the next highest configuration until the SAR value is ≤ 1.2 W/kg per KDB 248227 D01 v02 section 5.1.1 3) page 9.
- Reduced³ – When the highest reported SAR for DSSS is adjusted by the ratio of OFDM to DSSS specified maximum output power and the adjusted SAR is ≤ 1.2 W/kg, SAR is not required per KDB 248227 D01 v02 section 5.2.2 2) page 10.
- Reduced⁴ – When the antenna is more than 25 mm from a side, the test can be reduced per KDB447498 D01 v05r02 section 4.3.1 1) page 11. See below for calculations.

Calculations for test exclusion for Bottom, Right and Left side.

Maximum power: 56.2 mW
 Bottom Edge distance: 210.73 mm
 Left Side distance: 191.45 mm
 Right Side distance: 101.45 mm

The closest distance is from the right side. Therefore, if the right side is excluded the bottom and left side would also be excluded.

$$[{\{(3.0)/(\sqrt{2.462})\} * 50 \text{ mm}}] + [101.45 - 50 \text{ mm}] * 10 = 610 \text{ mW}$$

which is greater than 56.2 mW

**Figure 8.8 Test Reduction Table – 2.4 GHz Aux Silver Case
Ethertronics**

Mode	Side	Required Channel	Tested/Reduced
802.11b	Back	1 – 2412 MHz	Reduced ¹
		6 – 2437 MHz	Reduced ¹
		11 – 2462 MHz	Reduced ¹
	Front Edge	1 – 2412 MHz	Reduced ¹
		6 – 2437 MHz	Tested
		11 – 2462 MHz	Reduced ¹
	Right	1 – 2412 MHz	Reduced ²
		6 – 2437 MHz	Tested
		11 – 2462 MHz	Tested
	Left, Bottom	1 – 2412 MHz	Reduced ⁴
		6 – 2437 MHz	Reduced ⁴
		11 – 2462 MHz	Reduced ⁴
802.11g	Back	1 – 2412 MHz	Reduced ³
		6 – 2437 MHz	Reduced ³
		11 – 2462 MHz	Reduced ³
	Front Edge	1 – 2412 MHz	Reduced ³
		6 – 2437 MHz	Reduced ³
		11 – 2462 MHz	Reduced ³
	Right	1 – 2412 MHz	Reduced ³
		6 – 2437 MHz	Reduced ³
		11 – 2462 MHz	Reduced ³
	Left, Bottom	1 – 2412 MHz	Reduced ³
		6 – 2437 MHz	Reduced ³
		11 – 2462 MHz	Reduced ³
802.11n	Back	1 – 2412 MHz	Reduced ³
		6 – 2437 MHz	Reduced ³
		11 – 2462 MHz	Reduced ³
	Front Edge	1 – 2412 MHz	Reduced ³
		6 – 2437 MHz	Reduced ³
		11 – 2462 MHz	Reduced ³
	Right	1 – 2412 MHz	Reduced ³
		6 – 2437 MHz	Reduced ³
		11 – 2462 MHz	Reduced ³
	Left, Bottom	1 – 2412 MHz	Reduced ³
		6 – 2437 MHz	Reduced ³
		11 – 2462 MHz	Reduced ³

Reduced¹ – When the reported SAR is ≤ 0.4 W/kg, SAR is not required for the remaining test configuration per KDB 248227 D01 v02 section 5.1.1 1) page 9.

Reduced² – When the reported SAR is >0.4 W/kg, test the next highest configuration until the SAR value is ≤ 0.8 W/kg per KDB 248227 D01 v02 section 5.1.1 2) page 9.

Reduced³ – When the highest reported SAR for DSSS is adjusted by the ratio of OFDM to DSSS specified maximum output power and the adjusted SAR is ≤ 1.2 W/kg, SAR is not required per KDB 248227 D01 v02 section 5.2.2 2) page 10.

Reduced⁴ – When the antenna is more than 25 mm from a side, the test can be reduced per KDB447498 D01 v05r02 section 4.3.1 1) page 11. See below for calculations.

Calculations for test exclusion for Bottom and Left side.

Maximum power: 56.2 mW
 Bottom Edge distance: 210.73 mm
 Left Side distance: 286.45 mm

The closest distance is from the bottom side. Therefore, if the bottom side is excluded the right and laptop would also be excluded.

$$[[{(3.0)/(\sqrt{2.462})} * 50 \text{ mm}]] + [[{210.73 - 50 \text{ mm}} * 10]] = 1702 \text{ mW which is greater than } 56.2 \text{ mW}$$

Figure 8.9 Test Reduction Table – 5.1 GHz Main Black Case HighTek

Mode	Side	Required Channel	Tested/Reduced
802.11a 5150 MHz	Back	36 – 5180 MHz	Reduced ¹
		40 – 5200 MHz	Reduced ¹
		44 – 5220 MHz	Reduced ¹
		48 – 5240 MHz	Reduced ¹
	Front Edge	36 – 5180 MHz	Reduced ¹
		40 – 5200 MHz	Reduced ¹
		44 – 5220 MHz	Reduced ¹
		48 – 5240 MHz	Reduced ¹
	Right, Left, Bottom	36 – 5180 MHz	Reduced ²
		40 – 5200 MHz	Reduced ²
		44 – 5220 MHz	Reduced ²
		48 – 5240 MHz	Reduced ²
802.11n 5150 MHz	Back	36 – 5180 MHz	Reduced ¹
		40 – 5200 MHz	Reduced ¹
		44 – 5220 MHz	Reduced ¹
		48 – 5240 MHz	Reduced ¹
	Front Edge	36 – 5180 MHz	Reduced ¹
		40 – 5200 MHz	Reduced ¹
		44 – 5220 MHz	Reduced ¹
		48 – 5240 MHz	Reduced ¹
	Right, Left, Bottom	36 – 5180 MHz	Reduced ²
		40 – 5200 MHz	Reduced ²
		44 – 5220 MHz	Reduced ²
		48 – 5240 MHz	Reduced ²
802.11ac 5210 MHz	Back	42 – 5210 MHz	Reduced ¹
	Front Edge	42 – 5210 MHz	Reduced ¹
	Right, Left, Bottom	42 – 5210 MHz	Reduced ²

Reduced¹ – When the adjusted SAR is ≤ 1.2 W/kg, SAR is not required for the UNII-1 with the same or lower maximum output power in that test configuration per KDB 248227 D01 v02 section 5.3.1 1) page 11.

Reduced² – When the antenna is more than 25 mm from a side, the test can be reduced per KDB447498 D01 v05r02 section 4.3.1 1) page 11. See below for calculations.

Calculations for test exclusion for Bottom, Right and Left side.

Maximum power: 39.8 mW
 Bottom Edge distance: 210.73 mm
 Left Side distance: 191.45 mm
 Right Side distance: 101.45 mm

The closest distance is from the right side. Therefore, if the right side is excluded the bottom and left side would also be excluded.

$$[{\{(3.0)/(\sqrt{5.24})\} * 50 \text{ mm}}] + [101.45 - 50 \text{ mm}] = 580 \text{ mW which is greater than } 39.8 \text{ mW}$$

Figure 8.10 Test Reduction Table – 5.1 GHz Aux Black Case HighTek

Mode	Side	Required Channel	Tested/Reduced
802.11a 5150 MHz	Back	36 – 5180 MHz	Reduced ¹
		40 – 5200 MHz	Reduced ¹
		44 – 5220 MHz	Reduced ¹
		48 – 5240 MHz	Reduced ¹
	Front Edge	36 – 5180 MHz	Reduced ¹
		40 – 5200 MHz	Reduced ¹
		44 – 5220 MHz	Reduced ¹
		48 – 5240 MHz	Reduced ¹
	Right	36 – 5180 MHz	Reduced ¹
		40 – 5200 MHz	Reduced ¹
		44 – 5220 MHz	Reduced ¹
		48 – 5240 MHz	Reduced ¹
Left, Bottom	36 – 5180 MHz	Reduced ²	
	40 – 5200 MHz	Reduced ²	
	44 – 5220 MHz	Reduced ²	
	48 – 5240 MHz	Reduced ²	
802.11n 5150 MHz	Back	36 – 5180 MHz	Reduced ¹
		40 – 5200 MHz	Reduced ¹
		44 – 5220 MHz	Reduced ¹
		48 – 5240 MHz	Reduced ¹
	Front Edge	36 – 5180 MHz	Reduced ¹
		40 – 5200 MHz	Reduced ¹
		44 – 5220 MHz	Reduced ¹
		48 – 5240 MHz	Reduced ¹
	Right	36 – 5180 MHz	Reduced ¹
		40 – 5200 MHz	Reduced ¹
		44 – 5220 MHz	Reduced ¹
		48 – 5240 MHz	Reduced ¹
Left, Bottom	36 – 5180 MHz	Reduced ²	
	40 – 5200 MHz	Reduced ²	
	44 – 5220 MHz	Reduced ²	
	48 – 5240 MHz	Reduced ²	
802.11ac 5210 MHz	Back	42 – 5210 MHz	Reduced ¹
	Front Edge	42 – 5210 MHz	Reduced ¹
	Right	42 – 5210 MHz	Reduced ¹
	Left, Bottom	42 – 5210 MHz	Reduced ²

Reduced¹ – When the adjusted SAR is ≤ 1.2 W/kg, SAR is not required for the UNII-1 with the same or lower maximum output power in that test configuration per KDB 248227 D01 v02 section 5.3.1 1) page 11.

Reduced² – When the antenna is more than 25 mm from a side, the test can be reduced per KDB447498 D01 v05r02 section 4.3.1 1) page 11. See below for calculations.

Calculations for test exclusion for Bottom and Left side.

Maximum power: 39.8 mW
 Bottom Edge distance: 210.73 mm
 Left Side distance: 286.45 mm

The closest distance is from the bottom side. Therefore, if the bottom side is excluded the right and laptop would also be excluded.

$$[{\{(3.0)/(\sqrt{5.24})\} * 50 \text{ mm}}] + [210.73 - 50 \text{ mm}] * 10 = 1672 \text{ mW}$$

which is greater than 39.8 mW

**Figure 8.11 Test Reduction Table – 5.1 GHz Main Black Case
Ethertronics**

Mode	Side	Required Channel	Tested/Reduced
802.11a 5150 MHz	Back	36 – 5180 MHz	Reduced ¹
		40 – 5200 MHz	Reduced ¹
		44 – 5220 MHz	Reduced ¹
		48 – 5240 MHz	Reduced ¹
	Front Edge	36 – 5180 MHz	Reduced ¹
		40 – 5200 MHz	Reduced ¹
		44 – 5220 MHz	Reduced ¹
		48 – 5240 MHz	Reduced ¹
	Right, Left, Bottom	36 – 5180 MHz	Reduced ²
		40 – 5200 MHz	Reduced ²
		44 – 5220 MHz	Reduced ²
		48 – 5240 MHz	Reduced ²
802.11n 5150 MHz	Back	36 – 5180 MHz	Reduced ¹
		40 – 5200 MHz	Reduced ¹
		44 – 5220 MHz	Reduced ¹
		48 – 5240 MHz	Reduced ¹
	Front Edge	36 – 5180 MHz	Reduced ¹
		40 – 5200 MHz	Reduced ¹
		44 – 5220 MHz	Reduced ¹
		48 – 5240 MHz	Reduced ¹
	Right, Left, Bottom	36 – 5180 MHz	Reduced ²
		40 – 5200 MHz	Reduced ²
		44 – 5220 MHz	Reduced ²
		48 – 5240 MHz	Reduced ²
802.11ac 5210 MHz	Back	42 – 5210 MHz	Reduced ¹
	Front Edge	42 – 5210 MHz	Reduced ¹
	Right, Left, Bottom	42 – 5210 MHz	Reduced ²

Reduced¹ – When the adjusted SAR is ≤ 1.2 W/kg, SAR is not required for the UNII-1 with the same or lower maximum output power in that test configuration per KDB 248227 D01 v02 section 5.3.1 1) page 11.

Reduced² – When the antenna is more than 25 mm from a side, the test can be reduced per KDB447498 D01 v05r02 section 4.3.1 1) page 11. See below for calculations.

Calculations for test exclusion for Bottom, Right and Left side.

Maximum power: 39.8 mW
 Bottom Edge distance: 210.73 mm
 Left Side distance: 191.45 mm
 Right Side distance: 101.45 mm

The closest distance is from the right side. Therefore, if the right side is excluded the bottom and left side would also be excluded.

$$[[(3.0)/(\sqrt{5.24}) * 50 \text{ mm}]] + [(101.45 - 50 \text{ mm}) * 10] = 580 \text{ mW}$$

which is greater than 39.8 mW

**Figure 8.12 Test Reduction Table – 5.1 GHz Aux Black Case
Ethertronics**

Mode	Side	Required Channel	Tested/Reduced
802.11a 5150 MHz	Back	36 – 5180 MHz	Reduced ¹
		40 – 5200 MHz	Reduced ¹
		44 – 5220 MHz	Reduced ¹
		48 – 5240 MHz	Reduced ¹
	Front Edge	36 – 5180 MHz	Reduced ¹
		40 – 5200 MHz	Reduced ¹
		44 – 5220 MHz	Reduced ¹
		48 – 5240 MHz	Reduced ¹
	Right	36 – 5180 MHz	Reduced ¹
		40 – 5200 MHz	Reduced ¹
		44 – 5220 MHz	Reduced ¹
		48 – 5240 MHz	Reduced ¹
Left, Bottom	36 – 5180 MHz	Reduced ²	
	40 – 5200 MHz	Reduced ²	
	44 – 5220 MHz	Reduced ²	
	48 – 5240 MHz	Reduced ²	
802.11n 5150 MHz	Back	36 – 5180 MHz	Reduced ¹
		40 – 5200 MHz	Reduced ¹
		44 – 5220 MHz	Reduced ¹
		48 – 5240 MHz	Reduced ¹
	Front Edge	36 – 5180 MHz	Reduced ¹
		40 – 5200 MHz	Reduced ¹
		44 – 5220 MHz	Reduced ¹
		48 – 5240 MHz	Reduced ¹
	Right	36 – 5180 MHz	Reduced ¹
		40 – 5200 MHz	Reduced ¹
		44 – 5220 MHz	Reduced ¹
		48 – 5240 MHz	Reduced ¹
Left, Bottom	36 – 5180 MHz	Reduced ²	
	40 – 5200 MHz	Reduced ²	
	44 – 5220 MHz	Reduced ²	
	48 – 5240 MHz	Reduced ²	
802.11ac 5210 MHz	Back	42 – 5210 MHz	Reduced ¹
	Front Edge	42 – 5210 MHz	Reduced ¹
	Right	42 – 5210 MHz	Reduced ¹
	Left, Bottom	42 – 5210 MHz	Reduced ²

Reduced¹ – When the adjusted SAR is ≤ 1.2 W/kg, SAR is not required for the UNII-1 with the same or lower maximum output power in that test configuration per KDB 248227 D01 v02 section 5.3.1 1) page 11.

Reduced² – When the antenna is more than 25 mm from a side, the test can be reduced per KDB447498 D01 v05r02 section 4.3.1 1) page 11. See below for calculations.

Calculations for test exclusion for Bottom and Left side.

Maximum power: 39.8 mW
 Bottom Edge distance: 210.73 mm
 Left Side distance: 286.45 mm

The closest distance is from the bottom side. Therefore, if the bottom side is excluded the right and laptop would also be excluded.

$$[[(3.0)/(\sqrt{5.24})]*50 \text{ mm}]+[210.73-50 \text{ mm}]*10]=1672 \text{ mW}$$

which is greater than 39.8 mW

Figure 8.13 Test Reduction Table – 5.1 GHz Main Silver Case HighTek

Mode	Side	Required Channel	Tested/Reduced
802.11a 5150 MHz	Back	36 – 5180 MHz	Reduced ¹
		40 – 5200 MHz	Reduced ¹
		44 – 5220 MHz	Reduced ¹
		48 – 5240 MHz	Reduced ¹
	Front Edge	36 – 5180 MHz	Reduced ¹
		40 – 5200 MHz	Reduced ¹
		44 – 5220 MHz	Reduced ¹
		48 – 5240 MHz	Reduced ¹
	Right, Left, Bottom	36 – 5180 MHz	Reduced ²
		40 – 5200 MHz	Reduced ²
		44 – 5220 MHz	Reduced ²
		48 – 5240 MHz	Reduced ²
802.11n 5150 MHz	Back	36 – 5180 MHz	Reduced ¹
		40 – 5200 MHz	Reduced ¹
		44 – 5220 MHz	Reduced ¹
		48 – 5240 MHz	Reduced ¹
	Front Edge	36 – 5180 MHz	Reduced ¹
		40 – 5200 MHz	Reduced ¹
		44 – 5220 MHz	Reduced ¹
		48 – 5240 MHz	Reduced ¹
	Right, Left, Bottom	36 – 5180 MHz	Reduced ²
		40 – 5200 MHz	Reduced ²
		44 – 5220 MHz	Reduced ²
		48 – 5240 MHz	Reduced ²
802.11ac 5210 MHz	Back	42 – 5210 MHz	Reduced ¹
	Front Edge	42 – 5210 MHz	Reduced ¹
	Right, Left, Bottom	42 – 5210 MHz	Reduced ²

Reduced¹ – When the adjusted SAR is ≤ 1.2 W/kg, SAR is not required for the UNII-1 with the same or lower maximum output power in that test configuration per KDB 248227 D01 v02 section 5.3.1 1) page 11.

Reduced² – When the antenna is more than 25 mm from a side, the test can be reduced per KDB447498 D01 v05r02 section 4.3.1 1) page 11. See below for calculations.

Calculations for test exclusion for Bottom, Right and Left side.

Maximum power: 39.8 mW
 Bottom Edge distance: 210.73 mm
 Left Side distance: 191.45 mm
 Right Side distance: 101.45 mm

The closest distance is from the right side. Therefore, if the right side is excluded the bottom and left side would also be excluded.

$$[{\frac{3.0}{\sqrt{5.24}}}] * 50 \text{ mm}] + [(101.45 - 50 \text{ mm}) * 10] = 580 \text{ mW which is greater than } 39.8 \text{ mW}$$

Figure 8.14 Test Reduction Table – 5.1 GHz Aux Silver Case HighTek

Mode	Side	Required Channel	Tested/Reduced
802.11a 5150 MHz	Back	36 – 5180 MHz	Reduced ¹
		40 – 5200 MHz	Reduced ¹
		44 – 5220 MHz	Reduced ¹
		48 – 5240 MHz	Reduced ¹
	Front Edge	36 – 5180 MHz	Reduced ¹
		40 – 5200 MHz	Reduced ¹
		44 – 5220 MHz	Reduced ¹
		48 – 5240 MHz	Reduced ¹
	Right	36 – 5180 MHz	Reduced ¹
		40 – 5200 MHz	Reduced ¹
		44 – 5220 MHz	Reduced ¹
		48 – 5240 MHz	Reduced ¹
Left, Bottom	36 – 5180 MHz	Reduced ²	
	40 – 5200 MHz	Reduced ²	
	44 – 5220 MHz	Reduced ²	
	48 – 5240 MHz	Reduced ²	
802.11n 5150 MHz	Back	36 – 5180 MHz	Reduced ¹
		40 – 5200 MHz	Reduced ¹
		44 – 5220 MHz	Reduced ¹
		48 – 5240 MHz	Reduced ¹
	Front Edge	36 – 5180 MHz	Reduced ¹
		40 – 5200 MHz	Reduced ¹
		44 – 5220 MHz	Reduced ¹
		48 – 5240 MHz	Reduced ¹
	Right	36 – 5180 MHz	Reduced ¹
		40 – 5200 MHz	Reduced ¹
		44 – 5220 MHz	Reduced ¹
		48 – 5240 MHz	Reduced ¹
Left, Bottom	36 – 5180 MHz	Reduced ²	
	40 – 5200 MHz	Reduced ²	
	44 – 5220 MHz	Reduced ²	
	48 – 5240 MHz	Reduced ²	
802.11ac 5210 MHz	Back	42 – 5210 MHz	Reduced ¹
	Front Edge	42 – 5210 MHz	Reduced ¹
	Right	42 – 5210 MHz	Reduced ¹
	Left, Bottom	42 – 5210 MHz	Reduced ²

Reduced¹ – When the adjusted SAR is ≤ 1.2 W/kg, SAR is not required for the UNII-1 with the same or lower maximum output power in that test configuration per KDB 248227 D01 v02 section 5.3.1 1) page 11.

Reduced² – When the antenna is more than 25 mm from a side, the test can be reduced per KDB447498 D01 v05r02 section 4.3.1 1) page 11. See below for calculations.

Calculations for test exclusion for Bottom and Left side.

Maximum power: 39.8 mW
 Bottom Edge distance: 210.73 mm
 Left Side distance: 286.45 mm

The closest distance is from the bottom side. Therefore, if the bottom side is excluded the right and laptop would also be excluded.

$$[{\frac{3.0}{\sqrt{5.24}}}] * 50 \text{ mm}] + [210.73 - 50 \text{ mm}] * 10 = 1672 \text{ mW}$$

which is greater than 39.8 mW

**Figure 8.15 Test Reduction Table – 5.1 GHz Main Silver Case
Ethertronics**

Mode	Side	Required Channel	Tested/Reduced
802.11a 5150 MHz	Back	36 – 5180 MHz	Reduced ¹
		40 – 5200 MHz	Reduced ¹
		44 – 5220 MHz	Reduced ¹
		48 – 5240 MHz	Reduced ¹
	Front Edge	36 – 5180 MHz	Reduced ¹
		40 – 5200 MHz	Reduced ¹
		44 – 5220 MHz	Reduced ¹
		48 – 5240 MHz	Reduced ¹
	Right, Left, Bottom	36 – 5180 MHz	Reduced ²
		40 – 5200 MHz	Reduced ²
		44 – 5220 MHz	Reduced ²
		48 – 5240 MHz	Reduced ²
802.11n 5150 MHz	Back	36 – 5180 MHz	Reduced ¹
		40 – 5200 MHz	Reduced ¹
		44 – 5220 MHz	Reduced ¹
		48 – 5240 MHz	Reduced ¹
	Front Edge	36 – 5180 MHz	Reduced ¹
		40 – 5200 MHz	Reduced ¹
		44 – 5220 MHz	Reduced ¹
		48 – 5240 MHz	Reduced ¹
	Right, Left, Bottom	36 – 5180 MHz	Reduced ²
		40 – 5200 MHz	Reduced ²
		44 – 5220 MHz	Reduced ²
		48 – 5240 MHz	Reduced ²
802.11ac 5210 MHz	Back	42 – 5210 MHz	Reduced ¹
	Front Edge	42 – 5210 MHz	Reduced ¹
	Right, Left, Bottom	42 – 5210 MHz	Reduced ²

Reduced¹ – When the adjusted SAR is ≤ 1.2 W/kg, SAR is not required for the UNII-1 with the same or lower maximum output power in that test configuration per KDB 248227 D01 v02 section 5.3.1 1) page 11.

Reduced² – When the antenna is more than 25 mm from a side, the test can be reduced per KDB447498 D01 v05r02 section 4.3.1 1) page 11. See below for calculations.

Calculations for test exclusion for Bottom, Right and Left side.

Maximum power: 39.8 mW
 Bottom Edge distance: 210.73 mm
 Left Side distance: 191.45 mm
 Right Side distance: 101.45 mm

The closest distance is from the right side. Therefore, if the right side is excluded the bottom and left side would also be excluded.

$$[[(3.0)/(\sqrt{5.24}) * 50 \text{ mm}]] + [(101.45 - 50 \text{ mm}) * 10] = 580 \text{ mW}$$

which is greater than 39.8 mW

**Figure 8.16 Test Reduction Table – 5.1 GHz Aux Silver Case
Ethertronics**

Mode	Side	Required Channel	Tested/Reduced
802.11a 5150 MHz	Back	36 – 5180 MHz	Reduced ¹
		40 – 5200 MHz	Reduced ¹
		44 – 5220 MHz	Reduced ¹
		48 – 5240 MHz	Reduced ¹
	Front Edge	36 – 5180 MHz	Reduced ¹
		40 – 5200 MHz	Reduced ¹
		44 – 5220 MHz	Reduced ¹
		48 – 5240 MHz	Reduced ¹
	Right	36 – 5180 MHz	Reduced ¹
		40 – 5200 MHz	Reduced ¹
		44 – 5220 MHz	Reduced ¹
		48 – 5240 MHz	Reduced ¹
	Left, Bottom	36 – 5180 MHz	Reduced ²
		40 – 5200 MHz	Reduced ²
		44 – 5220 MHz	Reduced ²
		48 – 5240 MHz	Reduced ²
802.11n 5150 MHz	Back	36 – 5180 MHz	Reduced ¹
		40 – 5200 MHz	Reduced ¹
		44 – 5220 MHz	Reduced ¹
		48 – 5240 MHz	Reduced ¹
	Front Edge	36 – 5180 MHz	Reduced ¹
		40 – 5200 MHz	Reduced ¹
		44 – 5220 MHz	Reduced ¹
		48 – 5240 MHz	Reduced ¹
	Right	36 – 5180 MHz	Reduced ¹
		40 – 5200 MHz	Reduced ¹
		44 – 5220 MHz	Reduced ¹
		48 – 5240 MHz	Reduced ¹
	Left, Bottom	36 – 5180 MHz	Reduced ²
		40 – 5200 MHz	Reduced ²
		44 – 5220 MHz	Reduced ²
		48 – 5240 MHz	Reduced ²
802.11ac 5210 MHz	Back	42 – 5210 MHz	Reduced ¹
	Front Edge	42 – 5210 MHz	Reduced ¹
	Right	42 – 5210 MHz	Reduced ¹
	Left, Bottom	42 – 5210 MHz	Reduced ²

Reduced¹ – When the adjusted SAR is ≤ 1.2 W/kg, SAR is not required for the UNII-1 with the same or lower maximum output power in that test configuration per KDB 248227 D01 v02 section 5.3.1 1) page 11.

Reduced² – When the antenna is more than 25 mm from a side, the test can be reduced per KDB447498 D01 v05r02 section 4.3.1 1) page 11. See below for calculations.

Calculations for test exclusion for Bottom and Left side.

Maximum power: 39.8 mW
 Bottom Edge distance: 210.73 mm
 Left Side distance: 286.45 mm

The closest distance is from the bottom side. Therefore, if the bottom side is excluded the right and laptop would also be excluded.

$$[[{(3.0)/(\sqrt{5.24})]*50 \text{ mm}}]+[210.73-50 \text{ mm}]*10]=1672 \text{ mW}$$

which is greater than 39.8 mW

Figure 8.17 Test Reduction Table – 5.2 GHz Main Black Case HighTek

Mode	Side	Required Channel	Tested/Reduced
802.11a 5250 MHz	Back	52 – 5260 MHz	Reduced ¹
		56 – 5280 MHz	Reduced ¹
		60 – 5300 MHz	Reduced ¹
		64 – 5320 MHz	Reduced ¹
	Front Edge	52 – 5260 MHz	Reduced ¹
		56 – 5280 MHz	Reduced ¹
		60 – 5300 MHz	Tested
		64 – 5320 MHz	Reduced ¹
	Right, Left, Bottom	52 – 5260 MHz	Reduced ²
		56 – 5280 MHz	Reduced ²
		60 – 5300 MHz	Reduced ²
		64 – 5320 MHz	Reduced ²
802.11n 5250 MHz	Back	52 – 5260 MHz	Reduced ¹
		56 – 5280 MHz	Reduced ¹
		60 – 5300 MHz	Reduced ¹
		64 – 5320 MHz	Reduced ¹
	Front Edge	52 – 5260 MHz	Reduced ¹
		56 – 5280 MHz	Reduced ¹
		60 – 5300 MHz	Reduced ¹
		64 – 5320 MHz	Reduced ¹
	Right, Left, Bottom	52 – 5260 MHz	Reduced ²
		56 – 5280 MHz	Reduced ²
		60 – 5300 MHz	Reduced ²
		64 – 5320 MHz	Reduced ²
802.11ac 5210 MHz	Back	58 – 5290 MHz	Reduced ¹
	Front Edge	58 – 5290 MHz	Reduced ¹
	Right, Left, Bottom	58 – 5290 MHz	Reduced ²

Reduced¹ – When the reported SAR is ≤ 0.4 W/kg, SAR is not required for the remaining test configuration per KDB 248227 D01 v02 section 5.1.1 1) page 9.

Reduced² – When the antenna is more than 25 mm from a side, the test can be reduced per KDB447498 D01 v05r02 section 4.3.1 1) page 11. See below for calculations.

Reduced³ – When the reported SAR is >0.8 W/kg, test the next highest configuration until the SAR value is ≤ 1.2 W/kg per KDB 248227 D01 v02 section 5.1.1 3) page 9.

Calculations for test exclusion for Bottom, Right and Left side.

Maximum power: 39.8 mW
 Bottom Edge distance: 210.73 mm
 Left Side distance: 191.45 mm
 Right Side distance: 101.45 mm

The closest distance is from the right side. Therefore, if the right side is excluded the bottom and left side would also be excluded.

$$[[(3.0)/(\sqrt{5.32})]*50 \text{ mm}]+[101.45-50 \text{ mm}]*10]=579 \text{ mW}$$

which is greater than 39.8 mW

Figure 8.18 Test Reduction Table – 5.2 GHz Aux Black Case HighTek

Mode	Side	Required Channel	Tested/Reduced
802.11a 5250 MHz	Back	52 – 5260 MHz	Reduced ¹
		56 – 5280 MHz	Reduced ¹
		60 – 5300 MHz	Reduced ¹
		64 – 5320 MHz	Reduced ¹
	Front Edge	52 – 5260 MHz	Reduced ¹
		56 – 5280 MHz	Reduced ¹
		60 – 5300 MHz	Tested
		64 – 5320 MHz	Reduced ¹
	Right	52 – 5260 MHz	Reduced ¹
		56 – 5280 MHz	Reduced ¹
		60 – 5300 MHz	Tested
		64 – 5320 MHz	Reduced ¹
Left, Bottom	52 – 5260 MHz	Reduced ²	
	56 – 5280 MHz	Reduced ²	
	60 – 5300 MHz	Reduced ²	
	64 – 5320 MHz	Reduced ²	
802.11n 5250 MHz	Back	52 – 5260 MHz	Reduced ³
		56 – 5280 MHz	Reduced ³
		60 – 5300 MHz	Reduced ³
		64 – 5320 MHz	Reduced ³
	Front Edge	52 – 5260 MHz	Reduced ¹
		56 – 5280 MHz	Reduced ¹
		60 – 5300 MHz	Reduced ¹
		64 – 5320 MHz	Reduced ¹
	Right	52 – 5260 MHz	Reduced ¹
		56 – 5280 MHz	Reduced ¹
		60 – 5300 MHz	Reduced ¹
		64 – 5320 MHz	Reduced ¹
Left, Bottom	52 – 5260 MHz	Reduced ¹	
	56 – 5280 MHz	Reduced ¹	
	60 – 5300 MHz	Reduced ¹	
	64 – 5320 MHz	Reduced ¹	
802.11ac 5210 MHz	Back	58 – 5290 MHz	Reduced ⁴
	Front Edge	58 – 5290 MHz	Reduced ²
	Right	58 – 5290 MHz	Reduced ²
	Left, Bottom	58 – 5290 MHz	Reduced ³

Reduced¹ – When the reported SAR is ≤ 0.4 W/kg, SAR is not required for the remaining test configuration per KDB 248227 D01 v02 section 5.1.1 1) page 9.

Reduced² – When the antenna is more than 25 mm from a side, the test can be reduced per KDB447498 D01 v05r02 section 4.3.1 1) page 11. See below for calculations.

Reduced³ – When the reported SAR is >0.4 W/kg, test the next highest configuration until the SAR value is ≤ 0.8 W/kg per KDB 248227 D01 v02 section 5.1.1 2) page 9.

Calculations for test exclusion for Bottom and Left side.

Maximum power: 39.8 mW
 Bottom Edge distance: 210.73 mm
 Left Side distance: 286.45 mm

The closest distance is from the bottom side. Therefore, if the bottom side is excluded the right and laptop would also be excluded.

$$[{\frac{3.0}{\sqrt{5.32}} * 50 \text{ mm}}] + [(210.73 - 50 \text{ mm}) * 10] = 1672 \text{ mW}$$

which is greater than 39.8 mW

**Figure 8.19 Test Reduction Table – 5.2 GHz Main Black Case
Ethernics**

Mode	Side	Required Channel	Tested/Reduced
802.11a 5250 MHz	Back	52 – 5260 MHz	Reduced ¹
		56 – 5280 MHz	Reduced ¹
		60 – 5300 MHz	Tested
		64 – 5320 MHz	Reduced ¹
	Front Edge	52 – 5260 MHz	Reduced ¹
		56 – 5280 MHz	Reduced ¹
		60 – 5300 MHz	Tested
		64 – 5320 MHz	Reduced ¹
	Right, Left, Bottom	52 – 5260 MHz	Reduced ²
		56 – 5280 MHz	Reduced ²
		60 – 5300 MHz	Reduced ²
		64 – 5320 MHz	Reduced ²
802.11n 5250 MHz	Back	52 – 5260 MHz	Reduced ¹
		56 – 5280 MHz	Reduced ¹
		60 – 5300 MHz	Reduced ¹
		64 – 5320 MHz	Reduced ¹
	Front Edge	52 – 5260 MHz	Reduced ¹
		56 – 5280 MHz	Reduced ¹
		60 – 5300 MHz	Reduced ¹
		64 – 5320 MHz	Reduced ¹
	Right, Left, Bottom	52 – 5260 MHz	Reduced ²
		56 – 5280 MHz	Reduced ²
		60 – 5300 MHz	Reduced ²
		64 – 5320 MHz	Reduced ²
802.11ac 5210 MHz	Back	58 – 5290 MHz	Reduced ¹
	Front Edge	58 – 5290 MHz	Reduced ¹
	Right, Left, Bottom	58 – 5290 MHz	Reduced ²

Reduced¹ – When the reported SAR is ≤ 0.4 W/kg, SAR is not required for the remaining test configuration per KDB 248227 D01 v02 section 5.1.1 1) page 9.

Reduced² – When the antenna is more than 25 mm from a side, the test can be reduced per KDB447498 D01 v05r02 section 4.3.1 1) page 11. See below for calculations.

Reduced³ – When the reported SAR is >0.4 W/kg, test the next highest configuration until the SAR value is ≤ 0.8 W/kg per KDB 248227 D01 v02 section 5.1.1 2) page 9.

Calculations for test exclusion for Bottom, Right and Left side.

Maximum power: 39.8 mW
 Bottom Edge distance: 210.73 mm
 Left Side distance: 191.45 mm
 Right Side distance: 101.45 mm

The closest distance is from the right side. Therefore, if the right side is excluded the bottom and left side would also be excluded.

$$[{\frac{3.0}{\sqrt{5.32}}}] * 50 \text{ mm}] + [(101.45 - 50 \text{ mm}) * 10] = 579 \text{ mW}$$

which is greater than 39.8 mW

**Figure 8.20 Test Reduction Table – 5.2 GHz Aux Black Case
Ethernics**

Mode	Side	Required Channel	Tested/Reduced
802.11a 5250 MHz	Back	52 – 5260 MHz	Reduced ¹
		56 – 5280 MHz	Reduced ¹
		60 – 5300 MHz	Tested
		64 – 5320 MHz	Reduced ¹
	Front Edge	52 – 5260 MHz	Reduced ³
		56 – 5280 MHz	Tested
		60 – 5300 MHz	Tested
		64 – 5320 MHz	Reduced ³
	Right	52 – 5260 MHz	Reduced ³
		56 – 5280 MHz	Tested
		60 – 5300 MHz	Tested
		64 – 5320 MHz	Reduced ³
Left, Bottom	52 – 5260 MHz	Reduced ²	
	56 – 5280 MHz	Reduced ²	
	60 – 5300 MHz	Reduced ²	
	64 – 5320 MHz	Reduced ²	
802.11n 5250 MHz	Back	52 – 5260 MHz	Reduced ¹
		56 – 5280 MHz	Reduced ¹
		60 – 5300 MHz	Reduced ¹
		64 – 5320 MHz	Reduced ¹
	Front Edge	52 – 5260 MHz	Reduced ³
		56 – 5280 MHz	Reduced ³
		60 – 5300 MHz	Reduced ³
		64 – 5320 MHz	Reduced ³
	Right	52 – 5260 MHz	Reduced ³
		56 – 5280 MHz	Reduced ³
		60 – 5300 MHz	Reduced ³
		64 – 5320 MHz	Reduced ³
Left, Bottom	52 – 5260 MHz	Reduced ²	
	56 – 5280 MHz	Reduced ²	
	60 – 5300 MHz	Reduced ²	
	64 – 5320 MHz	Reduced ²	
802.11ac 5210 MHz	Back	58 – 5290 MHz	Reduced ¹
	Front Edge	58 – 5290 MHz	Reduced ³
	Right	58 – 5290 MHz	Reduced ³
	Left, Bottom	58 – 5290 MHz	Reduced ²

Reduced¹ – When the reported SAR is ≤ 0.4 W/kg, SAR is not required for the remaining test configuration per KDB 248227 D01 v02 section 5.1.1 1) page 9.

Reduced² – When the antenna is more than 25 mm from a side, the test can be reduced per KDB447498 D01 v05r02 section 4.3.1 1) page 11. See below for calculations.

Reduced³ – When the reported SAR is >0.4 W/kg, test the next highest configuration until the SAR value is ≤ 0.8 W/kg per KDB 248227 D01 v02 section 5.1.1 2) page 9.

Calculations for test exclusion for Bottom and Left side.

Maximum power: 39.8 mW
 Bottom Edge distance: 210.73 mm
 Left Side distance: 286.45 mm

The closest distance is from the bottom side. Therefore, if the bottom side is excluded the right and laptop would also be excluded.

$$[[{(3.0)/(\sqrt{5.32})}*50 \text{ mm}]]+[(210.73-50 \text{ mm})*10]=1672 \text{ mW}$$

which is greater than 39.8 mW

Figure 8.21 Test Reduction Table – 5.2 GHz Main Silver Case HighTek

Mode	Side	Required Channel	Tested/Reduced
802.11a 5250 MHz	Back	52 – 5260 MHz	Reduced ¹
		56 – 5280 MHz	Reduced ¹
		60 – 5300 MHz	Reduced ¹
		64 – 5320 MHz	Reduced ¹
	Front Edge	52 – 5260 MHz	Reduced ¹
		56 – 5280 MHz	Reduced ¹
		60 – 5300 MHz	Tested
		64 – 5320 MHz	Reduced ¹
	Right, Left, Bottom	52 – 5260 MHz	Reduced ²
		56 – 5280 MHz	Reduced ²
		60 – 5300 MHz	Reduced ²
		64 – 5320 MHz	Reduced ²
802.11n 5250 MHz	Back	52 – 5260 MHz	Reduced ¹
		56 – 5280 MHz	Reduced ¹
		60 – 5300 MHz	Reduced ¹
		64 – 5320 MHz	Reduced ¹
	Front Edge	52 – 5260 MHz	Reduced ¹
		56 – 5280 MHz	Reduced ¹
		60 – 5300 MHz	Reduced ¹
		64 – 5320 MHz	Reduced ¹
	Right, Left, Bottom	52 – 5260 MHz	Reduced ²
		56 – 5280 MHz	Reduced ²
		60 – 5300 MHz	Reduced ²
		64 – 5320 MHz	Reduced ²
802.11ac 5210 MHz	Back	58 – 5290 MHz	Reduced ¹
	Front Edge	58 – 5290 MHz	Reduced ¹
	Right, Left, Bottom	58 – 5290 MHz	Reduced ²

Reduced¹ – When the reported SAR is ≤ 0.4 W/kg, SAR is not required for the remaining test configuration per KDB 248227 D01 v02 section 5.1.1 1) page 9.

Reduced² – When the antenna is more than 25 mm from a side, the test can be reduced per KDB447498 D01 v05r02 section 4.3.1 1) page 11. See below for calculations.

Reduced³ – When the reported SAR is >0.8 W/kg, test the next highest configuration until the SAR value is ≤ 1.2 W/kg per KDB 248227 D01 v02 section 5.1.1 3) page 9.

Calculations for test exclusion for Bottom, Right and Left side.

Maximum power: 39.8 mW
 Bottom Edge distance: 210.73 mm
 Left Side distance: 191.45 mm
 Right Side distance: 101.45 mm

The closest distance is from the right side. Therefore, if the right side is excluded the bottom and left side would also be excluded.

$$[[(3.0)/(\sqrt{5.32})]*50 \text{ mm}]+[101.45-50 \text{ mm}]*10]=579 \text{ mW}$$

which is greater than 39.8 mW

Figure 8.22 Test Reduction Table – 5.2 GHz Aux Silver Case HighTek

Mode	Side	Required Channel	Tested/Reduced
802.11a 5250 MHz	Back	52 – 5260 MHz	Reduced ¹
		56 – 5280 MHz	Reduced ¹
		60 – 5300 MHz	Reduced ¹
		64 – 5320 MHz	Reduced ¹
	Front Edge	52 – 5260 MHz	Reduced ¹
		56 – 5280 MHz	Reduced ¹
		60 – 5300 MHz	Tested
		64 – 5320 MHz	Reduced ¹
	Right	52 – 5260 MHz	Reduced ¹
		56 – 5280 MHz	Reduced ¹
		60 – 5300 MHz	Tested
		64 – 5320 MHz	Reduced ¹
Left, Bottom	52 – 5260 MHz	Reduced ²	
	56 – 5280 MHz	Reduced ²	
	60 – 5300 MHz	Reduced ²	
	64 – 5320 MHz	Reduced ²	
802.11n 5250 MHz	Back	52 – 5260 MHz	Reduced ³
		56 – 5280 MHz	Reduced ³
		60 – 5300 MHz	Reduced ³
		64 – 5320 MHz	Reduced ³
	Front Edge	52 – 5260 MHz	Reduced ¹
		56 – 5280 MHz	Reduced ¹
		60 – 5300 MHz	Reduced ¹
		64 – 5320 MHz	Reduced ¹
	Right	52 – 5260 MHz	Reduced ¹
		56 – 5280 MHz	Reduced ¹
		60 – 5300 MHz	Reduced ¹
		64 – 5320 MHz	Reduced ¹
Left, Bottom	52 – 5260 MHz	Reduced ¹	
	56 – 5280 MHz	Reduced ¹	
	60 – 5300 MHz	Reduced ¹	
	64 – 5320 MHz	Reduced ¹	
802.11ac 5210 MHz	Back	58 – 5290 MHz	Reduced ⁴
	Front Edge	58 – 5290 MHz	Reduced ²
	Right	58 – 5290 MHz	Reduced ²
	Left, Bottom	58 – 5290 MHz	Reduced ³

Reduced¹ – When the reported SAR is ≤ 0.4 W/kg, SAR is not required for the remaining test configuration per KDB 248227 D01 v02 section 5.1.1 1) page 9.

Reduced² – When the antenna is more than 25 mm from a side, the test can be reduced per KDB447498 D01 v05r02 section 4.3.1 1) page 11. See below for calculations.

Reduced³ – When the reported SAR is >0.4 W/kg, test the next highest configuration until the SAR value is ≤ 0.8 W/kg per KDB 248227 D01 v02 section 5.1.1 2) page 9.

Calculations for test exclusion for Bottom and Left side.

Maximum power: 39.8 mW
 Bottom Edge distance: 210.73 mm
 Left Side distance: 286.45 mm

The closest distance is from the bottom side. Therefore, if the bottom side is excluded the right and laptop would also be excluded.

$$[{\frac{3.0}{\sqrt{5.32}} * 50 \text{ mm}}] + [(210.73 - 50 \text{ mm}) * 10] = 1672 \text{ mW}$$

which is greater than 39.8 mW

**Figure 8.23 Test Reduction Table – 5.2 GHz Main Silver Case
Ethernics**

Mode	Side	Required Channel	Tested/Reduced
802.11a 5250 MHz	Back	52 – 5260 MHz	Reduced ¹
		56 – 5280 MHz	Reduced ¹
		60 – 5300 MHz	Tested
		64 – 5320 MHz	Reduced ¹
	Front Edge	52 – 5260 MHz	Reduced ¹
		56 – 5280 MHz	Reduced ¹
		60 – 5300 MHz	Tested
		64 – 5320 MHz	Reduced ¹
	Right, Left, Bottom	52 – 5260 MHz	Reduced ²
		56 – 5280 MHz	Reduced ²
		60 – 5300 MHz	Reduced ²
		64 – 5320 MHz	Reduced ²
802.11n 5250 MHz	Back	52 – 5260 MHz	Reduced ¹
		56 – 5280 MHz	Reduced ¹
		60 – 5300 MHz	Reduced ¹
		64 – 5320 MHz	Reduced ¹
	Front Edge	52 – 5260 MHz	Reduced ¹
		56 – 5280 MHz	Reduced ¹
		60 – 5300 MHz	Reduced ¹
		64 – 5320 MHz	Reduced ¹
	Right, Left, Bottom	52 – 5260 MHz	Reduced ²
		56 – 5280 MHz	Reduced ²
		60 – 5300 MHz	Reduced ²
		64 – 5320 MHz	Reduced ²
802.11ac 5210 MHz	Back	58 – 5290 MHz	Reduced ¹
	Front Edge	58 – 5290 MHz	Reduced ¹
	Right, Left, Bottom	58 – 5290 MHz	Reduced ²

Reduced¹ – When the reported SAR is ≤ 0.4 W/kg, SAR is not required for the remaining test configuration per KDB 248227 D01 v02 section 5.1.1 1) page 9.

Reduced² – When the antenna is more than 25 mm from a side, the test can be reduced per KDB447498 D01 v05r02 section 4.3.1 1) page 11. See below for calculations.

Reduced³ – When the reported SAR is >0.4 W/kg, test the next highest configuration until the SAR value is ≤ 0.8 W/kg per KDB 248227 D01 v02 section 5.1.1 2) page 9.

Calculations for test exclusion for Bottom, Right and Left side.

Maximum power: 39.8 mW
 Bottom Edge distance: 210.73 mm
 Left Side distance: 191.45 mm
 Right Side distance: 101.45 mm

The closest distance is from the right side. Therefore, if the right side is excluded the bottom and left side would also be excluded.

$$[{\frac{3.0}{\sqrt{5.32}}}] * 50 \text{ mm}] + [(101.45 - 50 \text{ mm}) * 10] = 579 \text{ mW which is greater than } 39.8 \text{ mW}$$

**Figure 8.24 Test Reduction Table – 5.2 GHz Aux Silver Case
Ethernics**

Mode	Side	Required Channel	Tested/Reduced
802.11a 5250 MHz	Back	52 – 5260 MHz	Reduced ¹
		56 – 5280 MHz	Reduced ¹
		60 – 5300 MHz	Tested
		64 – 5320 MHz	Reduced ¹
	Front Edge	52 – 5260 MHz	Reduced ³
		56 – 5280 MHz	Tested
		60 – 5300 MHz	Tested
		64 – 5320 MHz	Reduced ³
	Right	52 – 5260 MHz	Reduced ³
		56 – 5280 MHz	Tested
		60 – 5300 MHz	Tested
		64 – 5320 MHz	Reduced ³
Left, Bottom	52 – 5260 MHz	Reduced ²	
	56 – 5280 MHz	Reduced ²	
	60 – 5300 MHz	Reduced ²	
	64 – 5320 MHz	Reduced ²	
802.11n 5250 MHz	Back	52 – 5260 MHz	Reduced ¹
		56 – 5280 MHz	Reduced ¹
		60 – 5300 MHz	Reduced ¹
		64 – 5320 MHz	Reduced ¹
	Front Edge	52 – 5260 MHz	Reduced ³
		56 – 5280 MHz	Reduced ³
		60 – 5300 MHz	Reduced ³
		64 – 5320 MHz	Reduced ³
	Right	52 – 5260 MHz	Reduced ³
		56 – 5280 MHz	Reduced ³
		60 – 5300 MHz	Reduced ³
		64 – 5320 MHz	Reduced ³
Left, Bottom	52 – 5260 MHz	Reduced ²	
	56 – 5280 MHz	Reduced ²	
	60 – 5300 MHz	Reduced ²	
	64 – 5320 MHz	Reduced ²	
802.11ac 5210 MHz	Back	58 – 5290 MHz	Reduced ¹
	Front Edge	58 – 5290 MHz	Reduced ³
	Right	58 – 5290 MHz	Reduced ³
	Left, Bottom	58 – 5290 MHz	Reduced ²

Reduced¹ – When the reported SAR is ≤ 0.4 W/kg, SAR is not required for the remaining test configuration per KDB 248227 D01 v02 section 5.1.1 1) page 9.

Reduced² – When the antenna is more than 25 mm from a side, the test can be reduced per KDB447498 D01 v05r02 section 4.3.1 1) page 11. See below for calculations.

Reduced³ – When the reported SAR is >0.4 W/kg, test the next highest configuration until the SAR value is ≤ 0.8 W/kg per KDB 248227 D01 v02 section 5.1.1 2) page 9.

Calculations for test exclusion for Bottom and Left side.

Maximum power: 39.8 mW
 Bottom Edge distance: 210.73 mm
 Left Side distance: 286.45 mm

The closest distance is from the bottom side. Therefore, if the bottom side is excluded the right and laptop would also be excluded.

$$[[{(3.0)/(\sqrt{5.32})}*50 \text{ mm}]]+[(210.73-50 \text{ mm})*10]=1672 \text{ mW}$$

which is greater than 39.8 mW

Figure 8.25 Test Reduction Table – 5.6 GHz Main Black Case HighTek

Mode	Side	Required Channel	Tested/Reduced
802.11a 5600 MHz	Back	100 – 5500 MHz	Reduced ¹
		104 – 5520 MHz	Reduced ¹
		108 – 5540 MHz	Reduced ¹
		112 – 5560 MHz	Reduced ¹
		116 – 5580 MHz	Reduced ¹
		120 – 5600 MHz	Reduced ¹
		124 – 5620 MHz	Reduced ¹
		128 – 5640 MHz	Reduced ¹
		132 – 5660 MHz	Reduced ¹
	Front Edge	136 – 5680 MHz	Reduced ¹
		140 – 5700 MHz	Reduced ¹
		100 – 5500 MHz	Reduced ¹
		104 – 5520 MHz	Reduced ¹
		108 – 5540 MHz	Reduced ¹
		112 – 5560 MHz	Reduced ¹
		116 – 5580 MHz	Reduced ¹
		120 – 5600 MHz	Reduced ¹
		124 – 5620 MHz	Tested
	Right, Left, Bottom	128 – 5640 MHz	Reduced ¹
		132 – 5660 MHz	Reduced ¹
		136 – 5680 MHz	Reduced ¹
		140 – 5700 MHz	Reduced ¹
		100 – 5500 MHz	Reduced ³
		104 – 5520 MHz	Reduced ³
		108 – 5540 MHz	Reduced ³
		112 – 5560 MHz	Reduced ³
		116 – 5580 MHz	Reduced ³
120 – 5600 MHz	Reduced ³		
124 – 5620 MHz	Reduced ³		
128 – 5640 MHz	Reduced ³		
132 – 5660 MHz	Reduced ³		
136 – 5680 MHz	Reduced ³		
140 – 5700 MHz	Reduced ³		

Reduced¹ – When the reported SAR is ≤ 0.4 W/kg, SAR is not required for the remaining test configuration per KDB 248227 D01 v02 section 5.1.1 1) page 9.

Reduced² – When the reported SAR is >0.8 W/kg, test the next highest configuration until the SAR value is ≤ 1.2 W/kg per KDB 248227 D01 v02 section 5.1.1 3) page 9.

Reduced³ – When the antenna is more than 25 mm from a side, the test can be reduced per KDB447498 D01 v05r02 section 4.3.1 1) page 11. See below for calculations.

Calculations for test exclusion for Bottom, Right and Left side.

Maximum power: 39.8 mW
 Bottom Edge distance: 210.73 mm
 Left Side distance: 191.45 mm
 Right Side distance: 101.45 mm

The closest distance is from the right side. Therefore, if the right side is excluded the bottom and left side would also be excluded.

$$[[(3.0)/(\sqrt{5.70})]^*50 \text{ mm}]+[101.45-50 \text{ mm}]^*10=577 \text{ mW which is greater than } 39.8 \text{ mW}$$

Figure 8.26 Test Reduction Table – 5.6 GHz Main Black Case HighTek

Mode	Side	Required Channel	Tested/Reduced
802.11n 5600 MHz	Back	100 – 5500 MHz	Reduced ¹
		104 – 5520 MHz	Reduced ¹
		108 – 5540 MHz	Reduced ¹
		112 – 5560 MHz	Reduced ¹
		116 – 5580 MHz	Reduced ¹
		120 – 5600 MHz	Reduced ¹
		124 – 5620 MHz	Reduced ¹
		128 – 5640 MHz	Reduced ¹
		132 – 5660 MHz	Reduced ¹
	Front Edge	136 – 5680 MHz	Reduced ¹
		140 – 5700 MHz	Reduced ¹
		100 – 5500 MHz	Reduced ¹
		104 – 5520 MHz	Reduced ¹
		108 – 5540 MHz	Reduced ¹
		112 – 5560 MHz	Reduced ¹
		116 – 5580 MHz	Reduced ¹
		120 – 5600 MHz	Reduced ¹
		124 – 5620 MHz	Reduced ¹
	Right, Left, Bottom	128 – 5640 MHz	Reduced ¹
		132 – 5660 MHz	Reduced ¹
		136 – 5680 MHz	Reduced ¹
		140 – 5700 MHz	Reduced ¹
		100 – 5500 MHz	Reduced ³
		104 – 5520 MHz	Reduced ³
		108 – 5540 MHz	Reduced ³
		112 – 5560 MHz	Reduced ³
		116 – 5580 MHz	Reduced ³
802.11ac 5600 MHz	Back	120 – 5600 MHz	Reduced ³
		124 – 5620 MHz	Reduced ³
		128 – 5640 MHz	Reduced ³
	Front Edge	132 – 5660 MHz	Reduced ³
		136 – 5680 MHz	Reduced ³
		140 – 5700 MHz	Reduced ³
	Right, Left, Bottom	106 – 5530 MHz	Reduced ¹
		122 – 5610 MHz	Reduced ¹
		138 – 5690 MHz	Reduced ¹
106 – 5530 MHz	Reduced ³		
122 – 5610 MHz	Reduced ³		
138 – 5690 MHz	Reduced ³		

Reduced¹ – When the reported SAR is ≤ 0.4 W/kg, SAR is not required for the remaining test configuration per KDB 248227 D01 v02 section 5.1.1 1) page 9.

Reduced² – When the reported SAR is >0.8 W/kg, test the next highest configuration until the SAR value is ≤ 1.2 W/kg per KDB 248227 D01 v02 section 5.1.1 3) page 9.

Reduced³ – When the antenna is more than 25 mm from a side, the test can be reduced per KDB447498 D01 v05r02 section 4.3.1 1) page 11. See above for calculations.

Figure 8.27 Test Reduction Table – 5.6 GHz Aux Black Case HighTek

Mode	Side	Required Channel	Tested/Reduced
802.11a 5600 MHz	Back	100 – 5500 MHz	Reduced ¹
		104 – 5520 MHz	Reduced ¹
		108 – 5540 MHz	Reduced ¹
		112 – 5560 MHz	Reduced ¹
		116 – 5580 MHz	Reduced ¹
		120 – 5600 MHz	Reduced ¹
		124 – 5620 MHz	Reduced ¹
		128 – 5640 MHz	Reduced ¹
		132 – 5660 MHz	Reduced ¹
		136 – 5680 MHz	Reduced ¹
	140 – 5700 MHz	Reduced ¹	
	Front Edge	100 – 5500 MHz	Reduced ¹
		104 – 5520 MHz	Reduced ¹
		108 – 5540 MHz	Reduced ¹
		112 – 5560 MHz	Reduced ¹
		116 – 5580 MHz	Reduced ¹
		120 – 5600 MHz	Reduced ¹
		124 – 5620 MHz	Tested
		128 – 5640 MHz	Reduced ¹
		132 – 5660 MHz	Reduced ¹
		136 – 5680 MHz	Reduced ¹
	140 – 5700 MHz	Reduced ¹	
	Right	100 – 5500 MHz	Reduced ¹
		104 – 5520 MHz	Reduced ¹
		108 – 5540 MHz	Reduced ¹
		112 – 5560 MHz	Reduced ¹
		116 – 5580 MHz	Reduced ¹
		120 – 5600 MHz	Reduced ¹
		124 – 5620 MHz	Tested
		128 – 5640 MHz	Reduced ¹
		132 – 5660 MHz	Reduced ¹
		136 – 5680 MHz	Reduced ¹
	140 – 5700 MHz	Reduced ¹	
	Left, Bottom	100 – 5500 MHz	Reduced ³
		104 – 5520 MHz	Reduced ³
		108 – 5540 MHz	Reduced ³
		112 – 5560 MHz	Reduced ³
		116 – 5580 MHz	Reduced ³
		120 – 5600 MHz	Reduced ³
		124 – 5620 MHz	Reduced ³
128 – 5640 MHz		Reduced ³	
132 – 5660 MHz		Reduced ³	
136 – 5680 MHz		Reduced ³	
140 – 5700 MHz	Reduced ³		

Reduced¹ – When the reported SAR is ≤ 0.4 W/kg, SAR is not required for the remaining test configuration per KDB 248227 D01 v02 section 5.1.1 1) page 9.

Reduced² – When the reported SAR is > 0.4 W/kg, test next highest output power channel until SAR ≤ 0.8 W/kg then all remaining test configurations are not required per KDB 248227 D01 v02 section 5.1.1 2) page 9.

Reduced³ – When the antenna is more than 25 mm from a side, the test can be reduced per KDB447498 D01 v05r02 section 4.3.1 1) page 11. See below for calculations.

Calculations for test exclusion for Bottom and Left side.

Maximum power: 39.8 mW
 Bottom Edge distance: 210.73 mm
 Left Side distance: 286.45 mm

The closest distance is from the bottom side. Therefore, if the bottom side is excluded the right and laptop would also be excluded.

$$[[(3.0)/(\sqrt{5.70})]*50 \text{ mm}]+[210.73-50 \text{ mm}]*10]=1670 \text{ mW}$$

which is greater than 39.8 mW

Figure 8.28 Test Reduction Table – 5.6 GHz Aux Black Case HighTek

Mode	Side	Required Channel	Tested/Reduced
802.11a 5600 MHz	Back	100 – 5500 MHz	Reduced ¹
		104 – 5520 MHz	Reduced ¹
		108 – 5540 MHz	Reduced ¹
		112 – 5560 MHz	Reduced ¹
		116 – 5580 MHz	Reduced ¹
		120 – 5600 MHz	Reduced ¹
		124 – 5620 MHz	Reduced ¹
		128 – 5640 MHz	Reduced ¹
		132 – 5660 MHz	Reduced ¹
	Front Edge	136 – 5680 MHz	Reduced ¹
		140 – 5700 MHz	Reduced ¹
		100 – 5500 MHz	Reduced ¹
		104 – 5520 MHz	Reduced ¹
		108 – 5540 MHz	Reduced ¹
		112 – 5560 MHz	Reduced ¹
		116 – 5580 MHz	Reduced ¹
		120 – 5600 MHz	Reduced ¹
		124 – 5620 MHz	Reduced ¹
	Right	128 – 5640 MHz	Reduced ¹
		132 – 5660 MHz	Reduced ¹
		136 – 5680 MHz	Reduced ¹
		140 – 5700 MHz	Reduced ¹
		100 – 5500 MHz	Reduced ¹
		104 – 5520 MHz	Reduced ¹
		108 – 5540 MHz	Reduced ¹
		112 – 5560 MHz	Reduced ¹
		116 – 5580 MHz	Reduced ¹
	Left, Bottom	120 – 5600 MHz	Reduced ¹
		124 – 5620 MHz	Reduced ¹
		128 – 5640 MHz	Reduced ¹
		132 – 5660 MHz	Reduced ¹
		136 – 5680 MHz	Reduced ¹
		140 – 5700 MHz	Reduced ¹
		100 – 5500 MHz	Reduced ³
		104 – 5520 MHz	Reduced ³
		108 – 5540 MHz	Reduced ³
802.11ac 5600 MHz	Back	112 – 5560 MHz	Reduced ³
		116 – 5580 MHz	Reduced ³
		120 – 5600 MHz	Reduced ³
	Front Edge	124 – 5620 MHz	Reduced ³
		128 – 5640 MHz	Reduced ³
		132 – 5660 MHz	Reduced ³
	Right	136 – 5680 MHz	Reduced ³
		140 – 5700 MHz	Reduced ³
		106 – 5530 MHz	Reduced ¹
	Left, Bottom	122 – 5610 MHz	Reduced ¹
		138 – 5690 MHz	Reduced ¹
		106 – 5530 MHz	Reduced ¹
122 – 5610 MHz		Reduced ¹	
138 – 5690 MHz		Reduced ¹	
106 – 5530 MHz		Reduced ¹	
Left, Bottom	122 – 5610 MHz	Reduced ³	
	138 – 5690 MHz	Reduced ³	
	106 – 5530 MHz	Reduced ³	

Reduced¹ – When the reported SAR is ≤ 0.4 W/kg, SAR is not required for the remaining test configuration per KDB 248227 D01 v02 section 5.1.1 1) page 9.

Reduced² – When the reported SAR is > 0.4 W/kg, test next highest output power channel until SAR ≤ 0.8 W/kg then all remaining test configurations are not required per KDB 248227 D01 v02 section 5.1.1 2) page 9.

Reduced³ – When the antenna is more than 25 mm from a side, the test can be reduced per KDB447498 D01 v05r02 section 4.3.1 1) page 11. See above for calculations.

**Figure 8.29 Test Reduction Table – 5.6 GHz Main Black Case
Ethertronics**

Mode	Side	Required Channel	Tested/Reduced
802.11a 5600 MHz	Back	100 – 5500 MHz	Reduced ¹
		104 – 5520 MHz	Reduced ¹
		108 – 5540 MHz	Reduced ¹
		112 – 5560 MHz	Reduced ¹
		116 – 5580 MHz	Reduced ¹
		120 – 5600 MHz	Reduced ¹
		124 – 5620 MHz	Tested
		128 – 5640 MHz	Reduced ¹
		132 – 5660 MHz	Reduced ¹
		136 – 5680 MHz	Reduced ¹
	140 – 5700 MHz	Reduced ¹	
	Front Edge	100 – 5500 MHz	Reduced ²
		104 – 5520 MHz	Reduced ²
		108 – 5540 MHz	Reduced ²
		112 – 5560 MHz	Reduced ²
		116 – 5580 MHz	Tested
		120 – 5600 MHz	Reduced ²
		124 – 5620 MHz	Tested
		128 – 5640 MHz	Reduced ²
		132 – 5660 MHz	Reduced ²
		136 – 5680 MHz	Reduced ²
	140 – 5700 MHz	Reduced ²	
	Right, Left, Bottom	100 – 5500 MHz	Reduced ³
		104 – 5520 MHz	Reduced ³
		108 – 5540 MHz	Reduced ³
		112 – 5560 MHz	Reduced ³
		116 – 5580 MHz	Reduced ³
		120 – 5600 MHz	Reduced ³
		124 – 5620 MHz	Reduced ³
		128 – 5640 MHz	Reduced ³
132 – 5660 MHz		Reduced ³	
136 – 5680 MHz		Reduced ³	
140 – 5700 MHz	Reduced ³		

Reduced¹ – When the reported SAR is ≤ 0.4 W/kg, SAR is not required for the remaining test configuration per KDB 248227 D01 v02 section 5.1.1 1) page 9.

Reduced² – When the reported SAR is >0.4 W/kg, test the next highest configuration until the SAR value is ≤ 0.8 W/kg per KDB 248227 D01 v02 section 5.1.1 2) page 9.

Reduced³ – When the antenna is more than 25 mm from a side, the test can be reduced per KDB447498 D01 v05r02 section 4.3.1 1) page 11. See below for calculations.

Calculations for test exclusion for Bottom, Right and Left side.

Maximum power: 39.8 mW
 Bottom Edge distance: 210.73 mm
 Left Side distance: 191.45 mm
 Right Side distance: 101.45 mm

The closest distance is from the right side. Therefore, if the right side is excluded the bottom and left side would also be excluded.

$$[{\{(3.0)/(\sqrt{5.70})\} * 50 \text{ mm}}] + [{\{101.45 - 50 \text{ mm}\} * 10}] = 577 \text{ mW which is greater than } 39.8 \text{ mW}$$

**Figure 8.30 Test Reduction Table – 5.6 GHz Main Black Case
Ethertronics**

Mode	Side	Required Channel	Tested/Reduced
802.11n 5600 MHz	Back	100 – 5500 MHz	Reduced ¹
		104 – 5520 MHz	Reduced ¹
		108 – 5540 MHz	Reduced ¹
		112 – 5560 MHz	Reduced ¹
		116 – 5580 MHz	Reduced ¹
		120 – 5600 MHz	Reduced ¹
		124 – 5620 MHz	Reduced ¹
		128 – 5640 MHz	Reduced ¹
		132 – 5660 MHz	Reduced ¹
		136 – 5680 MHz	Reduced ¹
	140 – 5700 MHz	Reduced ¹	
	Front Edge	100 – 5500 MHz	Reduced ²
		104 – 5520 MHz	Reduced ²
		108 – 5540 MHz	Reduced ²
		112 – 5560 MHz	Reduced ²
		116 – 5580 MHz	Reduced ²
		120 – 5600 MHz	Reduced ²
		124 – 5620 MHz	Reduced ²
		128 – 5640 MHz	Reduced ²
		132 – 5660 MHz	Reduced ²
		136 – 5680 MHz	Reduced ²
	140 – 5700 MHz	Reduced ²	
	Right, Left, Bottom	100 – 5500 MHz	Reduced ³
		104 – 5520 MHz	Reduced ³
		108 – 5540 MHz	Reduced ³
		112 – 5560 MHz	Reduced ³
		116 – 5580 MHz	Reduced ³
		120 – 5600 MHz	Reduced ³
		124 – 5620 MHz	Reduced ³
		128 – 5640 MHz	Reduced ³
132 – 5660 MHz		Reduced ³	
136 – 5680 MHz		Reduced ³	
140 – 5700 MHz	Reduced ³		
802.11ac 5600 MHz	Back	106 – 5530 MHz	Reduced ¹
		122 – 5610 MHz	Reduced ¹
		138 – 5690 MHz	Reduced ¹
	Front Edge	106 – 5530 MHz	Reduced ²
		122 – 5610 MHz	Reduced ²
		138 – 5690 MHz	Reduced ²
	Right, Left, Bottom	106 – 5530 MHz	Reduced ³
		122 – 5610 MHz	Reduced ³
		138 – 5690 MHz	Reduced ³

Reduced¹ – When the reported SAR is ≤ 0.4 W/kg, SAR is not required for the remaining test configuration per KDB 248227 D01 v02 section 5.1.1 1) page 9.

Reduced² – When the reported SAR is >0.8 W/kg, test the next highest configuration until the SAR value is ≤ 1.2 W/kg per KDB 248227 D01 v02 section 5.1.1 3) page 9.

Reduced³ – When the antenna is more than 25 mm from a side, the test can be reduced per KDB447498 D01 v05r02 section 4.3.1 1) page 11. See above for calculations.

**Figure 8.31 Test Reduction Table – 5.6 GHz Aux Black Case
Ethertronics**

Mode	Side	Required Channel	Tested/Reduced
802.11a 5600 MHz	Back	100 – 5500 MHz	Reduced ¹
		104 – 5520 MHz	Reduced ¹
		108 – 5540 MHz	Reduced ¹
		112 – 5560 MHz	Reduced ¹
		116 – 5580 MHz	Tested
		120 – 5600 MHz	Reduced ¹
		124 – 5620 MHz	Tested
		128 – 5640 MHz	Reduced ¹
		132 – 5660 MHz	Reduced ¹
		136 – 5680 MHz	Reduced ¹
	140 – 5700 MHz	Reduced ¹	
	Front Edge	100 – 5500 MHz	Reduced ²
		104 – 5520 MHz	Reduced ²
		108 – 5540 MHz	Reduced ²
		112 – 5560 MHz	Reduced ²
		116 – 5580 MHz	Tested
		120 – 5600 MHz	Reduced ²
		124 – 5620 MHz	Tested
		128 – 5640 MHz	Reduced ²
		132 – 5660 MHz	Reduced ²
		136 – 5680 MHz	Reduced ²
	140 – 5700 MHz	Reduced ²	
	Right	100 – 5500 MHz	Reduced ²
		104 – 5520 MHz	Reduced ²
		108 – 5540 MHz	Reduced ²
		112 – 5560 MHz	Reduced ²
		116 – 5580 MHz	Tested
		120 – 5600 MHz	Reduced ²
		124 – 5620 MHz	Tested
		128 – 5640 MHz	Reduced ²
		132 – 5660 MHz	Reduced ²
		136 – 5680 MHz	Reduced ²
	140 – 5700 MHz	Reduced ²	
	Left, Bottom	100 – 5500 MHz	Reduced ³
		104 – 5520 MHz	Reduced ³
		108 – 5540 MHz	Reduced ³
		112 – 5560 MHz	Reduced ³
		116 – 5580 MHz	Reduced ³
		120 – 5600 MHz	Reduced ³
		124 – 5620 MHz	Reduced ³
128 – 5640 MHz		Reduced ³	
132 – 5660 MHz		Reduced ³	
136 – 5680 MHz		Reduced ³	
140 – 5700 MHz	Reduced ³		

Reduced¹ – When the reported SAR is > 0.4 W/kg, test next highest output power channel until SAR ≤ 0.8 W/kg then all remaining test configurations are not required per KDB 248227 D01 v02 section 5.1.1 2) page 9.

Reduced² – When the reported SAR is > 0.8 W/kg, test next highest output power channel until SAR ≤ 1.2 W/kg then all remaining test configurations are not required per KDB 248227 D01 v02 section 5.1.1 3) page 9.

Reduced³ – When the antenna is more than 25 mm from a side, the test can be reduced per KDB447498 D01 v05r02 section 4.3.1 1) page 11. See below for calculations.

Calculations for test exclusion for Bottom and Left side.

Maximum power: 39.8 mW
 Bottom Edge distance: 210.73 mm
 Left Side distance: 286.45 mm

The closest distance is from the bottom side. Therefore, if the bottom side is excluded the right and laptop would also be excluded.

$$[[(3.0)/(\sqrt{5.70})]*50 \text{ mm}]+[210.73-50 \text{ mm}]*10]=1670 \text{ mW}$$

which is greater than 39.8 mW

**Figure 8.32 Test Reduction Table – 5.6 GHz Aux Black Case
Ethertronics**

Mode	Side	Required Channel	Tested/Reduced
802.11a 5600 MHz	Back	100 – 5500 MHz	Reduced ¹
		104 – 5520 MHz	Reduced ¹
		108 – 5540 MHz	Reduced ¹
		112 – 5560 MHz	Reduced ¹
		116 – 5580 MHz	Reduced ¹
		120 – 5600 MHz	Reduced ¹
		124 – 5620 MHz	Reduced ¹
		128 – 5640 MHz	Reduced ¹
		132 – 5660 MHz	Reduced ¹
		136 – 5680 MHz	Reduced ¹
	140 – 5700 MHz	Reduced ¹	
	Front Edge	100 – 5500 MHz	Reduced ²
		104 – 5520 MHz	Reduced ²
		108 – 5540 MHz	Reduced ²
		112 – 5560 MHz	Reduced ²
		116 – 5580 MHz	Reduced ²
		120 – 5600 MHz	Reduced ²
		124 – 5620 MHz	Reduced ²
		128 – 5640 MHz	Reduced ²
		132 – 5660 MHz	Reduced ²
		136 – 5680 MHz	Reduced ²
	140 – 5700 MHz	Reduced ²	
	Right	100 – 5500 MHz	Reduced ²
		104 – 5520 MHz	Reduced ²
		108 – 5540 MHz	Reduced ²
		112 – 5560 MHz	Reduced ²
		116 – 5580 MHz	Reduced ²
		120 – 5600 MHz	Reduced ²
		124 – 5620 MHz	Reduced ²
		128 – 5640 MHz	Reduced ²
		132 – 5660 MHz	Reduced ²
		136 – 5680 MHz	Reduced ²
	140 – 5700 MHz	Reduced ²	
	Left, Bottom	100 – 5500 MHz	Reduced ³
		104 – 5520 MHz	Reduced ³
		108 – 5540 MHz	Reduced ³
112 – 5560 MHz		Reduced ³	
116 – 5580 MHz		Reduced ³	
120 – 5600 MHz		Reduced ³	
124 – 5620 MHz		Reduced ³	
128 – 5640 MHz		Reduced ³	
132 – 5660 MHz		Reduced ³	
136 – 5680 MHz		Reduced ³	
140 – 5700 MHz	Reduced ³		
802.11ac 5600 MHz	Back	106 – 5530 MHz	Reduced ¹
		122 – 5610 MHz	Reduced ¹
		138 – 5690 MHz	Reduced ¹
	Front Edge	106 – 5530 MHz	Reduced ²
		122 – 5610 MHz	Reduced ²
		138 – 5690 MHz	Reduced ²
	Right	106 – 5530 MHz	Reduced ²
		122 – 5610 MHz	Reduced ²
		138 – 5690 MHz	Reduced ²
	Left, Bottom	106 – 5530 MHz	Reduced ³
		122 – 5610 MHz	Reduced ³
		138 – 5690 MHz	Reduced ³

Reduced¹ – When the reported SAR is ≤ 0.4 W/kg, SAR is not required for the remaining test configuration per KDB 248227 D01 v02 section 5.1.1 1) page 9.

Reduced² – When the reported SAR is > 0.4 W/kg, test next highest output power channel until SAR ≤ 0.8 W/kg then all remaining test configurations are not required per KDB 248227 D01 v02 section 5.1.1 2) page 9.

Reduced³ – When the antenna is more than 25 mm from a side, the test can be reduced per KDB447498 D01 v05r02 section 4.3.1 1) page 11. See above for calculations.

Figure 8.33 Test Reduction Table – 5.6 GHz Main Silver Case HighTek

Mode	Side	Required Channel	Tested/Reduced
802.11a 5600 MHz	Back	100 – 5500 MHz	Reduced ¹
		104 – 5520 MHz	Reduced ¹
		108 – 5540 MHz	Reduced ¹
		112 – 5560 MHz	Reduced ¹
		116 – 5580 MHz	Reduced ¹
		120 – 5600 MHz	Reduced ¹
		124 – 5620 MHz	Reduced ¹
		128 – 5640 MHz	Reduced ¹
		132 – 5660 MHz	Reduced ¹
	Front Edge	136 – 5680 MHz	Reduced ¹
		140 – 5700 MHz	Reduced ¹
		100 – 5500 MHz	Reduced ¹
		104 – 5520 MHz	Reduced ¹
		108 – 5540 MHz	Reduced ¹
		112 – 5560 MHz	Reduced ¹
		116 – 5580 MHz	Reduced ¹
		120 – 5600 MHz	Reduced ¹
		124 – 5620 MHz	Tested
	Right, Left, Bottom	128 – 5640 MHz	Reduced ¹
		132 – 5660 MHz	Reduced ¹
		136 – 5680 MHz	Reduced ¹
		140 – 5700 MHz	Reduced ¹
		100 – 5500 MHz	Reduced ³
		104 – 5520 MHz	Reduced ³
		108 – 5540 MHz	Reduced ³
		112 – 5560 MHz	Reduced ³
		116 – 5580 MHz	Reduced ³
120 – 5600 MHz	Reduced ³		
124 – 5620 MHz	Reduced ³		
128 – 5640 MHz	Reduced ³		
132 – 5660 MHz	Reduced ³		
136 – 5680 MHz	Reduced ³		
140 – 5700 MHz	Reduced ³		

Reduced¹ – When the reported SAR is ≤ 0.4 W/kg, SAR is not required for the remaining test configuration per KDB 248227 D01 v02 section 5.1.1 1) page 9.

Reduced² – When the reported SAR is >0.8 W/kg, test the next highest configuration until the SAR value is ≤ 1.2 W/kg per KDB 248227 D01 v02 section 5.1.1 3) page 9.

Reduced³ – When the antenna is more than 25 mm from a side, the test can be reduced per KDB447498 D01 v05r02 section 4.3.1 1) page 11. See below for calculations.

Calculations for test exclusion for Bottom, Right and Left side.

Maximum power: 39.8 mW
 Bottom Edge distance: 210.73 mm
 Left Side distance: 191.45 mm
 Right Side distance: 101.45 mm

The closest distance is from the right side. Therefore, if the right side is excluded the bottom and left side would also be excluded.

$$[[(3.0)/(\sqrt{5.70})]^*50 \text{ mm}]+[101.45-50 \text{ mm}]^*10=577 \text{ mW which is greater than } 39.8 \text{ mW}$$

Figure 8.34 Test Reduction Table – 5.6 GHz Main Silver Case HighTek

Mode	Side	Required Channel	Tested/Reduced
802.11n 5600 MHz	Back	100 – 5500 MHz	Reduced ¹
		104 – 5520 MHz	Reduced ¹
		108 – 5540 MHz	Reduced ¹
		112 – 5560 MHz	Reduced ¹
		116 – 5580 MHz	Reduced ¹
		120 – 5600 MHz	Reduced ¹
		124 – 5620 MHz	Reduced ¹
		128 – 5640 MHz	Reduced ¹
		132 – 5660 MHz	Reduced ¹
	Front Edge	136 – 5680 MHz	Reduced ¹
		140 – 5700 MHz	Reduced ¹
		100 – 5500 MHz	Reduced ¹
		104 – 5520 MHz	Reduced ¹
		108 – 5540 MHz	Reduced ¹
		112 – 5560 MHz	Reduced ¹
		116 – 5580 MHz	Reduced ¹
		120 – 5600 MHz	Reduced ¹
		124 – 5620 MHz	Reduced ¹
	Right, Left, Bottom	128 – 5640 MHz	Reduced ¹
		132 – 5660 MHz	Reduced ¹
		136 – 5680 MHz	Reduced ¹
		140 – 5700 MHz	Reduced ¹
		100 – 5500 MHz	Reduced ³
		104 – 5520 MHz	Reduced ³
		108 – 5540 MHz	Reduced ³
		112 – 5560 MHz	Reduced ³
		116 – 5580 MHz	Reduced ³
802.11ac 5600 MHz	Back	120 – 5600 MHz	Reduced ³
		124 – 5620 MHz	Reduced ³
		128 – 5640 MHz	Reduced ³
	Front Edge	132 – 5660 MHz	Reduced ³
		136 – 5680 MHz	Reduced ³
		140 – 5700 MHz	Reduced ³
	Right, Left, Bottom	106 – 5530 MHz	Reduced ¹
		122 – 5610 MHz	Reduced ¹
		138 – 5690 MHz	Reduced ¹
106 – 5530 MHz	Reduced ³		
122 – 5610 MHz	Reduced ³		
138 – 5690 MHz	Reduced ³		

Reduced¹ – When the reported SAR is ≤ 0.4 W/kg, SAR is not required for the remaining test configuration per KDB 248227 D01 v02 section 5.1.1 1) page 9.

Reduced² – When the reported SAR is >0.8 W/kg, test the next highest configuration until the SAR value is ≤ 1.2 W/kg per KDB 248227 D01 v02 section 5.1.1 3) page 9.

Reduced³ – When the antenna is more than 25 mm from a side, the test can be reduced per KDB447498 D01 v05r02 section 4.3.1 1) page 11. See above for calculations.

Figure 8.35 Test Reduction Table – 5.6 GHz Aux Silver Case HighTek

Mode	Side	Required Channel	Tested/Reduced
802.11a 5600 MHz	Back	100 – 5500 MHz	Reduced ¹
		104 – 5520 MHz	Reduced ¹
		108 – 5540 MHz	Reduced ¹
		112 – 5560 MHz	Reduced ¹
		116 – 5580 MHz	Reduced ¹
		120 – 5600 MHz	Reduced ¹
		124 – 5620 MHz	Reduced ¹
		128 – 5640 MHz	Reduced ¹
		132 – 5660 MHz	Reduced ¹
		136 – 5680 MHz	Reduced ¹
	140 – 5700 MHz	Reduced ¹	
	Front Edge	100 – 5500 MHz	Reduced ¹
		104 – 5520 MHz	Reduced ¹
		108 – 5540 MHz	Reduced ¹
		112 – 5560 MHz	Reduced ¹
		116 – 5580 MHz	Reduced ¹
		120 – 5600 MHz	Reduced ¹
		124 – 5620 MHz	Tested
		128 – 5640 MHz	Reduced ¹
		132 – 5660 MHz	Reduced ¹
		136 – 5680 MHz	Reduced ¹
	140 – 5700 MHz	Reduced ¹	
	Right	100 – 5500 MHz	Reduced ¹
		104 – 5520 MHz	Reduced ¹
		108 – 5540 MHz	Reduced ¹
		112 – 5560 MHz	Reduced ¹
		116 – 5580 MHz	Reduced ¹
		120 – 5600 MHz	Reduced ¹
		124 – 5620 MHz	Tested
		128 – 5640 MHz	Reduced ¹
		132 – 5660 MHz	Reduced ¹
		136 – 5680 MHz	Reduced ¹
	140 – 5700 MHz	Reduced ¹	
	Left, Bottom	100 – 5500 MHz	Reduced ³
		104 – 5520 MHz	Reduced ³
		108 – 5540 MHz	Reduced ³
		112 – 5560 MHz	Reduced ³
		116 – 5580 MHz	Reduced ³
		120 – 5600 MHz	Reduced ³
		124 – 5620 MHz	Reduced ³
128 – 5640 MHz		Reduced ³	
132 – 5660 MHz		Reduced ³	
136 – 5680 MHz		Reduced ³	
140 – 5700 MHz	Reduced ³		

Reduced¹ – When the reported SAR is ≤ 0.4 W/kg, SAR is not required for the remaining test configuration per KDB 248227 D01 v02 section 5.1.1 1) page 9.

Reduced² – When the reported SAR is > 0.4 W/kg, test next highest output power channel until SAR ≤ 0.8 W/kg then all remaining test configurations are not required per KDB 248227 D01 v02 section 5.1.1 2) page 9.

Reduced³ – When the antenna is more than 25 mm from a side, the test can be reduced per KDB447498 D01 v05r02 section 4.3.1 1) page 11. See below for calculations.

Calculations for test exclusion for Bottom and Left side.

Maximum power: 39.8 mW
 Bottom Edge distance: 210.73 mm
 Left Side distance: 286.45 mm

The closest distance is from the bottom side. Therefore, if the bottom side is excluded the right and laptop would also be excluded.

$$[[(3.0)/(\sqrt{5.70})]*50 \text{ mm}]+[210.73-50 \text{ mm}]*10]=1670 \text{ mW}$$

which is greater than 39.8 mW

Figure 8.36 Test Reduction Table – 5.6 GHz Aux Silver Case HighTek

Mode	Side	Required Channel	Tested/Reduced
802.11a 5600 MHz	Back	100 – 5500 MHz	Reduced ¹
		104 – 5520 MHz	Reduced ¹
		108 – 5540 MHz	Reduced ¹
		112 – 5560 MHz	Reduced ¹
		116 – 5580 MHz	Reduced ¹
		120 – 5600 MHz	Reduced ¹
		124 – 5620 MHz	Reduced ¹
		128 – 5640 MHz	Reduced ¹
		132 – 5660 MHz	Reduced ¹
	Front Edge	136 – 5680 MHz	Reduced ¹
		140 – 5700 MHz	Reduced ¹
		100 – 5500 MHz	Reduced ¹
		104 – 5520 MHz	Reduced ¹
		108 – 5540 MHz	Reduced ¹
		112 – 5560 MHz	Reduced ¹
		116 – 5580 MHz	Reduced ¹
		120 – 5600 MHz	Reduced ¹
		124 – 5620 MHz	Reduced ¹
	Right	128 – 5640 MHz	Reduced ¹
		132 – 5660 MHz	Reduced ¹
		136 – 5680 MHz	Reduced ¹
		140 – 5700 MHz	Reduced ¹
		100 – 5500 MHz	Reduced ¹
		104 – 5520 MHz	Reduced ¹
		108 – 5540 MHz	Reduced ¹
		112 – 5560 MHz	Reduced ¹
		116 – 5580 MHz	Reduced ¹
	Left, Bottom	120 – 5600 MHz	Reduced ¹
		124 – 5620 MHz	Reduced ¹
		128 – 5640 MHz	Reduced ¹
		132 – 5660 MHz	Reduced ¹
		136 – 5680 MHz	Reduced ¹
		140 – 5700 MHz	Reduced ¹
		100 – 5500 MHz	Reduced ³
		104 – 5520 MHz	Reduced ³
		108 – 5540 MHz	Reduced ³
802.11ac 5600 MHz	Back	112 – 5560 MHz	Reduced ³
		116 – 5580 MHz	Reduced ³
		120 – 5600 MHz	Reduced ³
	Front Edge	124 – 5620 MHz	Reduced ³
		128 – 5640 MHz	Reduced ³
		132 – 5660 MHz	Reduced ³
	Right	136 – 5680 MHz	Reduced ³
		140 – 5700 MHz	Reduced ³
		106 – 5530 MHz	Reduced ¹
	Left, Bottom	122 – 5610 MHz	Reduced ¹
		138 – 5690 MHz	Reduced ¹
		106 – 5530 MHz	Reduced ¹
122 – 5610 MHz		Reduced ¹	
138 – 5690 MHz		Reduced ¹	
106 – 5530 MHz		Reduced ¹	
Left, Bottom	122 – 5610 MHz	Reduced ³	
	138 – 5690 MHz	Reduced ³	
	138 – 5690 MHz	Reduced ³	

Reduced¹ – When the reported SAR is ≤ 0.4 W/kg, SAR is not required for the remaining test configuration per KDB 248227 D01 v02 section 5.1.1 1) page 9.

Reduced² – When the reported SAR is > 0.4 W/kg, test next highest output power channel until SAR ≤ 0.8 W/kg then all remaining test configurations are not required per KDB 248227 D01 v02 section 5.1.1 2) page 9.

Reduced³ – When the antenna is more than 25 mm from a side, the test can be reduced per KDB447498 D01 v05r02 section 4.3.1 1) page 11. See above for calculations.

Figure 8.37 Test Reduction Table – 5.6 GHz Main Silver Case Ethertronics

Mode	Side	Required Channel	Tested/Reduced
802.11a 5600 MHz	Back	100 – 5500 MHz	Reduced ¹
		104 – 5520 MHz	Reduced ¹
		108 – 5540 MHz	Reduced ¹
		112 – 5560 MHz	Reduced ¹
		116 – 5580 MHz	Reduced ¹
		120 – 5600 MHz	Reduced ¹
		124 – 5620 MHz	Tested
		128 – 5640 MHz	Reduced ¹
		132 – 5660 MHz	Reduced ¹
		136 – 5680 MHz	Reduced ¹
	140 – 5700 MHz	Reduced ¹	
	Front Edge	100 – 5500 MHz	Reduced ²
		104 – 5520 MHz	Reduced ²
		108 – 5540 MHz	Reduced ²
		112 – 5560 MHz	Reduced ²
		116 – 5580 MHz	Tested
		120 – 5600 MHz	Reduced ²
		124 – 5620 MHz	Tested
		128 – 5640 MHz	Reduced ²
		132 – 5660 MHz	Reduced ²
		136 – 5680 MHz	Reduced ²
	140 – 5700 MHz	Reduced ²	
	Right, Left, Bottom	100 – 5500 MHz	Reduced ³
		104 – 5520 MHz	Reduced ³
		108 – 5540 MHz	Reduced ³
		112 – 5560 MHz	Reduced ³
		116 – 5580 MHz	Reduced ³
		120 – 5600 MHz	Reduced ³
		124 – 5620 MHz	Reduced ³
		128 – 5640 MHz	Reduced ³
132 – 5660 MHz		Reduced ³	
136 – 5680 MHz		Reduced ³	
140 – 5700 MHz	Reduced ³		

Reduced¹ – When the reported SAR is ≤ 0.4 W/kg, SAR is not required for the remaining test configuration per KDB 248227 D01 v02 section 5.1.1 1) page 9.

Reduced² – When the reported SAR is >0.4 W/kg, test the next highest configuration until the SAR value is ≤ 0.8 W/kg per KDB 248227 D01 v02 section 5.1.1 2) page 9.

Reduced³ – When the antenna is more than 25 mm from a side, the test can be reduced per KDB447498 D01 v05r02 section 4.3.1 1) page 11. See below for calculations.

Calculations for test exclusion for Bottom, Right and Left side.

Maximum power: 39.8 mW
 Bottom Edge distance: 210.73 mm
 Left Side distance: 191.45 mm
 Right Side distance: 101.45 mm

The closest distance is from the right side. Therefore, if the right side is excluded the bottom and left side would also be excluded.

$$[{\{(3.0)/(\sqrt{5.70})\} * 50 \text{ mm}}] + [{\{101.45 - 50 \text{ mm}\} * 10}] = 577 \text{ mW which is greater than } 39.8 \text{ mW}$$

**Figure 8.38 Test Reduction Table – 5.6 GHz Main Silver Case
Ethertronics**

Mode	Side	Required Channel	Tested/Reduced
802.11n 5600 MHz	Back	100 – 5500 MHz	Reduced ¹
		104 – 5520 MHz	Reduced ¹
		108 – 5540 MHz	Reduced ¹
		112 – 5560 MHz	Reduced ¹
		116 – 5580 MHz	Reduced ¹
		120 – 5600 MHz	Reduced ¹
		124 – 5620 MHz	Reduced ¹
		128 – 5640 MHz	Reduced ¹
		132 – 5660 MHz	Reduced ¹
		136 – 5680 MHz	Reduced ¹
	140 – 5700 MHz	Reduced ¹	
	Front Edge	100 – 5500 MHz	Reduced ²
		104 – 5520 MHz	Reduced ²
		108 – 5540 MHz	Reduced ²
		112 – 5560 MHz	Reduced ²
		116 – 5580 MHz	Reduced ²
		120 – 5600 MHz	Reduced ²
		124 – 5620 MHz	Reduced ²
		128 – 5640 MHz	Reduced ²
		132 – 5660 MHz	Reduced ²
		136 – 5680 MHz	Reduced ²
	140 – 5700 MHz	Reduced ²	
	Right, Left, Bottom	100 – 5500 MHz	Reduced ³
		104 – 5520 MHz	Reduced ³
		108 – 5540 MHz	Reduced ³
		112 – 5560 MHz	Reduced ³
		116 – 5580 MHz	Reduced ³
		120 – 5600 MHz	Reduced ³
		124 – 5620 MHz	Reduced ³
		128 – 5640 MHz	Reduced ³
132 – 5660 MHz		Reduced ³	
136 – 5680 MHz		Reduced ³	
140 – 5700 MHz	Reduced ³		
802.11ac 5600 MHz	Back	106 – 5530 MHz	Reduced ¹
		122 – 5610 MHz	Reduced ¹
		138 – 5690 MHz	Reduced ¹
	Front Edge	106 – 5530 MHz	Reduced ²
		122 – 5610 MHz	Reduced ²
		138 – 5690 MHz	Reduced ²
	Right, Left, Bottom	106 – 5530 MHz	Reduced ³
		122 – 5610 MHz	Reduced ³
		138 – 5690 MHz	Reduced ³

Reduced¹ – When the reported SAR is ≤ 0.4 W/kg, SAR is not required for the remaining test configuration per KDB 248227 D01 v02 section 5.1.1 1) page 9.

Reduced² – When the reported SAR is >0.8 W/kg, test the next highest configuration until the SAR value is ≤ 1.2 W/kg per KDB 248227 D01 v02 section 5.1.1 3) page 9.

Reduced³ – When the antenna is more than 25 mm from a side, the test can be reduced per KDB447498 D01 v05r02 section 4.3.1 1) page 11. See above for calculations.

**Figure 8.39 Test Reduction Table – 5.6 GHz Aux Silver Case
Ethertronics**

Mode	Side	Required Channel	Tested/Reduced
802.11a 5600 MHz	Back	100 – 5500 MHz	Reduced ¹
		104 – 5520 MHz	Reduced ¹
		108 – 5540 MHz	Reduced ¹
		112 – 5560 MHz	Reduced ¹
		116 – 5580 MHz	Tested
		120 – 5600 MHz	Reduced ¹
		124 – 5620 MHz	Tested
		128 – 5640 MHz	Reduced ¹
		132 – 5660 MHz	Reduced ¹
		136 – 5680 MHz	Reduced ¹
	140 – 5700 MHz	Reduced ¹	
	Front Edge	100 – 5500 MHz	Reduced ²
		104 – 5520 MHz	Reduced ²
		108 – 5540 MHz	Reduced ²
		112 – 5560 MHz	Reduced ²
		116 – 5580 MHz	Tested
		120 – 5600 MHz	Reduced ²
		124 – 5620 MHz	Tested
		128 – 5640 MHz	Reduced ²
		132 – 5660 MHz	Reduced ²
		136 – 5680 MHz	Reduced ²
	140 – 5700 MHz	Reduced ²	
	Right	100 – 5500 MHz	Reduced ²
		104 – 5520 MHz	Reduced ²
		108 – 5540 MHz	Reduced ²
		112 – 5560 MHz	Reduced ²
		116 – 5580 MHz	Tested
		120 – 5600 MHz	Reduced ²
		124 – 5620 MHz	Tested
		128 – 5640 MHz	Reduced ²
		132 – 5660 MHz	Reduced ²
		136 – 5680 MHz	Reduced ²
	140 – 5700 MHz	Reduced ²	
	Left, Bottom	100 – 5500 MHz	Reduced ³
		104 – 5520 MHz	Reduced ³
		108 – 5540 MHz	Reduced ³
		112 – 5560 MHz	Reduced ³
		116 – 5580 MHz	Reduced ³
		120 – 5600 MHz	Reduced ³
		124 – 5620 MHz	Reduced ³
128 – 5640 MHz		Reduced ³	
132 – 5660 MHz		Reduced ³	
136 – 5680 MHz		Reduced ³	
140 – 5700 MHz	Reduced ³		

Reduced¹ – When the reported SAR is > 0.4 W/kg, test next highest output power channel until SAR ≤ 0.8 W/kg then all remaining test configurations are not required per KDB 248227 D01 v02 section 5.1.1 2) page 9.

Reduced² – When the reported SAR is > 0.8 W/kg, test next highest output power channel until SAR ≤ 1.2 W/kg then all remaining test configurations are not required per KDB 248227 D01 v02 section 5.1.1 3) page 9.

Reduced³ – When the antenna is more than 25 mm from a side, the test can be reduced per KDB447498 D01 v05r02 section 4.3.1 1) page 11. See below for calculations.

Calculations for test exclusion for Bottom and Left side.

Maximum power: 39.8 mW
 Bottom Edge distance: 210.73 mm
 Left Side distance: 286.45 mm

The closest distance is from the bottom side. Therefore, if the bottom side is excluded the right and laptop would also be excluded.

$$[{\{(3.0)/(\sqrt{5.70})\} * 50 \text{ mm}}] + [210.73 - 50 \text{ mm}] * 10 = 1670 \text{ mW}$$

which is greater than 39.8 mW

**Figure 8.40 Test Reduction Table – 5.6 GHz Aux Silver Case
Ethertronics**

Mode	Side	Required Channel	Tested/Reduced
802.11a 5600 MHz	Back	100 – 5500 MHz	Reduced ¹
		104 – 5520 MHz	Reduced ¹
		108 – 5540 MHz	Reduced ¹
		112 – 5560 MHz	Reduced ¹
		116 – 5580 MHz	Reduced ¹
		120 – 5600 MHz	Reduced ¹
		124 – 5620 MHz	Reduced ¹
		128 – 5640 MHz	Reduced ¹
		132 – 5660 MHz	Reduced ¹
		136 – 5680 MHz	Reduced ¹
	140 – 5700 MHz	Reduced ¹	
	Front Edge	100 – 5500 MHz	Reduced ²
		104 – 5520 MHz	Reduced ²
		108 – 5540 MHz	Reduced ²
		112 – 5560 MHz	Reduced ²
		116 – 5580 MHz	Reduced ²
		120 – 5600 MHz	Reduced ²
		124 – 5620 MHz	Reduced ²
		128 – 5640 MHz	Reduced ²
		132 – 5660 MHz	Reduced ²
		136 – 5680 MHz	Reduced ²
	140 – 5700 MHz	Reduced ²	
	Right	100 – 5500 MHz	Reduced ²
		104 – 5520 MHz	Reduced ²
		108 – 5540 MHz	Reduced ²
		112 – 5560 MHz	Reduced ²
		116 – 5580 MHz	Reduced ²
		120 – 5600 MHz	Reduced ²
		124 – 5620 MHz	Reduced ²
		128 – 5640 MHz	Reduced ²
		132 – 5660 MHz	Reduced ²
		136 – 5680 MHz	Reduced ²
	140 – 5700 MHz	Reduced ²	
	Left, Bottom	100 – 5500 MHz	Reduced ³
		104 – 5520 MHz	Reduced ³
		108 – 5540 MHz	Reduced ³
112 – 5560 MHz		Reduced ³	
116 – 5580 MHz		Reduced ³	
120 – 5600 MHz		Reduced ³	
124 – 5620 MHz		Reduced ³	
128 – 5640 MHz		Reduced ³	
132 – 5660 MHz		Reduced ³	
136 – 5680 MHz		Reduced ³	
140 – 5700 MHz	Reduced ³		
802.11ac 5600 MHz	Back	106 – 5530 MHz	Reduced ¹
		122 – 5610 MHz	Reduced ¹
		138 – 5690 MHz	Reduced ¹
	Front Edge	106 – 5530 MHz	Reduced ²
		122 – 5610 MHz	Reduced ²
		138 – 5690 MHz	Reduced ²
	Right	106 – 5530 MHz	Reduced ²
		122 – 5610 MHz	Reduced ²
		138 – 5690 MHz	Reduced ²
	Left, Bottom	106 – 5530 MHz	Reduced ³
		122 – 5610 MHz	Reduced ³
		138 – 5690 MHz	Reduced ³

Reduced¹ – When the reported SAR is ≤ 0.4 W/kg, SAR is not required for the remaining test configuration per KDB 248227 D01 v02 section 5.1.1 1) page 9.

Reduced² – When the reported SAR is > 0.4 W/kg, test next highest output power channel until SAR ≤ 0.8 W/kg then all remaining test configurations are not required per KDB 248227 D01 v02 section 5.1.1 2) page 9.

Reduced³ – When the antenna is more than 25 mm from a side, the test can be reduced per KDB447498 D01 v05r02 section 4.3.1 1) page 11. See above for calculations.

Figure 8.41 Test Reduction Table – 5.8 GHz Main Black Case HighTek

Mode	Side	Required Channel	Tested/Reduced
802.11a 5800 MHz	Back	149 – 5745 MHz	Reduced ¹
		153 – 5765 MHz	Reduced ¹
		157 – 5785 MHz	Reduced ¹
		161 – 5805 MHz	Reduced ¹
		165 – 5825 MHz	Reduced ¹
	Front Edge	149 – 5745 MHz	Reduced ¹
		153 – 5765 MHz	Reduced ¹
		157 – 5785 MHz	Tested
		161 – 5805 MHz	Reduced ¹
		165 – 5825 MHz	Reduced ¹
	Right, Left, Bottom	149 – 5745 MHz	Reduced ⁴
		153 – 5765 MHz	Reduced ⁴
		157 – 5785 MHz	Reduced ⁴
161 – 5805 MHz		Reduced ⁴	
165 – 5825 MHz		Reduced ⁴	
802.11n 5800 MHz	Back	149 – 5745 MHz	Reduced ¹
		153 – 5765 MHz	Reduced ¹
		157 – 5785 MHz	Reduced ¹
		161 – 5805 MHz	Reduced ¹
		165 – 5825 MHz	Reduced ¹
	Front Edge	149 – 5745 MHz	Reduced ¹
		153 – 5765 MHz	Reduced ¹
		157 – 5785 MHz	Reduced ¹
		161 – 5805 MHz	Reduced ¹
		165 – 5825 MHz	Reduced ¹
	Right, Left, Bottom	149 – 5745 MHz	Reduced ⁴
		153 – 5765 MHz	Reduced ⁴
		157 – 5785 MHz	Reduced ⁴
161 – 5805 MHz		Reduced ⁴	
165 – 5825 MHz		Reduced ⁴	
802.11ac 5775 MHz	Back	155 – 5775 MHz	Reduced ¹
	Front Edge	155 – 5775 MHz	Reduced ¹
	Right, Left, Bottom	155 – 5775 MHz	Reduced ⁴

Reduced¹ – When the reported SAR is ≤ 0.4 W/kg, SAR is not required for the remaining test configuration per KDB 248227 D01 v02 section 5.1.1 1) page 9.

Reduced² – When the reported SAR is > 0.4 W/kg, test next highest output power channel until SAR ≤ 0.8 W/kg then all remaining test configurations are not required per KDB 248227 D01 v02 section 5.1.1 2) page 9.

Reduced³ – When the reported SAR is >0.8 W/kg, test the next highest configuration until the SAR value is ≤ 1.2 W/kg per KDB 248227 D01 v02 section 5.1.1 3) page 9.

Reduced⁴ – When the antenna is more than 25 mm from a side, the test can be reduced per KDB447498 D01 v05r02 section 4.3.1 1) page 11. See below for calculations.

Calculations for test exclusion for Bottom, Right and Left side.

Maximum power: 39.8 mW
 Bottom Edge distance: 210.73 mm
 Left Side distance: 191.45 mm
 Right Side distance: 101.45 mm

The closest distance is from the right side. Therefore, if the right side is excluded the bottom and left side would also be excluded.

$$[[(3.0)/(\sqrt{5.825})]*50 \text{ mm}]+[(101.45-50 \text{ mm})^2*10]=576 \text{ mW which is greater than } 39.8 \text{ mW}$$

Figure 8.42 Test Reduction Table – 5.8 GHz Aux Black Case HighTek

Mode	Side	Required Channel	Tested/Reduced
802.11a 5800 MHz	Back	149 – 5745 MHz	Reduced ¹
		153 – 5765 MHz	Reduced ¹
		157 – 5785 MHz	Reduced ¹
		161 – 5805 MHz	Reduced ¹
		165 – 5825 MHz	Reduced ¹
	Front Edge	149 – 5745 MHz	Reduced ²
		153 – 5765 MHz	Reduced ²
		157 – 5785 MHz	Tested
		161 – 5805 MHz	Reduced ²
		165 – 5825 MHz	Tested
	Right	149 – 5745 MHz	Reduced ¹
		153 – 5765 MHz	Reduced ¹
		157 – 5785 MHz	Tested
		161 – 5805 MHz	Reduced ¹
		165 – 5825 MHz	Reduced ¹
	Left, Bottom	149 – 5745 MHz	Reduced ³
153 – 5765 MHz		Reduced ³	
157 – 5785 MHz		Reduced ³	
161 – 5805 MHz		Reduced ³	
165 – 5825 MHz		Reduced ³	
802.11n 5800 MHz	Back	149 – 5745 MHz	Reduced ¹
		153 – 5765 MHz	Reduced ¹
		157 – 5785 MHz	Reduced ¹
		161 – 5805 MHz	Reduced ¹
		165 – 5825 MHz	Reduced ¹
	Front Edge	149 – 5745 MHz	Reduced ²
		153 – 5765 MHz	Reduced ²
		157 – 5785 MHz	Reduced ²
		161 – 5805 MHz	Reduced ²
		165 – 5825 MHz	Reduced ²
	Right	149 – 5745 MHz	Reduced ¹
		153 – 5765 MHz	Reduced ¹
		157 – 5785 MHz	Reduced ¹
		161 – 5805 MHz	Reduced ¹
		165 – 5825 MHz	Reduced ¹
	Left, Bottom	149 – 5745 MHz	Reduced ³
153 – 5765 MHz		Reduced ³	
157 – 5785 MHz		Reduced ³	
161 – 5805 MHz		Reduced ³	
165 – 5825 MHz		Reduced ³	
802.11ac 5775 MHz	Back	155 – 5775 MHz	Reduced ¹
	Right	155 – 5775 MHz	Reduced ²
	Bottom	155 – 5775 MHz	Reduced ¹
	Top & Left	155 – 5775 MHz	Reduced ³

Reduced¹ – When the reported SAR is ≤ 0.4 W/kg, SAR is not required for the remaining test configuration per KDB 248227 D01 v02 section 5.1.1 1) page 9.

Reduced² – When the reported SAR is > 0.4 W/kg, test next highest output power channel until SAR ≤ 0.8 W/kg then all remaining test configurations are not required per KDB 248227 D01 v02 section 5.1.1 2) page 9.

Reduced³ – When the antenna is more than 25 mm from a side, the test can be reduced per KDB447498 D01 v05r02 section 4.3.1 1) page 11. See below for calculations.

Calculations for test exclusion for Bottom and Left side.

Maximum power: 39.8 mW
 Bottom Edge distance: 210.73 mm
 Left Side distance: 286.45 mm

The closest distance is from the bottom side. Therefore, if the bottom side is excluded the right and laptop would also be excluded.

$$[[(3.0)/(\sqrt{5.825})]*50 \text{ mm}]+[(210.73-50 \text{ mm})*10]=1669 \text{ mW which is greater than } 39.8 \text{ mW}$$

Figure 8.43 Test Reduction Table – 5.8 GHz Main Black Case Ethertronics

Mode	Side	Required Channel	Tested/Reduced
802.11a 5800 MHz	Back	149 – 5745 MHz	Reduced ¹
		153 – 5765 MHz	Reduced ¹
		157 – 5785 MHz	Tested
		161 – 5805 MHz	Reduced ¹
		165 – 5825 MHz	Reduced ¹
	Front Edge	149 – 5745 MHz	Reduced ³
		153 – 5765 MHz	Reduced ³
		157 – 5785 MHz	Tested
		161 – 5805 MHz	Reduced ³
		165 – 5825 MHz	Tested
	Right, Left, Bottom	149 – 5745 MHz	Reduced ⁴
		153 – 5765 MHz	Reduced ⁴
		157 – 5785 MHz	Reduced ⁴
		161 – 5805 MHz	Reduced ⁴
		165 – 5825 MHz	Reduced ⁴
802.11n 5800 MHz	Back	149 – 5745 MHz	Reduced ¹
		153 – 5765 MHz	Reduced ¹
		157 – 5785 MHz	Reduced ¹
		161 – 5805 MHz	Reduced ¹
		165 – 5825 MHz	Reduced ¹
	Front Edge	149 – 5745 MHz	Reduced ³
		153 – 5765 MHz	Reduced ³
		157 – 5785 MHz	Reduced ³
		161 – 5805 MHz	Reduced ³
		165 – 5825 MHz	Reduced ³
	Right, Left, Bottom	149 – 5745 MHz	Reduced ⁴
		153 – 5765 MHz	Reduced ⁴
		157 – 5785 MHz	Reduced ⁴
		161 – 5805 MHz	Reduced ⁴
		165 – 5825 MHz	Reduced ⁴
802.11ac 5775 MHz	Back	155 – 5775 MHz	Reduced ¹
	Front Edge	155 – 5775 MHz	Reduced ³
	Right, Left, Bottom	155 – 5775 MHz	Reduced ⁴

Reduced¹ – When the reported SAR is ≤ 0.4 W/kg, SAR is not required for the remaining test configuration per KDB 248227 D01 v02 section 5.1.1 1) page 9.

Reduced² – When the reported SAR is > 0.4 W/kg, test next highest output power channel until SAR ≤ 0.8 W/kg then all remaining test configurations are not required per KDB 248227 D01 v02 section 5.1.1 2) page 9.

Reduced³ – When the reported SAR is >0.8 W/kg, test the next highest configuration until the SAR value is ≤ 1.2 W/kg per KDB 248227 D01 v02 section 5.1.1 3) page 9.

Reduced⁴ – When the antenna is more than 25 mm from a side, the test can be reduced per KDB447498 D01 v05r02 section 4.3.1 1) page 11. See below for calculations.

Calculations for test exclusion for Bottom, Right and Left side.

Maximum power: 39.8 mW
 Bottom Edge distance: 210.73 mm
 Left Side distance: 191.45 mm
 Right Side distance: 101.45 mm

The closest distance is from the right side. Therefore, if the right side is excluded the bottom and left side would also be excluded.

$$[[{(3.0)/(\sqrt{5.825})]*50 \text{ mm}}]+[101.45-50 \text{ mm}]*10]=576 \text{ mW which is greater than } 39.8 \text{ mW}$$

**Figure 8.44 Test Reduction Table – 5.8 GHz Aux Black Case
Ethertronics**

Mode	Side	Required Channel	Tested/Reduced
802.11a 5800 MHz	Back	149 – 5745 MHz	Reduced ²
		153 – 5765 MHz	Reduced ²
		157 – 5785 MHz	Tested
		161 – 5805 MHz	Reduced ²
		165 – 5825 MHz	Tested
	Front Edge	149 – 5745 MHz	Reduced ³
		153 – 5765 MHz	Reduced ³
		157 – 5785 MHz	Tested
		161 – 5805 MHz	Reduced ³
		165 – 5825 MHz	Tested
	Right	149 – 5745 MHz	Reduced ³
		153 – 5765 MHz	Reduced ³
		157 – 5785 MHz	Tested
		161 – 5805 MHz	Reduced ³
		165 – 5825 MHz	Tested
	Left, Bottom	149 – 5745 MHz	Reduced ⁴
153 – 5765 MHz		Reduced ⁴	
157 – 5785 MHz		Reduced ⁴	
161 – 5805 MHz		Reduced ⁴	
165 – 5825 MHz		Reduced ⁴	
802.11n 5800 MHz	Back	149 – 5745 MHz	Reduced ²
		153 – 5765 MHz	Reduced ²
		157 – 5785 MHz	Reduced ²
		161 – 5805 MHz	Reduced ²
		165 – 5825 MHz	Reduced ²
	Front Edge	149 – 5745 MHz	Reduced ³
		153 – 5765 MHz	Reduced ³
		157 – 5785 MHz	Reduced ³
		161 – 5805 MHz	Reduced ³
		165 – 5825 MHz	Reduced ³
	Right	149 – 5745 MHz	Reduced ³
		153 – 5765 MHz	Reduced ³
		157 – 5785 MHz	Reduced ³
		161 – 5805 MHz	Reduced ³
		165 – 5825 MHz	Reduced ³
	Left, Bottom	149 – 5745 MHz	Reduced ⁴
153 – 5765 MHz		Reduced ⁴	
157 – 5785 MHz		Reduced ⁴	
161 – 5805 MHz		Reduced ⁴	
165 – 5825 MHz		Reduced ⁴	
802.11ac 5775 MHz	Back	155 – 5775 MHz	Reduced ²
	Right	155 – 5775 MHz	Reduced ³
	Bottom	155 – 5775 MHz	Reduced ³
	Top & Left	155 – 5775 MHz	Reduced ⁴

Reduced¹ – When the reported SAR is ≤ 0.4 W/kg, SAR is not required for the remaining test configuration per KDB 248227 D01 v02 section 5.1.1 1) page 9.

Reduced² – When the reported SAR is > 0.4 W/kg, test next highest output power channel until SAR ≤ 0.8 W/kg then all remaining test configurations are not required per KDB 248227 D01 v02 section 5.1.1 2) page 9.

Reduced³ – When the reported SAR is >0.8 W/kg, test the next highest configuration until the SAR value is ≤ 1.2 W/kg per KDB 248227 D01 v02 section 5.1.1 3) page 9.

Reduced⁴ – When the antenna is more than 25 mm from a side, the test can be reduced per KDB447498 D01 v05r02 section 4.3.1 1) page 11. See below for calculations.

Calculations for test exclusion for Bottom and Left side.

Maximum power: 39.8 mW
 Bottom Edge distance: 210.73 mm
 Left Side distance: 286.45 mm

The closest distance is from the bottom side. Therefore, if the bottom side is excluded the right and laptop would also be excluded.

$$[[{(3.0)/(\sqrt{5.825})]^*50 \text{ mm}}]+[[{210.73-50 \text{ mm}}]^*10]=1669 \text{ mW}$$

which is greater than 39.8 mW

Figure 8.45 Test Reduction Table – 5.8 GHz Main Silver Case HighTek

Mode	Side	Required Channel	Tested/Reduced
802.11a 5800 MHz	Back	149 – 5745 MHz	Reduced ¹
		153 – 5765 MHz	Reduced ¹
		157 – 5785 MHz	Reduced ¹
		161 – 5805 MHz	Reduced ¹
	Front Edge	149 – 5745 MHz	Reduced ¹
		153 – 5765 MHz	Reduced ¹
		157 – 5785 MHz	Tested
		161 – 5805 MHz	Reduced ¹
	Right, Left, Bottom	165 – 5825 MHz	Reduced ¹
		149 – 5745 MHz	Reduced ⁴
		153 – 5765 MHz	Reduced ⁴
		157 – 5785 MHz	Reduced ⁴
802.11n 5800 MHz	Back	161 – 5805 MHz	Reduced ⁴
		165 – 5825 MHz	Reduced ⁴
		149 – 5745 MHz	Reduced ¹
		153 – 5765 MHz	Reduced ¹
	Front Edge	157 – 5785 MHz	Reduced ¹
		161 – 5805 MHz	Reduced ¹
		165 – 5825 MHz	Reduced ¹
		149 – 5745 MHz	Reduced ¹
	Right, Left, Bottom	153 – 5765 MHz	Reduced ¹
		157 – 5785 MHz	Reduced ¹
		161 – 5805 MHz	Reduced ¹
		165 – 5825 MHz	Reduced ¹
802.11ac 5775 MHz	Back	149 – 5745 MHz	Reduced ⁴
	Front Edge	155 – 5775 MHz	Reduced ¹
	Right, Left, Bottom	155 – 5775 MHz	Reduced ⁴

- Reduced¹ – When the reported SAR is ≤ 0.4 W/kg, SAR is not required for the remaining test configuration per KDB 248227 D01 v02 section 5.1.1 1) page 9.
- Reduced² – When the reported SAR is > 0.4 W/kg, test next highest output power channel until SAR ≤ 0.8 W/kg then all remaining test configurations are not required per KDB 248227 D01 v02 section 5.1.1 2) page 9.
- Reduced³ – When the reported SAR is >0.8 W/kg, test the next highest configuration until the SAR value is ≤ 1.2 W/kg per KDB 248227 D01 v02 section 5.1.1 3) page 9.
- Reduced⁴ – When the antenna is more than 25 mm from a side, the test can be reduced per KDB447498 D01 v05r02 section 4.3.1 1) page 11. See below for calculations.

Calculations for test exclusion for Bottom, Right and Left side.

Maximum power: 39.8 mW
 Bottom Edge distance: 210.73 mm
 Left Side distance: 191.45 mm
 Right Side distance: 101.45 mm

The closest distance is from the right side. Therefore, if the right side is excluded the bottom and left side would also be excluded.

$$[{\{(3.0)/(\sqrt{5.825})\} * 50 \text{ mm}}] + [101.45 - 50 \text{ mm}] * 10 = 576 \text{ mW}$$

which is greater than 39.8 mW

Figure 8.46 Test Reduction Table – 5.8 GHz Aux Silver Case HighTek

Mode	Side	Required Channel	Tested/Reduced
802.11a 5800 MHz	Back	149 – 5745 MHz	Reduced ¹
		153 – 5765 MHz	Reduced ¹
		157 – 5785 MHz	Reduced ¹
		161 – 5805 MHz	Reduced ¹
		165 – 5825 MHz	Reduced ¹
	Front Edge	149 – 5745 MHz	Reduced ¹
		153 – 5765 MHz	Reduced ¹
		157 – 5785 MHz	Tested
		161 – 5805 MHz	Reduced ¹
	Right	165 – 5825 MHz	Reduced ¹
		149 – 5745 MHz	Reduced ¹
		153 – 5765 MHz	Reduced ¹
		157 – 5785 MHz	Tested
	Left, Bottom	161 – 5805 MHz	Reduced ¹
		165 – 5825 MHz	Reduced ¹
		149 – 5745 MHz	Reduced ³
153 – 5765 MHz		Reduced ³	
157 – 5785 MHz		Reduced ³	
802.11n 5800 MHz	Back	161 – 5805 MHz	Reduced ³
		165 – 5825 MHz	Reduced ³
		149 – 5745 MHz	Reduced ¹
		153 – 5765 MHz	Reduced ¹
		157 – 5785 MHz	Reduced ¹
	Front Edge	161 – 5805 MHz	Reduced ¹
		165 – 5825 MHz	Reduced ¹
		149 – 5745 MHz	Reduced ¹
		153 – 5765 MHz	Reduced ¹
	Right	157 – 5785 MHz	Reduced ¹
		161 – 5805 MHz	Reduced ¹
		165 – 5825 MHz	Reduced ¹
		149 – 5745 MHz	Reduced ¹
	Left, Bottom	153 – 5765 MHz	Reduced ³
		157 – 5785 MHz	Reduced ³
		161 – 5805 MHz	Reduced ³
165 – 5825 MHz		Reduced ³	
149 – 5745 MHz		Reduced ³	
802.11ac 5775 MHz	Back	155 – 5775 MHz	Reduced ¹
	Right	155 – 5775 MHz	Reduced ¹
	Bottom	155 – 5775 MHz	Reduced ¹
	Top & Left	155 – 5775 MHz	Reduced ³

Reduced¹ – When the reported SAR is ≤ 0.4 W/kg, SAR is not required for the remaining test configuration per KDB 248227 D01 v02 section 5.1.1 1) page 9.

Reduced² – When the reported SAR is > 0.4 W/kg, test next highest output power channel until SAR ≤ 0.8 W/kg then all remaining test configurations are not required per KDB 248227 D01 v02 section 5.1.1 2) page 9.

Reduced³ – When the antenna is more than 25 mm from a side, the test can be reduced per KDB447498 D01 v05r02 section 4.3.1 1) page 11. See below for calculations.

Calculations for test exclusion for Bottom and Left side.

Maximum power: 39.8 mW
 Bottom Edge distance: 210.73 mm
 Left Side distance: 286.45 mm

The closest distance is from the bottom side. Therefore, if the bottom side is excluded the right and laptop would also be excluded.

$$[[(3.0)/(\sqrt{5.825})]*50 \text{ mm}]+[(210.73-50 \text{ mm})*10]=1669 \text{ mW which is greater than } 39.8 \text{ mW}$$

**Figure 8.47 Test Reduction Table – 5.8 GHz Main Silver Case
Ethertronics**

Mode	Side	Required Channel	Tested/Reduced
802.11a 5800 MHz	Back	149 – 5745 MHz	Reduced ¹
		153 – 5765 MHz	Reduced ¹
		157 – 5785 MHz	Tested
		161 – 5805 MHz	Reduced ¹
		165 – 5825 MHz	Reduced ¹
	Front Edge	149 – 5745 MHz	Reduced ³
		153 – 5765 MHz	Reduced ³
		157 – 5785 MHz	Tested
		161 – 5805 MHz	Reduced ³
		165 – 5825 MHz	Tested
	Right, Left, Bottom	149 – 5745 MHz	Reduced ⁴
		153 – 5765 MHz	Reduced ⁴
		157 – 5785 MHz	Reduced ⁴
		161 – 5805 MHz	Reduced ⁴
		165 – 5825 MHz	Reduced ⁴
802.11n 5800 MHz	Back	149 – 5745 MHz	Reduced ¹
		153 – 5765 MHz	Reduced ¹
		157 – 5785 MHz	Reduced ¹
		161 – 5805 MHz	Reduced ¹
		165 – 5825 MHz	Reduced ¹
	Front Edge	149 – 5745 MHz	Reduced ³
		153 – 5765 MHz	Reduced ³
		157 – 5785 MHz	Reduced ³
		161 – 5805 MHz	Reduced ³
		165 – 5825 MHz	Reduced ³
	Right, Left, Bottom	149 – 5745 MHz	Reduced ⁴
		153 – 5765 MHz	Reduced ⁴
		157 – 5785 MHz	Reduced ⁴
		161 – 5805 MHz	Reduced ⁴
		165 – 5825 MHz	Reduced ⁴
802.11ac 5775 MHz	Back	155 – 5775 MHz	Reduced ¹
	Front Edge	155 – 5775 MHz	Reduced ³
	Right, Left, Bottom	155 – 5775 MHz	Reduced ⁴

Reduced¹ – When the reported SAR is ≤ 0.4 W/kg, SAR is not required for the remaining test configuration per KDB 248227 D01 v02 section 5.1.1 1) page 9.

Reduced² – When the reported SAR is > 0.4 W/kg, test next highest output power channel until SAR ≤ 0.8 W/kg then all remaining test configurations are not required per KDB 248227 D01 v02 section 5.1.1 2) page 9.

Reduced³ – When the reported SAR is >0.8 W/kg, test the next highest configuration until the SAR value is ≤ 1.2 W/kg per KDB 248227 D01 v02 section 5.1.1 3) page 9.

Reduced⁴ – When the antenna is more than 25 mm from a side, the test can be reduced per KDB447498 D01 v05r02 section 4.3.1 1) page 11. See below for calculations.

Calculations for test exclusion for Bottom, Right and Left side.

Maximum power: 39.8 mW
 Bottom Edge distance: 210.73 mm
 Left Side distance: 191.45 mm
 Right Side distance: 101.45 mm

The closest distance is from the right side. Therefore, if the right side is excluded the bottom and left side would also be excluded.

$$[[(3.0)/(\sqrt{5.825})] * 50 \text{ mm}] + [(101.45 - 50 \text{ mm}) * 10] = 576 \text{ mW which is greater than } 39.8 \text{ mW}$$

**Figure 8.48 Test Reduction Table – 5.8 GHz Aux Silver Case
Ethertronics**

Mode	Side	Required Channel	Tested/Reduced
802.11a 5800 MHz	Back	149 – 5745 MHz	Reduced ²
		153 – 5765 MHz	Reduced ²
		157 – 5785 MHz	Tested
		161 – 5805 MHz	Reduced ²
		165 – 5825 MHz	Tested
	Front Edge	149 – 5745 MHz	Reduced ³
		153 – 5765 MHz	Reduced ³
		157 – 5785 MHz	Tested
		161 – 5805 MHz	Reduced ³
		165 – 5825 MHz	Tested
	Right	149 – 5745 MHz	Reduced ³
		153 – 5765 MHz	Reduced ³
		157 – 5785 MHz	Tested
		161 – 5805 MHz	Reduced ³
		165 – 5825 MHz	Tested
	Left, Bottom	149 – 5745 MHz	Reduced ⁴
153 – 5765 MHz		Reduced ⁴	
157 – 5785 MHz		Reduced ⁴	
161 – 5805 MHz		Reduced ⁴	
165 – 5825 MHz		Reduced ⁴	
802.11n 5800 MHz	Back	149 – 5745 MHz	Reduced ²
		153 – 5765 MHz	Reduced ²
		157 – 5785 MHz	Reduced ²
		161 – 5805 MHz	Reduced ²
		165 – 5825 MHz	Reduced ²
	Front Edge	149 – 5745 MHz	Reduced ³
		153 – 5765 MHz	Reduced ³
		157 – 5785 MHz	Reduced ³
		161 – 5805 MHz	Reduced ³
		165 – 5825 MHz	Reduced ³
	Right	149 – 5745 MHz	Reduced ³
		153 – 5765 MHz	Reduced ³
		157 – 5785 MHz	Reduced ³
		161 – 5805 MHz	Reduced ³
		165 – 5825 MHz	Reduced ³
	Left, Bottom	149 – 5745 MHz	Reduced ⁴
153 – 5765 MHz		Reduced ⁴	
157 – 5785 MHz		Reduced ⁴	
161 – 5805 MHz		Reduced ⁴	
165 – 5825 MHz		Reduced ⁴	
802.11ac 5775 MHz	Back	155 – 5775 MHz	Reduced ²
	Right	155 – 5775 MHz	Reduced ³
	Bottom	155 – 5775 MHz	Reduced ³
	Top & Left	155 – 5775 MHz	Reduced ⁴

Reduced¹ – When the reported SAR is ≤ 0.4 W/kg, SAR is not required for the remaining test configuration per KDB 248227 D01 v02 section 5.1.1 1) page 9.

Reduced² – When the reported SAR is > 0.4 W/kg, test next highest output power channel until SAR ≤ 0.8 W/kg then all remaining test configurations are not required per KDB 248227 D01 v02 section 5.1.1 2) page 9.

Reduced³ – When the reported SAR is >0.8 W/kg, test the next highest configuration until the SAR value is ≤ 1.2 W/kg per KDB 248227 D01 v02 section 5.1.1 3) page 9.

Reduced⁴ – When the antenna is more than 25 mm from a side, the test can be reduced per KDB447498 D01 v05r02 section 4.3.1 1) page 11. See below for calculations.

Calculations for test exclusion for Bottom and Left side.

Maximum power: 39.8 mW
 Bottom Edge distance: 210.73 mm
 Left Side distance: 286.45 mm

The closest distance is from the bottom side. Therefore, if the bottom side is excluded the right and laptop would also be excluded.

$$[[{(3.0)/(\sqrt{5.825})]^*50 \text{ mm}}]+[[210.73-50 \text{ mm}]^*10]=1669 \text{ mW}$$

which is greater than 39.8 mW

SAR Data Summary – 2450 MHz Body 802.11b & BT

MEASUREMENT RESULTS

Plot	Gap	Antenna/Case	Position	Frequency		Modulation	Antenna	End Power (dBm)	Measured SAR (W/kg)	Reported SAR (W/kg)			
				MHz	Ch.								
----	0 mm	HighTek/ Black Case	Front Edge	2437	6	DSSS	Main	17.50	0.139	0.14			
----				2437	6		Aux				0.137	0.14	
----		Ethertronics/ Black Case	Right	2437	6	DSSS	Main	17.50	0.218	0.22			
----				2437	6						Aux	0.116	0.12
----		HighTek/ Silver Case	Front Edge	2437	6	DSSS	Main	17.50	0.117	0.12			
----				2437	6						Aux	0.125	0.13
----		Ethertronics/ Silver Case	Right	2437	6	DSSS	Main	17.50	0.340	0.34			
----				2437	6						Aux	0.161	0.16
1		Ethertronics/ Silver Case	Front Edge	2437	6	DSSS	Main	17.50	0.190	0.19			
----				2437	6						Aux	0.439	0.44
----		HighTek/ Black Case	Right	2462	11	DSSS	Main	17.36	0.402	0.42			
----				2462	11						Aux	0.402	0.42
----		HighTek/ Black Case	Front Edge	2440	39	GFSK	Main	11.39	0.0348	0.04			
----				2440	39						GFSK	0.0545	0.06
----				2440	39						GFSK	0.0313	0.03
----				2440	39						GFSK	0.0475	0.05

Body
1.6 W/kg (mW/g)
averaged over 1 gram

1. Battery is fully charged for all tests.
 Power Measured Conducted ERP EIRP
2. SAR Measurement
 Phantom Configuration Left Head Eli4 Right Head
 SAR Configuration Head Body
3. Test Signal Call Mode Test Code Base Station Simulator
4. Test Configuration With Belt Clip Without Belt Clip N/A
5. Tissue Depth is at least 15.0 cm



 Jay M. Moulton
 Vice President

SAR Data Summary – 5250 MHz Body 802.11a

MEASUREMENT RESULTS

Plot	Gap	Antenna	Position	Frequency		Modulation	Antenna	End Power (dBm)	Measured SAR (W/kg)	Reported SAR (W/kg)		
				MHz	Ch.							
----	0 mm	HighTek/ Black Case	Front	5300	60	OFDM	Main	16.00	0.267	0.27		
----			Edge	5300	60	OFDM	Aux	16.00	0.341	0.34		
----			Right	5300	60	OFDM		16.00	0.177	0.18		
----		Ethertronics/ Black Case	Tablet Back	5300	60	OFDM	Main	16.00	0.326	0.33		
----				5300	60	OFDM	Aux	16.00	0.355	0.36		
----			Front Edge	5300	60	OFDM	Main	16.00	0.300	0.30		
----				5280	56	OFDM		15.95	0.760	0.77		
----				5300	60	OFDM		16.00	0.695	0.70		
----			Right	5280	56	OFDM	Aux	15.95	0.745	0.75		
----					5300	60		OFDM	16.00	0.651	0.65	
----				Front Edge	5300	60		OFDM	Main	16.00	0.174	0.17
----					5300	60		OFDM		16.00	0.227	0.23
----		HighTek/ Silver Case	Right	5300	60	OFDM	Aux	16.00	0.158	0.16		
----				5300	60	OFDM		16.00	0.297	0.30		
----			Tablet Back	5300	60	OFDM	Main	16.00	0.297	0.30		
----		5300		60	OFDM	Aux	16.00	0.315	0.32			
----		Ethertronics/ Silver Case	Front Edge	5300	60	OFDM	Main	16.00	0.298	0.30		
----				5280	56	OFDM		15.95	0.761	0.77		
----				5300	60	OFDM		16.00	0.653	0.65		
----			Right	5280	56	OFDM	Aux	15.95	0.695	0.70		
----	5300				60	OFDM		16.00	0.596	0.60		
----	5300			60	OFDM	16.00		0.596	0.60			

Body
1.6 W/kg (mW/g)
averaged over 1 gram

- Battery is fully charged for all tests.
Power Measured Conducted ERP EIRP
- SAR Measurement
Phantom Configuration Left Head Eli4 Right Head
SAR Configuration Head Body
- Test Signal Call Mode Test Code Base Station Simulator
- Test Configuration With Belt Clip Without Belt Clip N/A
- Tissue Depth is at least 15.0 cm



Jay M. Moulton
Vice President

SAR Data Summary – 5600 MHz Body 802.11a

MEASUREMENT RESULTS

Plot	Gap	Antenna	Position	Frequency		Modulation	Antenna	End Power (dBm)	Measured SAR (W/kg)	Reported SAR (W/kg)		
				MHz	Ch.							
----	0 mm	HighTek/ Black Case	Front	124	5620	OFDM	Main	16.00	0.348	0.35		
----			Edge	124	5620	OFDM	Aux	16.00	0.387	0.39		
----			Right	124	5620	OFDM		16.00	0.132	0.13		
----		Ethertronics/ Black Case	Tablet Back	Front	124	5620	OFDM	Main	16.00	0.177	0.18	
----				Edge	116	5580	OFDM	Aux	15.95	0.579	0.59	
----				Right	124	5620	OFDM		16.00	0.573	0.57	
----			Front Edge		Front	116	5580	OFDM	Main	16.00	0.679	0.68
----					Edge	124	5620	OFDM		16.00	0.767	0.77
----					Right	116	5580	OFDM	Aux	15.95	0.948	0.96
----			Right		Front	124	5620	OFDM		16.00	0.906	0.91
----					Edge	116	5580	OFDM	Aux	15.95	0.885	0.90
----					Right	124	5620	OFDM		16.00	0.852	0.85
----		HighTek/ Silver Case	Front Edge	Front	124	5620	OFDM	Main	16.00	0.292	0.29	
----				Edge	124	5620	OFDM	Aux	16.00	0.378	0.38	
----				Right	124	5620	OFDM		16.00	0.134	0.13	
----		Ethertronics/ Silver Case	Tablet Back	Front	124	5620	OFDM	Main	16.00	0.108	0.11	
----				Edge	116	5580	OFDM	Aux	15.95	0.535	0.54	
----				Right	124	5620	OFDM		16.00	0.513	0.51	
----			Front Edge		Front	116	5580	OFDM	Main	16.00	0.650	0.65
----					Edge	124	5620	OFDM		16.00	0.705	0.71
----					Right	116	5580	OFDM	Aux	15.95	0.918	0.93
----			Right		Front	124	5620	OFDM		16.00	1.00	1.00
----					Edge	116	5580	OFDM	Aux	15.95	0.826	0.84
----					Right	124	5620	OFDM		16.00	0.943	0.94
----		Repeat		124	5620	OFDM		16.00	0.987	0.99		

Body
1.6 W/kg (mW/g)
averaged over 1 gram

1. Battery is fully charged for all tests.
Power Measured Conducted ERP EIRP
2. SAR Measurement
Phantom Configuration Left Head Eli4 Right Head
SAR Configuration Head Body
3. Test Signal Call Mode Test Code Base Station Simulator
4. Test Configuration With Belt Clip Without Belt Clip N/A
5. Tissue Depth is at least 15.0 cm

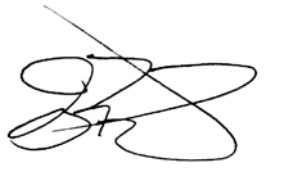

Jay M. Moulton
Vice President

SAR Data Summary – 5800 MHz Body 802.11a

MEASUREMENT RESULTS

Plot	Gap	Antenna	Position	Frequency		Modulation	Antenna	End Power (dBm)	Measured SAR (W/kg)	Reported SAR (W/kg)	
				MHz	Ch.						
----	0 mm	HighTek/ Black Case	Front Edge	157	5785	OFDM	Main	16.00	0.367	0.37	
----				157	5785	OFDM	Aux	16.00	0.407	0.41	
----				165	5825	OFDM		15.93	0.394	0.40	
----			Right	157	5785	OFDM	Main	16.00	0.152	0.15	
----				157	5785	OFDM	Aux	16.00	0.157	0.16	
----				157	5785	OFDM		16.00	0.506	0.51	
----		Ethertronics/ Black Case	Tablet Back	165	5825	OFDM	Aux	15.93	0.458	0.47	
----				Front Edge	157	5785	OFDM	Main	16.00	0.810	0.81
----					165	5825	OFDM		15.90	0.815	0.83
----					157	5785	OFDM	Aux	16.00	0.969	0.97
----				Right	165	5825	OFDM		15.93	0.882	0.90
----					157	5785	OFDM		16.00	0.994	0.99
----			165		5825	OFDM	15.93	0.873	0.89		
----			HighTek/ Silver Case	Front Edge	157	5785	OFDM	Main	16.00	0.227	0.23
----					157	5785	OFDM	Aux	16.00	0.382	0.38
----					157	5785	OFDM		16.00	0.176	0.18
----				Tablet Back	157	5785	OFDM	Main	16.00	0.110	0.11
----					157	5785	OFDM	Aux	16.00	0.606	0.61
----		165			5825	OFDM	15.93		0.499	0.51	
----		Ethertronics/ Silver Case	Front Edge	157	5785	OFDM	Main	16.00	0.826	0.83	
----				165	5825	OFDM		15.90	0.884	0.91	
----				157	5785	OFDM	Aux	16.00	1.20	1.20	
4			Right	165	5825	OFDM		15.93	0.970	0.99	
----				157	5785	OFDM		16.00	1.03	1.03	
----				165	5825	OFDM	15.93	0.878	0.89		
----			Repeat	157	5785	OFDM	Main	16.00	1.18	1.18	

Body
1.6 W/kg (mW/g)
averaged over 1 gram

- Battery is fully charged for all tests.
Power Measured Conducted ERP EIRP
- SAR Measurement
Phantom Configuration Left Head Eli4 Right Head
SAR Configuration Head Body
- Test Signal Call Mode Test Code Base Station Simulator
- Test Configuration With Belt Clip Without Belt Clip N/A
- Tissue Depth is at least 15.0 cm



Jay M. Moulton
Vice President

SAR Data Summary – Simultaneous Evaluation

MEASUREMENT RESULTS								
Frequency		Modulation	Frequency		Modulation	SAR ₁	SAR ₂	SAR Total
MHz	Ch.		MHz	Ch.				
2437	6	DSSS	2440	39	GFSK	0.44	0.06	0.50
5280	56	OFDM	2440	39	GFSK	0.77	0.06	0.83
5620	124	OFDM	2440	39	GFSK	1.00	0.06	1.06
5785	157	OFDM	2440	39	GFSK	1.20	0.06	1.26

Body
1.6 W/kg (mW/g)
averaged over 1 gram

The sum of the two transmitters is less than the limit; therefore, the simultaneous transmission meets the requirements of KDB447498 D01 v05r02 section 4.3.2 page 11.

MEASUREMENT RESULTS - MIMO								
Frequency		Modulation	Frequency		Modulation	SAR ₁ - Main	SAR ₂ - Aux	SAR Total
MHz	Ch.		MHz	Ch.				
2437	6	DSSS	2437	6	DSSS	0.22	0.44	0.66
5300	60	OFDM	5280	56	OFDM	0.33	0.77	1.10
5620	124	OFDM	5620	124	OFDM	0.77	1.00	1.77
5825	165	OFDM	5785	157	OFDM	0.91	1.20	2.11

Body
1.6 W/kg (mW/g)
averaged over 1 gram

In MIMO mode, the worst case condition is in the 5.8 GHz band. The main and aux antennas are a minimum of 80 mm apart. Using the highest reported SAR to calculate the simultaneous Tx using peak separation ratio, the highest ratio would be 0.04 which meets the requirements of KDB 447498 section 4.3.2 3) on page 13. The calculation is shown below.

Simultaneous Separation Ratio Calculation

$$(SAR_1 + SAR_2)^{1.5}/R_i \leq 0.04 \text{ rounded to two digits}$$

$$(0.91 + 1.20)^{1.5}/80 = 0.04$$

9. Test Equipment List

Table 9.1 Equipment Specifications

Type	Calibration Due Date	Calibration Done Date	Serial Number
Staubli Robot TX60L	N/A	N/A	F07/55M6A1/A/01
Measurement Controller CS8c	N/A	N/A	1012
ELI4 Flat Phantom	N/A	N/A	1065
Device Holder	N/A	N/A	N/A
Data Acquisition Electronics 4	01/08/2016	01/08/2015	1321
SPEAG E-Field Probe EX3DV4	01/23/2016	01/23/2015	3883
Speag Validation Dipole D2450V2	12/04/2015	12/04/2012	829
Speag Validation Dipole D5GHzV2	12/11/2015	12/11/2012	1085
Agilent N1911A Power Meter	05/20/2017	05/20/2015	GB45100254
Agilent N1922A Power Sensor	06/25/2017	06/25/2015	MY45240464
Advantest R3261A Spectrum Analyzer	03/26/2017	03/26/2015	31720068
Agilent (HP) 8350B Signal Generator	03/26/2017	03/26/2015	2749A10226
Agilent (HP) 83525A RF Plug-In	03/26/2017	03/26/2015	2647A01172
Agilent (HP) 8753C Vector Network Analyzer	03/26/2017	03/26/2015	3135A01724
Agilent (HP) 85047A S-Parameter Test Set	03/26/2017	03/26/2015	2904A00595
Agilent (HP) 8960 Base Station Sim.	03/31/2017	03/31/2015	MY48360364
Anritsu MT8820C	07/28/2017	07/28/2015	6201176199
Agilent 778D Dual Directional Coupler	N/A	N/A	MY48220184
MiniCircuits BW-N20W5+ Fixed 20 dB Attenuator	N/A	N/A	N/A
MiniCircuits SPL-10.7+ Low Pass Filter	N/A	N/A	R8979513746
Apriel Dielectric Probe Assembly	N/A	N/A	0011
Body Equivalent Matter (2450 MHz)	N/A	N/A	N/A
Body Equivalent Matter (5 GHz)	N/A	N/A	N/A

10. Conclusion

The SAR measurement indicates that the EUT complies with the RF radiation exposure limits of the FCC/IC. These measurements are taken to simulate the RF effects exposure under worst-case conditions. Precise laboratory measures were taken to assure repeatability of the tests. The tested device complies with the requirements in respect to all parameters subject to the test. The test results and statements relate only to the item(s) tested.

Please note that the absorption and distribution of electromagnetic energy in the body is a very complex phenomena that depends on the mass, shape, and size of the body; the orientation of the body with respect to the field vectors; and, the electrical properties of both the body and the environment. Other variables that may play a substantial role in possible biological effects are those that characterize the environment (e.g. ambient temperature, air velocity, relative humidity, and body insulation) and those that characterize the individual (e.g. age, gender, activity level, debilitation, or disease). Because innumerable factors may interact to determine the specific biological outcome of an exposure to electromagnetic fields, any protection guide shall consider maximal amplification of biological effects as a result of field-body interactions, environmental conditions, and physiological variables.

11. References

- [1] Federal Communications Commission, ET Docket 93-62, Guidelines for Evaluating the Environmental Effects of Radio Frequency Radiation, August 1996
- [2] ANSI/IEEE C95.1 – 1992, American National Standard Safety Levels with respect to Human Exposure to Radio Frequency Electromagnetic Fields, 300kHz to 100GHz, New York: IEEE, 1992.
- [3] ANSI/IEEE C95.3 – 1992, IEEE Recommended Practice for the Measurement of Potentially Hazardous Electromagnetic Fields – RF and Microwave, New York: IEEE, 1992.
- [4] International Electrotechnical Commission, IEC 62209-2 (Edition 1.0), Human Exposure to radio frequency fields from hand-held and body mounted wireless communication devices – Human models, instrumentation, and procedures – Part 2: Procedure to determine the specific absorption rate (SAR) for wireless communication devices used in close proximity to the human body (frequency range of 30 MHz to 6 GHz), March 2010.
- [5] IEEE Standard 1528 – 2013, IEEE Recommended Practice for Determining the Peak-Spatial Average Specific Absorption Rate (SAR) in the Human Head from Wireless Communication Devices: Measurement Techniques, June 2013.
- [6] Industry Canada, RSS – 102 Issue 5, Radio Frequency Exposure Compliance of Radiocommunication Apparatus (All Frequency Bands), March 2015.
- [7] Health Canada, Safety Code 6, Limits of Human Exposure to Radiofrequency Electromagnetic Fields in the Frequency Range from 3kHz to 300 GHz, 2009.

Appendix A – System Validation Plots and Data

```
*****
Test Result for UIM Dielectric Parameter
Thu 20/Aug/2015
Freq  Frequency(GHz)
FCC_eH Limits for Head Epsilon
FCC_sH Limits for Head Sigma
FCC_eB Limits for Body Epsilon
FCC_sB Limits for Body Sigma
Test_e Epsilon of UIM
Test_s Sigma of UIM
*****
Freq      FCC_eB FCC_sB Test_e Test_s
2.4100    52.75  1.91  52.61  1.92
2.4120    52.748 1.912 52.606 1.922*
2.4200    52.74  1.92  52.59  1.93
2.4300    52.73  1.93  52.57  1.94
2.4370    52.716 1.937 52.556 1.947*
2.4400    52.71  1.94  52.55  1.95
2.4500    52.70  1.95  52.53  1.96
2.4600    52.69  1.96  52.51  1.98
2.4620    52.686 1.964 52.508 1.982*
2.4700    52.67  1.98  52.50  1.99
2.4800    52.66  1.99  52.48  2.00
```

* value interpolated

Test Result for UIM Dielectric Parameter

Mon 17/Aug/2015

Freq Frequency(GHz)

FCC_eH Limits for Head Epsilon

FCC_sH Limits for Head Sigma

FCC_eB Limits for Body Epsilon

FCC_sB Limits for Body Sigma

Test_e Epsilon of UIM

Test_s Sigma of UIM

Freq	FCC_eB	FCC_sB	Test_e	Test_s
5.1000	49.15	5.18	49.09	5.18
5.1200	49.12	5.21	49.06	5.21
5.1400	49.10	5.23	49.03	5.24
5.1600	49.07	5.25	49.00	5.26
5.1800	49.04	5.28	48.97	5.29
5.2000	49.01	5.30	48.94	5.31
5.2100	49.00	5.31	48.93	5.32*
5.2200	48.99	5.32	48.92	5.33
5.2400	48.96	5.35	48.89	5.36
5.2600	48.93	5.37	48.86	5.38
5.2800	48.91	5.39	48.83	5.40
5.2900	48.895	5.405	48.815	5.415*
5.3000	48.88	5.42	48.80	5.43
5.3200	48.85	5.44	48.78	5.45
5.3400	48.82	5.46	48.75	5.48
5.3600	48.80	5.49	48.72	5.50
5.3800	48.77	5.51	48.69	5.52
5.4000	48.74	5.53	48.66	5.55
5.4200	48.72	5.56	48.64	5.57
5.4400	48.69	5.58	48.61	5.59
5.4600	48.66	5.60	48.58	5.62
5.4800	48.63	5.63	48.55	5.64
5.5000	48.61	5.65	48.52	5.66
5.5200	48.58	5.67	48.49	5.69
5.5400	48.55	5.70	48.47	5.71
5.5600	48.53	5.72	48.44	5.73
5.5800	48.50	5.74	48.41	5.76
5.6000	48.47	5.77	48.38	5.78
5.6100	48.455	5.78	48.365	5.79*
5.6200	48.44	5.79	48.35	5.80
5.6400	48.42	5.81	48.33	5.83
5.6600	48.39	5.84	48.30	5.85
5.6800	48.36	5.86	48.27	5.87
5.7000	48.34	5.88	48.24	5.90
5.7200	48.31	5.91	48.21	5.92
5.7400	48.28	5.93	48.18	5.94
5.7450	48.273	5.935	48.175	5.948*
5.7600	48.25	5.95	48.16	5.97
5.7750	48.235	5.973	48.138	5.985*
5.7800	48.23	5.98	48.13	5.99
5.7850	48.223	5.985	48.123	5.995*
5.8000	48.20	6.00	48.10	6.01
5.8200	48.17	6.02	48.07	6.03
5.8250	48.165	6.028	48.063	6.038*
5.8400	48.15	6.05	48.04	6.06

* value interpolated

RF Exposure Lab

Plot 1

DUT: Dipole 2450 MHz D2450V2; Type: D2450V2; Serial: D2450V2 - SN: 829

Communication System: CW; Frequency: 2450 MHz; Duty Cycle: 1:1
 Medium: MSL2450; Medium parameters used: $f = 2450$ MHz; $\sigma = 1.96$ S/m; $\epsilon_r = 52.53$; $\rho = 1000$ kg/m³
 Phantom section: Flat Section

Test Date: Date: 8/20/2015; Ambient Temp: 23 °C; Tissue Temp: 21 °C
 Probe: EX3DV4 - SN3833; ConvF(6.69, 6.69, 6.69); Calibrated: 1/23/2015;
 Sensor-Surface: 2mm (Mechanical Surface Detection)
 Electronics: DAE4 Sn1321; Calibrated: 1/8/2015
 Phantom: ELI v4.0; Type: QDOVA001BB; Serial: 1251
 Measurement SW: DASY52, Version 52.8 (8); SEMCAD X Version 14.6.10 (7331)

Procedure Notes:

Body Verification/2450 MHz/Area Scan (61x101x1): Interpolated grid: dx=1.200 mm, dy=1.200 mm
 Maximum value of SAR (interpolated) = 8.95 W/kg

Body Verification/2450 MHz/Zoom Scan (7x7x7)/Cube 0: Measurement grid: dx=5mm, dy=5mm, dz=5mm
 Reference Value = 53.597 V/m; Power Drift = -0.01 dB
 Peak SAR (extrapolated) = 11.18 W/kg
 $P_{in} = 100$ mW
SAR(1 g) = 5.22 W/kg; SAR(10 g) = 2.4 W/kg
 Maximum value of SAR (measured) = 8.71 W/kg

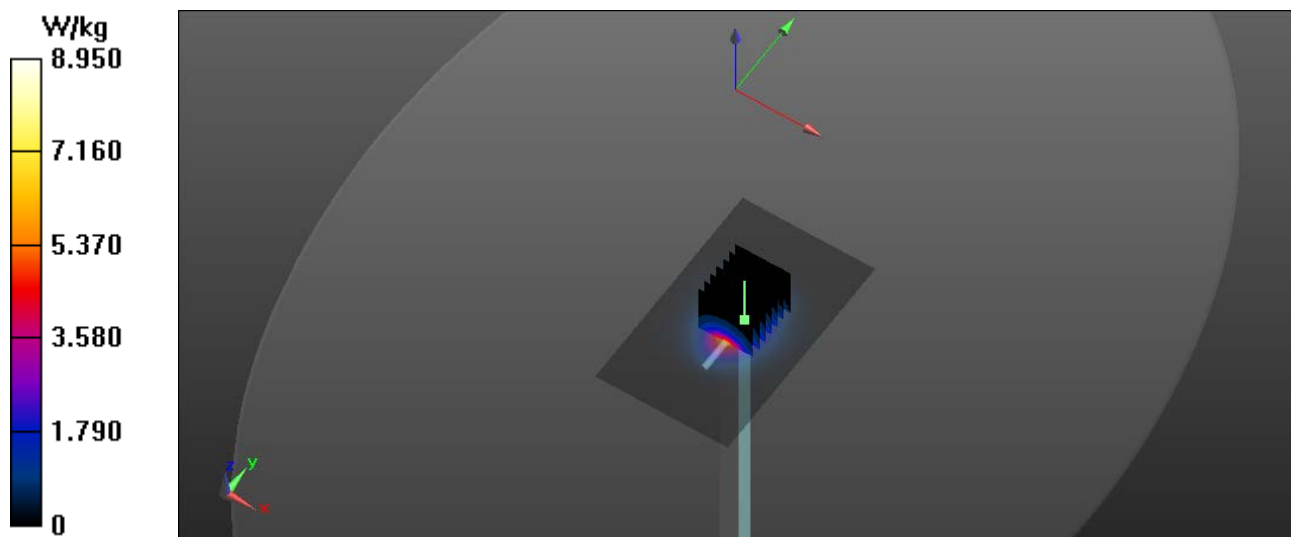

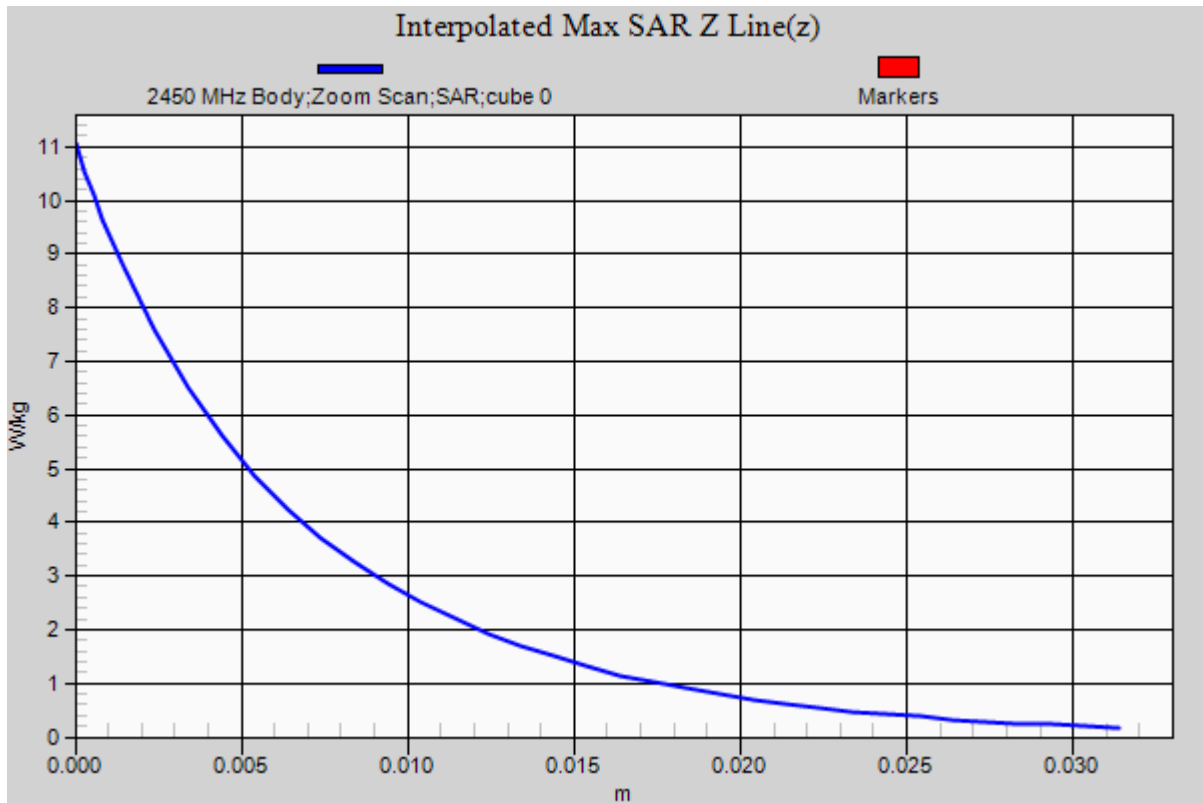

RF Exposure Lab

Plot 2

DUT: Dipole D5GHzV2; Type: D5GHzV2; Serial: D5GHzV2 - SN: 1085

Communication System: CW; Frequency: 5200 MHz; Duty Cycle: 1:1
Medium: MSL 3-6 GHz; Medium parameters used: $f = 5200$ MHz; $\sigma = 5.31$ S/m; $\epsilon_r = 48.94$; $\rho = 1000$ kg/m³
Phantom section: Flat Section

Test Date: Date: 8/17/2015; Ambient Temp: 23 °C; Tissue Temp: 21 °C
Probe: EX3DV4 - SN3833; ConvF(3.92, 3.92, 3.92); Calibrated: 1/23/2015;
Sensor-Surface: 2mm (Mechanical Surface Detection)
Electronics: DAE4 Sn1321; Calibrated: 1/8/2015
Phantom: ELI v4.0; Type: QDOVA001BB; Serial: 1251
Measurement SW: DASY52, Version 52.8 (8); SEMCAD X Version 14.6.10 (7331)

Procedure Notes:

Body Verification/5200 MHz/Area Scan (61x81x1): Interpolated grid: dx=1.000 mm, dy=1.000 mm
Maximum value of SAR (interpolated) = 1.9 W/kg

Body Verification/5200 MHz/Zoom Scan (7x7x12)/Cube 0: Measurement grid: dx=4mm, dy=4mm, dz=2mm
Reference Value = 12.722 V/m; Power Drift = 0.01 dB
Peak SAR (extrapolated) = 3.22 W/kg
Pin=10 mW
SAR(1 g) = 0.739 W/kg; SAR(10 g) = 0.202 W/kg
Maximum value of SAR (measured) = 1.88 W/kg

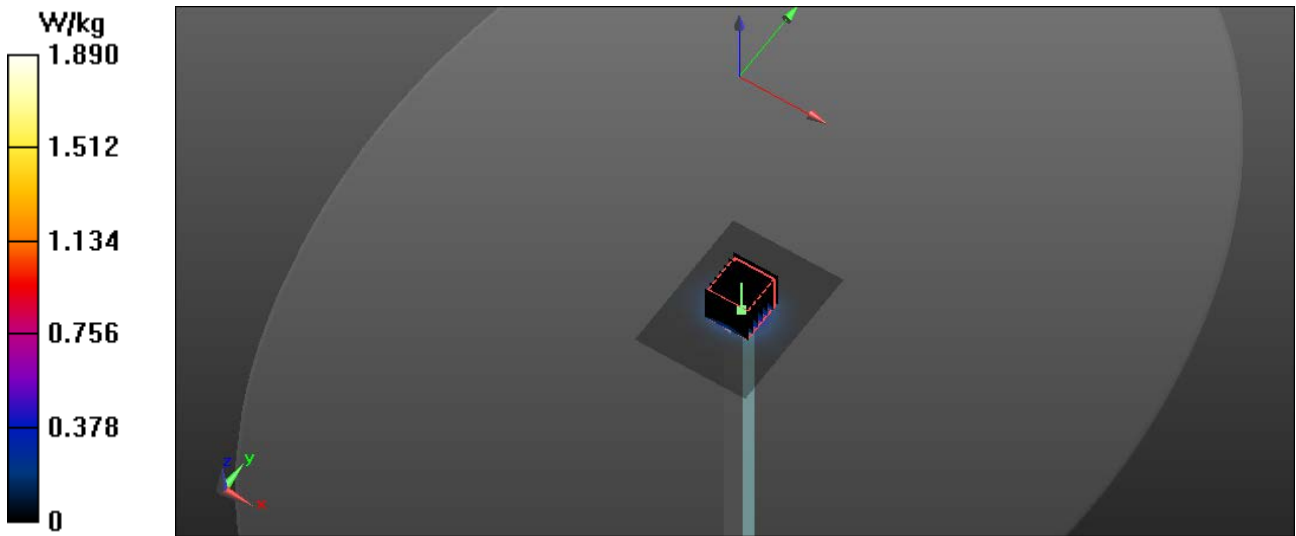

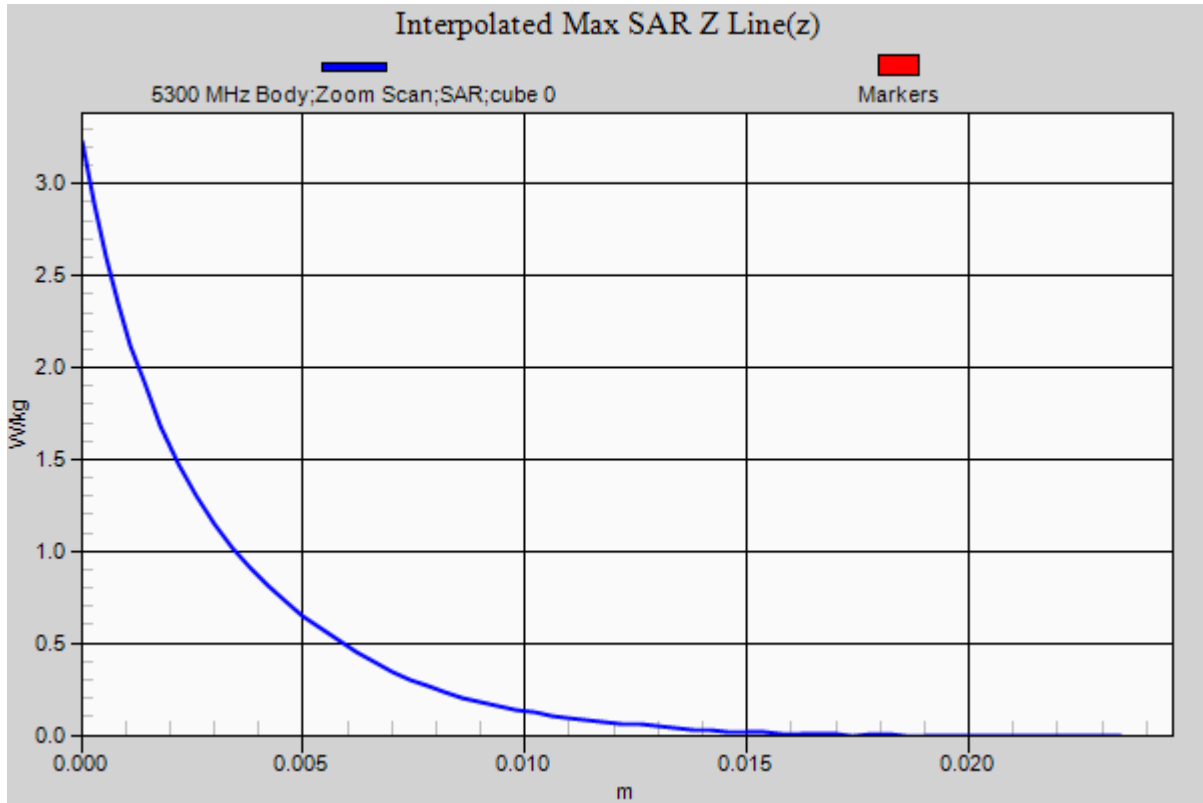

RF Exposure Lab

Plot 3

DUT: Dipole D5GHzV2; Type: D5GHzV2; Serial: D5GHzV2 - SN: 1085

Communication System: CW; Frequency: 5600 MHz; Duty Cycle: 1:1
 Medium: MSL 3-6 GHz; Medium parameters used: $f = 5600$ MHz; $\sigma = 5.78$ S/m; $\epsilon_r = 48.38$; $\rho = 1000$ kg/m³
 Phantom section: Flat Section

Test Date: Date: 8/17/2015; Ambient Temp: 23 °C; Tissue Temp: 21 °C
 Probe: EX3DV4 - SN3833; ConvF(3.46, 3.46, 3.46); Calibrated: 1/23/2015;
 Sensor-Surface: 2mm (Mechanical Surface Detection)
 Electronics: DAE4 Sn1321; Calibrated: 1/8/2015
 Phantom: ELI v4.0; Type: QDOVA001BB; Serial: 1251
 Measurement SW: DASY52, Version 52.8 (8); SEMCAD X Version 14.6.10 (7331)

Procedure Notes:

Body Verification/5600 MHz/Area Scan (61x81x1): Interpolated grid: dx=1.000 mm, dy=1.000 mm
 Maximum value of SAR (interpolated) = 2.01 W/kg

Body Verification/5600 MHz/Zoom Scan (7x7x12)/Cube 0: Measurement grid: dx=4mm, dy=4mm, dz=2mm
 Reference Value = 13.367 V/m; Power Drift = -0.01 dB
 Peak SAR (extrapolated) = 3.35 W/kg
 Pin=10 mW
SAR(1 g) = 0.798 W/kg; SAR(10 g) = 0.219 W/kg
 Maximum value of SAR (measured) = 2.02 W/kg

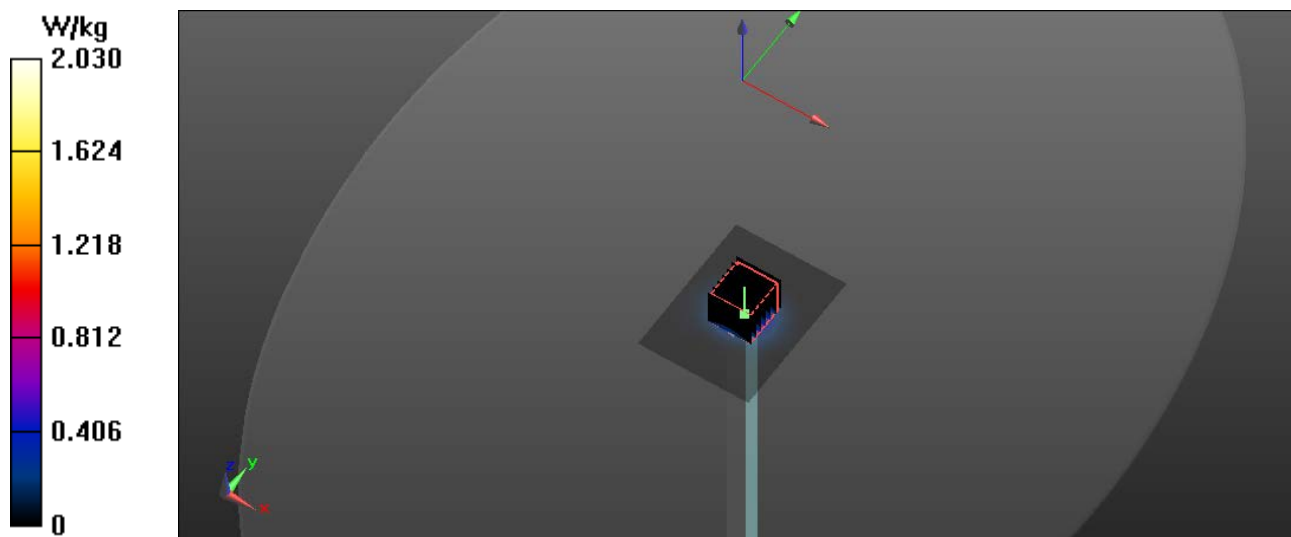

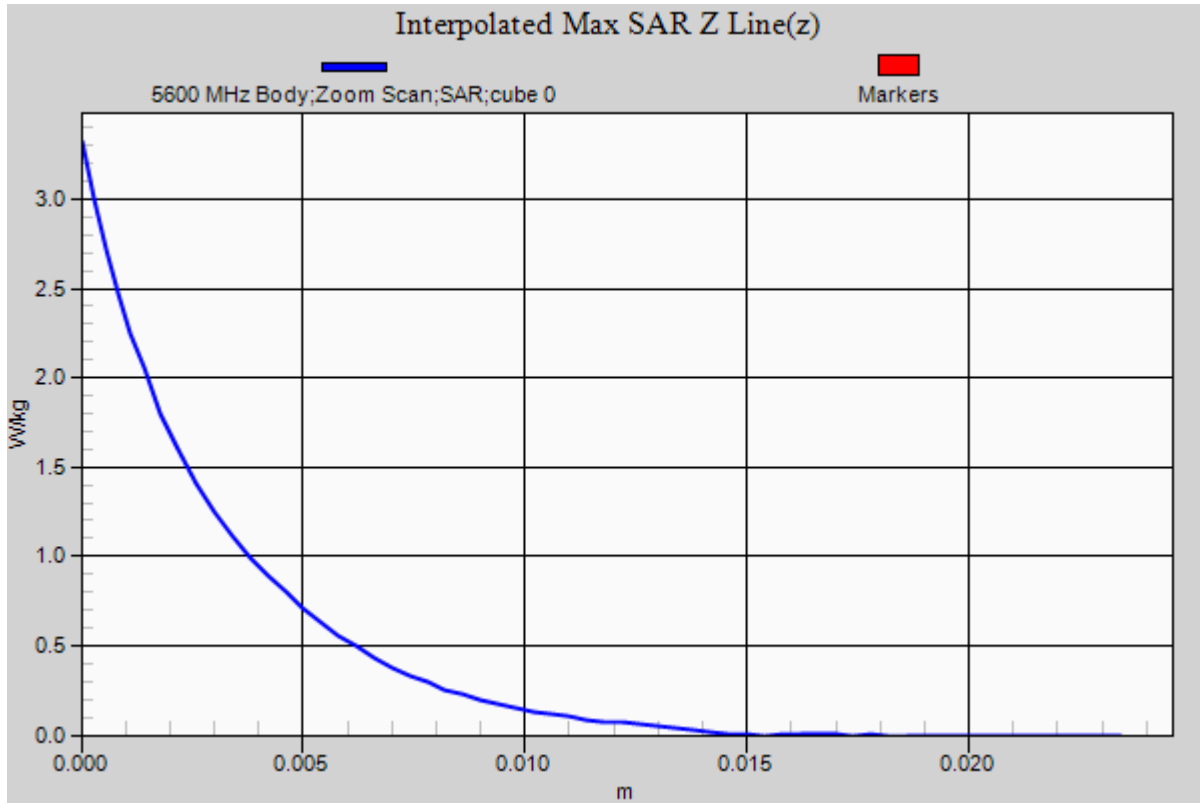

RF Exposure Lab

Plot 4

DUT: Dipole D5GHzV2; Type: D5GHzV2; Serial: D5GHzV2 - SN: 1085

Communication System: CW; Frequency: 5800 MHz; Duty Cycle: 1:1
 Medium: MSL 3-6 GHz; Medium parameters used: $f = 5800$ MHz; $\sigma = 6.01$ S/m; $\epsilon_r = 48.1$; $\rho = 1000$ kg/m³
 Phantom section: Flat Section

Test Date: Date: 8/17/2015; Ambient Temp: 23 °C; Tissue Temp: 21 °C
 Probe: EX3DV4 - SN3833; ConvF(3.57, 3.57, 3.57); Calibrated: 1/23/2015;
 Sensor-Surface: 2mm (Mechanical Surface Detection)
 Electronics: DAE4 Sn1321; Calibrated: 1/8/2015
 Phantom: ELI v4.0; Type: QDOVA001BB; Serial: 1251
 Measurement SW: DASY52, Version 52.8 (8); SEMCAD X Version 14.6.10 (7331)

Procedure Notes:

Body Verification/5800 MHz/Area Scan (61x81x1): Interpolated grid: dx=1.000 mm, dy=1.000 mm
 Maximum value of SAR (interpolated) = 1.76 W/kg

Body Verification/5800 MHz/Zoom Scan (7x7x12)/Cube 0: Measurement grid: dx=4mm, dy=4mm, dz=2mm
 Reference Value = 12.321 V/m; Power Drift = 0.02 dB
 Peak SAR (extrapolated) = 2.87 W/kg
 Pin=10 mW
SAR(1 g) = 0.724 W/kg; SAR(10 g) = 0.2 W/kg
 Maximum value of SAR (measured) = 1.75 W/kg

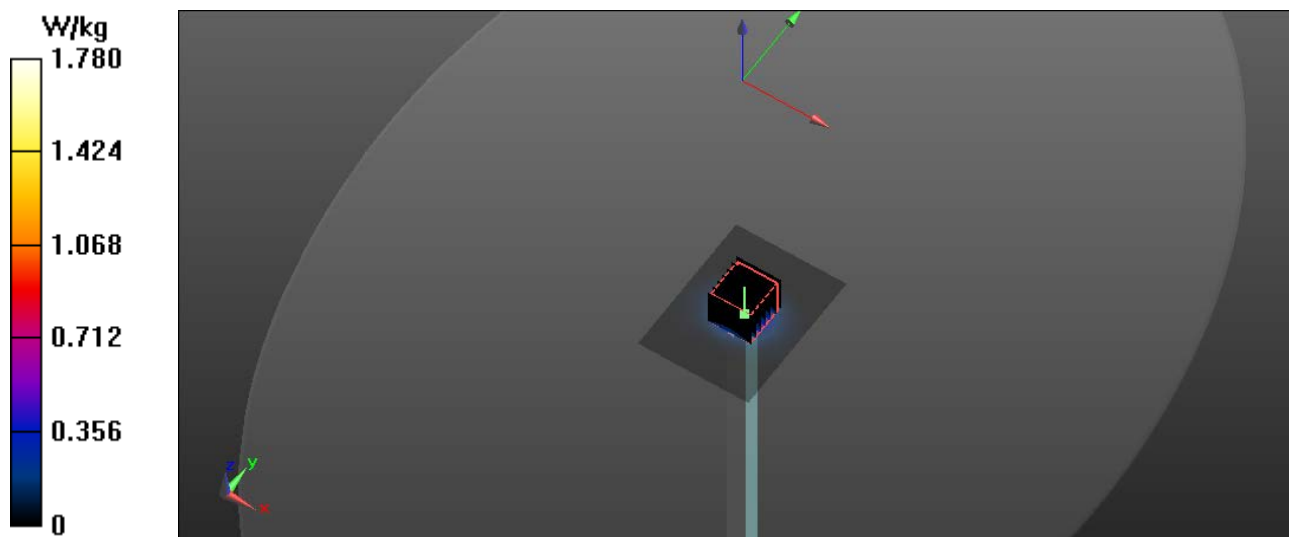

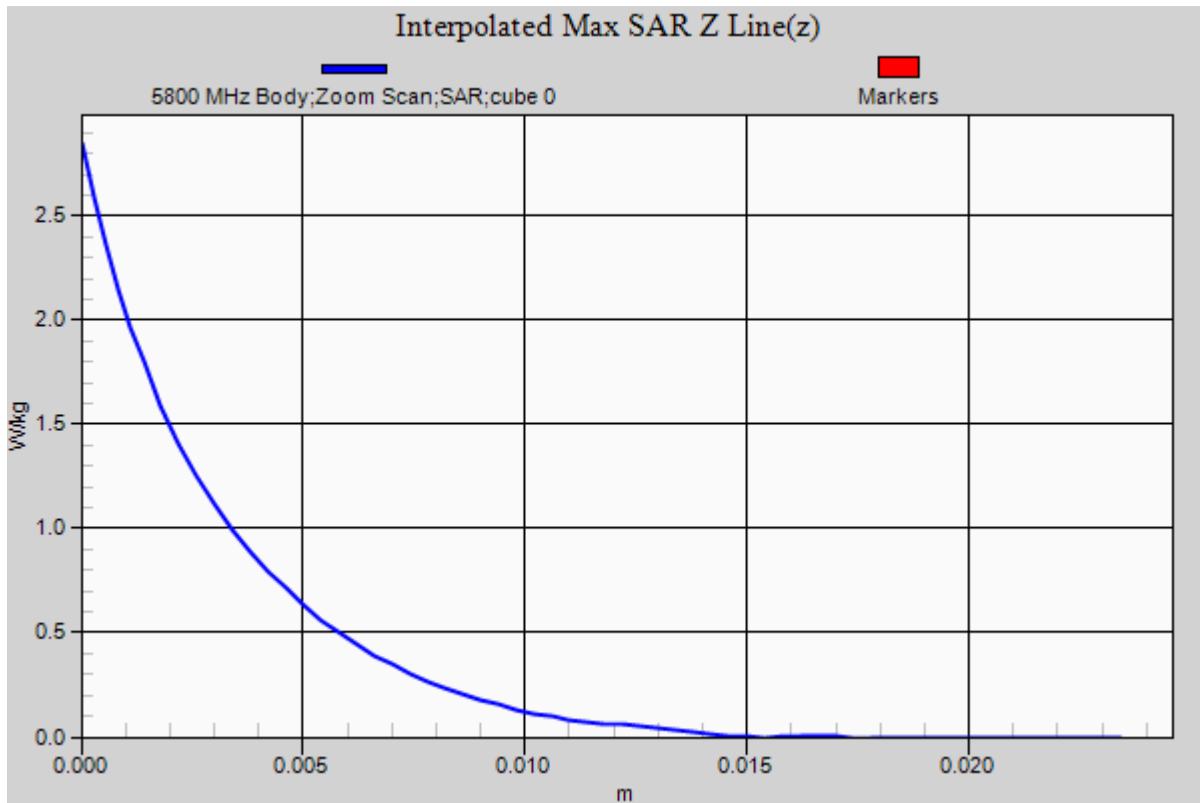

Appendix B – SAR Test Data Plots

RF Exposure Lab

Plot 1

DUT: Lenovo TP00078A PC; Type: Convertible PC; Serial: MP-08F100

Communication System: WiFi 802.11b (DSSS, 1 Mbps); Frequency: 2437 MHz; Duty Cycle: 1:1
Medium: MSL2450; Medium parameters used (interpolated): $f = 2437$ MHz; $\sigma = 1.947$ S/m; $\epsilon_r = 52.556$; $\rho = 1000$ kg/m³
Phantom section: Flat Section

Test Date: Date: 8/20/2015; Ambient Temp: 23 °C; Tissue Temp: 21 °C

Probe: EX3DV4 - SN3833; ConvF(6.69, 6.69, 6.69); Calibrated: 1/23/2015;
Sensor-Surface: 2mm (Mechanical Surface Detection)
Electronics: DAE4 Sn1321; Calibrated: 1/8/2015
Phantom: ELI v4.0; Type: QDOVA001BB; Serial: 1251
Measurement SW: DASY52, Version 52.8 (8); SEMCAD X Version 14.6.10 (7331)

Procedure Notes:

2450 MHz Ethertronics/Tablet Right Side Aux Mid/Area Scan (7x9x1): Measurement grid: dx=10mm, dy=10mm

[Info: Interpolated medium parameters used for SAR evaluation.](#)

Maximum value of SAR (measured) = 0.521 W/kg

2450 MHz Ethertronics/Tablet Right Side Aux Mid/Zoom Scan (7x7x7)/Cube 0: Measurement grid: dx=5mm, dy=5mm, dz=5mm

Reference Value = 12.17 V/m; Power Drift = 0.01 dB

Peak SAR (extrapolated) = 1.03 W/kg

SAR(1 g) = 0.439 W/kg

[Info: Interpolated medium parameters used for SAR evaluation.](#)

Maximum value of SAR (measured) = 0.716 W/kg

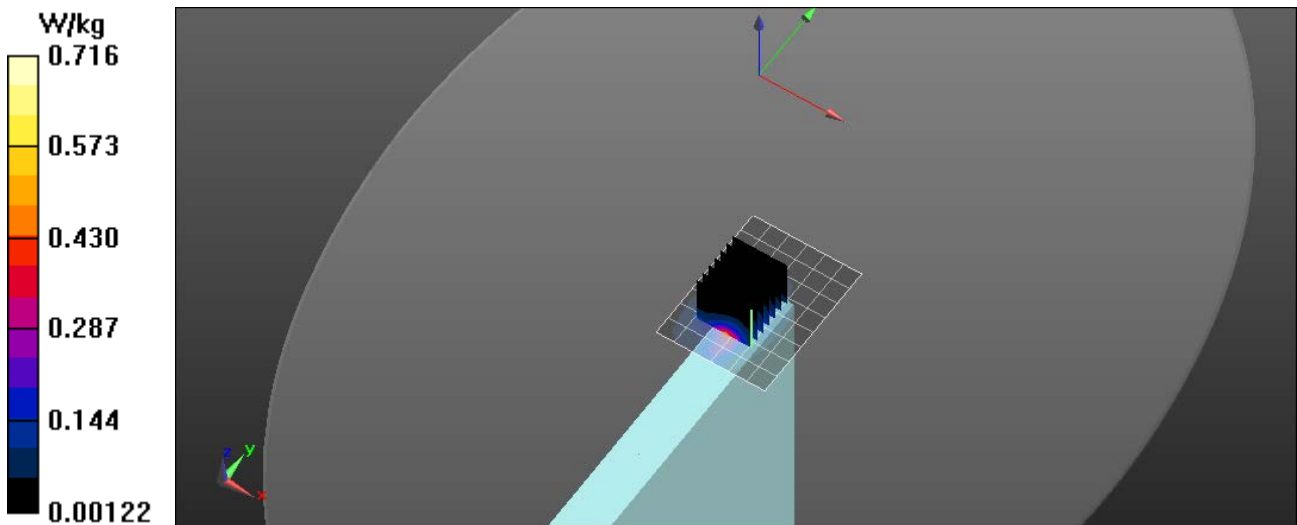

RF Exposure Lab

Plot 2

DUT: Lenovo TP00078A PC; Type: Convertible PC; Serial: MP-08F100

Communication System: WiFi 802.11a (OFDM, 6 Mbps); Frequency: 5280 MHz; Duty Cycle: 1:1
 Medium: MSL 3-6 GHz; Medium parameters used: $f = 5280 \text{ MHz}$; $\sigma = 5.4 \text{ S/m}$; $\epsilon_r = 48.83$; $\rho = 1000 \text{ kg/m}^3$
 Phantom section: Flat Section

Test Date: Date: 8/19/2015; Ambient Temp: 23 °C; Tissue Temp: 21 °C

Probe: EX3DV4 - SN3833; ConvF(3.81, 3.81, 3.81); Calibrated: 1/23/2015;
 Sensor-Surface: 2mm (Mechanical Surface Detection)
 Electronics: DAE4 Sn1321; Calibrated: 1/8/2015
 Phantom: ELI v4.0; Type: QDOVA001BB; Serial: 1251
 Measurement SW: DASY52, Version 52.8 (8); SEMCAD X Version 14.6.10 (7331)

Procedure Notes:

5200 MHz Ethertronics/Tablet Front Edge Aux 56/Area Scan (7x9x1): Measurement grid: dx=10mm, dy=10mm
 Maximum value of SAR (measured) = 1.35 W/kg

5200 MHz Ethertronics/Tablet Front Edge Aux 56/Zoom Scan (7x7x12)/Cube 0: Measurement grid: dx=4mm, dy=4mm, dz=2mm
 Reference Value = 12.26 V/m; Power Drift = -0.01 dB
 Peak SAR (extrapolated) = 2.80 W/kg
SAR(1 g) = 0.761 W/kg
 Maximum value of SAR (measured) = 1.50 W/kg

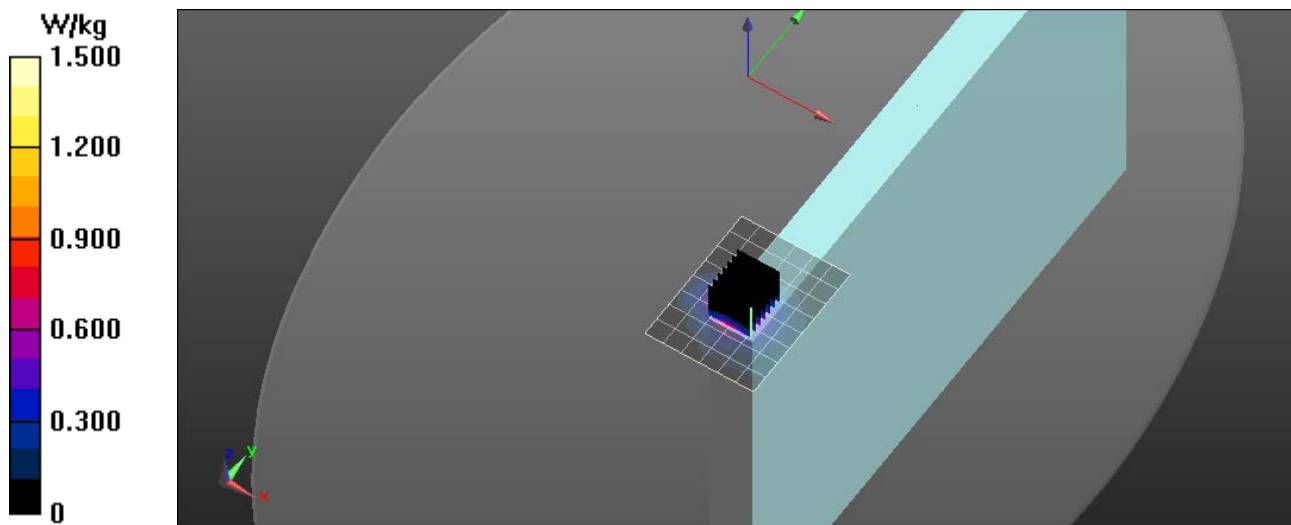

RF Exposure Lab

Plot 3

DUT: Lenovo TP00078A PC; Type: Convertible PC; Serial: MP-08F100

Communication System: WiFi 802.11a (OFDM, 6 Mbps); Frequency: 5620 MHz; Duty Cycle: 1:1
Medium: MSL 3-6 GHz; Medium parameters used: $f = 5620$ MHz; $\sigma = 5.8$ S/m; $\epsilon_r = 48.35$; $\rho = 1000$ kg/m³
Phantom section: Flat Section

Test Date: Date: 8/19/2015; Ambient Temp: 23 °C; Tissue Temp: 21 °C

Probe: EX3DV4 - SN3833; ConvF(3.46, 3.46, 3.46); Calibrated: 1/23/2015;
Sensor-Surface: 2mm (Mechanical Surface Detection)
Electronics: DAE4 Sn1321; Calibrated: 1/8/2015
Phantom: ELI v4.0; Type: QDOVA001BB; Serial: 1251
Measurement SW: DASY52, Version 52.8 (8); SEMCAD X Version 14.6.10 (7331)

Procedure Notes:

5600 MHz Ethertronic/ Tablet Front Edge Aux 124/Area Scan (7x9x1): Measurement grid: dx=10mm, dy=10mm
Maximum value of SAR (measured) = 1.95 W/kg

5600 MHz Ethertronic/ Tablet Front Edge Aux 124/Zoom Scan (7x7x12)/Cube 0: Measurement grid: dx=4mm, dy=4mm, dz=2mm
Reference Value = 13.77 V/m; Power Drift = 0.01 dB
Peak SAR (extrapolated) = 3.88 W/kg
SAR(1 g) = 1 W/kg
Maximum value of SAR (measured) = 2.04 W/kg

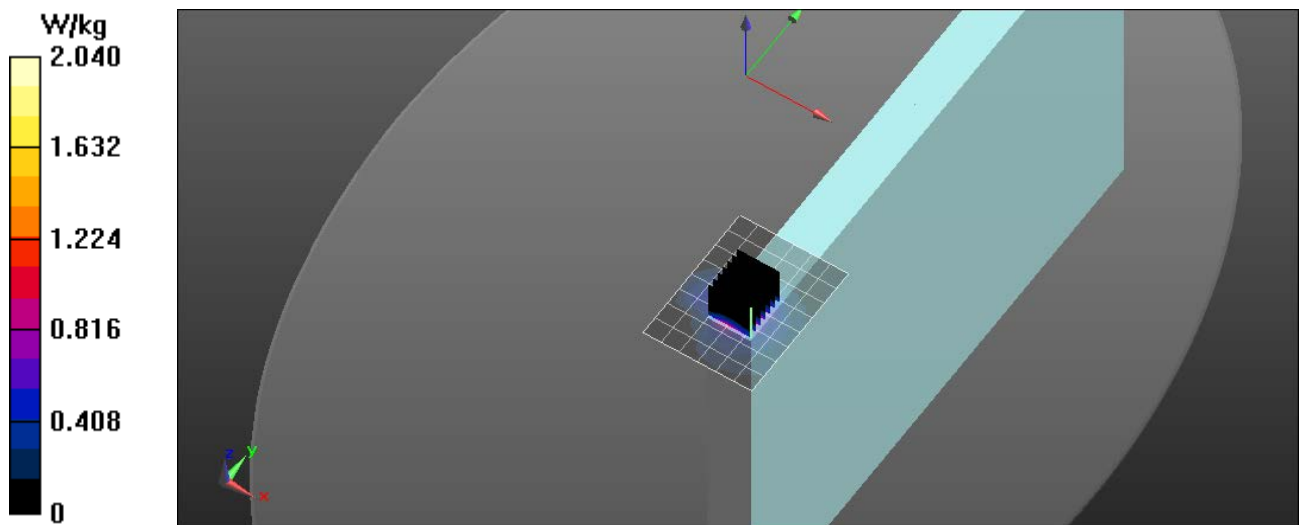

RF Exposure Lab

Plot 4

DUT: Lenovo TP00078A PC; Type: Convertible PC; Serial: MP-08F100

Communication System: WiFi 802.11a (OFDM, 6 Mbps); Frequency: 5785 MHz; Duty Cycle: 1:1
Medium: MSL 3-6 GHz; Medium parameters used (interpolated): $f = 5785$ MHz; $\sigma = 5.995$ S/m; $\epsilon_r = 48.123$; $\rho = 1000$ kg/m³
Phantom section: Flat Section

Test Date: Date: 8/18/2015; Ambient Temp: 23 °C; Tissue Temp: 21 °C

Probe: EX3DV4 - SN3833; ConvF(3.57, 3.57, 3.57); Calibrated: 1/23/2015;
Sensor-Surface: 2mm (Mechanical Surface Detection)
Electronics: DAE4 Sn1321; Calibrated: 1/8/2015
Phantom: ELI v4.0; Type: QDOVA001BB; Serial: 1251
Measurement SW: DASY52, Version 52.8 (8); SEMCAD X Version 14.6.10 (7331)

Procedure Notes:

5800 MHz Ethertronics/Tablet Front Edge Aux 157/Area Scan (7x9x1): Measurement grid: dx=10mm, dy=10mm

[Info: Interpolated medium parameters used for SAR evaluation.](#)

Maximum value of SAR (measured) = 2.32 W/kg

5800 MHz Ethertronics/Tablet Front Edge Aux 157/Zoom Scan (7x7x12)/Cube 0: Measurement grid: dx=4mm, dy=4mm, dz=2mm

Reference Value = 14.36 V/m; Power Drift = 0.02 dB

Peak SAR (extrapolated) = 5.11 W/kg

SAR(1 g) = 1.2 W/kg

[Info: Interpolated medium parameters used for SAR evaluation.](#)

Maximum value of SAR (measured) = 2.49 W/kg

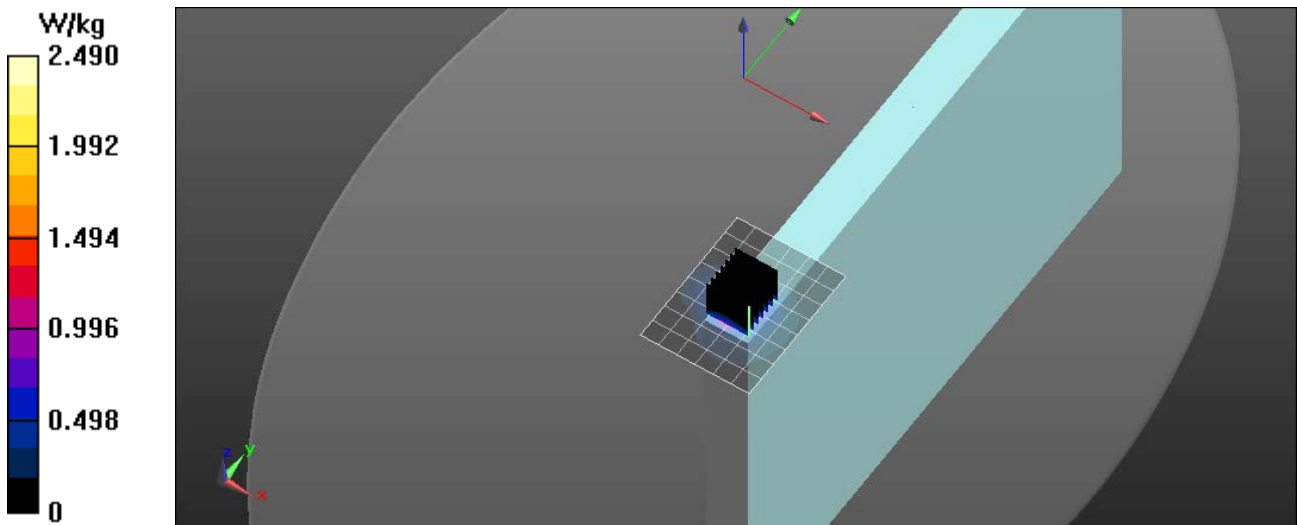

Appendix D – Probe Calibration Data Sheets



Accredited by the Swiss Accreditation Service (SAS)
The Swiss Accreditation Service is one of the signatories to the EA
Multilateral Agreement for the recognition of calibration certificates

Accreditation No.: **SCS 0108**

Client **RF Exposure Lab**

Certificate No: **EX3-3833_Jan15**

CALIBRATION CERTIFICATE

Object **EX3DV4 - SN:3833**

Calibration procedure(s) **QA CAL-01.v9, QA CAL-12.v9, QA CAL-14.v4, QA CAL-23.v5,
QA CAL-25.v6
Calibration procedure for dosimetric E-field probes**

Calibration date: **January 23, 2015**

This calibration certificate documents the traceability to national standards, which realize the physical units of measurements (SI).
The measurements and the uncertainties with confidence probability are given on the following pages and are part of the certificate.

All calibrations have been conducted in the closed laboratory facility: environment temperature (22 ± 3)°C and humidity < 70%.

Calibration Equipment used (M&TE critical for calibration)

Primary Standards	ID	Cal Date (Certificate No.)	Scheduled Calibration
Power meter E4419B	GB41293874	03-Apr-14 (No. 217-01911)	Apr-15
Power sensor E4412A	MY41498087	03-Apr-14 (No. 217-01911)	Apr-15
Reference 3 dB Attenuator	SN: S5054 (3c)	03-Apr-14 (No. 217-01915)	Apr-15
Reference 20 dB Attenuator	SN: S5277 (20x)	03-Apr-14 (No. 217-01919)	Apr-15
Reference 30 dB Attenuator	SN: S5129 (30b)	03-Apr-14 (No. 217-01920)	Apr-15
Reference Probe ES3DV2	SN: 3013	30-Dec-14 (No. ES3-3013_Dec14)	Dec-15
DAE4	SN: 660	14-Jan-15 (No. DAE4-660_Jan15)	Jan-16
Secondary Standards	ID	Check Date (in house)	Scheduled Check
RF generator HP 8648C	US3642U01700	4-Aug-99 (in house check Apr-13)	In house check: Apr-16
Network Analyzer HP 8753E	US37390585	18-Oct-01 (in house check Oct-14)	In house check: Oct-15

Calibrated by:	Name Cluadio Leubler	Function Laboratory Technician	Signature
Approved by:	Name Katja Pokovic	Function Technical Manager	Signature

Issued: January 26, 2015

This calibration certificate shall not be reproduced except in full without written approval of the laboratory.



Accredited by the Swiss Accreditation Service (SAS)

Accreditation No.: **SCS 0108**

The Swiss Accreditation Service is one of the signatories to the EA Multilateral Agreement for the recognition of calibration certificates

Glossary:

TSL	tissue simulating liquid
NORM _{x,y,z}	sensitivity in free space
ConvF	sensitivity in TSL / NORM _{x,y,z}
DCP	diode compression point
CF	crest factor (1/duty_cycle) of the RF signal
A, B, C, D	modulation dependent linearization parameters
Polarization φ	φ rotation around probe axis
Polarization ϑ	ϑ rotation around an axis that is in the plane normal to probe axis (at measurement center), i.e., $\vartheta = 0$ is normal to probe axis
Connector Angle	information used in DASY system to align probe sensor X to the robot coordinate system

Calibration is Performed According to the Following Standards:

- IEEE Std 1528-2013, "IEEE Recommended Practice for Determining the Peak Spatial-Averaged Specific Absorption Rate (SAR) in the Human Head from Wireless Communications Devices: Measurement Techniques", June 2013
- IEC 62209-1, "Procedure to measure the Specific Absorption Rate (SAR) for hand-held devices used in close proximity to the ear (frequency range of 300 MHz to 3 GHz)", February 2005

Methods Applied and Interpretation of Parameters:

- NORM_{x,y,z}**: Assessed for E-field polarization $\vartheta = 0$ ($f \leq 900$ MHz in TEM-cell; $f > 1800$ MHz: R22 waveguide). NORM_{x,y,z} are only intermediate values, i.e., the uncertainties of NORM_{x,y,z} does not affect the E^2 -field uncertainty inside TSL (see below *ConvF*).
- NORM(f)_{x,y,z}** = NORM_{x,y,z} * *frequency_response* (see Frequency Response Chart). This linearization is implemented in DASY4 software versions later than 4.2. The uncertainty of the frequency response is included in the stated uncertainty of *ConvF*.
- DCP_{x,y,z}**: DCP are numerical linearization parameters assessed based on the data of power sweep with CW signal (no uncertainty required). DCP does not depend on frequency nor media.
- PAR**: PAR is the Peak to Average Ratio that is not calibrated but determined based on the signal characteristics
- A_{x,y,z}; B_{x,y,z}; C_{x,y,z}; D_{x,y,z}; VR_{x,y,z}; A, B, C, D** are numerical linearization parameters assessed based on the data of power sweep for specific modulation signal. The parameters do not depend on frequency nor media. VR is the maximum calibration range expressed in RMS voltage across the diode.
- ConvF and Boundary Effect Parameters**: Assessed in flat phantom using E-field (or Temperature Transfer Standard for $f \leq 800$ MHz) and inside waveguide using analytical field distributions based on power measurements for $f > 800$ MHz. The same setups are used for assessment of the parameters applied for boundary compensation (alpha, depth) of which typical uncertainty values are given. These parameters are used in DASY4 software to improve probe accuracy close to the boundary. The sensitivity in TSL corresponds to NORM_{x,y,z} * *ConvF* whereby the uncertainty corresponds to that given for *ConvF*. A frequency dependent *ConvF* is used in DASY version 4.4 and higher which allows extending the validity from ± 50 MHz to ± 100 MHz.
- Spherical isotropy (3D deviation from isotropy)**: in a field of low gradients realized using a flat phantom exposed by a patch antenna.
- Sensor Offset**: The sensor offset corresponds to the offset of virtual measurement center from the probe tip (on probe axis). No tolerance required.
- Connector Angle**: The angle is assessed using the information gained by determining the NORM_x (no uncertainty required).

Probe EX3DV4

SN:3833

Manufactured: November 7, 2011
Calibrated: January 23, 2015

Calibrated for DASY/EASY Systems
(Note: non-compatible with DASY2 system!)

DASY/EASY - Parameters of Probe: EX3DV4 - SN:3833

Basic Calibration Parameters

	Sensor X	Sensor Y	Sensor Z	Unc (k=2)
Norm ($\mu\text{V}/(\text{V}/\text{m})^2$) ^A	0.47	0.49	0.35	$\pm 10.1\%$
DCP (mV) ^B	101.8	100.3	103.5	

Modulation Calibration Parameters

UID	Communication System Name		A dB	B dB $\sqrt{\mu\text{V}}$	C	D dB	VR mV	Unc ^E (k=2)
0	CW	X	0.0	0.0	1.0	0.00	131.5	$\pm 3.5\%$
		Y	0.0	0.0	1.0		133.2	
		Z	0.0	0.0	1.0		131.7	

The reported uncertainty of measurement is stated as the standard uncertainty of measurement multiplied by the coverage factor k=2, which for a normal distribution corresponds to a coverage probability of approximately 95%.

^A The uncertainties of NormX,Y,Z do not affect the E²-field uncertainty inside TSL (see Pages 5 and 6).

^B Numerical linearization parameter: uncertainty not required.

^E Uncertainty is determined using the max. deviation from linear response applying rectangular distribution and is expressed for the square of the field value.

DASY/EASY - Parameters of Probe: EX3DV4 - SN:3833

Calibration Parameter Determined in Head Tissue Simulating Media

f (MHz) ^C	Relative Permittivity ^F	Conductivity (S/m) ^F	ConvF X	ConvF Y	ConvF Z	Alpha ^G	Depth ^G (mm)	Unct. (k=2)
150	52.3	0.76	11.02	11.02	11.02	0.00	1.00	± 13.3 %
220	49.0	0.81	10.50	10.50	10.50	0.00	1.00	± 13.3 %
300	45.3	0.87	10.41	10.41	10.41	0.10	1.25	± 13.3 %
450	43.5	0.87	9.34	9.34	9.34	0.16	1.40	± 13.3 %
600	42.7	0.88	9.41	9.41	9.41	0.10	1.10	± 13.3 %
750	41.9	0.89	8.98	8.98	8.98	0.35	0.98	± 12.0 %
900	41.5	0.97	8.51	8.51	8.51	0.34	0.99	± 12.0 %
1640	40.3	1.29	7.50	7.50	7.50	0.23	1.08	± 12.0 %
1750	40.1	1.37	7.42	7.42	7.42	0.49	0.70	± 12.0 %
1900	40.0	1.40	7.29	7.29	7.29	0.57	0.62	± 12.0 %
2450	39.2	1.80	6.58	6.58	6.58	0.41	0.76	± 12.0 %
5200	36.0	4.66	4.62	4.62	4.62	0.35	1.80	± 13.1 %
5300	35.9	4.76	4.44	4.44	4.44	0.35	1.80	± 13.1 %
5500	35.6	4.96	4.18	4.18	4.18	0.40	1.80	± 13.1 %
5600	35.5	5.07	4.03	4.03	4.03	0.40	1.80	± 13.1 %
5800	35.3	5.27	4.12	4.12	4.12	0.40	1.80	± 13.1 %

^C Frequency validity above 300 MHz of ± 100 MHz only applies for DASY v4.4 and higher (see Page 2), else it is restricted to ± 50 MHz. The uncertainty is the RSS of the ConvF uncertainty at calibration frequency and the uncertainty for the indicated frequency band. Frequency validity below 300 MHz is ± 10, 25, 40, 50 and 70 MHz for ConvF assessments at 30, 64, 128, 150 and 220 MHz respectively. Above 5 GHz frequency validity can be extended to ± 110 MHz.

^F At frequencies below 3 GHz, the validity of tissue parameters (ϵ and σ) can be relaxed to ± 10% if liquid compensation formula is applied to measured SAR values. At frequencies above 3 GHz, the validity of tissue parameters (ϵ and σ) is restricted to ± 5%. The uncertainty is the RSS of the ConvF uncertainty for indicated target tissue parameters.

^G Alpha/Depth are determined during calibration. SPEAG warrants that the remaining deviation due to the boundary effect after compensation is always less than ± 1% for frequencies below 3 GHz and below ± 2% for frequencies between 3-6 GHz at any distance larger than half the probe tip diameter from the boundary.

DASY/EASY - Parameters of Probe: EX3DV4 - SN:3833

Calibration Parameter Determined in Body Tissue Simulating Media

f (MHz) ^C	Relative Permittivity ^F	Conductivity (S/m) ^F	ConvF X	ConvF Y	ConvF Z	Alpha ^G	Depth ^G (mm)	Unct. (k=2)
150	61.9	0.80	11.21	11.21	11.21	0.00	1.00	± 13.3 %
220	60.2	0.86	10.20	10.20	10.20	0.00	1.00	± 13.3 %
300	58.2	0.92	10.29	10.29	10.29	0.06	1.15	± 13.3 %
450	56.7	0.94	10.02	10.02	10.02	0.08	1.12	± 13.3 %
600	56.1	0.95	9.37	9.37	9.37	0.10	1.10	± 13.3 %
750	55.5	0.96	8.75	8.75	8.75	0.24	1.32	± 12.0 %
900	55.0	1.05	8.51	8.51	8.51	0.41	0.88	± 12.0 %
1640	53.8	1.40	7.64	7.64	7.64	0.31	0.95	± 12.0 %
1750	53.4	1.49	7.18	7.18	7.18	0.34	0.93	± 12.0 %
1900	53.3	1.52	7.04	7.04	7.04	0.60	0.67	± 12.0 %
2450	52.7	1.95	6.69	6.69	6.69	0.80	0.57	± 12.0 %
5200	49.0	5.30	3.92	3.92	3.92	0.45	1.90	± 13.1 %
5300	48.9	5.42	3.81	3.81	3.81	0.45	1.90	± 13.1 %
5500	48.6	5.65	3.52	3.52	3.52	0.50	1.90	± 13.1 %
5600	48.5	5.77	3.47	3.47	3.47	0.50	1.90	± 13.1 %
5800	48.2	6.00	3.57	3.57	3.57	0.50	1.90	± 13.1 %

^C Frequency validity above 300 MHz of ± 100 MHz only applies for DASY v4.4 and higher (see Page 2), else it is restricted to ± 50 MHz. The uncertainty is the RSS of the ConvF uncertainty at calibration frequency and the uncertainty for the indicated frequency band. Frequency validity below 300 MHz is ± 10, 25, 40, 50 and 70 MHz for ConvF assessments at 30, 64, 128, 150 and 220 MHz respectively. Above 5 GHz frequency validity can be extended to ± 110 MHz.

^F At frequencies below 3 GHz, the validity of tissue parameters (ϵ and σ) can be relaxed to ± 10% if liquid compensation formula is applied to measured SAR values. At frequencies above 3 GHz, the validity of tissue parameters (ϵ and σ) is restricted to ± 5%. The uncertainty is the RSS of the ConvF uncertainty for indicated target tissue parameters.

^G Alpha/Depth are determined during calibration. SPEAG warrants that the remaining deviation due to the boundary effect after compensation is always less than ± 1% for frequencies below 3 GHz and below ± 2% for frequencies between 3-6 GHz at any distance larger than half the probe tip diameter from the boundary.

Frequency Response of E-Field

(TEM-Cell:ifi110 EXX, Waveguide: R22)

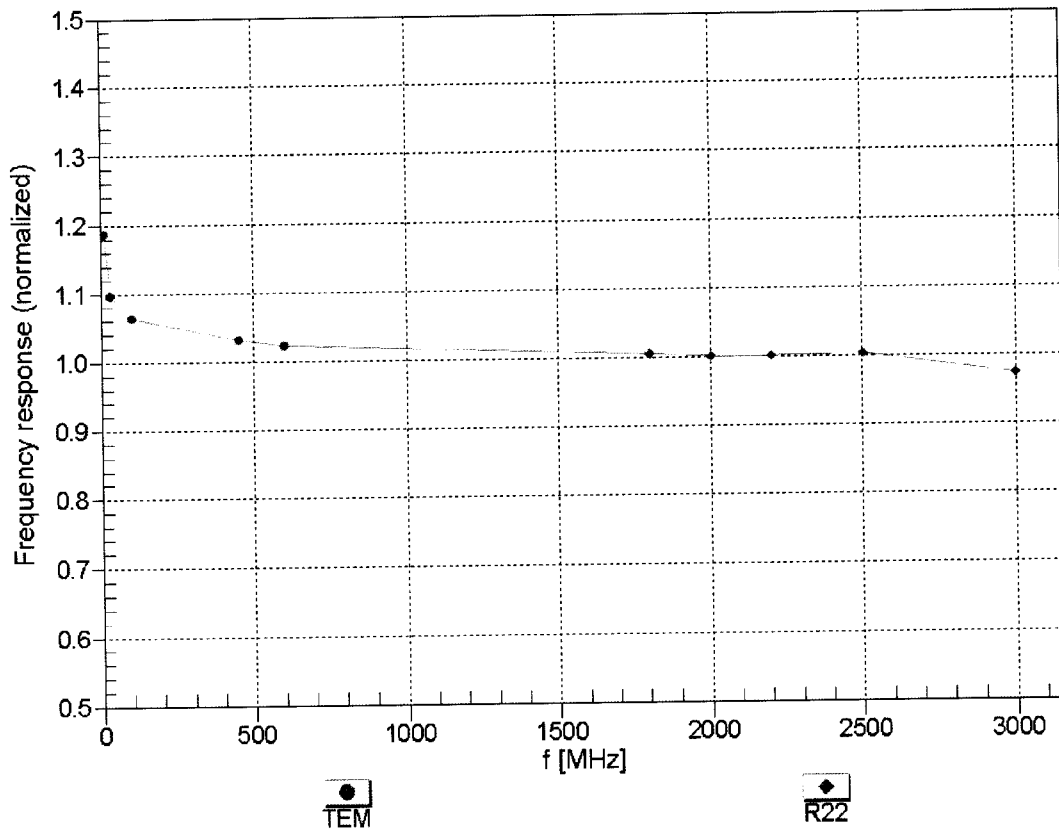

Uncertainty of Frequency Response of E-field: $\pm 6.3\%$ (k=2)

Receiving Pattern (ϕ), $\vartheta = 0^\circ$

f=600 MHz, TEM

f=1800 MHz, R22

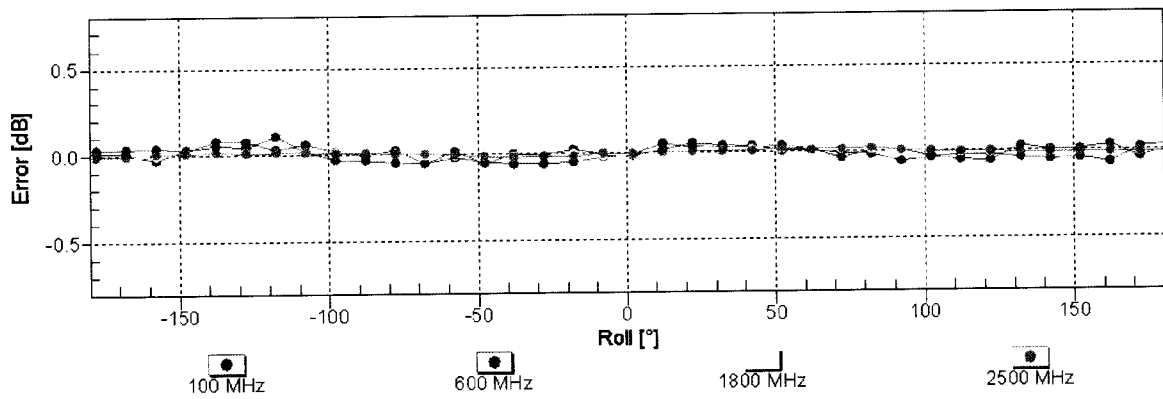
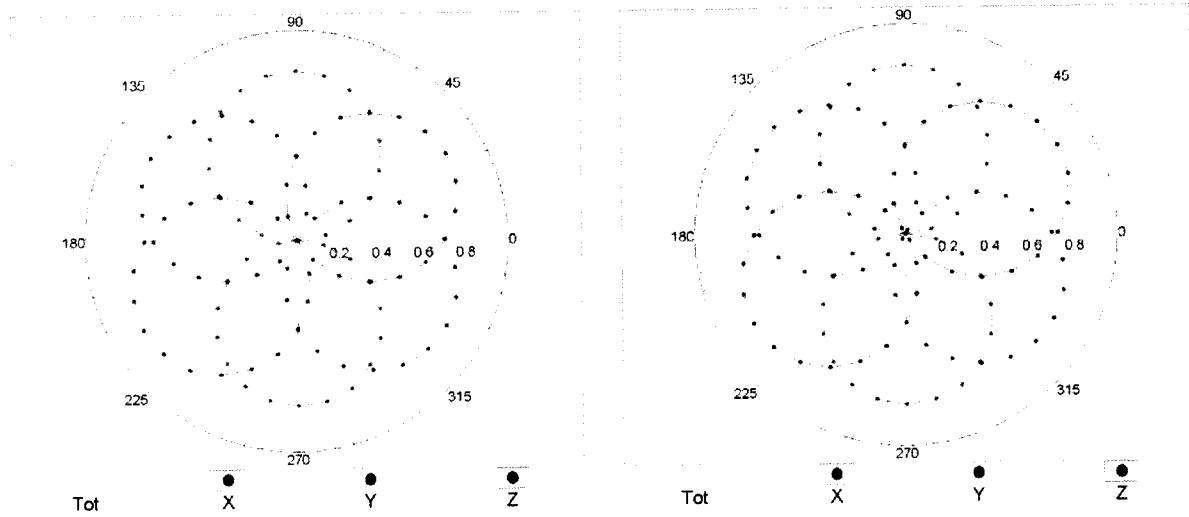

Uncertainty of Axial Isotropy Assessment: $\pm 0.5\%$ (k=2)

Dynamic Range f(SAR_{head}) (TEM cell , f_{eval}= 1900 MHz)

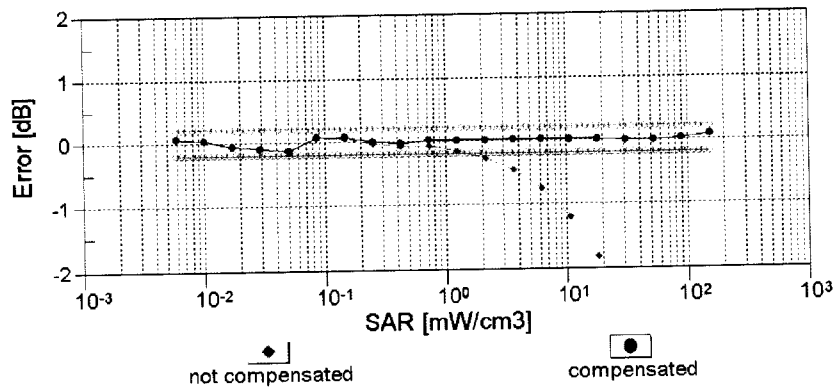
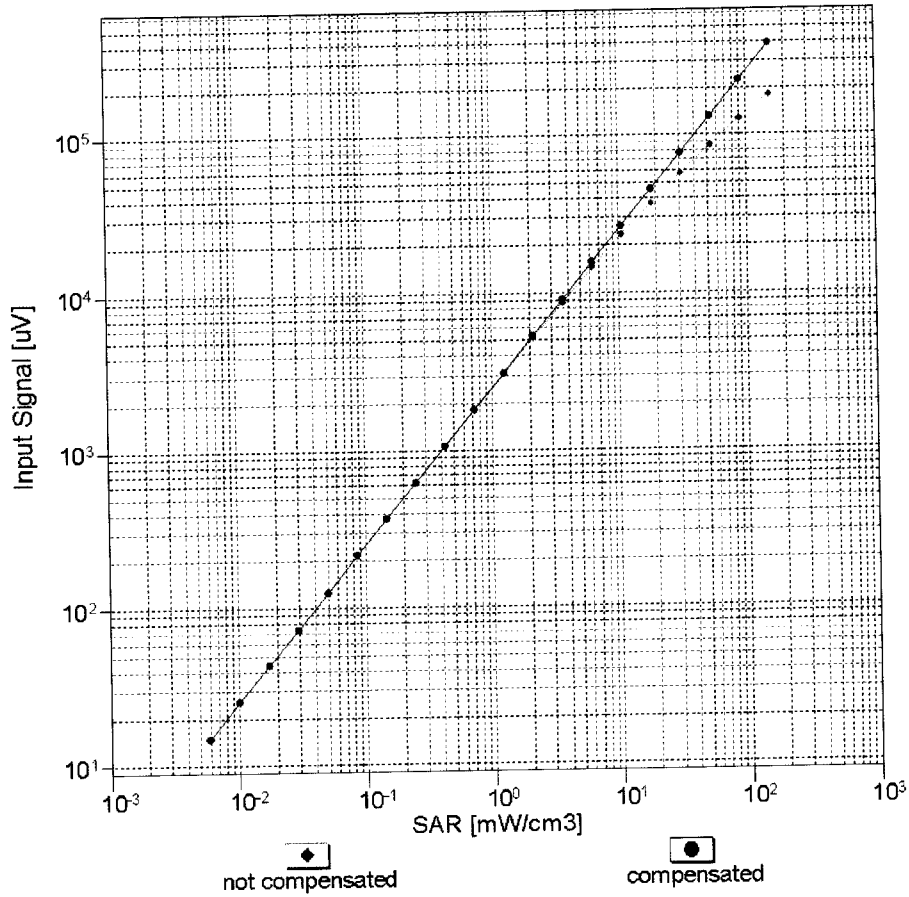

Uncertainty of Linearity Assessment: ± 0.6% (k=2)

Conversion Factor Assessment

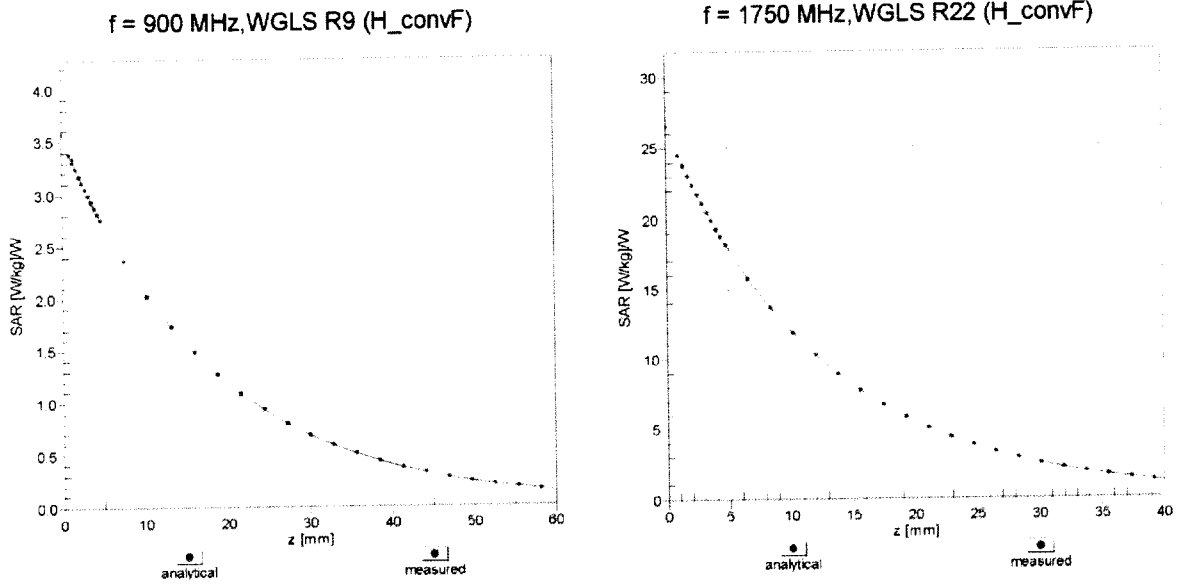

Deviation from Isotropy in Liquid Error (ϕ, ϑ), f = 900 MHz

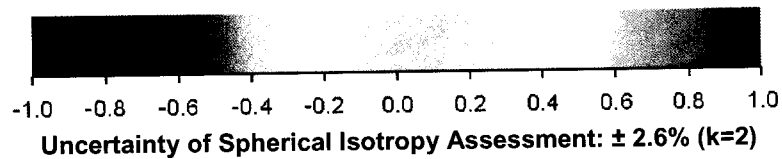
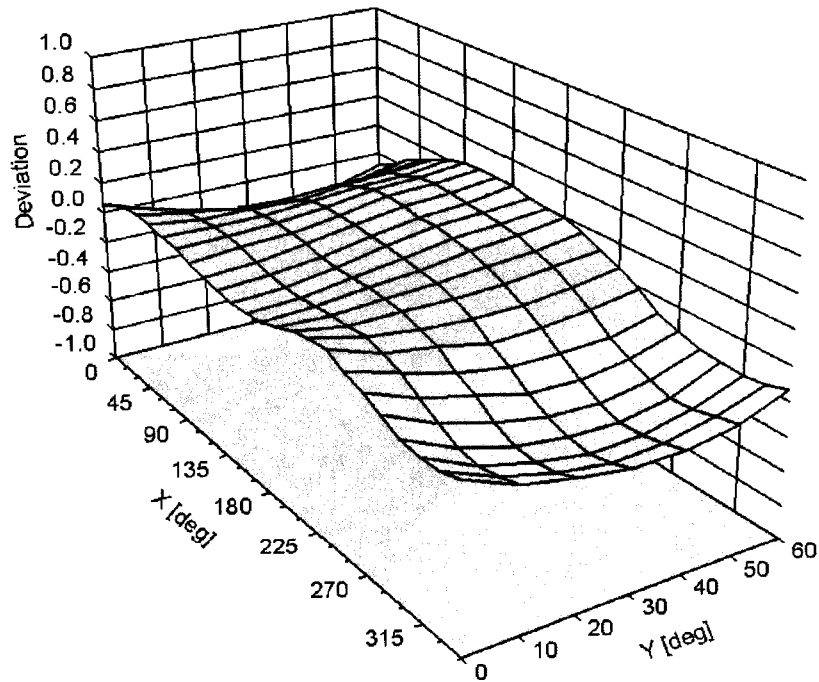

DASY/EASY - Parameters of Probe: EX3DV4 - SN:3833

Other Probe Parameters

Sensor Arrangement	Triangular
Connector Angle (°)	12.2
Mechanical Surface Detection Mode	enabled
Optical Surface Detection Mode	disabled
Probe Overall Length	337 mm
Probe Body Diameter	10 mm
Tip Length	9 mm
Tip Diameter	2.5 mm
Probe Tip to Sensor X Calibration Point	1 mm
Probe Tip to Sensor Y Calibration Point	1 mm
Probe Tip to Sensor Z Calibration Point	1 mm
Recommended Measurement Distance from Surface	1.4 mm

Appendix E – Dipole Calibration Data Sheets



Accredited by the Swiss Accreditation Service (SAS)
The Swiss Accreditation Service is one of the signatories to the EA
Multilateral Agreement for the recognition of calibration certificates

Accreditation No.: **SCS 108**

Client **RF Exposure Lab**

Certificate No: **D2450V2-829_Dec12**

CALIBRATION CERTIFICATE

Object **D2450V2 - SN: 829**

Calibration procedure(s) **QA CAL-05.v8**
Calibration procedure for dipole validation kits above 700 MHz

Calibration date: **December 04, 2012**

This calibration certificate documents the traceability to national standards, which realize the physical units of measurements (SI).
The measurements and the uncertainties with confidence probability are given on the following pages and are part of the certificate.

All calibrations have been conducted in the closed laboratory facility: environment temperature (22 ± 3)°C and humidity < 70%.

Calibration Equipment used (M&TE critical for calibration)

Primary Standards	ID #	Cal Date (Certificate No.)	Scheduled Calibration
Power meter EPM-442A	GB37480704	01-Nov-12 (No. 217-01640)	Oct-13
Power sensor HP 8481A	US37292783	01-Nov-12 (No. 217-01640)	Oct-13
Reference 20 dB Attenuator	SN: 5058 (20k)	27-Mar-12 (No. 217-01530)	Apr-13
Type-N mismatch combination	SN: 5047.3 / 06327	27-Mar-12 (No. 217-01533)	Apr-13
Reference Probe ES3DV3	SN: 3205	30-Dec-11 (No. ES3-3205_Dec11)	Dec-12
DAE4	SN: 601	27-Jun-12 (No. DAE4-601_Jun12)	Jun-13
Secondary Standards	ID #	Check Date (in house)	Scheduled Check
Power sensor HP 8481A	MY41092317	18-Oct-02 (in house check Oct-11)	In house check: Oct-13
RF generator R&S SMT-06	100005	04-Aug-99 (in house check Oct-11)	In house check: Oct-13
Network Analyzer HP 8753E	US37390585 S4206	18-Oct-01 (in house check Oct-12)	In house check: Oct-13

Calibrated by:	Name Leif Klysner	Function Laboratory Technician	Signature
Approved by:	Katja Pokovic	Technical Manager	

Issued: December 4, 2012

This calibration certificate shall not be reproduced except in full without written approval of the laboratory.



Accredited by the Swiss Accreditation Service (SAS)
The Swiss Accreditation Service is one of the signatories to the EA
Multilateral Agreement for the recognition of calibration certificates

Glossary:

TSL	tissue simulating liquid
ConvF	sensitivity in TSL / NORM x,y,z
N/A	not applicable or not measured

Calibration is Performed According to the Following Standards:

- IEEE Std 1528-2003, "IEEE Recommended Practice for Determining the Peak Spatial-Averaged Specific Absorption Rate (SAR) in the Human Head from Wireless Communications Devices: Measurement Techniques", December 2003
- IEC 62209-1, "Procedure to measure the Specific Absorption Rate (SAR) for hand-held devices used in close proximity to the ear (frequency range of 300 MHz to 3 GHz)", February 2005
- Federal Communications Commission Office of Engineering & Technology (FCC OET), "Evaluating Compliance with FCC Guidelines for Human Exposure to Radiofrequency Electromagnetic Fields; Additional Information for Evaluating Compliance of Mobile and Portable Devices with FCC Limits for Human Exposure to Radiofrequency Emissions", Supplement C (Edition 01-01) to Bulletin 65

Additional Documentation:

- DASY4/5 System Handbook

Methods Applied and Interpretation of Parameters:

- Measurement Conditions:** Further details are available from the Validation Report at the end of the certificate. All figures stated in the certificate are valid at the frequency indicated.
- Antenna Parameters with TSL:** The dipole is mounted with the spacer to position its feed point exactly below the center marking of the flat phantom section, with the arms oriented parallel to the body axis.
- Feed Point Impedance and Return Loss:** These parameters are measured with the dipole positioned under the liquid filled phantom. The impedance stated is transformed from the measurement at the SMA connector to the feed point. The Return Loss ensures low reflected power. No uncertainty required.
- Electrical Delay:** One-way delay between the SMA connector and the antenna feed point. No uncertainty required.
- SAR measured:** SAR measured at the stated antenna input power.
- SAR normalized:** SAR as measured, normalized to an input power of 1 W at the antenna connector.
- SAR for nominal TSL parameters:** The measured TSL parameters are used to calculate the nominal SAR result.

The reported uncertainty of measurement is stated as the standard uncertainty of measurement multiplied by the coverage factor $k=2$, which for a normal distribution corresponds to a coverage probability of approximately 95%.

Measurement Conditions

DASY system configuration, as far as not given on page 1.

DASY Version	DASY5	V52.8.3
Extrapolation	Advanced Extrapolation	
Phantom	Modular Flat Phantom	
Distance Dipole Center - TSL	10 mm	with Spacer
Zoom Scan Resolution	dx, dy, dz = 5 mm	
Frequency	2450 MHz \pm 1 MHz	

Head TSL parameters

The following parameters and calculations were applied.

	Temperature	Permittivity	Conductivity
Nominal Head TSL parameters	22.0 °C	39.2	1.80 mho/m
Measured Head TSL parameters	(22.0 \pm 0.2) °C	38.2 \pm 6 %	1.84 mho/m \pm 6 %
Head TSL temperature change during test	< 0.5 °C	----	----

SAR result with Head TSL

SAR averaged over 1 cm³ (1 g) of Head TSL	Condition	
SAR measured	250 mW input power	13.7 W/kg
SAR for nominal Head TSL parameters	normalized to 1W	53.9 W/kg \pm 17.0 % (k=2)

SAR averaged over 10 cm³ (10 g) of Head TSL	condition	
SAR measured	250 mW input power	6.33 W/kg
SAR for nominal Head TSL parameters	normalized to 1W	25.1 W/kg \pm 16.5 % (k=2)

Body TSL parameters

The following parameters and calculations were applied.

	Temperature	Permittivity	Conductivity
Nominal Body TSL parameters	22.0 °C	52.7	1.95 mho/m
Measured Body TSL parameters	(22.0 \pm 0.2) °C	50.7 \pm 6 %	2.02 mho/m \pm 6 %
Body TSL temperature change during test	< 0.5 °C	----	----

SAR result with Body TSL

SAR averaged over 1 cm³ (1 g) of Body TSL	Condition	
SAR measured	250 mW input power	13.2 W/kg
SAR for nominal Body TSL parameters	normalized to 1W	51.5 W/kg \pm 17.0 % (k=2)

SAR averaged over 10 cm³ (10 g) of Body TSL	condition	
SAR measured	250 mW input power	6.08 W/kg
SAR for nominal Body TSL parameters	normalized to 1W	24.0 W/kg \pm 16.5 % (k=2)

Appendix

Antenna Parameters with Head TSL

Impedance, transformed to feed point	53.1 Ω + 4.2 j Ω
Return Loss	- 25.9 dB

Antenna Parameters with Body TSL

Impedance, transformed to feed point	49.7 Ω + 5.1 j Ω
Return Loss	- 25.9 dB

General Antenna Parameters and Design

Electrical Delay (one direction)	1.158 ns
----------------------------------	----------

After long term use with 100W radiated power, only a slight warming of the dipole near the feedpoint can be measured.

The dipole is made of standard semirigid coaxial cable. The center conductor of the feeding line is directly connected to the second arm of the dipole. The antenna is therefore short-circuited for DC-signals. On some of the dipoles, small end caps are added to the dipole arms in order to improve matching when loaded according to the position as explained in the "Measurement Conditions" paragraph. The SAR data are not affected by this change. The overall dipole length is still according to the Standard.

No excessive force must be applied to the dipole arms, because they might bend or the soldered connections near the feedpoint may be damaged.

Additional EUT Data

Manufactured by	SPEAG
Manufactured on	December 11, 2008

DASY5 Validation Report for Head TSL

Date: 04.12.2012

Test Laboratory: SPEAG, Zurich, Switzerland

DUT: Dipole 2450 MHz; Type: D2450V2; Serial: D2450V2 - SN: 829

Communication System: CW; Frequency: 2450 MHz

Medium parameters used: $f = 2450$ MHz; $\sigma = 1.84$ mho/m; $\epsilon_r = 38.2$; $\rho = 1000$ kg/m³

Phantom section: Flat Section

Measurement Standard: DASY5 (IEEE/IEC/ANSI C63.19-2007)

DASY52 Configuration:

- Probe: ES3DV3 - SN3205; ConvF(4.45, 4.45, 4.45); Calibrated: 30.12.2011;
- Sensor-Surface: 3mm (Mechanical Surface Detection)
- Electronics: DAE4 Sn601; Calibrated: 27.06.2012
- Phantom: Flat Phantom 5.0 (front); Type: QD000P50AA; Serial: 1001
- DASY52 52.8.3(988); SEMCAD X 14.6.7(6848)

Dipole Calibration for Head Tissue/Pin=250 mW, d=10mm/Zoom Scan (7x7x7)/Cube 0:

Measurement grid: dx=5mm, dy=5mm, dz=5mm

Reference Value = 102.1 V/m; Power Drift = 0.05 dB

Peak SAR (extrapolated) = 28.3 W/kg

SAR(1 g) = 13.7 W/kg; SAR(10 g) = 6.33 W/kg

Maximum value of SAR (measured) = 17.8 W/kg

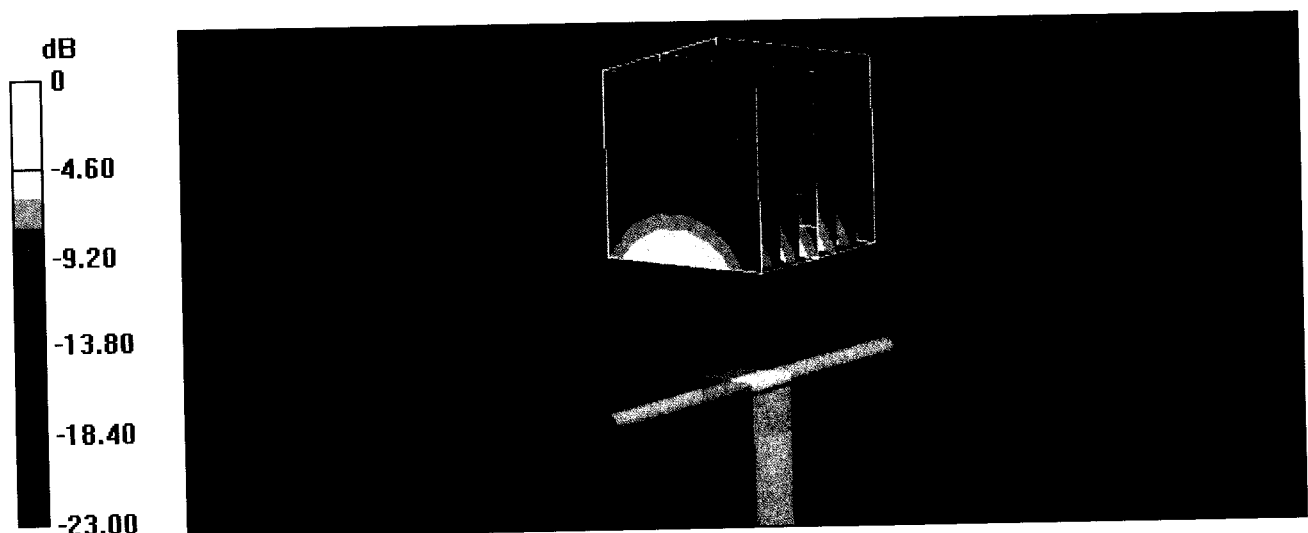

0 dB = 17.8 W/kg = 12.50 dBW/kg

Impedance Measurement Plot for Head TSL

4 Dec 2012 10:08:57

[CH1] S11 1 U FS 1: 53.113 Ω 4.1680 Ω 270.76 μH 2 450.000 000 MHz

*
De1
C Δ
Avg
16
H1d

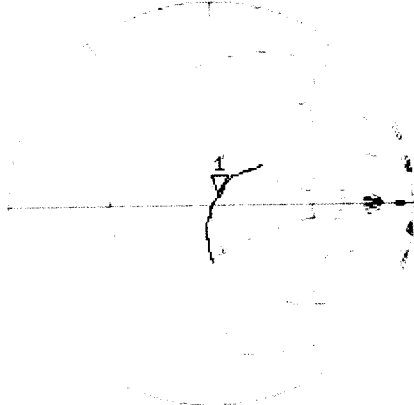

CH2 S11 LOG 5 dB/REF -20 dB 1: -25.942 dB 2 450.000 000 MHz

C Δ
Avg
16
H1d

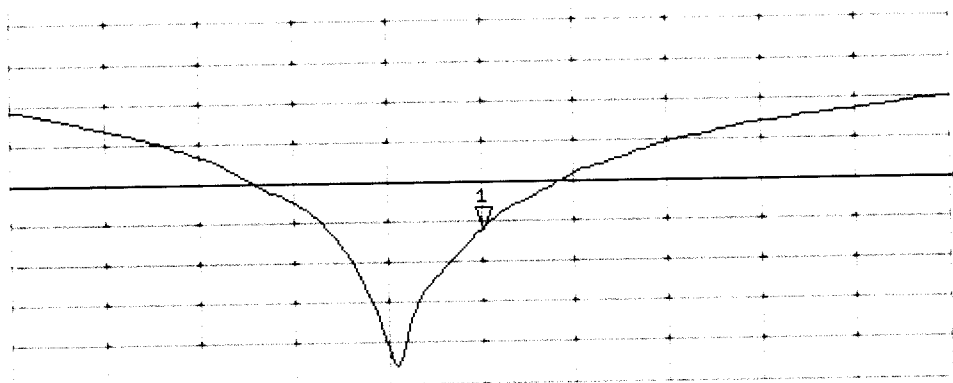

START 2 250.000 000 MHz STOP 2 650.000 000 MHz

DASY5 Validation Report for Body TSL

Date: 04.12.2012

Test Laboratory: SPEAG, Zurich, Switzerland

DUT: Dipole 2450 MHz; Type: D2450V2; Serial: D2450V2 - SN: 829

Communication System: CW; Frequency: 2450 MHz

Medium parameters used: $f = 2450$ MHz; $\sigma = 2.02$ mho/m; $\epsilon_r = 50.7$; $\rho = 1000$ kg/m³

Phantom section: Flat Section

Measurement Standard: DASY5 (IEEE/IEC/ANSI C63.19-2007)

DASY52 Configuration:

- Probe: ES3DV3 - SN3205; ConvF(4.26, 4.26, 4.26); Calibrated: 30.12.2011;
- Sensor-Surface: 3mm (Mechanical Surface Detection)
- Electronics: DAE4 Sn601; Calibrated: 27.06.2012
- Phantom: Flat Phantom 5.0 (back); Type: QD000P50AA; Serial: 1002
- DASY52 52.8.3(988); SEMCAD X 14.6.7(6848)

Dipole Calibration for Body Tissue/Pin=250 mW, d=10mm/Zoom Scan (7x7x7)/Cube 0:

Measurement grid: dx=5mm, dy=5mm, dz=5mm

Reference Value = 102.1 V/m; Power Drift = 0.05 dB

Peak SAR (extrapolated) = 27.4 W/kg

SAR(1 g) = 13.2 W/kg; SAR(10 g) = 6.08 W/kg

Maximum value of SAR (measured) = 17.5 W/kg

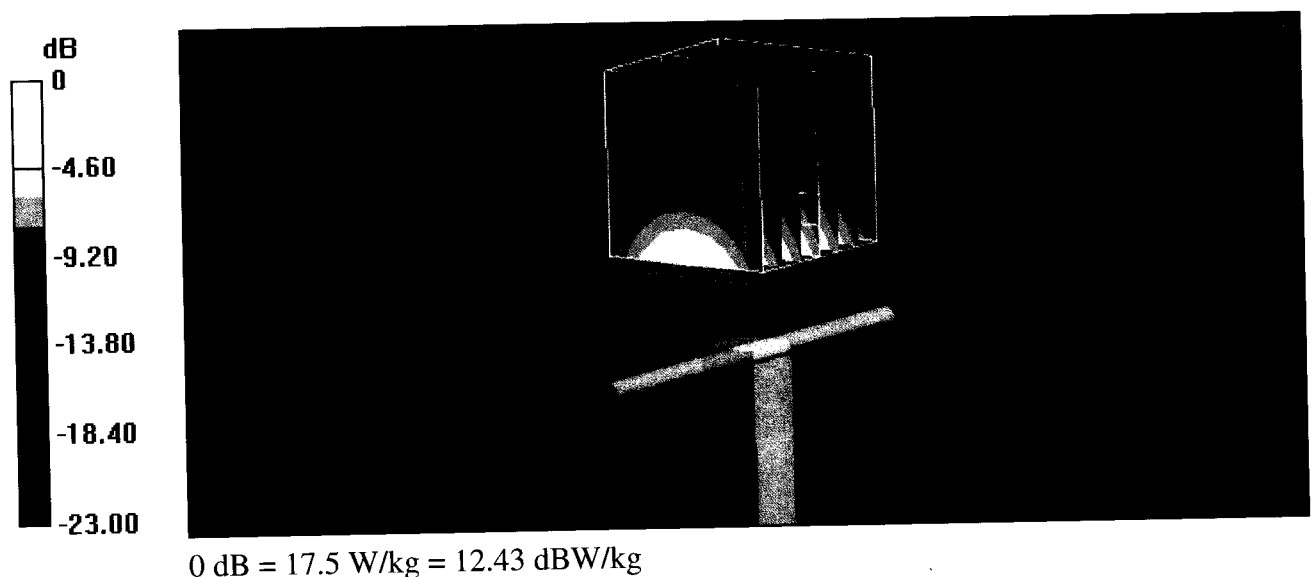

Impedance Measurement Plot for Body TSL

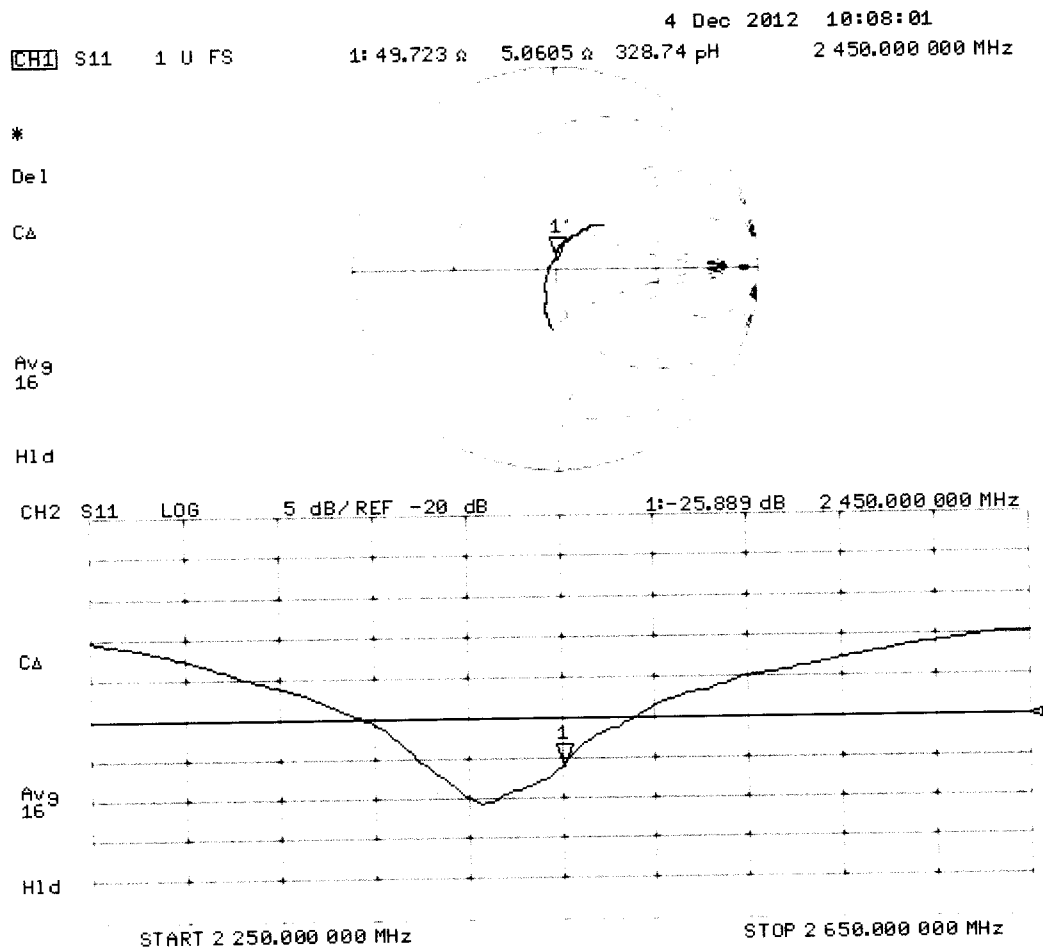

Extended Calibration

Usage of SAR dipoles calibrated less than 2 years ago but more than 1 year ago were confirmed in maintaining return loss (< -20 dB, within 20% of prior calibration) and impedance (within 5 ohm from prior calibration) requirements per extended calibrations in KDB Publication 865664 D01 v01r03.

D2450V2 SN: 829 - Head						
Date of Measurement	Return Loss (dB)	$\Delta\%$	Impedance (Ω)	$\Delta\Omega$	Impedance Imaginary (j Ω)	$\Delta\Omega$
12/4/2012	-25.9		53.1		4.2	
12/5/2013	-26.5	2.3	52.6	-0.5	3.8	-0.4
12/5/2014	-24.6	-5.0	51.6	-1.5	4.9	0.7

D2450V2 SN: 829 - Body						
Date of Measurement	Return Loss (dB)	$\Delta\%$	Impedance (Ω)	$\Delta\Omega$	Impedance Imaginary (j Ω)	$\Delta\Omega$
12/4/2012	-25.9		49.7		5.1	
12/5/2013	-26.2	1.2	48.5	-1.2	4.6	-0.5
12/4/2014	-24.6	-5.0	47.6	-2.1	5.9	0.8



Accredited by the Swiss Accreditation Service (SAS)
The Swiss Accreditation Service is one of the signatories to the EA
Multilateral Agreement for the recognition of calibration certificates

Accreditation No.: **SCS 108**

Client **RF Exposure Lab**

Certificate No: **D5GHzV2-1085_Dec12**

CALIBRATION CERTIFICATE

Object **D5GHzV2 - SN: 1085**

Calibration procedure(s) **QA CAL-22.v1
Calibration procedure for dipole validation kits between 3-6 GHz**

Calibration date: **December 11, 2012**

This calibration certificate documents the traceability to national standards, which realize the physical units of measurements (SI).
The measurements and the uncertainties with confidence probability are given on the following pages and are part of the certificate.

All calibrations have been conducted in the closed laboratory facility: environment temperature (22 ± 3)°C and humidity < 70%.

Calibration Equipment used (M&TE critical for calibration)

Primary Standards	ID #	Cal Date (Certificate No.)	Scheduled Calibration
Power meter EPM-442A	GB37480704	01-Nov-12 (No. 217-01640)	Oct-13
Power sensor HP 8481A	US37292783	01-Nov-12 (No. 217-01640)	Oct-13
Reference 20 dB Attenuator	SN: 5058 (20k)	27-Mar-12 (No. 217-01530)	Apr-13
Type-N mismatch combination	SN: 5047.3 / 06327	27-Mar-12 (No. 217-01533)	Apr-13
Reference Probe EX3DV4	SN: 3503	30-Dec-11 (No. EX3-3503_Dec11)	Dec-12
DAE4	SN: 601	27-Jun-12 (No. DAE4-601_Jun12)	Jun-13
Secondary Standards	ID #	Check Date (in house)	Scheduled Check
Power sensor HP 8481A	MY41092317	18-Oct-02 (in house check Oct-11)	In house check: Oct-13
RF generator R&S SMT-06	100005	04-Aug-99 (in house check Oct-11)	In house check: Oct-13
Network Analyzer HP 8753E	US37390585 S4206	18-Oct-01 (in house check Oct-12)	In house check: Oct-13

Calibrated by:	Name Israe El-Naouq	Function Laboratory Technician	Signature
Approved by:	Katja Pokovic	Technical Manager	

Issued: December 11, 2012

This calibration certificate shall not be reproduced except in full without written approval of the laboratory.



Accredited by the Swiss Accreditation Service (SAS)
The Swiss Accreditation Service is one of the signatories to the EA
Multilateral Agreement for the recognition of calibration certificates

Glossary:

TSL	tissue simulating liquid
ConvF	sensitivity in TSL / NORM x,y,z
N/A	not applicable or not measured

Calibration is Performed According to the Following Standards:

- IEC 62209-2, "Evaluation of Human Exposure to Radio Frequency Fields from Handheld and Body-Mounted Wireless Communication Devices in the Frequency Range of 30 MHz to 6 GHz: Human models, Instrumentation, and Procedures"; Part 2: "Procedure to determine the Specific Absorption Rate (SAR) for including accessories and multiple transmitters", March 2010
- Federal Communications Commission Office of Engineering & Technology (FCC OET), "Evaluating Compliance with FCC Guidelines for Human Exposure to Radiofrequency Electromagnetic Fields; Additional Information for Evaluating Compliance of Mobile and Portable Devices with FCC Limits for Human Exposure to Radiofrequency Emissions", Supplement C (Edition 01-01) to Bulletin 65

Additional Documentation:

- DASY4/5 System Handbook

Methods Applied and Interpretation of Parameters:

- Measurement Conditions:** Further details are available from the Validation Report at the end of the certificate. All figures stated in the certificate are valid at the frequency indicated.
- Antenna Parameters with TSL:** The dipole is mounted with the spacer to position its feed point exactly below the center marking of the flat phantom section, with the arms oriented parallel to the body axis.
- Feed Point Impedance and Return Loss:** These parameters are measured with the dipole positioned under the liquid filled phantom. The impedance stated is transformed from the measurement at the SMA connector to the feed point. The Return Loss ensures low reflected power. No uncertainty required.
- Electrical Delay:** One-way delay between the SMA connector and the antenna feed point. No uncertainty required.
- SAR measured:** SAR measured at the stated antenna input power.
- SAR normalized:** SAR as measured, normalized to an input power of 1 W at the antenna connector.
- SAR for nominal TSL parameters:** The measured TSL parameters are used to calculate the nominal SAR result.

The reported uncertainty of measurement is stated as the standard uncertainty of measurement multiplied by the coverage factor $k=2$, which for a normal distribution corresponds to a coverage probability of approximately 95%.

Measurement Conditions

DASY system configuration, as far as not given on page 1.

DASY Version	DASY5	V52.8.3
Extrapolation	Advanced Extrapolation	
Phantom	Modular Flat Phantom V5.0	
Distance Dipole Center - TSL	10 mm	with Spacer
Zoom Scan Resolution	dx, dy = 4.0 mm, dz = 1.4 mm	Graded Ratio = 1.4 (Z direction)
Frequency	5200 MHz ± 1 MHz 5300 MHz ± 1 MHz 5600 MHz ± 1 MHz 5800 MHz ± 1 MHz	

Head TSL parameters at 5200 MHz

The following parameters and calculations were applied.

	Temperature	Permittivity	Conductivity
Nominal Head TSL parameters	22.0 °C	36.0	4.66 mho/m
Measured Head TSL parameters	(22.0 ± 0.2) °C	34.8 ± 6 %	4.53 mho/m ± 6 %
Head TSL temperature change during test	< 0.5 °C	----	----

SAR result with Head TSL at 5200 MHz

SAR averaged over 1 cm³ (1 g) of Head TSL	Condition	
SAR measured	100 mW input power	8.20 W/kg
SAR for nominal Head TSL parameters	normalized to 1W	81.4 W/kg ± 19.9 % (k=2)

SAR averaged over 10 cm³ (10 g) of Head TSL	condition	
SAR measured	100 mW input power	2.35 W/kg
SAR for nominal Head TSL parameters	normalized to 1W	23.3 W/kg ± 19.5 % (k=2)

Head TSL parameters at 5300 MHz

The following parameters and calculations were applied.

	Temperature	Permittivity	Conductivity
Nominal Head TSL parameters	22.0 °C	35.9	4.76 mho/m
Measured Head TSL parameters	(22.0 ± 0.2) °C	34.7 ± 6 %	4.63 mho/m ± 6 %
Head TSL temperature change during test	< 0.5 °C	----	----

SAR result with Head TSL at 5300 MHz

SAR averaged over 1 cm³ (1 g) of Head TSL	Condition	
SAR measured	100 mW input power	8.35 W/kg
SAR for nominal Head TSL parameters	normalized to 1W	82.9 W / kg ± 19.9 % (k=2)

SAR averaged over 10 cm³ (10 g) of Head TSL	condition	
SAR measured	100 mW input power	2.39 W/kg
SAR for nominal Head TSL parameters	normalized to 1W	23.7 W/kg ± 19.5 % (k=2)

Head TSL parameters at 5600 MHz

The following parameters and calculations were applied.

	Temperature	Permittivity	Conductivity
Nominal Head TSL parameters	22.0 °C	35.5	5.07 mho/m
Measured Head TSL parameters	(22.0 ± 0.2) °C	34.2 ± 6 %	4.93 mho/m ± 6 %
Head TSL temperature change during test	< 0.5 °C	----	----

SAR result with Head TSL at 5600 MHz

SAR averaged over 1 cm ³ (1 g) of Head TSL	Condition	
SAR measured	100 mW input power	8.69 W/kg
SAR for nominal Head TSL parameters	normalized to 1W	86.1 W/kg ± 19.9 % (k=2)

SAR averaged over 10 cm ³ (10 g) of Head TSL	condition	
SAR measured	100 mW input power	2.48 W/kg
SAR for nominal Head TSL parameters	normalized to 1W	24.5 W/kg ± 19.5 % (k=2)

Head TSL parameters at 5800 MHz

The following parameters and calculations were applied.

	Temperature	Permittivity	Conductivity
Nominal Head TSL parameters	22.0 °C	35.3	5.27 mho/m
Measured Head TSL parameters	(22.0 ± 0.2) °C	34.0 ± 6 %	5.15 mho/m ± 6 %
Head TSL temperature change during test	< 0.5 °C	----	----

SAR result with Head TSL at 5800 MHz

SAR averaged over 1 cm ³ (1 g) of Head TSL	Condition	
SAR measured	100 mW input power	8.16 W/kg
SAR for nominal Head TSL parameters	normalized to 1W	80.9 W/kg ± 19.9 % (k=2)

SAR averaged over 10 cm ³ (10 g) of Head TSL	condition	
SAR measured	100 mW input power	2.33 W/kg
SAR for nominal Head TSL parameters	normalized to 1W	23.1 W/kg ± 19.5 % (k=2)

Body TSL parameters at 5200 MHz

The following parameters and calculations were applied.

	Temperature	Permittivity	Conductivity
Nominal Body TSL parameters	22.0 °C	49.0	5.30 mho/m
Measured Body TSL parameters	(22.0 ± 0.2) °C	46.8 ± 6 %	5.35 mho/m ± 6 %
Body TSL temperature change during test	< 0.5 °C	----	----

SAR result with Body TSL at 5200 MHz

SAR averaged over 1 cm ³ (1 g) of Body TSL	Condition	
SAR measured	100 mW input power	7.41 W/kg
SAR for nominal Body TSL parameters	normalized to 1W	73.4 W/kg ± 19.9 % (k=2)

SAR averaged over 10 cm ³ (10 g) of Body TSL	condition	
SAR measured	100 mW input power	2.08 W/kg
SAR for nominal Body TSL parameters	normalized to 1W	20.6 W/kg ± 19.5 % (k=2)

Body TSL parameters at 5300 MHz

The following parameters and calculations were applied.

	Temperature	Permittivity	Conductivity
Nominal Body TSL parameters	22.0 °C	48.9	5.42 mho/m
Measured Body TSL parameters	(22.0 ± 0.2) °C	46.7 ± 6 %	5.47 mho/m ± 6 %
Body TSL temperature change during test	< 0.5 °C	----	----

SAR result with Body TSL at 5300 MHz

SAR averaged over 1 cm ³ (1 g) of Body TSL	Condition	
SAR measured	100 mW input power	7.43 W/kg
SAR for nominal Body TSL parameters	normalized to 1W	73.6 W/kg ± 19.9 % (k=2)

SAR averaged over 10 cm ³ (10 g) of Body TSL	condition	
SAR measured	100 mW input power	2.09 W/kg
SAR for nominal Body TSL parameters	normalized to 1W	20.7 W/kg ± 19.5 % (k=2)

Body TSL parameters at 5600 MHz

The following parameters and calculations were applied.

	Temperature	Permittivity	Conductivity
Nominal Body TSL parameters	22.0 °C	48.5	5.77 mho/m
Measured Body TSL parameters	(22.0 ± 0.2) °C	46.2 ± 6 %	5.86 mho/m ± 6 %
Body TSL temperature change during test	< 0.5 °C	----	----

SAR result with Body TSL at 5600 MHz

SAR averaged over 1 cm ³ (1 g) of Body TSL	Condition	
SAR measured	100 mW input power	7.98 W/kg
SAR for nominal Body TSL parameters	normalized to 1W	79.1 W/kg ± 19.9 % (k=2)

SAR averaged over 10 cm ³ (10 g) of Body TSL	condition	
SAR measured	100 mW input power	2.22 W/kg
SAR for nominal Body TSL parameters	normalized to 1W	21.9 W/kg ± 19.5 % (k=2)

Body TSL parameters at 5800 MHz

The following parameters and calculations were applied.

	Temperature	Permittivity	Conductivity
Nominal Body TSL parameters	22.0 °C	48.2	6.00 mho/m
Measured Body TSL parameters	(22.0 ± 0.2) °C	45.9 ± 6 %	6.13 mho/m ± 6 %
Body TSL temperature change during test	< 0.5 °C	----	----

SAR result with Body TSL at 5800 MHz

SAR averaged over 1 cm ³ (1 g) of Body TSL	Condition	
SAR measured	100 mW input power	7.36 W/kg
SAR for nominal Body TSL parameters	normalized to 1W	72.9 W/kg ± 19.9 % (k=2)

SAR averaged over 10 cm ³ (10 g) of Body TSL	condition	
SAR measured	100 mW input power	2.04 W/kg
SAR for nominal Body TSL parameters	normalized to 1W	20.2 W/kg ± 19.5 % (k=2)

Appendix

Antenna Parameters with Head TSL at 5200 MHz

Impedance, transformed to feed point	50.9 Ω - 9.9 j Ω
Return Loss	- 20.2 dB

Antenna Parameters with Head TSL at 5300 MHz

Impedance, transformed to feed point	48.7 Ω - 5.6 j Ω
Return Loss	- 24.7 dB

Antenna Parameters with Head TSL at 5600 MHz

Impedance, transformed to feed point	56.1 Ω - 4.4 j Ω
Return Loss	- 23.0 dB

Antenna Parameters with Head TSL at 5800 MHz

Impedance, transformed to feed point	51.9 Ω - 4.6 j Ω
Return Loss	- 26.2 dB

Antenna Parameters with Body TSL at 5200 MHz

Impedance, transformed to feed point	50.0 Ω - 9.5 j Ω
Return Loss	- 20.5 dB

Antenna Parameters with Body TSL at 5300 MHz

Impedance, transformed to feed point	49.7 Ω - 5.0 j Ω
Return Loss	- 26.0 dB

Antenna Parameters with Body TSL at 5600 MHz

Impedance, transformed to feed point	56.5 Ω - 3.4 j Ω
Return Loss	- 23.2 dB

Antenna Parameters with Body TSL at 5800 MHz

Impedance, transformed to feed point	53.5 Ω - 4.7 j Ω
Return Loss	- 25.0 dB

General Antenna Parameters and Design

Electrical Delay (one direction)	1.207 ns
----------------------------------	----------

After long term use with 100W radiated power, only a slight warming of the dipole near the feedpoint can be measured.

The dipole is made of standard semirigid coaxial cable. The center conductor of the feeding line is directly connected to the second arm of the dipole. The antenna is therefore short-circuited for DC-signals. On some of the dipoles, small end caps are added to the dipole arms in order to improve matching when loaded according to the position as explained in the "Measurement Conditions" paragraph. The SAR data are not affected by this change. The overall dipole length is still according to the Standard.

No excessive force must be applied to the dipole arms, because they might bend or the soldered connections near the feedpoint may be damaged.

Additional EUT Data

Manufactured by	SPEAG
Manufactured on	December 21, 2009

Extended Calibration

Usage of SAR dipoles calibrated less than 2 years ago but more than 1 year ago were confirmed in maintaining return loss (< -20 dB, within 20% of prior calibration) and impedance (within 5 ohm from prior calibration) requirements per extended calibrations in KDB Publication 865664 D01 v01r03.

D5GHzV2 SN: 1085 - Head							
Date of Measurement	Frequency	Return Loss (dB)	$\Delta\%$	Impedance (Ω)	$\Delta\Omega$	Impedance Imaginary ($j\Omega$)	$\Delta\Omega$
12/11/2012	5200 MHz	-20.2		50.9		-9.9	
12/11/2013		-21.3	5.4	51.2	0.3	-8.7	1.2
12/11/2014		-20.8	3.0	50.1	-0.8	-9.4	0.5
12/11/2012	5300 MHz	-24.7		48.7		-5.6	
12/11/2013		-24.3	-1.6	47.9	-0.8	-4.8	0.8
12/11/2014		-23.9	-3.2	47.2	-1.5	-4.2	1.4
12/11/2012	5600 MHz	-23.0		56.1		-4.4	
12/11/2013		-23.9	3.9	55.0	-1.1	-4.9	-0.5
12/11/2014		-23.5	2.2	55.8	-0.3	-3.8	1.1
12/11/2012	5800 MHz	-26.2		51.9		-4.6	
12/11/2013		-25.6	-2.3	53.1	1.2	-4.1	0.5
12/11/2014		-25.2	-3.8	52.6	0.7	-5.2	-0.6

D5GHzV2 SN: 1085 - Body							
Date of Measurement	Frequency	Return Loss (dB)	$\Delta\%$	Impedance Real (Ω)	$\Delta\Omega$	Impedance Imaginary ($j\Omega$)	$\Delta\Omega$
12/11/2012	5200 MHz	-20.5		50.0		-9.5	
12/11/2013		-21.3	3.9	51.2	1.2	-8.7	0.8
12/11/2014		-21.6	5.4	49.8	-0.2	-10.2	-0.7
12/11/2012	5300 MHz	-26.0		49.7		-5.0	
12/11/2013		-25.3	-2.7	51.3	1.6	-4.6	0.4
12/11/2014		-27.1	4.2	50.3	0.6	-5.8	-0.8
12/11/2012	5600 MHz	-23.2		56.5		-3.4	
12/11/2013		-22.6	-2.6	55.9	-0.6	-3.9	-0.5
12/11/2014		-24.3	4.7	57.1	0.6	-2.8	0.6
12/11/2012	5800 MHz	-25.0		53.5		-4.7	
12/11/2013		-23.9	-4.4	52.6	-0.9	-5.7	-1.0
12/11/2014		-25.6	2.4	53.9	0.4	-4.5	0.2

Test Laboratory: SPEAG, Zurich, Switzerland

DUT: Dipole 5GHz; Type: D5GHzV2; Serial: D5GHzV2 - SN: 1085

Communication System: CW; Frequency: 5200 MHz, Frequency: 5300 MHz, Frequency: 5600 MHz,
Frequency: 5800 MHz

Medium parameters used: $f = 5200$ MHz; $\sigma = 4.53$ mho/m; $\epsilon_r = 34.8$; $\rho = 1000$ kg/m³, Medium parameters used: $f = 5300$ MHz; $\sigma = 4.63$ mho/m; $\epsilon_r = 34.7$; $\rho = 1000$ kg/m³, Medium parameters used: $f = 5600$ MHz; $\sigma = 4.93$ mho/m; $\epsilon_r = 34.2$; $\rho = 1000$ kg/m³, Medium parameters used: $f = 5800$ MHz; $\sigma = 5.15$ mho/m; $\epsilon_r = 34$; $\rho = 1000$ kg/m³

Phantom section: Flat Section

Measurement Standard: DASY5 (IEEE/IEC/ANSI C63.19-2007)

DASY52 Configuration:

- Probe: EX3DV4 - SN3503; ConvF(5.41, 5.41, 5.41); Calibrated: 30.12.2011, ConvF(5.1, 5.1, 5.1); Calibrated: 30.12.2011, ConvF(4.76, 4.76, 4.76); Calibrated: 30.12.2011, ConvF(4.81, 4.81, 4.81); Calibrated: 30.12.2011;
- Sensor-Surface: 1.4mm (Mechanical Surface Detection)
- Electronics: DAE4 Sn601; Calibrated: 27.06.2012
- Phantom: Flat Phantom 5.0 (front); Type: QD000P50AA; Serial: 1001
- DASY52 52.8.3(988); SEMCAD X 14.6.7(6848)

Dipole Calibration for Head Tissue/Pin=100mW, dist=10mm, f=5200 MHz/Zoom Scan, dist=1.4mm (8x8x7)/Cube 0: Measurement grid: dx=4mm, dy=4mm, dz=1.4mm
Reference Value = 64.782 V/m; Power Drift = 0.07 dB
Peak SAR (extrapolated) = 30.1 W/kg
SAR(1 g) = 8.2 W/kg; SAR(10 g) = 2.35 W/kg
Maximum value of SAR (measured) = 18.9 W/kg

Dipole Calibration for Head Tissue/Pin=100mW, dist=10mm, f=5300 MHz/Zoom Scan, dist=1.4mm (8x8x7)/Cube 0: Measurement grid: dx=4mm, dy=4mm, dz=1.4mm
Reference Value = 64.947 V/m; Power Drift = 0.04 dB
Peak SAR (extrapolated) = 31.3 W/kg
SAR(1 g) = 8.35 W/kg; SAR(10 g) = 2.39 W/kg
Maximum value of SAR (measured) = 19.4 W/kg

Dipole Calibration for Head Tissue/Pin=100mW, dist=10mm, f=5600 MHz/Zoom Scan, dist=1.4mm (8x8x7)/Cube 0: Measurement grid: dx=4mm, dy=4mm, dz=1.4mm
Reference Value = 64.857 V/m; Power Drift = 0.05 dB
Peak SAR (extrapolated) = 34.4 W/kg
SAR(1 g) = 8.69 W/kg; SAR(10 g) = 2.48 W/kg
Maximum value of SAR (measured) = 20.8 W/kg

Dipole Calibration for Head Tissue/Pin=100mW, dist=10mm, f=5800 MHz/Zoom Scan, dist=1.4mm (8x8x7)/Cube 0: Measurement grid: dx=4mm, dy=4mm, dz=1.4mm

Reference Value = 61.816 V/m; Power Drift = 0.06 dB

Peak SAR (extrapolated) = 33.5 W/kg

SAR(1 g) = 8.16 W/kg; SAR(10 g) = 2.33 W/kg

Maximum value of SAR (measured) = 19.9 W/kg

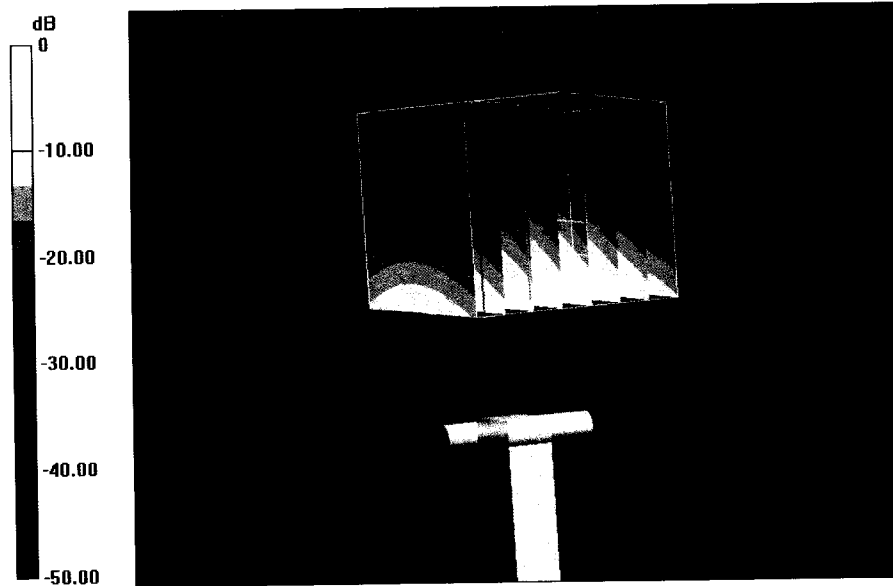

0 dB = 19.9 W/kg = 12.99 dBW/kg

Impedance Measurement Plot for Head TSL

11 Dec 2012 16:17:51

CH1 S11 1 U FS 1: 50.916 Ω -9.8672 Ω 3.1019 pF 5 200.000 000 MHz

*
De1
Cor
Avg
16
H1d

CH1 Markers
2: 48.664 Ω
-5.5938 Ω
5.30000 GHz
4: 56.137 Ω
-4.3555 Ω
5.60000 GHz
5: 51.922 Ω
-4.6328 Ω
5.80000 GHz

CH2 S11 LQ6 5 dB/REF -20 dB 1: -20.201 dB 5 200.000 000 MHz

Cor
Avg
16
H1d

CH2 Markers
2: -24.698 dB
5.30000 GHz
4: -22.991 dB
5.60000 GHz
5: -26.163 dB
5.80000 GHz

START 5 000.000 000 MHz

STOP 6 000.000 000 MHz

DASY5 Validation Report for Body TSL

Date: 10.12.2012

Test Laboratory: SPEAG, Zurich, Switzerland

DUT: Dipole 5GHz; Type: D5GHzV2; Serial: D5GHzV2 - SN: 1085

Communication System: CW; Frequency: 5200 MHz, Frequency: 5300 MHz, Frequency: 5600 MHz,
Frequency: 5800 MHz

Medium parameters used: $f = 5200$ MHz; $\sigma = 5.35$ mho/m; $\epsilon_r = 46.8$; $\rho = 1000$ kg/m³, Medium parameters used: $f = 5300$ MHz; $\sigma = 5.47$ mho/m; $\epsilon_r = 46.7$; $\rho = 1000$ kg/m³, Medium parameters used: $f = 5600$ MHz; $\sigma = 5.86$ mho/m; $\epsilon_r = 46.2$; $\rho = 1000$ kg/m³, Medium parameters used: $f = 5800$ MHz; $\sigma = 6.13$ mho/m; $\epsilon_r = 45.9$; $\rho = 1000$ kg/m³

Phantom section: Flat Section

Measurement Standard: DASY5 (IEEE/IEC/ANSI C63.19-2007)

DASY52 Configuration:

- Probe: EX3DV4 - SN3503; ConvF(4.91, 4.91, 4.91); Calibrated: 30.12.2011, ConvF(4.67, 4.67, 4.67); Calibrated: 30.12.2011, ConvF(4.22, 4.22, 4.22); Calibrated: 30.12.2011, ConvF(4.38, 4.38, 4.38); Calibrated: 30.12.2011;
- Sensor-Surface: 1.4mm (Mechanical Surface Detection)
- Electronics: DAE4 Sn601; Calibrated: 27.06.2012
- Phantom: Flat Phantom 5.0 (back); Type: QD000P50AA; Serial: 1002
- DASY52 52.8.3(988); SEMCAD X 14.6.7(6848)

Dipole Calibration for Body Tissue/Pin=100mW, dist=10mm, f=5200 MHz/Zoom Scan, dist=1.4mm (8x8x7)/Cube 0: Measurement grid: dx=4mm, dy=4mm, dz=1.4mm

Reference Value = 58.435 V/m; Power Drift = -0.01 dB

Peak SAR (extrapolated) = 29.5 W/kg

SAR(1 g) = 7.41 W/kg; SAR(10 g) = 2.08 W/kg

Maximum value of SAR (measured) = 17.3 W/kg

Dipole Calibration for Body Tissue/Pin=100mW, dist=10mm, f=5300 MHz/Zoom Scan, dist=1.4mm (8x8x7)/Cube 0: Measurement grid: dx=4mm, dy=4mm, dz=1.4mm

Reference Value = 57.938 V/m; Power Drift = -0.01 dB

Peak SAR (extrapolated) = 30.1 W/kg

SAR(1 g) = 7.43 W/kg; SAR(10 g) = 2.09 W/kg

Maximum value of SAR (measured) = 17.4 W/kg

Dipole Calibration for Body Tissue/Pin=100mW, dist=10mm, f=5600 MHz/Zoom Scan, dist=1.4mm (8x8x7)/Cube 0: Measurement grid: dx=4mm, dy=4mm, dz=1.4mm

Reference Value = 58.467 V/m; Power Drift = -0.01 dB

Peak SAR (extrapolated) = 35.4 W/kg

SAR(1 g) = 7.98 W/kg; SAR(10 g) = 2.22 W/kg

Maximum value of SAR (measured) = 19.5 W/kg

**Dipole Calibration for Body Tissue/Pin=100mW, dist=10mm, f=5800 MHz/Zoom Scan,
dist=1.4mm (8x8x7)/Cube 0:** Measurement grid: dx=4mm, dy=4mm, dz=1.4mm
Reference Value = 54.901 V/m; Power Drift = -0.01 dB
Peak SAR (extrapolated) = 34.6 W/kg
SAR(1 g) = 7.36 W/kg; SAR(10 g) = 2.04 W/kg
Maximum value of SAR (measured) = 18.3 W/kg

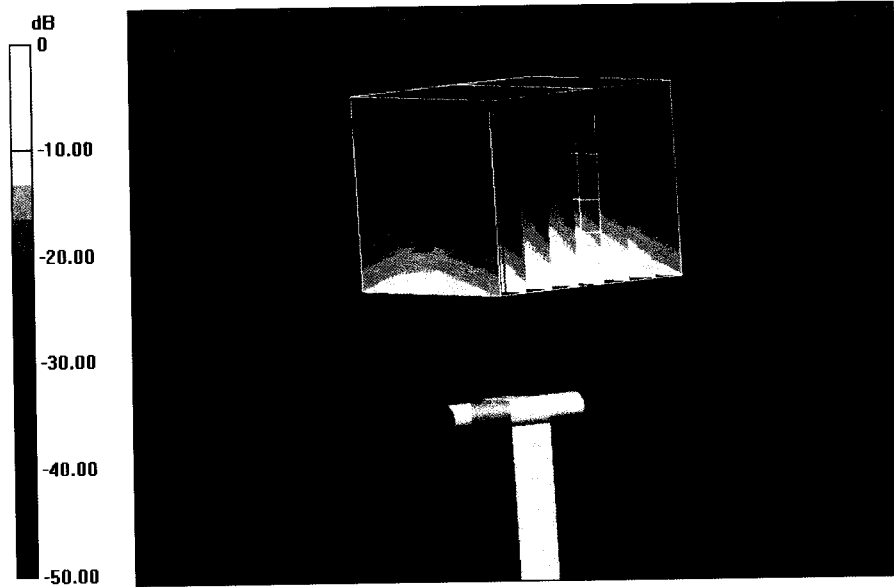

0 dB = 18.3 W/kg = 12.62 dBW/kg

Impedance Measurement Plot for Body TSL

10 Dec 2012 14:55:30

CH1 S11 1 U FS 1: 50.000 Ω -9.4551 Ω 3.2371 pF 5 200.000 000 MHz

*

De1

Cor

Avg
16

H1d

CH2 S11 LQG 5 dB/REF -20 dB 1: -20.524 dB 5 200.000 000 MHz

Cor

Avg
16

H1d

START 5 000.000 000 MHz

STOP 6 000.000 000 MHz

CH1 Markers

2: 49.746 Ω
-4.9941 Ω
5.30000 GHz
4: 56.489 Ω
-3.4395 Ω
5.60000 GHz
5: 53.482 Ω
-4.6660 Ω
5.80000 GHz

CH2 Markers

2: -26.005 dB
5.30000 GHz
4: -23.234 dB
5.60000 GHz
5: -25.002 dB
5.80000 GHz

Appendix F – Phantom Calibration Data Sheets

Zeughausstrasse 43, 8004 Zurich, Switzerland
 Phone +41 44 245 9700, Fax +41 44 245 9779
 info@speag.com, http://www.speag.com

Certificate of Conformity / First Article Inspection

Item	Oval Flat Phantom ELI 4.0
Type No	QD OVA 001 B
Series No	1003 and higher
Manufacturer	Untersee Composites Knebelstrasse 8 CH-8268 Mannenbach, Switzerland

Tests

Complete tests were made on the prototype units QD OVA 001 AA 1001, QD OVA 001 AB 1002, pre-series units QD OVA 001 BA 1003-1005 as well as on the series units QD OVA 001 BB, 1006 ff.

Test	Requirement	Details	Units tested
Material thickness	Compliant with the standard requirements	Bottom plate: 2.0mm +/- 0.2mm	all
Material parameters	Dielectric parameters for required frequencies	< 6 GHz: Rel. permittivity = 4 +/-1, Loss tangent ≤ 0.05	Material sample
Material resistivity	The material has been tested to be compatible with the liquids defined in the standards if handled and cleaned according to the instructions.	DGBE based simulating liquids. Observe Technical Note for material compatibility.	Equivalent phantoms, Material sample
Shape	Thickness of bottom material, Internal dimensions, Sagging compatible with standards from minimum frequency	Bottom elliptical 600 x 400 mm Depth 190 mm, Shape is within tolerance for filling height up to 155 mm, Eventual sagging is reduced or eliminated by support via DUT	Prototypes, Sample testing

Standards

- [1] CENELEC EN 50361-2001, « Basic standard for the measurement of the Specific Absorption Rate related to human exposure to electromagnetic fields from mobile phones (300 MHz – 3 GHz) », July 2001
- [2] IEEE 1528-2003, "Recommended Practice for Determining the Peak Spatial-Average Specific Absorption Rate (SAR) in the Human Head from Wireless Communications Devices: Measurement Techniques, December 2003
- [3] IEC 62209 – 1, "Specific Absorption Rate (SAR) in the frequency range of 300 MHz to 3 GHz – Measurement Procedure, Part 1: Hand-held mobile wireless communication devices", February 2005
- [4] IEC 62209 – 2, Draft, "Human Exposure to Radio Frequency Fields from Handheld and Body-Mounted Wireless Communication Devices – Human models, Instrumentation and Procedures – Part 2: Procedure to determine the Specific Absorption Rate (SAR) in the head and body for 30 MHz to 6 GHz Handheld and Body-Mounted Devices used in close proximity to the Body.", February 2005
- [5] OET Bulletin 65, Supplement C, "Evaluating Compliance with FCC Guidelines for Human Exposure to Radiofrequency Electromagnetic Fields", Edition January 2001

Based on the tests above, we certify that this item is in compliance with the standards [1] to [5] if operated according to the specific requirements and considering the thickness. The dimensions are fully compliant with [4] from 30 MHz to 6 GHz. For the other standards, the minimum lower frequency limit is limited due to the dimensional requirements ([1]: 450 MHz, [2]: 300 MHz, [3]: 800 MHz, [5]: 375 MHz) and possibly further by the dimensions of the DUT.

Date 28.4.2008

Signature / Stamp

s p e a g
 Schmid & Partner Engineering AG
 Zeughausstrasse 43, 8004 Zurich, Switzerland
 Phone +41 44 245 9700, Fax +41 44 245 9779
 info@speag.com; http://www.speag.com

Appendix G – Validation Summary

Per FCC KDB 865664 D02v01, SAR system validation status should be documented to confirm measurement accuracy. The SAR systems (including SAR probes, system components and software versions) used for this device were validated against its performance specifications prior to the SAR measurements. Reference dipoles were used with the required tissue equivalent media for system validation according to the procedures outlined in FCC KDB 865664 D01 v01 and IEEE 1528-2013. Since SAR probe calibrations are frequency dependent, each probe calibration point was validated at a frequency within the valid frequency range of the probe calibration point using the system that normally operates with the probe for routine SAR measurements and according to the required tissue equivalent media.

A tabulated summary of the system validation status including the validation date(s), measurement frequencies, SAR probes and tissue dielectric parameters has been included.

**Table G-1
SAR System Validation Summary**

SAR System #	Freq. (MHz)	Date	Probe S/N	Probe Type	Probe Cal. Point	Cond. (σ)	Perm. (ϵ_r)	CW Validation			Modulation Validation			
								Sensitivity	Probe Linearity	Probe Isotropy	Modulation Type	Duty Factor	PAR	
1	2450	2/09/2015	3833	EX3DV4	2450	Body	1.98	52.34	Pass	Pass	Pass	OFDM/TDD	Pass	Pass
1	5200	2/10/2015	3833	EX3DV4	5200	Body	5.36	48.83	Pass	Pass	Pass	OFDM	N/A	Pass
1	5300	2/10/2015	3833	EX3DV4	5300	Body	5.49	48.52	Pass	Pass	Pass	OFDM	N/A	Pass
1	5500	2/10/2015	3833	EX3DV4	5500	Body	5.79	48.04	Pass	Pass	Pass	OFDM	N/A	Pass
1	5600	2/11/2015	3833	EX3DV4	5600	Body	5.82	47.98	Pass	Pass	Pass	OFDM	N/A	Pass
1	5800	2/11/2015	3833	EX3DV4	5800	Body	6.09	47.81	Pass	Pass	Pass	OFDM	N/A	Pass