

4.5.6 LTE B26 Band Edge Results

Graphical results:

1.4MHz bandwidth, QPSK, (1,0) Mode, below 814MHz

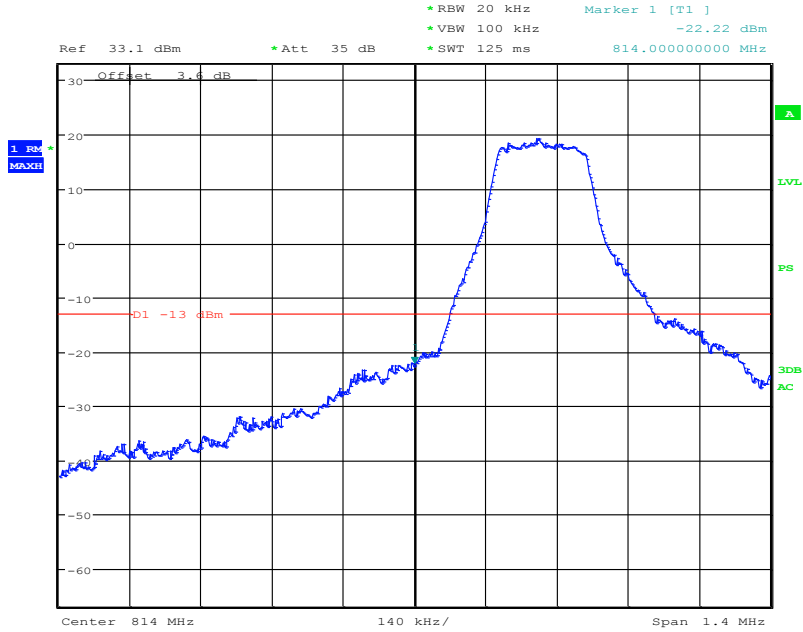

Date: 25.JUN.2015 11:53:20

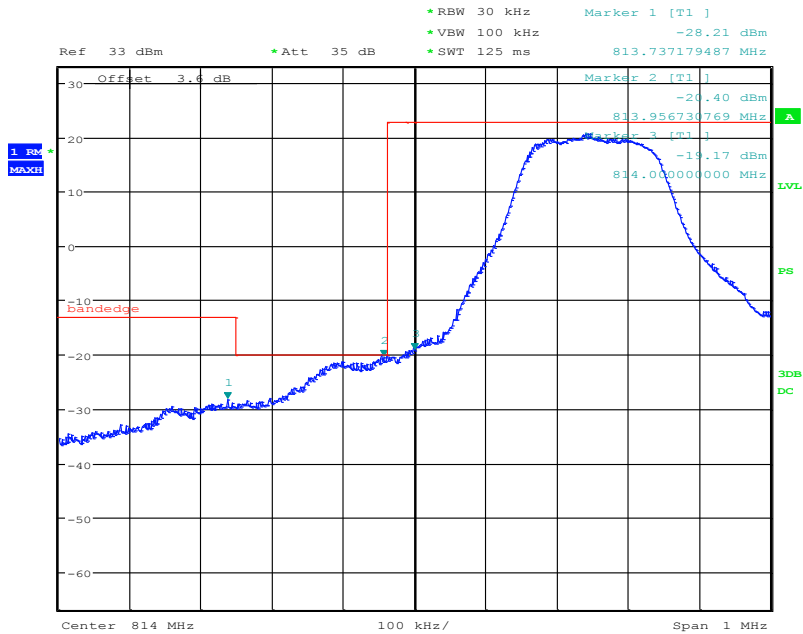

Date: 9.JUL.2015 15:57:21

1.4MHz bandwidth, QPSK, (6,0) Mode, below 814MHz

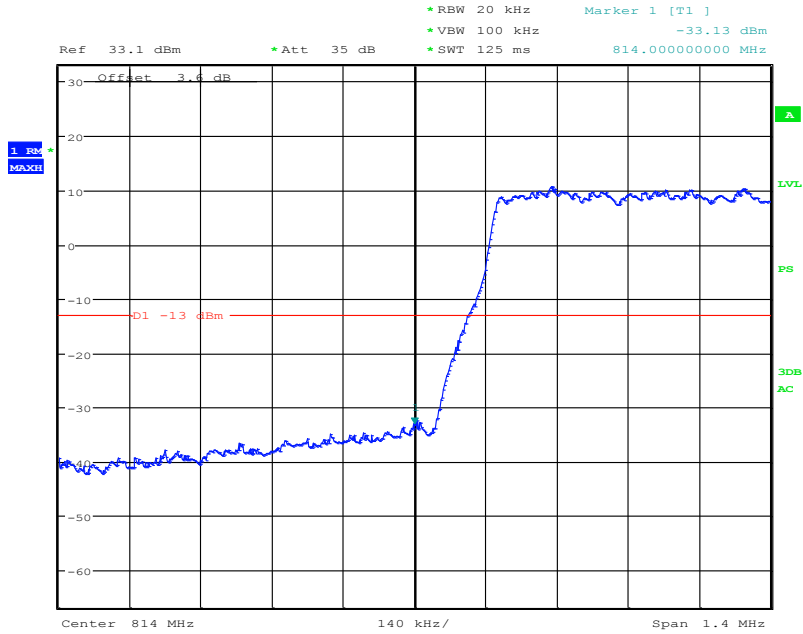

Date: 25.JUN.2015 11:54:16

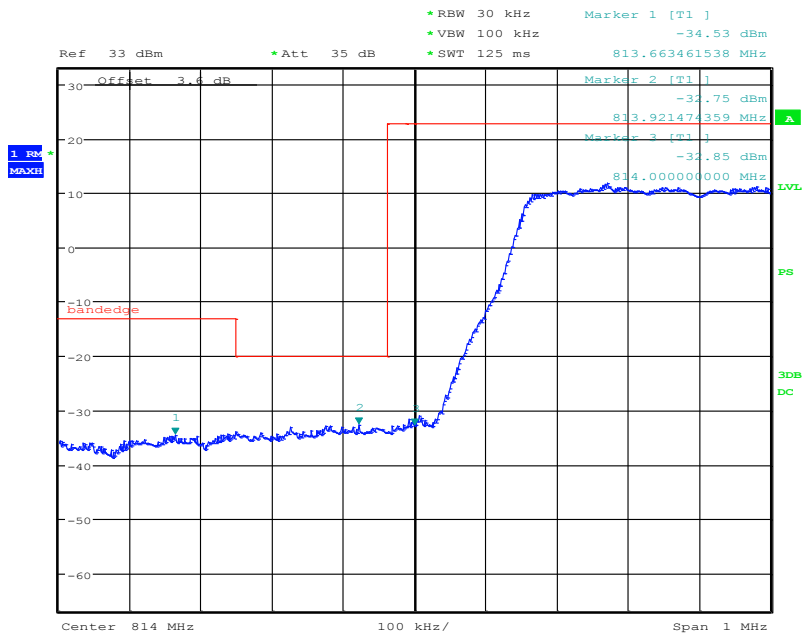

Date: 9.JUL.2015 15:58:19

1.4MHz bandwidth, QPSK,(1,6) Mode, Above 849MHz

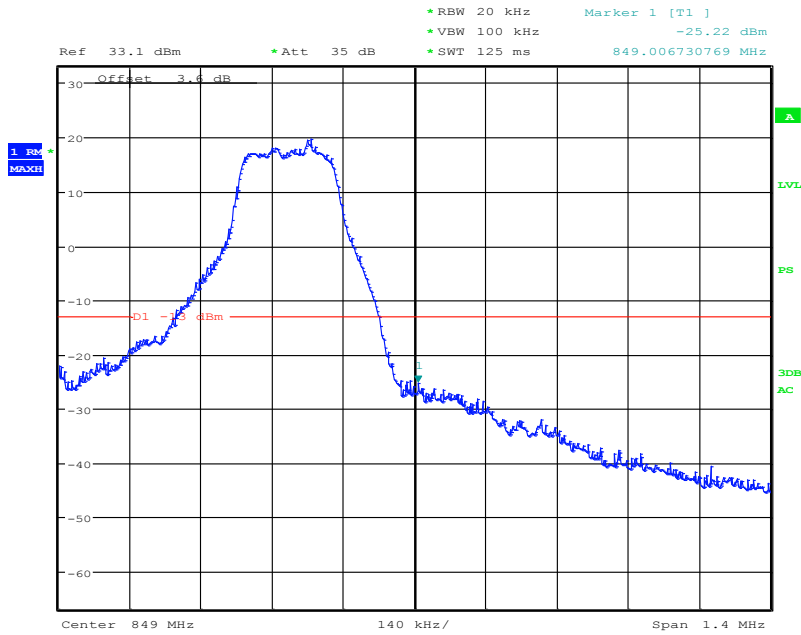

Date: 25.JUN.2015 11:57:09

1.4MHz bandwidth, QPSK,(6,0) Mode, Above 849MHz

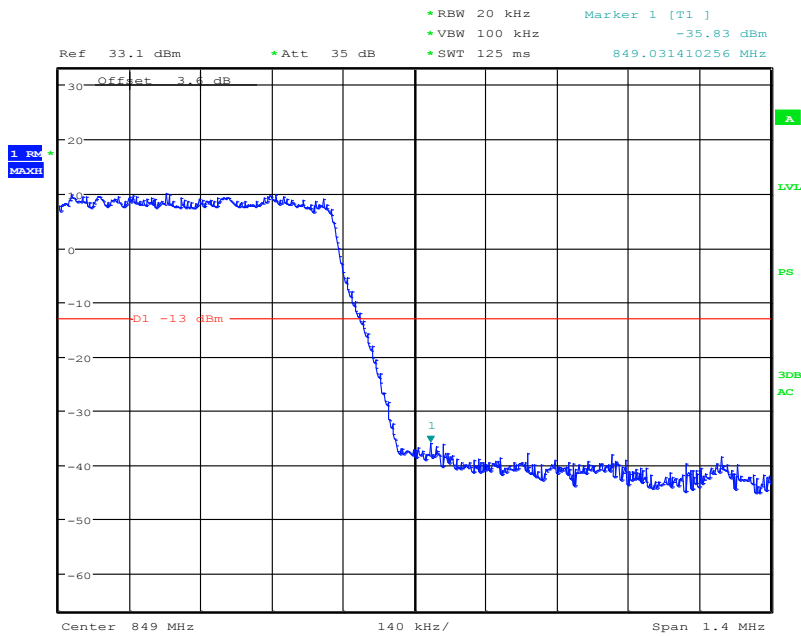

Date: 25.JUN.2015 11:57:54

1.4MHz bandwidth, 16QAM,(1,0) Mode , below 814MHz

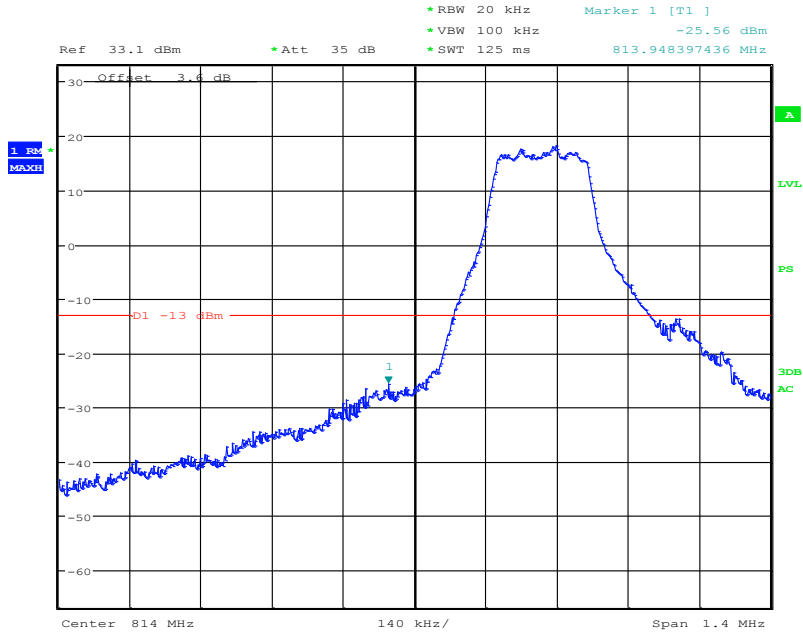

Date: 25.JUN.2015 11:55:44

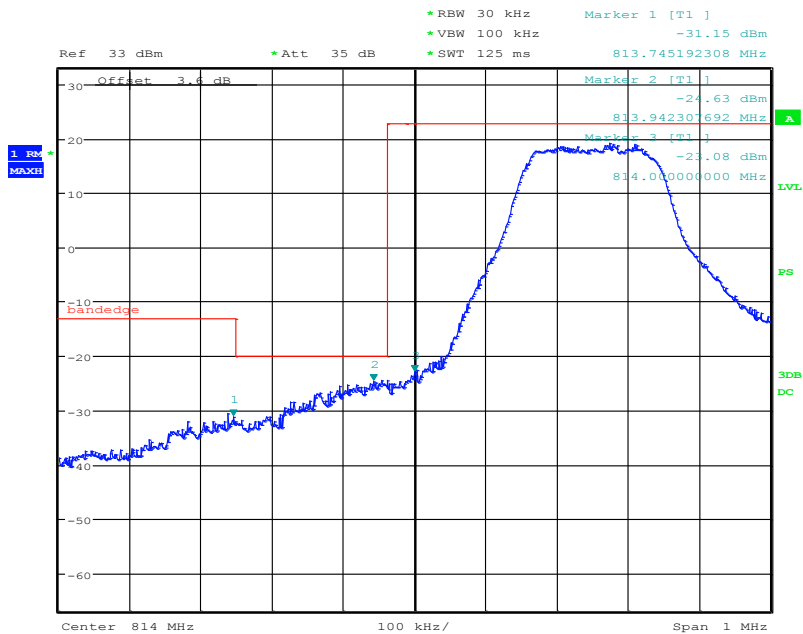

Date: 9.JUL.2015 16:00:02

1.4MHz bandwidth, 16QAM,(6,0) Mode , below 814MHz

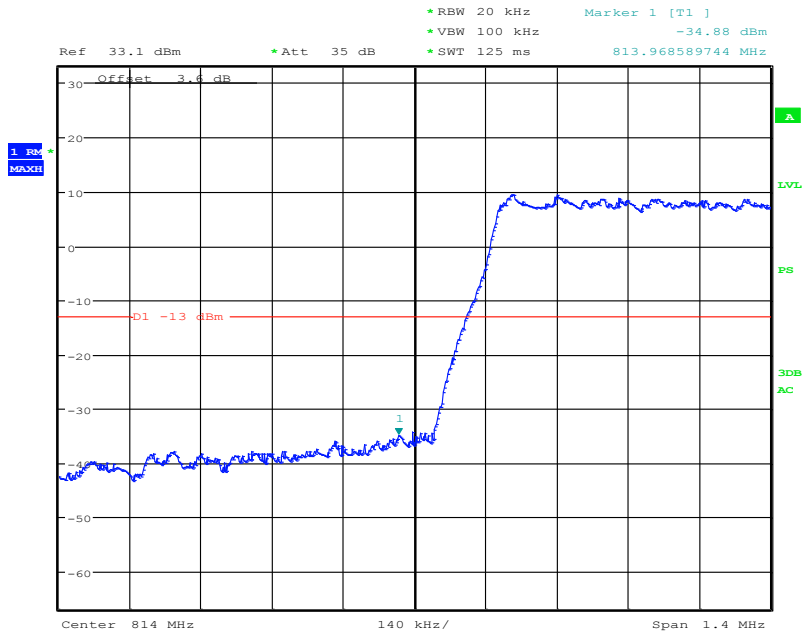

Date: 25.JUN.2015 11:54:57

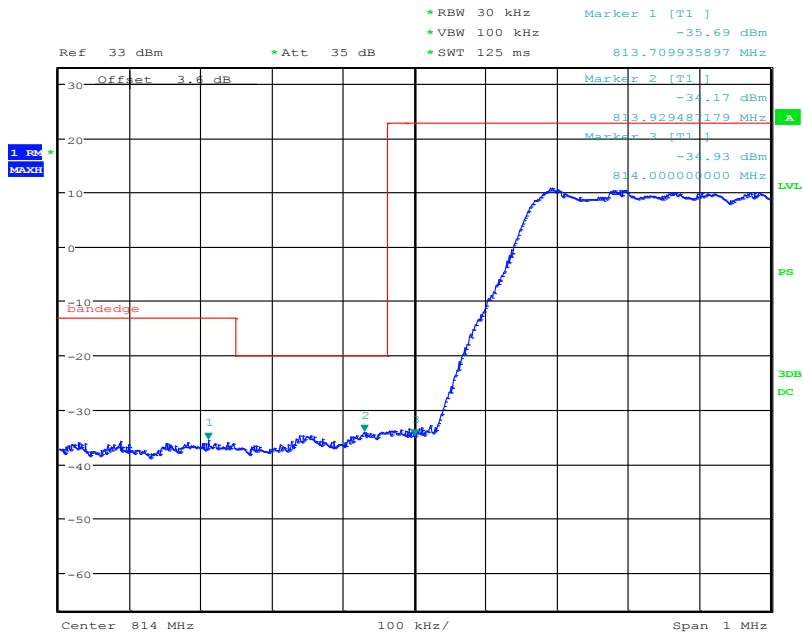

Date: 9.JUL.2015 15:59:16

1.4MHz bandwidth, 16QAM,(1,6) Mode, Above 849MHz

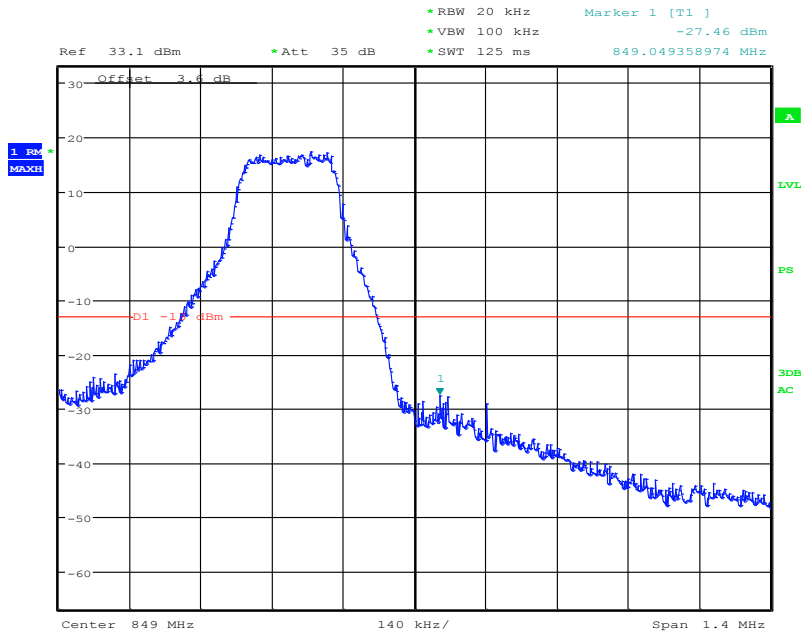

Date: 25.JUN.2015 11:59:01

1.4MHz bandwidth, 16QAM,(6,0) Mode, Above 849MHz

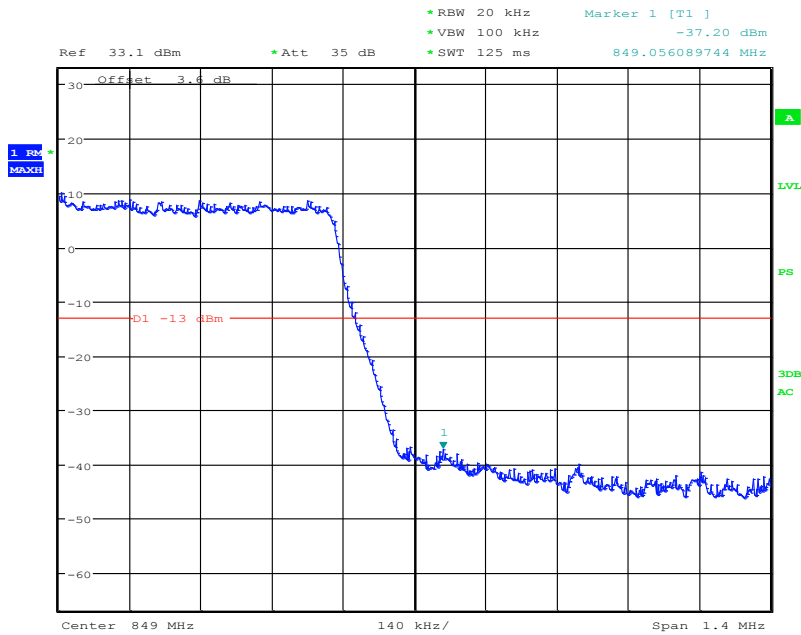

Date: 25.JUN.2015 11:58:28

3MHz bandwidth, QPSK, (1,0) Mode , below 814MHz

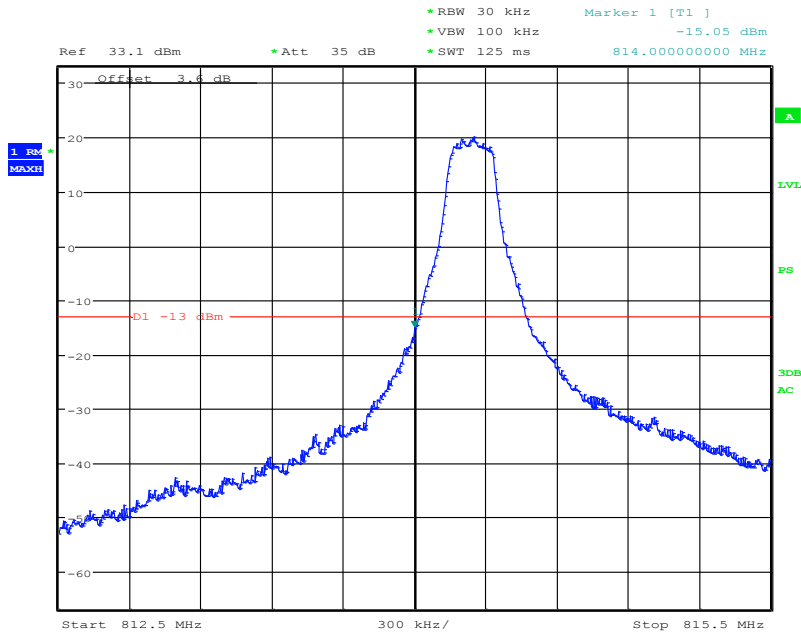

Date: 25.JUN.2015 11:45:44

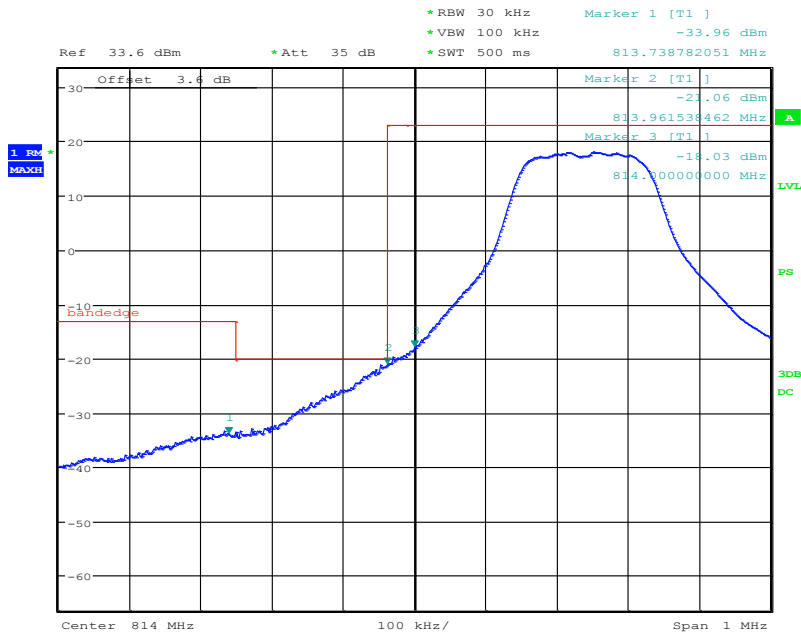

Date: 9.JUL.2015 16:11:34

3MHz bandwidth, QPSK, (15,0) Mode, below 814MHz

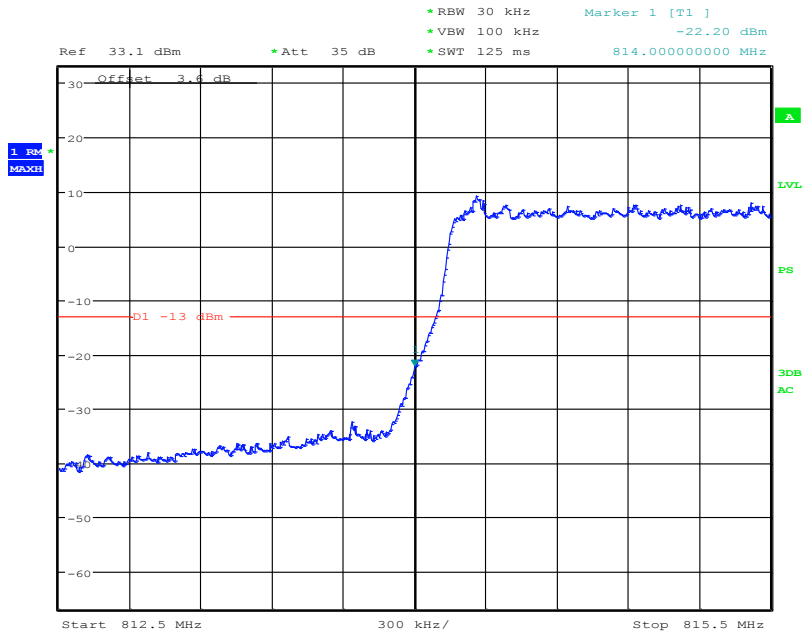

Date: 25.JUN.2015 11:46:10

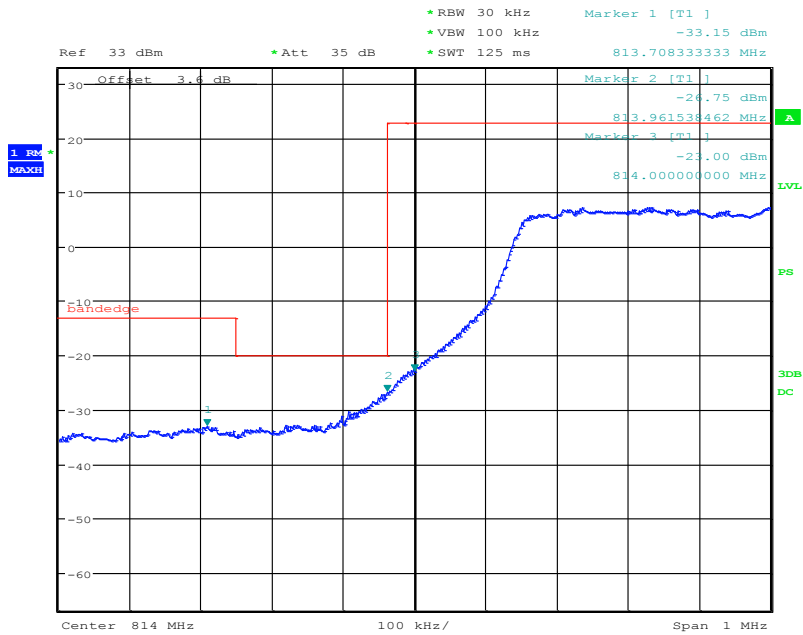

Date: 9.JUL.2015 16:02:19

3MHz bandwidth, QPSK,(1,15) Mode, Above 849MHz

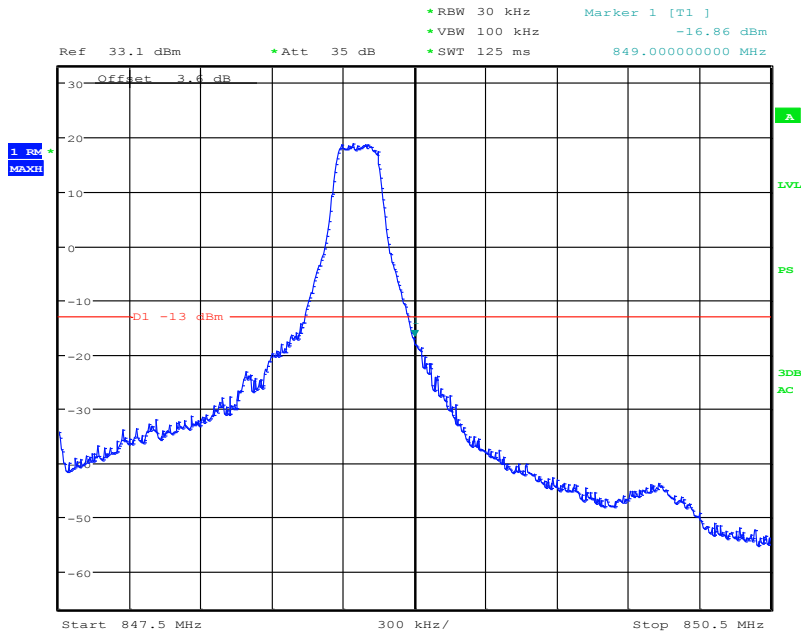

Date: 25.JUN.2015 11:48:15

3MHz bandwidth, QPSK,(15,0) Mode, Above 849MHz

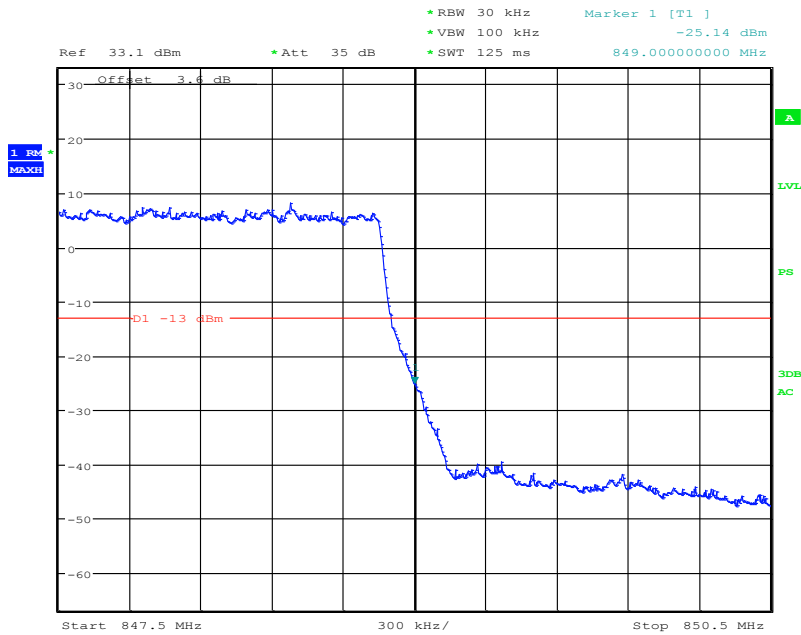

Date: 25.JUN.2015 11:48:42

3MHz bandwidth, 16QAM,(1,0) Mode , below 814MHz

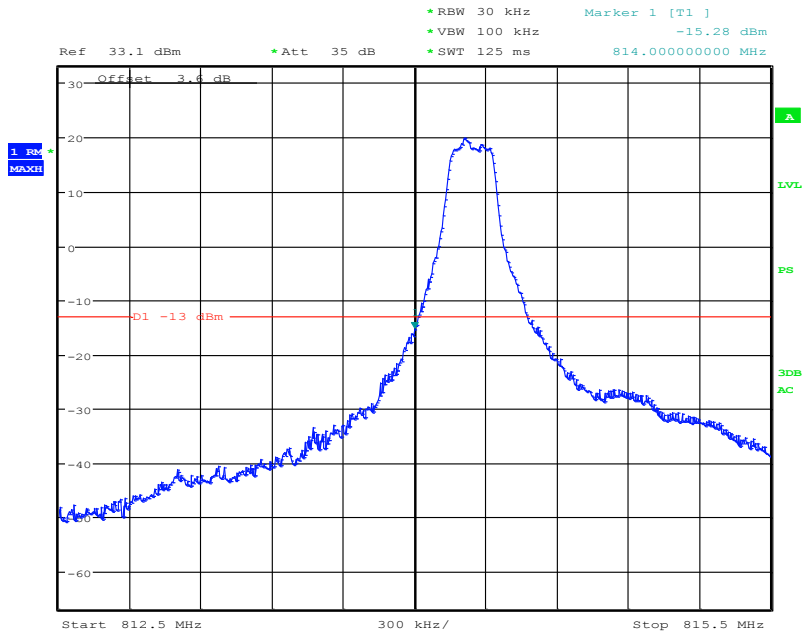

Date: 25.JUN.2015 11:44:59

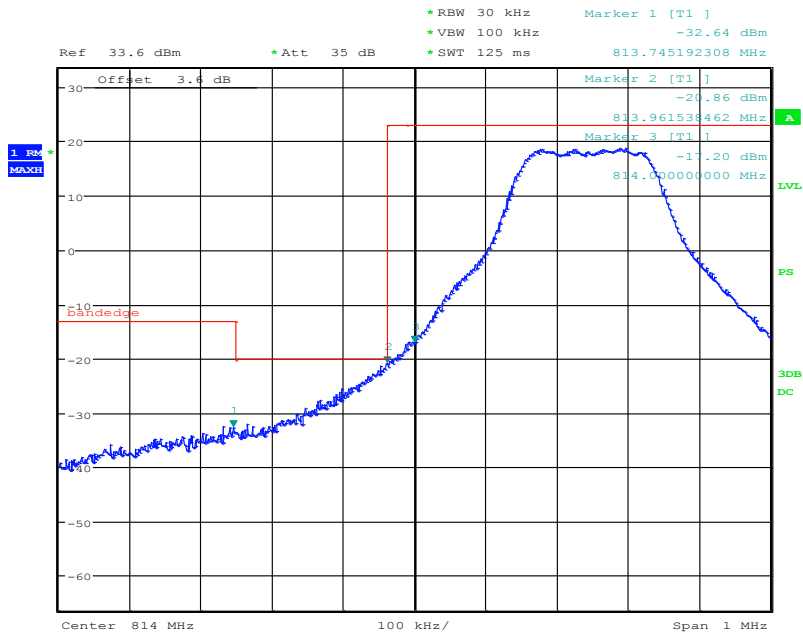

Date: 9.JUL.2015 16:12:41

3MHz bandwidth, 16QAM,(15,0) Mode , below 814MHz

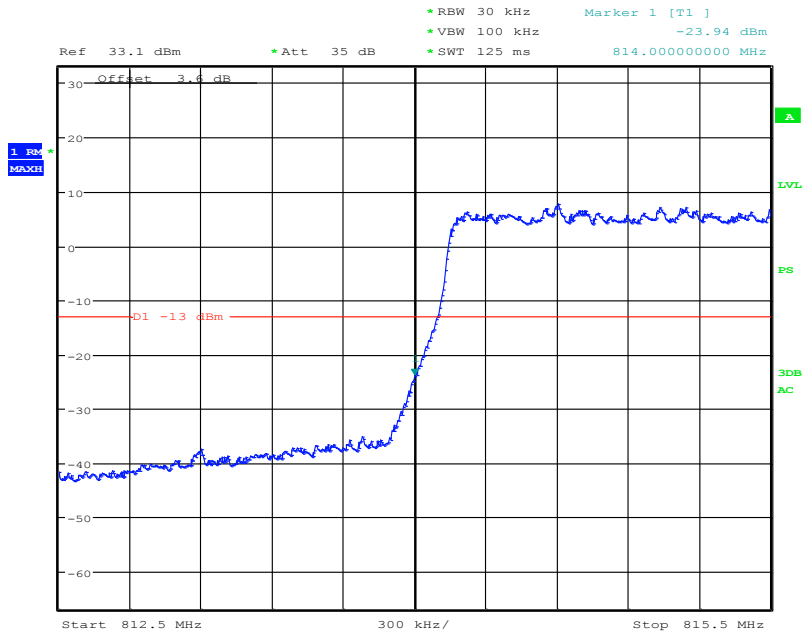

Date: 25.JUN.2015 11:44:01

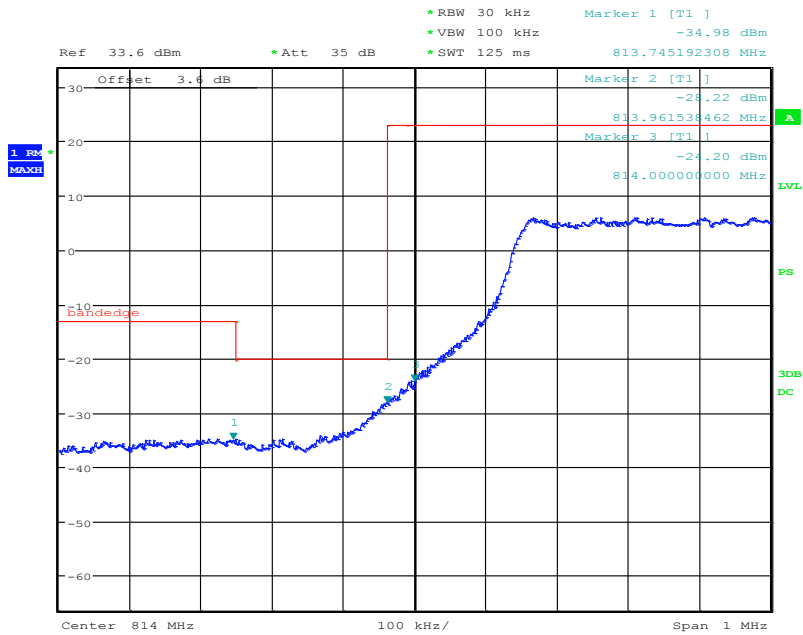

Date: 9.JUL.2015 16:13:11

3MHz bandwidth, 16QAM,(1,15) Mode, Above 849MHz

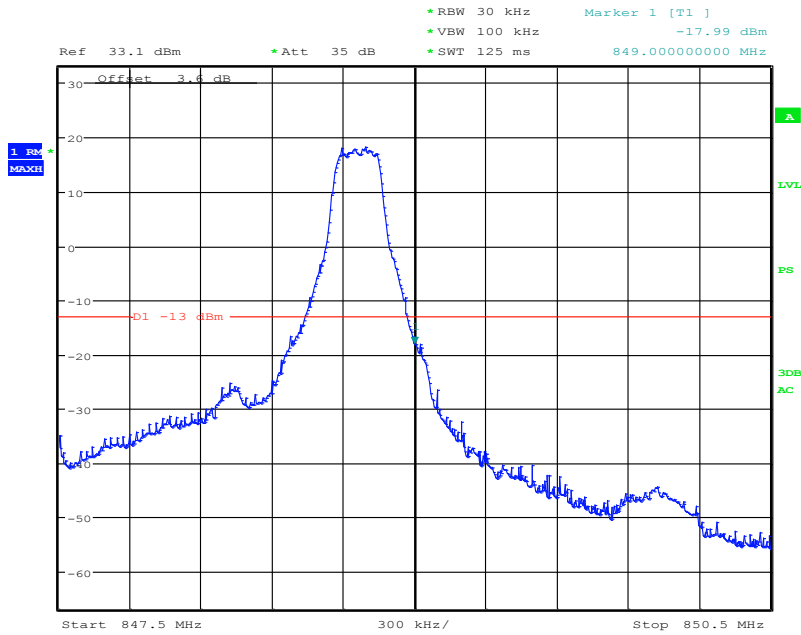

Date: 25.JUN.2015 11:49:39

3MHz bandwidth, 16QAM,(15,0) Mode, Above 849MHz

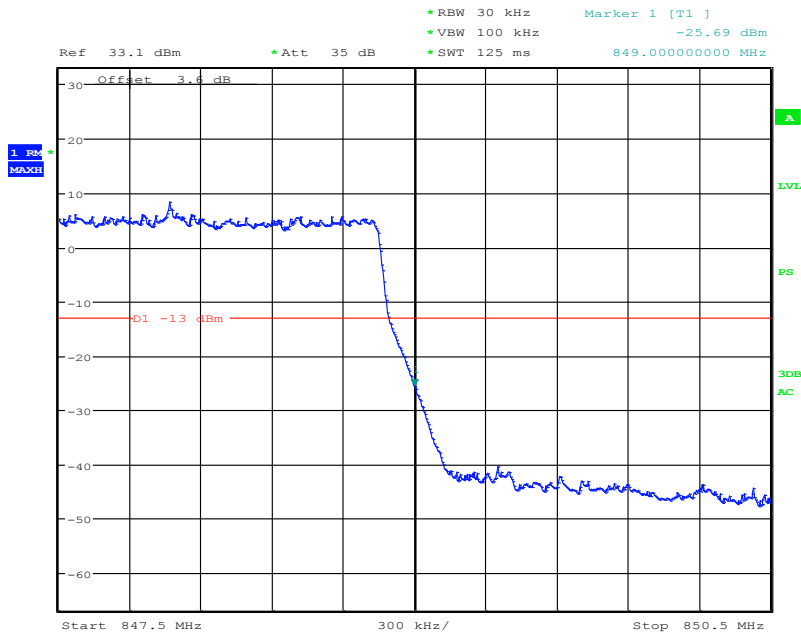

Date: 25.JUN.2015 11:49:14

5MHz bandwidth, QPSK, (1,0) Mode, below 814MHz

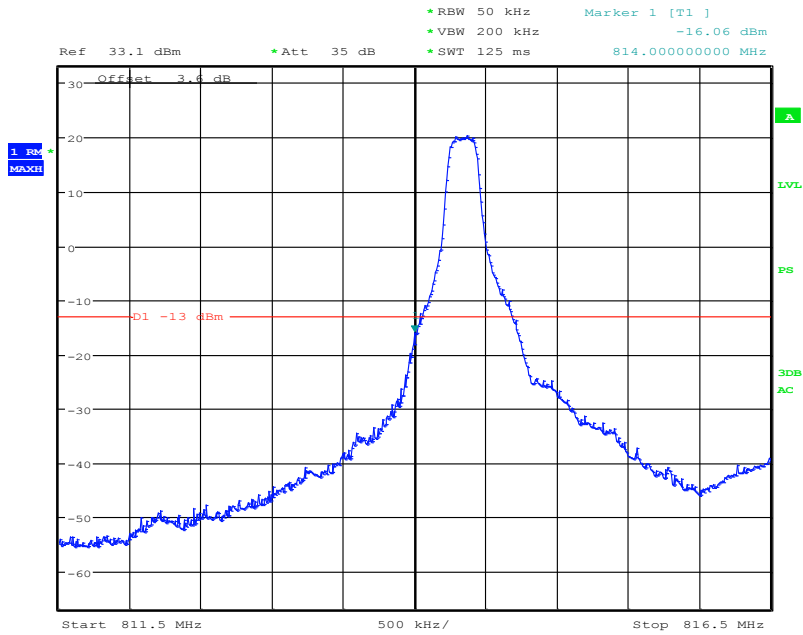

Date: 25.JUN.2015 13:42:19

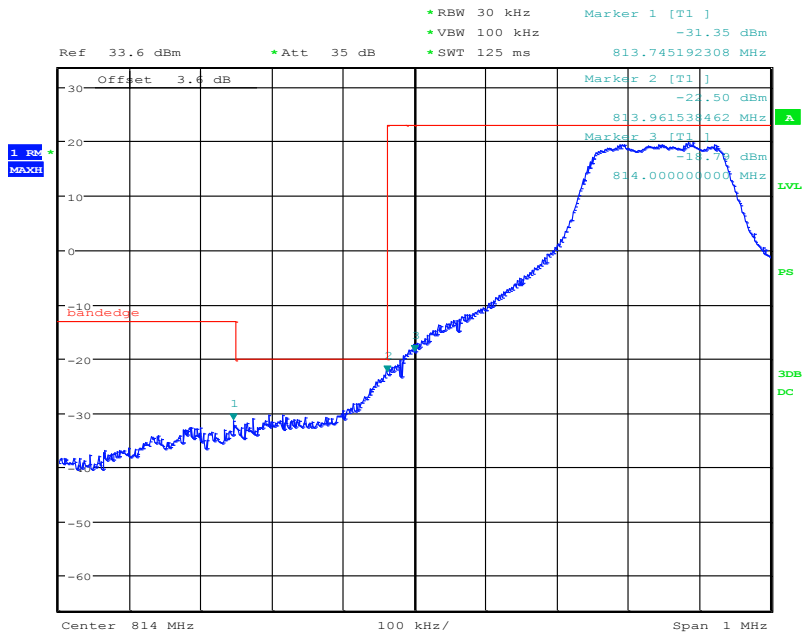

Date: 9.JUL.2015 16:15:05

5MHz bandwidth, QPSK, (25,0) Mode, below 814MHz

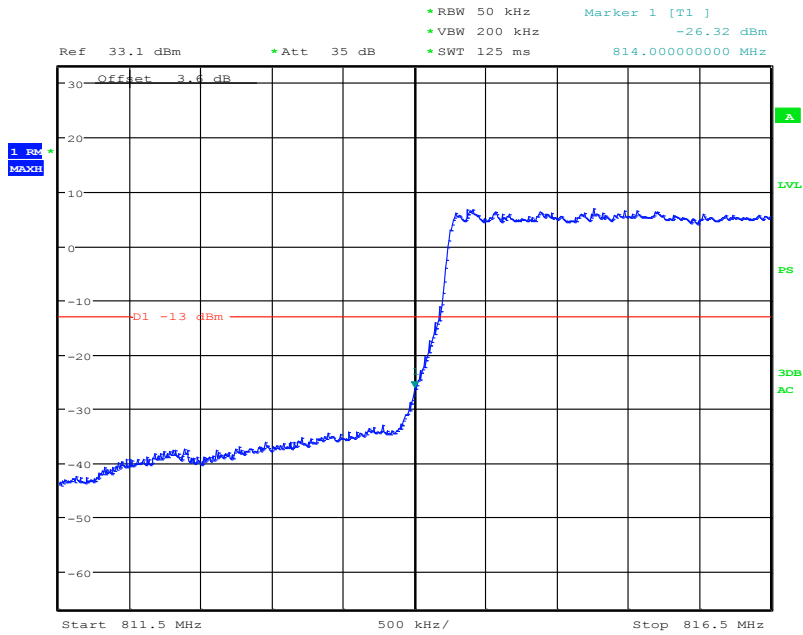

Date: 25.JUN.2015 13:43:02

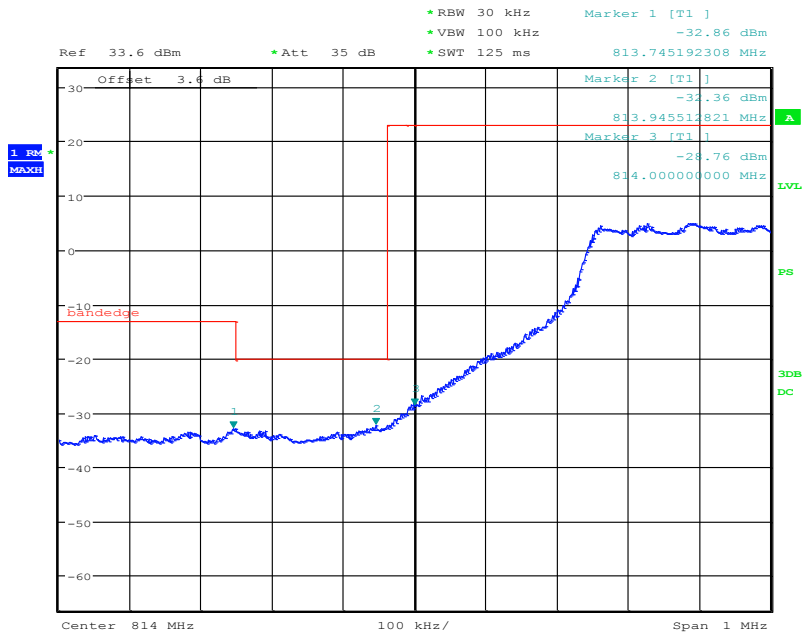

Date: 9.JUL.2015 16:14:24

5MHz bandwidth, QPSK,(1,25) Mode, Above 849MHz

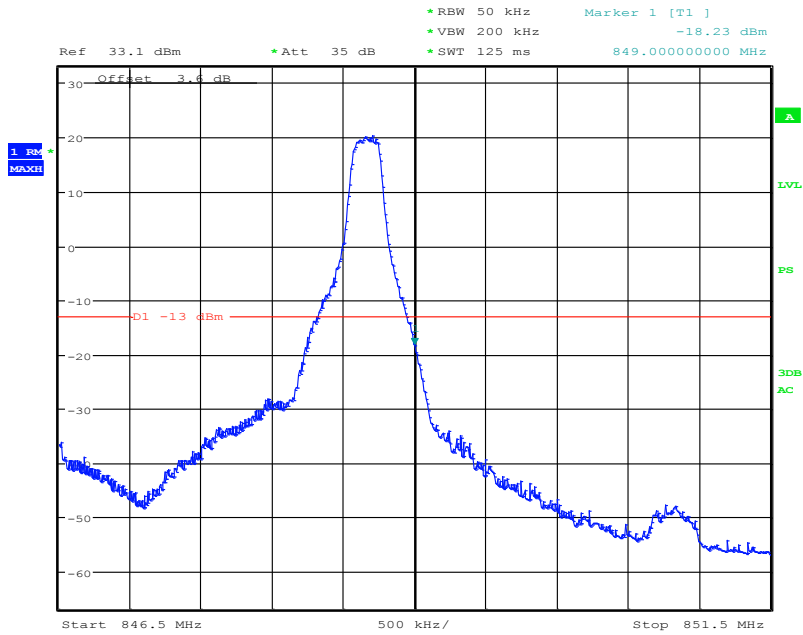

Date: 25.JUN.2015 13:47:17

5MHz bandwidth, QPSK,(25,0) Mode, Above 849MHz

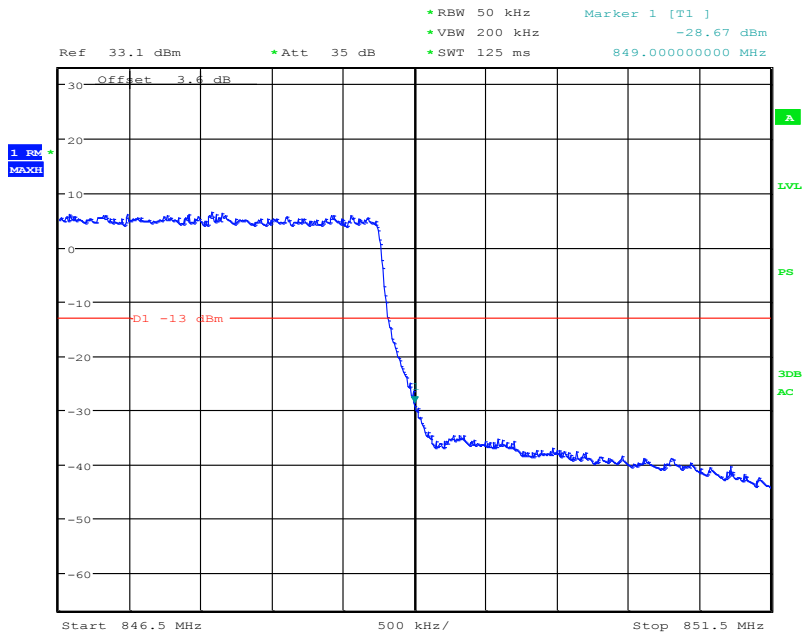

Date: 25.JUN.2015 13:47:47

5MHz bandwidth, 16QAM,(1,0) Mode , below 814MHz

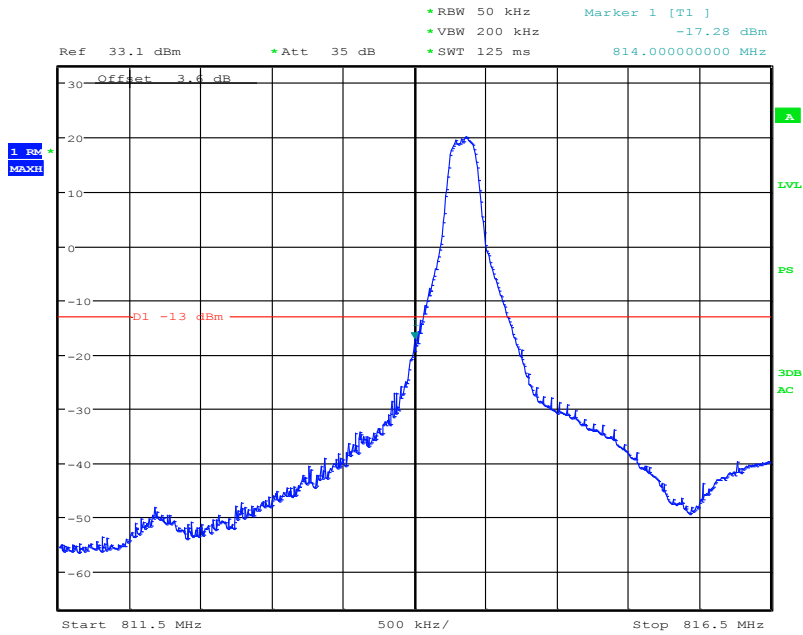

Date: 25.JUN.2015 13:44:24

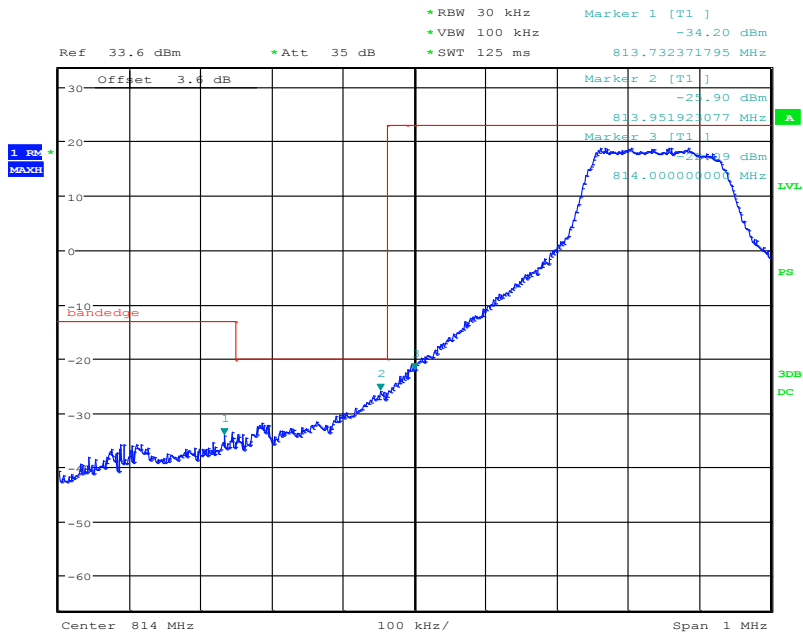

Date: 9.JUL.2015 16:15:48

5MHz bandwidth, 16QAM,(25,0) Mode , below 814MHz

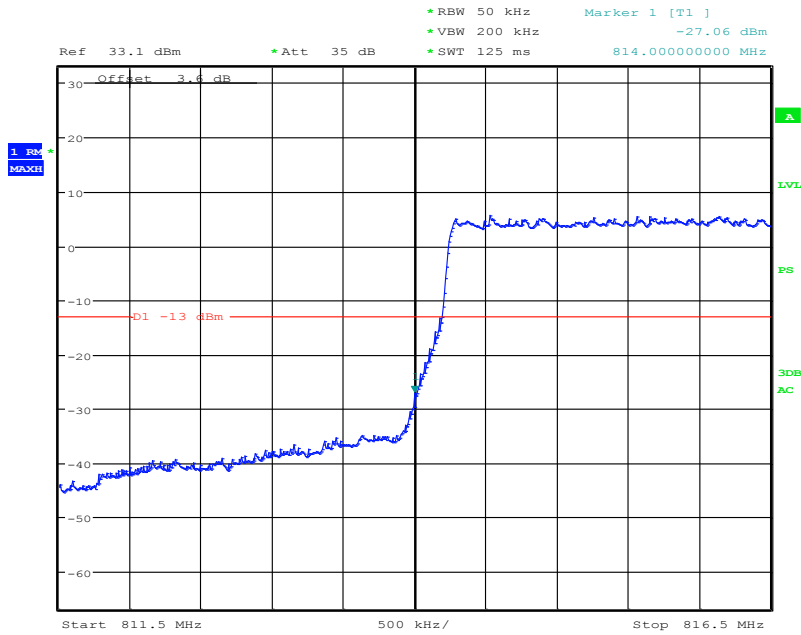

Date: 25.JUN.2015 13:43:50

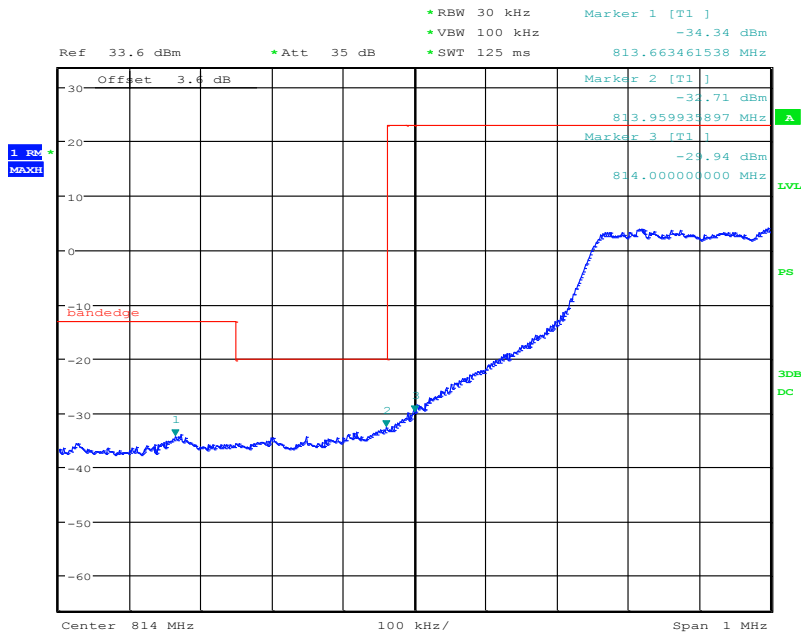

Date: 9.JUL.2015 16:16:21

5MHz bandwidth, 16QAM,(1,25) Mode, Above 849MHz

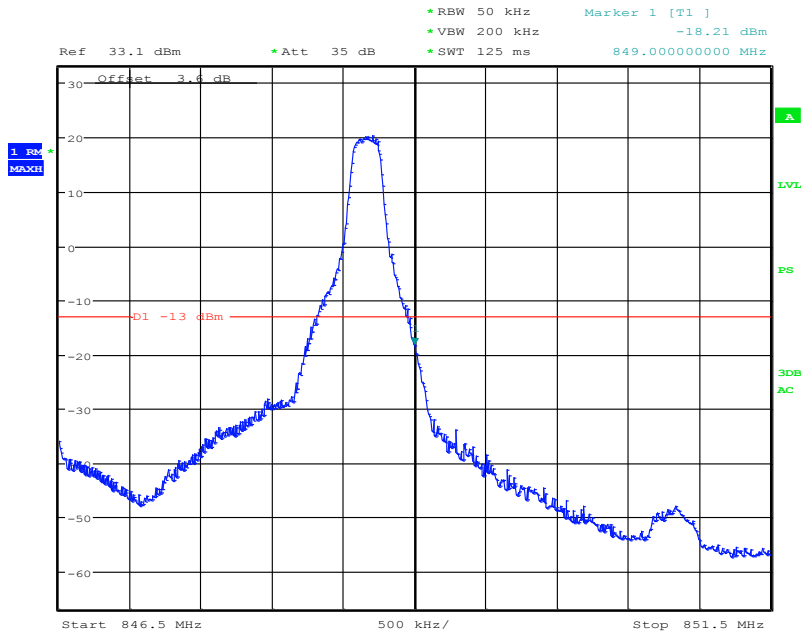

Date: 25.JUN.2015 13:48:44

5MHz bandwidth, 16QAM,(25,0) Mode, Above 849MHz

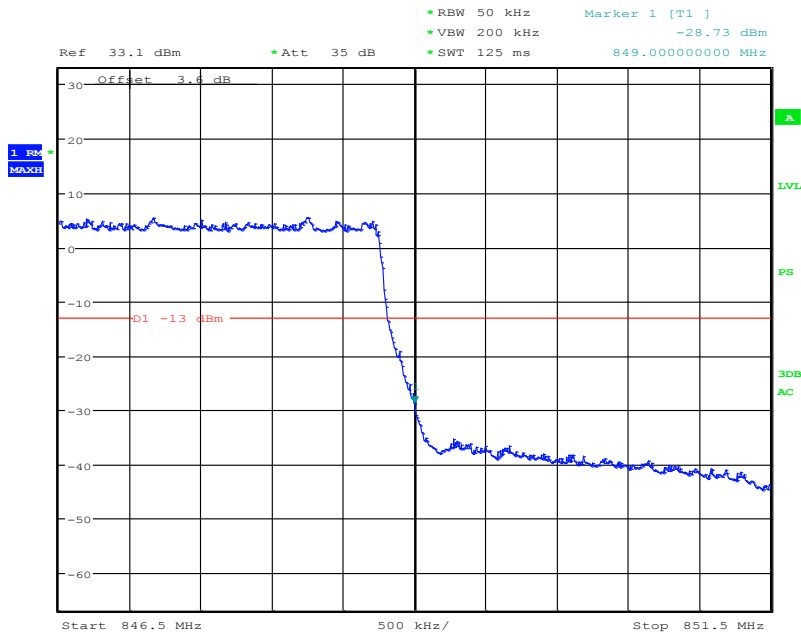

Date: 25.JUN.2015 13:48:10

10MHz bandwidth, QPSK, (1,0) Mode , below 814MHz

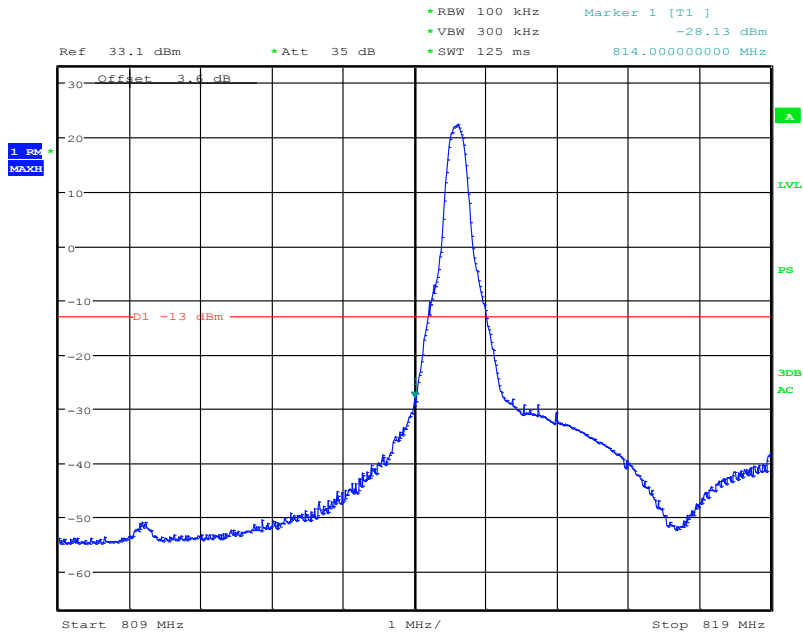

Date: 25.JUN.2015 13:50:52

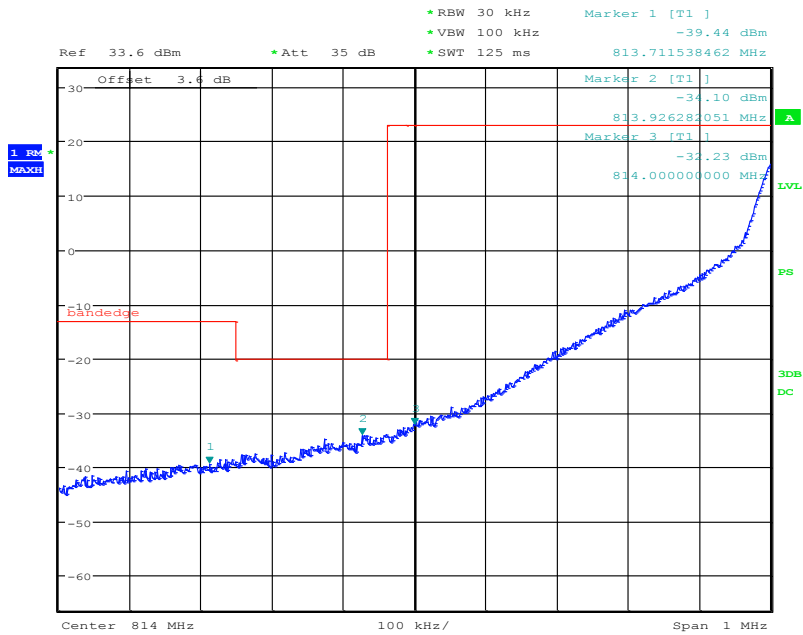

Date: 9.JUL.2015 16:18:41

10MHz bandwidth, QPSK, (50,0) Mode, below 814MHz

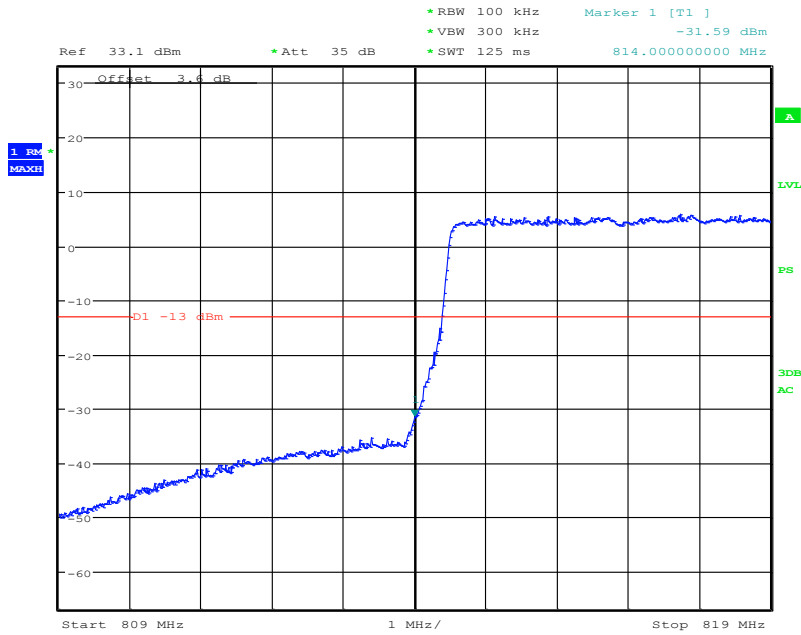

Date: 25.JUN.2015 13:51:20

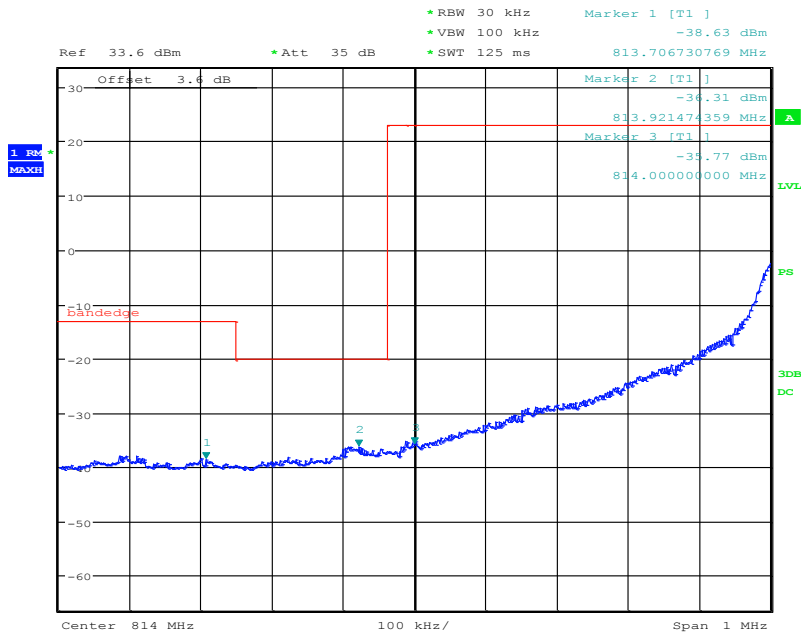

Date: 9.JUL.2015 16:19:15

10MHz bandwidth, QPSK,(1,50) Mode, Above 849MHz

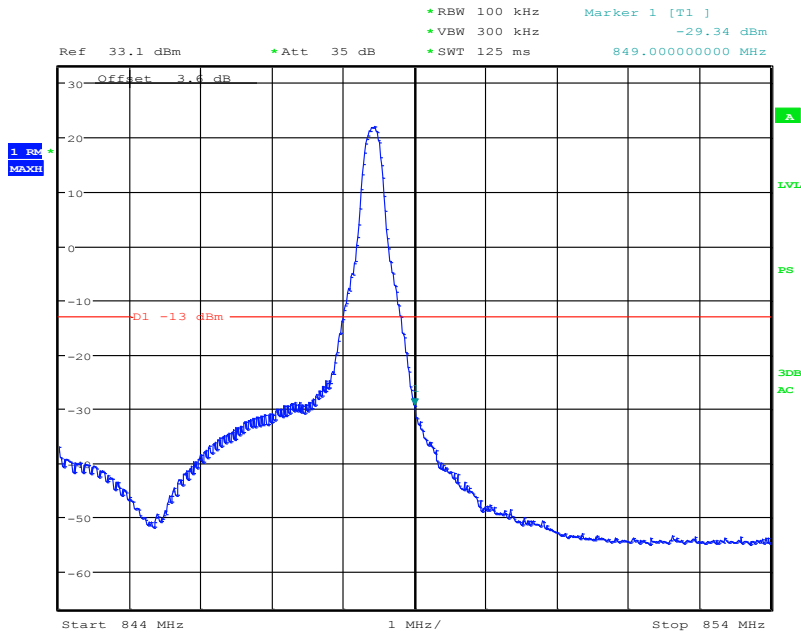

Date: 25.JUN.2015 13:54:22

10MHz bandwidth, QPSK,(50,0) Mode, Above 849MHz

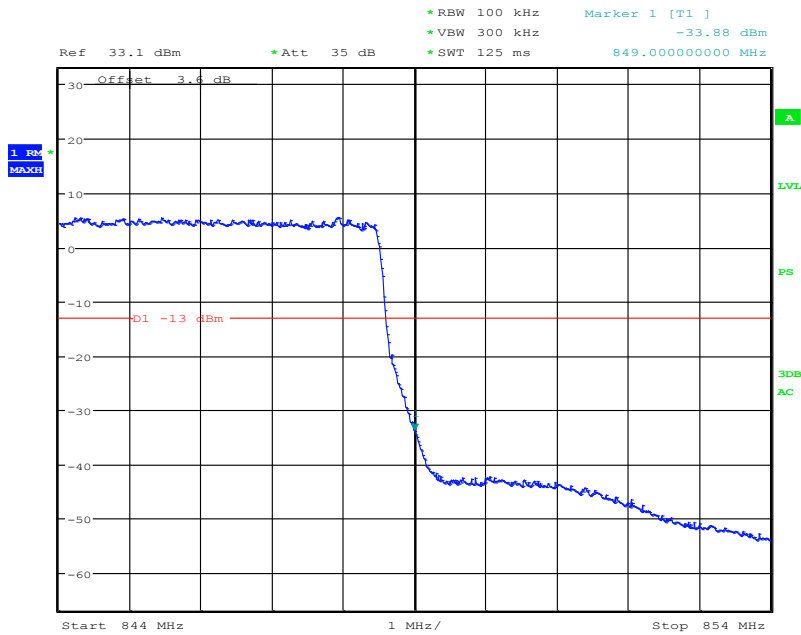

Date: 25.JUN.2015 13:54:43

10MHz bandwidth, 16QAM,(1,0) Mode , below 814MHz

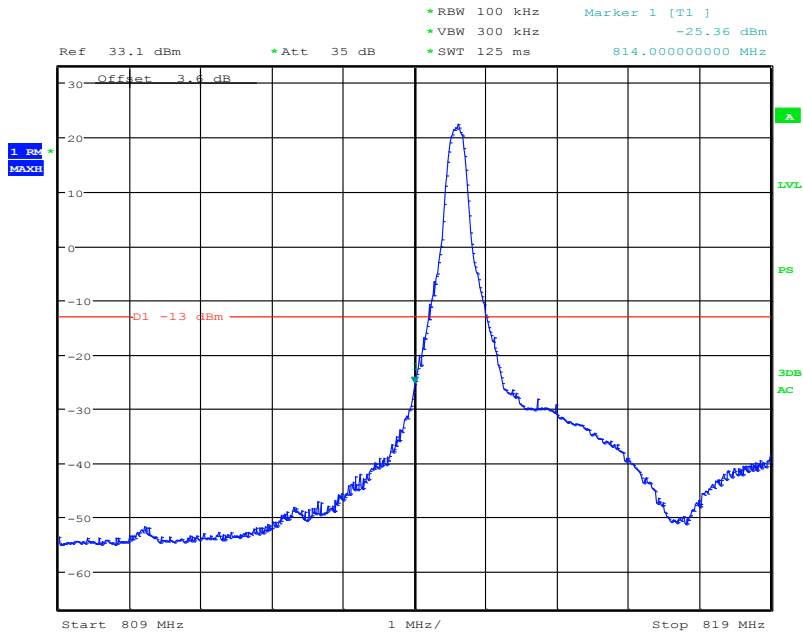

Date: 25.JUN.2015 13:52:33

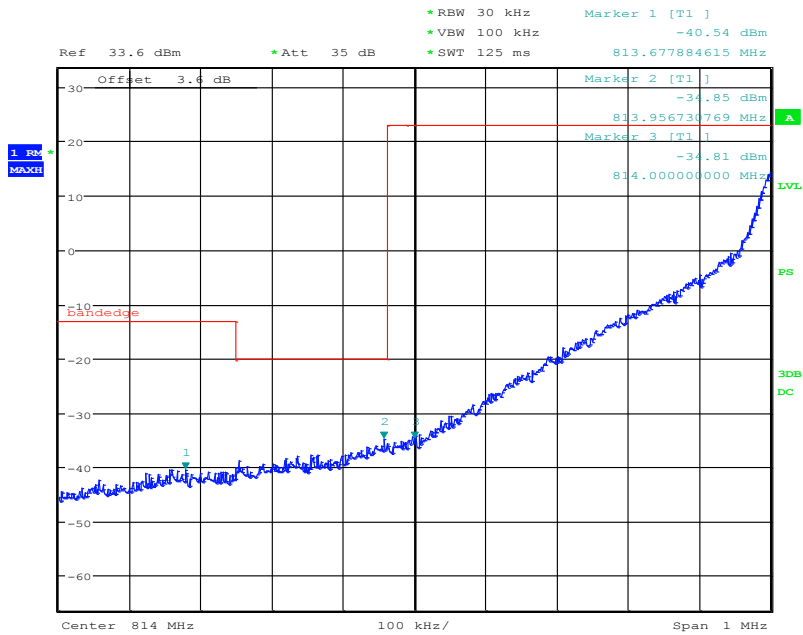

Date: 9.JUL.2015 16:18:04

10MHz bandwidth, 16QAM,(50,0) Mode , below 814MHz

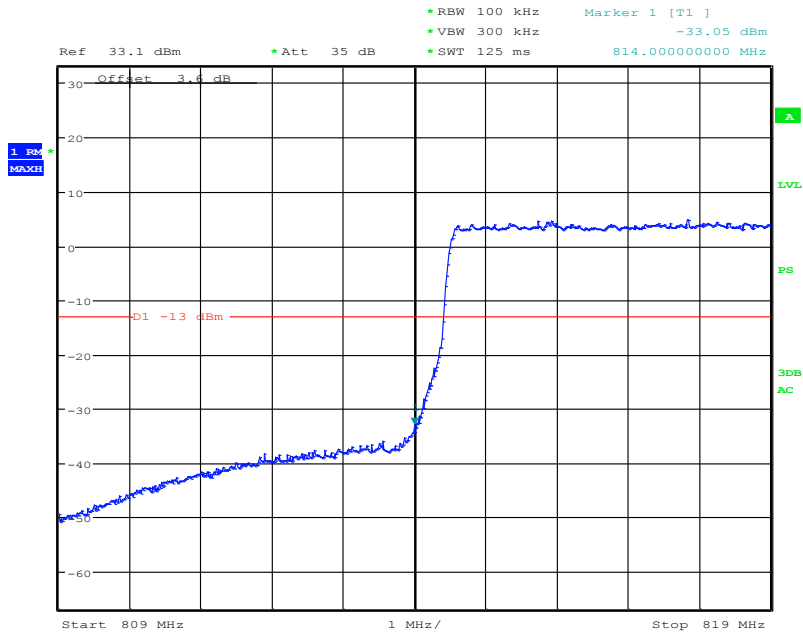

Date: 25.JUN.2015 13:51:52

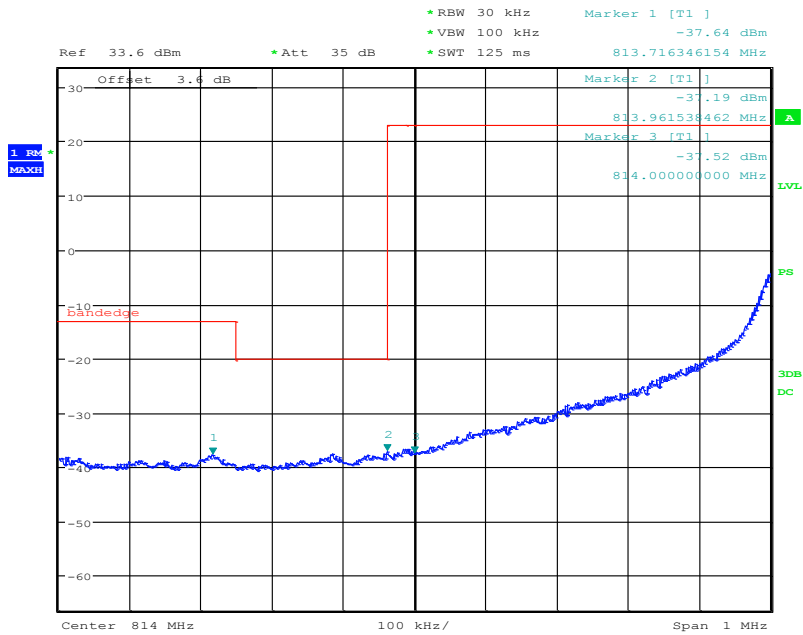

Date: 9.JUL.2015 16:17:27

10MHz bandwidth, 16QAM,(1,50) Mode, Above 849MHz

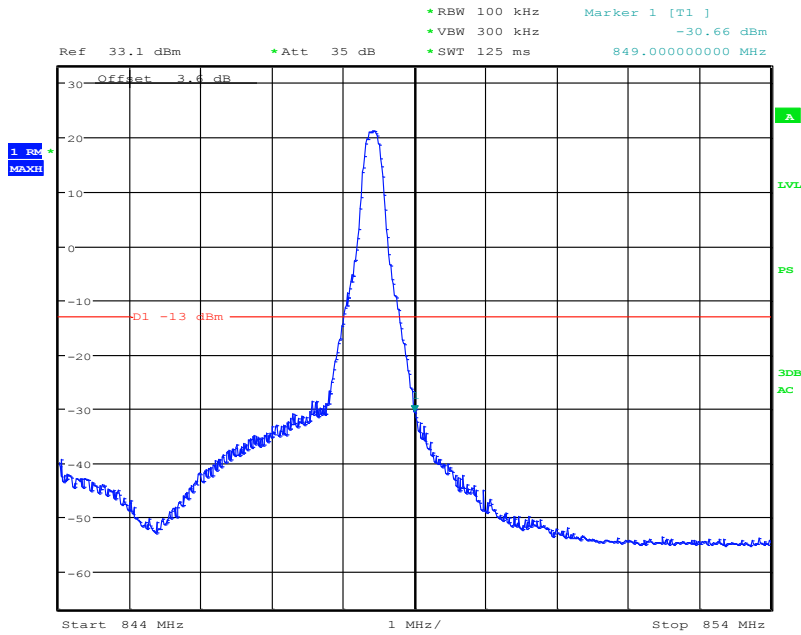

Date: 25.JUN.2015 13:55:59

10MHz bandwidth, 16QAM,(50,0) Mode, Above 849MHz

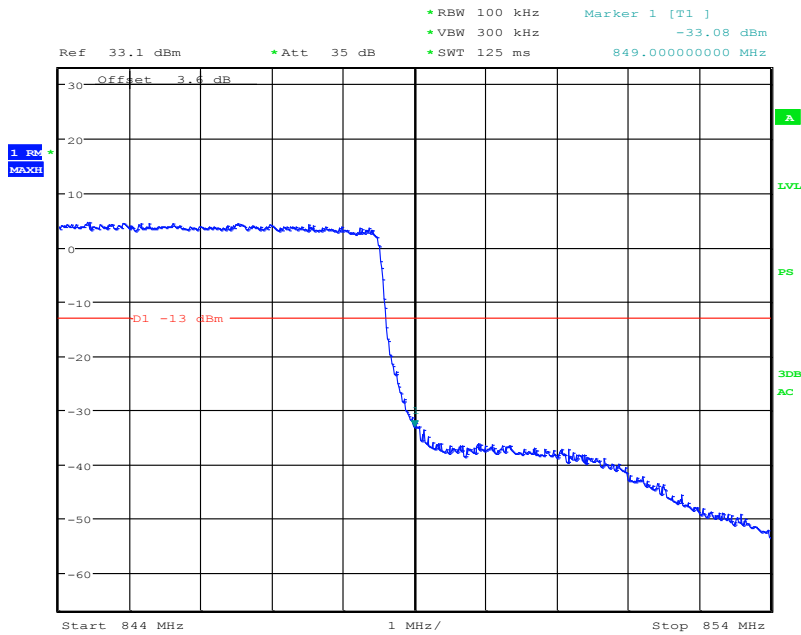

Date: 25.JUN.2015 13:55:23

15MHz bandwidth, QPSK, (1,0) Mode, below 814MHz

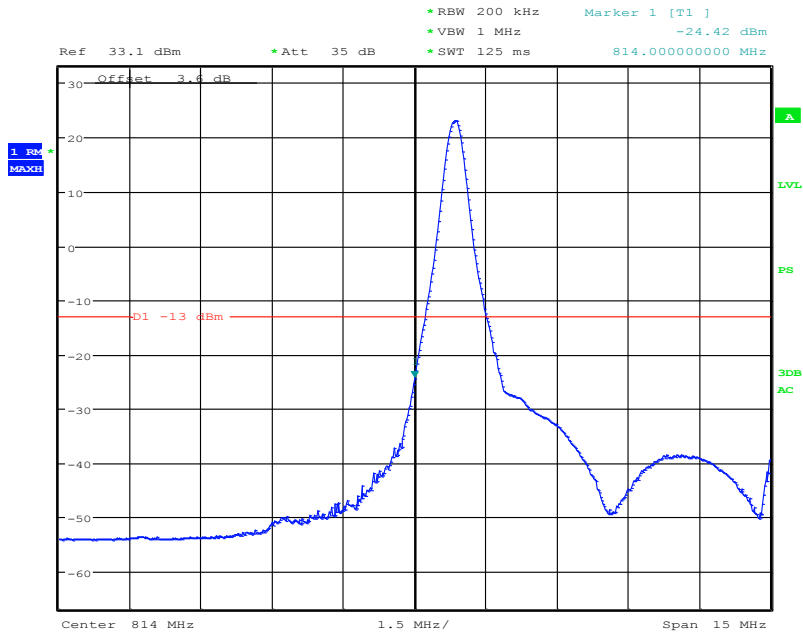

Date: 25.JUN.2015 13:57:47

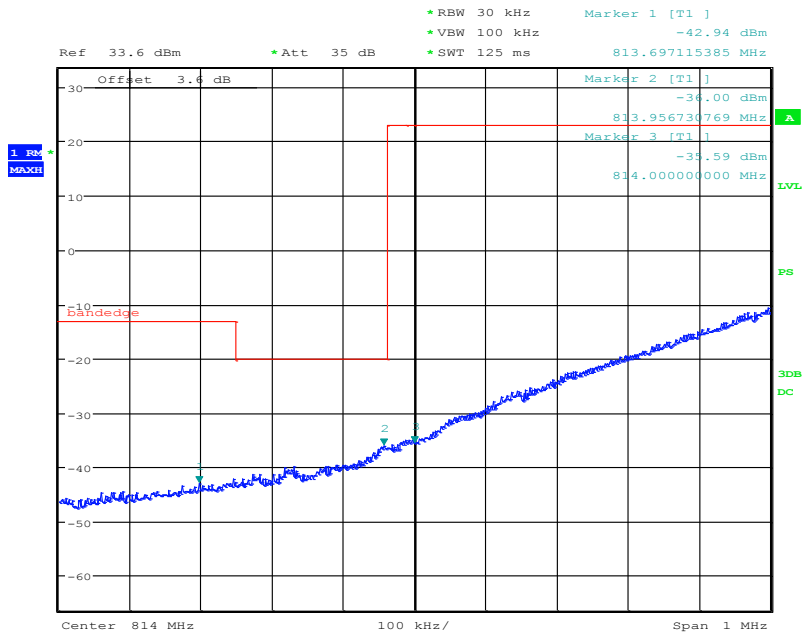

Date: 9.JUL.2015 16:20:40

15MHz bandwidth, QPSK, (75,0) Mode, below 814MHz

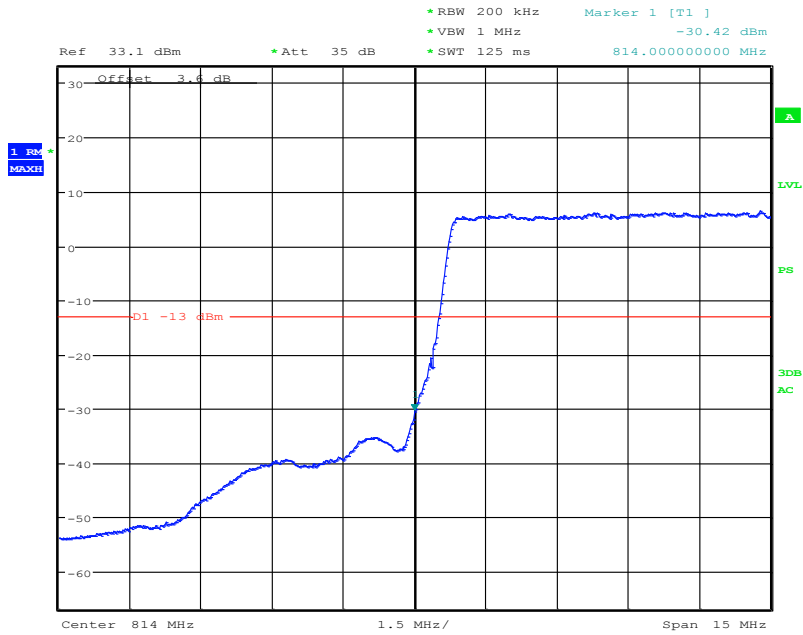

Date: 25.JUN.2015 13:58:12

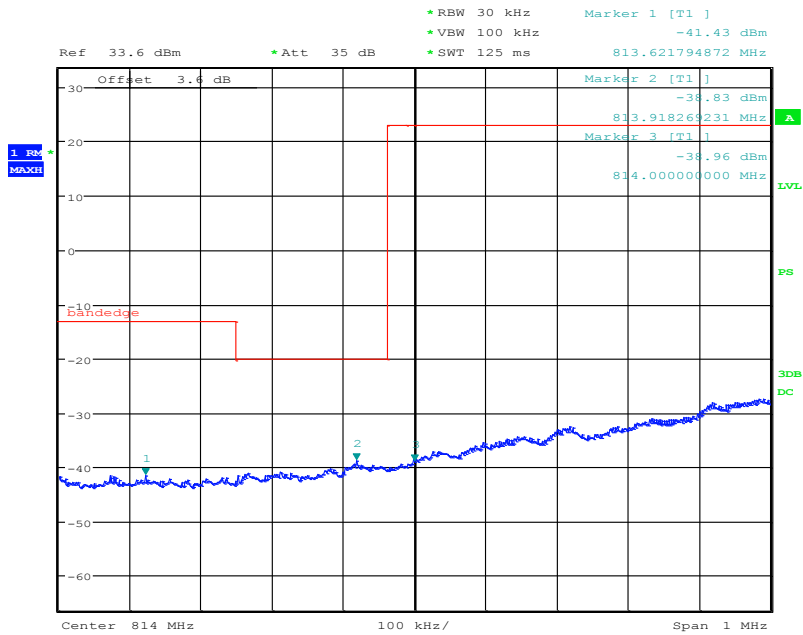

Date: 9.JUL.2015 16:21:24

15MHz bandwidth, QPSK,(1,75) Mode, Above 849MHz

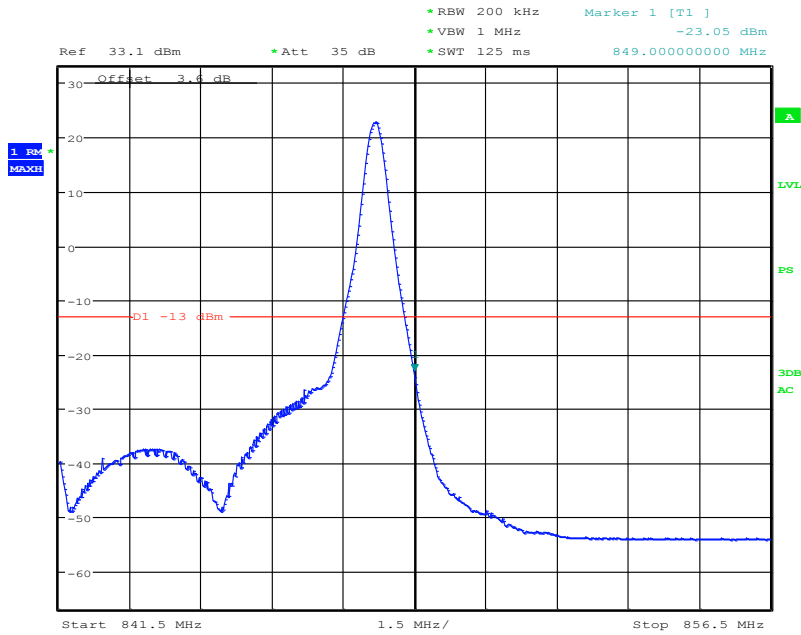

Date: 25.JUN.2015 14:04:06

15MHz bandwidth, QPSK,(75,0) Mode, Above 849MHz

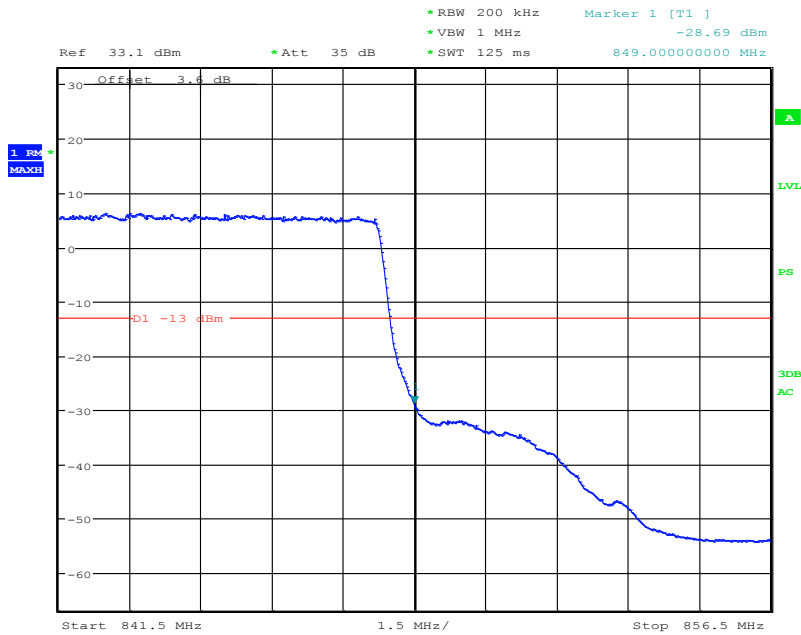

Date: 25.JUN.2015 14:04:23

15MHz bandwidth, 16QAM,(1,0) Mode , below 814MHz

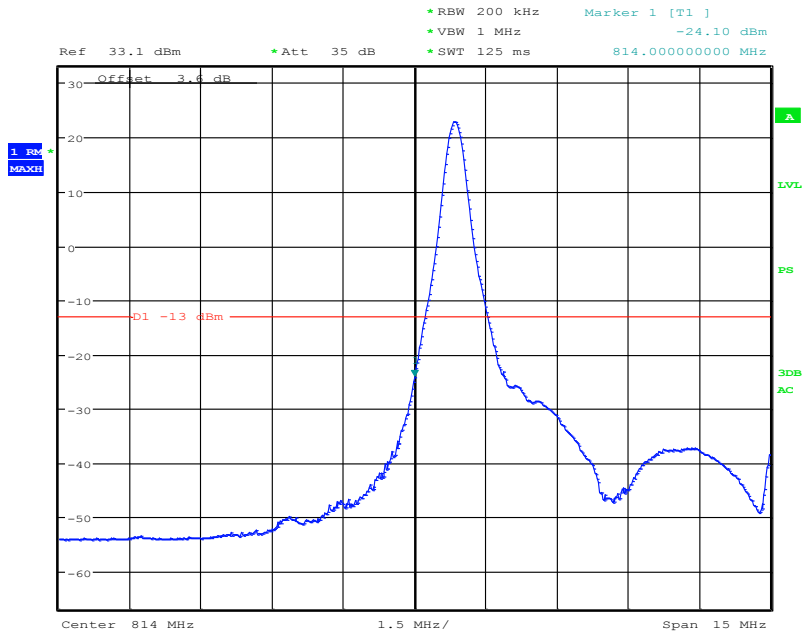

Date: 25.JUN.2015 13:59:15

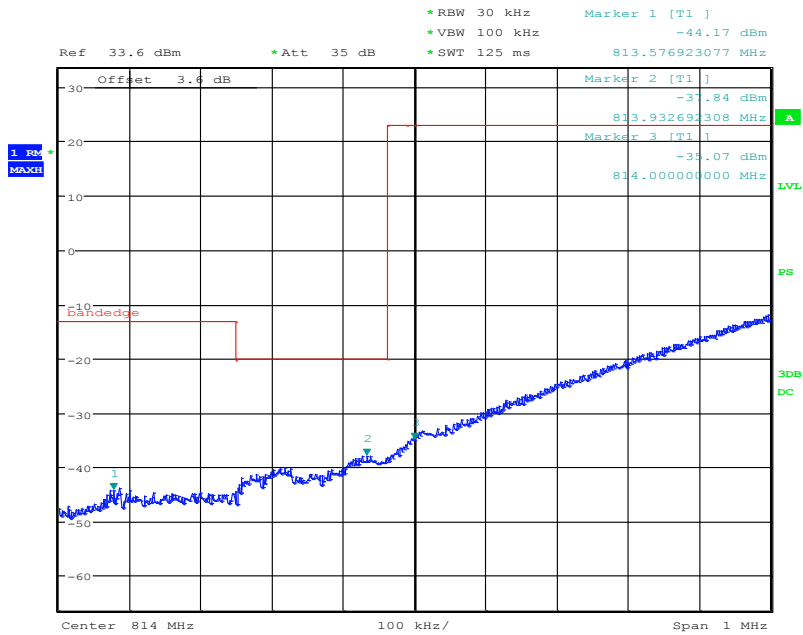

Date: 9.JUL.2015 16:23:07

15MHz bandwidth, 16QAM,(75,0) Mode , below 814MHz

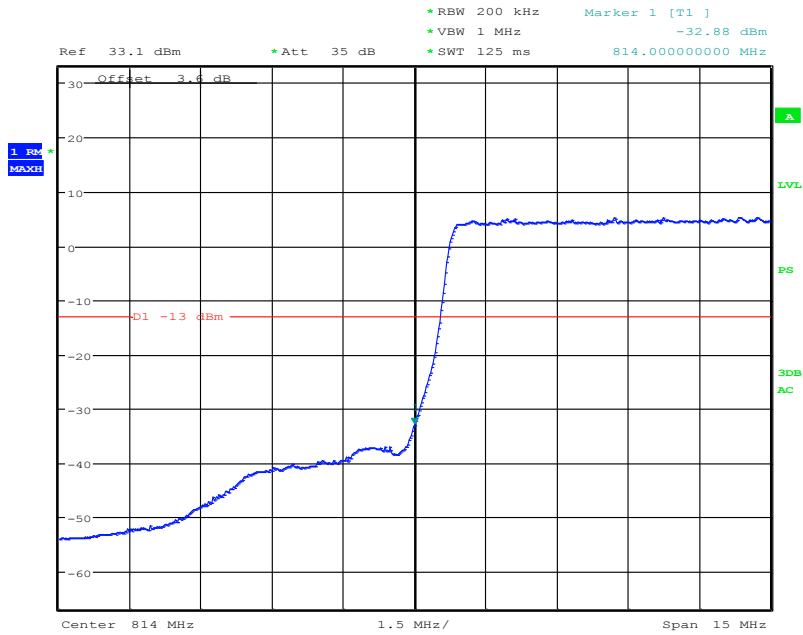

Date: 25.JUN.2015 13:58:32

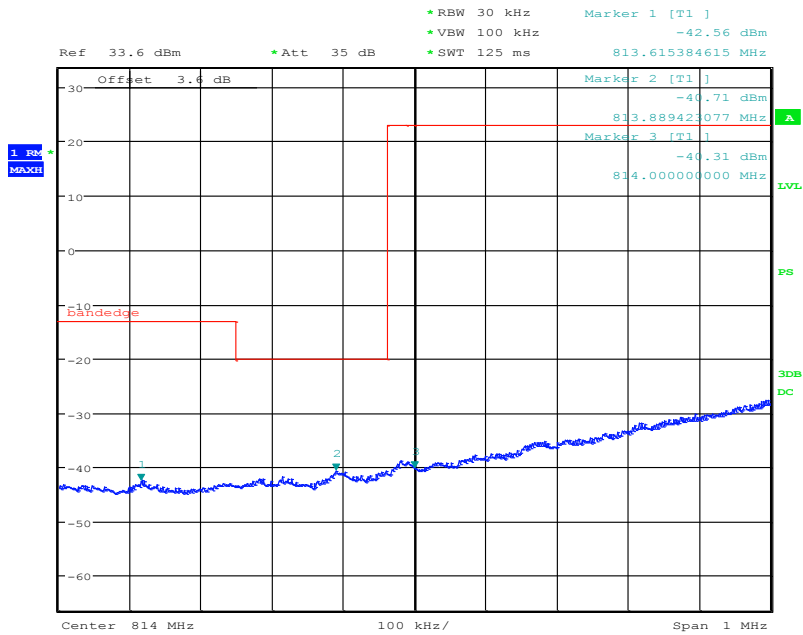

Date: 9.JUL.2015 16:22:24

15MHz bandwidth, 16QAM,(1,75) Mode, Above 849MHz

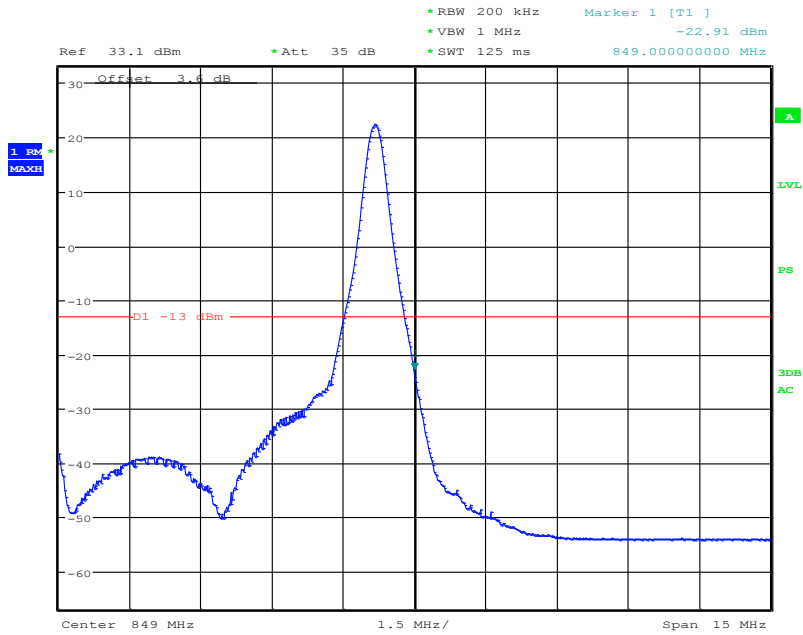

Date: 25.JUN.2015 14:00:29

15MHz bandwidth, 16QAM,(75,0) Mode, Above 849MHz

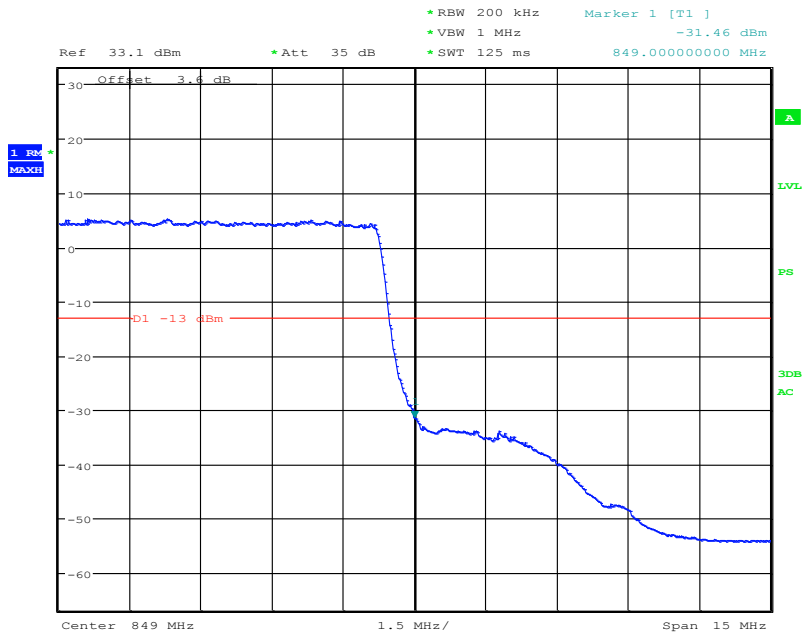

Date: 25.JUN.2015 14:00:49

4.5.7 LTE B30 Band Edge Results

Graphical results:

5MHz bandwidth, QPSK,(1,0) Mode , below 2305MHz

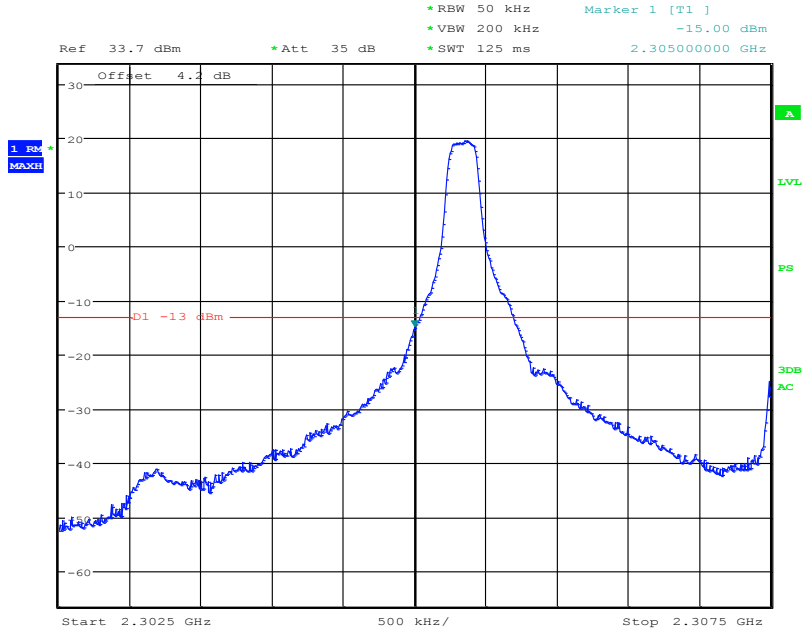

Date: 25.JUN.2015 14:08:58

5MHz bandwidth, QPSK,(25,0) Mode , below 2305MHz

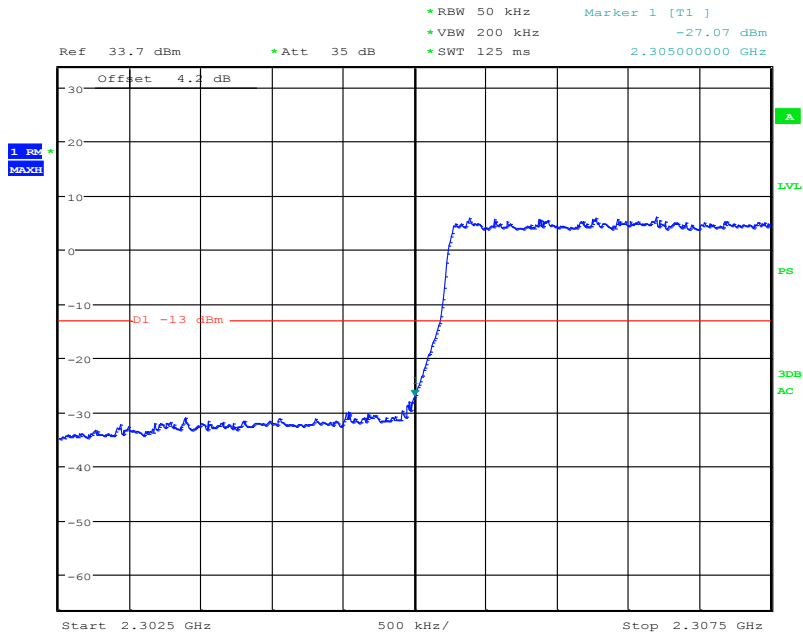

Date: 25.JUN.2015 14:09:26

5MHz bandwidth, QPSK, 2296MHz-2300MHz, below 2305MHz

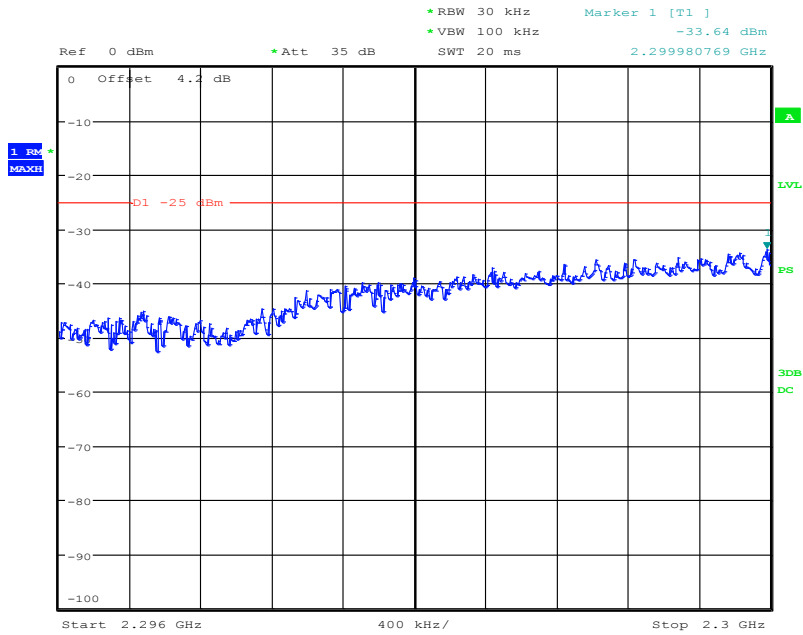

Date: 1.JUL.2015 15:35:47

5MHz bandwidth, QPSK, 2292MHz-2296MHz, below 2305MHz

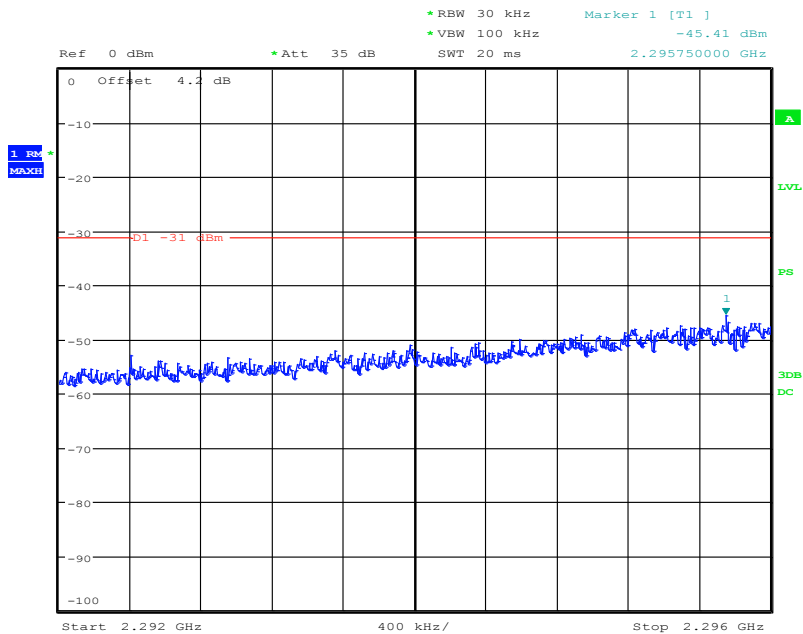

Date: 1.JUL.2015 15:39:07

5MHz bandwidth, QPSK, 2288MHz-2292MHz, below 2305MHz

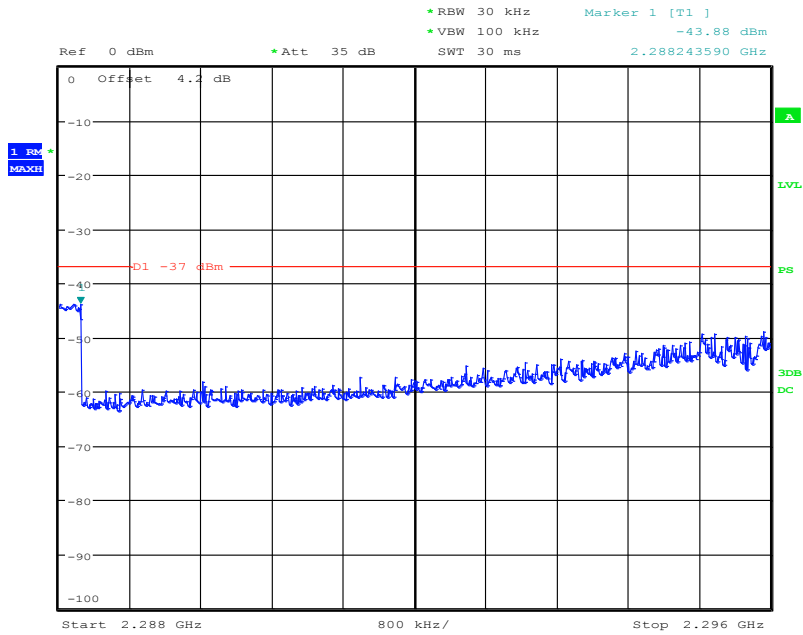

Date: 1.JUL.2015 15:41:03

5MHz bandwidth, QPSK, 30MHz-2288MHz, below 2305MHz

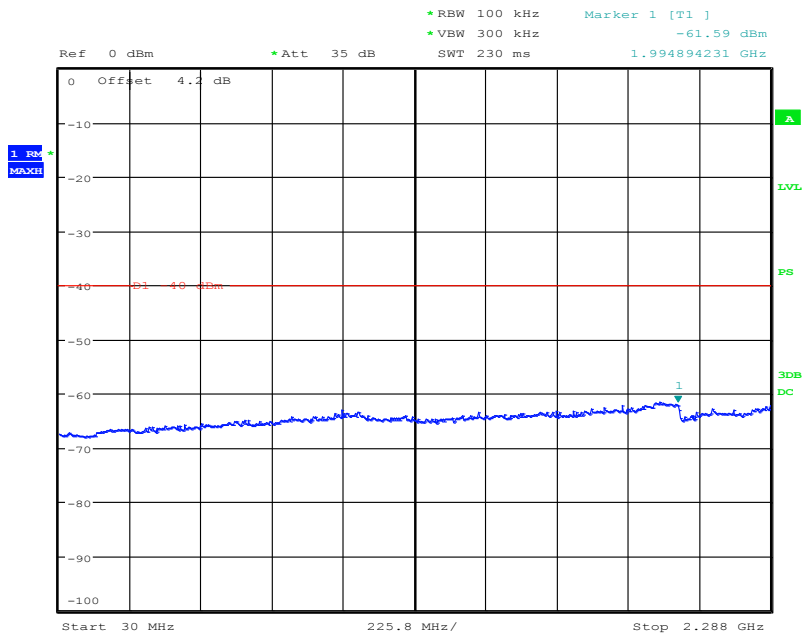

Date: 1.JUL.2015 15:46:54

5MHz bandwidth, QPSK,(1,25) Mode, Above 2315MHz

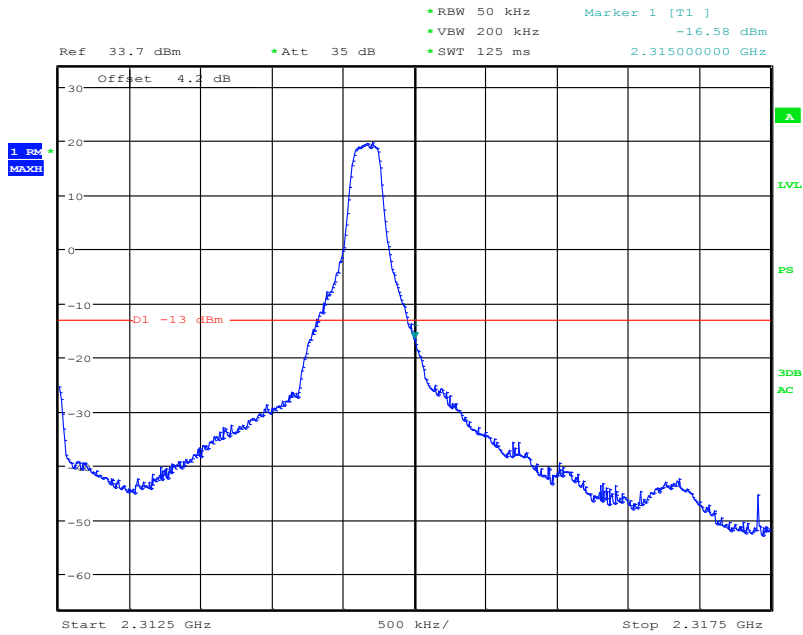

Date: 25.JUN.2015 14:11:32

5MHz bandwidth, QPSK,(25,0) Mode, Above 2315MHz

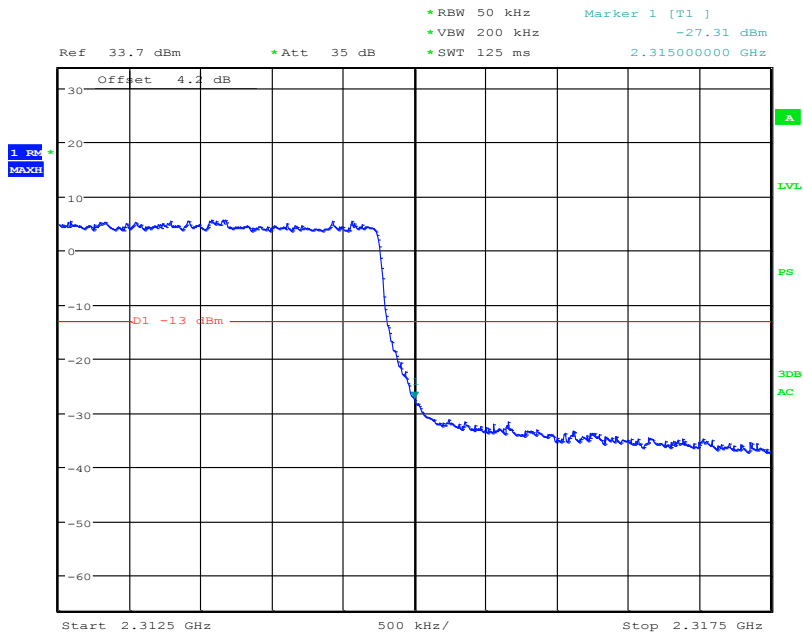

Date: 25.JUN.2015 14:12:02

5MHz bandwidth, QPSK, 2320MHz-2324MHz, Above 2315MHz

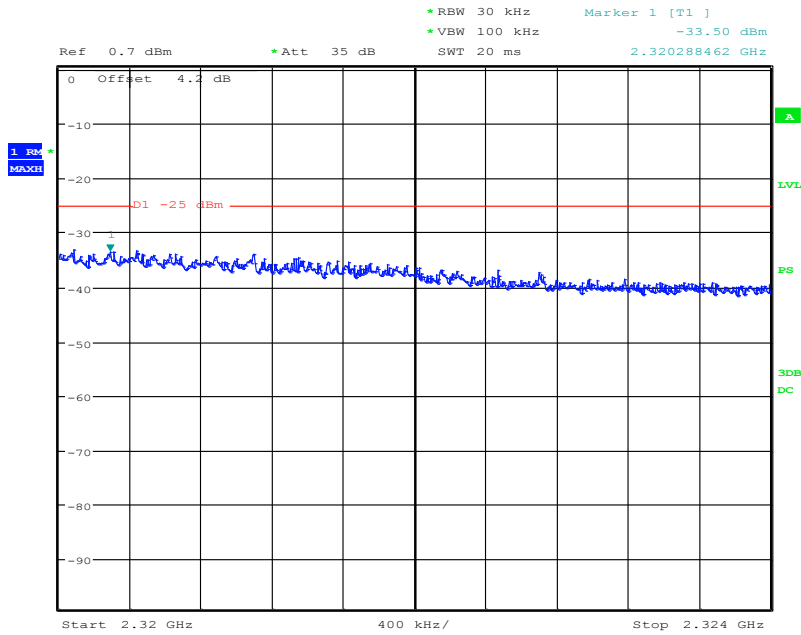

Date: 1.JUL.2015 15:18:07

5MHz bandwidth, QPSK, 2324MHz-2328MHz, Above 2315MHz

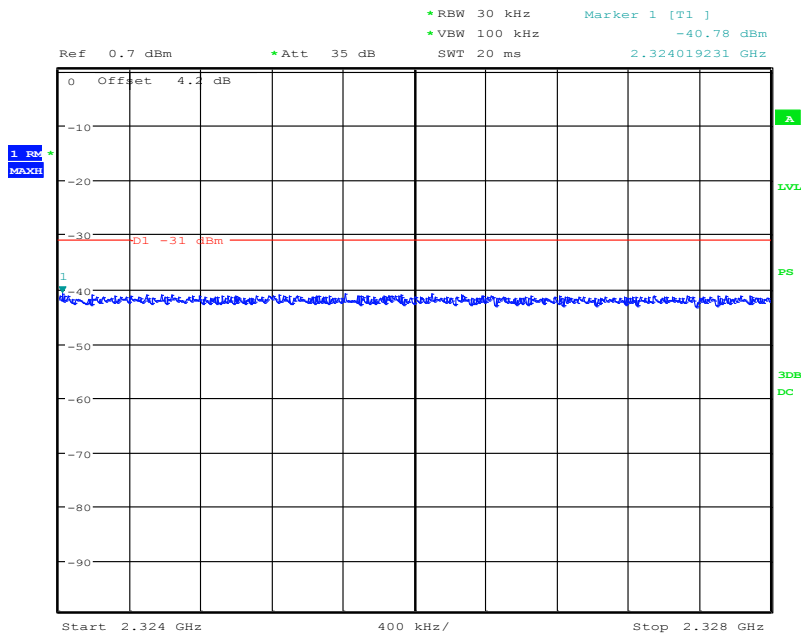

Date: 1.JUL.2015 15:24:05

5MHz bandwidth, QPSK, 2328MHz-2337MHz, Above 2315MHz

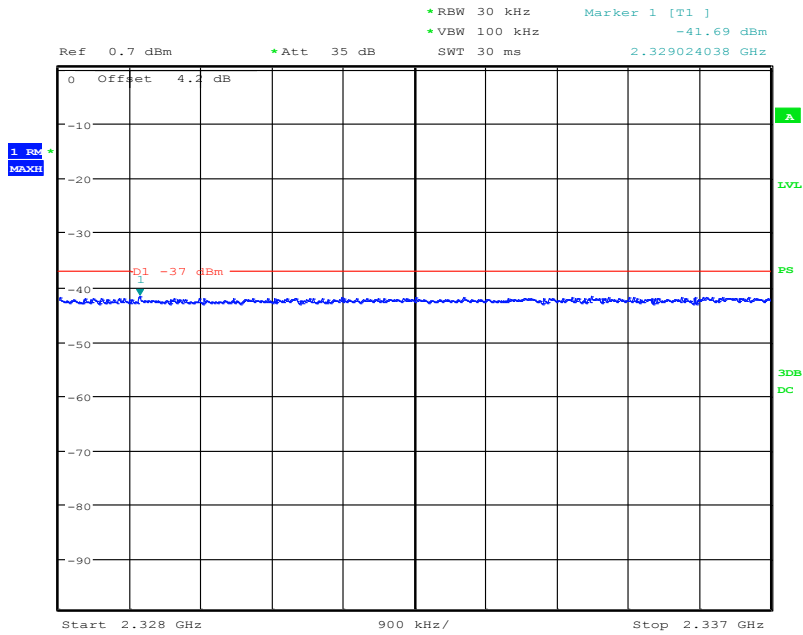

Date: 1.JUL.2015 15:25:45

5MHz bandwidth, 16QAM,(1,0) Mode , below 2305MHz

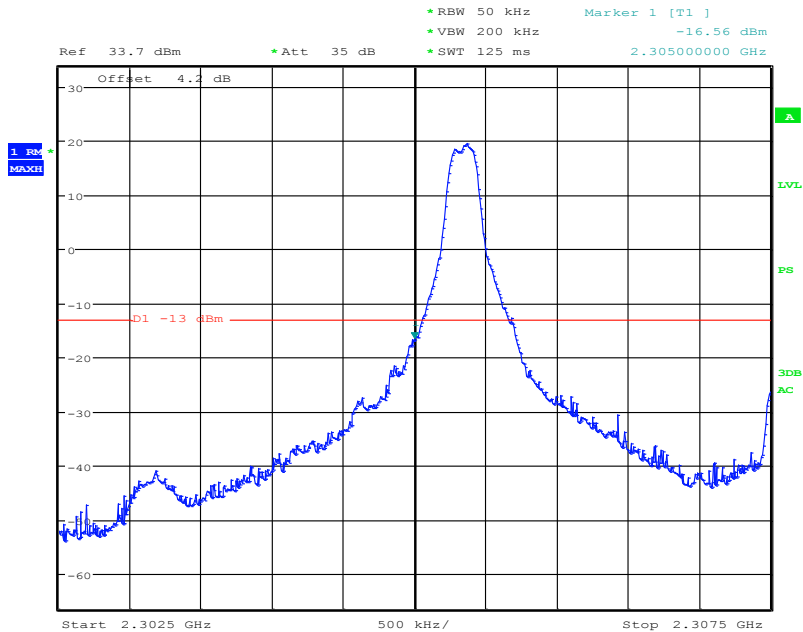

Date: 25.JUN.2015 14:10:22

5MHz bandwidth, 16QAM,(25,0) Mode , below 2305MHz

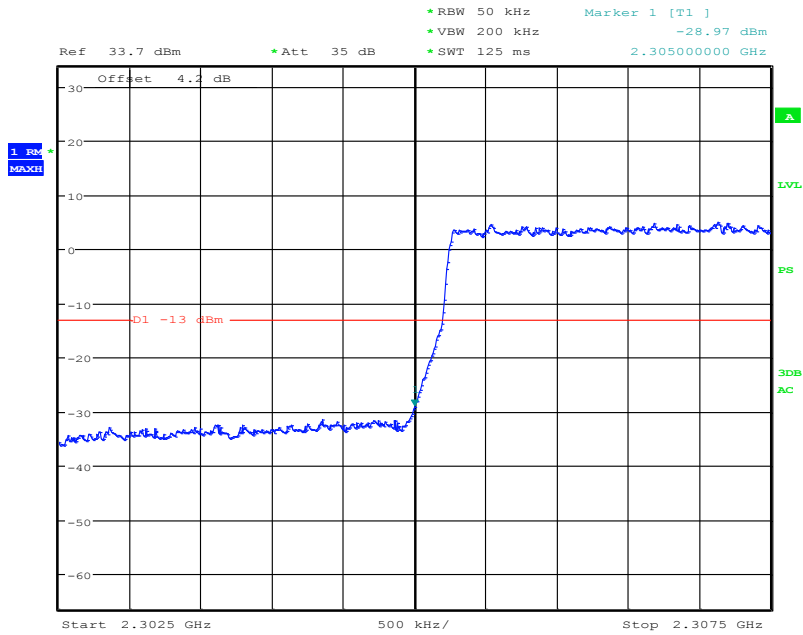

Date: 25.JUN.2015 14:09:47

5MHz bandwidth, 16QAM, 2296MHz-2300MHz, below 2305MHz

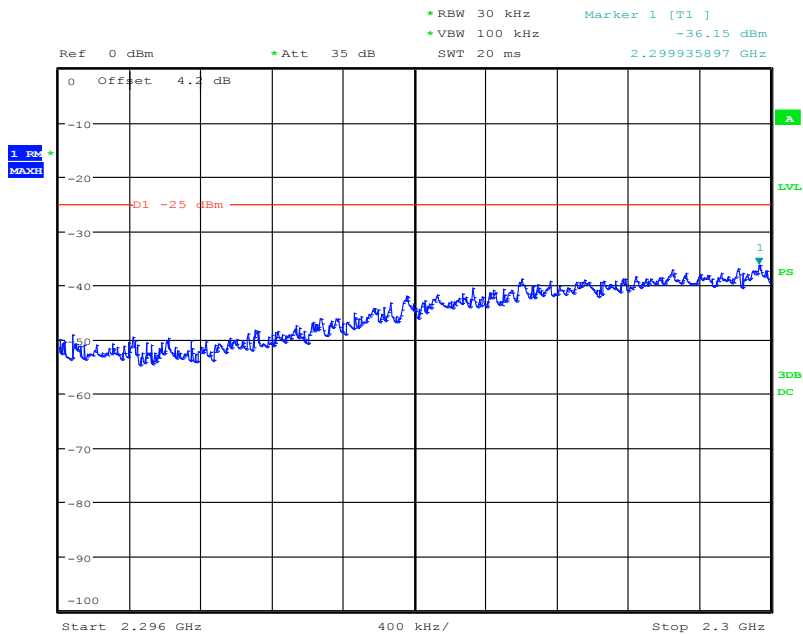

Date: 1.JUL.2015 15:35:22

5MHz bandwidth, 16QAM, 30MHz-2288MHz, below 2305MHz

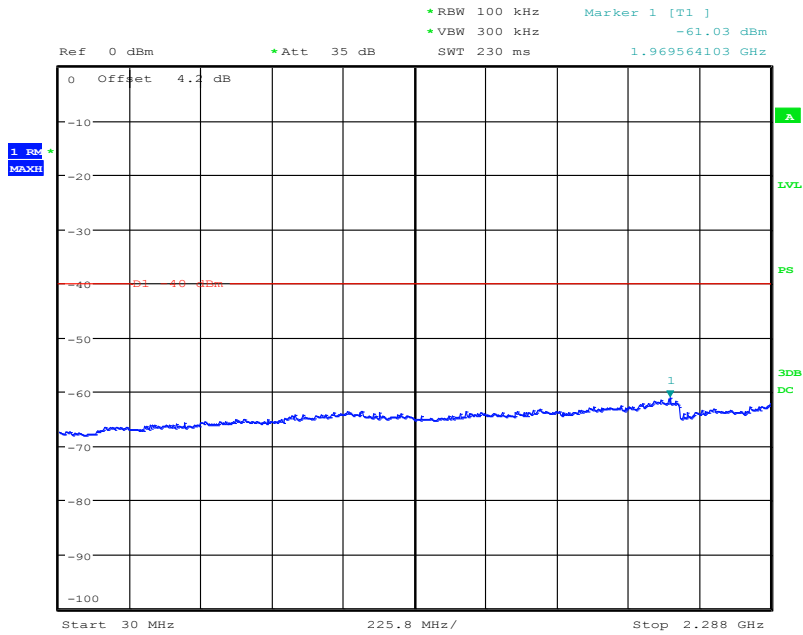

Date: 1.JUL.2015 15:47:21

5MHz bandwidth, 16QAM,(1,25) Mode, Above 2315MHz

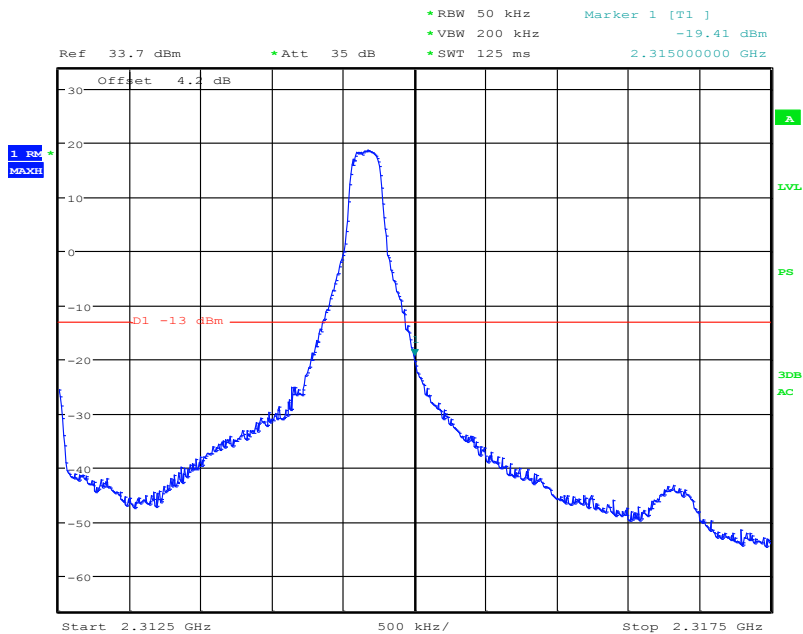

Date: 25.JUN.2015 14:12:57

5MHz bandwidth, 16QAM,(25,0) Mode, Above 2315MHz

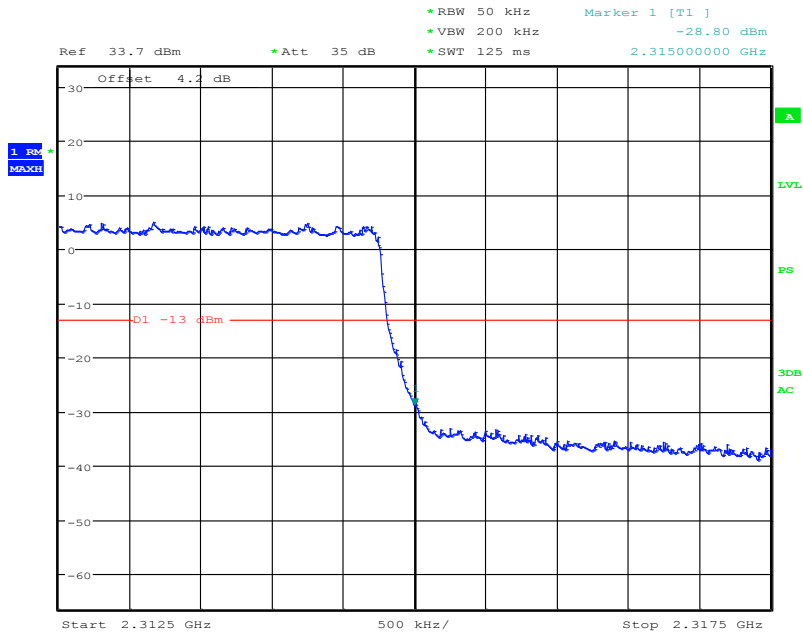

Date: 25.JUN.2015 14:12:28

5MHz bandwidth, 16QAM, 2320MHz-2324MHz, Above 2315MHz

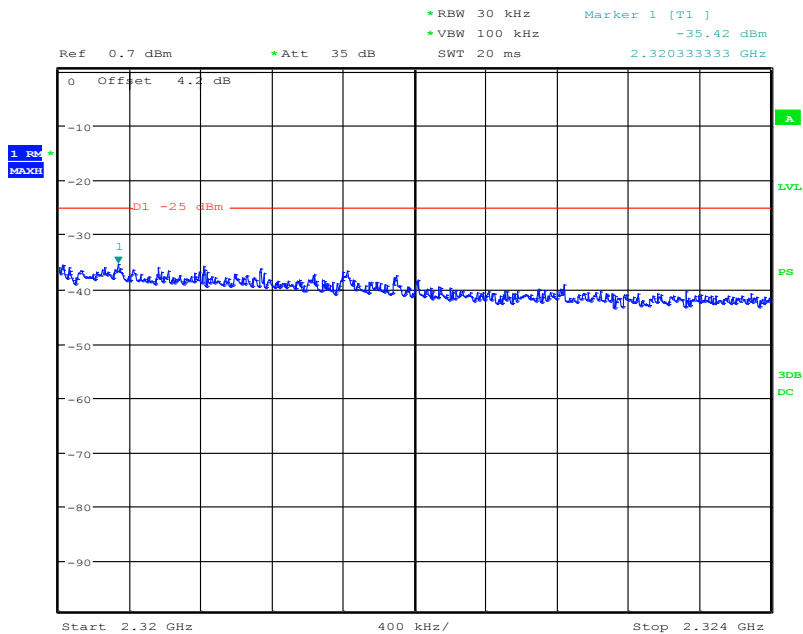

Date: 1.JUL.2015 15:18:33

5MHz bandwidth, 16QAM, 2324MHz-2328MHz, Above 2315MHz

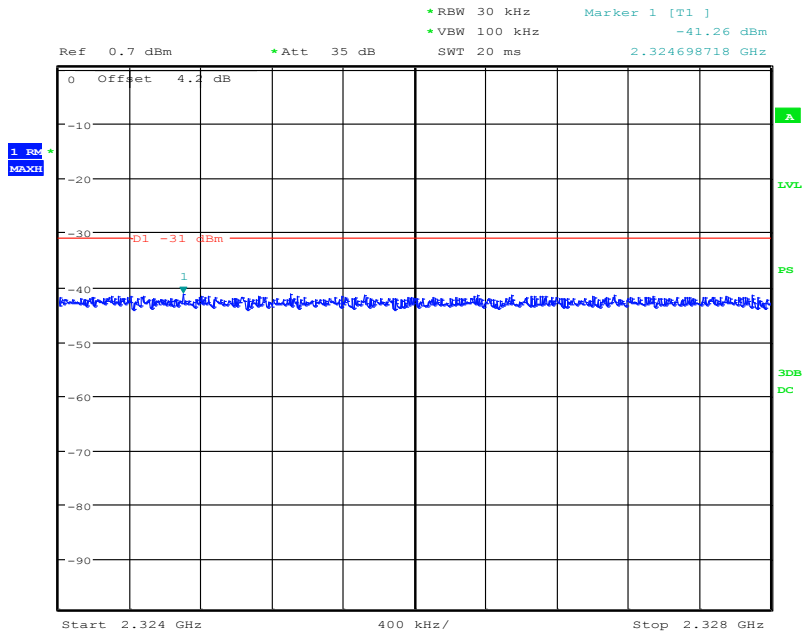

Date: 1.JUL.2015 15:23:36

5MHz bandwidth, 16QAM, 2328MHz-2337MHz, Above 2315MHz

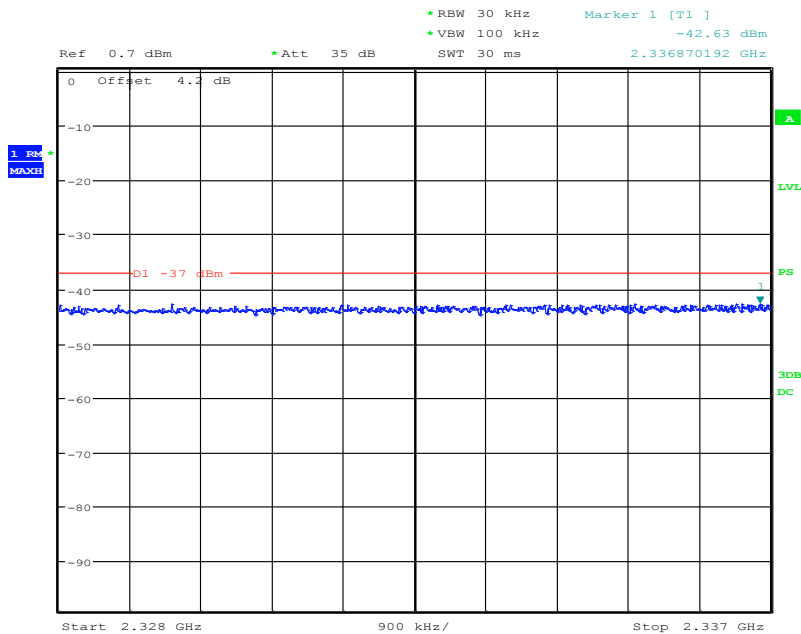

Date: 1.JUL.2015 15:26:14

10MHz bandwidth, QPSK,(1,0) Mode , below 2305MHz

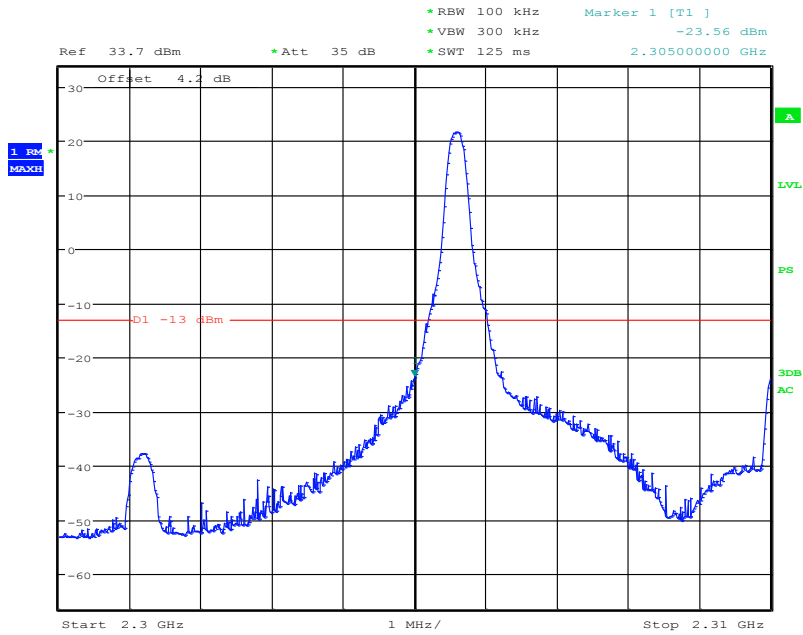

Date: 25.JUN.2015 14:21:34

10MHz bandwidth, QPSK,(50,0) Mode , below 2305MHz

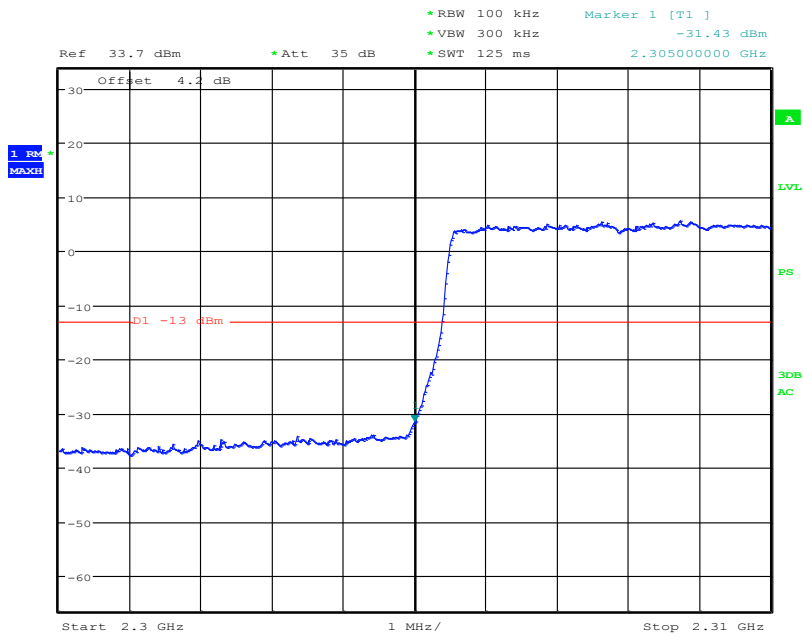

Date: 25.JUN.2015 14:20:46

10MHz bandwidth, QPSK, 2296MHz-2300MHz, below 2305MHz

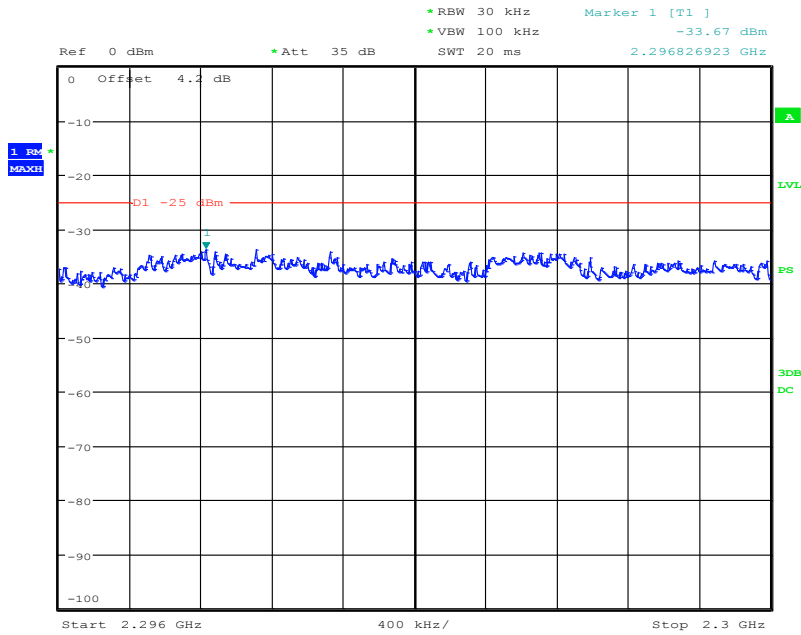

Date: 1.JUL.2015 15:36:53

10MHz bandwidth, QPSK, 2292MHz-2296MHz, below 2305MHz

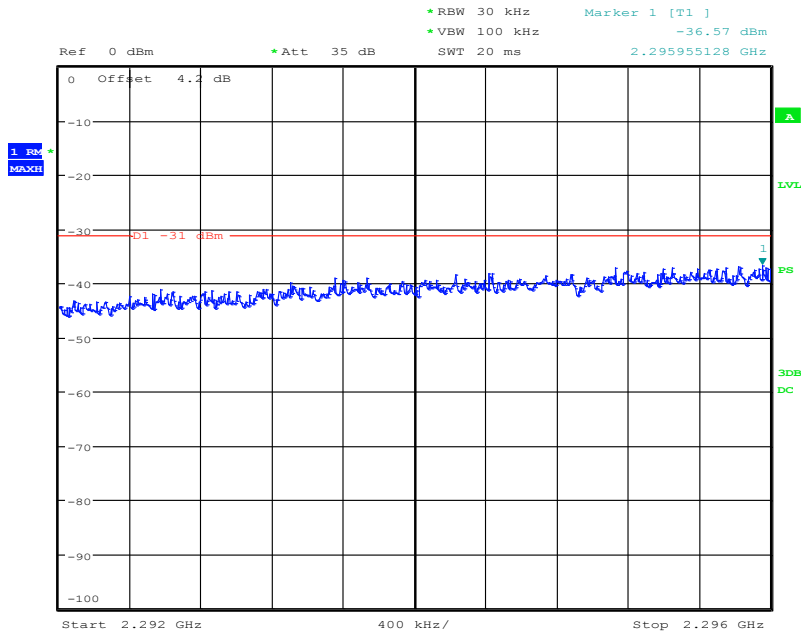

Date: 1.JUL.2015 15:37:37

10MHz bandwidth, QPSK, 2288MHz-2292MHz, below 2305MHz

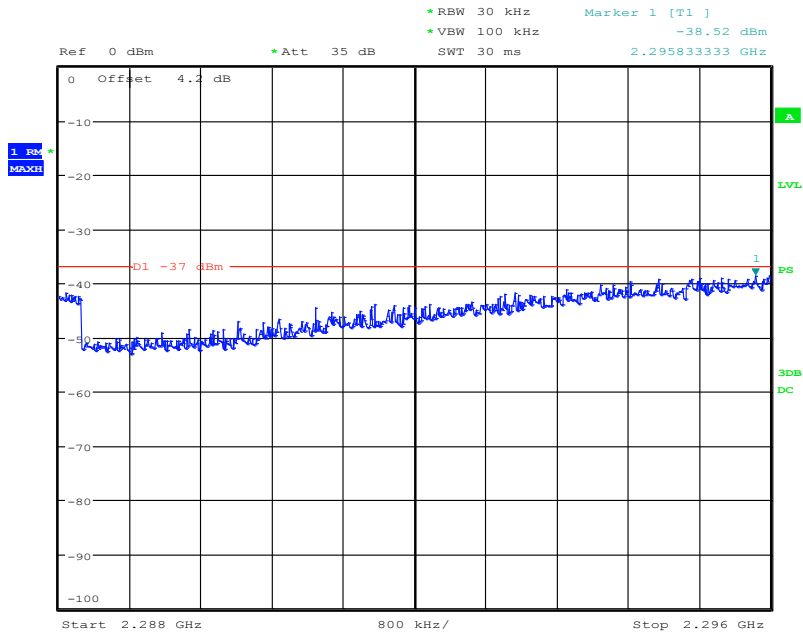

Date: 1.JUL.2015 15:43:10

10MHz bandwidth, QPSK, 30MHz-2288MHz, below 2305MHz

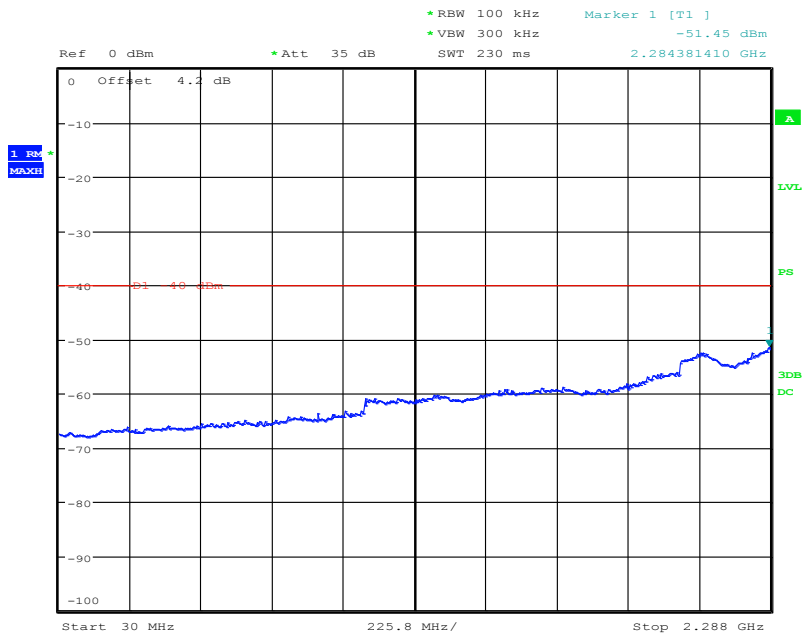

Date: 1.JUL.2015 15:44:37

10MHz bandwidth, QPSK,(1,50) Mode, Above 2315MHz

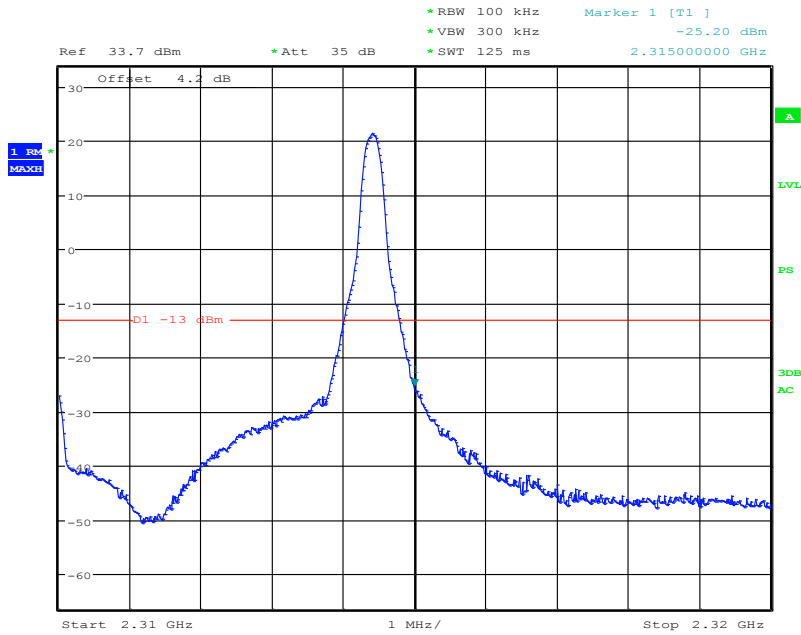

Date: 25.JUN.2015 14:19:23

10MHz bandwidth, QPSK,(50,0) Mode, Above 2315MHz

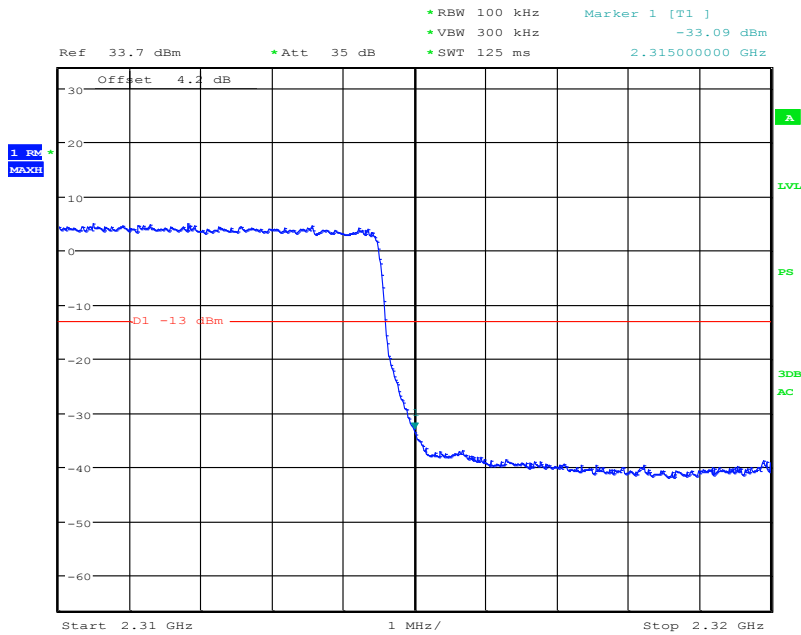

Date: 25.JUN.2015 14:19:40

10MHz bandwidth, QPSK, 2320MHz-2324MHz, Above 2315MHz

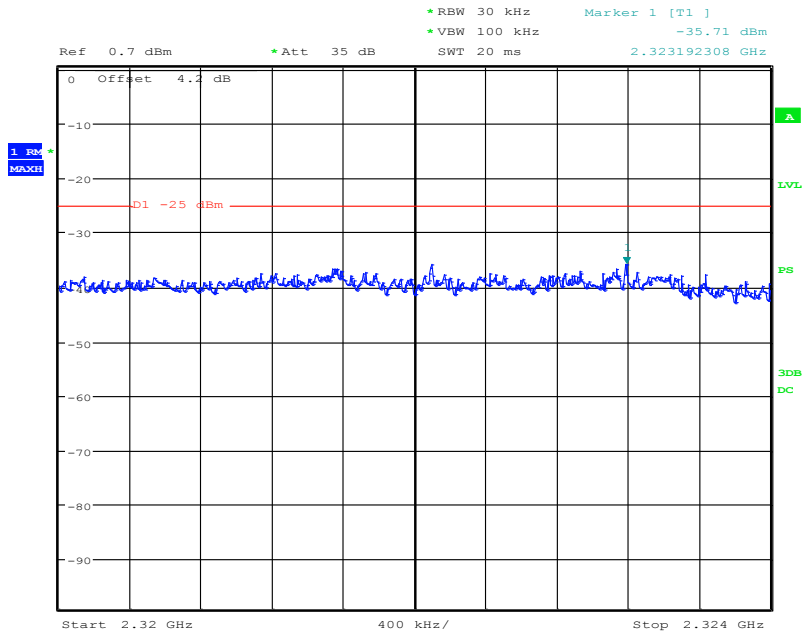

Date: 1.JUL.2015 15:20:18

10MHz bandwidth, QPSK, 2324MHz-2328MHz, Above 2315MHz

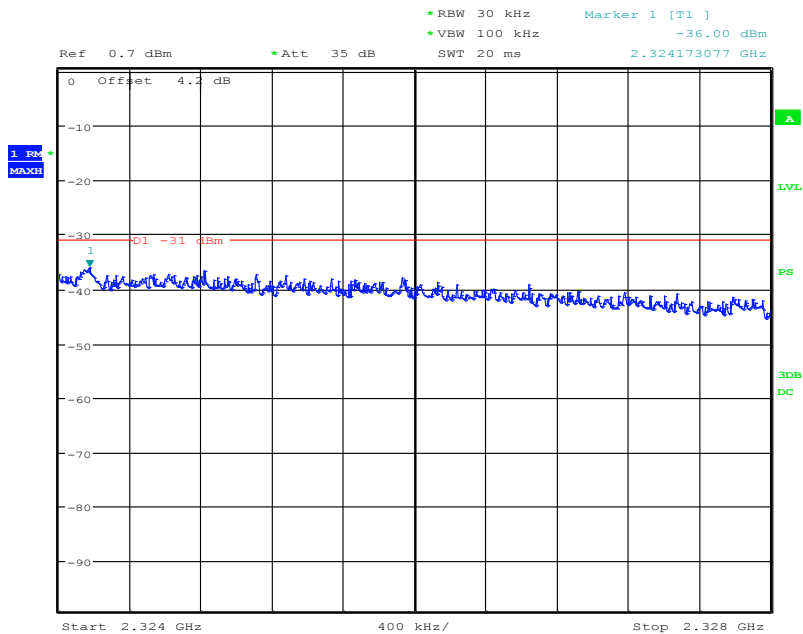

Date: 1.JUL.2015 15:22:10

10MHz bandwidth, QPSK, 2328MHz-2337MHz, Above 2315MHz

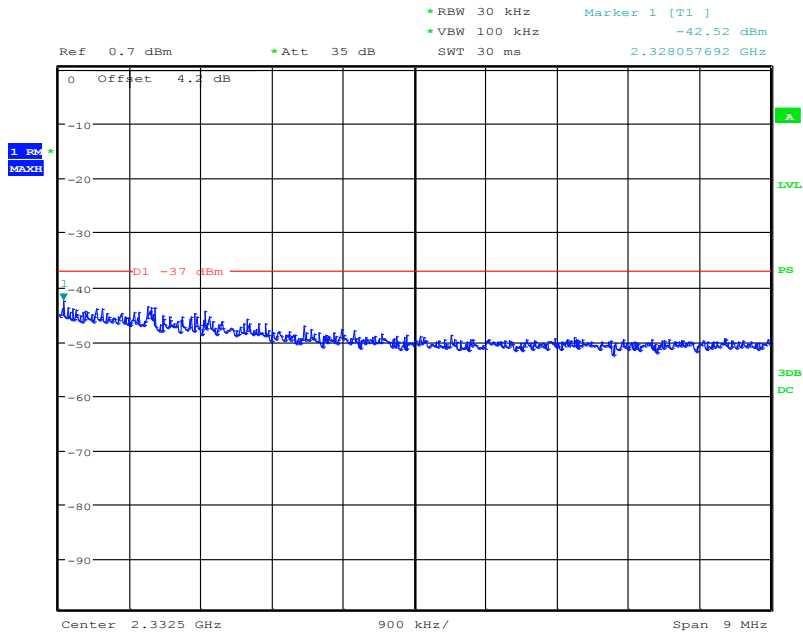

Date: 1.JUL.2015 15:27:20

10MHz bandwidth, 16QAM,(1,0) Mode , below 2305MHz

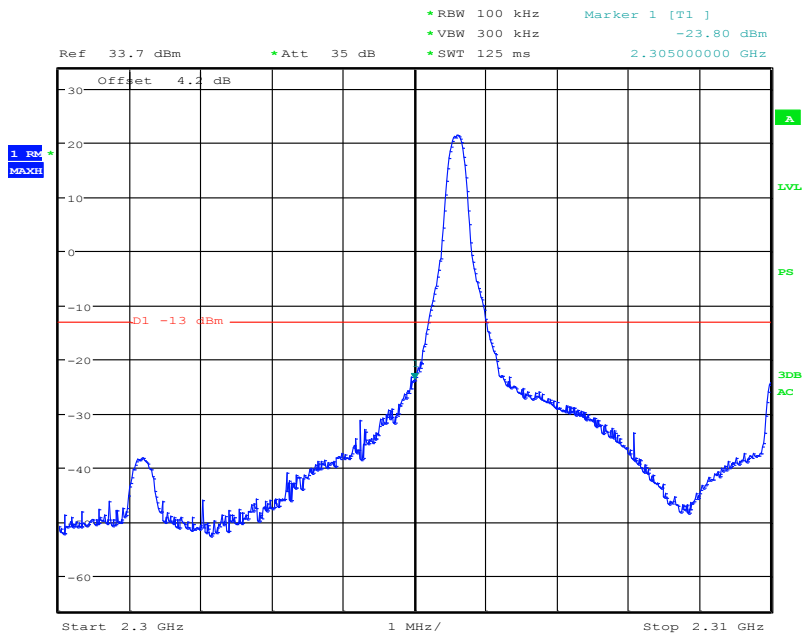

Date: 25.JUN.2015 14:22:30

10MHz bandwidth, 16QAM,(50,0) Mode , below 2305MHz

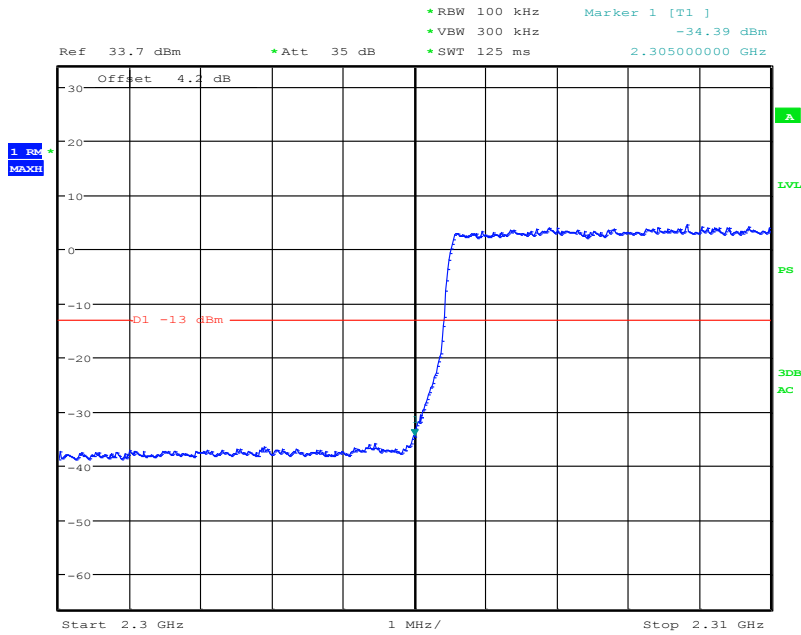

Date: 25.JUN.2015 14:22:48

10MHz bandwidth, 16QAM, 2296MHz-2300MHz, below 2305MHz

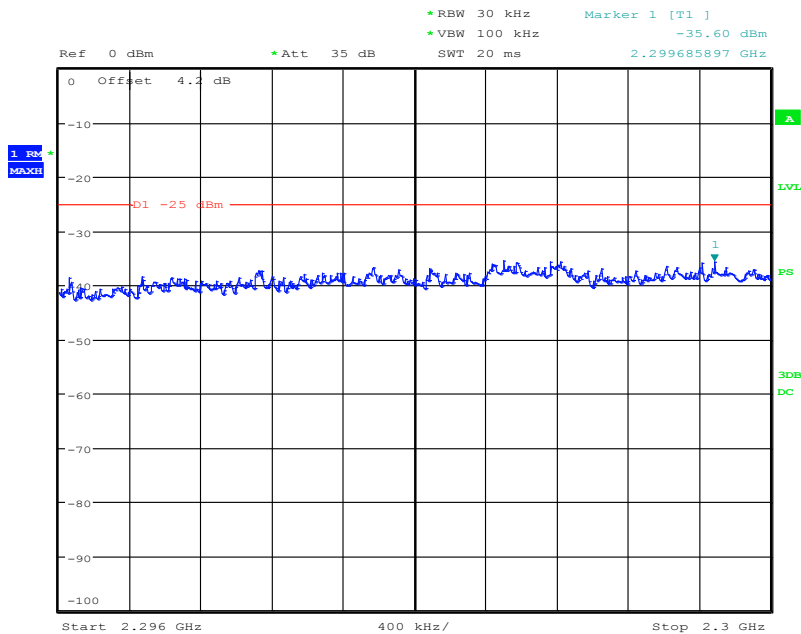

Date: 1.JUL.2015 15:36:26

10MHz bandwidth, 16QAM, 2292MHz-2296MHz, below 2305MHz

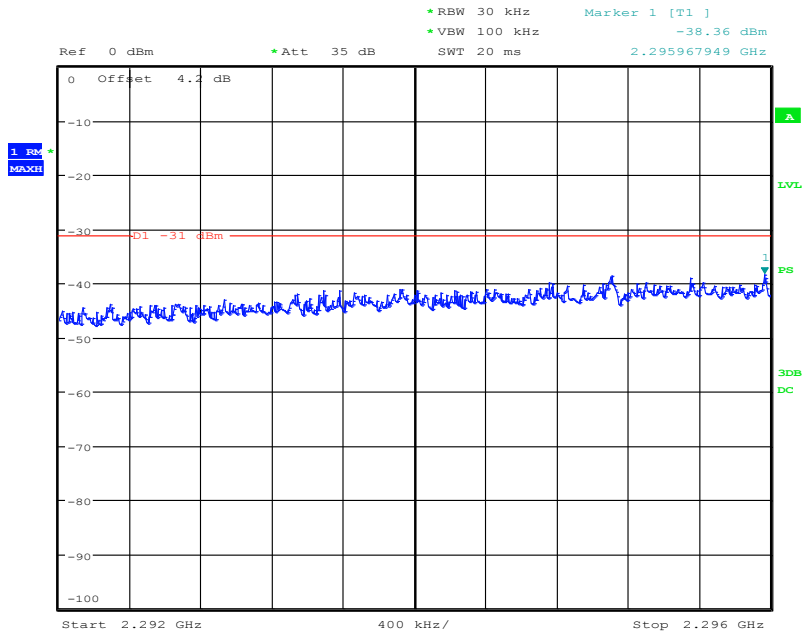

Date: 1.JUL.2015 15:38:17

10MHz bandwidth, 16QAM, 2288MHz-2292MHz, below 2305MHz

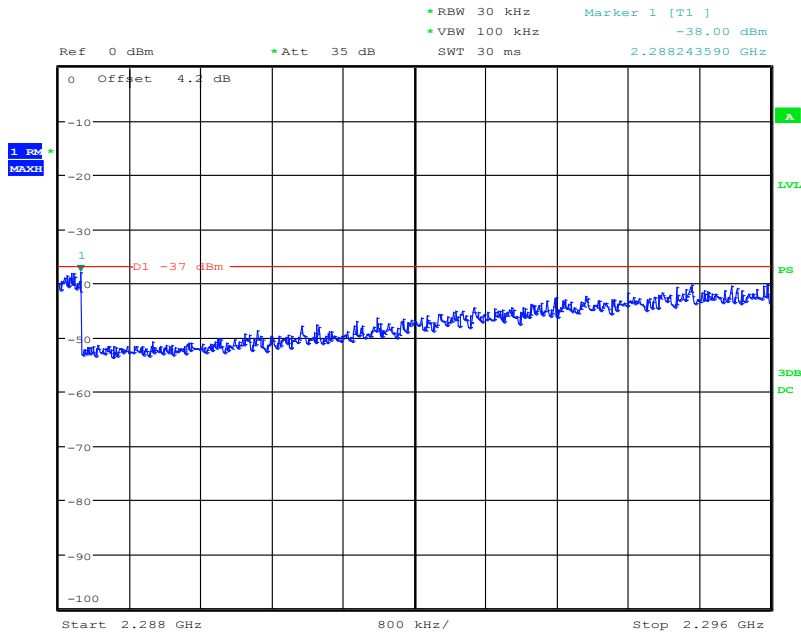

Date: 1.JUL.2015 15:42:43

10MHz bandwidth, 16QAM, 30MHz-2288MHz, below 2305MHz

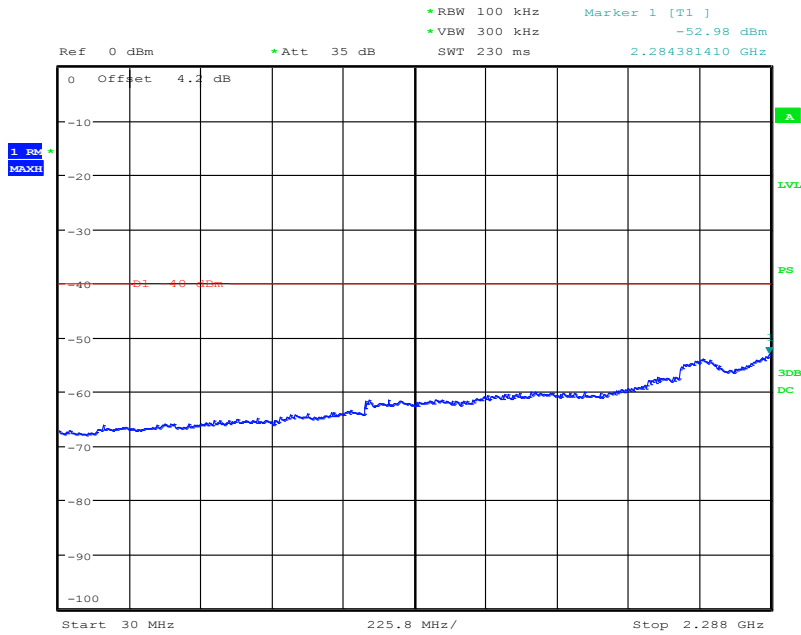

Date: 1.JUL.2015 15:45:16

10MHz bandwidth, 16QAM,(1,50) Mode, Above 2315MHz

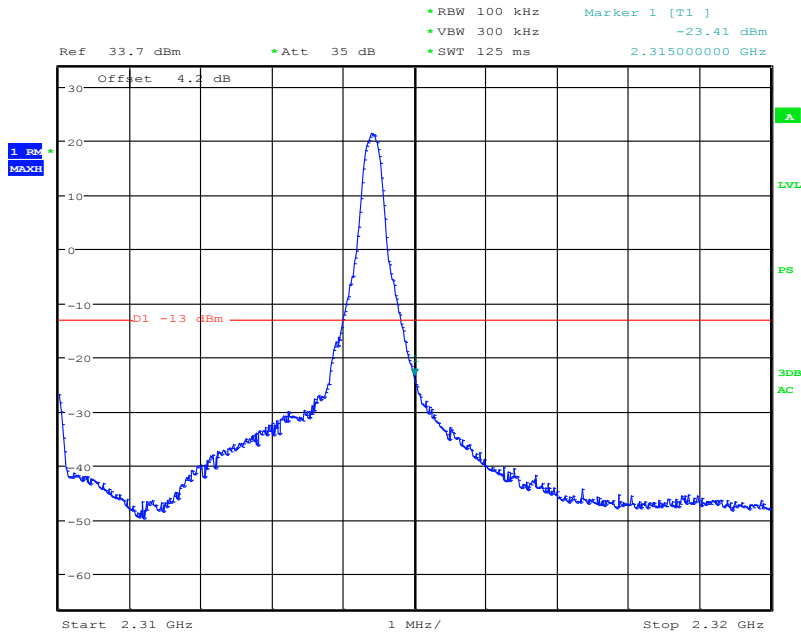

Date: 25.JUN.2015 14:24:14

10MHz bandwidth, 16QAM,(50,0) Mode, Above 2315MHz

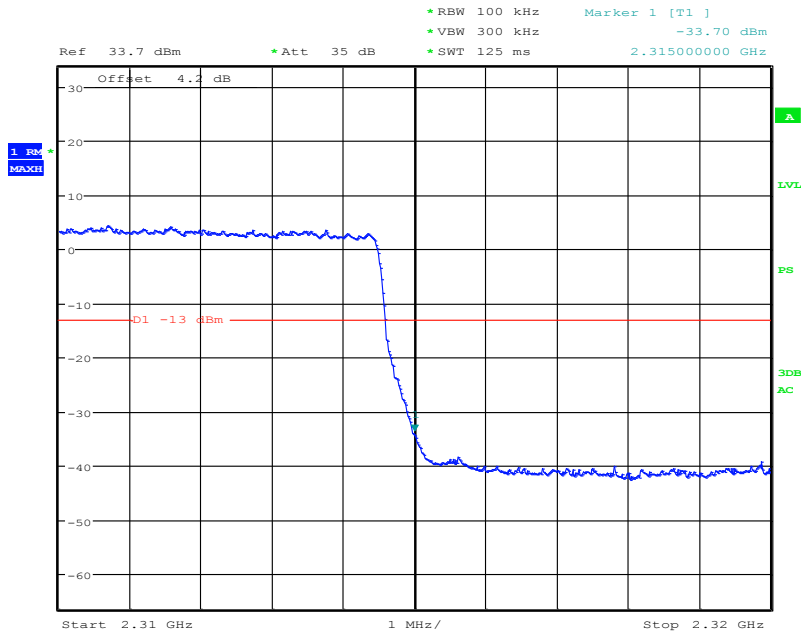

Date: 25.JUN.2015 14:23:23

10MHz bandwidth, 16QAM, 2320MHz-2324MHz, Above 2315MHz

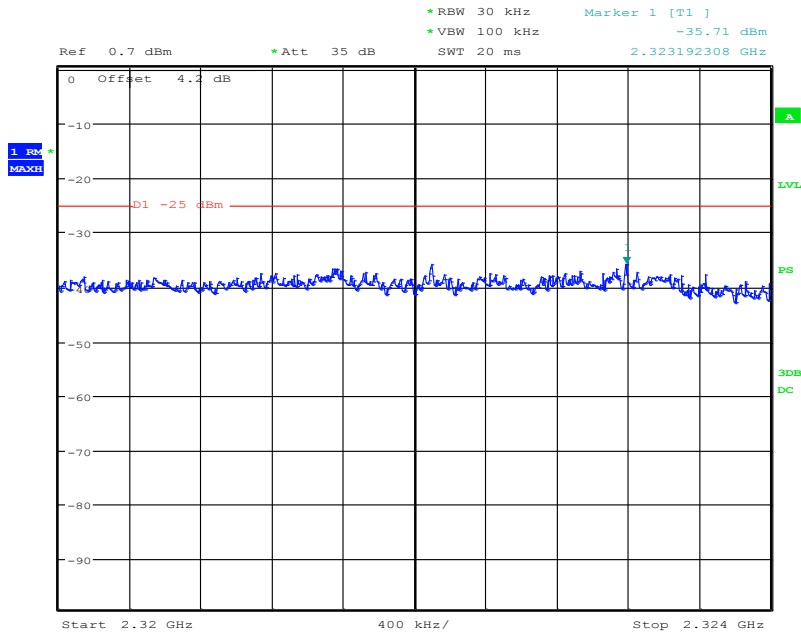

Date: 1.JUL.2015 15:20:18

10MHz bandwidth, 16QAM, 2324MHz-2328MHz, Above 2315MHz

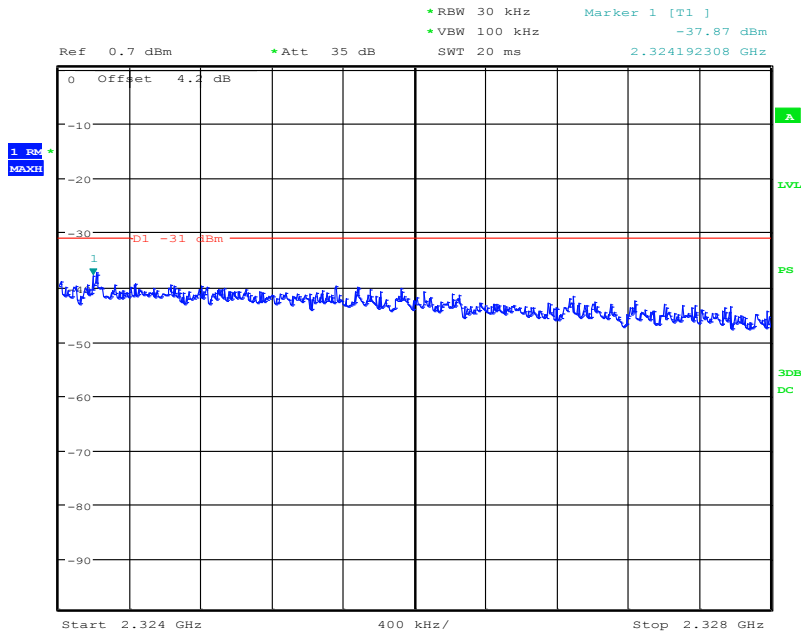

Date: 1.JUL.2015 15:22:40

10MHz bandwidth, 16QAM, 2328MHz-2337MHz, Above 2315MHz

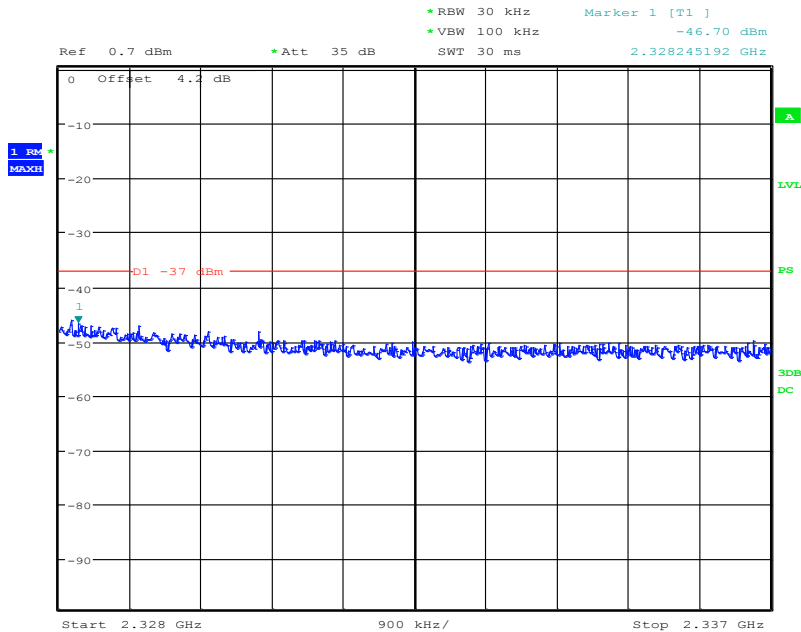

Date: 1.JUL.2015 15:26:53

4.5.8 LTE B41 Band Edge Results

Graphical results:

5MHz bandwidth, QPSK, (1,0) Mode, below 2496MHz

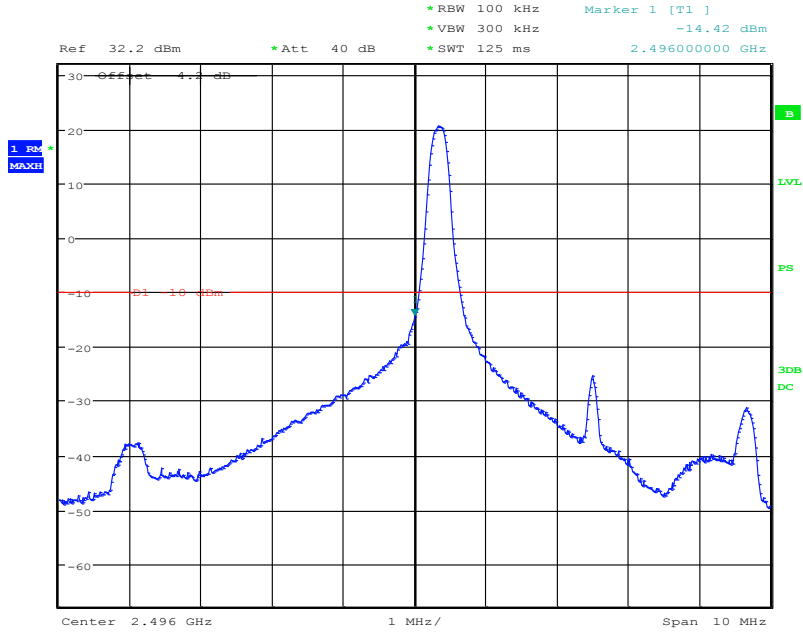

Date: 3.JUL.2015 19:07:24

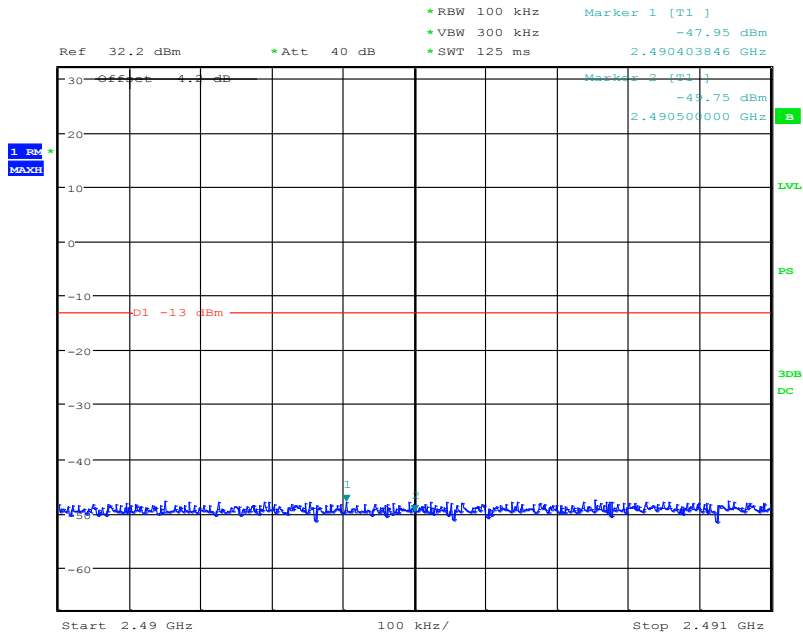

Date: 3.JUL.2015 19:10:14

5MHz bandwidth, QPSK, (25,0) Mode , below 2496MHz

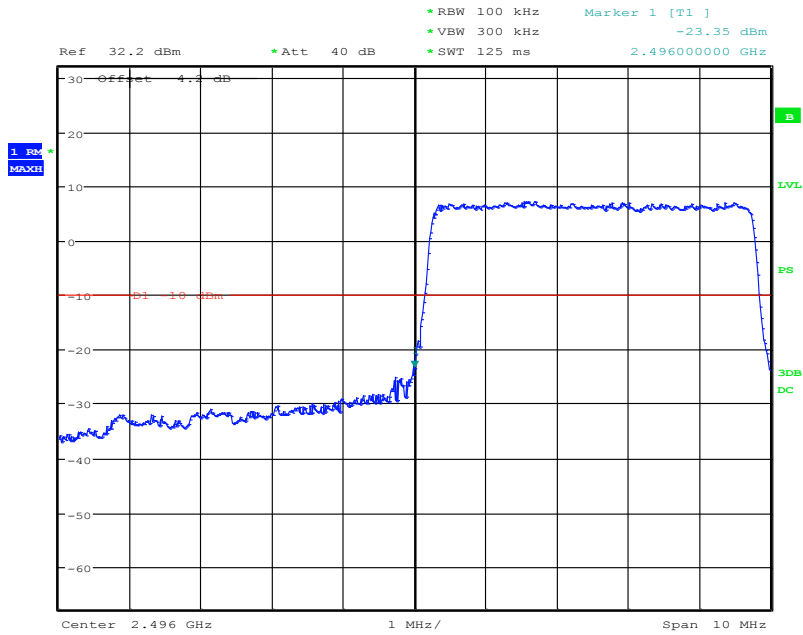

Date: 3.JUL.2015 19:07:45

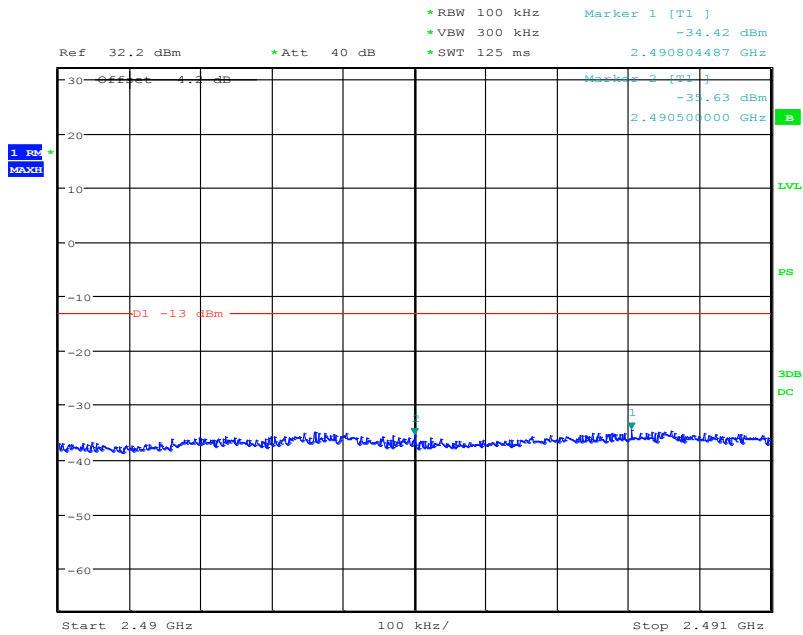

Date: 3.JUL.2015 19:09:59

5MHz bandwidth, QPSK,(1,25) Mode, Above 2690MHz

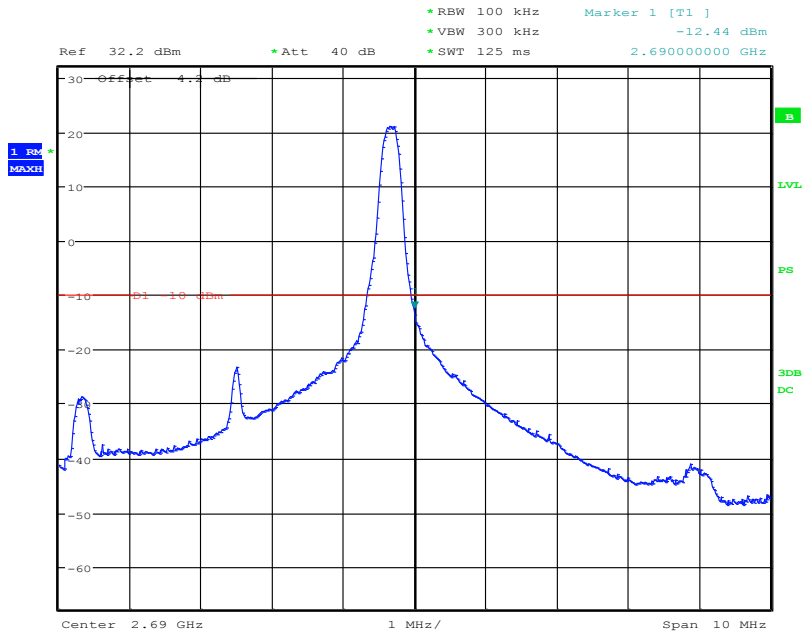

Date: 3.JUL.2015 19:13:34

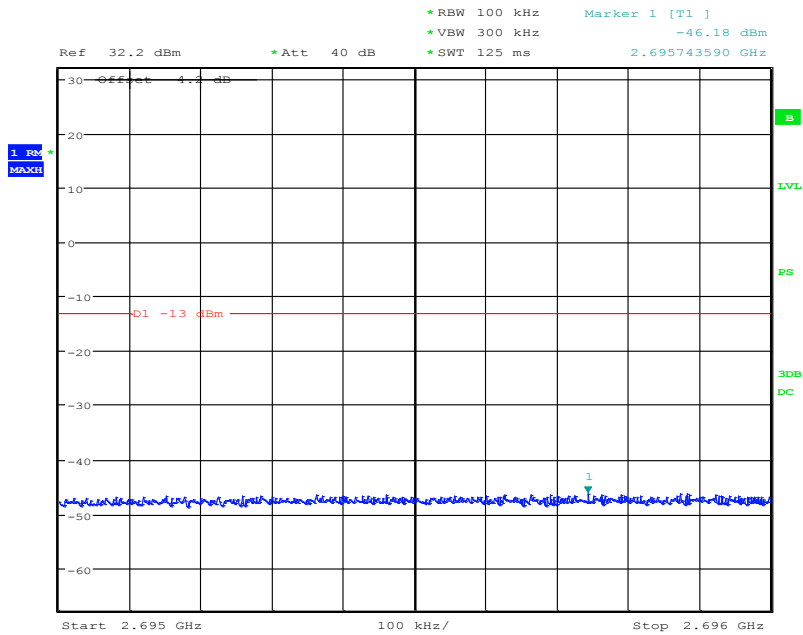

Date: 3.JUL.2015 19:15:47

5MHz bandwidth, QPSK,(25,0) Mode, Above 2690MHz

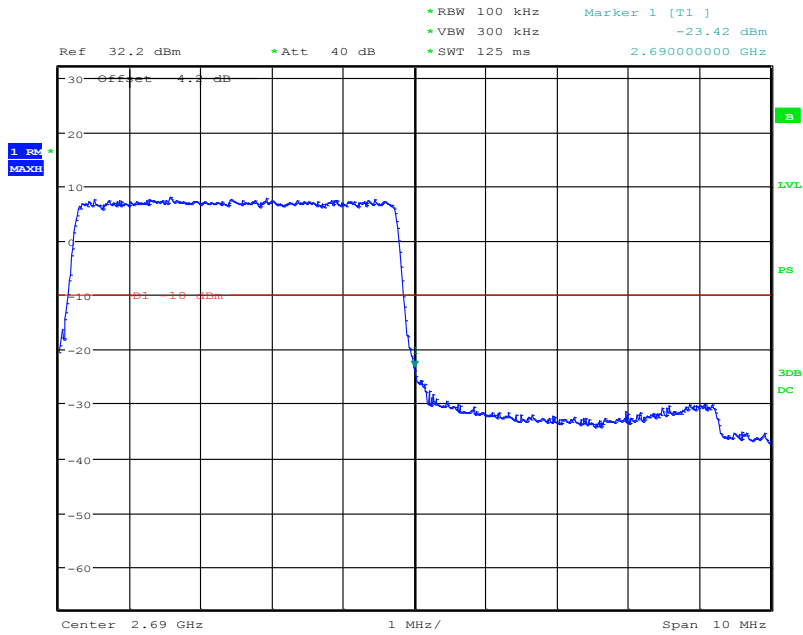

Date: 3.JUL.2015 19:13:48

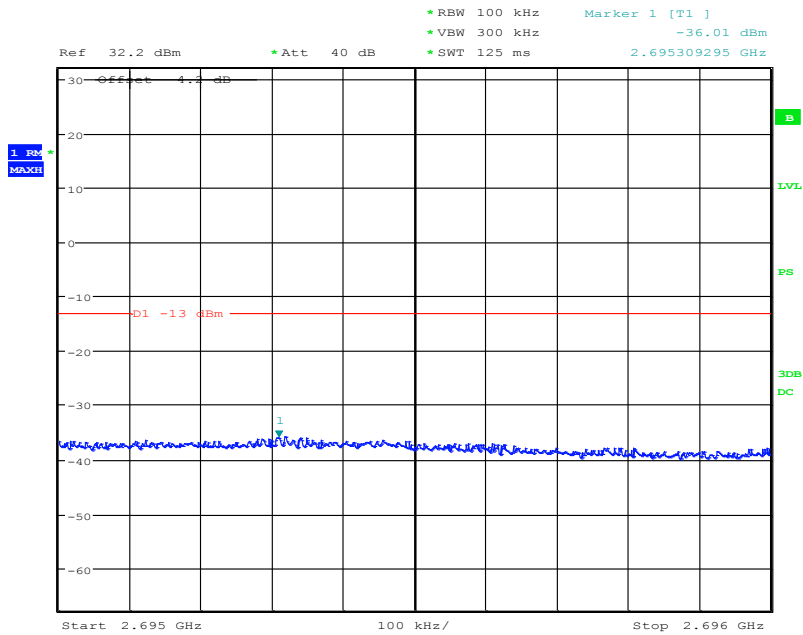

Date: 3.JUL.2015 19:15:19

5MHz bandwidth, 16QAM,(1,0) Mode , below 2496MHz

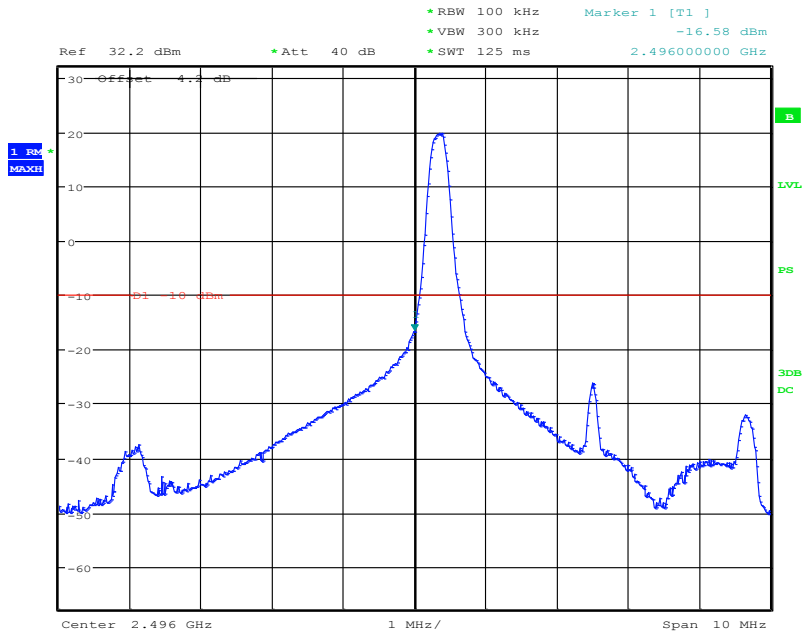

Date: 3.JUL.2015 19:08:26

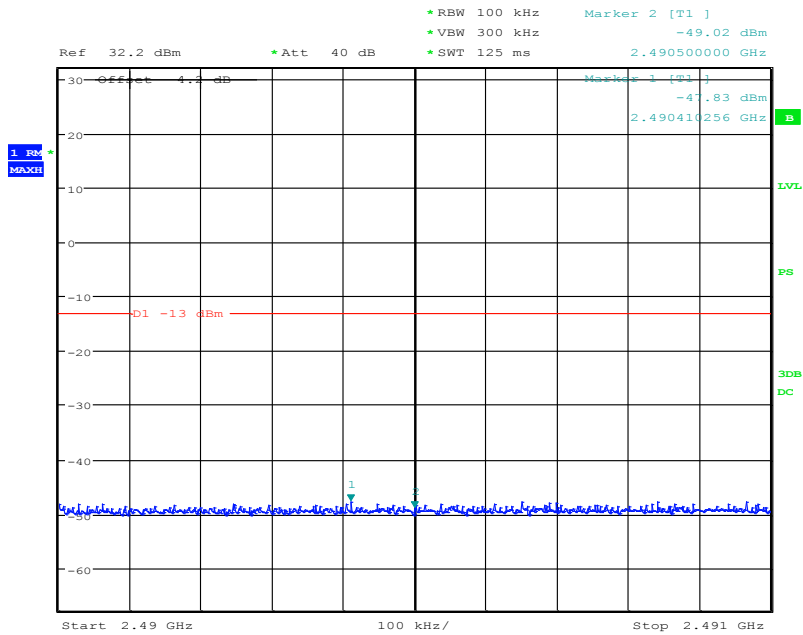

Date: 3.JUL.2015 19:09:26

5MHz bandwidth, 16QAM,(25,0) Mode , below 2496MHz

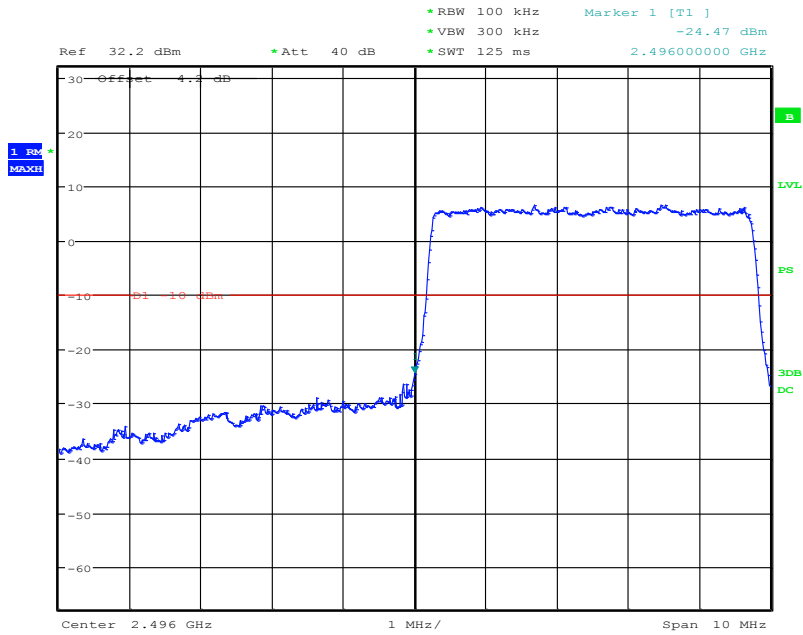

Date: 3.JUL.2015 19:08:00

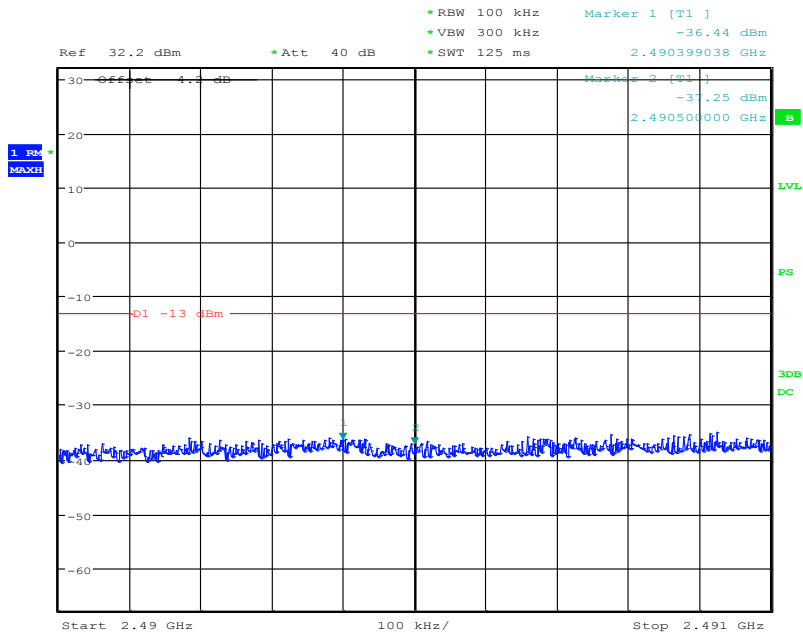

Date: 3.JUL.2015 19:09:45

5MHz bandwidth, 16QAM,(1,25) Mode, Above 2690MHz

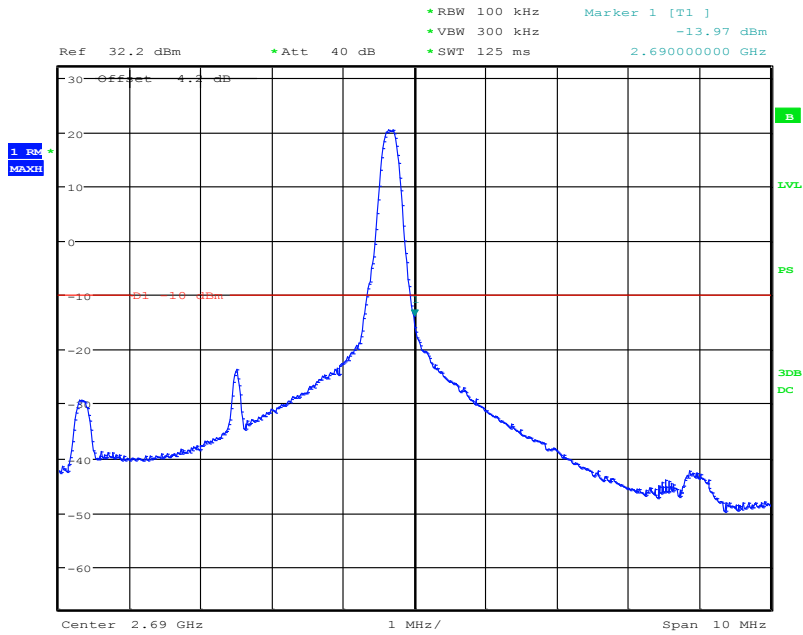

Date: 3.JUL.2015 19:14:21

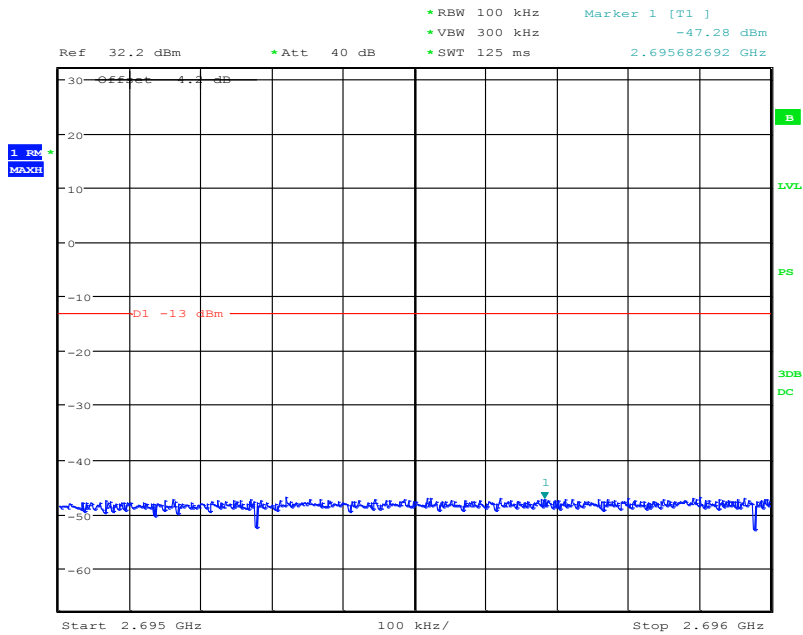

Date: 3.JUL.2015 19:14:53

5MHz bandwidth, 16QAM,(25,0) Mode, Above 2690MHz

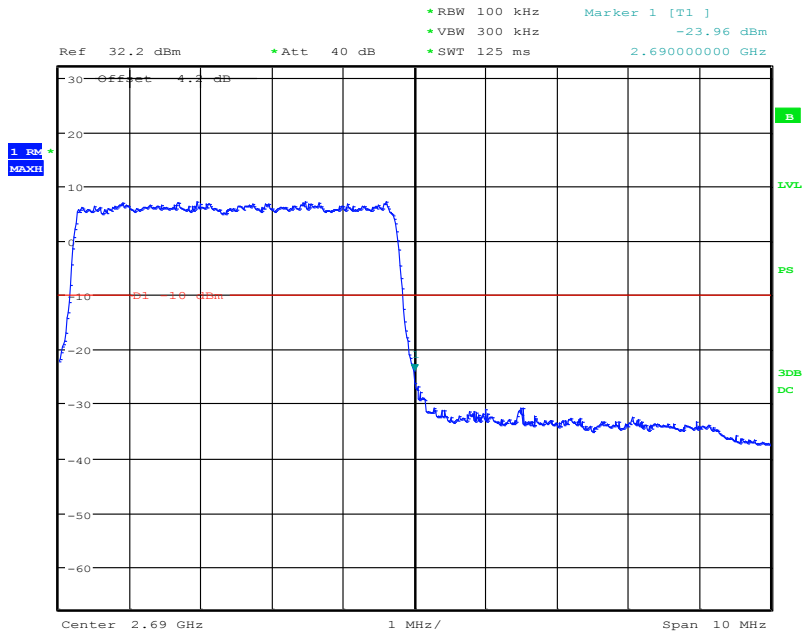

Date: 3.JUL.2015 19:13:59

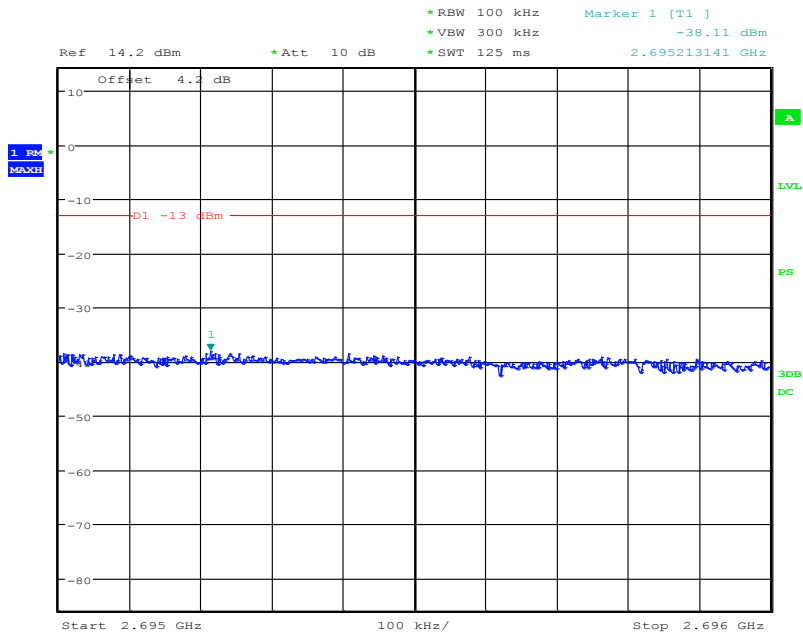

Date: 3.JUL.2015 19:57:36

10MHz bandwidth, QPSK, (1,0) Mode, below 2496MHz

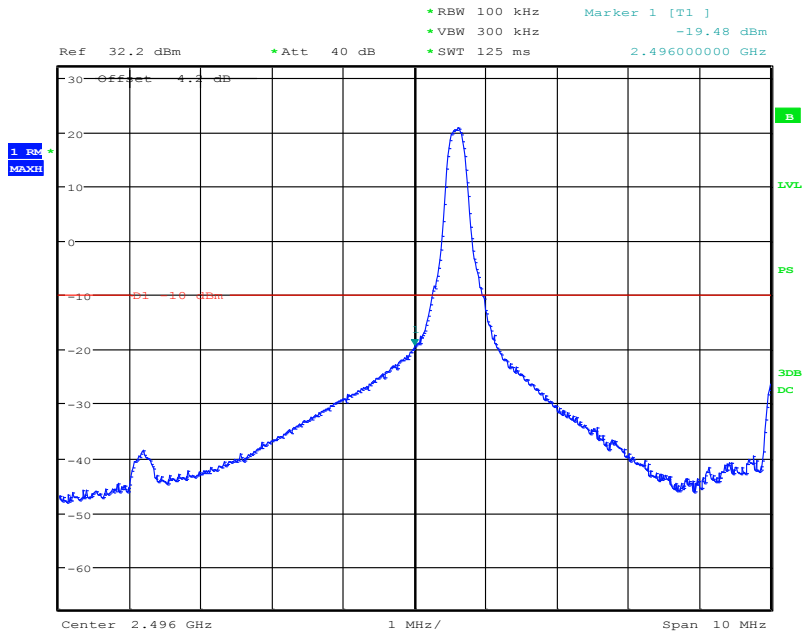

Date: 3.JUL.2015 19:18:45

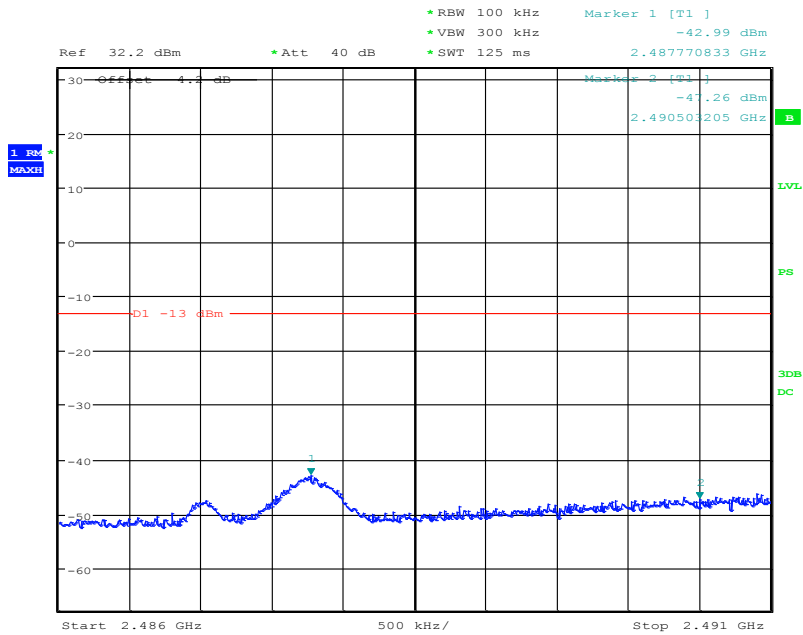

Date: 3.JUL.2015 19:19:51

10MHz bandwidth, QPSK, (50,0) Mode , below 2496MHz

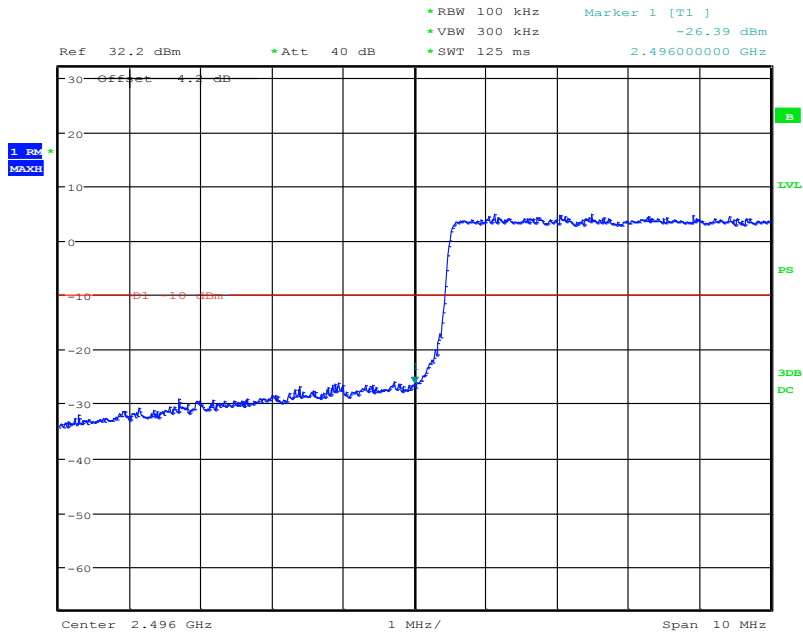

Date: 3.JUL.2015 19:18:15

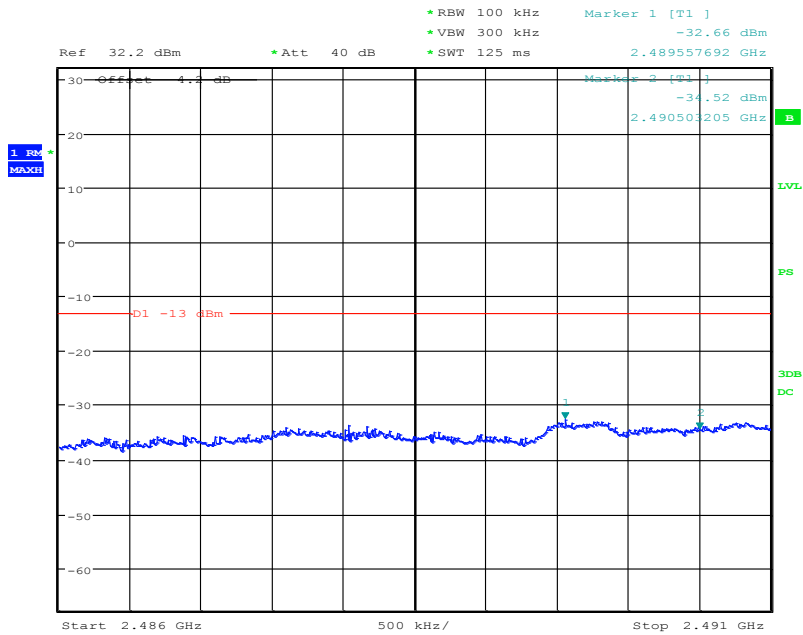

Date: 3.JUL.2015 19:20:03

10MHz bandwidth, QPSK,(1,50) Mode, Above 2690MHz

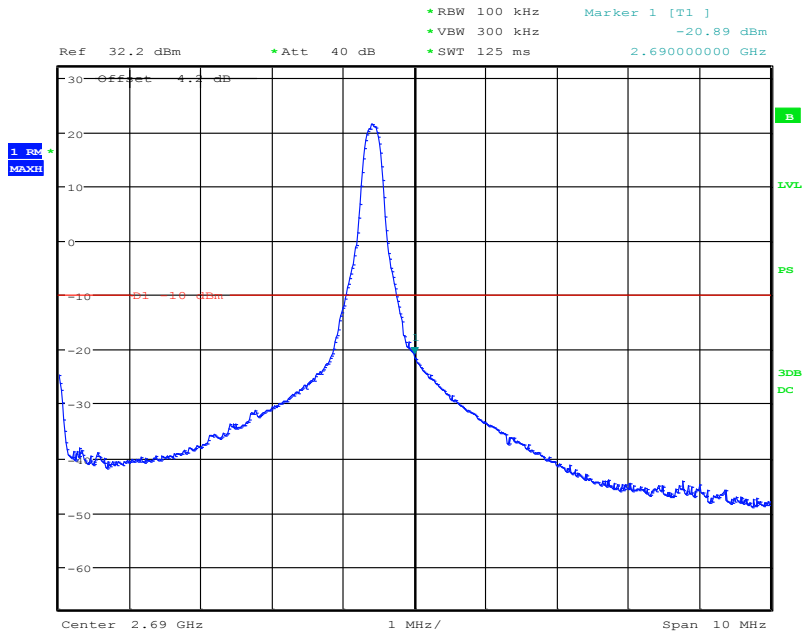

Date: 3.JUL.2015 19:21:56

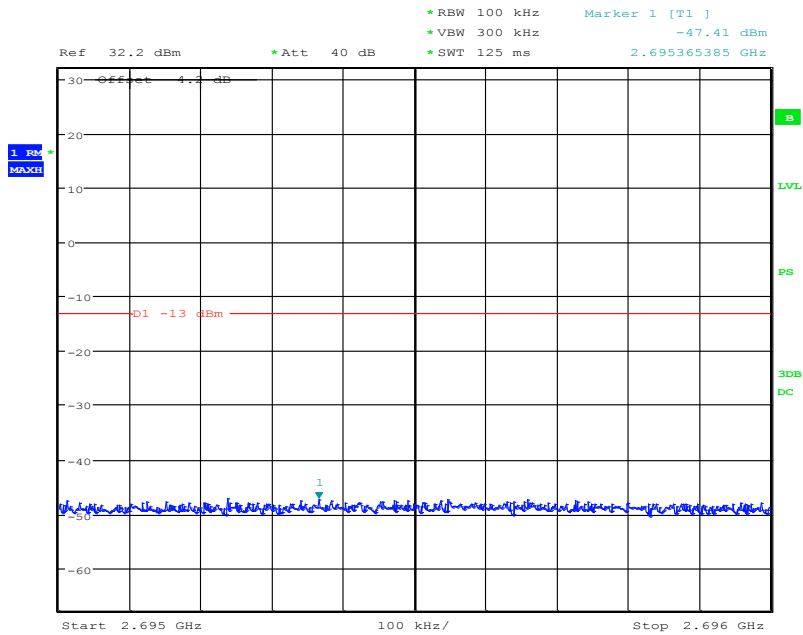

Date: 3.JUL.2015 19:24:10

10MHz bandwidth, QPSK,(50,0) Mode, Above 2690MHz

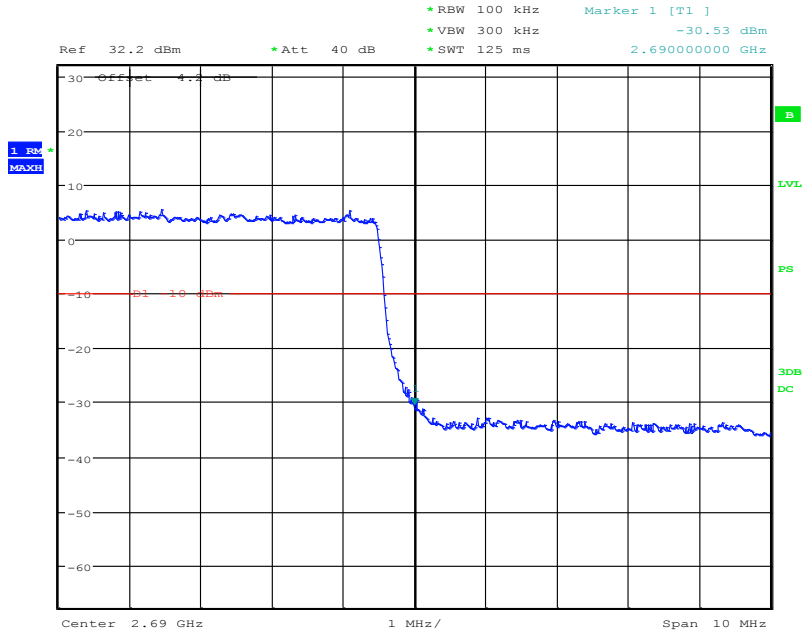

Date: 3.JUL.2015 19:22:08

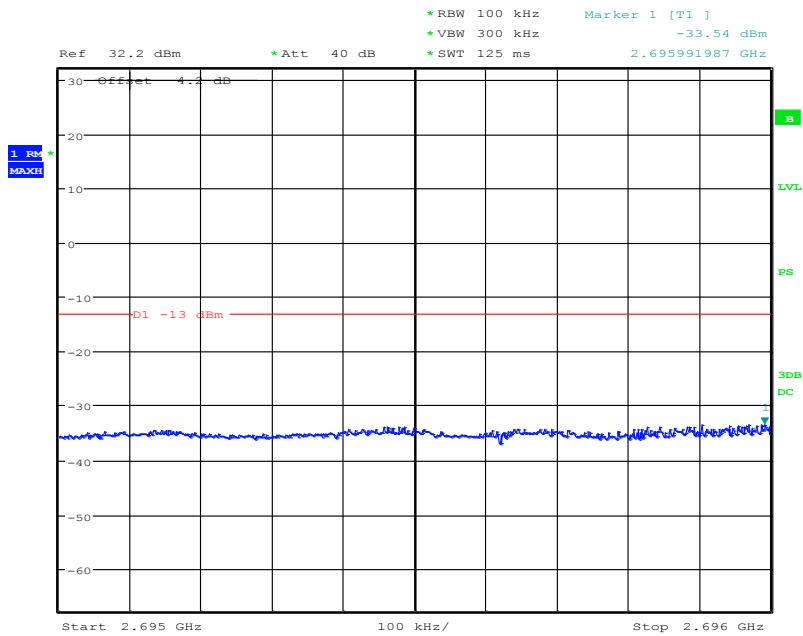

Date: 3.JUL.2015 19:23:57

10MHz bandwidth, 16QAM,(1,0) Mode , below 2496MHz

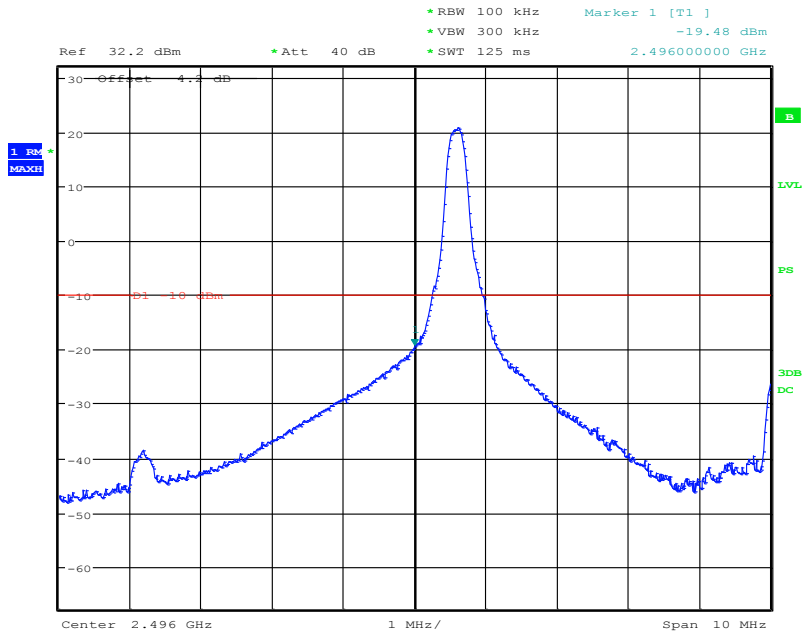

Date: 3.JUL.2015 19:18:45

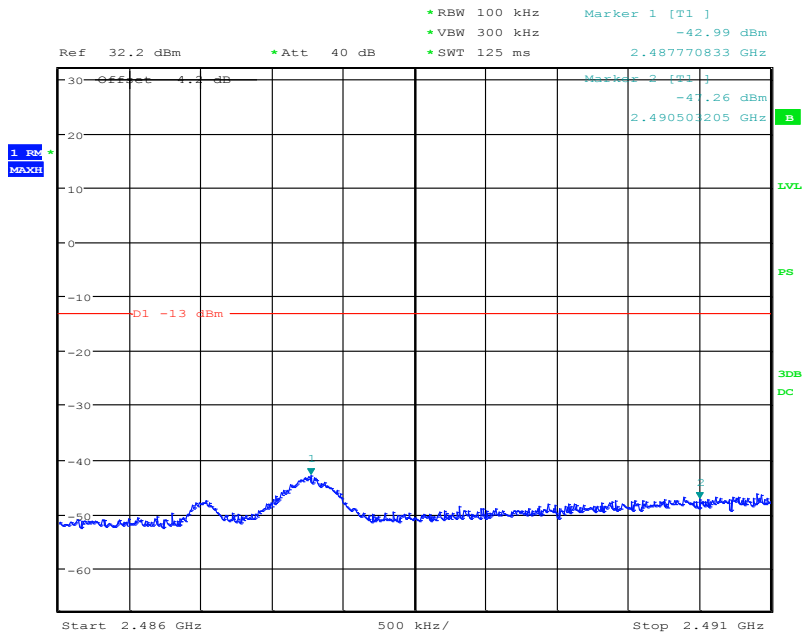

Date: 3.JUL.2015 19:19:51

10MHz bandwidth, 16QAM,(50,0) Mode , below 2496 MHz

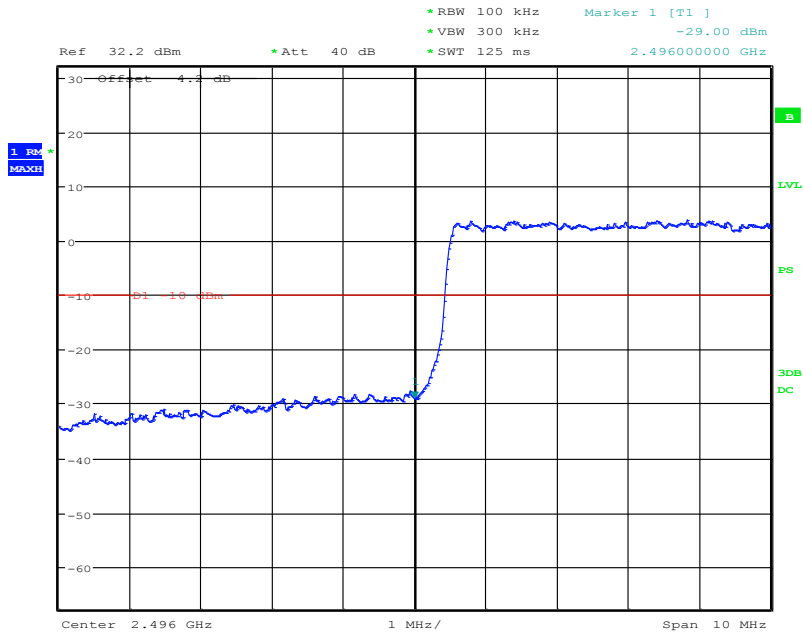

Date: 3.JUL.2015 19:18:03

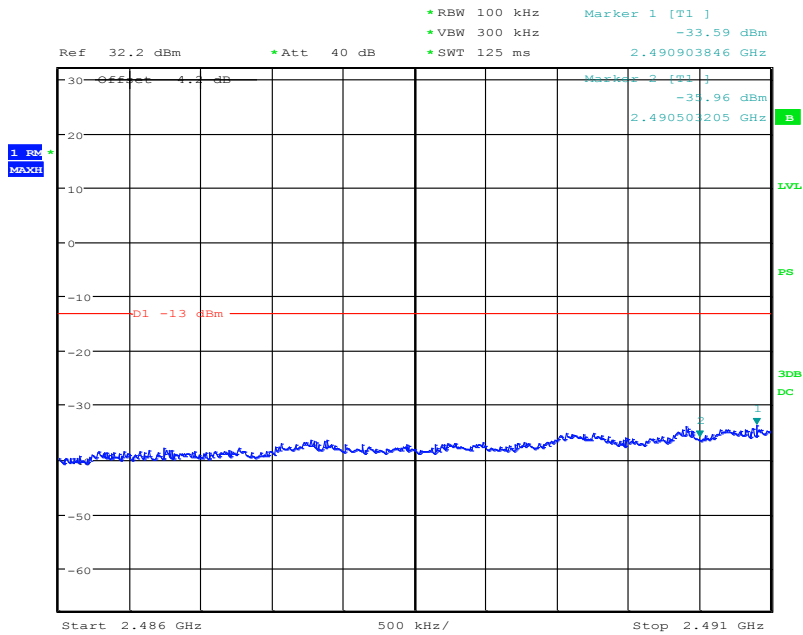

Date: 3.JUL.2015 19:20:19

10MHz bandwidth, 16QAM,(1,50) Mode, Above 2690MHz

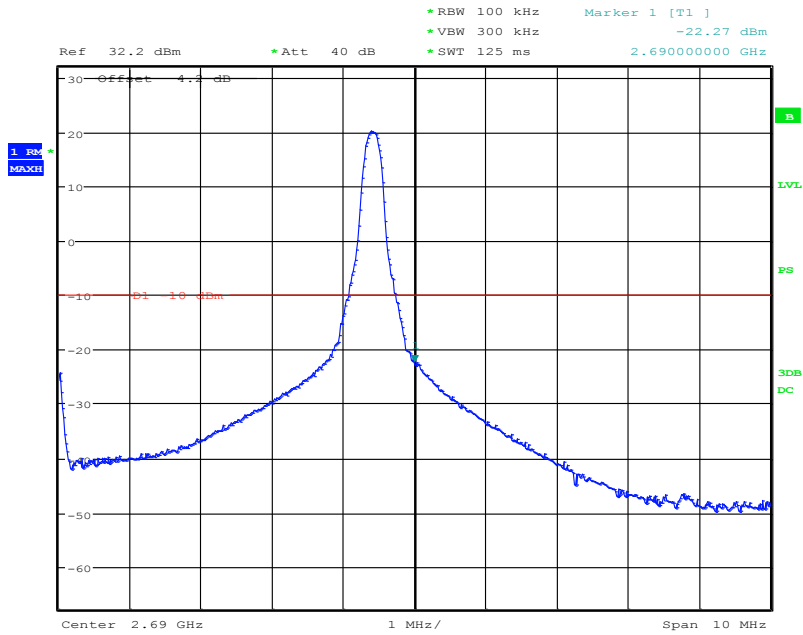

Date: 3.JUL.2015 19:22:58

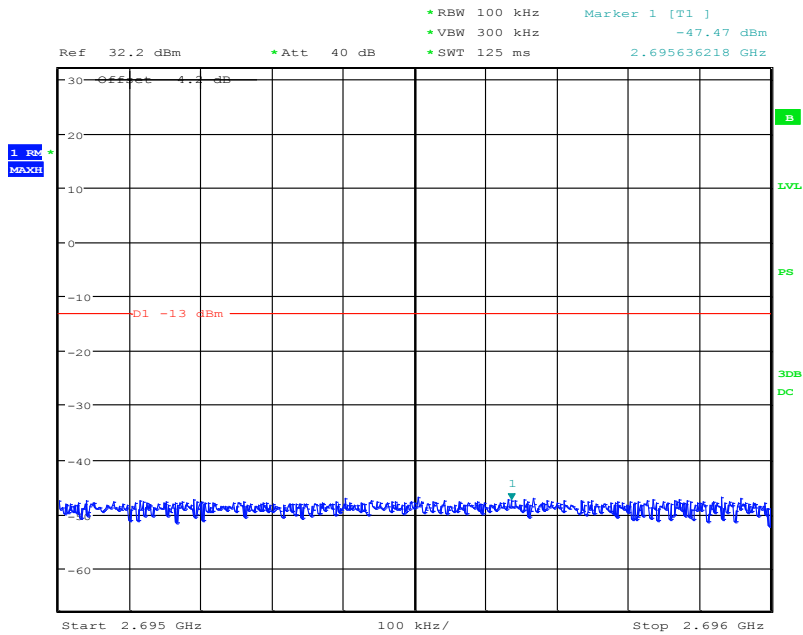

Date: 3.JUL.2015 19:23:26

10MHz bandwidth, 16QAM,(50,0) Mode, Above 2690MHz

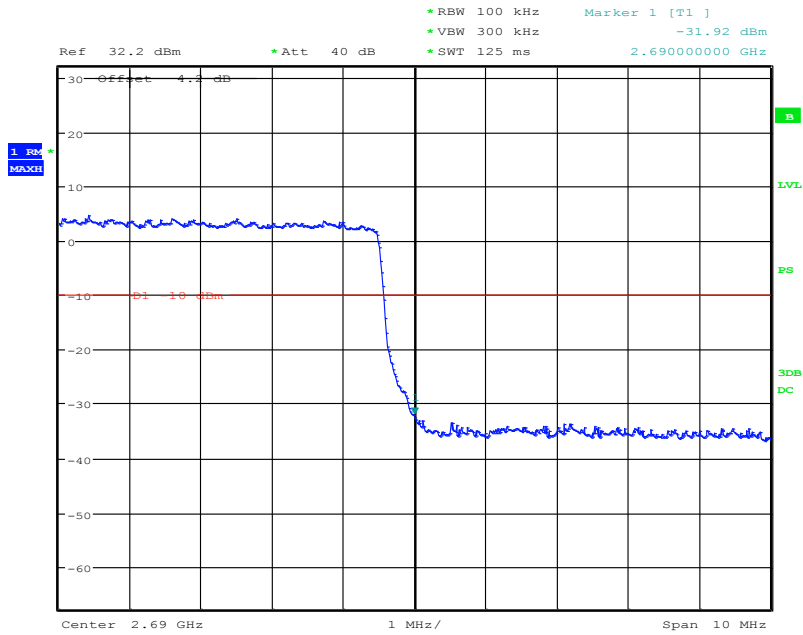

Date: 3.JUL.2015 19:22:35

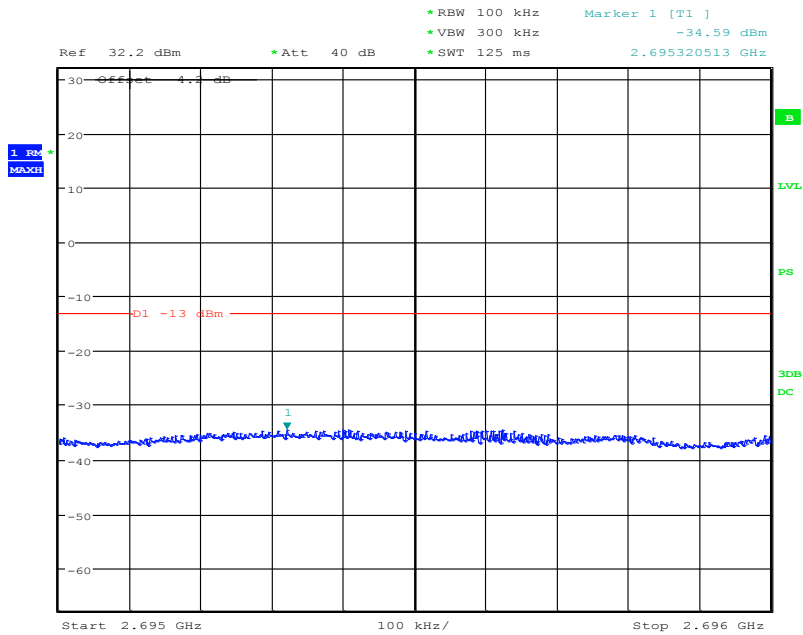

Date: 3.JUL.2015 19:23:39

15MHz bandwidth, QPSK, (1,0) Mode, below 2496MHz

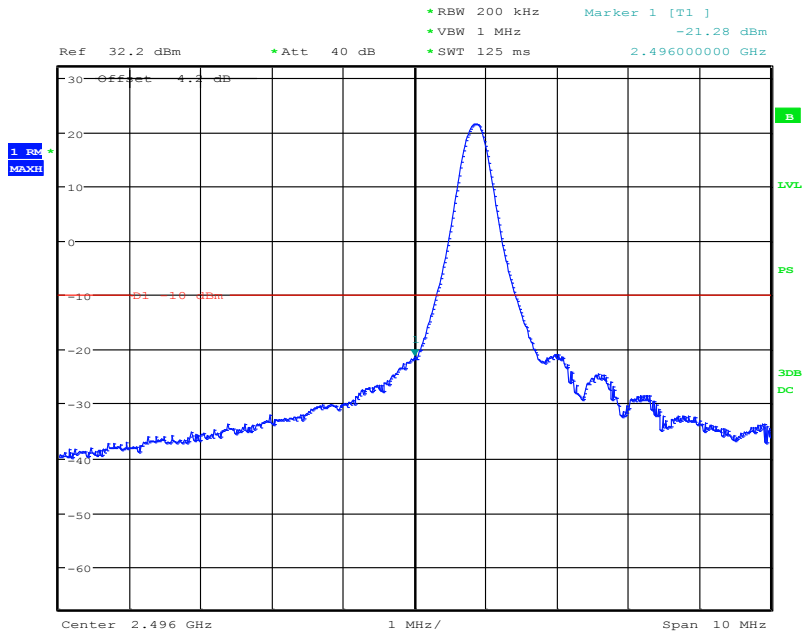

Date: 3.JUL.2015 19:25:42

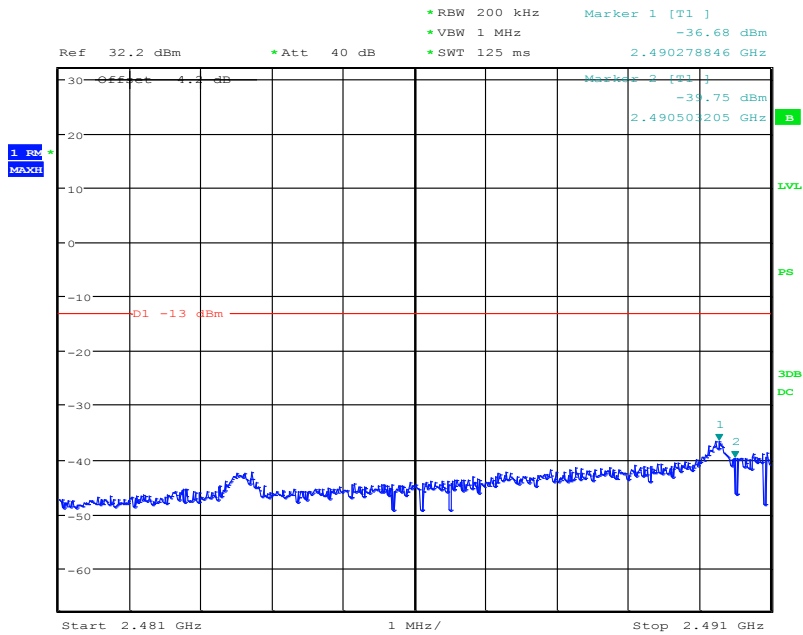

Date: 3.JUL.2015 19:28:07

15MHz bandwidth, QPSK, (75,0) Mode , below 2496MHz

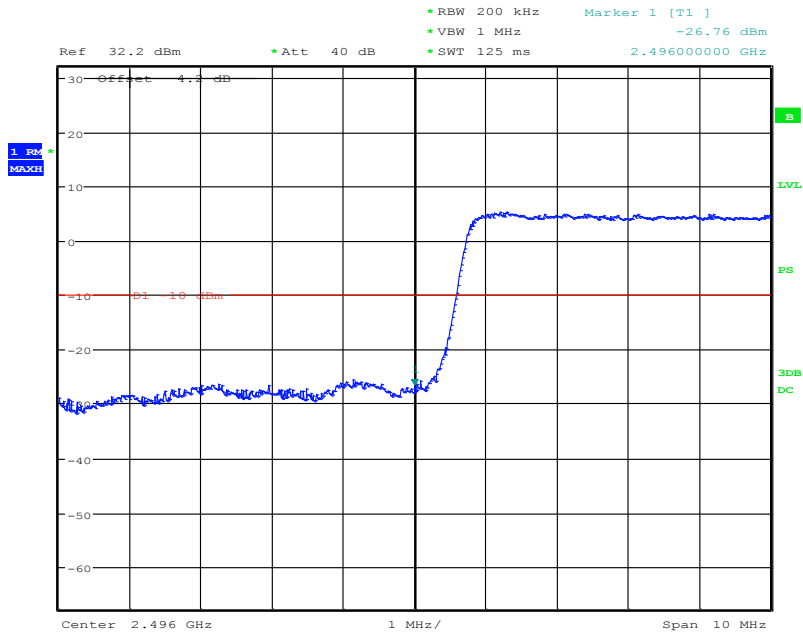

Date: 3.JUL.2015 19:25:54

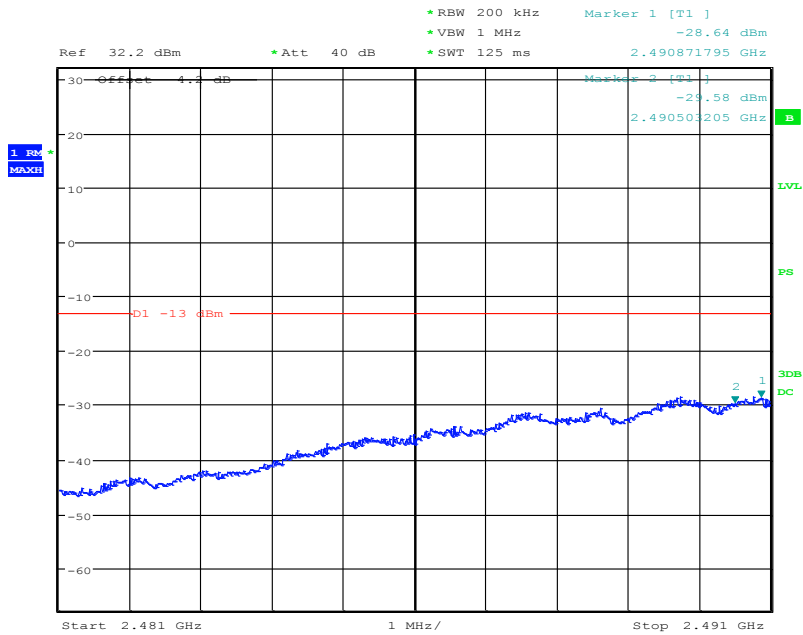

Date: 3.JUL.2015 19:27:40

15MHz bandwidth, QPSK,(1,75) Mode, Above 2690MHz

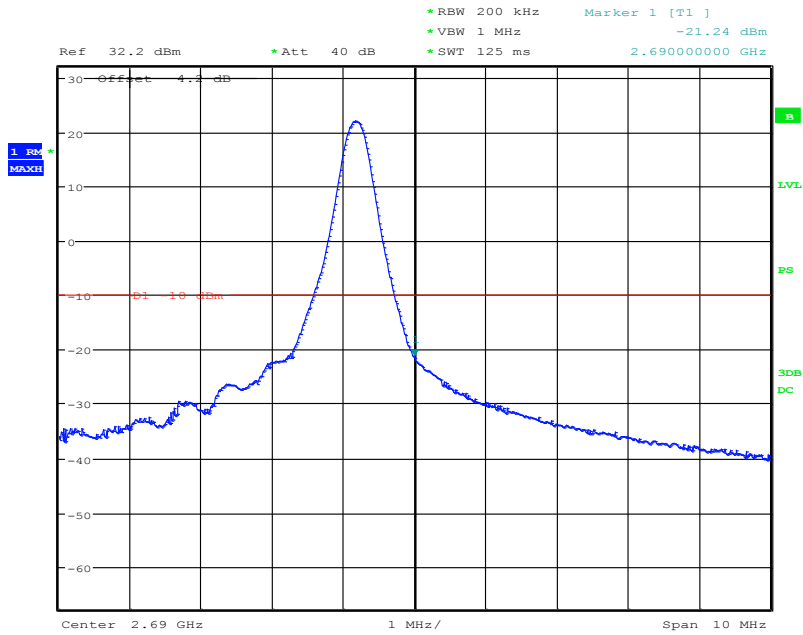

Date: 3.JUL.2015 19:29:24

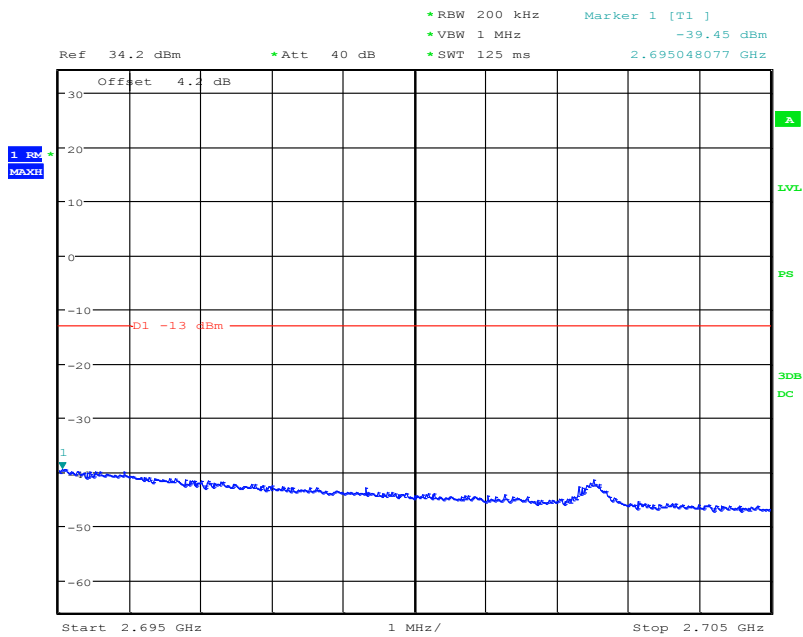

Date: 3.JUL.2015 19:35:15

15MHz bandwidth, QPSK,(75,0) Mode, Above 2690MHz

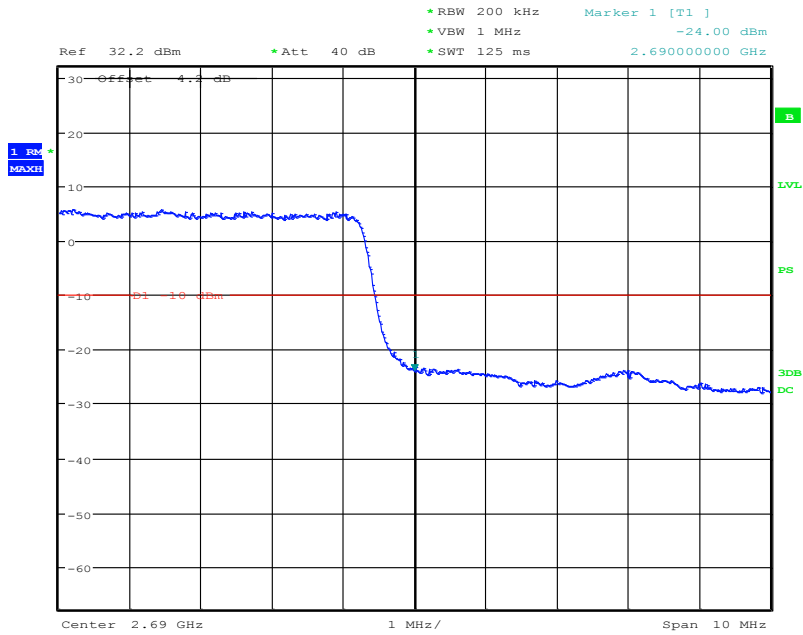

Date: 3.JUL.2015 19:29:39

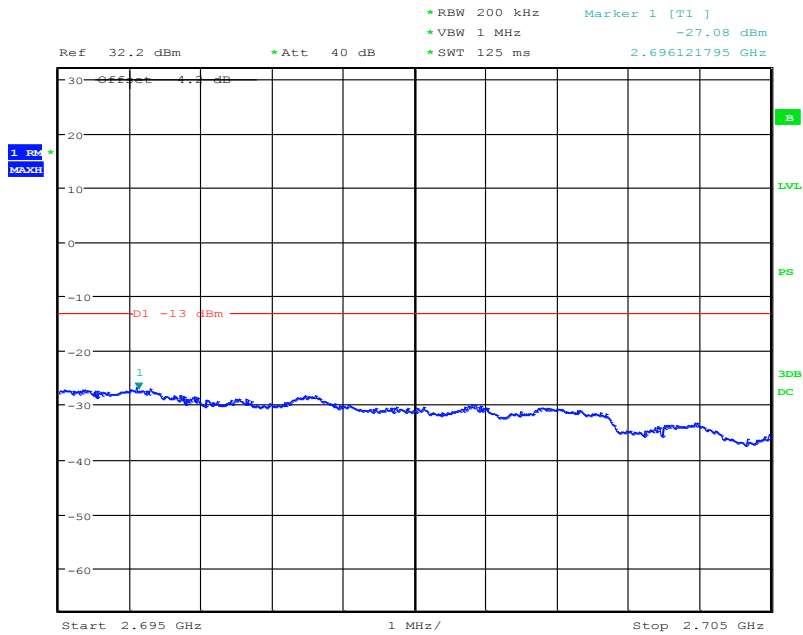

Date: 3.JUL.2015 19:31:46

15MHz bandwidth, 16QAM,(1,0) Mode , below 2496MHz

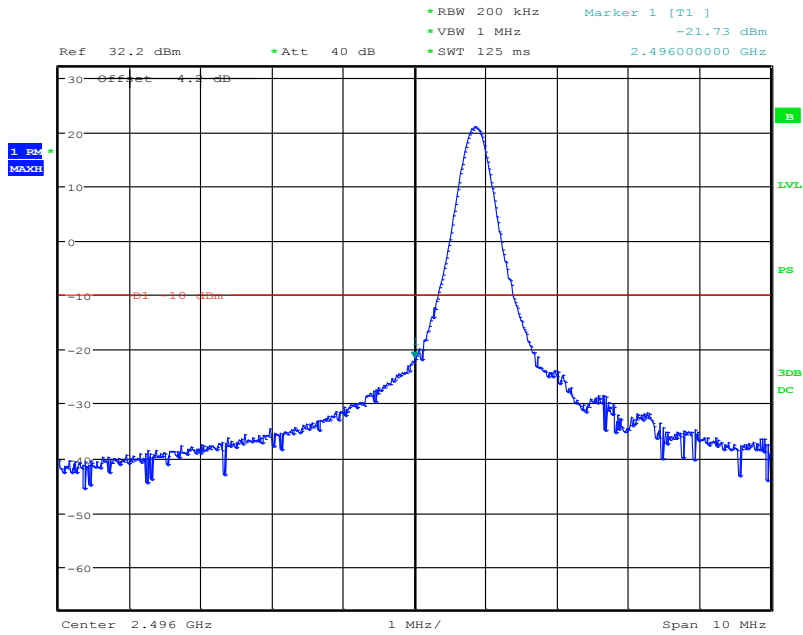

Date: 3.JUL.2015 19:26:34

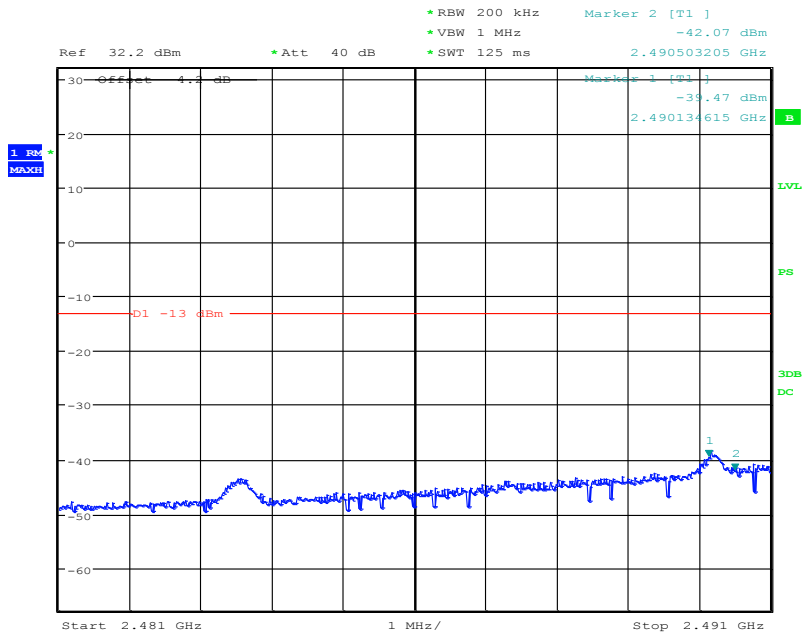

Date: 3.JUL.2015 19:27:14

15MHz bandwidth, 16QAM,(75,0) Mode , below 2496MHz

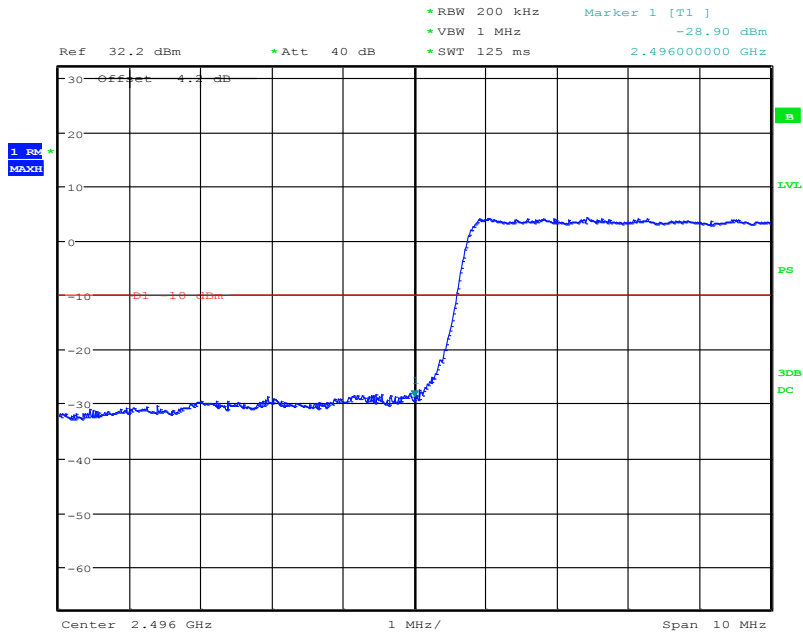

Date: 3.JUL.2015 19:26:10

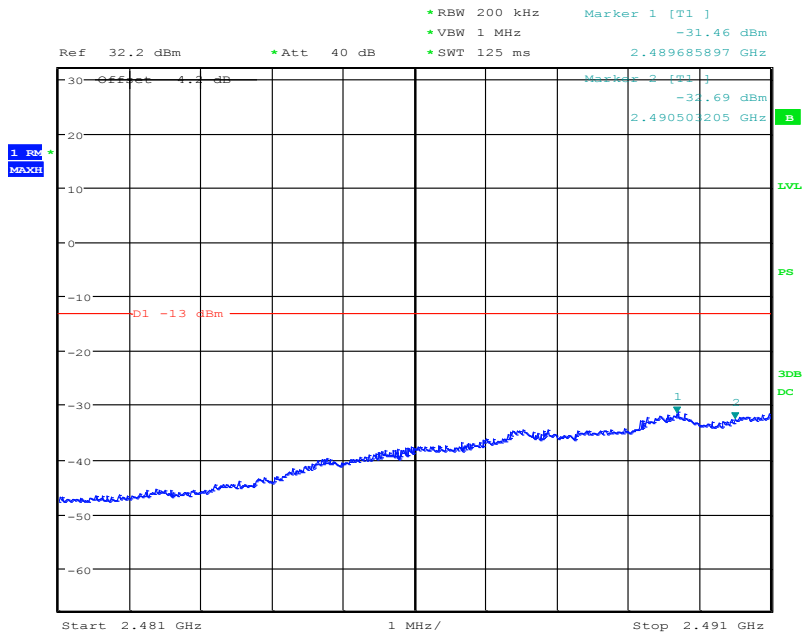

Date: 3.JUL.2015 19:27:26

15MHz bandwidth, 16QAM,(1,75) Mode, Above 2690MHz

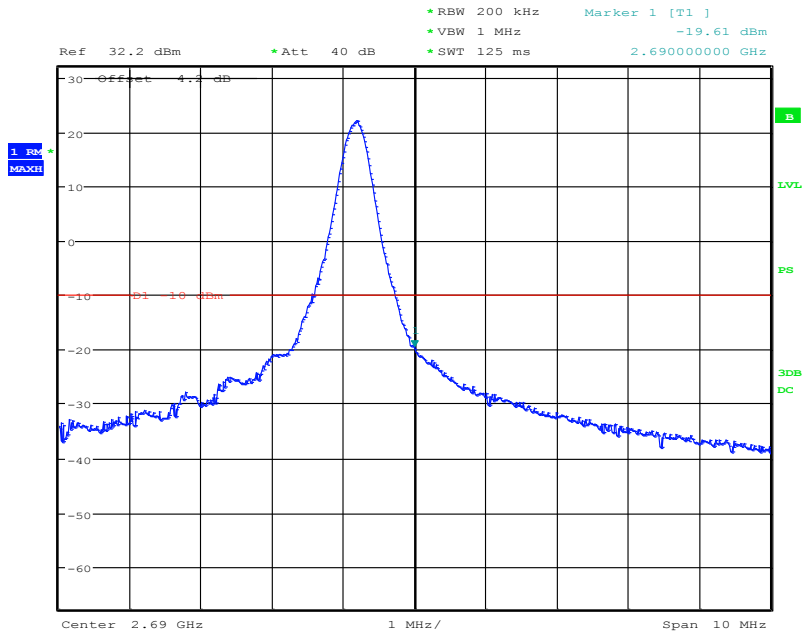

Date: 3.JUL.2015 19:30:16

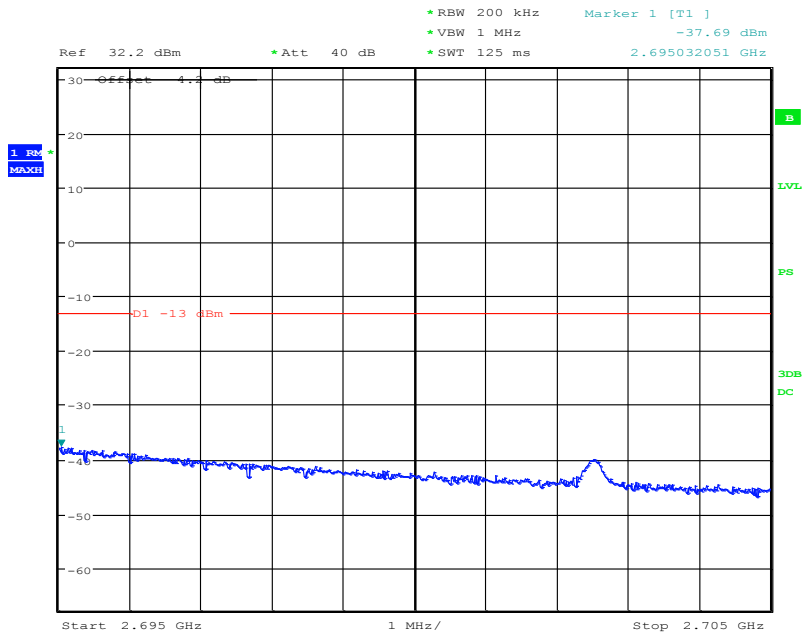

Date: 3.JUL.2015 19:31:18

15MHz bandwidth, 16QAM,(75,0) Mode, Above 2690MHz

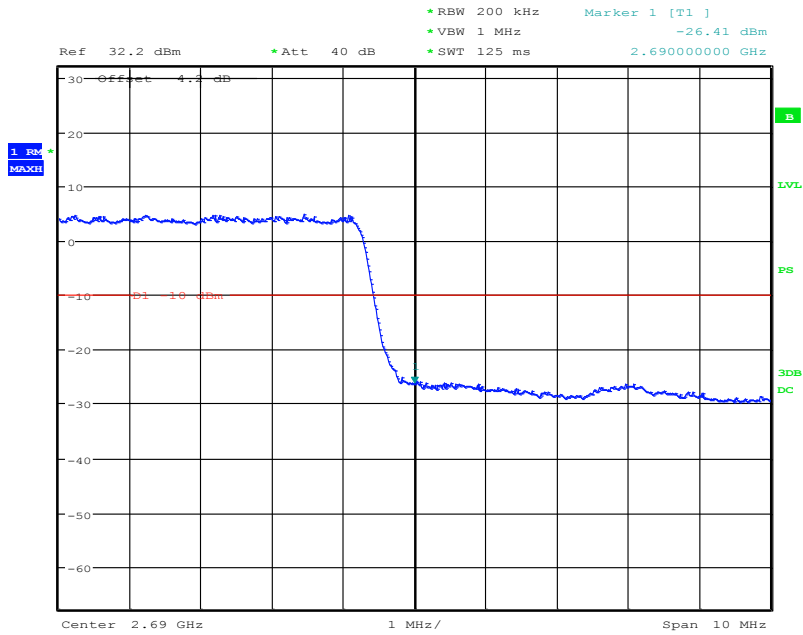

Date: 3.JUL.2015 19:29:52

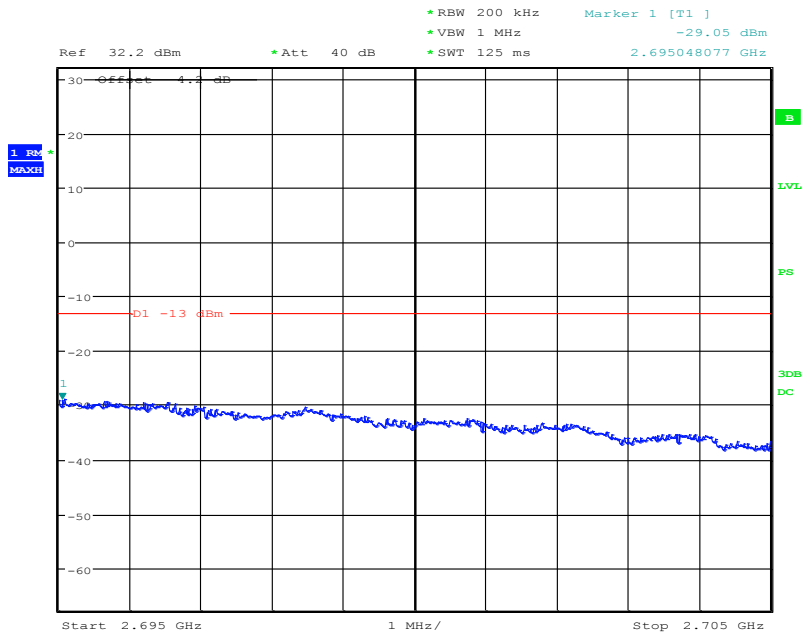

Date: 3.JUL.2015 19:31:30

20MHz bandwidth, QPSK, (1,0) Mode, below 2496MHz

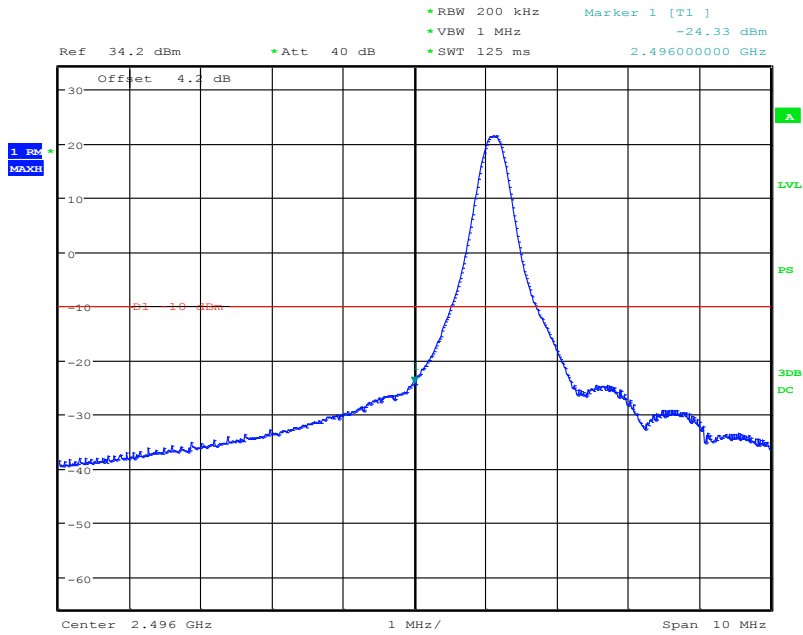

Date: 3.JUL.2015 19:36:37

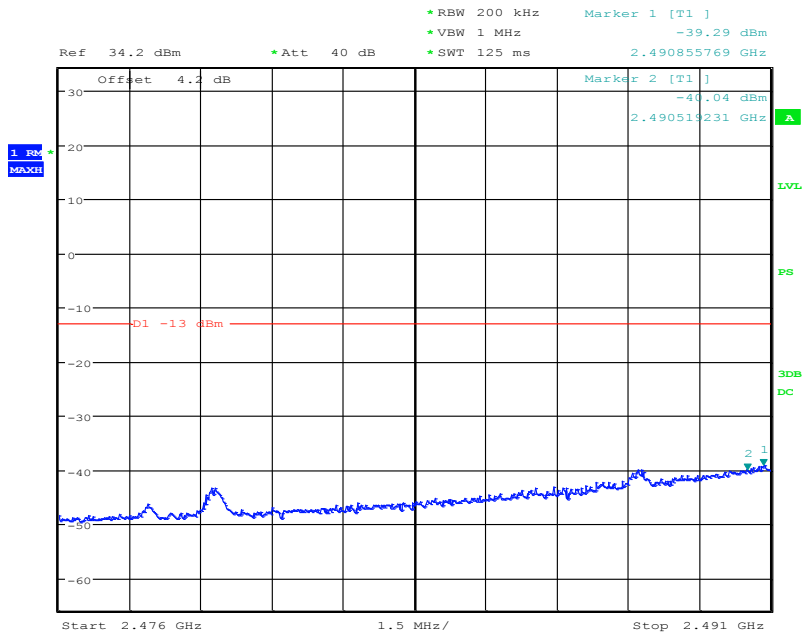

Date: 3.JUL.2015 19:39:34

20MHz bandwidth, QPSK, (100,0) Mode , below 2496MHz

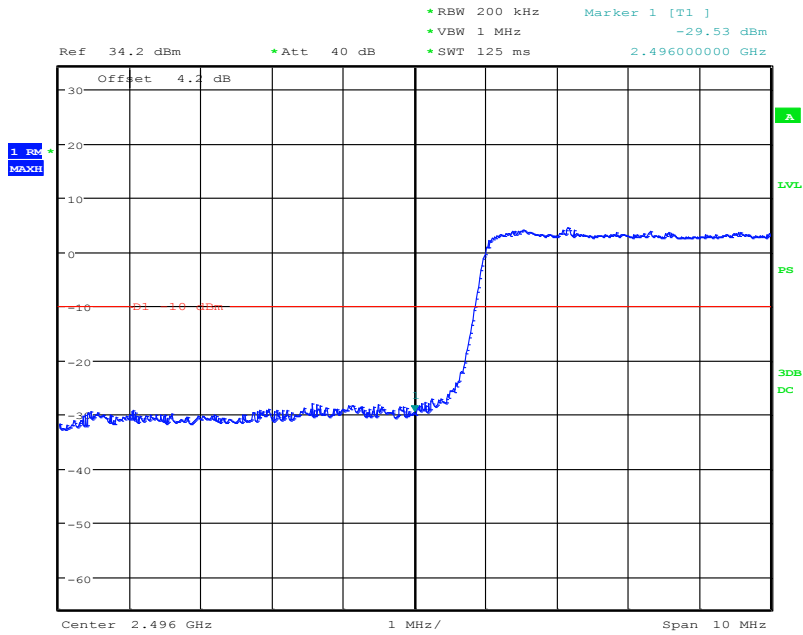

Date: 3.JUL.2015 19:36:53

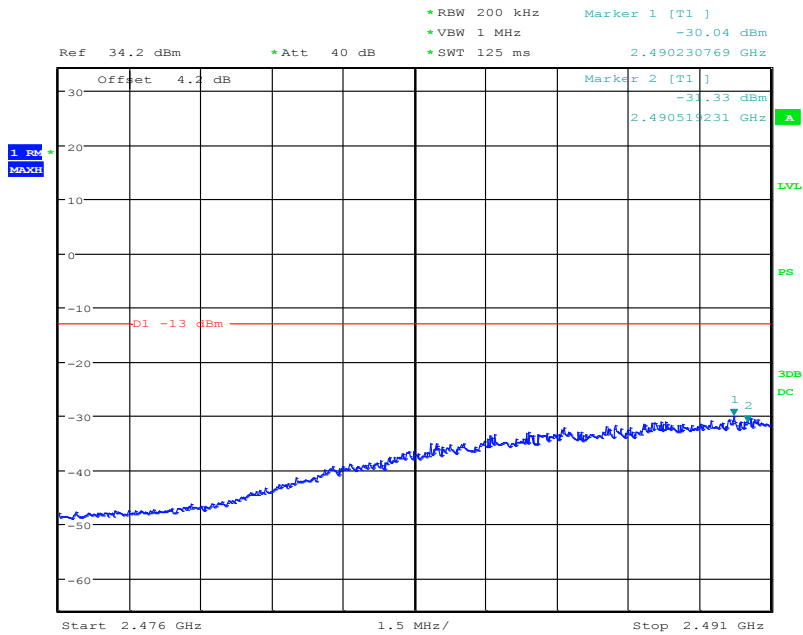

Date: 3.JUL.2015 19:39:02

20MHz bandwidth, QPSK,(1,100) Mode, Above 2690MHz

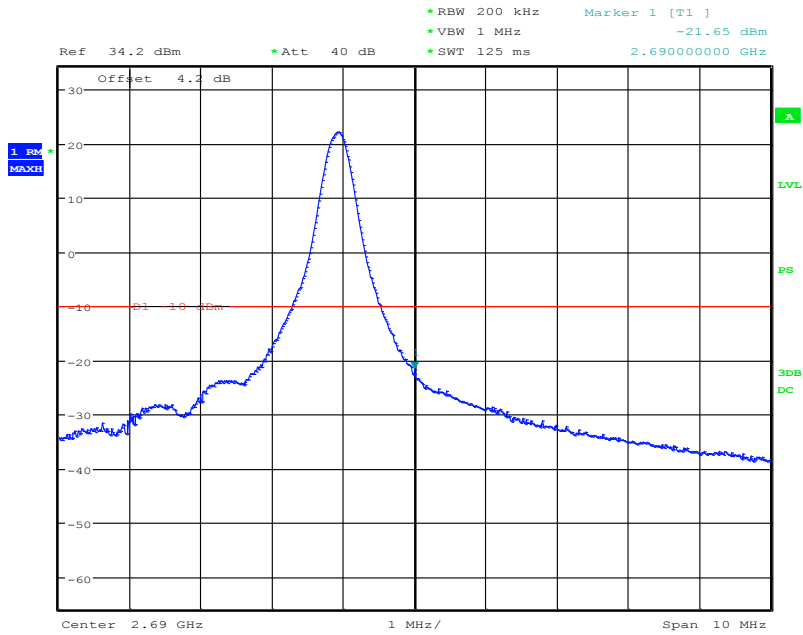

Date: 3.JUL.2015 19:41:10

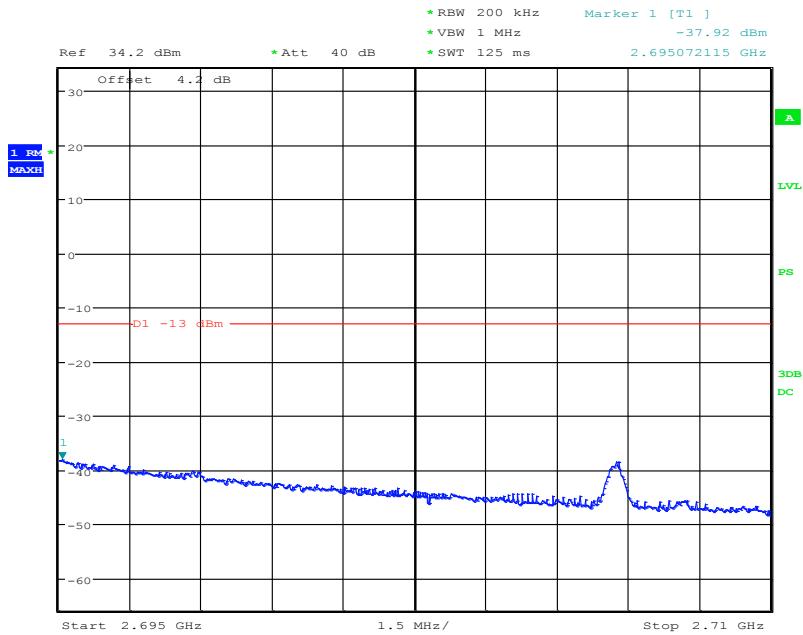

Date: 3.JUL.2015 19:43:53

20MHz bandwidth, QPSK,(100,0) Mode, Above 2690MHz

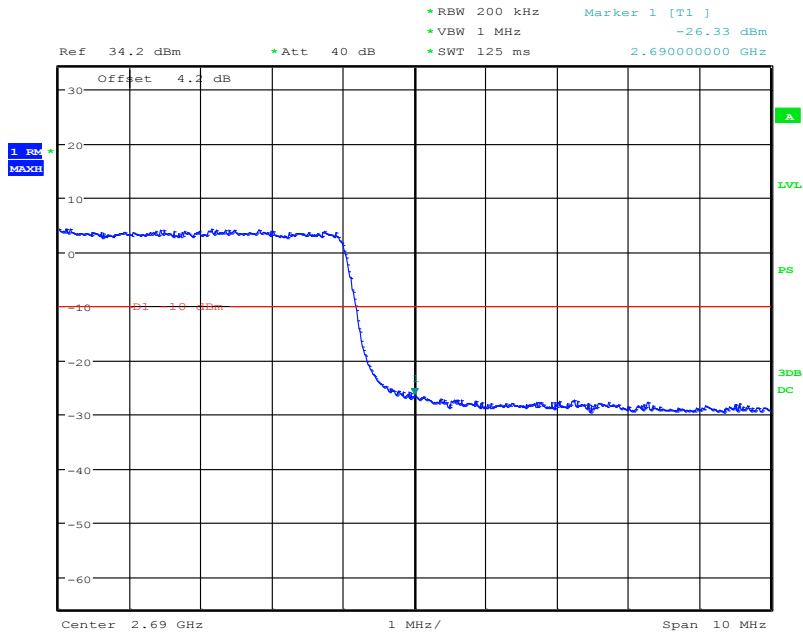

Date: 3.JUL.2015 19:41:25

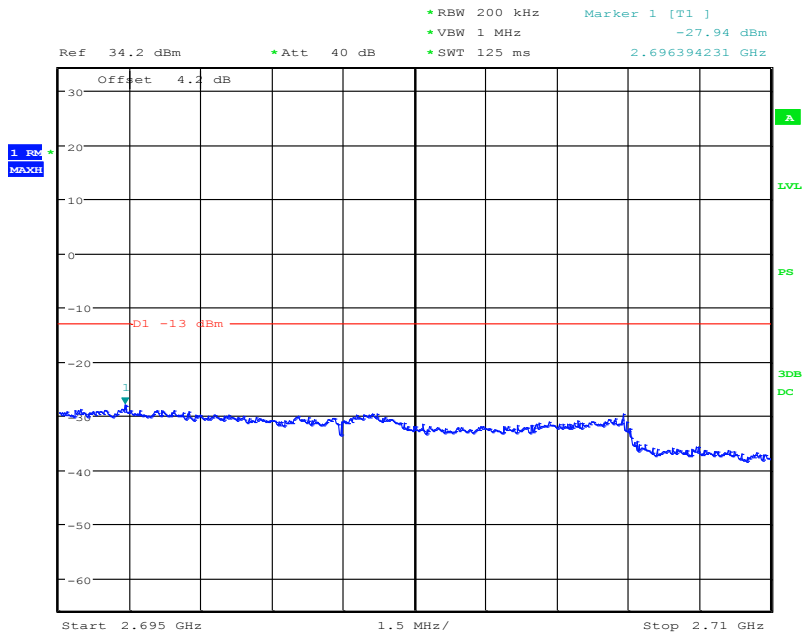

Date: 3.JUL.2015 19:43:14

20MHz bandwidth, 16QAM,(1,0) Mode , below 2496MHz

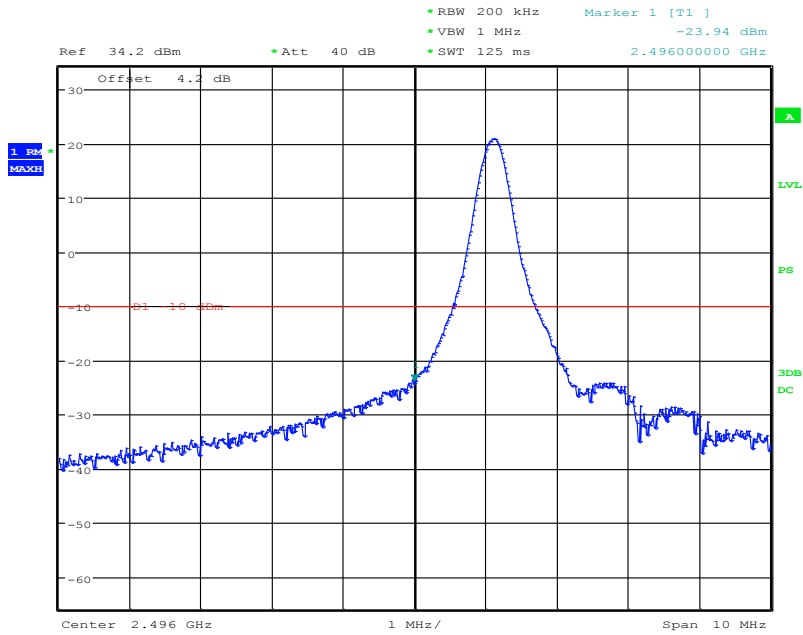

Date: 3.JUL.2015 19:37:26

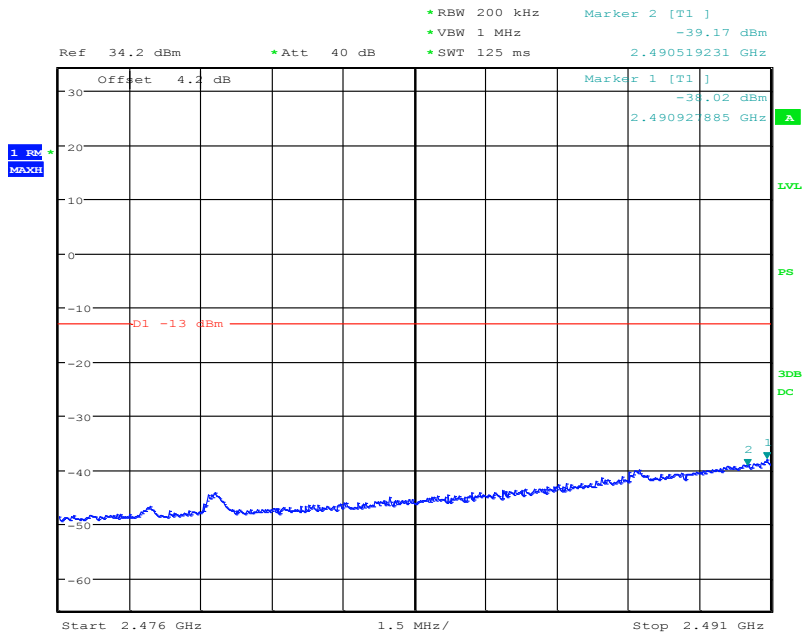

Date: 3.JUL.2015 19:38:22

20MHz bandwidth, 16QAM,(100,0) Mode , below 2496MHz

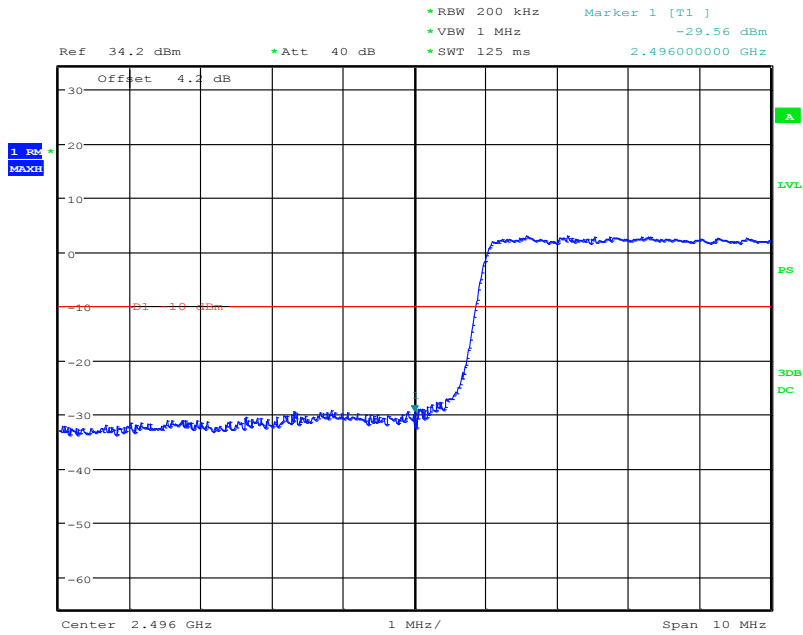

Date: 3.JUL.2015 19:37:11

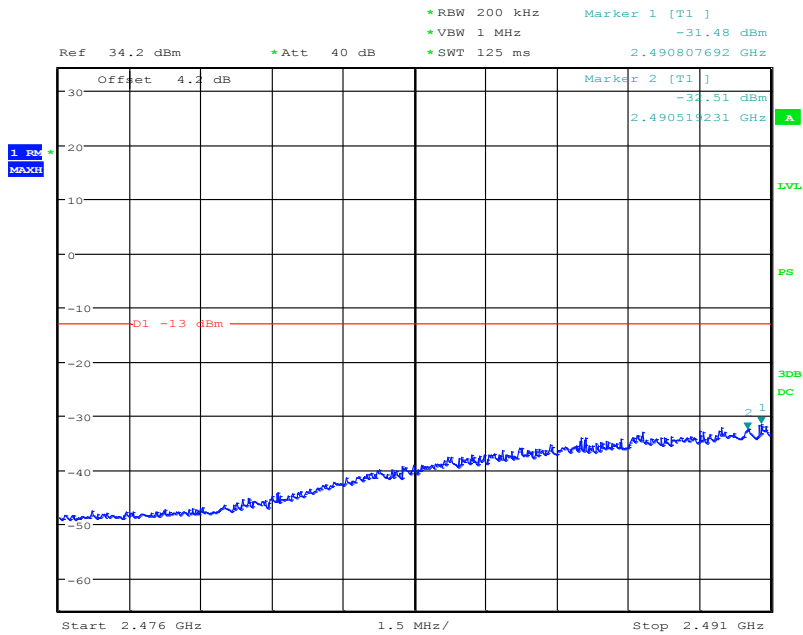

Date: 3.JUL.2015 19:38:38

20MHz bandwidth, 16QAM,(1,100) Mode, Above 2690MHz

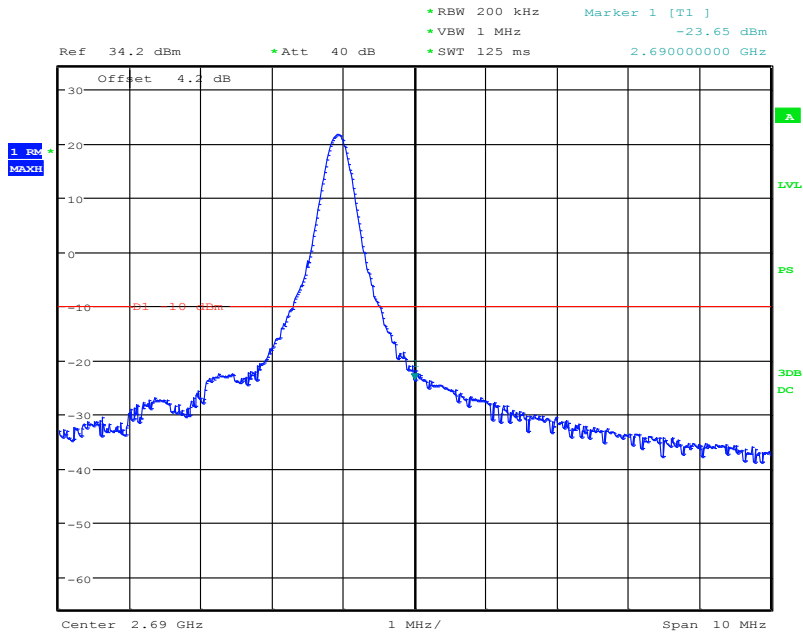

Date: 3.JUL.2015 19:41:53

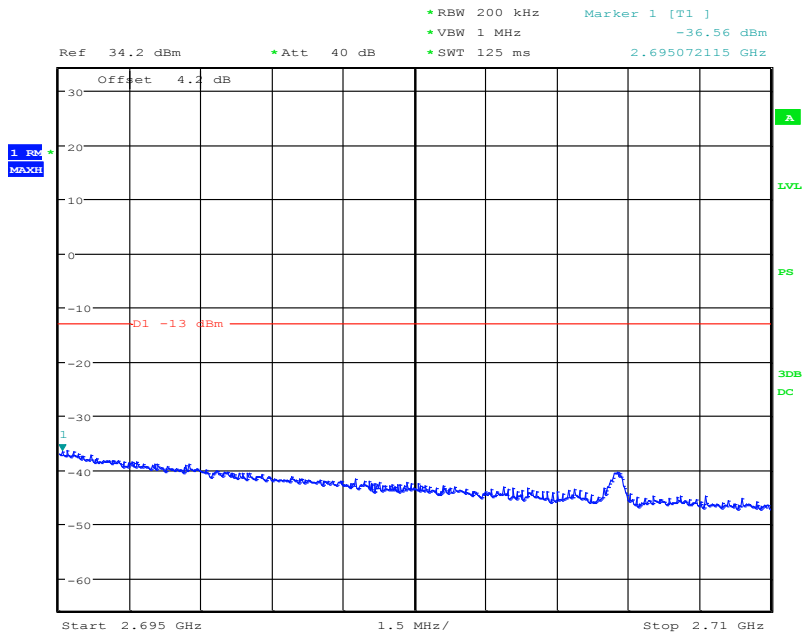

Date: 3.JUL.2015 19:42:44

20MHz bandwidth, 16QAM,(100,0) Mode, Above 2690MHz

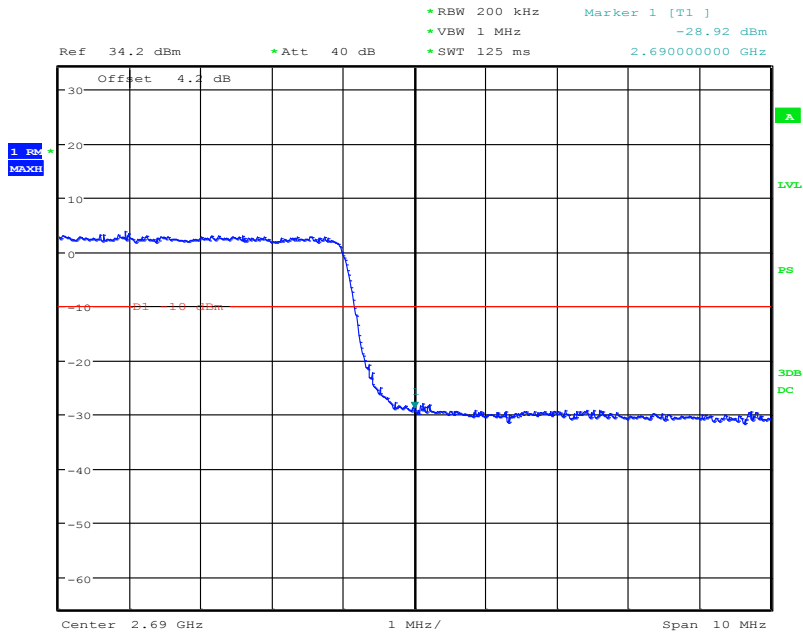

Date: 3.JUL.2015 19:41:38

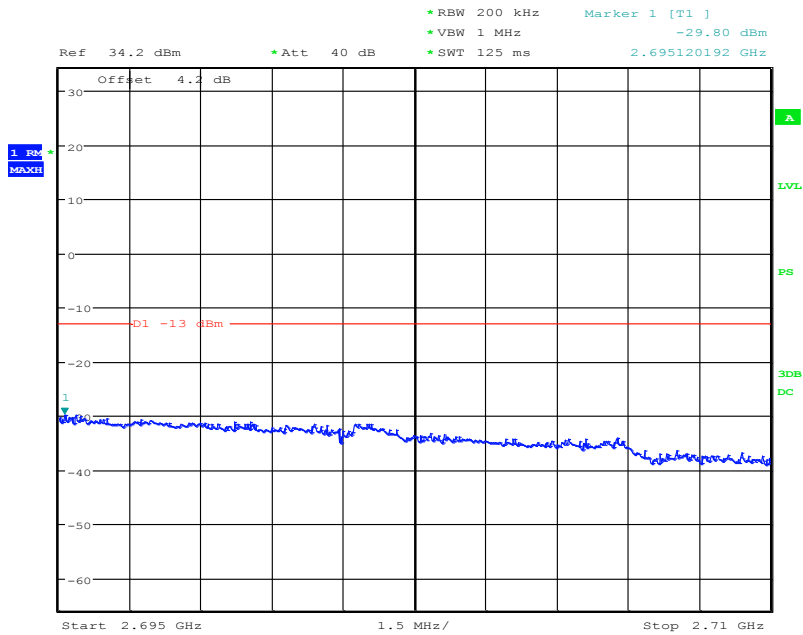

Date: 3.JUL.2015 19:42:56

4.5.9 WCDMA B2 Band Edge Results

Graphical results:

Low Channel , Below 1850MHz

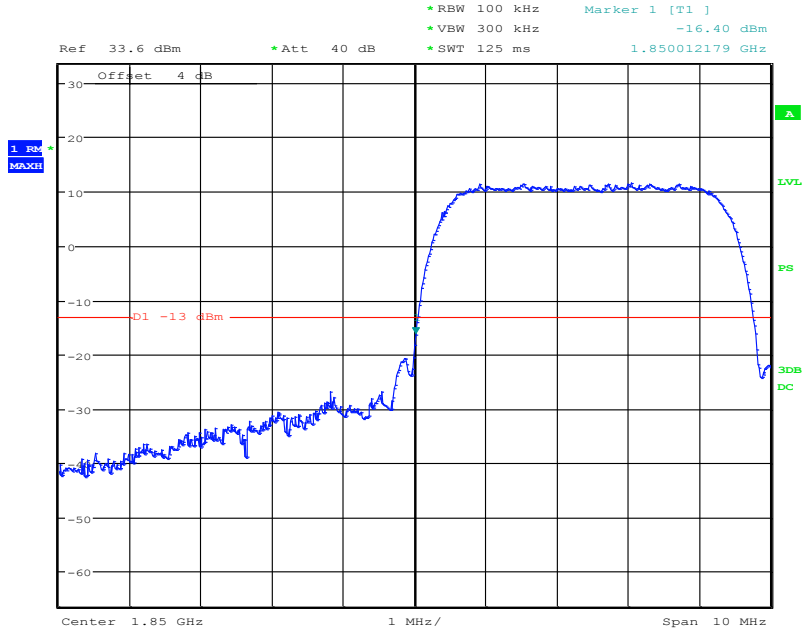

Date: 3.JUL.2015 13:18:16

High Channel , Above 1910MHz

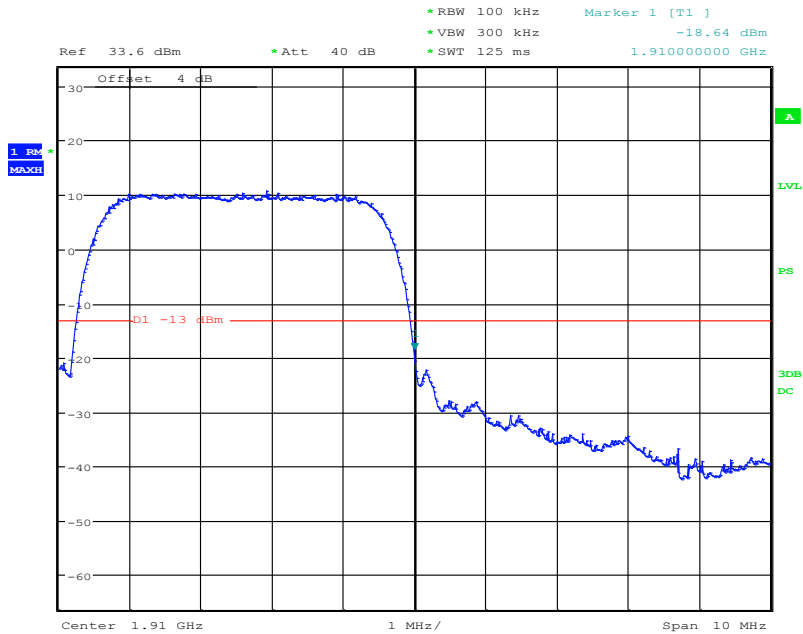

Date: 3.JUL.2015 13:19:00

4.5.10 WCDMA B4 Band Edge Results

Graphical results:

Low Channel , Below 1710MHz

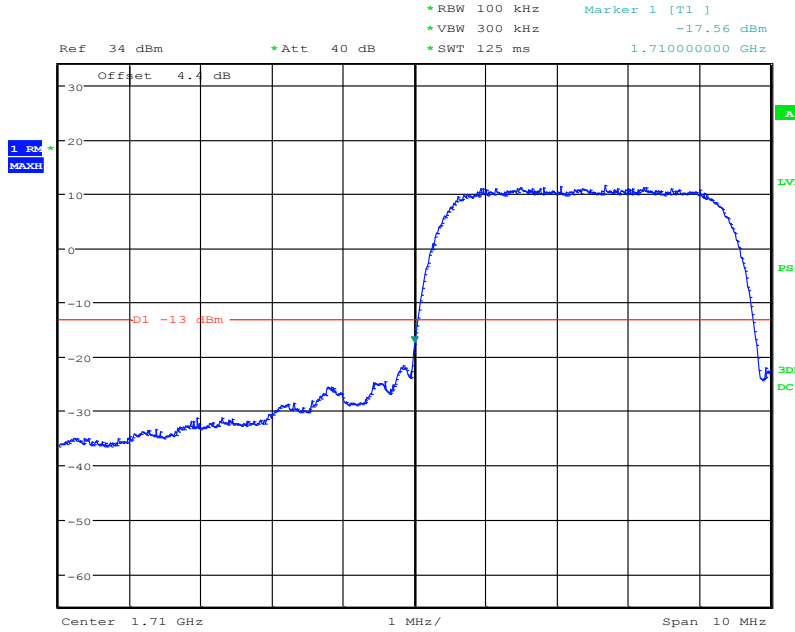

Date: 3.JUL.2015 13:20:34

High Channel , Above 1755MHz

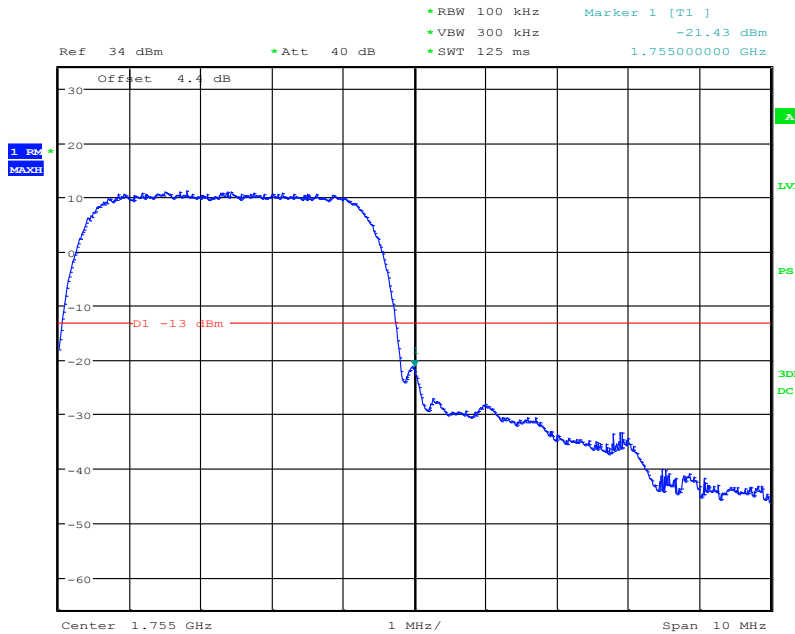

Date: 3.JUL.2015 13:21:13

4.5.11 WCDMA B5 Band Edge Results

Graphical results:

Low Channel , Below 824MHz

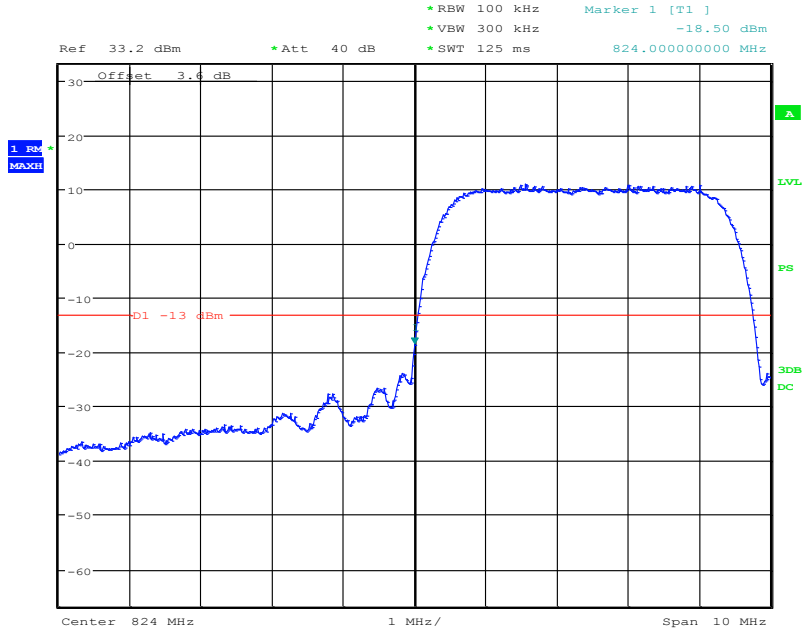

Date: 3.JUL.2015 13:23:52

High Channel , Above 849MHz

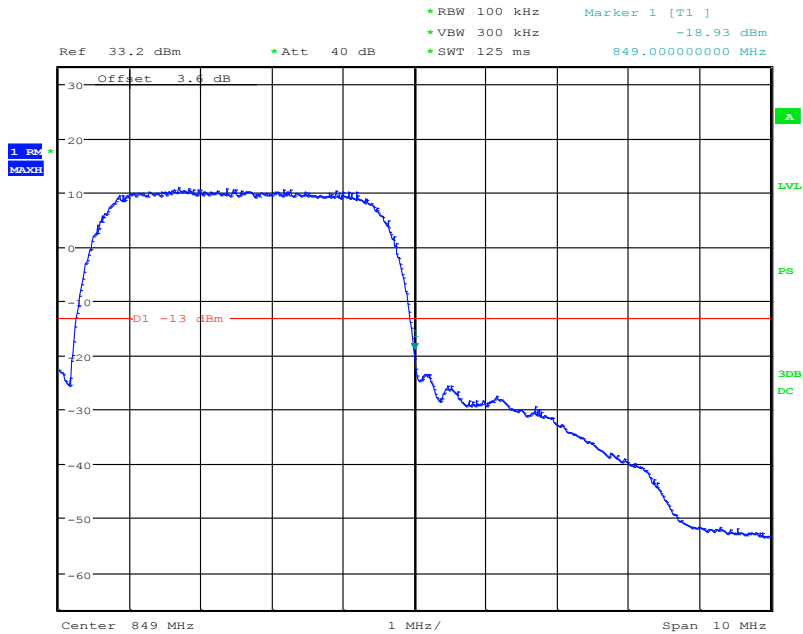

Date: 3.JUL.2015 13:24:23

4.6 Frequency Stability over Temperature Variation

Specifications:	FCC Part 2.1055, 22.355, 24.235, 27.54, 90.213 RSS-130 4.3, RSS-132 4.3, RSS-133 6.3, RSS-199 4.3
Date of Test	2015-06-24 to 2015-06-25
Test conditions:	Ambient Temperature: -30°C-50°C Relative Humidity: 30%-60% Air pressure: 86-106kPa
Test Results:	Pass

Limit	
Frequency deviation [ppm]	±2.5

Test Setup

The EUT was placed in a temperature chamber, demonstrated as figure T. The Wireless Telecommunications Test Set was used to set the Tx channel and power level, modulate the TX signal with different bit patterns and measure the frequency of Tx.

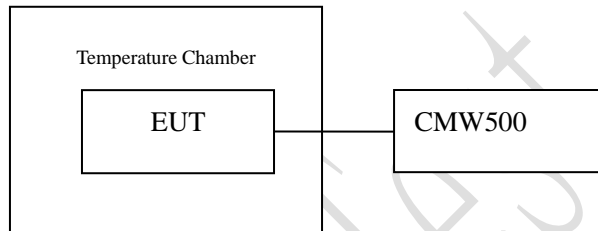

Figure T: setup for measurement of frequency stability over temperature variation

Test Method

1. The EUT was turned off and placed in the temperature chamber.
2. The temperature of the chamber was set to -30°C and allowed to stabilize.
3. The EUT temperature was allowed to stabilize for 45 minutes.
4. The EUT was turned on and set to transmit with Wireless Telecommunications Test Set.
5. The maximum transmit frequency deviation during one minute period was measured by Wireless Communications Test Set.
6. The steps 3-5 were repeated for -30°C, -20°C, -10°C, 0°C, 10°C, 20°C, 30°C, 40°C and 50°C.

4.6.1 LTE Band Frequency Stability over Temperature Variation Results

Test data:

Frequency stability is not affected by transmission bandwidth or modulation mode (QPSK, 16-QAM). The measurements below were performed with a 10 MHz transmission bandwidth and QPSK modulation.

BAND	Offset	Temperature[°C]								
		-30	-20	-10	0	10	20	30	40	50
4	Hz	14.97	12.13	18.59	-22.34	21.50	7.88	13.87	10.57	-18.81
	ppm	0.0086	0.0070	0.0107	-0.0129	0.0124	0.0045	0.0080	0.0061	-0.0109
7	Hz	15.50	-18.61	14.40	21.60	-13.29	8.57	17.22	-13.69	5.25
	ppm	0.0061	-0.0073	0.0057	0.0085	-0.0052	0.0034	0.0068	-0.0054	0.0021
12	Hz	8.19	-12.81	15.72	-11.28	18.74	-14.13	-18.56	20.97	-14.40
	ppm	0.0116	-0.0181	0.0222	-0.0159	0.0265	-0.0200	-0.0262	0.0296	-0.0204
13	Hz	-19.76	18.64	-18.58	12.90	14.75	-10.89	17.69	11.15	14.51
	ppm	-0.0253	0.0238	-0.0238	0.0165	0.0189	-0.0139	0.0226	0.0143	0.0186
25	Hz	-20.14	19.91	10.88	11.15	-15.70	14.72	13.37	-18.94	10.10
	ppm	-0.0107	0.0106	0.0058	0.0059	-0.0083	0.0078	0.0071	-0.0101	0.0054
26	Hz	-14.50	-11.06	-10.52	22.78	15.36	-12.05	14.09	15.81	-8.33
	ppm	-0.0174	-0.0133	-0.0127	0.0274	0.0185	-0.0145	0.0169	0.0190	-0.0100
30	Hz	-22.20	11.85	16.98	16.68	-13.21	-14.80	15.55	-4.11	18.37
	ppm	-0.0096	0.0051	0.0074	0.0072	-0.0057	-0.0064	0.0067	-0.0018	0.0080
41	Hz	-12.04	10.31	-11.06	2.10	17.80	-11.31	-20.27	19.75	16.22
	ppm	-0.0046	0.0040	-0.0043	0.0008	0.0069	-0.0044	-0.0078	0.0076	0.0063

4.6.2 WCDMA Band Frequency Stability over Temperature Variation

Results

Test data:

Band	Offset	Temperature[°C]								
		-30	-20	-10	0	10	20	30	40	50
2	Hz	3.04	1.86	2.93	-0.86	2.53	3.52	2.57	-3.89	4.13
	ppm	0.0016	0.0010	0.0016	-0.0005	0.0013	0.0019	0.0014	-0.0021	0.0022
4	Hz	2.33	0.78	2.12	-2.13	4.80	2.37	4.70	-2.12	3.29
	ppm	0.0013	0.0005	0.0012	-0.0012	0.0028	0.0014	0.0027	-0.0012	0.0019
5	Hz	3.59	-2.63	-2.07	0.27	-0.66	-0.15	-3.05	4.71	0.73
	ppm	0.0043	-0.0031	-0.0025	0.0003	-0.0008	-0.0002	-0.0036	0.0056	0.0009

TTL Test Report

4.7 Frequency Stability over Voltage Variation

Specifications:	FCC Part 2.1055, 22.355, 24.235, 27.54, 90.213 RSS-130 4.3, RSS-132 4.3, RSS-133 6.3, RSS-199 4.3
Date of Test	2015-06-24 to 2015-06-25
Test conditions:	Ambient Temperature: 15°C-35°C Relative Humidity: 30%-60% Air pressure: 86-106kPa
Test Results:	Pass

Limit	
Frequency deviation [ppm]	±2.5

Test Setup

The EUT was placed in a shielding chamber and powered by an adjustable power supply, demonstrated as figure V. A Wireless Telecommunications Test Set was used to set the TX channel and power level, modulate the TX signal with different bit patterns and measure the frequency of TX.

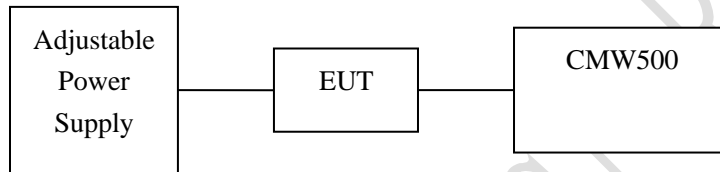

Figure V: test setup for measurement of frequency stability over voltage variation

Test Method

The EUT was powered by the adjustable power supply. The frequency stability is measured by the Wireless Telecommunications Test Set.

4.7.1 LTE Band Frequency Stability over Voltage Variation Results

Test data:

BAND	Offset	Voltage (V)		
		3.15	3.7	4.25
4	Hz	-10.77	5.69	-24.48
	ppm	-0.0062	0.0033	-0.0141
7	Hz	-16.28	5.06	29.17
	ppm	-0.0064	0.0020	0.0115
12	Hz	-7.08	-12.92	21.73
	ppm	-0.0100	-0.0183	0.0307
13	Hz	-17.67	-8.25	28.94
	ppm	-0.0226	-0.0105	0.0370
25	Hz	16.48	15.12	11.13
	ppm	0.0088	0.0080	0.0059
26	Hz	-21.29	-11.40	15.28
	ppm	-0.0256	-0.0137	0.0184
30	Hz	27.37	-17.85	8.48
	ppm	0.0118	-0.0077	0.0037
41	Hz	32.22	-12.56	-15.85
	ppm	0.0124	-0.0048	-0.0061

4.7.2 WCDMA Band Frequency Stability over Voltage Variation Results

Test data:

Band	Offset	Voltage (V)		
		3.15	3.7	4.25
2	Hz	0.40	3.68	-0.92
	ppm	0.0002	0.0020	-0.0005
4	Hz	2.37	-1.18	-2.98
	ppm	0.0014	-0.0007	-0.0017
5	Hz	-0.60	-0.64	0.14
	ppm	-0.0007	-0.0008	0.0002

TTL Test Report

4.8 Peak to Average Ratio

Specifications:	FCC Part 24.232, 27.50, RSS-130 4.4
Date of Tests	2015-06-18-2015-07-03
Test conditions:	Ambient Temperature: 15°C-35°C Relative Humidity: 30%-60% Air pressure: 86-106kPa
Test Results:	Pass

Limit

The EUT meets the requirement of having a peak to average ratio of less than 13dB.

Test Setup:

During the test, the EUT was controlled via the Wireless Communications Test Set to ensure max power transmission and proper modulation and measured by spectrum analyzer.

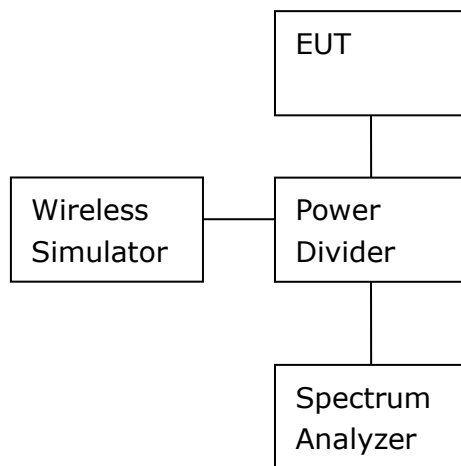

Test Method

The transmitter output was connected to a CMW500 through a coaxial RF cable and directional coupler, and configured to operate at maximum power. The peak to average ratio was measured at the required operating frequencies in each band on the Spectrum Analyzer.

4.8.1 LTE B4 Peak to Average Ratio Results

Test Data

	EUT channel No.	bandwidth	Peak to Average Ratio
QPSK	20175	10MHz	5.48
16QAM	(1732.5MHz)		6.39

4.8.2 LTE B7 Peak to Average Ratio Results

Test Data

	EUT channel No.	bandwidth	Peak to Average Ratio
QPSK	21100	10MHz	6.26
16QAM	(2535MHz)		7.13

4.8.3 LTE B12 Peak to Average Ratio Results

Test Data

	EUT channel No.	bandwidth	Peak to Average Ratio
QPSK	23095	10MHz	6.60
16QAM	(707.5MHz)		7.33

4.8.4 LTE B13 Peak to Average Ratio Results

Test Data

	EUT channel No.	bandwidth	Peak to Average Ratio
QPSK	23230	10MHz	6.41
16QAM	(782MHz)		7.58

4.8.5 LTE B25 Peak to Average Ratio Results

Test Data

	EUT channel No.	bandwidth	Peak to Average Ratio
QPSK	26365	10MHz	6.61
16QAM	(1882.5MHz)		7.34

4.8.6 LTE B26 Peak to Average Ratio Results

Test Data

	EUT channel No.	bandwidth	Peak to Average Ratio
QPSK	26865	10MHz	6.74
16QAM	(831.5MHz)		7.58

4.8.7 LTE B30 Peak to Average Ratio Results

Test Data

	EUT channel No.	bandwidth	Peak to Average Ratio
QPSK	27710	10MHz	6.23
16QAM	(2310MHz)		6.99

4.8.8 LTE B41 Peak to Average Ratio Results

Test Data

	EUT channel No.	bandwidth	Peak to Average Ratio
QPSK	40620	10MHz	11.14
16QAM	(2593MHz)		11.15

4.8.9 WCDMA B2 Peak to Average Ratio Results

Test Data

Frequency (MHz)	EUT channel No.	Modulation	Peak to Average Ratio
1880	9400	QPSK	3.61

4.8.10 WCDMA B4 Peak to Average Ratio Results

Test Data

Frequency (MHz)	EUT channel No.	Modulation	Peak to Average Ratio
1732.4	1412	QPSK	2.97

4.8.11 WCDMA B5 Peak to Average Ratio Results

Test Data

Frequency (MHz)	EUT channel No.	Modulation	Peak to Average Ratio
836.4	4182	QPSK	3.69

Graphical results for LTE B4:

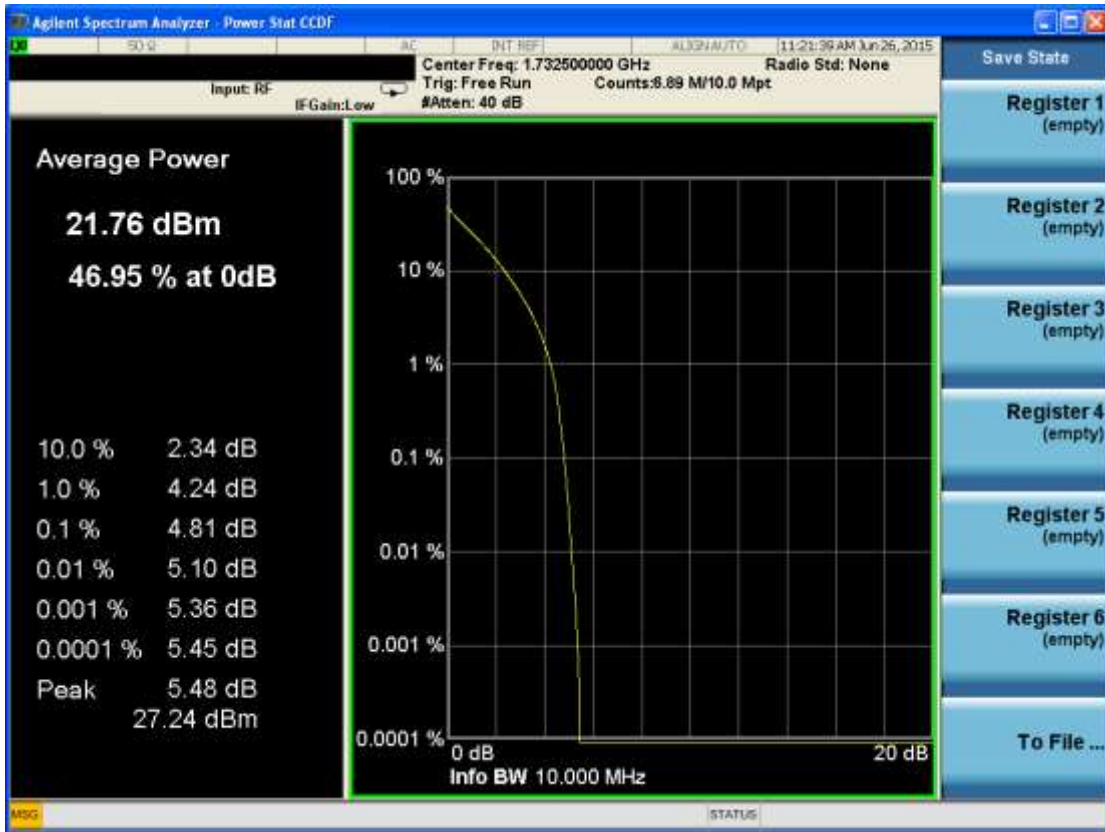

LTE Band4, QPSK

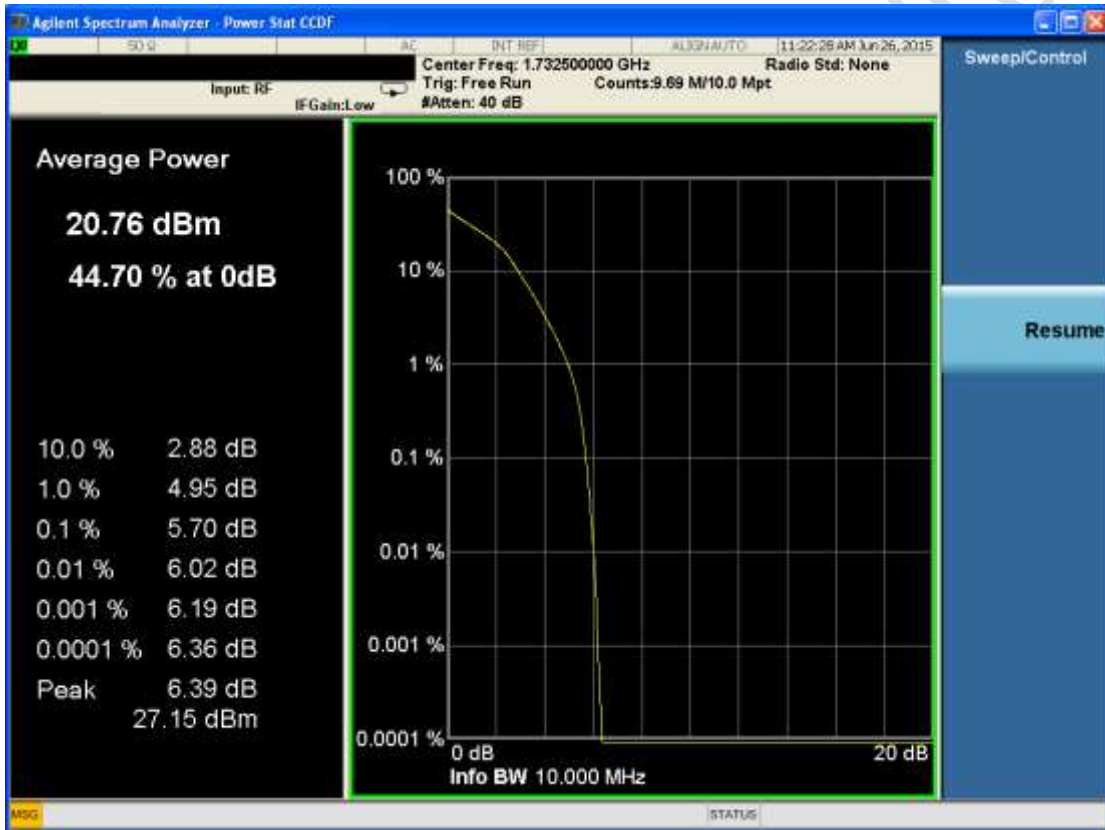

LTE Band4, 16QAM

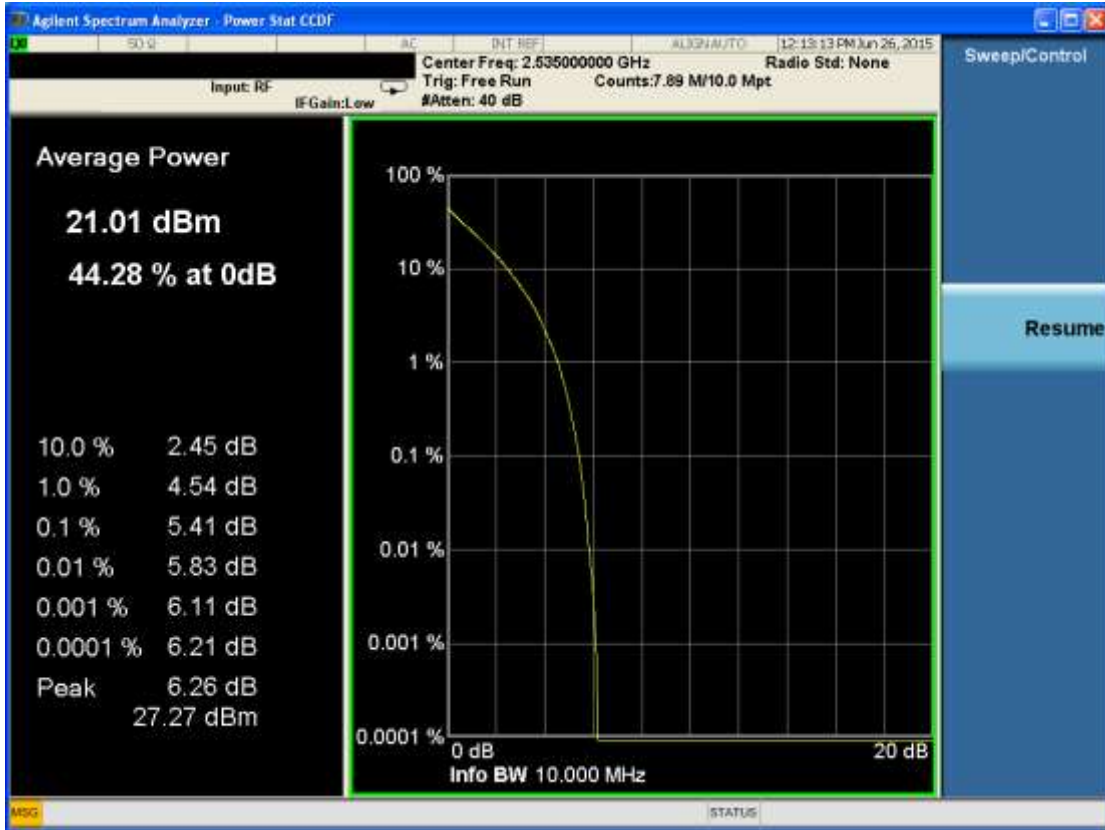

LTE Band7, QPSK

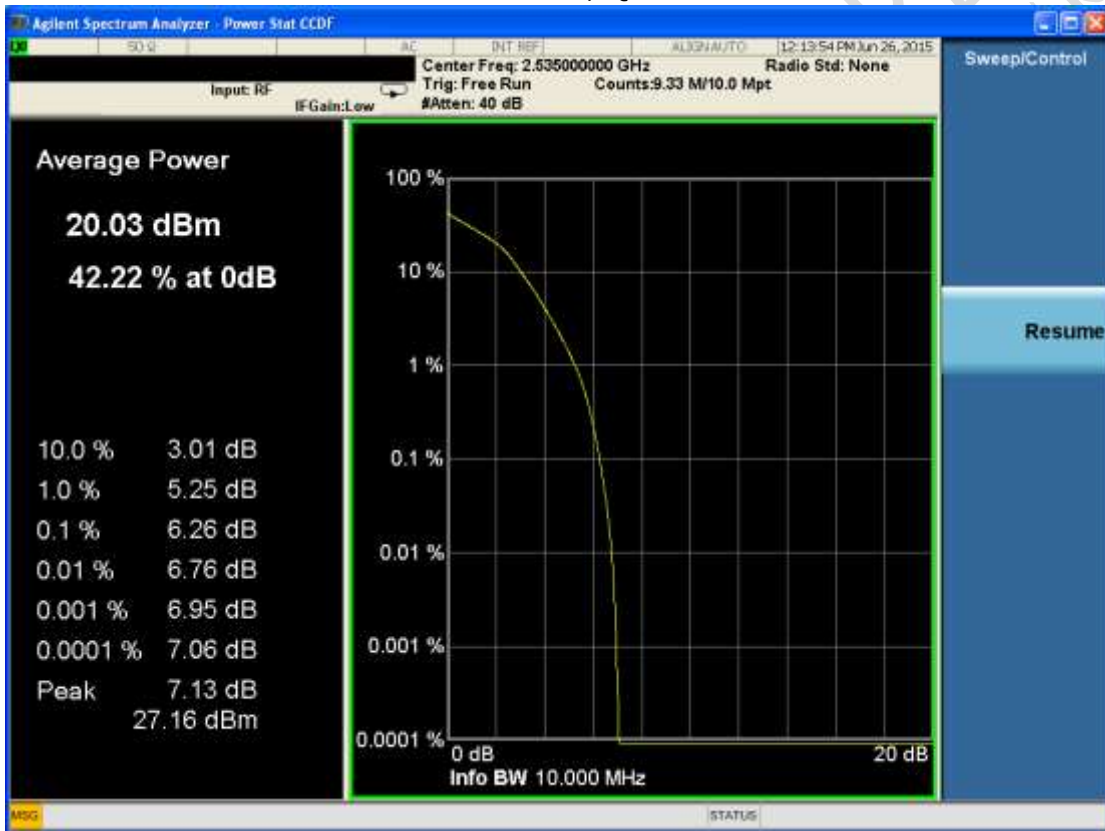

LTE Band7, 16QAM

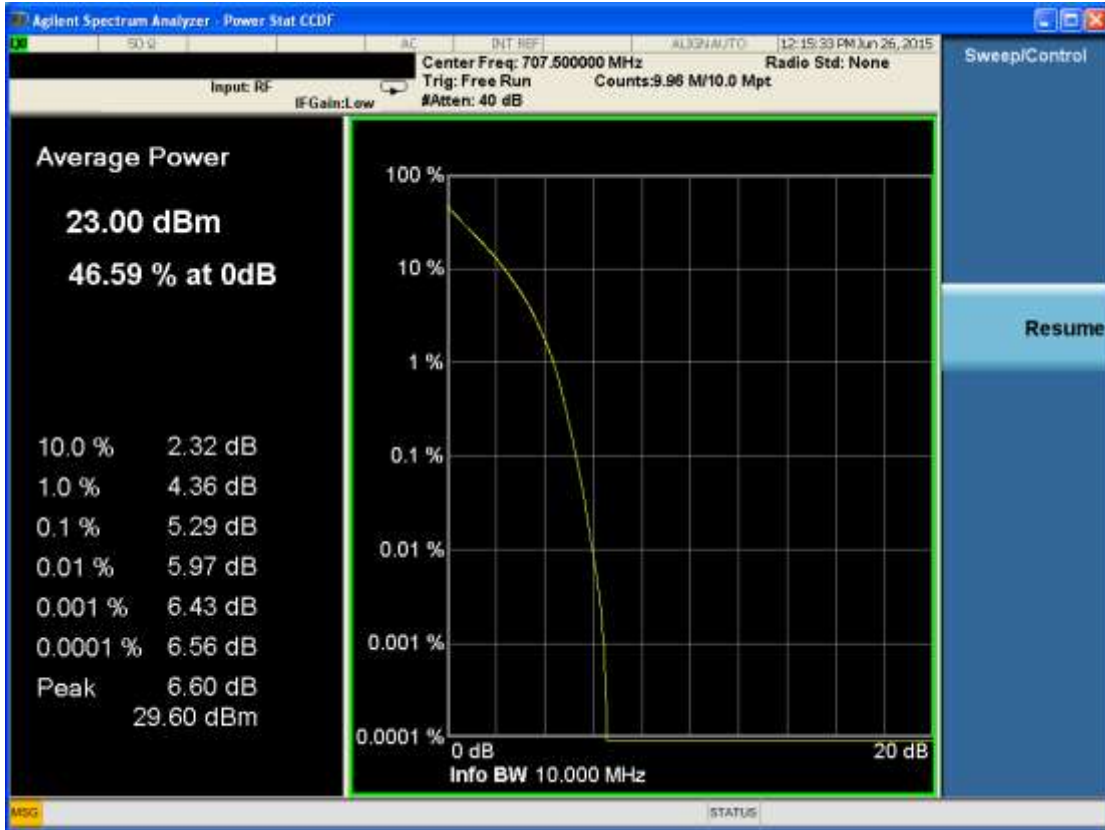

LTE Band12, QPSK

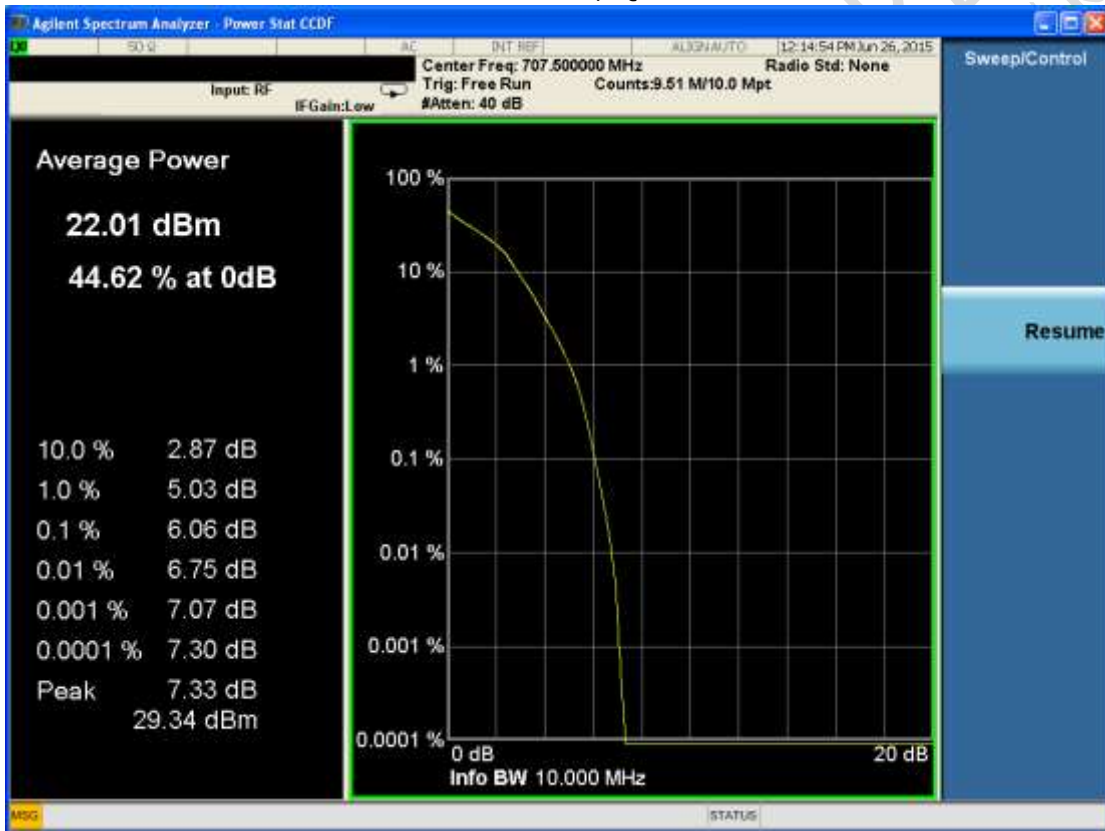

LTE Band12, 16QAM

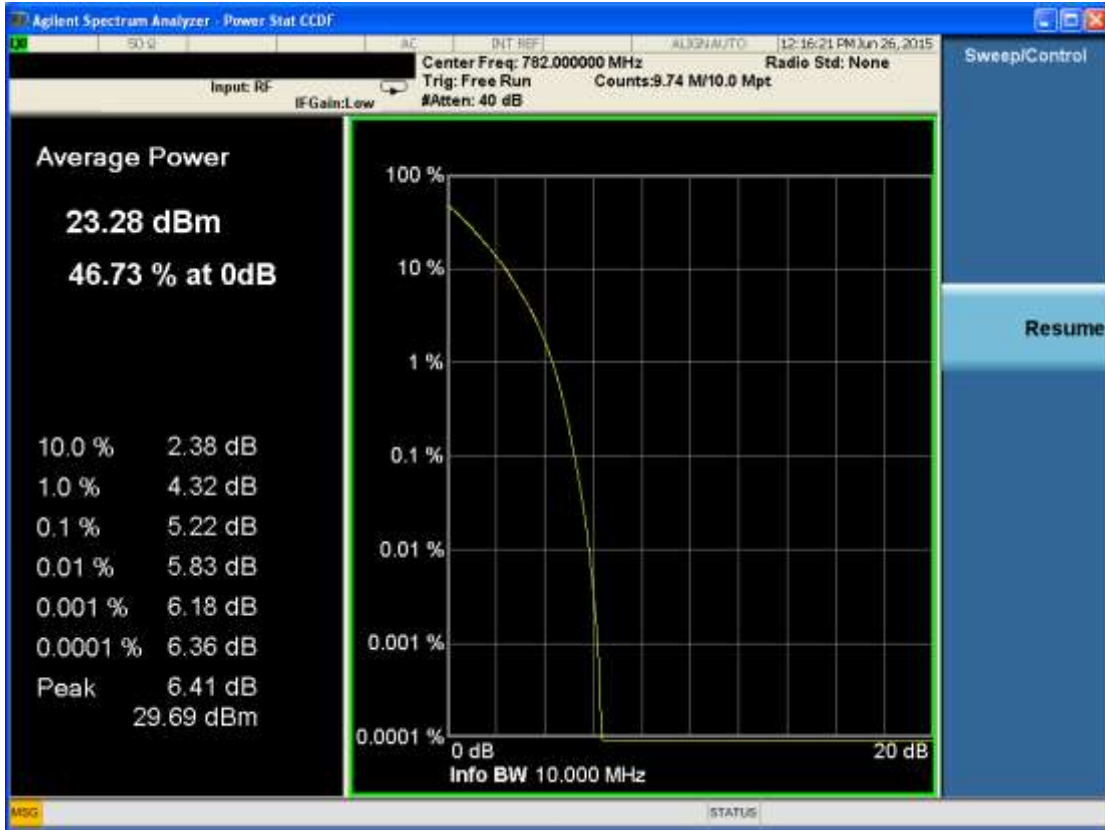

LTE Band13, QPSK

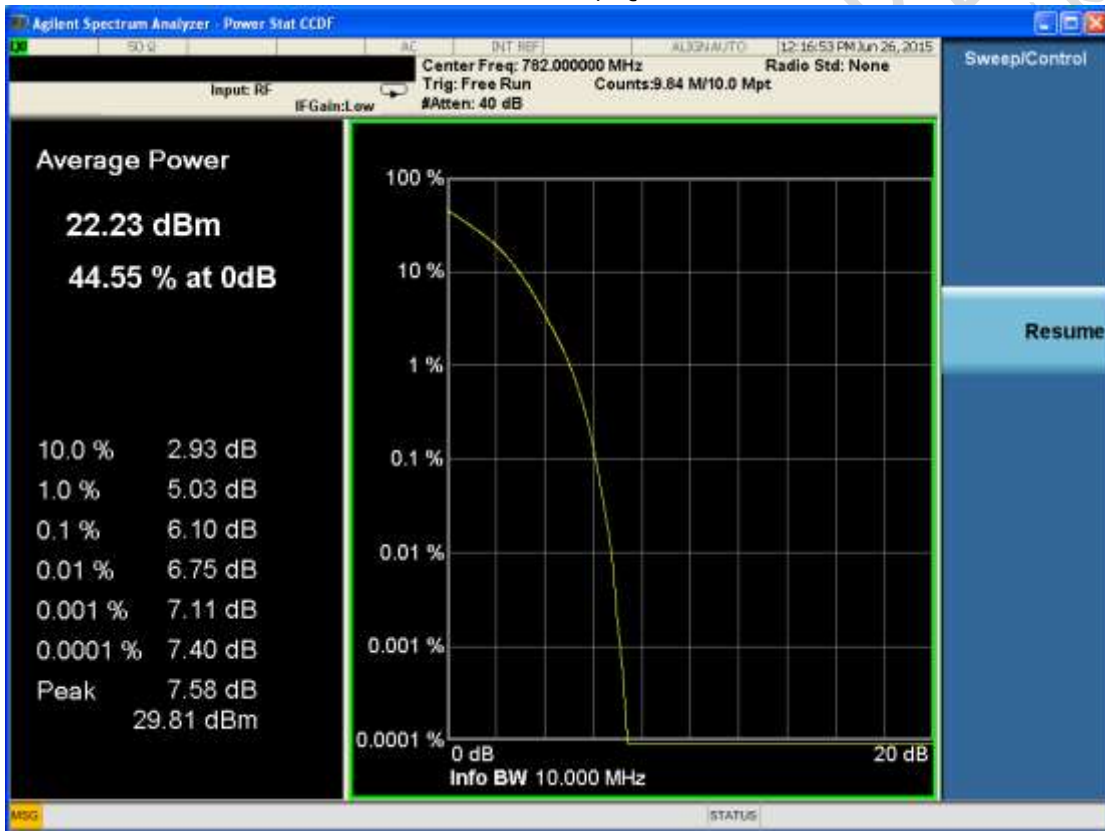

LTE Band13, 16QAM

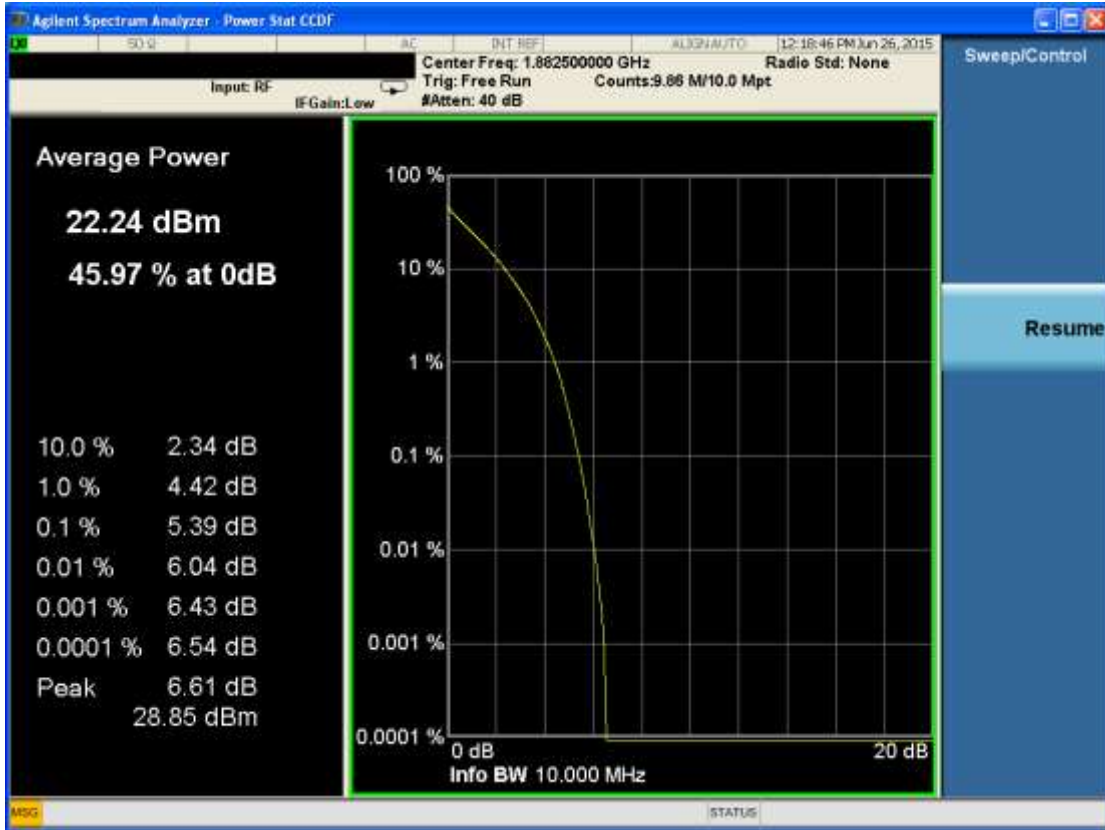

LTE Band25, QPSK

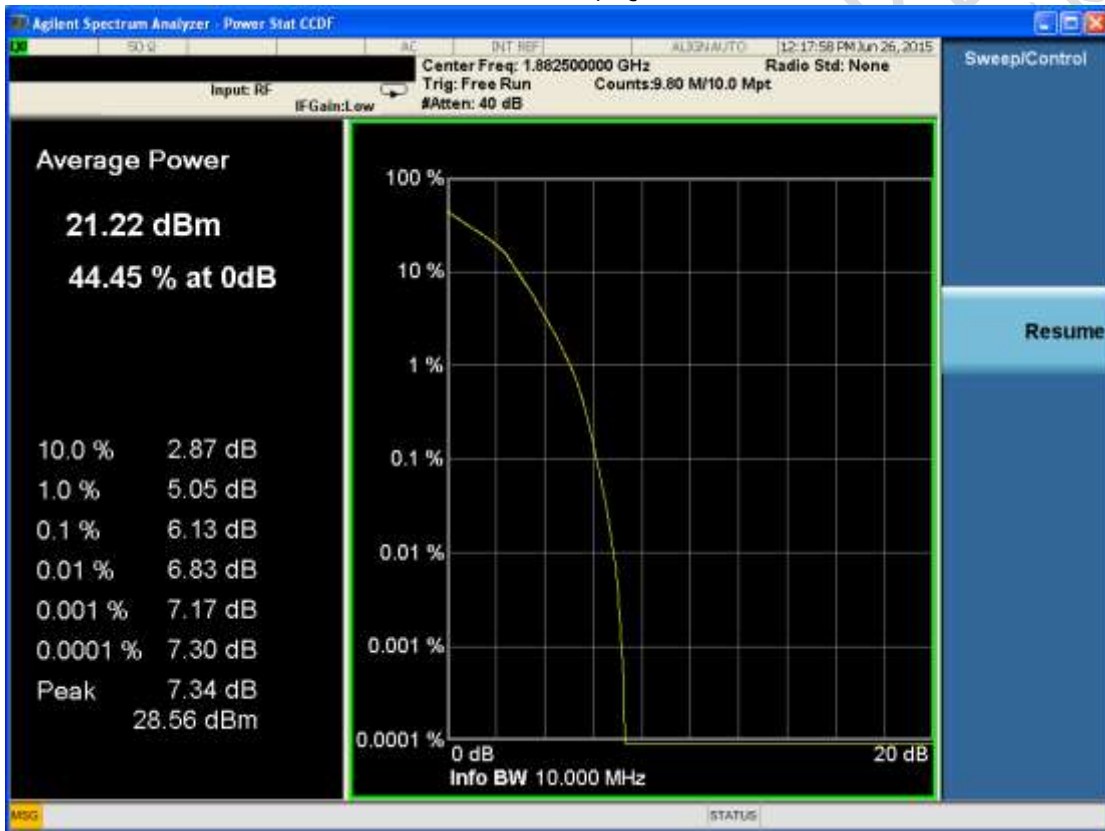

LTE Band25, 16QAM

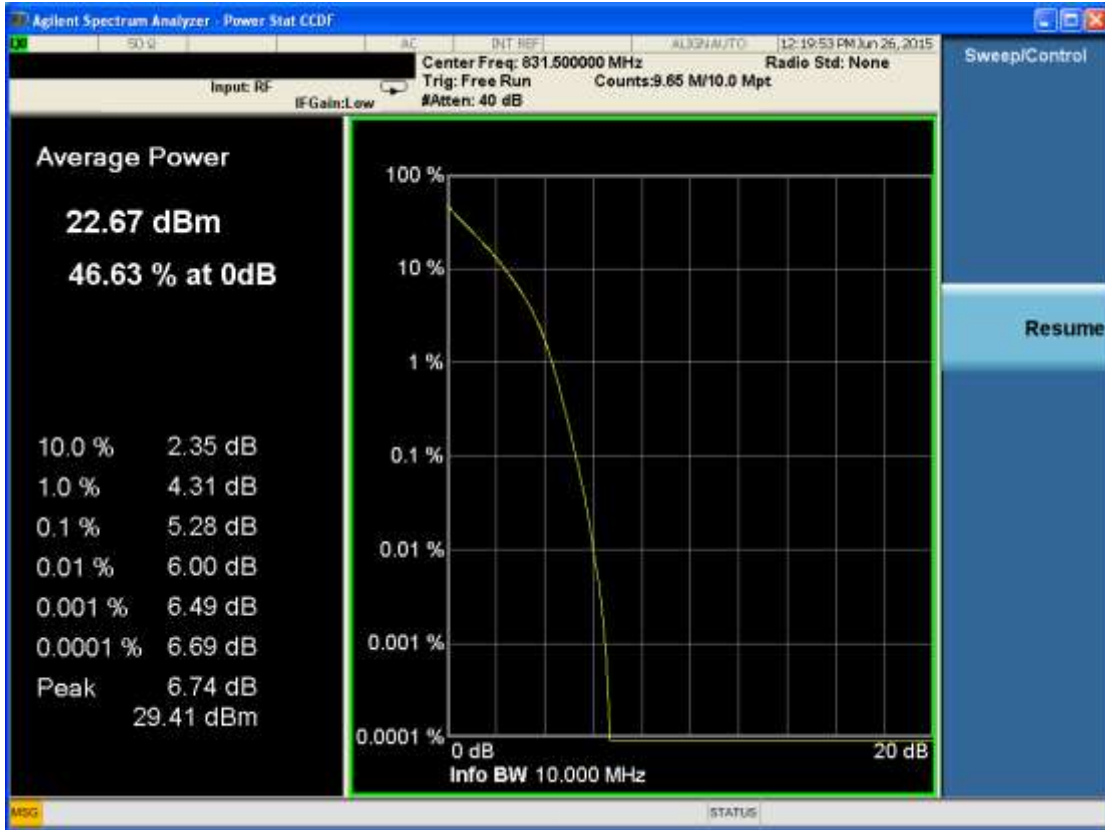

LTE Band26, QPSK



LTE Band26, 16QAM

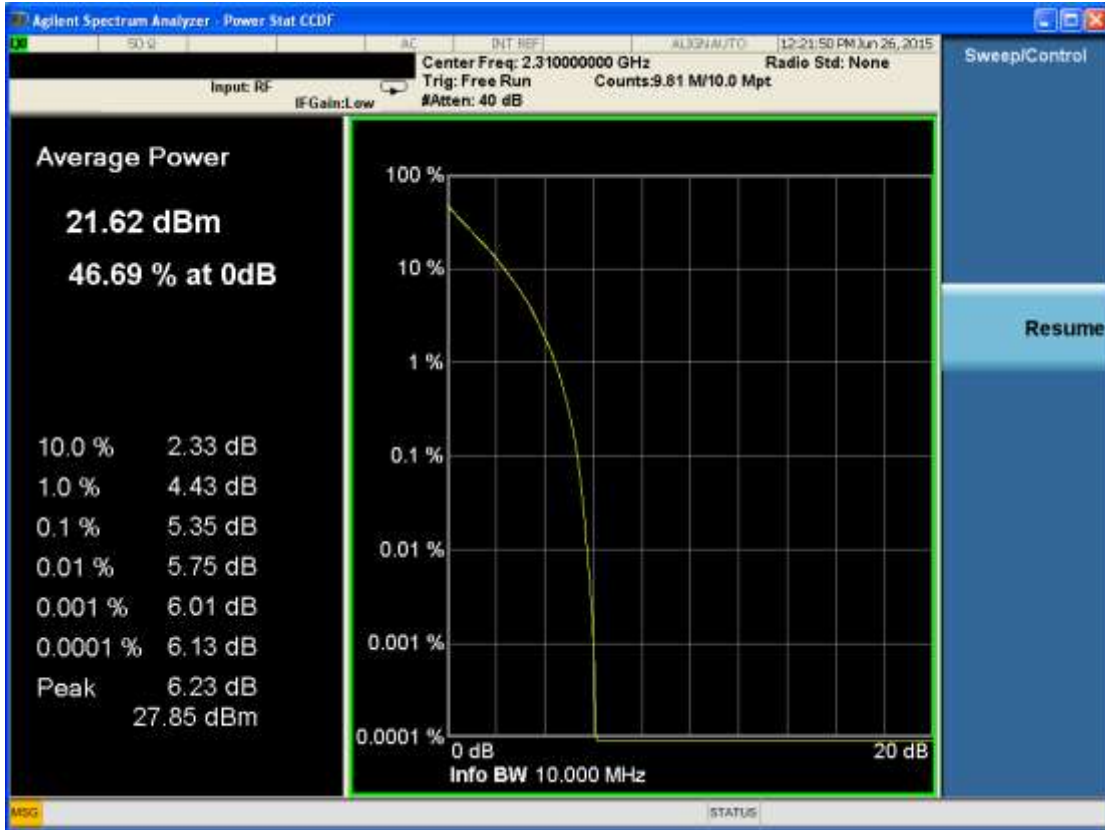

LTE Band30, QPSK

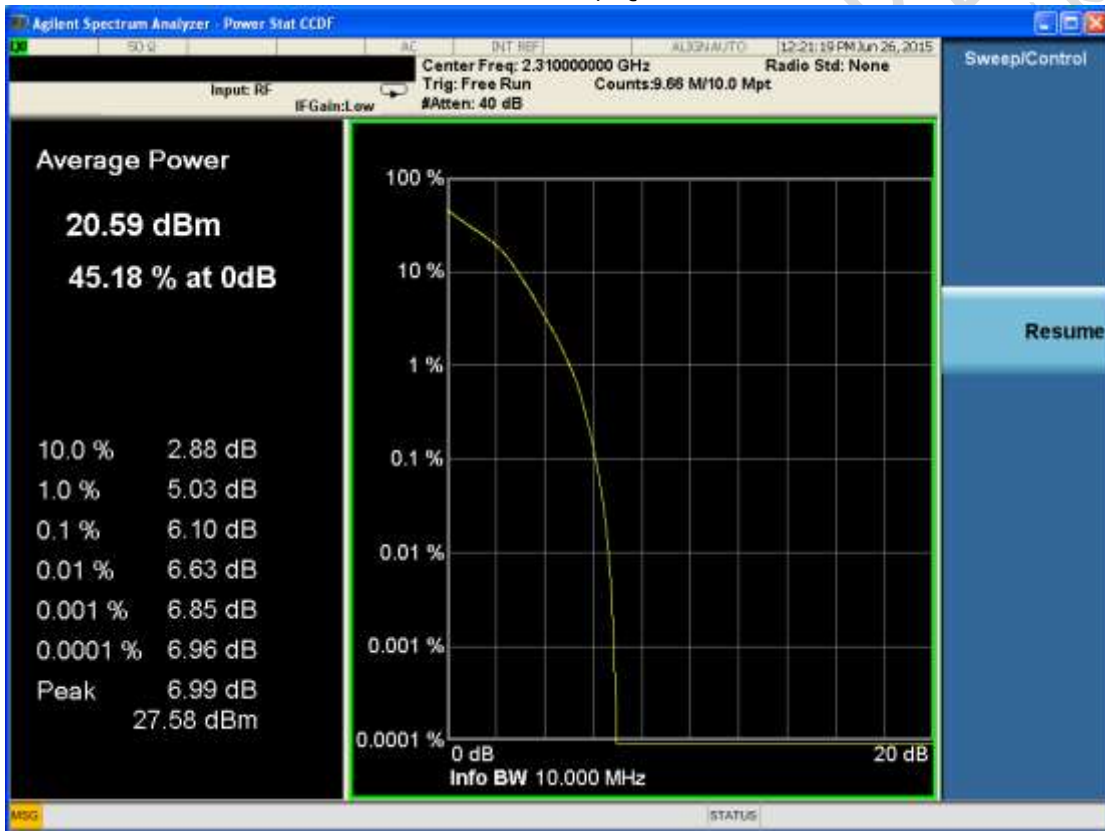

LTE Band30, 16QAM

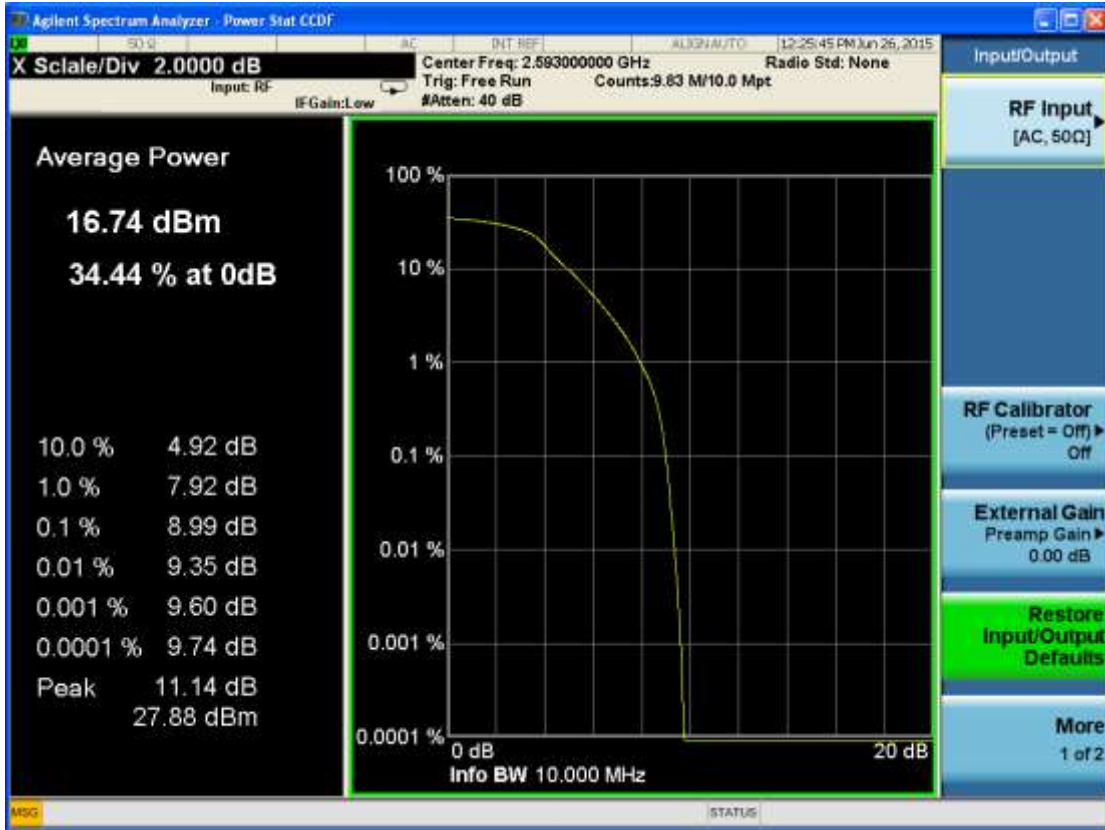

LTE Band41, QPSK

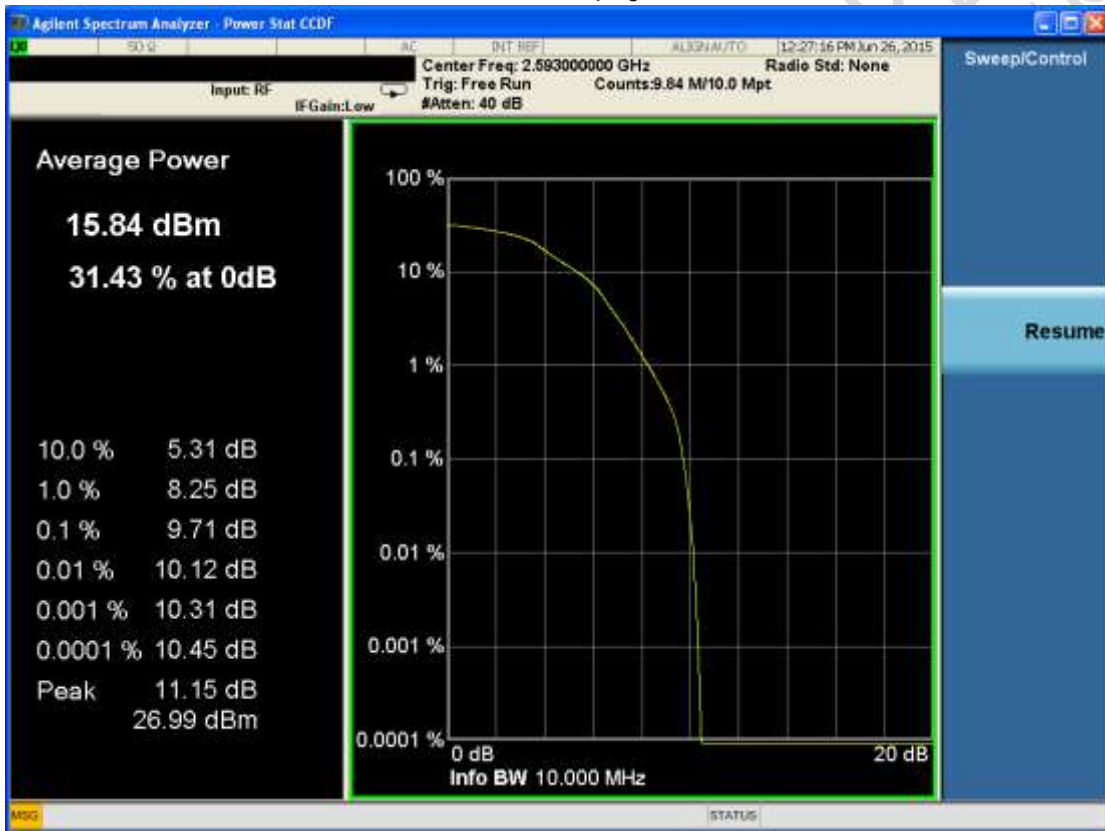

LTE Band41, 16QAM

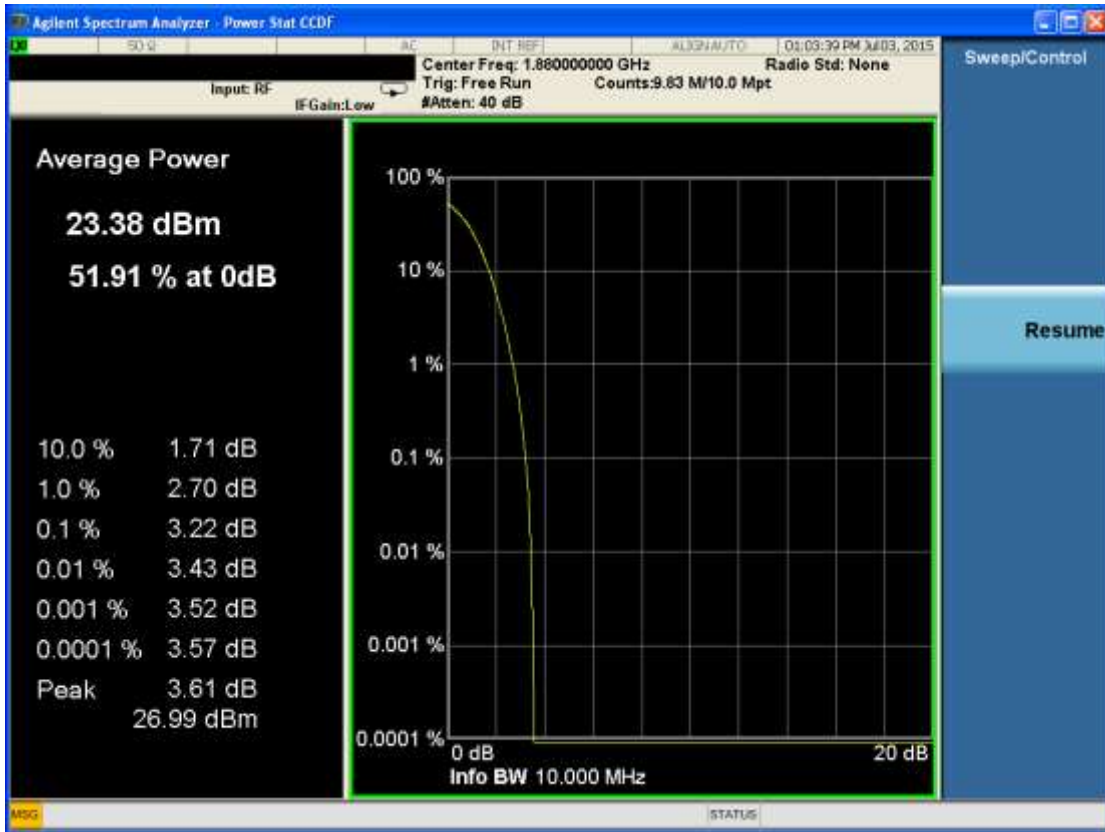

WCDMA Band2, QPSK

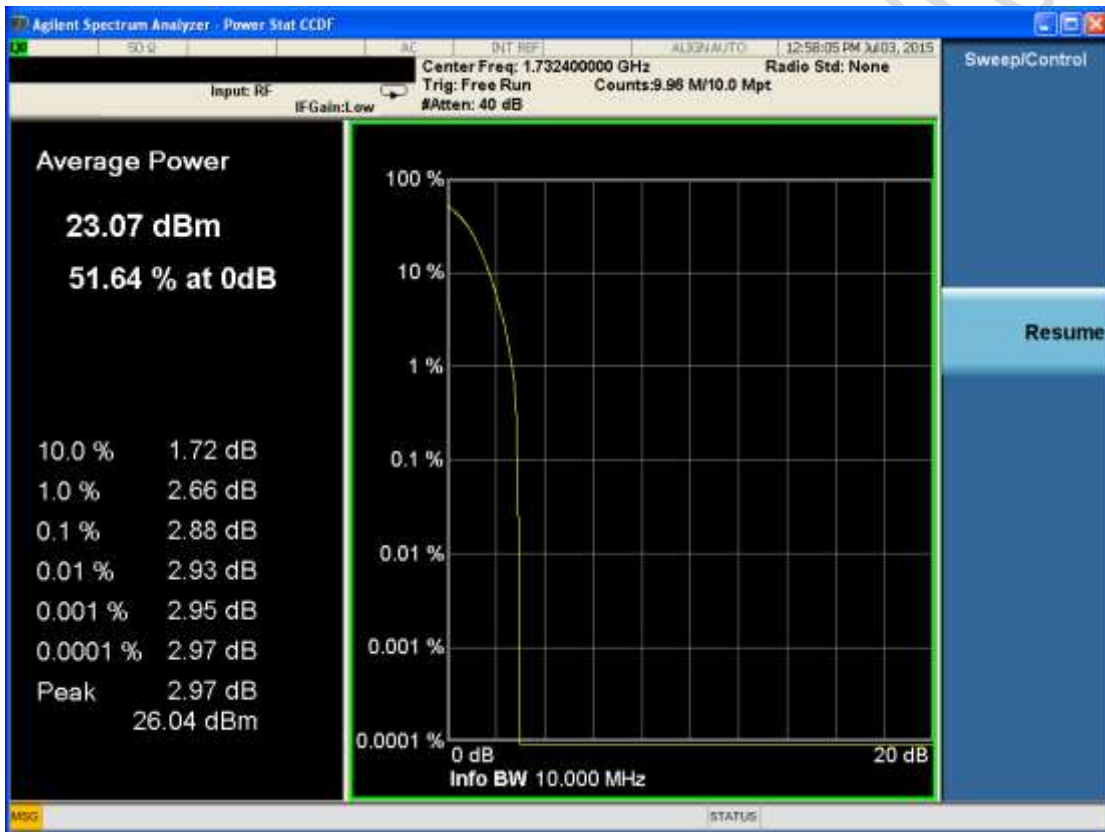

WCDMA Band4, QPSK

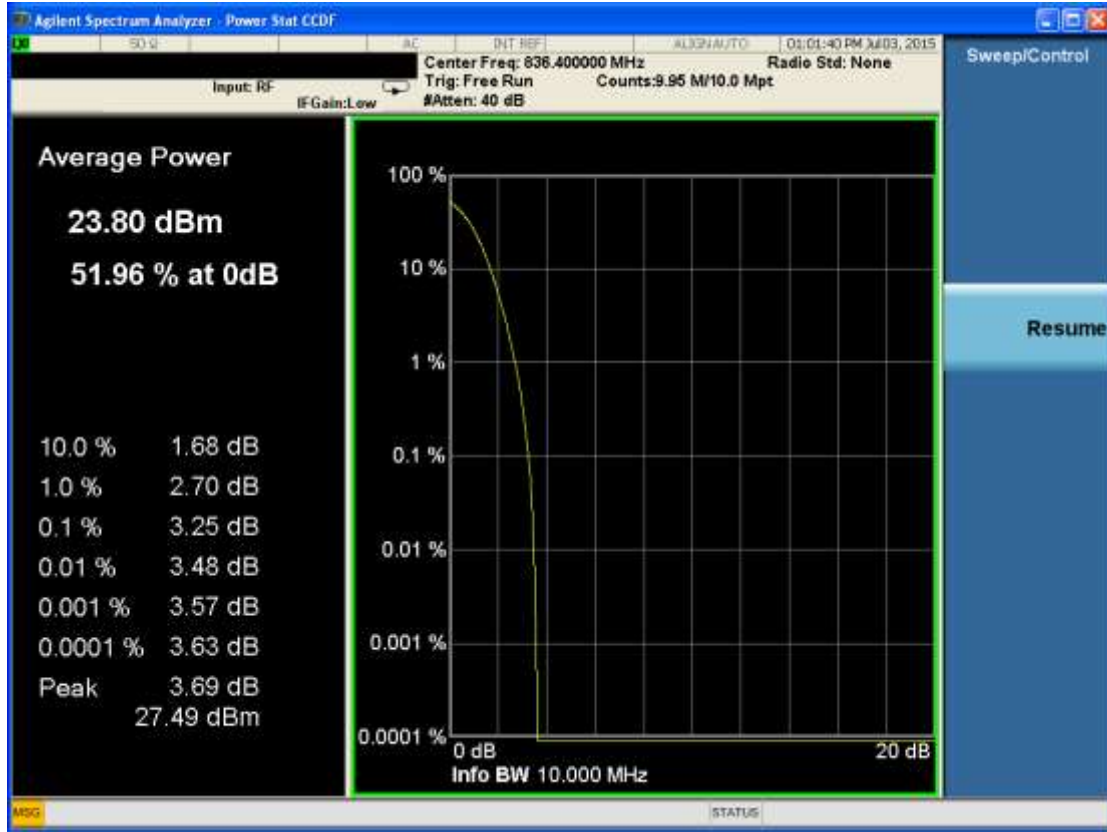

WCDMA Band5, QPSK

Annex A Photos of EM7455

See Attachment Annex A.

Annex B Photos of development board

See Attachment Annex B.

ANNEX C Deviations from Prescribed Test Methods

No deviation from Prescribed Test Methods.

————— **The End of this Report** —————