



A D T

FCC Test Report

Report No.: RF160104C14-3

FCC ID: GKR-TP00078ASB

Test Model: TP00078A

Received Date: Jul. 22, 2015

Test Date: Jul. 28, 2015 ~ Aug. 18, 2015

Issued Date: Feb. 18, 2016

Applicant: Compal Electronics Inc

Address: No.581, Ruiguang Rd., Neihu District, Taipei City, Taiwan 11492, R.O.C.

Issued By: Bureau Veritas Consumer Products Services (H.K.) Ltd., Taoyuan Branch

Lab Address: No. 47-2, 14th Ling, Chia Pau Vil., Lin Kou Dist., New Taipei City, Taiwan (R.O.C)

Test Location (1): No. 19, Hwa Ya 2nd Rd, Wen Hwa Tsuen, Kwei Shan Hsiang, Taoyuan Hsien 333, Taiwan, R.O.C.

Test Location (2): No.215, Sec. 3, Beixin Rd., Xindian Dist., New Taipei City 231, Taiwan, R.O.C



This report is for your exclusive use. Any copying or replication of this report to or for any other person or entity, or use of our name or trademark, is permitted only with our prior written permission. This report sets forth our findings solely with respect to the test samples identified herein. The results set forth in this report are not indicative or representative of the quality or characteristics of the lot from which a test sample was taken or any similar or identical product unless specifically and expressly noted. Our report includes all of the tests requested by you and the results thereof based upon the information that you provided to us. You have 60 days from date of issuance of this report to notify us of any material error or omission caused by our negligence, provided, however, that such notice shall be in writing and shall specifically address the issue you wish to raise. A failure to raise such issue within the prescribed time shall constitute your unqualified acceptance of the completeness of this report, the tests conducted and the correctness of the report contents. Unless specifically mentioned, the uncertainty of measurement has been explicitly taken into account to declare the compliance or non-compliance to the specification.



Table of Contents

Release Control Record	3
1 Certificate of Conformity	4
2 Summary of Test Results	5
2.1 Measurement Uncertainty	5
2.2 Modification Record	5
3 General Information	6
3.1 General Description of EUT	6
3.2 Description of Test Modes.....	7
3.2.1 Test Mode Applicability and Tested Channel Detail	8
3.3 Description of Support Units	10
3.3.1 Configuration of System under Test	10
3.4 General Description of Applied Standards.....	10
4 Test Types and Results	11
4.1 Radiated Emission and Bandedge Measurement	11
4.1.1 Limits of Radiated Emission and Bandedge Measurement	11
4.1.2 Test Instruments	12
4.1.3 Test Procedures.....	13
4.1.4 Deviation from Test Standard	13
4.1.5 Test Set Up	14
4.1.6 EUT Operating Conditions.....	14
4.1.7 Test Results	15
4.2 Conducted Emission Measurement.....	21
4.2.1 Limits of Conducted Emission Measurement	21
4.2.2 Test Instruments	21
4.2.3 Test Procedures.....	21
4.2.4 Deviation from Test Standard	21
4.2.5 TEST SETUP.....	22
4.2.6 EUT Operating Conditions.....	22
4.2.7 Test Results	23
4.3 Conducted Output Power Measurement	27
4.3.1 Limits OF Conducted Output Power Measurement	27
4.3.2 Test Setup.....	27
4.3.3 Test Instruments	27
4.3.4 Test Procedures.....	27
4.3.5 Deviation from Test Standard	27
4.3.6 EUT Operating Conditions.....	27
4.3.7 Test Results	28
5 Pictures of Test Arrangements	29
Appendix – Information on the Testing Laboratories	30



A D T

Release Control Record

Issue No.	Description	Date Issued
RF160104C14-3	Original Release	Feb. 18, 2016



A D T

1 Certificate of Conformity

Product: Tablet Computer

Brand: Lenovo

Test Model: TP00078A

Sample Status: Production Unit

Applicant: Compal Electronics Inc

Test Date: Jul. 28, 2015 ~ Aug. 18, 2015

Standards: 47 CFR FCC Part 15, Subpart C (Section 15.247)
ANSI C63.10:2013

The above equipment has been tested by **Bureau Veritas Consumer Products Services (H.K.) Ltd., Taoyuan Branch**, and found compliance with the requirement of the above standards. The test record, data evaluation & Equipment Under Test (EUT) configurations represented herein are true and accurate accounts of the measurements of the sample's EMC characteristics under the conditions specified in this report.

Prepared by : Gina Liu , **Date:** Feb. 18, 2016
Gina Liu / Specialist

Approved by : Stanley Wu , **Date:** Feb. 18, 2016
Stanley Wu / Assistant Manager



2 Summary of Test Results

47 CFR FCC Part 15, Subpart C (SECTION 15.247) LE			
FCC Clause	Test Item	Result	Remarks
15.207	AC Power Conducted Emission	PASS	Meet the requirement of limit. Minimum passing margin is -17.82dB at 0.15000MHz.
15.205 & 209	Radiated Emissions	PASS	Meet the requirement of limit. Minimum passing margin is -4.33dB at 700.4MHz.
15.247(d)	Band Edge Measurement	N/A	Refer to Note
15.247(d)	Antenna Port Emission	N/A	Refer to Note
15.247(a)(2)	6dB bandwidth	N/A	Refer to Note
15.247(b)	Conducted power	PASS	Meet the requirement of limit.
15.247(e)	Power Spectral Density	N/A	Refer to Note
15.203	Antenna Requirement	PASS	No antenna connector is used.

Note: Only test item of AC power Conducted Emission and Radiated Emissions were performed for this report. Other testing data please refer to SPORTON International Inc. report no.: FR473142AD for module (Brand: Broadcom, Model: BCM94356Z, FCC ID: QDS-BRCM1085).

2.1 Measurement Uncertainty

Where relevant, the following measurement uncertainty levels have been estimated for tests performed on the EUT:

The listed uncertainties are the worst case uncertainty for the entire range of measurement. Please note that the uncertainty values are provided for informational purposes only and are not used in determining the PASS/FAIL results.

Measurement	Frequency	Expanded Uncertainty (k=2) (±)
Conducted Emissions at mains ports	150kHz ~ 30MHz	2.44 dB
Radiated Emissions up to 1 GHz	30MHz ~ 200MHz	2.0153 dB
	200MHz ~ 1000MHz	2.0224 dB
Radiated Emissions above 1 GHz	1GHz ~ 18GHz	1.0121 dB
	18GHz ~ 40GHz	1.1508 dB

2.2 Modification Record

There were no modifications required for compliance.



3 General Information

3.1 General Description of EUT

Product	Tablet Computer
Brand	Lenovo
Test Model	TP00078A
Status of EUT	Production Unit
Power Supply Rating	20Vdc (Adapter) 15.2Vdc (Li-ion battery)
Modulation Type	GFSK
Transfer Rate	1 Mbps
Operating Frequency	2402 ~ 2480 MHz
Number of Channel	40
Antenna Type	Refer to Note as below
Antenna Connector	N/A
Accessory Device	Refer to Note as below
Data Cable Supplied	Refer to Note as below

Note:

- This EUT contains two samples listed as below.

Sample	Difference
EUT 1	Tablet computer with Antenna (Ethertronics Inc.)
EUT 2	Tablet computer with Antenna (HIGH-TEK)

- The antenna information is listed as below.

Antenna Type	Brand Name	Parts Number	Antenna Gain	
			2.4GHz	5GHz
PIFA	Ethertronics Inc.	WLAN Main Antenna: 5002022 WLAN Aux. Antenna: 5002030	Main: 0.85 Aux.: -0.71	Main: 0.46 Aux.: 0.36
	HIGH-TEK	WLAN Main Antenna: DC33001RQ00 WLAN Aux. Antenna: DC33001RQ10	Main: -0.17 Aux.: -0.30	Main: 1.84 Aux.: 1.56

- The EUT contains following accessory devices.

Product	Brand	Model	Description
Adapter 1	Lenovo	ADLX45NCC2A	I/P: 100-240Vac, 50~60Hz, 1.3A O/P: 20Vdc, 2.25A
Adapter 2	Lenovo	ADLX45NDC2A	I/P: 100-240Vac, 50~60Hz, 1.3A O/P: 20Vdc, 2.25A
Battery	Lenovo	SB10F46465	15.2Vdc, 2.895Ah
WLAN Module	Broadcom	BCM94356Z	--
WWAN Module	Sierra	EM7455	--

- The above EUT information is declared by manufacturer and for more detailed features description, please refer to the manufacturer's specifications or User's Manual.



3.2 Description of Test Modes

LE 4.0

40 channels are provided to this EUT:

Channel	Freq. (MHz)	Channel	Freq. (MHz)	Channel	Freq. (MHz)	Channel	Freq. (MHz)
0	2402	10	2422	20	2442	30	2462
1	2404	11	2424	21	2444	31	2464
2	2406	12	2426	22	2446	32	2466
3	2408	13	2428	23	2448	33	2468
4	2410	14	2430	24	2450	34	2470
5	2412	15	2432	25	2452	35	2472
6	2414	16	2434	26	2454	36	2474
7	2416	17	2436	27	2456	37	2476
8	2418	18	2438	28	2458	38	2478
9	2420	19	2440	29	2460	39	2480



3.2.1 Test Mode Applicability and Tested Channel Detail

LE 4.0

EUT Configure Mode	Applicable To				Description
	RE≥1G	RE<1G	PLC	APCM	
A	√	√	√	√	EUT 1 (Ant. Ethertronic)
B	√	√	√	√	EUT 2 (Ant. HIGH-TEK)

Where **RE≥1G**: Radiated Emission above 1GHz **RE<1G**: Radiated Emission below 1GHz
PLC: Power Line Conducted Emission **APCM**: Antenna Port Conducted Measurement

Radiated Emission Test (Above 1GHz):

- Pre-Scan has been conducted to determine the worst-case mode from all possible combinations between available modulations, data rates and antenna ports (if EUT with antenna diversity architecture).
- Following channel(s) was (were) selected for the final test as listed below.

EUT Configure Mode	Available Channel	Tested Channel	Modulation Type	Data Rate (Mbps)
A	0 to 39	0, 19, 39	GFSK	1
B	0 to 39	0	GFSK	1

Radiated Emission Test (Below 1GHz):

- Pre-Scan has been conducted to determine the worst-case mode from all possible combinations between available modulations, data rates and antenna ports (if EUT with antenna diversity architecture).
- Following channel(s) was (were) selected for the final test as listed below.

EUT Configure Mode	Available Channel	Tested Channel	Modulation Type	Data Rate (Mbps)
A, B	0 to 39	0	GFSK	1

Power Line Conducted Emission Test:

- Pre-Scan has been conducted to determine the worst-case mode from all possible combinations between available modulations, data rates and antenna ports (if EUT with antenna diversity architecture).
- Following channel(s) was (were) selected for the final test as listed below.

EUT Configure Mode	Available Channel	Tested Channel	Modulation Type	Data Rate (Mbps)
A, B	0 to 39	0	GFSK	1

Antenna Port Conducted Measurement:

- This item includes all test value of each mode, but only includes spectrum plot of worst value of each mode.
- Pre-Scan has been conducted to determine the worst-case mode from all possible combinations between available modulations, data rates and antenna ports (if EUT with antenna diversity architecture).
- Following channel(s) was (were) selected for the final test as listed below.

EUT Configure Mode	Available Channel	Tested Channel	Modulation Type	Data Rate (Mbps)
A, B	0 to 39	0, 19, 39	GFSK	1



Test Condition:

Applicable To	Environmental Conditions	Input Power	Tested by
RE \geq 1G	25deg. C, 65%RH	120Vac, 60Hz	Charles Hsiao
RE $<$ 1G	25deg. C, 65%RH	120Vac, 60Hz	Charles Hsiao
PLC	25deg. C, 68%RH	120Vac, 60Hz	Toby Tian
APCM	25deg. C, 65%RH	120Vac, 60Hz	Howard Kao

3.3 Description of Support Units

3.3.1 Configuration of System under Test

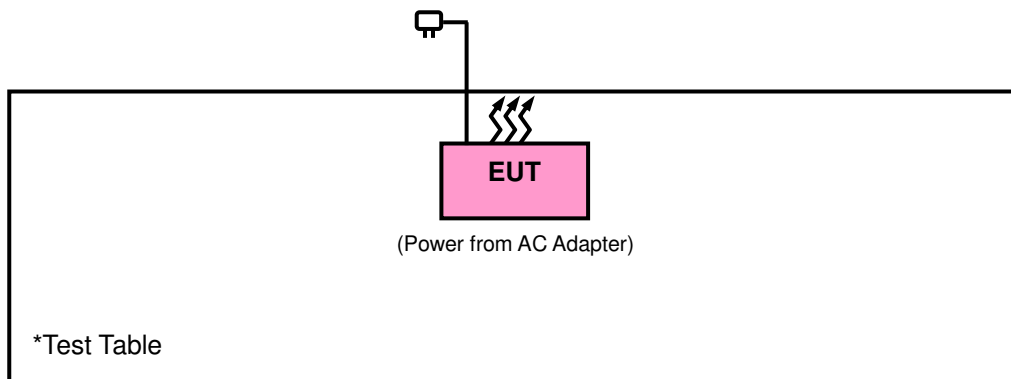

3.4 General Description of Applied Standards

The EUT is a RF Product. According to the specifications of the manufacturer, it must comply with the requirements of the following standards:

FCC Part 15, Subpart C (15.247)

FCC Public Notice DA 00-705

558074 D01 DTS Meas Guidance v03r02

ANSI C63.10-2013

All test items have been performed and recorded as per the above standards.

NOTE: The EUT has been verified to comply with the requirements of FCC Part 15, Subpart B, Class B (DoC).
The test report has been issued separately.

4 Test Types and Results

4.1 Radiated Emission and Bandedge Measurement

4.1.1 Limits of Radiated Emission and Bandedge Measurement

Radiated emissions which fall in the restricted bands must comply with the radiated emission limits specified as below table. Other emissions shall be at least 20dB below the highest level of the desired power:

Frequencies (MHz)	Field Strength (microvolts/meter)	Measurement Distance (meters)
0.009 ~ 0.490	2400/F(kHz)	300
0.490 ~ 1.705	24000/F(kHz)	30
1.705 ~ 30.0	30	30
30 ~ 88	100	3
88 ~ 216	150	3
216 ~ 960	200	3
Above 960	500	3

NOTE:

1. The lower limit shall apply at the transition frequencies.
2. Emission level (dBuV/m) = 20 log Emission level (uV/m).
3. For frequencies above 1000MHz, the field strength limits are based on average detector, however, the peak field strength of any emission shall not exceed the maximum permitted average limits, specified above by more than 20dB under any condition of modulation.



A D T

4.1.2 Test Instruments

Description & Manufacturer	Model No.	Serial No.	Date of Calibration	Due Date of Calibration
Spectrum Analyzer Agilent Technologies	N9038A	MY52260177	May 19, 2015	May 18, 2016
Spectrum Analyzer ROHDE & SCHWARZ	FSU43	101261	Dec. 10, 2014	Dec. 09, 2015
BILOG Antenna SCHWARZBECK	VULB9168	9168-472	Feb. 04, 2015	Feb. 04, 2016
HORN Antenna ETS-Lindgren	3117	00143293	Aug. 28, 2014	Aug. 27, 2015
Preamplifier Agilent	310N	187226	Jun. 29, 2015	Jun. 28, 2016
Preamplifier Agilent	83017A	980116	Jan. 09, 2015	Jan. 08, 2016
Power Meter Anritsu	ML2495A	1232002	Sep. 17, 2014	Sep. 16, 2015
Power Sensor Anritsu	MA2411B	1207325	Sep. 17, 2014	Sep. 16, 2015
RF signal cable ETS-LINDGREN	5D-FB	Cable-CH1-01(R FC-SMS-100-SM S-120+RFC-SMS -100-SMS-400)	Jun. 27, 2015	Jun. 26, 2016
RF signal cable ETS-LINDGREN	8D-FB	Cable-CH1-02(R FC-SMS-100-SM S-24)	Jun. 27, 2015	Jun. 26, 2016
Software BV ADT	E3 8.130425b	NA	NA	NA
Antenna Tower MF	NA	NA	NA	NA
Turn Table MF	NA	NA	NA	NA
Antenna Tower & Turn Table Controller MF	MF-7802	NA	NA	NA

- Note: 1. The calibration interval of the above test instruments is 12 months and the calibrations are traceable to NML/ROC and NIST/USA.
2. The test was performed in HsinTien Chamber 1.
3. The horn antenna and HP preamplifier (model: 8449B) are used only for the measurement of emission frequency above 1GHz if tested.
4. The FCC Site Registration No. is 149147.
5. The IC Site Registration No. is IC7450I-1.



4.1.3 Test Procedures

- a. The EUT was placed on the top of a rotating table 0.8 meters (for below 1GHz) / 1.5 meters (for above 1GHz) above the ground at 3 meter chamber room for test. The table was rotated 360 degrees to determine the position of the highest radiation.
- b. The EUT was set 3 meters away from the interference-receiving antenna, which was mounted on the top of a variable-height antenna tower.
- c. The height of antenna is varied from one meter to four meters above the ground to determine the maximum value of the field strength. Both horizontal and vertical polarizations of the antenna are set to make the measurement.
- d. For each suspected emission, the EUT was arranged to its worst case and then the antenna was tuned to heights from 1 meter to 4 meters and the rotatable table was turned from 0 degrees to 360 degrees to find the maximum reading.
- e. The test-receiver system was set to quasi-peak detect function and specified bandwidth with maximum hold mode when the test frequency is below 1 GHz.
- f. The test-receiver system was set to peak and average detect function and specified bandwidth with maximum hold mode when the test frequency is above 1 GHz. If the peak reading value also meets average limit, measurement with the average detector is unnecessary.

Note:

1. The resolution bandwidth and video bandwidth of test receiver/spectrum analyzer is 120kHz for Quasi-peak detection (QP) at frequency below 1GHz.
2. The resolution bandwidth of test receiver/spectrum analyzer is 1 MHz and the video bandwidth is 3 MHz for Peak detection (PK) at frequency above 1GHz.
3. The resolution bandwidth of test receiver/spectrum analyzer is 1MHz and the video bandwidth is 3MHz for RMS Average (Duty cycle < 98%) for Average detection (AV) at frequency above 1GHz, then the measurement results was added to a correction factor ($10 \log(1/\text{duty cycle})$).
4. The resolution bandwidth of test receiver/spectrum analyzer is 1MHz and the video bandwidth is 10Hz (Duty cycle $\geq 98\%$) for Average detection (AV) at frequency above 1GHz.
5. All modes of operation were investigated and the worst-case emissions are reported.

4.1.4 Deviation from Test Standard

No deviation.

4.1.5 Test Set Up

<Frequency Range below 1GHz>

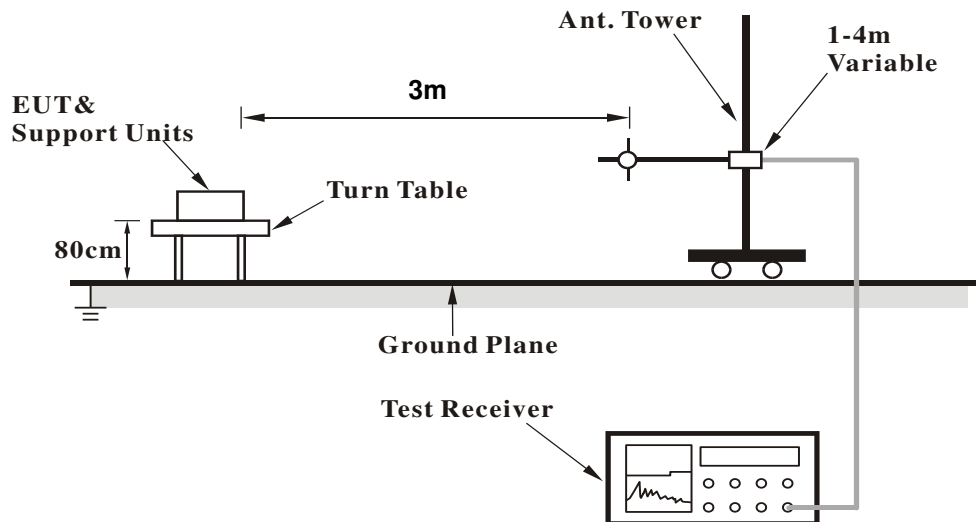

<Frequency Range above 1GHz>

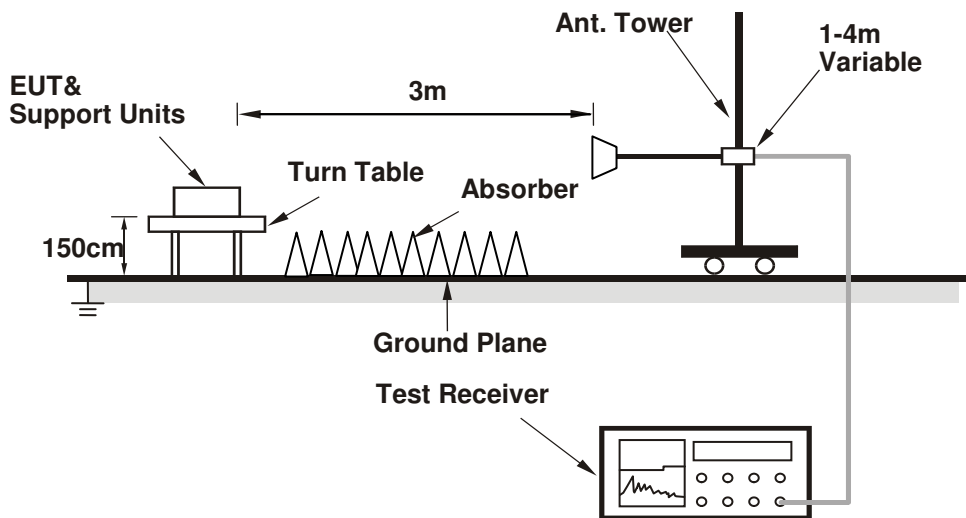

For the actual test configuration, please refer to the attached file (Test Setup Photo).

4.1.6 EUT Operating Conditions

- a. Placed the EUT on the testing table.
- b. Set the EUT under transmission condition continuously at specific channel frequency.



A O T

4.1.7 Test Results

ABOVE 1GHz DATA :

Mode A

EUT TEST CONDITION		MEASUREMENT DETAIL	
CHANNEL	Channel 0	FREQUENCY RANGE	1GHz ~ 25GHz
INPUT POWER	120Vac, 60 Hz	DETECTOR FUNCTION	Peak (PK) Average (AV)
ENVIRONMENTAL CONDITIONS	25deg. C, 65%RH	TESTED BY	Charles Hsiao

ANTENNA POLARITY & TEST DISTANCE: HORIZONTAL AT 3 M										
FREQ. (MHz)	EMISSION LEVEL (dBuV/m)	READ LEVEL (dBuV)	LIMIT (dBuV/m)	MARGIN (dB)	ANTENNA FACTOR (dB/m)	CABLE LOSS (dB)	PREAMP FACTOR (dB)	ANTENNA HEIGHT (cm)	TABLE ANGLE (Degree)	REMARK
2376	41.22	39.56	54	-12.78	31.78	5.37	35.49	101	65	Average
2376	55.85	54.19	74	-18.15	31.78	5.37	35.49	101	65	Peak
2402	93.24	91.51			31.8	5.4	35.47	101	65	Average
2402	94.24	92.51			31.8	5.4	35.47	101	65	Peak
2498	41.89	39.87	54	-12.11	31.9	5.53	35.41	101	65	Average
2498	56.12	54.1	74	-17.88	31.9	5.53	35.41	101	65	Peak

ANTENNA POLARITY & TEST DISTANCE: VERTICAL AT 3 M										
FREQ. (MHz)	EMISSION LEVEL (dBuV/m)	READ LEVEL (dBuV)	LIMIT (dBuV/m)	MARGIN (dB)	ANTENNA FACTOR (dB/m)	CABLE LOSS (dB)	PREAMP FACTOR (dB)	ANTENNA HEIGHT (cm)	TABLE ANGLE (Degree)	REMARK
2358	41.22	39.59	54	-12.78	31.76	5.37	35.5	102	276	Average
2358	56.1	54.47	74	-17.9	31.76	5.37	35.5	102	276	Peak
2402	91.62	89.89			31.8	5.4	35.47	102	276	Average
2402	92.64	90.91			31.8	5.4	35.47	102	276	Peak
2486	41.66	39.67	54	-12.34	31.88	5.53	35.42	102	276	Average
2486	56.2	54.21	74	-17.8	31.88	5.53	35.42	102	276	Peak

REMARKS:

- Emission Level = Read Level + Antenna Factor + Cable Loss - Preamp Factor
Margin value = Emission level – Limit value
- 2402MHz: Fundamental frequency.



A D T

EUT TEST CONDITION		MEASUREMENT DETAIL	
CHANNEL	Channel 19	FREQUENCY RANGE	1GHz ~ 25GHz
INPUT POWER	120Vac, 60 Hz	DETECTOR FUNCTION	Peak (PK) Average (AV)
ENVIRONMENTAL CONDITIONS	25deg. C, 65%RH	TESTED BY	Charles Hsiao

ANTENNA POLARITY & TEST DISTANCE: HORIZONTAL AT 3 M										
FREQ. (MHz)	EMISSION LEVEL (dBuV/m)	READ LEVEL (dBuV)	LIMIT (dBuV/m)	MARGIN (dB)	ANTENNA FACTOR (dB/m)	CABLE LOSS (dB)	PREAMP FACTOR (dB)	ANTENNA HEIGHT (cm)	TABLE ANGLE (Degree)	REMARK
2390	41.27	39.54	54	-12.73	31.8	5.4	35.47	101	181	Average
2390	56.02	54.29	74	-17.98	31.8	5.4	35.47	101	181	Peak
2440	94.35	92.5			31.85	5.46	35.46	101	181	Average
2440	95.38	93.53			31.85	5.46	35.46	101	181	Peak
2492	41.86	39.84	54	-12.14	31.9	5.53	35.41	101	181	Average
2492	55.34	53.32	74	-18.66	31.9	5.53	35.41	101	181	Peak
ANTENNA POLARITY & TEST DISTANCE: VERTICAL AT 3 M										
FREQ. (MHz)	EMISSION LEVEL (dBuV/m)	READ LEVEL (dBuV)	LIMIT (dBuV/m)	MARGIN (dB)	ANTENNA FACTOR (dB/m)	CABLE LOSS (dB)	PREAMP FACTOR (dB)	ANTENNA HEIGHT (cm)	TABLE ANGLE (Degree)	REMARK
2386	41.38	39.67	54	-12.62	31.8	5.4	35.49	102	276	Average
2386	56.84	55.13	74	-17.16	31.8	5.4	35.49	102	276	Peak
2440	92.41	90.56			31.85	5.46	35.46	102	276	Average
2440	93.55	91.7			31.85	5.46	35.46	102	276	Peak
2492	41.83	39.81	54	-12.17	31.9	5.53	35.41	102	276	Average
2492	56.39	54.37	74	-17.61	31.9	5.53	35.41	102	276	Peak

REMARKS:

- Emission Level = Read Level + Antenna Factor + Cable Loss - Preamp Factor
Margin value = Emission level – Limit value
- 2440MHz: Fundamental frequency.



A D T

EUT TEST CONDITION		MEASUREMENT DETAIL	
CHANNEL	Channel 39	FREQUENCY RANGE	1GHz ~ 25GHz
INPUT POWER	120Vac, 60 Hz	DETECTOR FUNCTION	Peak (PK) Average (AV)
ENVIRONMENTAL CONDITIONS	25deg. C, 65%RH	TESTED BY	Charles Hsiao

ANTENNA POLARITY & TEST DISTANCE: HORIZONTAL AT 3 M										
FREQ. (MHz)	EMISSION LEVEL (dBuV/m)	READ LEVEL (dBuV)	LIMIT (dBuV/m)	MARGIN (dB)	ANTENNA FACTOR (dB/m)	CABLE LOSS (dB)	PREAMP FACTOR (dB)	ANTENNA HEIGHT (cm)	TABLE ANGLE (Degree)	REMARK
2376	41.26	39.6	54	-12.74	31.78	5.37	35.49	112	186	Average
2376	56.32	54.66	74	-17.68	31.78	5.37	35.49	112	186	Peak
2480	93.38	91.42			31.88	5.5	35.42	112	186	Average
2480	94.38	92.42			31.88	5.5	35.42	112	186	Peak
2486	41.67	39.68	54	-12.33	31.88	5.53	35.42	112	186	Average
2486	56.54	54.55	74	-17.46	31.88	5.53	35.42	112	186	Peak
ANTENNA POLARITY & TEST DISTANCE: VERTICAL AT 3 M										
FREQ. (MHz)	EMISSION LEVEL (dBuV/m)	READ LEVEL (dBuV)	LIMIT (dBuV/m)	MARGIN (dB)	ANTENNA FACTOR (dB/m)	CABLE LOSS (dB)	PREAMP FACTOR (dB)	ANTENNA HEIGHT (cm)	TABLE ANGLE (Degree)	REMARK
2384	41.31	39.62	54	-12.69	31.78	5.4	35.49	102	160	Average
2384	55.35	53.66	74	-18.65	31.78	5.4	35.49	102	160	Peak
2480	91.51	89.55			31.88	5.5	35.42	102	160	Average
2480	92.59	90.63			31.88	5.5	35.42	102	160	Peak
2492	41.84	39.82	54	-12.16	31.9	5.53	35.41	102	160	Average
2492	56.27	54.25	74	-17.73	31.9	5.53	35.41	102	160	Peak

REMARKS:

- Emission Level = Read Level + Antenna Factor + Cable Loss - Preamp Factor
Margin value = Emission level – Limit value
- 2480MHz: Fundamental frequency.

**Mode B**

EUT TEST CONDITION		MEASUREMENT DETAIL	
CHANNEL	Channel 0	FREQUENCY RANGE	1GHz ~ 25GHz
INPUT POWER	120Vac, 60 Hz	DETECTOR FUNCTION	Peak (PK) Average (AV)
ENVIRONMENTAL CONDITIONS	25deg. C, 65%RH	TESTED BY	Charles Hsiao

ANTENNA POLARITY & TEST DISTANCE: HORIZONTAL AT 3 M

FREQ. (MHz)	EMISSION LEVEL (dBuV/m)	READ LEVEL (dBuV)	LIMIT (dBuV/m)	MARGIN (dB)	ANTENNA FACTOR (dB/m)	CABLE LOSS (dB)	PREAMP FACTOR (dB)	ANTENNA HEIGHT (cm)	TABLE ANGLE (Degree)	REMARK
2352	40.6	39.01	54	-13.4	31.76	5.33	35.5	103	157	Average
2352	55.46	53.87	74	-18.54	31.76	5.33	35.5	103	157	Peak
2402	93.1	91.37			31.8	5.4	35.47	103	157	Average
2402	94.09	92.36			31.8	5.4	35.47	103	157	Peak
2484	41.78	39.82	54	-12.22	31.88	5.5	35.42	103	157	Average
2484	55.36	53.4	74	-18.64	31.88	5.5	35.42	103	157	Peak

ANTENNA POLARITY & TEST DISTANCE: VERTICAL AT 3 M

FREQ. (MHz)	EMISSION LEVEL (dBuV/m)	READ LEVEL (dBuV)	LIMIT (dBuV/m)	MARGIN (dB)	ANTENNA FACTOR (dB/m)	CABLE LOSS (dB)	PREAMP FACTOR (dB)	ANTENNA HEIGHT (cm)	TABLE ANGLE (Degree)	REMARK
2368	40.63	38.99	54	-13.37	31.76	5.37	35.49	103	268	Average
2368	55.04	53.4	74	-18.96	31.76	5.37	35.49	103	268	Peak
2402	91.2	89.47			31.8	5.4	35.47	103	268	Average
2402	92.04	90.31			31.8	5.4	35.47	103	268	Peak
2488	41.53	39.52	54	-12.47	31.9	5.53	35.42	103	268	Average
2488	55.16	53.15	74	-18.84	31.9	5.53	35.42	103	268	Peak

REMARKS:

- Emission Level = Read Level + Antenna Factor + Cable Loss - Preamp Factor
Margin value = Emission level – Limit value
- 2402MHz: Fundamental frequency.

**BELOW 1GHz WORST-CASE DATA:****Mode A**

EUT TEST CONDITION		MEASUREMENT DETAIL	
CHANNEL	Channel 0	FREQUENCY RANGE	30MHz ~ 1GHz
INPUT POWER	120Vac, 60 Hz	DETECTOR FUNCTION	Peak (PK) Quasi-peak (QP)
ENVIRONMENTAL CONDITIONS	25deg. C, 65%RH	TESTED BY	Charles Hsiao

ANTENNA POLARITY & TEST DISTANCE: HORIZONTAL AT 3 M

FREQ. (MHz)	EMISSION LEVEL (dBuV/m)	READ LEVEL (dBuV)	LIMIT (dBuV/m)	MARGIN (dB)	ANTENNA FACTOR (dB/m)	CABLE LOSS (dB)	PREAMP FACTOR (dB)	ANTENNA HEIGHT (cm)	TABLE ANGLE (Degree)	REMARK
160.14	27.97	47.92	43.5	-15.53	10.8	1.52	32.27	106	114	Peak
206.85	35.61	55.06	43.5	-7.89	11.17	1.65	32.27	100	242	QP
264.9	28.22	44.94	46	-17.78	13.45	1.94	32.11	164	159	Peak
531	38.4	47.25	46	-7.6	20.61	2.7	32.16	156	38	Peak
708.8	33.67	39.47	46	-12.33	23.19	3.11	32.1	133	66	Peak
888	31.36	34.51	46	-14.64	24.92	3.49	31.56	188	249	Peak

ANTENNA POLARITY & TEST DISTANCE: VERTICAL AT 3 M

FREQ. (MHz)	EMISSION LEVEL (dBuV/m)	READ LEVEL (dBuV)	LIMIT (dBuV/m)	MARGIN (dB)	ANTENNA FACTOR (dB/m)	CABLE LOSS (dB)	PREAMP FACTOR (dB)	ANTENNA HEIGHT (cm)	TABLE ANGLE (Degree)	REMARK
138	31.68	53.28	43.5	-11.82	9.28	1.38	32.26	134	167	Peak
206.85	37.67	57.12	43.5	-5.83	11.17	1.65	32.27	100	218	QP
274.35	26.4	42.88	46	-19.6	13.7	1.94	32.12	127	351	Peak
441.4	30.04	41.82	46	-15.96	17.89	2.49	32.16	130	44	Peak
531	41.64	50.49	46	-4.36	20.61	2.7	32.16	141	264	Peak
708.1	37.46	43.26	46	-8.54	23.19	3.11	32.1	185	17	Peak

REMARKS: Emission Level = Read Level + Antenna Factor + Cable Loss - Preamp Factor

Margin value = Emission level – Limit value



A D T

Mode B

EUT TEST CONDITION		MEASUREMENT DETAIL	
CHANNEL	Channel 0	FREQUENCY RANGE	30MHz ~ 1GHz
INPUT POWER	120Vac, 60 Hz	DETECTOR FUNCTION	Peak (PK)
ENVIRONMENTAL CONDITIONS	25deg. C, 65%RH	TESTED BY	Charles Hsiao

ANTENNA POLARITY & TEST DISTANCE: HORIZONTAL AT 3 M										
FREQ. (MHz)	EMISSION LEVEL (dBuV/m)	READ LEVEL (dBuV)	LIMIT (dBuV/m)	MARGIN (dB)	ANTENNA FACTOR (dB/m)	CABLE LOSS (dB)	PREAMP FACTOR (dB)	ANTENNA HEIGHT (cm)	TABLE ANGLE (Degree)	REMARK
126.12	25.87	47.73	43.5	-17.63	9	1.38	32.24	126	121	Peak
188.76	34.03	54.27	43.5	-9.47	10.4	1.61	32.25	102	22	Peak
265.98	38.74	55.46	46	-7.26	13.45	1.94	32.11	133	338	Peak
533.1	38.2	47.1	46	-7.8	20.57	2.7	32.17	152	330	Peak
798.4	37.98	42.3	46	-8.02	24.42	3.32	32.06	137	197	Peak
854.4	31.63	35.95	46	-14.37	24	3.44	31.76	185	44	Peak
ANTENNA POLARITY & test distance: VERTICAL at 3 m										
FREQ. (MHz)	EMISSION LEVEL (dBuV/m)	READ LEVEL (dBuV)	LIMIT (dBuV/m)	MARGIN (dB)	ANTENNA FACTOR (dB/m)	CABLE LOSS (dB)	PREAMP FACTOR (dB)	ANTENNA HEIGHT (cm)	TABLE ANGLE (Degree)	REMARK
125.58	30.93	52.82	43.5	-12.57	8.97	1.38	32.24	130	129	Peak
192	33.81	54	43.5	-9.69	10.46	1.61	32.26	164	104	Peak
266.25	32.78	49.46	46	-13.22	13.49	1.94	32.11	109	194	Peak
531.7	39.12	48.01	46	-6.88	20.57	2.7	32.16	120	55	Peak
700.4	41.67	47.55	46	-4.33	23.1	3.11	32.09	134	349	Peak
799.8	39.68	43.82	46	-6.32	24.6	3.32	32.06	179	99	Peak

REMARKS: Emission Level = Read Level + Antenna Factor + Cable Loss - Preamp Factor
 Margin value = Emission level – Limit value



4.2 Conducted Emission Measurement

4.2.1 Limits of Conducted Emission Measurement

Frequency (MHz)	Conducted Limit (dBuV)	
	Quasi-peak	Average
0.15 - 0.5	66 - 56	56 - 46
0.50 - 5.0	56	46
5.0 - 30.0	60	50

4.2.2 Test Instruments

Description & Manufacturer	Model No.	Serial No.	Date Of Calibration	Due Date Of Calibration
Test Receiver ROHDE & SCHWARZ	ESCI	100613	Nov. 11, 2014	Nov. 10, 2015
RF signal cable Woken	5D-FB	Cable-HYC01-01	Dec. 26, 2014	Dec. 25, 2015
LISN ROHDE & SCHWARZ (EUT)	ESH3-Z5	835239/001	Mar. 02, 2015	Mar. 01, 2016
LISN ROHDE & SCHWARZ (Peripheral)	ESH3-Z5	100311	Jul. 24, 2015	Jul. 23, 2016
Software ADT	BV ADT_Cond_ V7.3.7.3	NA	NA	NA

- Note: 1. The calibration interval of the above test instruments is 12 months and the calibrations are traceable to NML/ROC and NIST/USA.
2. The test was performed in HwaYa Shielded Room 1.
3. The VCCI Site Registration No. is C-2040.

4.2.3 Test Procedures

- The EUT was placed 0.4 meters from the conducting wall of the shielded room with EUT being connected to the power mains through a line impedance stabilization network (LISN). Other support units were connected to the power mains through another LISN. The two LISNs provide 50 ohm/ 50uH of coupling impedance for the measuring instrument.
- Both lines of the power mains connected to the EUT were checked for maximum conducted interference.
- The frequency range from 150kHz to 30MHz was searched. Emission levels under (Limit - 20dB) was not recorded.

NOTE: All modes of operation were investigated and the worst-case emissions are reported.

4.2.4 Deviation from Test Standard

No deviation.

4.2.5 TEST SETUP

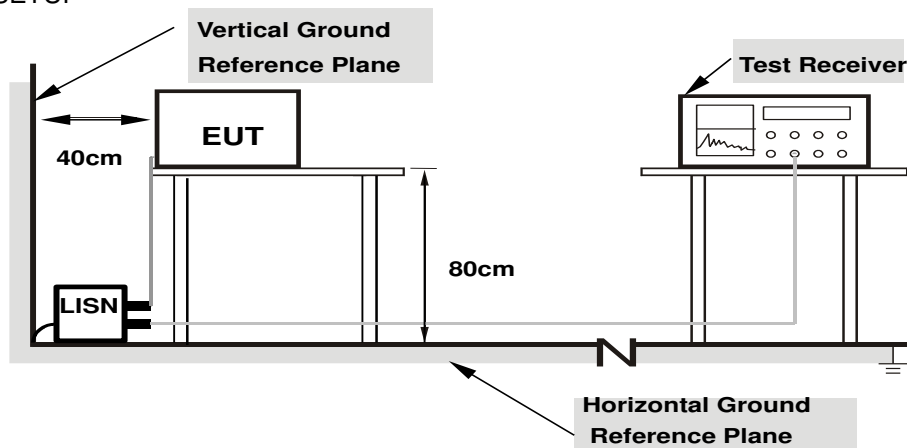

Note: 1.Support units were connected to second LISN.

2.Both of LISNs (AMN) are 80 cm from EUT and at least 80 from other units and other metal planes

4.2.6 EUT Operating Conditions

Same as 4.1.6.



A D T

4.2.7 Test Results

Mode A

CONDUCTED WORST-CASE DATA

Phase	Line (L)	Detector Function	Quasi-Peak (QP) / Average (AV)
-------	----------	-------------------	--------------------------------

No	Frequency (MHz)	Correction Factor (dB)	Reading Value (dBuV)		Emission Level (dBuV)		Limit (dBuV)		Margin (dB)	
			Q.P.	AV.	Q.P.	AV.	Q.P.	AV.	Q.P.	AV.
1	0.16564	0.05	37.59	13.02	37.64	13.07	65.18	55.18	-27.53	-42.10
2	0.20474	0.06	42.68	22.18	42.74	22.24	63.42	53.42	-20.68	-31.18
3	0.25948	0.06	37.16	21.09	37.22	21.15	61.45	51.45	-24.23	-30.30
4	0.38851	0.06	29.08	14.19	29.14	14.25	58.10	48.10	-28.96	-33.85
5	2.29659	0.13	25.85	14.62	25.98	14.75	56.00	46.00	-30.02	-31.25
6	4.27896	0.20	29.26	18.30	29.46	18.50	56.00	46.00	-26.54	-27.50

REMARKS:

1. Q.P. and AV. are abbreviations of quasi-peak and average individually.
2. The emission levels of other frequencies were very low against the limit.
3. Margin value = Emission level - Limit value
4. Correction factor = Insertion loss + Cable loss
5. Emission Level = Correction Factor + Reading Value.

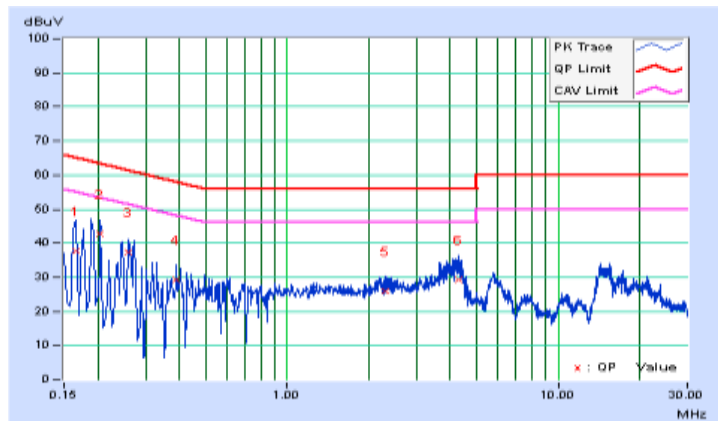



Phase	Neutral (N)	Detector Function	Quasi-Peak (QP) / Average (AV)
-------	-------------	-------------------	--------------------------------

No	Frequency (MHz)	Correction Factor (dB)	Reading Value (dBuV)		Emission Level (dBuV)		Limit (dBuV)		Margin (dB)	
			Q.P.	AV.	Q.P.	AV.	Q.P.	AV.	Q.P.	AV.
1	0.15391	0.05	39.28	23.79	39.33	23.84	65.79	55.79	-26.46	-31.95
2	0.18266	0.05	46.28	29.15	46.33	29.20	64.36	54.36	-18.03	-25.16
3	0.24384	0.05	37.99	22.40	38.04	22.45	61.96	51.96	-23.92	-29.51
4	0.31021	0.06	34.56	20.38	34.62	20.44	59.96	49.96	-25.35	-29.53
5	0.43543	0.06	30.24	17.01	30.30	17.07	57.15	47.15	-26.85	-30.08
6	0.90854	0.08	26.16	13.85	26.24	13.93	56.00	46.00	-29.76	-32.07

REMARKS:

1. Q.P. and AV. are abbreviations of quasi-peak and average individually.
2. The emission levels of other frequencies were very low against the limit.
3. Margin value = Emission level - Limit value
4. Correction factor = Insertion loss + Cable loss
5. Emission Level = Correction Factor + Reading Value.

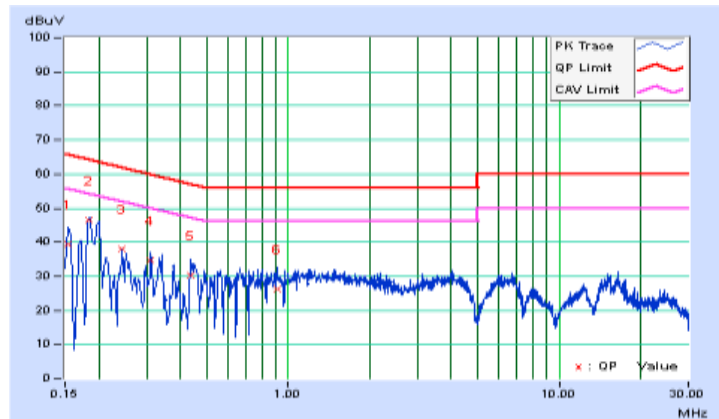



Mode B

CONDUCTED WORST-CASE DATA

Phase	Line (L)	Detector Function	Quasi-Peak (QP) / Average (AV)
-------	----------	-------------------	--------------------------------

No	Frequency (MHz)	Correction Factor (dB)	Reading Value (dBuV)		Emission Level (dBuV)		Limit (dBuV)		Margin (dB)	
			Q.P.	AV.	Q.P.	AV.	Q.P.	AV.	Q.P.	AV.
1	0.15000	0.05	48.13	34.04	48.18	34.09	66.00	56.00	-17.82	-21.91
2	0.16096	0.05	45.94	28.31	45.99	28.36	65.41	55.41	-19.42	-27.05
3	0.18910	0.06	41.39	26.14	41.45	26.20	64.08	54.08	-22.63	-27.88
4	0.27512	0.06	28.59	15.27	28.65	15.33	60.96	50.96	-32.31	-35.63
5	0.46669	0.06	25.42	17.43	25.48	17.49	56.57	46.57	-31.09	-29.08
6	3.72374	0.18	21.38	14.91	21.56	15.09	56.00	46.00	-34.44	-30.91

REMARKS:

1. Q.P. and AV. are abbreviations of quasi-peak and average individually.
2. The emission levels of other frequencies were very low against the limit.
3. Margin value = Emission level - Limit value
4. Correction factor = Insertion loss + Cable loss
5. Emission Level = Correction Factor + Reading Value.

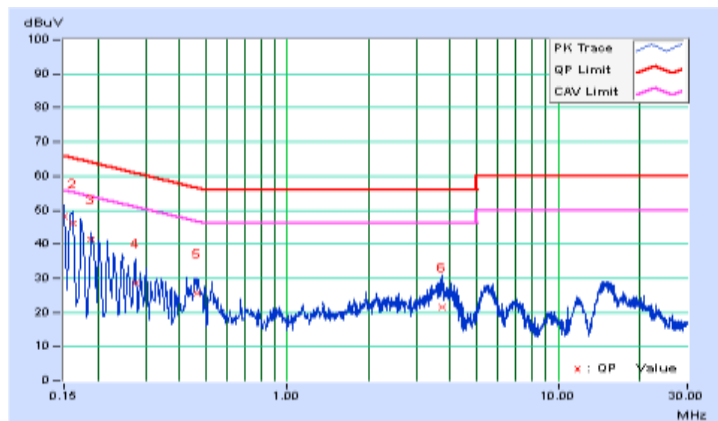



Phase	Neutral (N)	Detector Function	Quasi-Peak (QP) / Average (AV)
-------	-------------	-------------------	--------------------------------

No	Frequency (MHz)	Correction Factor (dB)	Reading Value (dBuV)		Emission Level (dBuV)		Limit (dBuV)		Margin (dB)	
			Q.P.	AV.	Q.P.	AV.	Q.P.	AV.	Q.P.	AV.
1	0.15000	0.05	47.83	32.68	47.88	32.73	66.00	56.00	-18.12	-23.27
2	0.16955	0.05	42.06	25.21	42.11	25.26	64.98	54.98	-22.87	-29.72
3	0.20458	0.05	37.52	21.60	37.57	21.65	63.42	53.42	-25.85	-31.77
4	0.27120	0.05	29.37	18.30	29.42	18.35	61.08	51.08	-31.66	-32.73
5	0.49799	0.06	26.96	20.27	27.02	20.33	56.03	46.03	-29.01	-25.70
6	0.70913	0.07	21.18	15.05	21.25	15.12	56.00	46.00	-34.75	-30.88

REMARKS:

1. Q.P. and AV. are abbreviations of quasi-peak and average individually.
2. The emission levels of other frequencies were very low against the limit.
3. Margin value = Emission level - Limit value
4. Correction factor = Insertion loss + Cable loss
5. Emission Level = Correction Factor + Reading Value.

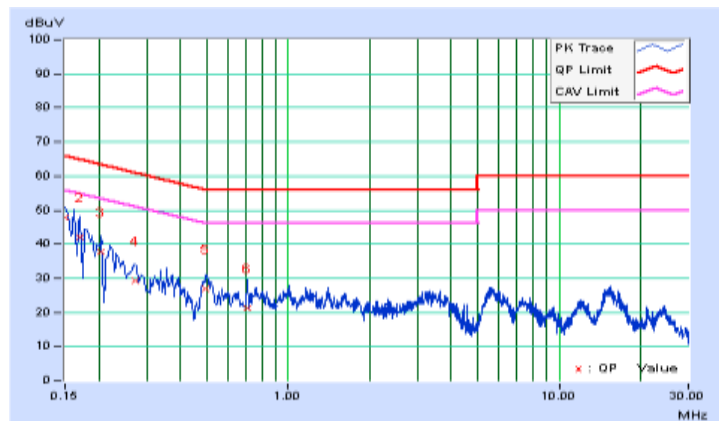

4.3 Conducted Output Power Measurement

4.3.1 Limits OF Conducted Output Power Measurement

For systems using digital modulation in the 2400–2483.5 MHz bands: 1 Watt (30dBm)

4.3.2 Test Setup

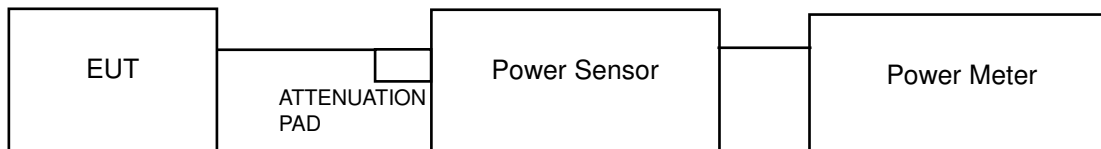

4.3.3 Test Instruments

Refer to section 4.1.2 to get information of above instrument.

4.3.4 Test Procedures

A peak / average power sensor was used on the output port of the EUT. A power meter was used to read the response of the peak / average power sensor. Record the power level.

4.3.5 Deviation from Test Standard

No deviation.

4.3.6 EUT Operating Conditions

Same as 4.3.6.



4.3.7 Test Results

Mode A

Channel	Frequency (MHz)	Peak Power (mW)	Peak Power (dBm)	Limit (dBm)	Pass / Fail
0	2402	0.731	-1.36	30	Pass
19	2440	0.845	-0.73	30	Pass
39	2480	0.873	-0.59	30	Pass

Mode B

Channel	Frequency (MHz)	Peak Power (mW)	Peak Power (dBm)	Limit (dBm)	Pass / Fail
0	2402	0.583	-2.34	30	Pass
19	2440	0.618	-2.09	30	Pass
39	2480	0.652	-1.86	30	Pass



5 Pictures of Test Arrangements

Please refer to the attached file (Test Setup Photo).



Appendix – Information on the Testing Laboratories

We, Bureau Veritas Consumer Products Services (H.K.) Ltd., Taoyuan Branch, were founded in 1988 to provide our best service in EMC, Radio, Telecom and Safety consultation. Our laboratories are accredited and approved according to ISO/IEC 17025.

If you have any comments, please feel free to contact us at the following:

Linko EMC/RF Lab

Tel: 886-2-26052180

Fax: 886-2-26051924

Hsin Chu EMC/RF Lab/Telecom Lab

Tel: 886-3-5935343

Fax: 886-3-5935342

Hwa Ya EMC/RF/Safety

Tel: 886-3-3183232

Fax: 886-3-3270892

Email: service.adt@tw.bureauveritas.com

Web Site: www.bureauveritas-adt.com

The address and road map of all our labs can be found in our web site also.

--- END ---