



# FCC SAR Test Report

Report No. : SA150722C27  
 Applicant : Compal Electronics Inc  
 Address : No.581, Ruiguang Rd., Neihu District, Taipei City, Taiwan 11492, R.O.C.  
 Product : Tablet Computer  
 FCC ID : GKR-TP00078A  
 Brand : Lenovo  
 Model No. : TP00078A  
 Standards : FCC 47 CFR Part 2 (2.1093) / IEEE C95.1:1992 / IEEE Std 1528:2013  
 KDB 865664 D01 v01r04 / KDB 865664 D02 v01r01  
 KDB 248227 D01 v02r01/ KDB 447498 D01 v05r02 / KDB 616217 D04 v01r01  
 Sample Received Date : Jul. 22, 2015  
 Date of Testing : Aug. 17, 2015 ~ Aug. 23, 2015

**CERTIFICATION:** The above equipment have been tested by **Bureau Veritas Consumer Products Services (H.K.) Ltd., Taoyuan Branch – Lin Kou Laboratories**, and found compliance with the requirement of the above standards. The test record, data evaluation & Equipment Under Test (EUT) configurations represented herein are true and accurate accounts of the measurements of the sample’s SAR characteristics under the conditions specified in this report. It should not be reproduced except in full, without the written approval of our laboratory. The client should not use it to claim product certification, approval, or endorsement by TAF or any government agencies.

Prepared By : Rona Chen  
 Rona Chen / Specialist

Approved By : Gordon Lin  
 Gordon Lin / Assistant Manager



This report is for your exclusive use. Any copying or replication of this report to or for any other person or entity, or use of our name or trademark, is permitted only with our prior written permission. This report sets forth our findings solely with respect to the test samples identified herein. The results set forth in this report are not indicative or representative of the quality or characteristics of the lot from which a test sample was taken or any similar or identical product unless specifically and expressly noted. Our report includes all of the tests requested by you and the results thereof based upon the information that you provided to us. You have 60 days from date of issuance of this report to notify us of any material error or omission caused by our negligence, provided, however, that such notice shall be in writing and shall specifically address the issue you wish to raise. A failure to raise such issue within the prescribed time shall constitute your unqualified acceptance of the completeness of this report, the tests conducted and the correctness of the report contents. Unless specific mention, the uncertainty of measurement has been explicitly taken into account to declare the compliance or non-compliance to the specification.



## Table of Contents

Release Control Record .....	3
1. Summary of Maximum SAR Value .....	4
2. Description of Equipment Under Test .....	5
3. SAR Measurement System .....	6
3.1 Definition of Specific Absorption Rate (SAR) .....	6
3.2 SPEAG DASY System .....	6
3.2.1 Robot.....	7
3.2.2 Probes.....	8
3.2.3 Data Acquisition Electronics (DAE) .....	8
3.2.4 Phantoms .....	9
3.2.5 Device Holder.....	10
3.2.6 System Validation Dipoles.....	10
3.2.7 Tissue Simulating Liquids.....	11
3.3 SAR System Verification .....	14
3.4 SAR Measurement Procedure .....	15
3.4.1 Area & Zoom Scan Procedure .....	15
3.4.2 Volume Scan Procedure.....	15
3.4.3 Power Drift Monitoring.....	16
3.4.4 Spatial Peak SAR Evaluation .....	16
3.4.5 SAR Averaged Methods .....	16
4. SAR Measurement Evaluation .....	17
4.1 EUT Configuration and Setting.....	17
4.2 EUT Testing Position .....	18
4.2.1 Body Exposure Conditions .....	18
4.2.2 SAR Test Exclusion Evaluations .....	20
4.3 Tissue Verification .....	22
4.4 System Validation.....	22
4.5 System Verification.....	23
4.6 Maximum Output Power.....	24
4.6.1 Maximum Conducted Power .....	24
4.6.2 Measured Conducted Power Result.....	27
4.7 SAR Testing Results .....	33
4.7.1 SAR Test Reduction Considerations .....	33
4.7.2 SAR Results for Body Exposure Condition (Separation Distance is 0 cm Gap) .....	34
4.7.3 SAR Measurement Variability.....	38
5. Calibration of Test Equipment.....	40
6. Measurement Uncertainty.....	41
7. Information on the Testing Laboratories.....	43
Appendix A. SAR Plots of System Verification	
Appendix B. SAR Plots of SAR Measurement	
Appendix C. Calibration Certificate for Probe and Dipole	
Appendix D. Photographs of EUT and Setup	



### Release Control Record

Report No.	Reason for Change	Date Issued
SA150722C27	Initial release	Aug. 26, 2015

# 1. Summary of Maximum SAR Value

EUT1 (Ant. Ethertronics)

Equipment Class	Mode	Tablet PC Highest Reported Body SAR1g (W/kg)	Laptop PC Highest Reported Body SAR1g (W/kg)
DTS	2.4G WLAN	0.27	0.03
NII	5.2G WLAN	0.40	0.08
	5.3G WLAN	0.38	0.06
	5.6G WLAN	0.45	0.07
	5.8G WLAN	0.70	0.11
DSS	Bluetooth	N/A	N/A

EUT 2 (Ant. HIGH-TEK)

Equipment Class	Mode	Tablet PC Highest Reported Body SAR1g (W/kg)	Laptop PC Highest Reported Body SAR1g (W/kg)
DTS	2.4G WLAN	0.66	0.07
NII	5.2G WLAN	0.93	0.12
	5.3G WLAN	0.86	0.13
	5.6G WLAN	0.75	0.12
	5.8G WLAN	1.10	0.17
DSS	Bluetooth	N/A	N/A

Highest Simultaneous Transmission SAR	Body SAR1g (W/kg)
DTS + DSS	0.71
NII + DSS	1.15

Note:

- The SAR limit (Head & Body: SAR<sub>1g</sub> 1.6 W/kg, Extremity: SAR<sub>10g</sub> 4.0 W/kg) for general population / uncontrolled exposure is specified in FCC 47 CFR part 2 (2.1093) and ANSI/IEEE C95.1-1992.



# FCC SAR Test Report

## 2. Description of Equipment Under Test

<b>EUT Type</b>	Tablet Computer
<b>FCC ID</b>	GKR-TP00078A
<b>Brand Name</b>	Lenovo
<b>Model Name</b>	TP00078A
<b>Tx Frequency Bands (Unit: MHz)</b>	WLAN : 2412 ~ 2462, 5180 ~ 5240, 5260 ~ 5320, 5500 ~ 5700, 5745 ~ 5825 Bluetooth : 2402 ~ 2480
<b>Uplink Modulations</b>	802.11b : DSSS 802.11a/g/n/ac : OFDM Bluetooth : GFSK, π/4-DQPSK, 8-DPSK
<b>Maximum Tune-up Conducted Power (Unit: dBm)</b>	Refer to section 4.6.1 of this report.
<b>Antenna Type</b>	PIFA Antenna
<b>EUT Stage</b>	Production Unit

### Note:

1. This EUT contains two samples listed as below.

Sample	Difference
EUT 1	Tablet computer with Antenna (Ethertronics Inc.)
EUT 2	Tablet computer with Antenna (HIGH-TEK)

2. The antenna information is listed as below.

Antenna Type	Brand Name	Parts Number	Antenna Gain	
			2.4GHz	5GHz
PIFA	Ethertronics Inc.	WLAN Main Antenna: 5002022 WLAN Aux. Antenna: 5002030	Main: 0.85 Aux.: -0.71	Main: 0.46 Aux.: 0.36
	HIGH-TEK	WLAN Main Antenna: DC33001RQ00 WLAN Aux. Antenna: DC33001RQ10	Main: -0.17 Aux.: -0.30	Main: 1.84 Aux.: 1.56

3. The above EUT information is declared by manufacturer and for more detailed features description please refers to the manufacturer's specifications or User's Manual.

### List of Accessory:

Battery	<b>Brand Name</b>	lenovo
	<b>Model Name</b>	SB10F46465
	<b>Power Rating</b>	15.2Vdc, 2.895Ah
	<b>Type</b>	Li-ion
WLAN Module	<b>Brand Name</b>	Broadcom
	<b>Model Name</b>	BCM94356Z

### **3. SAR Measurement System**

#### **3.1 Definition of Specific Absorption Rate (SAR)**

SAR is related to the rate at which energy is absorbed per unit mass in an object exposed to a radio field. The SAR distribution in a biological body is complicated and is usually carried out by experimental techniques or numerical modeling. The standard recommends limits for two tiers of groups, occupational/controlled and general population/uncontrolled, based on a person's awareness and ability to exercise control over his or her exposure. In general, occupational/controlled exposure limits are higher than the limits for general population/uncontrolled.

The SAR definition is the time derivative (rate) of the incremental energy (dW) absorbed by (dissipated in) an incremental mass (dm) contained in a volume element (dv) of a given density ( $\rho$ ). The equation description is as below:

$$\text{SAR} = \frac{d}{dt} \left( \frac{dW}{dm} \right) = \frac{d}{dt} \left( \frac{dW}{\rho dv} \right)$$

SAR is expressed in units of Watts per kilogram (W/kg)

SAR measurement can be related to the electrical field in the tissue by

$$\text{SAR} = \frac{\sigma |E|^2}{\rho}$$

Where:  $\sigma$  is the conductivity of the tissue,  $\rho$  is the mass density of the tissue and E is the RMS electrical field strength.

#### **3.2 SPEAG DASY System**

DASY system consists of high precision robot, probe alignment sensor, phantom, robot controller, controlled measurement server and near-field probe. The robot includes six axes that can move to the precision position of the DASY4/5 software defined. The DASY software can define the area that is detected by the probe. The robot is connected to controlled box. Controlled measurement server is connected to the controlled robot box. The DAE includes amplifier, signal multiplexing, AD converter, offset measurement and surface detection. It is connected to the Electro-optical coupler (ECO). The ECO performs the conversion from the optical into digital electric signal of the DAE and transfers data to the PC.



Fig-3.1 DASY System Setup

### 3.2.1 Robot

The DASY system uses the high precision robots from Stäubli SA (France). For the 6-axis controller system, the robot controller version (DASY4: CS7MB; DASY5: CS8c) from Stäubli is used. The Stäubli robot series have many features that are important for our application:

- High precision (repeatability  $\pm 0.035$  mm)
- High reliability (industrial design)
- Jerk-free straight movements
- Low ELF interference (the closed metallic construction shields against motor control fields)



Fig-3.2 DASY4





Fig-3.3 DASY5

# FCC SAR Test Report

## 3.2.2 Probes

The SAR measurement is conducted with the dosimetric probe. The probe is specially designed and calibrated for use in liquid with high permittivity. The dosimetric probe has special calibration in liquid at different frequency.

<b>Model</b>	EX3DV4	
<b>Construction</b>	Symmetrical design with triangular core. Built-in shielding against static charges. PEEK enclosure material (resistant to organic solvents, e.g., DGBE).	
<b>Frequency</b>	10 MHz to 6 GHz Linearity: $\pm 0.2$ dB	
<b>Directivity</b>	$\pm 0.3$ dB in HSL (rotation around probe axis) $\pm 0.5$ dB in tissue material (rotation normal to probe axis)	
<b>Dynamic Range</b>	10 $\mu$ W/g to 100 mW/g Linearity: $\pm 0.2$ dB (noise: typically $< 1$ $\mu$ W/g)	
<b>Dimensions</b>	Overall length: 337 mm (Tip: 20 mm) Tip diameter: 2.5 mm (Body: 12 mm) Typical distance from probe tip to dipole centers: 1 mm	

<b>Model</b>	ES3DV3	
<b>Construction</b>	Symmetrical design with triangular core. Interleaved sensors. Built-in shielding against static charges. PEEK enclosure material (resistant to organic solvents, e.g., DGBE).	
<b>Frequency</b>	10 MHz to 4 GHz Linearity: $\pm 0.2$ dB	
<b>Directivity</b>	$\pm 0.2$ dB in HSL (rotation around probe axis) $\pm 0.3$ dB in tissue material (rotation normal to probe axis)	
<b>Dynamic Range</b>	5 $\mu$ W/g to 100 mW/g Linearity: $\pm 0.2$ dB	
<b>Dimensions</b>	Overall length: 337 mm (Tip: 20 mm) Tip diameter: 3.9 mm (Body: 12 mm) Distance from probe tip to dipole centers: 2.0 mm	

## 3.2.3 Data Acquisition Electronics (DAE)

<b>Model</b>	DAE3, DAE4	
<b>Construction</b>	Signal amplifier, multiplexer, A/D converter and control logic. Serial optical link for communication with DASY embedded system (fully remote controlled). Two step probe touch detector for mechanical surface detection and emergency robot stop.	
<b>Measurement Range</b>	-100 to +300 mV (16 bit resolution and two range settings: 4mV, 400mV)	
<b>Input Offset Voltage</b>	$< 5$ $\mu$ V (with auto zero)	
<b>Input Bias Current</b>	$< 50$ fA	
<b>Dimensions</b>	60 x 60 x 68 mm	



# FCC SAR Test Report

## 3.2.4 Phantoms

<b>Model</b>	Twin SAM	
<b>Construction</b>	The shell corresponds to the specifications of the Specific Anthropomorphic Mannequin (SAM) phantom defined in IEEE 1528 and IEC 62209-1. It enables the dosimetric evaluation of left and right hand phone usage as well as body mounted usage at the flat phantom region. A cover prevents evaporation of the liquid. Reference markings on the phantom allow the complete setup of all predefined phantom positions and measurement grids by teaching three points with the robot.	
<b>Material</b>	Vinylester, glass fiber reinforced (VE-GF)	
<b>Shell Thickness</b>	2 ± 0.2 mm (6 ± 0.2 mm at ear point)	
<b>Dimensions</b>	Length: 1000 mm Width: 500 mm Height: adjustable feet	
<b>Filling Volume</b>	approx. 25 liters	

<b>Model</b>	ELI	
<b>Construction</b>	Phantom for compliance testing of handheld and body-mounted wireless devices in the frequency range of 30 MHz to 6 GHz. ELI is fully compatible with the IEC 62209-2 standard and all known tissue simulating liquids. ELI has been optimized regarding its performance and can be integrated into our standard phantom tables. A cover prevents evaporation of the liquid. Reference markings on the phantom allow installation of the complete setup, including all predefined phantom positions and measurement grids, by teaching three points. The phantom is compatible with all SPEAG dosimetric probes and dipoles.	
<b>Material</b>	Vinylester, glass fiber reinforced (VE-GF)	
<b>Shell Thickness</b>	2.0 ± 0.2 mm (bottom plate)	
<b>Dimensions</b>	Major axis: 600 mm Minor axis: 400 mm	
<b>Filling Volume</b>	approx. 30 liters	

# FCC SAR Test Report

## 3.2.5 Device Holder

<b>Model</b>	Mounting Device	
<b>Construction</b>	In combination with the Twin SAM Phantom or ELI4, the Mounting Device enables the rotation of the mounted transmitter device in spherical coordinates. Rotation point is the ear opening point. Transmitter devices can be easily and accurately positioned according to IEC, IEEE, FCC or other specifications. The device holder can be locked for positioning at different phantom sections (left head, right head, flat).	
<b>Material</b>	POM	

<b>Model</b>	Laptop Extensions Kit	
<b>Construction</b>	Simple but effective and easy-to-use extension for Mounting Device that facilitates the testing of larger devices according to IEC 62209-2 (e.g., laptops, cameras, etc.). It is lightweight and fits easily on the upper part of the Mounting Device in place of the phone positioner.	
<b>Material</b>	POM, Acrylic glass, Foam	

## 3.2.6 System Validation Dipoles

<b>Model</b>	D-Serial	
<b>Construction</b>	Symmetrical dipole with 1/4 balun. Enables measurement of feed point impedance with NWA. Matched for use near flat phantoms filled with tissue simulating solutions.	
<b>Frequency</b>	750 MHz to 5800 MHz	
<b>Return Loss</b>	> 20 dB	
<b>Power Capability</b>	> 100 W (f < 1GHz), > 40 W (f > 1GHz)	

# FCC SAR Test Report

## 3.2.7 Tissue Simulating Liquids

For SAR measurement of the field distribution inside the phantom, the phantom must be filled with homogeneous tissue simulating liquid to a depth of at least 15 cm. For head SAR testing, the liquid height from the ear reference point (ERP) of the phantom to the liquid top surface is larger than 15 cm. For body SAR testing, the liquid height from the center of the flat phantom to the liquid top surface is larger than 15 cm. The nominal dielectric values of the tissue simulating liquids in the phantom and the tolerance of 5% are listed in Table-3.1.

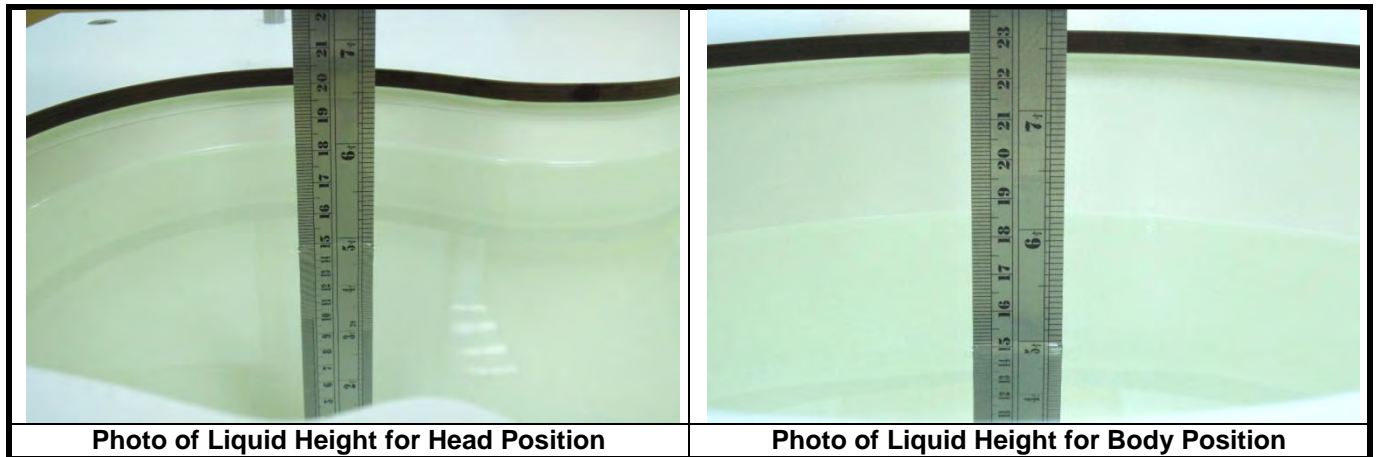

The dielectric properties of the head tissue simulating liquids are defined in IEEE 1528, and KDB 865664 D01 Appendix A. For the body tissue simulating liquids, the dielectric properties are defined in KDB 865664 D01 Appendix A. The dielectric properties of the tissue simulating liquids were verified prior to the SAR evaluation using a dielectric assessment kit and a network analyzer.



# FCC SAR Test Report

**Table-3.1 Targets of Tissue Simulating Liquid**

Frequency (MHz)	Target Permittivity	Range of $\pm 5\%$	Target Conductivity	Range of $\pm 5\%$
<b>For Head</b>				
750	41.9	39.8 ~ 44.0	0.89	0.85 ~ 0.93
835	41.5	39.4 ~ 43.6	0.90	0.86 ~ 0.95
900	41.5	39.4 ~ 43.6	0.97	0.92 ~ 1.02
1450	40.5	38.5 ~ 42.5	1.20	1.14 ~ 1.26
1640	40.3	38.3 ~ 42.3	1.29	1.23 ~ 1.35
1750	40.1	38.1 ~ 42.1	1.37	1.30 ~ 1.44
1800	40.0	38.0 ~ 42.0	1.40	1.33 ~ 1.47
1900	40.0	38.0 ~ 42.0	1.40	1.33 ~ 1.47
2000	40.0	38.0 ~ 42.0	1.40	1.33 ~ 1.47
2300	39.5	37.5 ~ 41.5	1.67	1.59 ~ 1.75
2450	39.2	37.2 ~ 41.2	1.80	1.71 ~ 1.89
2600	39.0	37.1 ~ 41.0	1.96	1.86 ~ 2.06
3500	37.9	36.0 ~ 39.8	2.91	2.76 ~ 3.06
5200	36.0	34.2 ~ 37.8	4.66	4.43 ~ 4.89
5300	35.9	34.1 ~ 37.7	4.76	4.52 ~ 5.00
5500	35.6	33.8 ~ 37.4	4.96	4.71 ~ 5.21
5600	35.5	33.7 ~ 37.3	5.07	4.82 ~ 5.32
5800	35.3	33.5 ~ 37.1	5.27	5.01 ~ 5.53
<b>For Body</b>				
750	55.5	52.7 ~ 58.3	0.96	0.91 ~ 1.01
835	55.2	52.4 ~ 58.0	0.97	0.92 ~ 1.02
900	55.0	52.3 ~ 57.8	1.05	1.00 ~ 1.10
1450	54.0	51.3 ~ 56.7	1.30	1.24 ~ 1.37
1640	53.8	51.1 ~ 56.5	1.40	1.33 ~ 1.47
1750	53.4	50.7 ~ 56.1	1.49	1.42 ~ 1.56
1800	53.3	50.6 ~ 56.0	1.52	1.44 ~ 1.60
1900	53.3	50.6 ~ 56.0	1.52	1.44 ~ 1.60
2000	53.3	50.6 ~ 56.0	1.52	1.44 ~ 1.60
2300	52.9	50.3 ~ 55.5	1.81	1.72 ~ 1.90
2450	52.7	50.1 ~ 55.3	1.95	1.85 ~ 2.05
2600	52.5	49.9 ~ 55.1	2.16	2.05 ~ 2.27
3500	51.3	48.7 ~ 53.9	3.31	3.14 ~ 3.48
5200	49.0	46.6 ~ 51.5	5.30	5.04 ~ 5.57
5300	48.9	46.5 ~ 51.3	5.42	5.15 ~ 5.69
5500	48.6	46.2 ~ 51.0	5.65	5.37 ~ 5.93
5600	48.5	46.1 ~ 50.9	5.77	5.48 ~ 6.06
5800	48.2	45.8 ~ 50.6	6.00	5.70 ~ 6.30



The following table gives the recipes for tissue simulating liquids.

Table-3.2 Recipes of Tissue Simulating Liquid

Tissue Type	Bactericide	DGBE	HEC	NaCl	Sucrose	Triton X-100	Water	Diethylene Glycol Mono-hexylether
H750	0.2	-	0.2	1.5	56.0	-	42.1	-
H835	0.2	-	0.2	1.5	57.0	-	41.1	-
H900	0.2	-	0.2	1.4	58.0	-	40.2	-
H1450	-	43.3	-	0.6	-	-	56.1	-
H1640	-	45.8	-	0.5	-	-	53.7	-
H1750	-	47.0	-	0.4	-	-	52.6	-
H1800	-	44.5	-	0.3	-	-	55.2	-
H1900	-	44.5	-	0.2	-	-	55.3	-
H2000	-	44.5	-	0.1	-	-	55.4	-
H2300	-	44.9	-	0.1	-	-	55.0	-
H2450	-	45.0	-	0.1	-	-	54.9	-
H2600	-	45.1	-	0.1	-	-	54.8	-
H3500	-	8.0	-	0.2	-	20.0	71.8	-
H5G	-	-	-	-	-	17.2	65.5	17.3
B750	0.2	-	0.2	0.8	48.8	-	50.0	-
B835	0.2	-	0.2	0.9	48.5	-	50.2	-
B900	0.2	-	0.2	0.9	48.2	-	50.5	-
B1450	-	34.0	-	0.3	-	-	65.7	-
B1640	-	32.5	-	0.3	-	-	67.2	-
B1750	-	31.0	-	0.2	-	-	68.8	-
B1800	-	29.5	-	0.4	-	-	70.1	-
B1900	-	29.5	-	0.3	-	-	70.2	-
B2000	-	30.0	-	0.2	-	-	69.8	-
B2300	-	31.0	-	0.1	-	-	68.9	-
B2450	-	31.4	-	0.1	-	-	68.5	-
B2600	-	31.8	-	0.1	-	-	68.1	-
B3500	-	28.8	-	0.1	-	-	71.1	-
B5G	-	-	-	-	-	10.7	78.6	10.7

### 3.3 SAR System Verification

The system check verifies that the system operates within its specifications. It is performed daily or before every SAR measurement. The system check uses normal SAR measurements in the flat section of the phantom with a matched dipole at a specified distance. The system verification setup is shown as below.

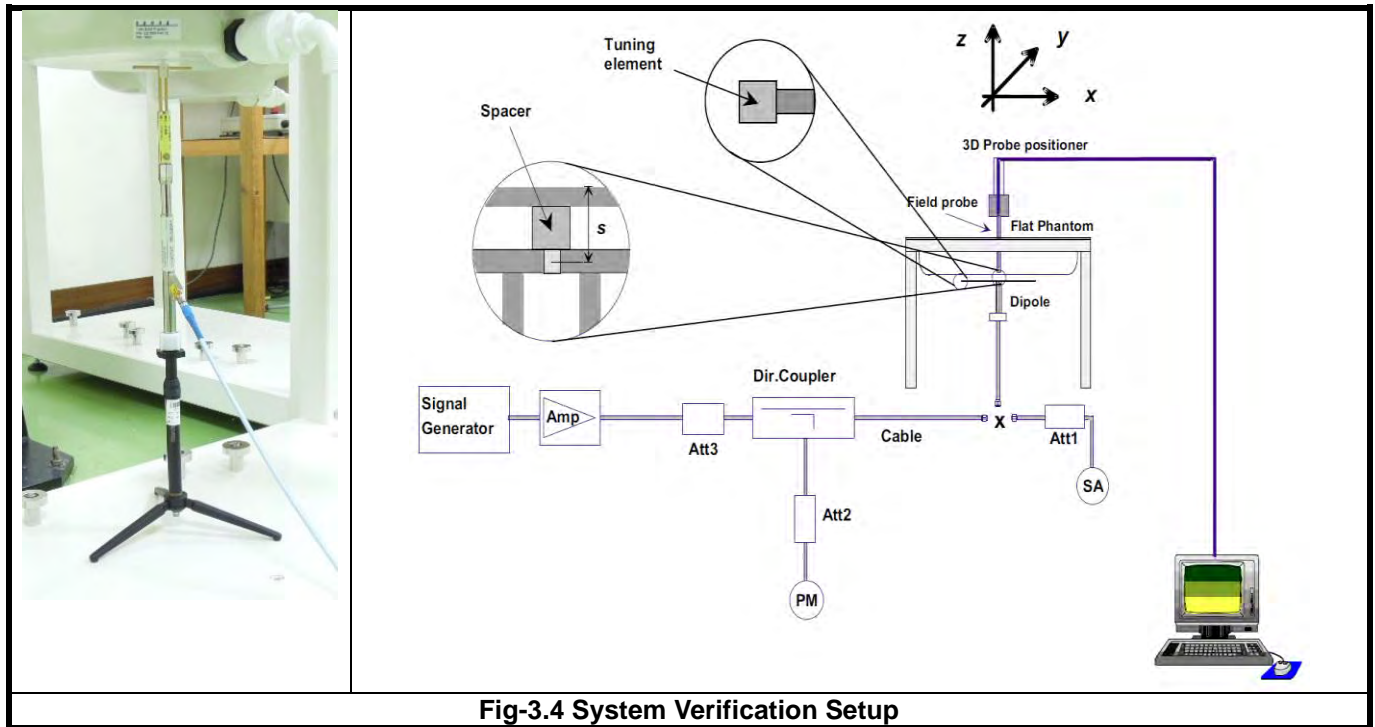

**Fig-3.4 System Verification Setup**

The validation dipole is placed beneath the flat phantom with the specific spacer in place. The distance spacer is touch the phantom surface with a light pressure at the reference marking and be oriented parallel to the long side of the phantom. The spectrum analyzer measures the forward power at the location of the system check dipole connector. The signal generator is adjusted for the desired forward power (250 mW is used for 700 MHz to 3 GHz, 100 mW is used for 3.5 GHz to 6 GHz) at the dipole connector and the power meter is read at that level. After connecting the cable to the dipole, the signal generator is readjusted for the same reading at power meter.

After system check testing, the SAR result will be normalized to 1W forward input power and compared with the reference SAR value derived from validation dipole certificate report. The deviation of system check should be within 10 %.

### 3.4 SAR Measurement Procedure

According to the SAR test standard, the recommended procedure for assessing the peak spatial-average SAR value consists of the following steps:

- (a) Power reference measurement
- (b) Area scan
- (c) Zoom scan
- (d) Power drift measurement

The SAR measurement procedures for each of test conditions are as follows:

- (a) Make EUT to transmit maximum output power
- (b) Measure conducted output power through RF cable
- (c) Place the EUT in the specific position of phantom
- (d) Perform SAR testing steps on the DASY system
- (e) Record the SAR value

#### 3.4.1 Area & Zoom Scan Procedure

First Area Scan is used to locate the approximate location(s) of the local peak SAR value(s). The measurement grid within an Area Scan is defined by the grid extent, grid step size and grid offset. Next, in order to determine the EM field distribution in a three-dimensional spatial extension, Zoom Scan is required. The Zoom Scan is performed around the highest E-field value to determine the averaged SAR-distribution over 10 g. According to KDB 865664 D01, the resolution for Area and Zoom scan is specified in the table below.

Items	<= 2 GHz	2-3 GHz	3-4 GHz	4-5 GHz	5-6 GHz
Area Scan ( $\Delta x, \Delta y$ )	<= 15 mm	<= 12 mm	<= 12 mm	<= 10 mm	<= 10 mm
Zoom Scan ( $\Delta x, \Delta y$ )	<= 8 mm	<= 5 mm	<= 5 mm	<= 4 mm	<= 4 mm
Zoom Scan ( $\Delta z$ )	<= 5 mm	<= 5 mm	<= 4 mm	<= 3 mm	<= 2 mm
Zoom Scan Volume	>= 30 mm	>= 30 mm	>= 28 mm	>= 25 mm	>= 22 mm

**Note:**

When zoom scan is required and report SAR is <= 1.4 W/kg, the zoom scan resolution of  $\Delta x / \Delta y$  (2-3GHz: <= 8 mm, 3-4GHz: <= 7 mm, 4-6GHz: <= 5 mm) may be applied.

#### 3.4.2 Volume Scan Procedure

The volume scan is used for assess overlapping SAR distributions for antennas transmitting in different frequency bands. It is equivalent to an oversized zoom scan used in standalone measurements. The measurement volume will be used to enclose all the simultaneous transmitting antennas. For antennas transmitting simultaneously in different frequency bands, the volume scan is measured separately in each frequency band. In order to sum correctly to compute the 1g aggregate SAR, the EUT remain in the same test position for all measurements and all volume scan use the same spatial resolution and grid spacing. When all volume scan were completed, the software, SEMCAD postprocessor can combine and subsequently superpose these measurement data to calculating the multiband SAR.

## FCC SAR Test Report

---

### 3.4.3 Power Drift Monitoring

All SAR testing is under the EUT install full charged battery and transmit maximum output power. In DASY measurement software, the power reference measurement and power drift measurement procedures are used for monitoring the power drift of EUT during SAR test. Both these procedures measure the field at a specified reference position before and after the SAR testing. The software will calculate the field difference in dB. If the power drift more than 5%, the SAR will be retested.

### 3.4.4 Spatial Peak SAR Evaluation

The procedure for spatial peak SAR evaluation has been implemented according to the test standard. It can be conducted for 1g and 10g, as well as for user-specific masses. The DASY software includes all numerical procedures necessary to evaluate the spatial peak SAR value.

The base for the evaluation is a "cube" measurement. The measured volume must include the 1g and 10g cubes with the highest averaged SAR values. For that purpose, the center of the measured volume is aligned to the interpolated peak SAR value of a previously performed area scan.

The entire evaluation of the spatial peak values is performed within the post-processing engine (SEMCAD). The system always gives the maximum values for the 1g and 10g cubes. The algorithm to find the cube with highest averaged SAR is divided into the following stages:

- (a) Extraction of the measured data (grid and values) from the Zoom Scan
- (b) Calculation of the SAR value at every measurement point based on all stored data (A/D values and measurement parameters)
- (c) Generation of a high-resolution mesh within the measured volume
- (d) Interpolation of all measured values from the measurement grid to the high-resolution grid
- (e) Extrapolation of the entire 3-D field distribution to the phantom surface over the distance from sensor to surface
- (f) Calculation of the averaged SAR within masses of 1g and 10g

### 3.4.5 SAR Averaged Methods

In DASY, the interpolation and extrapolation are both based on the modified Quadratic Shepard's method. The interpolation scheme combines a least-square fitted function method and a weighted average method which are the two basic types of computational interpolation and approximation.

Extrapolation routines are used to obtain SAR values between the lowest measurement points and the inner phantom surface. The extrapolation distance is determined by the surface detection distance and the probe sensor offset. The uncertainty increases with the extrapolation distance. To keep the uncertainty within 1% for the 1 g and 10 g cubes, the extrapolation distance should not be larger than 5 mm.



## **4. SAR Measurement Evaluation**

### **4.1 EUT Configuration and Setting**

#### **<Considerations Related to WLAN for Setup and Testing>**

In general, various vendor specific external test software and chipset based internal test modes are typically used for SAR measurement. These chipset based test mode utilities are generally hardware and manufacturer dependent, and often include substantial flexibility to reconfigure or reprogram a device. A Wi-Fi device must be configured to transmit continuously at the required data rate, channel bandwidth and signal modulation, using the highest transmission duty factor supported by the test mode tools for SAR measurement. The test frequencies established using test mode must correspond to the actual channel frequencies. When 802.11 frame gaps are accounted for in the transmission, a maximum transmission duty factor of 92 - 96% is typically achievable in most test mode configurations. A minimum transmission duty factor of 85% is required to avoid certain hardware and device implementation issues related to wide range SAR scaling. In addition, a periodic transmission duty factor is required for current generation SAR systems to measure SAR correctly. The reported SAR must be scaled to 100% transmission duty factor to determine compliance at the maximum tune-up tolerance limit.

According to KDB 248227 D01, this device has installed WLAN engineering testing software which can provide continuous transmitting RF signal. During WLAN SAR testing, this device was operated to transmit continuously at the maximum transmission duty with specified transmission mode, operating frequency, lowest data rate, and maximum output power.

#### **Initial Test Configuration**

An initial test configuration is determined for OFDM transmission modes in 2.4 GHz and 5 GHz bands according to the channel bandwidth, modulation and data rate combination(s) with the highest maximum output power specified for production units in each standalone and aggregated frequency band. When the same maximum power is specified for multiple transmission modes in a frequency band, the largest channel bandwidth, lowest order modulation, lowest data rate and lowest order 802.11a/g/n/ac mode is used for SAR measurement, on the highest measured output power channel in the initial test configuration, for each frequency band.

#### **Subsequent Test Configuration**

SAR measurement requirements for the remaining 802.11 transmission mode configurations that have not been tested in the initial test configuration are determined separately for each standalone and aggregated frequency band, in each exposure condition, according to the maximum output power specified for production units. Additional power measurements may be required to determine if SAR measurements are required for subsequent highest output power channels in a subsequent test configuration. When the highest reported SAR for the initial test configuration according to the initial test position or fixed exposure position requirements, is adjusted by the ratio of the subsequent test configuration to initial test configuration specified maximum output power and the adjusted SAR is  $\leq 1.2$  W/kg, SAR is not required for that subsequent test configuration.

## FCC SAR Test Report

### SAR Test Configuration and Channel Selection

When multiple channel bandwidth configurations in a frequency band have the same specified maximum output power, the initial test configuration is using largest channel bandwidth, lowest order modulation, lowest data rate, and lowest order 802.11 mode (i.e., 802.11a is chosen over 802.11n then 802.11ac or 802.11g is chosen over 802.11n). After an initial test configuration is determined, if multiple test channels have the same measured maximum output power, the channel chosen for SAR measurement is determined according to the following.

- 1) The channel closest to mid-band frequency is selected for SAR measurement.
- 2) For channels with equal separation from mid-band frequency; for example, high and low channels or two mid-band channels, the higher frequency (number) channel is selected for SAR measurement.

### Test Reduction for U-NII-1 (5.2 GHz) and U-NII-2A (5.3 GHz) Bands

For devices that operate in both U-NII bands using the same transmitter and antenna(s), SAR test reduction is determined according to the following.

- 1) When the same maximum output power is specified for both bands, begin SAR measurement in U-NII-2A band by applying the OFDM SAR requirements. If the highest reported SAR for a test configuration is  $\leq 1.2$  W/kg, SAR is not required for U-NII-1 band for that configuration (802.11 mode and exposure condition).
- 2) When different maximum output power is specified for the bands, begin SAR measurement in the band with higher specified maximum output power. The highest reported SAR for the tested configuration is adjusted by the ratio of lower to higher specified maximum output power for the two bands. When the adjusted SAR is  $\leq 1.2$  W/kg, SAR is not required for the band with lower maximum output power in that test configuration.

## 4.2 EUT Testing Position

### 4.2.1 Body Exposure Conditions

For laptop PC, according to KDB 616217 D04, SAR evaluation is required for the bottom surface of the keyboard. This EUT was tested in the base of EUT directly against the flat phantom. The required minimum test separation distance for incorporating transmitters and antennas into laptop computer display is determined with the display screen opened at an angle of  $90^\circ$  to the keyboard compartment.

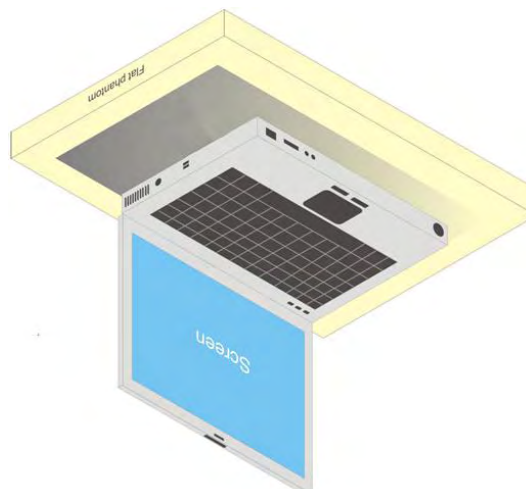
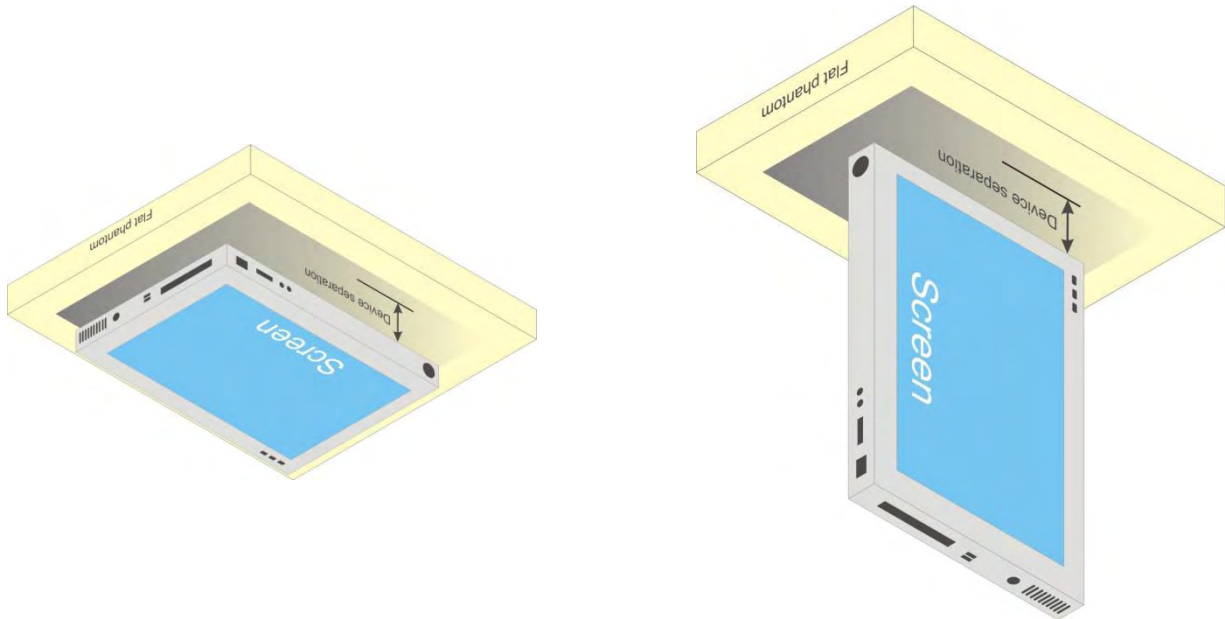

Fig-4.1 Illustration for Laptop Setup

## FCC SAR Test Report

For full-size tablet, according to KDB 616217 D04, SAR evaluation is required for back surface and edges of the devices. The back surface and edges of the tablet are tested with the tablet touching the phantom. Exposures from antennas through the front surface of the display section of a tablet are generally limited to the user's hands. Exposures to hands for typical consumer transmitters used in tablets are not expected to exceed the extremity SAR limit; therefore, SAR evaluation for the front surface of tablet display screens are generally not necessary. When voice mode is supported on a tablet and it is limited to speaker mode or headset operations only, additional SAR testing for this type of voice use is not required.



**Fig-4.2 Illustration for Tablet Setup**

# FCC SAR Test Report

## 4.2.2 SAR Test Exclusion Evaluations

According to KDB 447498 D01, the SAR test exclusion condition is based on source-based time-averaged maximum conducted output power, adjusted for tune-up tolerance, and the minimum test separation distance required for the exposure conditions. The SAR exclusion threshold is determined by the following formula.

1. For the test separation distance  $\leq 50$  mm

$$\frac{\text{Max. Tune up Power}_{(mW)}}{\text{Min. Test Separation Distance}_{(mm)}} \times \sqrt{f_{(GHz)}} \leq 3.0 \text{ for SAR-1g, } \leq 7.5 \text{ for SAR-10g}$$

When the minimum test separation distance is  $< 5$  mm, a distance of 5 mm is applied to determine SAR test exclusion.

2. For the test separation distance  $> 50$  mm, and the frequency at 100 MHz to 1500 MHz

$$\left[ (\text{Threshold at 50 mm in Step 1}) + (\text{Test Separation Distance} - 50 \text{ mm}) \times \left( \frac{f_{(MHz)}}{150} \right) \right]_{(mW)}$$

3. For the test separation distance  $> 50$  mm, and the frequency at  $> 1500$  MHz to 6 GHz

$$[(\text{Threshold at 50 mm in Step 1}) + (\text{Test Separation Distance} - 50 \text{ mm}) \times 10]_{(mW)}$$

### EUT 1 (Ant. Ethertronic)

<For BT/WLAN Ant-0>

Mode	Max. Tune-up Power (dBm)	Max. Tune-up Power (mW)	Rear Face			Left Side			Right Side			Top Side			Bottom Side		
			Ant. to Surface (mm)	Calculated Result	Require SAR Testing?	Ant. to Surface (mm)	Calculated Result	Require SAR Testing?	Ant. to Surface (mm)	Calculated Result	Require SAR Testing?	Ant. to Surface (mm)	Calculated Result	Require SAR Testing?	Ant. to Surface (mm)	Calculated Result	Require SAR Testing?
WLAN 2.4G	20.5	112.20	5	35.2	YES	90	496 mW	No	191.45	1510 mW	No	5	35.2	YES	210.73	1703 mW	No
WLAN 5.2G	20.5	112.20	5	51.4	YES	90	466 mW	No	191.45	1480 mW	No	5	51.4	YES	210.73	1673 mW	No
WLAN 5.3G	20.5	112.20	5	51.8	YES	90	465 mW	No	191.45	1480 mW	No	5	51.8	YES	210.73	1672 mW	No
WLAN 5.6G	20.5	112.20	5	53.6	YES	90	463 mW	No	191.45	1477 mW	No	5	53.6	YES	210.73	1670 mW	No
WLAN 5.8G	19.0	79.43	5	38.3	YES	90	462 mW	No	191.45	1477 mW	No	5	38.3	YES	210.73	1669 mW	No
BT	1.0	1.00	5	0.4	No	90	495 mW	No	191.45	1510 mW	No	5	0.4	No	210.73	1703 mW	No

<For WLAN Ant-1>

Mode	Max. Tune-up Power (dBm)	Max. Tune-up Power (mW)	Rear Face			Left Side			Right Side			Top Side			Bottom Side		
			Ant. to Surface (mm)	Calculated Result	Require SAR Testing?	Ant. to Surface (mm)	Calculated Result	Require SAR Testing?	Ant. to Surface (mm)	Calculated Result	Require SAR Testing?	Ant. to Surface (mm)	Calculated Result	Require SAR Testing?	Ant. to Surface (mm)	Calculated Result	Require SAR Testing?
WLAN 2.4G	20.5	112.20	5	35.2	YES	6.45	27.3	YES	290	2496 mW	No	5	35.2	YES	210.73	1703 mW	No
WLAN 5.2G	20.5	112.20	5	51.4	YES	6.45	39.8	YES	290	2466 mW	No	5	51.4	YES	210.73	1673 mW	No
WLAN 5.3G	20.5	112.20	5	51.8	YES	6.45	40.1	YES	290	2465 mW	No	5	51.8	YES	210.73	1672 mW	No
WLAN 5.6G	20.5	112.20	5	53.6	YES	6.45	41.5	YES	290	2463 mW	No	5	53.6	YES	210.73	1670 mW	No
WLAN 5.8G	19.0	79.43	5	38.3	YES	6.45	29.7	YES	290	2462 mW	No	5	38.3	YES	210.73	1669 mW	No



# FCC SAR Test Report

## <For WLAN Ant-0 + Ant-1>

Mode	Max. Tune-up Power (dBm)	Max. Tune-up Power (mW)	Rear Face			Left Side			Right Side			Top Side			Bottom Side		
			Ant. to Surface (mm)	Calculated Result	Require SAR Testing?	Ant. to Surface (mm)	Calculated Result	Require SAR Testing?	Ant. to Surface (mm)	Calculated Result	Require SAR Testing?	Ant. to Surface (mm)	Calculated Result	Require SAR Testing?	Ant. to Surface (mm)	Calculated Result	Require SAR Testing?
WLAN 2.4G	22.5	177.83	5	55.8	YES	6.45	43.3	YES	191.45	1510 mW	No	5	55.8	YES	210.73	1703 mW	No
WLAN 5.2G	21.5	141.25	5	64.7	YES	6.45	50.1	YES	191.45	1480 mW	No	5	64.7	YES	210.73	1673 mW	No
WLAN 5.3G	21.0	125.89	5	58.1	YES	6.45	45.0	YES	191.45	1480 mW	No	5	58.1	YES	210.73	1672 mW	No
WLAN 5.6G	21.0	125.89	5	60.1	YES	6.45	46.6	YES	191.45	1477 mW	No	5	60.1	YES	210.73	1670 mW	No
WLAN 5.8G	22.0	158.49	5	76.5	YES	6.45	59.3	YES	191.45	1477 mW	No	5	76.5	YES	210.73	1669 mW	No

## EUT 2 (Ant. HIGH-TEK)

### <For BT/WLAN Ant-0>

Mode	Max. Tune-up Power (dBm)	Max. Tune-up Power (mW)	Rear Face			Left Side			Right Side			Top Side			Bottom Side		
			Ant. to Surface (mm)	Calculated Result	Require SAR Testing?	Ant. to Surface (mm)	Calculated Result	Require SAR Testing?	Ant. to Surface (mm)	Calculated Result	Require SAR Testing?	Ant. to Surface (mm)	Calculated Result	Require SAR Testing?	Ant. to Surface (mm)	Calculated Result	Require SAR Testing?
WLAN 2.4G	21.0	125.89	5	39.5	YES	90	496 mW	No	191.45	1510 mW	No	5	39.5	YES	210.73	1703 mW	No
WLAN 5.2G	20.5	112.20	5	51.4	YES	90	466 mW	No	191.45	1480 mW	No	5	51.4	YES	210.73	1673 mW	No
WLAN 5.3G	20.5	112.20	5	51.8	YES	90	465 mW	No	191.45	1480 mW	No	5	51.8	YES	210.73	1672 mW	No
WLAN 5.6G	21.0	125.89	5	60.1	YES	90	463 mW	No	191.45	1477 mW	No	5	60.1	YES	210.73	1670 mW	No
WLAN 5.8G	19.0	79.43	5	38.3	YES	90	462 mW	No	191.45	1477 mW	No	5	38.3	YES	210.73	1669 mW	No
BT	1.0	1.26	5	0.4	No	90	495 mW	No	191.45	1510 mW	No	5	0.4	No	210.73	1703 mW	No

### <For WLAN Ant-1>

Mode	Max. Tune-up Power (dBm)	Max. Tune-up Power (mW)	Rear Face			Left Side			Right Side			Top Side			Bottom Side		
			Ant. to Surface (mm)	Calculated Result	Require SAR Testing?	Ant. to Surface (mm)	Calculated Result	Require SAR Testing?	Ant. to Surface (mm)	Calculated Result	Require SAR Testing?	Ant. to Surface (mm)	Calculated Result	Require SAR Testing?	Ant. to Surface (mm)	Calculated Result	Require SAR Testing?
WLAN 2.4G	20.5	112.20	5	35.2	YES	6.45	27.3	YES	290	2496 mW	No	5	35.2	YES	210.73	1703 mW	No
WLAN 5.2G	20.5	112.20	5	51.4	YES	6.45	39.8	YES	290	2466 mW	No	5	51.4	YES	210.73	1673 mW	No
WLAN 5.3G	20.5	112.20	5	51.8	YES	6.45	40.1	YES	290	2465 mW	No	5	51.8	YES	210.73	1672 mW	No
WLAN 5.6G	20.5	112.20	5	53.6	YES	6.45	41.5	YES	290	2463 mW	No	5	53.6	YES	210.73	1670 mW	No
WLAN 5.8G	19.0	79.43	5	38.3	YES	6.45	29.7	YES	290	2462 mW	No	5	38.3	YES	210.73	1669 mW	No

### <For WLAN Ant-0 + Ant-1>

Mode	Max. Tune-up Power (dBm)	Max. Tune-up Power (mW)	Rear Face			Left Side			Right Side			Top Side			Bottom Side		
			Ant. to Surface (mm)	Calculated Result	Require SAR Testing?	Ant. to Surface (mm)	Calculated Result	Require SAR Testing?	Ant. to Surface (mm)	Calculated Result	Require SAR Testing?	Ant. to Surface (mm)	Calculated Result	Require SAR Testing?	Ant. to Surface (mm)	Calculated Result	Require SAR Testing?
WLAN 2.4G	22.5	177.83	5	55.8	YES	6.45	43.3	YES	191.45	1510 mW	No	5	55.8	YES	210.73	1703 mW	No
WLAN 5.2G	21.5	141.25	5	64.7	YES	6.45	50.1	YES	191.45	1480 mW	No	5	64.7	YES	210.73	1673 mW	No
WLAN 5.3G	21.0	125.89	5	58.1	YES	6.45	45	YES	191.45	1480 mW	No	5	58.1	YES	210.73	1672 mW	No
WLAN 5.6G	21.0	125.89	5	60.1	YES	6.45	46.6	YES	191.45	1477 mW	No	5	60.1	YES	210.73	1670 mW	No
WLAN 5.8G	22.0	158.49	5	76.5	YES	6.45	59.3	YES	191.45	1477 mW	No	5	76.5	YES	210.73	1669 mW	No

# FCC SAR Test Report

## 4.3 Tissue Verification

The measuring results for tissue simulating liquid are shown as below.

Test Date	Tissue Type	Frequency (MHz)	Liquid Temp. (°C)	Measured Conductivity (σ)	Measured Permittivity (ε <sub>r</sub> )	Target Conductivity (σ)	Target Permittivity (ε <sub>r</sub> )	Conductivity Deviation (%)	Permittivity Deviation (%)
Aug. 17, 2015	Body	2450	23.1	1.997	51.334	1.95	52.7	2.41	-2.59
Aug. 19, 2015	Body	2450	23.0	2.019	50.914	1.95	52.7	3.54	-3.39
Aug. 21, 2015	Body	2450	23.0	2.017	51.670	1.95	52.7	3.44	-1.95
Aug. 23, 2015	Body	2450	23.2	2.009	52.157	1.95	52.7	3.03	-1.03
Aug. 17, 2015	Body	5200	22.8	5.248	51.109	5.30	49.0	-0.98	4.30
Aug. 19, 2015	Body	5200	23.0	5.321	47.346	5.30	49.0	0.40	-3.38
Aug. 21, 2015	Body	5200	23.0	5.270	49.057	5.30	49.0	-0.57	0.12
Aug. 22, 2015	Body	5200	23.3	5.347	47.666	5.30	49.0	0.89	-2.72
Aug. 17, 2015	Body	5300	22.8	5.411	51.008	5.42	48.9	-0.17	4.31
Aug. 19, 2015	Body	5300	23.0	5.545	47.175	5.42	48.9	2.31	-3.53
Aug. 21, 2015	Body	5300	23.0	5.406	48.894	5.42	48.9	-0.26	-0.01
Aug. 22, 2015	Body	5300	23.3	5.488	47.439	5.42	48.9	1.25	-2.99
Aug. 19, 2015	Body	5600	23.5	5.889	46.629	5.77	48.5	2.06	-3.86
Aug. 18, 2015	Body	5600	23.4	5.940	47.006	5.77	48.5	2.95	-3.08
Aug. 22, 2015	Body	5600	23.3	5.894	46.817	5.77	48.5	2.15	-3.47
Aug. 18, 2015	Body	5800	23.2	6.231	46.620	6.00	48.2	3.85	-3.28
Aug. 19, 2015	Body	5800	23.4	6.176	46.237	6.00	48.2	2.93	-4.07
Aug. 22, 2015	Body	5800	23.3	6.172	46.486	6.00	48.2	2.87	-3.56

**Note:**

The dielectric properties of the tissue simulating liquid must be measured within 24 hours before the SAR testing and within ±5% of the target values. Liquid temperature during the SAR testing must be within ±2 °C.

## 4.4 System Validation

The SAR measurement system was validated according to procedures in KDB 865664 D01. The validation status in tabulated summary is as below.

Test Date	Probe S/N	Calibration Point		Measured Conductivity (σ)	Measured Permittivity (ε <sub>r</sub> )	Validation for CW			Validation for Modulation		
						Sensitivity Range	Probe Linearity	Probe Isotropy	Modulation Type	Duty Factor	PAR
Aug. 17, 2015	3971	Body	2450	1.997	51.334	Pass	Pass	Pass	OFDM	N/A	Pass
Aug. 19, 2015	3864	Body	2450	2.019	50.914	Pass	Pass	Pass	OFDM	N/A	Pass
Aug. 21, 2015	3864	Body	2450	2.017	51.670	Pass	Pass	Pass	OFDM	N/A	Pass
Aug. 23, 2015	3864	Body	2450	2.009	52.157	Pass	Pass	Pass	OFDM	N/A	Pass
Aug. 17, 2015	3971	Body	5200	5.248	51.109	Pass	Pass	Pass	OFDM	N/A	Pass
Aug. 19, 2015	3864	Body	5200	5.321	47.346	Pass	Pass	Pass	OFDM	N/A	Pass
Aug. 21, 2015	3864	Body	5200	5.270	49.057	Pass	Pass	Pass	OFDM	N/A	Pass
Aug. 22, 2015	3864	Body	5200	5.347	47.666	Pass	Pass	Pass	OFDM	N/A	Pass
Aug. 17, 2015	3971	Body	5300	5.411	51.008	Pass	Pass	Pass	OFDM	N/A	Pass
Aug. 19, 2015	3864	Body	5300	5.545	47.175	Pass	Pass	Pass	OFDM	N/A	Pass
Aug. 21, 2015	3864	Body	5300	5.406	48.894	Pass	Pass	Pass	OFDM	N/A	Pass
Aug. 22, 2015	3864	Body	5300	5.488	47.439	Pass	Pass	Pass	OFDM	N/A	Pass
Aug. 19, 2015	3864	Body	5600	5.889	46.629	Pass	Pass	Pass	OFDM	N/A	Pass
Aug. 18, 2015	3864	Body	5600	5.940	47.006	Pass	Pass	Pass	OFDM	N/A	Pass
Aug. 22, 2015	3864	Body	5600	5.894	46.817	Pass	Pass	Pass	OFDM	N/A	Pass
Aug. 18, 2015	3864	Body	5800	6.231	46.620	Pass	Pass	Pass	OFDM	N/A	Pass
Aug. 19, 2015	3864	Body	5800	6.176	46.237	Pass	Pass	Pass	OFDM	N/A	Pass
Aug. 22, 2015	3864	Body	5800	6.172	46.486	Pass	Pass	Pass	OFDM	N/A	Pass



# FCC SAR Test Report

## 4.5 System Verification

The measuring result for system verification is tabulated as below.

Test Date	Mode	Frequency (MHz)	1W Target SAR-1g (W/kg)	Measured SAR-1g (W/kg)	Normalized to 1W SAR-1g (W/kg)	Deviation (%)	Dipole S/N	Probe S/N	DAE S/N
Aug. 17, 2015	Body	2450	50.30	12.30	49.20	-2.19	835	3971	1431
Aug. 19, 2015	Body	2450	50.30	12.60	50.40	0.20	835	3864	915
Aug. 21, 2015	Body	2450	50.30	12.50	50.00	-0.60	835	3864	915
Aug. 23, 2015	Body	2450	50.30	12.40	49.60	-1.39	835	3864	915
Aug. 17, 2015	Body	5200	73.70	7.31	73.10	-0.81	1040	3971	1431
Aug. 19, 2015	Body	5200	73.70	7.54	75.40	2.31	1040	3864	915
Aug. 21, 2015	Body	5200	73.70	7.47	74.70	1.36	1040	3864	915
Aug. 22, 2015	Body	5200	73.70	7.20	72.00	-2.31	1040	3864	915
Aug. 17, 2015	Body	5300	75.20	7.56	75.60	0.53	1040	3971	1431
Aug. 19, 2015	Body	5300	75.20	7.37	73.70	-1.99	1040	3864	915
Aug. 21, 2015	Body	5300	75.20	7.31	73.10	-2.79	1040	3864	915
Aug. 22, 2015	Body	5300	75.20	7.89	78.90	4.92	1040	3864	915
Aug. 19, 2015	Body	5600	79.00	7.99	79.90	1.14	1040	3864	915
Aug. 18, 2015	Body	5600	79.00	7.88	78.80	-0.25	1040	3864	915
Aug. 22, 2015	Body	5600	79.00	8.06	80.60	2.03	1040	3864	915
Aug. 18, 2015	Body	5800	76.60	7.15	71.50	-6.66	1040	3864	915
Aug. 19, 2015	Body	5800	76.00	7.01	70.10	-7.76	1040	3864	915
Aug. 22, 2015	Body	5800	76.60	7.29	72.90	-4.83	1040	3864	915

**Note:**

Comparing to the reference SAR value provided by SPEAG, the validation data should be within its specification of 10 %. The result indicates the system check can meet the variation criterion and the plots can be referred to Appendix A of this report.

# FCC SAR Test Report

## 4.6 Maximum Output Power

### 4.6.1 Maximum Conducted Power

The maximum conducted average power (Unit: dBm) including tune-up tolerance is shown as below.

#### EUT 1 (Ant. Ethertronics)

Mode	2.4G WLAN	5.2G WLAN	5.3G WLAN	5.6G WLAN	5.8G WLAN
802.11b	Ant0 CH1:17.5 CH6:20.5 CH11:18.0 Ant1 CH1:17.5 CH6:20.5 CH11:18.0	N/A	N/A	N/A	N/A
802.11g	Ant0 CH1:14.0 CH6:19.5 CH11:13.5 Ant1 CH0:14.0 CH6:19.5 CH11:13.5	N/A	N/A	N/A	N/A
802.11a	N/A	Ant0:20.5 Ant1:20.5	Ant0 CH52-56:20.5 CH60:18.0 CH64:17.0 Ant1 CH52-56:20.5 CH60:18.0 CH64:17.0	Ant0 CH100:16.5 CH104-136:20.5 CH140:16.0 Ant1 CH100:16.5 CH104-136:20.5 CH140:16.0	Ant0 CH149:16.0 CH153-161:19.0 CH165:17.0 Ant1 CH149:16.0 CH153-161:19.0 CH165:17.0
802.11n HT20	Ant0 CH1:14.5 CH6:19.5 CH11:13.5 Ant1 CH1:14.5 CH6:19.5 CH11:13.0 Ant0+1 CH1:17.0 CH6:22.5 CH11:16.0	Ant0 CH36:16.5 CH40-48:18.5 Ant1 CH36:16.5 CH40-48:18.5 Ant0+1 CH36:19.5 CH40-48:21.5	Ant0 CH52-60:18.0 CH64:17.0 Ant1 CH52-60:18.0 CH64:17.0 Ant0+1 CH52-60:21.0 CH64:20.0	Ant0 CH100:16.5 CH104-136:18.0 CH140:15.5 Ant1 CH100:16.5 CH104-136:18.0 CH140:15.5 Ant0+1 CH100:19.5 CH104-136:21.0 CH140:18.5	Ant0 CH149:16.0 CH153-161:19.0 CH165:17.0 Ant1 CH149:16.0 CH153-161:19.0 CH165:17.0 Ant0+1 CH149:19.0 CH153-161:22.0 H165:20.0





**FCC SAR Test Report**

Mode	2.4G WLAN	5.2G WLAN	5.3G WLAN	5.6G WLAN	5.8G WLAN
802.11n HT40	Ant0 CH1:11.0 CH6-11:13.0 Ant1 CH1:11.0 CH6-11:13.0 Ant0+1 CH3:14.0 CH6-9:16.0	Ant0 CH38:14.0 CH46:18.0 Ant1 CH38:14.0 CH46:18.0 Ant0+1 CH38:17.0 CH46:21.0	Ant0 CH54:17.5 CH62:15.5 Ant1 CH54:17.5 CH62:15.0 Ant0+1 CH54:21.0 CH62:18.5	Ant0 CH102:13.5 CH110:17.5 CH134:16.5 Ant1 CH102:13.5 CH110:17.5 CH134:16.5 Ant0+1 CH102:16.5 CH110:20.5 CH134:19.5	Ant0 CH151:14.0 CH159:16.0 Ant1 CH151:14.0 CH159:16.0 Ant0+1 CH151:17.0 CH159:19.0
802.11ac VHT80	N/A	Ant0:14.5 Ant1:14.5 Ant0+1:17.5	Ant0:14.5 Ant1:14.5 Ant0+1:17.5	Ant0 CH106:13.5 CH122:15.0 Ant1 CH106:13.5 CH122:15.5 Ant0+1 CH106:16.0 CH122:18.5	Ant0:14.5 Ant1:14.5 Ant0+1:17.5

Mode	2.4G Bluetooth
Bluetooth	1.0

**EUT 2 (Ant. HIGH-TEK)**

Mode	2.4G WLAN	5.2G WLAN	5.3G WLAN	5.6G WLAN	5.8G WLAN
802.11b	Ant0 CH1:17.5 CH6:21.0 CH11:18.0 Ant1 CH1:17.5 CH6:20.5 CH11:18.0	N/A	N/A	N/A	N/A
802.11g	Ant0 CH1:14.0 CH6:19.5 CH11:13.5 Ant1 CH0:14.0 CH6:19.5 CH11:13.5	N/A	N/A	N/A	N/A



**FCC SAR Test Report**

Mode	2.4G WLAN	5.2G WLAN	5.3G WLAN	5.6G WLAN	5.8G WLAN
802.11a	N/A	Ant0:20.5 Ant1:20.5	Ant0 CH52-56:20.5 CH60:18.0 CH64:17.0 Ant1 CH52-56:20.5 CH60:18.0 CH64:17.0	Ant0 CH100:16.5 CH104-136:21.0 CH140:16.0 Ant1 CH100:16.5 CH104-136:20.5 CH140:16.0	Ant0 CH149:16.0 CH153-161:18.5 CH165:17.5 Ant1 CH149:16.0 CH153-161:18.5 CH165:17.0
802.11n HT20	Ant0 CH1:14.5 CH6:19.5 CH11:13.5 Ant1 CH1:14.5 CH6:19.5 CH11:13.5 Ant0+1 CH1:17.5 CH6:22.5 CH11:16.5	Ant0 CH36:16.5 CH40-48:18.5 Ant1 CH36:16.5 CH40-48:18.5 Ant0+1 CH36:19.5 CH40-48:21.5	Ant0 CH52-60:18.0 CH64:17.0 Ant1 CH52-60:18.0 CH64:17.0 Ant0+1 CH52-60:21.0 CH64:20.0	Ant0 CH100:16.5 CH104-136:18.0 CH140:15.5 Ant1 CH100:16.5 CH104-136:18.0 CH140:15.5 Ant0+1 CH100:19.5 CH104-136:21.0 CH140:18.5	Ant0 CH149:16.0 CH153-161:19.0 CH165:17.0 Ant1 CH149:16.0 CH153-161:19.0 CH165:17.0 Ant0+1 CH149:19.0 CH153-161:22.0 H165:20.0
802.11n HT40	Ant0 CH1:11.0 CH6-11:13.0 Ant1 CH1:11.0 CH6-11:13.0 Ant0+1 CH3:14.0 CH6-9:16.0	Ant0 CH38:14.0 CH46:18.0 Ant1 CH38:14.0 CH46:18.0 Ant0+1 CH38:17.0 CH46:21.0	Ant0 CH54:17.5 CH62:15.5 Ant1 CH54:17.5 CH62:15.5 Ant0+1 CH54:21.0 CH62:18.5	Ant0 CH102:13.5 CH110:17.5 CH134:16.5 Ant1 CH102:13.5 CH110:17.5 CH134:16.5 Ant0+1 CH102:16.5 CH110:21.0 CH134:19.5	Ant0 CH151:14.0 CH159:16.0 Ant1 CH151:14.0 CH159:16.0 Ant0+1 CH151:17.0 CH159:19.0
802.11ac VHT80	N/A	Ant0:14.5 Ant1:14.5 Ant0+1:17.5	Ant0:15.0 Ant1:15.0 Ant0+1:18.0	Ant0 CH106:13.5 CH122:15.5 Ant1 CH106:13.5 CH122:15.5 Ant0+1 CH106:16.5 CH122:18.5	Ant0:14.5 Ant1:14.5 Ant0+1:18.0

Mode	2.4G Bluetooth
Bluetooth	1.0

# FCC SAR Test Report

## 4.6.2 Measured Conducted Power Result

The measuring conducted average power (Unit: dBm) is shown as below.

### EUT 1 (Ant. Ethertronics)

#### <WLAN 2.4G>

Mode	802.11b		
Channel / Frequency (MHz)	1 (2412)	6 (2437)	11 (2462)
Average Power (Ant-0)	17.11	20.43	17.88
Average Power (Ant-1)	17.03	20.26	17.79
Mode	802.11g		
Channel / Frequency (MHz)	1 (2412)	6 (2437)	11 (2462)
Average Power (Ant-0)	13.68	19.17	13.29
Average Power (Ant-1)	13.54	19.01	13.17
Mode	802.11n (HT20)		
Channel / Frequency (MHz)	1 (2412)	6 (2437)	11 (2462)
Average Power (Ant-0)	14.07	19.13	13.06
Average Power (Ant-1)	14.04	19.10	12.99
Average Power (Ant-0 + Ant-1)	16.92	22.11	15.99
Mode	802.11n (HT40)		
Channel / Frequency (MHz)	3 (2422)	6 (2437)	9 (2452)
Average Power (Ant-0)	10.72	12.69	12.55
Average Power (Ant-1)	10.66	12.61	12.47
Average Power (Ant-0 + Ant-1)	13.78	15.75	15.40

#### <WLAN 5.2G>

Mode	802.11a			
Channel / Frequency (MHz)	36 (5180)	40 (5200)	44 (5220)	48 (5240)
Average Power (Ant-0)	19.92	20.09	20.18	20.38
Average Power (Ant-1)	19.84	20.11	20.05	20.31
Mode	802.11n (HT20)			
Channel / Frequency (MHz)	36 (5180)	40 (5200)	44 (5220)	48 (5240)
Average Power (Ant-0)	16.12	18.01	18.03	18.10
Average Power (Ant-1)	16.11	17.92	17.93	18.01
Average Power (Ant-0 + Ant-1)	19.20	21.04	21.09	21.11
Mode	802.11n (HT40)			
Channel / Frequency (MHz)	38 (5190)		46 (5230)	
Average Power (Ant-0)	13.72		17.60	
Average Power (Ant-1)	13.54		17.57	
Average Power (Ant-0 + Ant-1)	16.66		20.63	
Mode	802.11ac (VHT80)			
Channel / Frequency (MHz)	42 (5210)			
Average Power (Ant-0)	14.25			
Average Power (Ant-1)	14.08			
Average Power (Ant-0 + Ant-1)	17.11			

**FCC SAR Test Report**
**<WLAN 5.3G>**

Mode	802.11a			
Channel / Frequency (MHz)	52 (5260)	56 (5280)	60 (5300)	64 (5320)
Average Power (Ant-0)	20.34	20.16	17.89	16.92
Average Power (Ant-1)	20.27	20.08	17.87	16.76
Mode	802.11n (HT20)			
Channel / Frequency (MHz)	52 (5260)	56 (5280)	60 (5300)	64 (5320)
Average Power (Ant-0)	17.89	17.82	17.78	16.67
Average Power (Ant-1)	17.83	17.77	17.67	16.65
Average Power (Ant-0 + Ant-1)	20.88	20.90	20.84	19.69
Mode	802.11n (HT40)			
Channel / Frequency (MHz)	54 (5270)		62 (5310)	
Average Power (Ant-0)	17.39		15.02	
Average Power (Ant-1)	17.31		14.92	
Average Power (Ant-0 + Ant-1)	20.52		18.08	
Mode	802.11ac (VHT80)			
Channel / Frequency (MHz)	58 (5290)			
Average Power (Ant-0)	14.49			
Average Power (Ant-1)	14.23			
Average Power (Ant-0 + Ant-1)	17.47			

**<WLAN 5.6G>**

Mode	802.11a							
Channel / Frequency (MHz)	100 (5500)	104 (5520)	108 (5540)	112 (5560)	116 (5580)	132 (5660)	136 (5680)	140 (5700)
Average Power (Ant-0)	16.31	20.29	20.30	20.27	20.45	20.31	20.24	15.91
Average Power (Ant-1)	16.30	20.30	20.33	20.25	20.44	20.33	20.28	15.89
Mode	802.11n (HT20)							
Channel / Frequency (MHz)	100 (5500)	104 (5520)	108 (5540)	112 (5560)	116 (5580)	132 (5660)	136 (5680)	140 (5700)
Average Power (Ant-0)	16.21	17.67	17.73	17.76	17.77	17.72	17.76	15.27
Average Power (Ant-1)	16.19	17.56	17.59	17.54	17.70	17.69	17.61	15.25
Average Power (Ant-0 + Ant-1)	19.28	20.81	20.83	20.81	20.81	20.78	20.76	18.28
Mode	802.11n (HT40)							
Channel / Frequency (MHz)	102 (5510)			110 (5550)			134 (5670)	
Average Power (Ant-0)	13.11			17.39			16.31	
Average Power (Ant-1)	13.02			17.34			16.12	
Average Power (Ant-0 + Ant-1)	16.17			20.44			19.29	
Mode	802.11ac (VHT80)							
Channel / Frequency (MHz)	106 (5530)				122 (5610)			
Average Power (Ant-0)	13.05				14.98			
Average Power (Ant-1)	13.05				14.98			
Average Power (Ant-0 + Ant-1)	15.99				18.11			



# FCC SAR Test Report

## <WLAN 5.8G>

Mode	802.11a				
Channel / Frequency (MHz)	149 (5745)	153 (5765)	157 (5785)	161 (5805)	165 (5825)
Average Power (Ant-0)	15.88	18.49	18.53	18.43	16.93
Average Power (Ant-1)	15.78	18.38	18.50	18.34	16.87
Mode	802.11n (HT20)				
Channel / Frequency (MHz)	149 (5745)	153 (5765)	157 (5785)	161 (5805)	165 (5825)
Average Power (Ant-0)	15.96	18.42	18.59	18.38	16.83
Average Power (Ant-1)	15.79	18.38	18.52	18.34	16.78
Average Power (Ant-0 + Ant-1)	18.95	21.47	21.68	21.49	19.79
Mode	802.11n (HT40)				
Channel / Frequency (MHz)	151 (5755)		159 (5795)		
Average Power (Ant-0)	13.89		15.90		
Average Power (Ant-1)	13.89		15.82		
Average Power (Ant-0 + Ant-1)	16.85		18.98		
Mode	802.11ac (VHT80)				
Channel / Frequency (MHz)	155 (5775)				
Average Power (Ant-0)	14.25				
Average Power (Ant-1)	14.20				
Average Power (Ant-0 + Ant-1)	17.45				

## <Bluetooth>

Mode	Bluetooth		
Channel / Frequency (MHz)	0 (2402)	39 (2441)	78 (2480)
Average Power	0.97	0.91	0.53

# FCC SAR Test Report

## EUT 2 (Ant. HIGH-TEK)

### <WLAN 2.4G>

Mode	802.11b		
Channel / Frequency (MHz)	1 (2412)	6 (2437)	11 (2462)
Average Power (Ant-0)	17.25	20.59	17.97
Average Power (Ant-1)	17.16	20.43	17.92
Mode	802.11g		
Channel / Frequency (MHz)	1 (2412)	6 (2437)	11 (2462)
Average Power (Ant-0)	13.75	19.25	13.42
Average Power (Ant-1)	13.71	19.20	13.34
Mode	802.11n (HT20)		
Channel / Frequency (MHz)	1 (2412)	6 (2437)	11 (2462)
Average Power (Ant-0)	14.24	19.21	13.17
Average Power (Ant-1)	14.19	19.18	13.11
Average Power (Ant-0 + Ant-1)	17.01	22.26	16.10
Mode	802.11n (HT40)		
Channel / Frequency (MHz)	3 (2422)	6 (2437)	9 (2452)
Average Power (Ant-0)	10.88	12.85	12.63
Average Power (Ant-1)	10.75	12.66	12.57
Average Power (Ant-0 + Ant-1)	13.82	15.77	15.51

### <WLAN 5.2G>

Mode	802.11a			
Channel / Frequency (MHz)	36 (5180)	40 (5200)	44 (5220)	48 (5240)
Average Power (Ant-0)	19.98	20.13	20.21	20.47
Average Power (Ant-1)	19.91	20.11	20.18	20.46
Mode	802.11n (HT20)			
Channel / Frequency (MHz)	36 (5180)	40 (5200)	44 (5220)	48 (5240)
Average Power (Ant-0)	16.24	18.13	18.12	18.15
Average Power (Ant-1)	16.21	17.97	18.09	18.10
Average Power (Ant-0 + Ant-1)	19.24	21.11	21.14	21.16
Mode	802.11n (HT40)			
Channel / Frequency (MHz)	38 (5190)		46 (5230)	
Average Power (Ant-0)	13.83		17.77	
Average Power (Ant-1)	13.76		17.73	
Average Power (Ant-0 + Ant-1)	16.84		20.77	
Mode	802.11ac (VHT80)			
Channel / Frequency (MHz)	42 (5210)			
Average Power (Ant-0)	14.28			
Average Power (Ant-1)	14.22			
Average Power (Ant-0 + Ant-1)	17.17			

**FCC SAR Test Report**
**<WLAN 5.3G>**

Mode	802.11a			
Channel / Frequency (MHz)	52 (5260)	56 (5280)	60 (5300)	64 (5320)
Average Power (Ant-0)	20.38	20.20	17.98	16.98
Average Power (Ant-1)	20.33	20.08	17.93	16.83
Mode	802.11n (HT20)			
Channel / Frequency (MHz)	52 (5260)	56 (5280)	60 (5300)	64 (5320)
Average Power (Ant-0)	17.98	17.95	17.94	16.84
Average Power (Ant-1)	17.95	17.89	17.89	16.82
Average Power (Ant-0 + Ant-1)	20.96	20.95	20.96	19.85
Mode	802.11n (HT40)			
Channel / Frequency (MHz)	54 (5270)		62 (5310)	
Average Power (Ant-0)	17.46		15.11	
Average Power (Ant-1)	17.41		15.09	
Average Power (Ant-0 + Ant-1)	20.53		18.16	
Mode	802.11ac (VHT80)			
Channel / Frequency (MHz)	58 (5290)			
Average Power (Ant-0)	14.57			
Average Power (Ant-1)	14.54			
Average Power (Ant-0 + Ant-1)	17.56			

**<WLAN 5.6G>**

Mode	802.11a							
Channel / Frequency (MHz)	100 (5500)	104 (5520)	108 (5540)	112 (5560)	116 (5580)	132 (5660)	136 (5680)	140 (5700)
Average Power (Ant-0)	16.39	20.33	20.34	20.31	20.52	20.36	20.29	15.97
Average Power (Ant-1)	16.36	20.30	20.33	20.25	20.45	20.33	20.28	15.95
Mode	802.11n (HT20)							
Channel / Frequency (MHz)	100 (5500)	104 (5520)	108 (5540)	112 (5560)	116 (5580)	132 (5660)	136 (5680)	140 (5700)
Average Power (Ant-0)	16.33	17.81	17.79	17.80	17.85	17.77	17.76	15.41
Average Power (Ant-1)	16.29	17.72	17.73	17.75	17.80	17.79	17.71	15.40
Average Power (Ant-0 + Ant-1)	19.31	20.85	20.86	20.87	20.88	20.82	20.81	18.41
Mode	802.11n (HT40)							
Channel / Frequency (MHz)	102 (5510)			110 (5550)			134 (5670)	
Average Power (Ant-0)	13.18			17.47			16.31	
Average Power (Ant-1)	13.11			17.45			16.24	
Average Power (Ant-0 + Ant-1)	16.21			20.52			19.30	
Mode	802.11ac (VHT80)							
Channel / Frequency (MHz)	106 (5530)				122 (5610)			
Average Power (Ant-0)	13.16				15.17			
Average Power (Ant-1)	13.14				15.12			
Average Power (Ant-0 + Ant-1)	16.09				18.17			



# FCC SAR Test Report

A D T

## <WLAN 5.8G>

Mode	802.11a				
Channel / Frequency (MHz)	149 (5745)	153 (5765)	157 (5785)	161 (5805)	165 (5825)
Average Power (Ant-0)	15.96	18.44	18.46	18.41	17.04
Average Power (Ant-1)	15.81	18.42	18.43	18.39	16.94
Mode	802.11n (HT20)				
Channel / Frequency (MHz)	149 (5745)	153 (5765)	157 (5785)	161 (5805)	165 (5825)
Average Power (Ant-0)	15.90	18.48	18.65	18.42	16.60
Average Power (Ant-1)	15.86	18.47	18.62	18.39	16.54
Average Power (Ant-0 + Ant-1)	18.90	21.58	21.67	21.54	19.60
Mode	802.11n (HT40)				
Channel / Frequency (MHz)	151 (5755)		159 (5795)		
Average Power (Ant-0)	13.98		15.94		
Average Power (Ant-1)	13.94		15.93		
Average Power (Ant-0 + Ant-1)	16.98		18.99		
Mode	802.11ac (VHT80)				
Channel / Frequency (MHz)	155 (5775)				
Average Power (Ant-0)	14.50				
Average Power (Ant-1)	14.37				
Average Power (Ant-0 + Ant-1)	17.58				

## <Bluetooth>

Mode	Bluetooth		
Channel / Frequency (MHz)	0 (2402)	39 (2441)	78 (2480)
Average Power	0.96	0.89	0.54



## **4.7 SAR Testing Results**

### **4.7.1 SAR Test Reduction Considerations**

#### **<KDB 447498 D01, General RF Exposure Guidance>**

Testing of other required channels within the operating mode of a frequency band is not required when the reported SAR for the mid-band or highest output power channel is:

- (1)  $\leq 0.8$  W/kg or 2.0 W/kg, for 1-g or 10-g respectively, when the transmission band is  $\leq 100$  MHz
- (2)  $\leq 0.6$  W/kg or 1.5 W/kg, for 1-g or 10-g respectively, when the transmission band is between 100 MHz and 200 MHz
- (3)  $\leq 0.4$  W/kg or 1.0 W/kg, for 1-g or 10-g respectively, when the transmission band is  $\geq 200$  MHz

#### **<KDB 248227 D01, SAR Guidance for Wi-Fi Transmitters>**

- (1) For WLAN 2.4 GHz, the highest measured maximum output power channel for DSSS was selected for SAR measurement. When the reported SAR is  $\leq 0.8$  W/kg, no further SAR testing is required. Otherwise, SAR is evaluated at the next highest measured output power channel. When any reported SAR is  $> 1.2$  W/kg, SAR is required for the third channel. For OFDM modes (802.11g/n), SAR is not required when the highest reported SAR for DSSS is adjusted by the ratio of OFDM to DSSS specified maximum output power and it is  $\leq 1.2$  W/kg.
- (2) For WLAN 5 GHz, the initial test configuration was selected according to the transmission mode with the highest maximum output power. When the reported SAR of initial test configuration is  $> 0.8$  W/kg, SAR is required for the subsequent highest measured output power channel until the reported SAR result is  $\leq 1.2$  W/kg or all required channels are measured. For other transmission modes, SAR is not required when the highest reported SAR for initial test configuration is adjusted by the ratio of subsequent test configuration to initial test configuration specified maximum output power and it is  $\leq 1.2$  W/kg.
- (3) For WLAN MIMO mode, the power-based standalone SAR test exclusion or the sum of SAR provision in KDB 447498 to determine simultaneous transmission SAR test exclusion should be applied. Otherwise, SAR for MIMO mode will be measured with all applicable antennas transmitting simultaneously at the specified maximum output power of MIMO operation.

# FCC SAR Test Report

## 4.7.2 SAR Results for Body Exposure Condition (Separation Distance is 0 cm Gap)

### EUT 1 (Ant. Ethertronics)

#### <Tablet PC Mode (Separation Distance is 0 cm Gap)>

Plot No.	Band	Mode	Test Position	Ch	Tx Antenna	Max. Tune-up Power (dBm)	Measured Conducted Power (dBm)	Scaling Factor	Power Drift (dB)	Measured SAR-1g (W/kg)	Scaled SAR-1g (W/kg)
	2.4G WLAN	802.11b	Rear Face	6	0	20.5	20.43	1.02	0.01	0.069	0.07
	2.4G WLAN	802.11b	Top Side	6	0	20.5	20.43	1.02	0.05	0.231	0.23
	2.4G WLAN	802.11b	Rear Face	6	1	20.5	20.26	1.06	0.09	0.078	0.08
01	2.4G WLAN	802.11b	Left Side	6	1	20.5	20.26	1.06	0.04	0.256	0.27
	2.4G WLAN	802.11b	Top Side	6	1	20.5	20.26	1.06	-0.05	0.194	0.21
	2.4G WLAN	802.11n HT20	Rear Face	6	0+1	22.5	22.11	1.09	0.07	0.078	0.09
	2.4G WLAN	802.11n HT20	Left Side	6	0+1	22.5	22.11	1.09	0.08	0.193	0.21
	2.4G WLAN	802.11n HT20	Top Side	6	0+1	22.5	22.11	1.09	-0.02	0.177	0.19
	5.2G WLAN	802.11n HT20	Rear Face	44	0+1	21.5	21.09	1.10	0.06	0.223	0.25
	5.2G WLAN	802.11n HT20	Left Side	44	0+1	21.5	21.09	1.10	-0.01	0.318	0.35
02	5.2G WLAN	802.11n HT20	Top Side	44	0+1	21.5	21.09	1.10	-0.05	0.366	0.40
	5.3G WLAN	802.11a	Rear Face	56	0	20.5	20.16	1.08	0.06	0.066	0.07
	5.3G WLAN	802.11a	Top Side	56	0	20.5	20.16	1.08	-0.05	0.022	0.02
	5.3G WLAN	802.11a	Rear Face	56	1	20.5	20.08	1.10	0.03	0.220	0.24
	5.3G WLAN	802.11a	Left Side	56	1	20.5	20.08	1.10	-0.05	0.022	0.02
03	5.3G WLAN	802.11a	Top Side	56	1	20.5	20.08	1.10	0.06	0.347	0.38
	5.6G WLAN	802.11a	Rear Face	116	0	20.5	20.45	1.01	-0.04	0.052	0.05
	5.6G WLAN	802.11a	Top Side	116	0	20.5	20.45	1.01	-0.07	0.370	0.37
	5.6G WLAN	802.11a	Rear Face	116	1	20.5	20.44	1.01	0.05	0.213	0.22
	5.6G WLAN	802.11a	Left Side	116	1	20.5	20.44	1.01	-0.07	0.340	0.34
	5.6G WLAN	802.11a	Top Side	116	1	20.5	20.44	1.01	-0.03	0.367	0.37
	5.6G WLAN	802.11n HT20	Rear Face	116	0+1	21.0	20.81	1.04	-0.01	0.213	0.22
	5.6G WLAN	802.11n HT20	Left Side	116	0+1	21.0	20.81	1.04	0.05	0.394	0.41
04	5.6G WLAN	802.11n HT20	Top Side	116	0+1	21.0	20.81	1.04	-0.03	0.429	0.45
	5.8G WLAN	802.11a	Rear Face	157	0	19.0	18.53	1.11	-0.1	0.076	0.08
	5.8G WLAN	802.11a	Top Side	157	0	19.0	18.53	1.11	-0.02	0.488	0.54
	5.8G WLAN	802.11a	Rear Face	157	1	19.0	18.50	1.12	-0.03	0.309	0.35
	5.8G WLAN	802.11a	Left Side	157	1	19.0	18.50	1.12	-0.03	0.603	0.68
	5.8G WLAN	802.11a	Top Side	157	1	19.0	18.50	1.12	-0.01	0.613	0.69
	5.8G WLAN	802.11n HT20	Rear Face	157	0+1	22.0	21.68	1.08	0.02	0.390	0.42
	5.8G WLAN	802.11n HT20	Left Side	157	0+1	22.0	21.68	1.08	0.07	0.614	0.66
05	5.8G WLAN	802.11n HT20	Top Side	157	0+1	22.0	21.68	1.08	0.06	0.652	0.70



# FCC SAR Test Report

A D T

## <Laptop PC Mode (Separation Distance is 2.5 cm Gap)>

Plot No.	Band	Mode	Test Position	Ch	Tx Antenna	Max. Tune-up Power (dBm)	Measured Conducted Power (dBm)	Scaling Factor	Power Drift (dB)	Measured SAR-1g (W/kg)	Scaled SAR-1g (W/kg)
06	2.4G WLAN	802.11b	Top Side	6	0	20.5	20.43	1.02	-0.06	0.029	<b>0.03</b>
	2.4G WLAN	802.11b	Left Side	6	1	20.5	20.26	1.06	-0.07	0.017	0.02
	2.4G WLAN	802.11b	Top Side	6	1	20.5	20.26	1.06	-0.11	0.012	0.01
	2.4G WLAN	802.11n HT20	Left Side	6	0+1	22.5	22.11	1.09	-0.02	0.017	0.02
	2.4G WLAN	802.11n HT20	Top Side	6	0+1	22.5	22.11	1.09	-0.11	0.023	0.03
07	5.2G WLAN	802.11n HT20	Left Side	44	0+1	21.5	21.09	1.10	-0.04	0.070	<b>0.08</b>
	5.2G WLAN	802.11n HT20	Top Side	44	0+1	21.5	21.09	1.10	-0.06	0.054	0.06
	5.3G WLAN	802.11a	Top Side	56	0	20.5	20.16	1.08	0.02	0.020	0.02
	5.3G WLAN	802.11a	Left Side	56	1	20.5	20.08	1.10	-0.07	0.053	0.06
08	5.3G WLAN	802.11a	Top Side	56	1	20.5	20.08	1.10	-0.03	0.059	<b>0.06</b>
	5.6G WLAN	802.11a	Top Side	116	0	20.5	20.45	1.01	-0.09	0.035	0.04
	5.6G WLAN	802.11a	Left Side	116	1	20.5	20.44	1.01	-0.09	0.065	0.07
	5.6G WLAN	802.11a	Top Side	116	1	20.5	20.44	1.01	-0.08	0.060	0.06
09	5.6G WLAN	802.11n HT20	Left Side	116	0+1	21.0	20.81	1.04	-0.03	0.069	<b>0.07</b>
	5.6G WLAN	802.11n HT20	Top Side	116	0+1	21.0	20.81	1.04	-0.03	0.066	0.07
	5.8G WLAN	802.11a	Top Side	157	0	19.0	18.53	1.11	-0.01	0.069	0.08
	5.8G WLAN	802.11a	Left Side	157	1	19.0	18.50	1.12	-0.01	0.089	0.10
	5.8G WLAN	802.11a	Top Side	157	1	19.0	18.50	1.12	-0.07	0.050	0.06
10	5.8G WLAN	802.11n HT20	Left Side	157	0+1	22.0	21.68	1.08	-0.09	0.102	<b>0.11</b>
	5.8G WLAN	802.11n HT20	Top Side	157	0+1	22.0	21.68	1.08	-0.07	0.064	0.07

## EUT 2 (Ant. HIGH-TEK)

<Tablet PC Mode (Separation Distance is 0 cm Gap)>

Plot No.	Band	Mode	Test Position	Ch	Tx Antenna	Max. Tune-up Power (dBm)	Measured Conducted Power (dBm)	Scaling Factor	Power Drift (dB)	Measured SAR-1g (W/kg)	Scaled SAR-1g (W/kg)
	2.4G WLAN	802.11b	Rear Face	6	0	21.0	20.59	1.10	0.03	0.151	0.17
	2.4G WLAN	802.11b	Top Side	6	0	21.0	20.59	1.10	-0.01	0.540	0.59
	2.4G WLAN	802.11b	Rear Face	6	1	20.5	20.43	1.02	0.02	0.323	0.33
11	2.4G WLAN	802.11b	Left Side	6	1	20.5	20.43	1.02	-0.04	0.650	<b>0.66</b>
	2.4G WLAN	802.11b	Top Side	6	1	20.5	20.43	1.02	0.15	0.508	0.52
	2.4G WLAN	802.11n HT20	Rear Face	6	0+1	22.5	22.26	1.06	0.04	0.267	0.28
	2.4G WLAN	802.11n HT20	Left Side	6	0+1	22.5	22.26	1.06	0.11	0.583	0.62
	2.4G WLAN	802.11n HT20	Top Side	6	0+1	22.5	22.26	1.06	0.07	0.470	0.50
	5.2G WLAN	802.11n HT20	Rear Face	44	0+1	21.5	21.14	1.09	0.01	0.418	0.45
	5.2G WLAN	802.11n HT20	Left Side	44	0+1	21.5	21.14	1.09	-0.14	0.592	0.64
12	5.2G WLAN	802.11n HT20	Top Side	44	0+1	21.5	21.14	1.09	-0.01	0.857	<b>0.93</b>
	5.2G WLAN	802.11n HT20	Top Side	44	0+1	21.5	21.14	1.09	-0.06	0.833	0.90
	5.2G WLAN	802.11n HT20	Left Side	48	0+1	21.5	21.16	1.08	0.02	0.523	0.57
	5.2G WLAN	802.11n HT20	Top Side	48	0+1	21.5	21.16	1.08	0.04	0.811	0.88
	5.3G WLAN	802.11a	Rear Face	56	0	20.5	20.20	1.07	0.06	0.257	0.28
	5.3G WLAN	802.11a	Top Side	56	0	20.5	20.20	1.07	-0.12	0.740	0.79
	5.3G WLAN	802.11a	Rear Face	56	1	20.5	20.08	1.10	-0.06	0.453	0.50
	5.3G WLAN	802.11a	Left Side	56	1	20.5	20.08	1.10	0.04	0.426	0.47
13	5.3G WLAN	802.11a	Top Side	56	1	20.5	20.08	1.10	-0.02	0.781	<b>0.86</b>
	5.3G WLAN	802.11a	Rear Face	52	1	20.5	20.33	1.04	0.07	0.444	0.46
	5.3G WLAN	802.11a	Top Side	52	1	20.5	20.33	1.04	-0.01	0.772	0.80
	5.6G WLAN	802.11a	Rear Face	116	0	21.0	20.52	1.12	-0.08	0.110	0.12
	5.6G WLAN	802.11a	Top Side	116	0	21.0	20.52	1.12	-0.08	0.495	0.55
	5.6G WLAN	802.11a	Rear Face	116	1	20.5	20.45	1.01	-0.1	0.404	0.41
	5.6G WLAN	802.11a	Left Side	116	1	20.5	20.45	1.01	-0.07	0.360	0.36
14	5.6G WLAN	802.11a	Top Side	116	1	20.5	20.45	1.01	-0.02	0.742	<b>0.75</b>
	5.6G WLAN	802.11n HT20	Rear Face	116	0+1	21.0	20.88	1.03	-0.07	0.240	0.25
	5.6G WLAN	802.11n HT20	Left Side	116	0+1	21.0	20.88	1.03	-0.06	0.183	0.19
	5.6G WLAN	802.11n HT20	Top Side	116	0+1	21.0	20.88	1.03	-0.11	0.450	0.46
	5.8G WLAN	802.11n HT20	Rear Face	157	0	19.0	18.65	1.08	-0.03	0.179	0.19
	5.8G WLAN	802.11n HT20	Top Side	157	0	19.0	18.65	1.08	-0.06	0.639	0.69
	5.8G WLAN	802.11n HT20	Rear Face	157	1	19.0	18.62	1.09	0.01	0.421	0.46
	5.8G WLAN	802.11n HT20	Left Side	157	1	19.0	18.62	1.09	0.11	0.320	0.35
	5.8G WLAN	802.11n HT20	Top Side	157	1	19.0	18.62	1.09	-0.01	0.651	0.71
	5.8G WLAN	802.11n HT20	Rear Face	157	0+1	22.0	21.67	1.08	0.08	0.674	0.73
	5.8G WLAN	802.11n HT20	Left Side	157	0+1	22.0	21.67	1.08	0.09	0.571	0.62
15	5.8G WLAN	802.11n HT20	Top Side	157	0+1	22.0	21.67	1.08	-0.08	1.020	<b>1.10</b>
	5.8G WLAN	802.11n HT20	Top Side	157	0+1	22.0	21.67	1.08	-0.1	0.997	1.08
	5.8G WLAN	802.11n HT20	Rear Face	153	0+1	22.0	21.58	1.10	0.07	0.578	0.64
	5.8G WLAN	802.11n HT20	Top Side	153	0+1	22.0	21.58	1.10	-0.09	0.925	1.02



# FCC SAR Test Report

A D T

## <Laptop PC Mode (Separation Distance is 2.5 cm Gap)>

Plot No.	Band	Mode	Test Position	Ch	Tx Antenna	Max. Tune-up Power (dBm)	Measured Conducted Power (dBm)	Scaling Factor	Power Drift (dB)	Measured SAR-1g (W/kg)	Scaled SAR-1g (W/kg)
	2.4G WLAN	802.11b	Top Side	6	0	21.0	20.59	1.10	0.02	0.051	0.06
	2.4G WLAN	802.11b	Left Side	6	1	20.5	20.43	1.02	0.09	0.04	0.04
16	2.4G WLAN	802.11b	Top Side	6	1	20.5	20.43	1.02	0.06	0.068	0.07
	2.4G WLAN	802.11b	Left Side	6	0+1	22.5	22.26	1.06	0.01	0.035	0.04
	2.4G WLAN	802.11b	Top Side	6	0+1	22.5	22.26	1.06	0.03	0.067	0.07
17	5.2G WLAN	802.11n HT20	Left Side	44	0+1	21.5	21.14	1.09	-0.04	0.109	0.12
	5.2G WLAN	802.11n HT20	Top Side	44	0+1	21.5	21.14	1.09	0.06	0.103	0.11
	5.3G WLAN	802.11a	Top Side	56	0	20.5	20.20	1.07	0.08	0.06	0.06
	5.3G WLAN	802.11a	Left Side	56	1	20.5	20.08	1.10	-0.03	0.042	0.05
18	5.3G WLAN	802.11a	Top Side	56	1	20.5	20.08	1.10	0.04	0.118	0.13
	5.6G WLAN	802.11a	Top Side	116	0	21.0	20.52	1.12	-0.03	0.102	0.11
	5.6G WLAN	802.11a	Left Side	116	1	20.5	20.45	1.01	-0.05	0.092	0.09
	5.6G WLAN	802.11a	Top Side	116	1	20.5	20.45	1.01	0.01	0.079	0.08
19	5.6G WLAN	802.11n HT20	Left Side	116	0+1	21.0	20.88	1.03	-0.08	0.113	0.12
	5.6G WLAN	802.11n HT20	Top Side	116	0+1	21.0	20.88	1.03	-0.04	0.072	0.07
	5.8G WLAN	802.11n HT20	Top Side	157	0	19.0	18.65	1.08	-0.07	0.079	0.09
	5.8G WLAN	802.11n HT20	Left Side	157	1	19.0	18.62	1.09	-0.05	0.053	0.06
	5.8G WLAN	802.11n HT20	Top Side	157	1	19.0	18.62	1.09	-0.06	0.084	0.09
	5.8G WLAN	802.11n HT20	Left Side	157	0+1	22.0	21.67	1.08	-0.04	0.142	0.15
20	5.8G WLAN	802.11n HT20	Top Side	157	0+1	22.0	21.67	1.08	-0.07	0.158	0.17

# FCC SAR Test Report

## 4.7.3 SAR Measurement Variability

According to KDB 865664 D01, SAR measurement variability was assessed for each frequency band, which is determined by the SAR probe calibration point and tissue-equivalent medium used for the device measurements. When both head and body tissue-equivalent media are required for SAR measurements in a frequency band, the variability measurement procedures should be applied to the tissue medium with the highest measured SAR, using the highest measured SAR configuration for that tissue-equivalent medium. Alternatively, if the highest measured SAR for both head and body tissue-equivalent media are  $\leq 1.45$  W/kg and the ratio of these highest SAR values, i.e., largest divided by smallest value, is  $\leq 1.10$ , the highest SAR configuration for either head or body tissue-equivalent medium may be used to perform the repeated measurement. These additional measurements are repeated after the completion of all measurements requiring the same head or body tissue-equivalent medium in a frequency band. The test device should be returned to ambient conditions (normal room temperature) with the battery fully charged before it is re-mounted on the device holder for the repeated measurement(s) to minimize any unexpected variations in the repeated results.

SAR repeated measurement procedure:

1. When the highest measured SAR is  $< 0.80$  W/kg, repeated measurement is not required.
2. When the highest measured SAR is  $\geq 0.80$  W/kg, repeat that measurement once.
3. If the ratio of largest to smallest SAR for the original and first repeated measurements is  $> 1.20$ , or when the original or repeated measurement is  $\geq 1.45$  W/kg, perform a second repeated measurement.
4. If the ratio of largest to smallest SAR for the original, first and second repeated measurements is  $> 1.20$ , and the original, first or second repeated measurement is  $\geq 1.5$  W/kg, perform a third repeated measurement.

Band	Mode	Test Position	Ch.	Tx Antenna	Original Measured SAR-1g (W/kg)	1st Repeated SAR-1g (W/kg)	L/S Ratio	2nd Repeated SAR-1g (W/kg)	L/S Ratio	3rd Repeated SAR-1g (W/kg)	L/S Ratio
5.2G WLAN	802.11n HT20	Top Side	44	0+1	0.857	0.833	1.03	N/A	N/A	N/A	N/A
5.8G WLAN	802.11n HT20	Top Side	157	0+1	1.02	0.997	1.02	N/A	N/A	N/A	N/A

# FCC SAR Test Report

## 4.7.4 Simultaneous Multi-band Transmission Evaluation

### <Estimated SAR Calculation>

According to KDB 447498 D01, when standalone SAR test exclusion applies to an antenna that transmits simultaneously with other antennas, the standalone SAR was estimated according to following formula to result in substantially conservative SAR values of  $\leq 0.4$  W/kg to determine simultaneous transmission SAR test exclusion.

$$\text{Estimated SAR} = \frac{\text{Max. Tune up Power}_{(mW)}}{\text{Min. Test Separation Distance}_{(mm)}} \times \frac{\sqrt{f_{(GHz)}}}{7.5}$$

If the minimum test separation distance is  $< 5$  mm, a distance of 5 mm is used for estimated SAR calculation. When the test separation distance is  $> 50$  mm, the 0.4 W/kg is used for SAR-1g.

Mode / Band	Frequency (GHz)	Max. Tune-up Power (dBm) Test Position	Separation Distance (mm)	Estimated SAR (W/kg)
BT (DSS)	2.48	1.0	5	0.05

### <SAR Summation Analysis>

Simultaneous transmission SAR test exclusion is determined for each operating configuration and exposure condition according to the reported standalone SAR of each applicable simultaneous transmitting antenna. When the sum of SAR<sub>1g</sub> of all simultaneously transmitting antennas in an operating mode and exposure condition combination is within the SAR limit (SAR<sub>1g</sub> 1.6 W/kg), the simultaneous transmission SAR is not required. When the sum of SAR<sub>1g</sub> is greater than the SAR limit (SAR<sub>1g</sub> 1.6 W/kg), SAR test exclusion is determined by the SPLSR.

No.	Conditions (SAR1 + SAR2)	Exposure Condition	Max. SAR1	Max. SAR2	SAR Summation	SPLSR Analysis
1	WLAN (DTS) + BT (DSS)	Body	0.66	0.05	0.71	$\Sigma$ SAR $< 1.6$ , Not required
2	WLAN (NII) + BT (DSS)	Body	1.10	0.05	1.15	$\Sigma$ SAR $< 1.6$ , Not required

Test Engineer : Way Huang, and Terry Huang



## 5. Calibration of Test Equipment

Equipment	Manufacturer	Model	SN	Cal. Date	Cal. Interval
System Validation Dipole	SPEAG	D2450V2	835	Mar. 30, 2015	2 Years
System Validation Dipole	SPEAG	D5GHzV2	1040	Jun. 22, 2015	2 Years
Dosimetric E-Field Probe	SPEAG	EX3DV4	3864	Jul. 23, 2015	1 Year
Dosimetric E-Field Probe	SPEAG	EX3DV4	3971	Mar. 26, 2015	1 Year
Data Acquisition Electronics	SPEAG	DAE4	915	Jun. 11, 2015	1 Year
Data Acquisition Electronics	SPEAG	DAE4	1431	Mar. 20, 2015	1 Year
ENA Series Network Analyzer	Agilent	E5071C	MY46214281	Jun. 23, 2015	1 Year
MXG Analog Signal Generator	Agilent	N5181A	MY50143868	Jul. 06, 2015	1 Year
Power Meter	Anritsu	ML2495A	1218009	Jul. 06, 2015	1 Year
Power Sensor	Anritsu	MA2411B	1207252	Jul. 06, 2015	1 Year
Thermometer	YFE	YF-160A	130504579	Aug. 21, 2014	1 Year





# FCC SAR Test Report

## 6. Measurement Uncertainty

Source of Uncertainty	Tolerance (± %)	Probability Distribution	Divisor	Ci (1g)	Ci (10g)	Standard Uncertainty (± %, 1g)	Standard Uncertainty (± %, 10g)	Vi
<b>Measurement System</b>								
Probe Calibration	6.0	Normal	1	1	1	6.0	6.0	∞
Axial Isotropy	4.7	Rectangular	√3	0.707	0.707	1.9	1.9	∞
Hemispherical Isotropy	9.6	Rectangular	√3	0.707	0.707	3.9	3.9	∞
Boundary Effect	1.0	Rectangular	√3	1	1	0.6	0.6	∞
Linearity	4.7	Rectangular	√3	1	1	2.7	2.7	∞
System Detection Limits	0.25	Rectangular	√3	1	1	0.14	0.14	∞
Readout Electronics	0.3	Normal	1	1	1	0.3	0.3	∞
Response Time	0.0	Rectangular	√3	1	1	0.0	0.0	∞
Integration Time	1.7	Rectangular	√3	1	1	1.0	1.0	∞
RF Ambient Conditions - Noise	3.0	Rectangular	√3	1	1	1.7	1.7	∞
RF Ambient Conditions - Reflections	3.0	Rectangular	√3	1	1	1.7	1.7	∞
Probe Positioner Mechanical Tolerance	0.4	Rectangular	√3	1	1	0.2	0.2	∞
Probe Positioning with Respect to Phantom Shell	2.9	Rectangular	√3	1	1	1.7	1.7	∞
Extrapolation, interpolation, and integration algorithms for max. SAR evaluation	2.0	Rectangular	√3	1	1	1.2	1.2	∞
<b>Test Sample Related</b>								
Test Sample Positioning	1.5 / 0.7	Normal	1	1	1	1.5	0.7	32
Device Holder Uncertainty	4.2 / 1.8	Normal	1	1	1	4.2	1.8	32
Output Power Variation - SAR Drift Measurement	5.0	Rectangular	√3	1	1	2.9	2.9	∞
<b>Phantom and Tissue Parameters</b>								
Phantom Uncertainty (Shape and Thickness Tolerances)	7.2	Rectangular	√3	1	1	4.2	4.2	∞
Liquid Conductivity - Deviation from Target Values	5.0	Rectangular	√3	0.64	0.43	1.8	1.2	∞
Liquid Conductivity - Measurement Uncertainty	1.0	Normal	1	0.64	0.43	0.6	0.4	25
Liquid Permittivity - Deviation from Target Values	5.0	Rectangular	√3	0.60	0.49	1.7	1.4	∞
Liquid Permittivity - Measurement Uncertainty	0.5	Normal	1	0.60	0.49	0.3	0.2	25
<b>Combined Standard Uncertainty</b>						± 11.2 %	± 10.4 %	
<b>Expanded Uncertainty (K=2)</b>						± 22.4 %	± 20.8 %	

Uncertainty budget for frequency range 300 MHz to 3 GHz



# FCC SAR Test Report

A D T

Source of Uncertainty	Tolerance (± %)	Probability Distribution	Divisor	Ci (1g)	Ci (10g)	Standard Uncertainty (± %, 1g)	Standard Uncertainty (± %, 10g)	Vi
<b>Measurement System</b>								
Probe Calibration	6.55	Normal	1	1	1	6.55	6.55	∞
Axial Isotropy	4.7	Rectangular	√3	0.707	0.707	1.9	1.9	∞
Hemispherical Isotropy	9.6	Rectangular	√3	0.707	0.707	3.9	3.9	∞
Boundary Effect	2.0	Rectangular	√3	1	1	1.2	1.2	∞
Linearity	4.7	Rectangular	√3	1	1	2.7	2.7	∞
System Detection Limits	0.25	Rectangular	√3	1	1	0.14	0.14	∞
Readout Electronics	0.3	Normal	1	1	1	0.3	0.3	∞
Response Time	0.0	Rectangular	√3	1	1	0.0	0.0	∞
Integration Time	1.7	Rectangular	√3	1	1	1.0	1.0	∞
RF Ambient Conditions - Noise	3.0	Rectangular	√3	1	1	1.7	1.7	∞
RF Ambient Conditions - Reflections	3.0	Rectangular	√3	1	1	1.7	1.7	∞
Probe Positioner Mechanical Tolerance	0.4	Rectangular	√3	1	1	0.2	0.2	∞
Probe Positioning with Respect to Phantom Shell	6.7	Rectangular	√3	1	1	3.9	3.9	∞
Extrapolation, interpolation, and integration algorithms for max. SAR evaluation	4.0	Rectangular	√3	1	1	2.3	2.3	∞
<b>Test Sample Related</b>								
Test Sample Positioning	1.5 / 0.7	Normal	1	1	1	1.5	0.7	32
Device Holder Uncertainty	4.2 / 1.8	Normal	1	1	1	4.2	1.8	32
Output Power Variation - SAR Drift Measurement	5.0	Rectangular	√3	1	1	2.9	2.9	∞
<b>Phantom and Tissue Parameters</b>								
Phantom Uncertainty (Shape and Thickness Tolerances)	7.6	Rectangular	√3	1	1	4.4	4.4	∞
Liquid Conductivity - Deviation from Target Values	5.0	Rectangular	√3	0.64	0.43	1.8	1.2	∞
Liquid Conductivity - Measurement Uncertainty	1.0	Normal	1	0.64	0.43	0.6	0.4	25
Liquid Permittivity - Deviation from Target Values	5.0	Rectangular	√3	0.60	0.49	1.7	1.4	∞
Liquid Permittivity - Measurement Uncertainty	0.5	Normal	1	0.60	0.49	0.3	0.2	25
<b>Combined Standard Uncertainty</b>						± 12.3 %	± 11.5 %	
<b>Expanded Uncertainty (K=2)</b>						± 24.6 %	± 23.0 %	

Uncertainty budget for frequency range 3 GHz to 6 GHz



## FCC SAR Test Report

---

### 7. Information on the Testing Laboratories

We, Bureau Veritas Consumer Products Services (H.K.) Ltd., Taoyuan Branch, were founded in 1988 to provide our best service in EMC, Radio, Telecom and Safety consultation. Our laboratories are accredited and approved according to ISO/IEC 17025.

If you have any comments, please feel free to contact us at the following:

**Taiwan HwaYa EMC/RF/Safety/Telecom Lab:**

Add: No.19, Hwa Ya 2nd Rd., Wen Hwa Vil., Kwei Shan Dist., Taoyuan City 33383, Taiwan, R.O.C.

Tel: 886-3-318-3232

Fax: 886-3-327-0892

**Taiwan LinKo EMC/RF Lab:**

Add: No. 47-2, 14th Ling, Chia Pau Vil., Linkou Dist., New Taipei City 244, Taiwan, R.O.C.

Tel: 886-2-2605-2180

Fax: 886-2-2605-1924

**Taiwan HsinChu EMC/RF Lab:**

Add: No. 81-1, Lu Liao Keng, 9<sup>th</sup> Ling, Wu Lung Vil., Chiung Lin Township, Hsinchu County 307, Taiwan, R.O.C.

Tel: 886-3-593-5343

Fax: 886-3-593-5342

**Email:** [service.adt@tw.bureauveritas.com](mailto:service.adt@tw.bureauveritas.com)

**Web Site:** [www.adt.com.tw](http://www.adt.com.tw)

The road map of all our labs can be found in our web site also.

---END---



## **Appendix A. SAR Plots of System Verification**

The plots for system verification with largest deviation for each SAR system combination are shown as follows.

## System Check\_B2450\_150817

**DUT: Dipole 2450 MHz; Type: D2450V2; SN: 835**

Communication System: CW; Frequency: 2450 MHz; Duty Cycle: 1:1

Medium: B19T27N3\_0817 Medium parameters used:  $f = 2450$  MHz;  $\sigma = 1.997$  S/m;  $\epsilon_r = 51.334$ ;  $\rho = 1000$  kg/m<sup>3</sup>

Ambient Temperature : 23.6 °C ; Liquid Temperature : 23.1 °C

DASY5 Configuration:

- Probe: EX3DV4 - SN3971; ConvF(7.12, 7.12, 7.12); Calibrated: 2015/03/26;
- Sensor-Surface: 1.4mm (Mechanical Surface Detection)
- Electronics: DAE4 Sn1431; Calibrated: 2015/03/20
- Phantom: ELI Phantom\_1245; Type: QDOVA;
- Measurement SW: DASY52, Version 52.8 (8); SEMCAD X Version 14.6.10 (7331)

**Pin=250mW/Area Scan (81x81x1):** Interpolated grid: dx=1.200 mm, dy=1.200 mm  
Maximum value of SAR (interpolated) = 19.2 W/kg

**Pin=250mW/Zoom Scan (7x7x7)/Cube 0:** Measurement grid: dx=5mm, dy=5mm, dz=5mm  
Reference Value = 97.07 V/m; Power Drift = 0.02 dB  
Peak SAR (extrapolated) = 25.8 W/kg  
**SAR(1 g) = 12.3 W/kg; SAR(10 g) = 5.71 W/kg**  
Maximum value of SAR (measured) = 18.9 W/kg

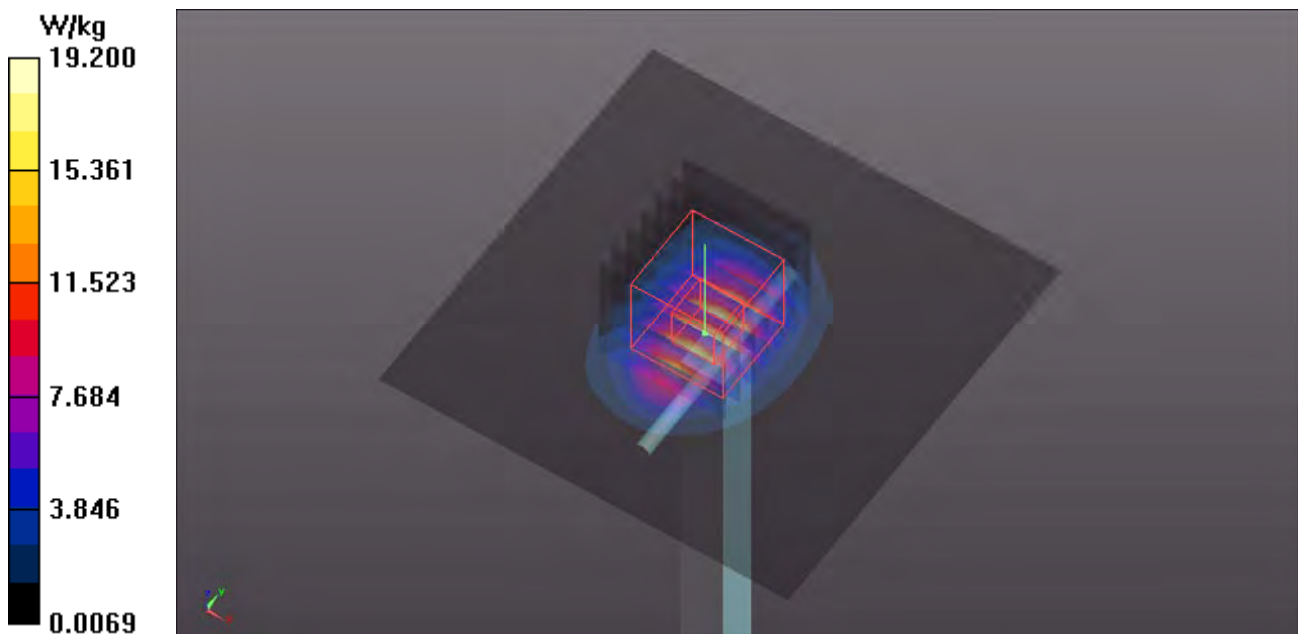

## System Check\_B5200\_150819

**DUT: Dipole 5 GHz; Type: D5GHzV2; SN: 1040**

Communication System: CW; Frequency: 5200 MHz; Duty Cycle: 1:1

Medium: B34T60N3\_0819 Medium parameters used:  $f = 5200$  MHz;  $\sigma = 5.321$  S/m;  $\epsilon_r = 47.346$ ;  $\rho = 1000$  kg/m<sup>3</sup>

Ambient Temperature : 23.5 °C ; Liquid Temperature : 23.0 °C

DASY5 Configuration:

- Probe: EX3DV4 - SN3864; ConvF(4.75, 4.75, 4.75); Calibrated: 2015/07/23;
- Sensor-Surface: 1.4mm (Mechanical Surface Detection)
- Electronics: DAE4 Sn915; Calibrated: 2015/06/11
- Phantom: ELI Phantom\_1039; Type: QDOVA;
- Measurement SW: DASY52, Version 52.8 (8); SEMCAD X Version 14.6.10 (7331)

**Pin=100mW/Area Scan (91x91x1):** Interpolated grid: dx=1.000 mm, dy=1.000 mm  
Maximum value of SAR (interpolated) = 15.4 W/kg

**Pin=100mW/Zoom Scan (7x7x12)/Cube 0:** Measurement grid: dx=4mm, dy=4mm, dz=2mm  
Reference Value = 59.31 V/m; Power Drift = -0.00 dB  
Peak SAR (extrapolated) = 29.3 W/kg  
**SAR(1 g) = 7.54 W/kg; SAR(10 g) = 2.16 W/kg**  
Maximum value of SAR (measured) = 15.7 W/kg

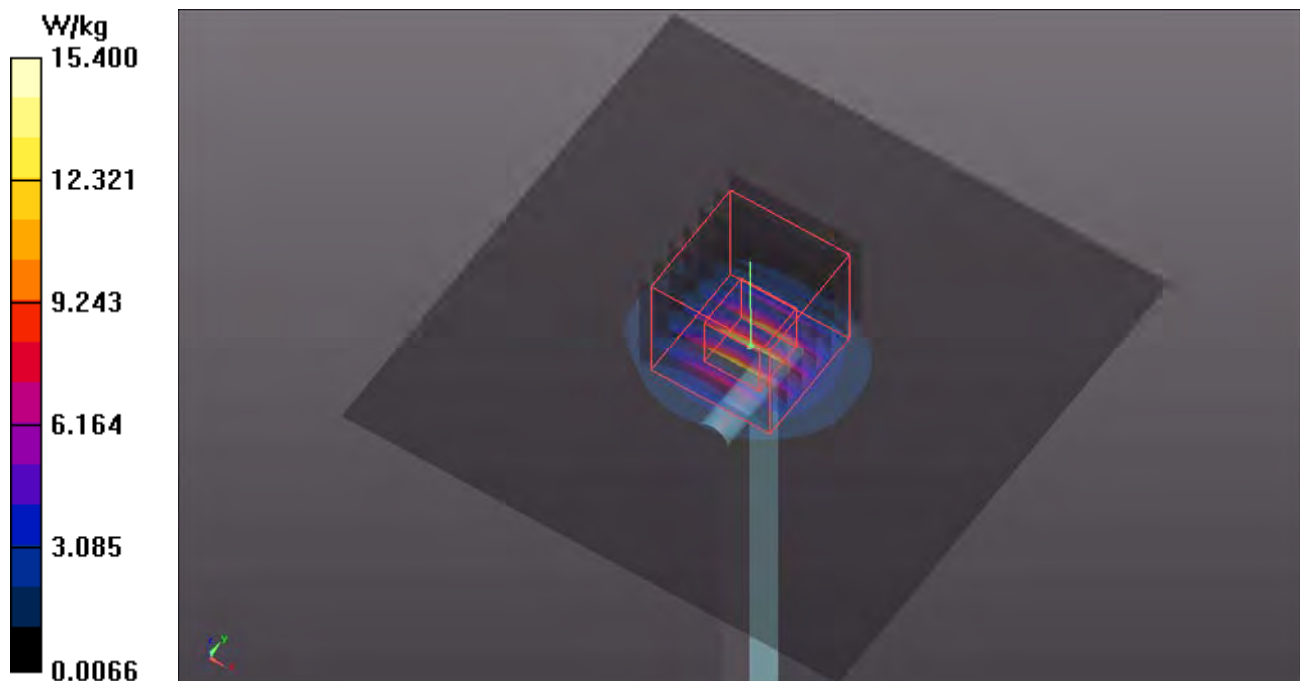

## System Check\_B5300\_150822

**DUT: Dipole 5 GHz; Type: D5GHzV2; SN: 1040**

Communication System: CW; Frequency: 5300 MHz; Duty Cycle: 1:1

Medium: B34T60N3\_0822 Medium parameters used:  $f = 5300$  MHz;  $\sigma = 5.488$  S/m;  $\epsilon_r = 47.439$ ;  $\rho = 1000$  kg/m<sup>3</sup>

Ambient Temperature : 23.7 °C ; Liquid Temperature : 23.3 °C

DASY5 Configuration:

- Probe: EX3DV4 - SN3864; ConvF(4.41, 4.41, 4.41); Calibrated: 2015/07/23;
- Sensor-Surface: 1.4mm (Mechanical Surface Detection)
- Electronics: DAE4 Sn915; Calibrated: 2015/06/11
- Phantom: ELI Phantom\_1039; Type: QDOVA;
- Measurement SW: DASY52, Version 52.8 (8); SEMCAD X Version 14.6.10 (7331)

**Pin=100mW/Area Scan (91x91x1):** Interpolated grid: dx=1.000 mm, dy=1.000 mm  
Maximum value of SAR (interpolated) = 16.7 W/kg

**Pin=100mW/Zoom Scan (7x7x12)/Cube 0:** Measurement grid: dx=4mm, dy=4mm, dz=2mm  
Reference Value = 60.30 V/m; Power Drift = 0.01 dB  
Peak SAR (extrapolated) = 31.1 W/kg  
**SAR(1 g) = 7.89 W/kg; SAR(10 g) = 2.24 W/kg**  
Maximum value of SAR (measured) = 16.3 W/kg

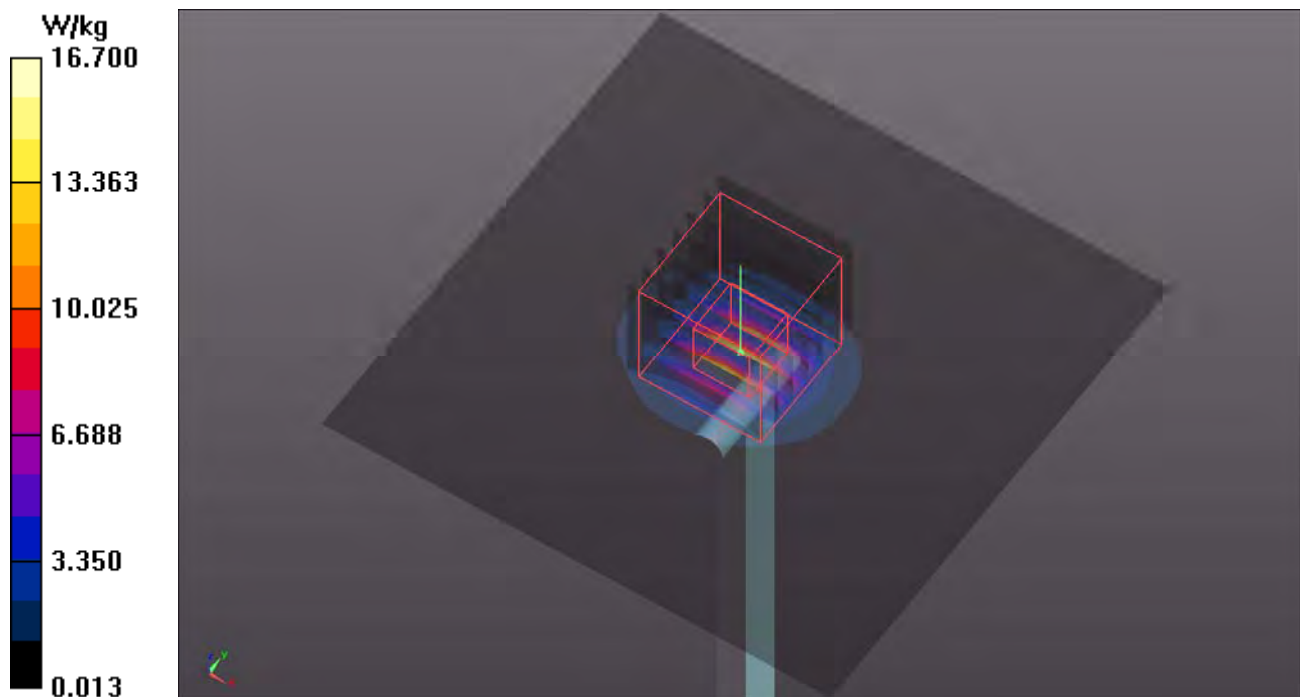

## System Check\_B5600\_150822

**DUT: Dipole 5 GHz; Type: D5GHzV2; SN: 1040**

Communication System: CW; Frequency: 5600 MHz; Duty Cycle: 1:1

Medium: B34T60N3\_0822 Medium parameters used:  $f = 5600$  MHz;  $\sigma = 5.894$  S/m;  $\epsilon_r = 46.817$ ;  $\rho = 1000$  kg/m<sup>3</sup>

Ambient Temperature : 23.7 °C ; Liquid Temperature : 23.3 °C

DASY5 Configuration:

- Probe: EX3DV4 - SN3864; ConvF(3.93, 3.93, 3.93); Calibrated: 2015/07/23;
- Sensor-Surface: 1.4mm (Mechanical Surface Detection)
- Electronics: DAE4 Sn915; Calibrated: 2015/06/11
- Phantom: ELI Phantom\_1039; Type: QDOVA;
- Measurement SW: DASY52, Version 52.8 (8); SEMCAD X Version 14.6.10 (7331)

**Pin=100mW/Area Scan (91x91x1):** Interpolated grid: dx=1.000 mm, dy=1.000 mm  
Maximum value of SAR (interpolated) = 17.9 W/kg

**Pin=100mW/Zoom Scan (7x7x12)/Cube 0:** Measurement grid: dx=4mm, dy=4mm, dz=2mm  
Reference Value = 56.54 V/m; Power Drift = 0.08 dB

Peak SAR (extrapolated) = 34.8 W/kg

**SAR(1 g) = 8.06 W/kg; SAR(10 g) = 2.27 W/kg**

Maximum value of SAR (measured) = 17.4 W/kg

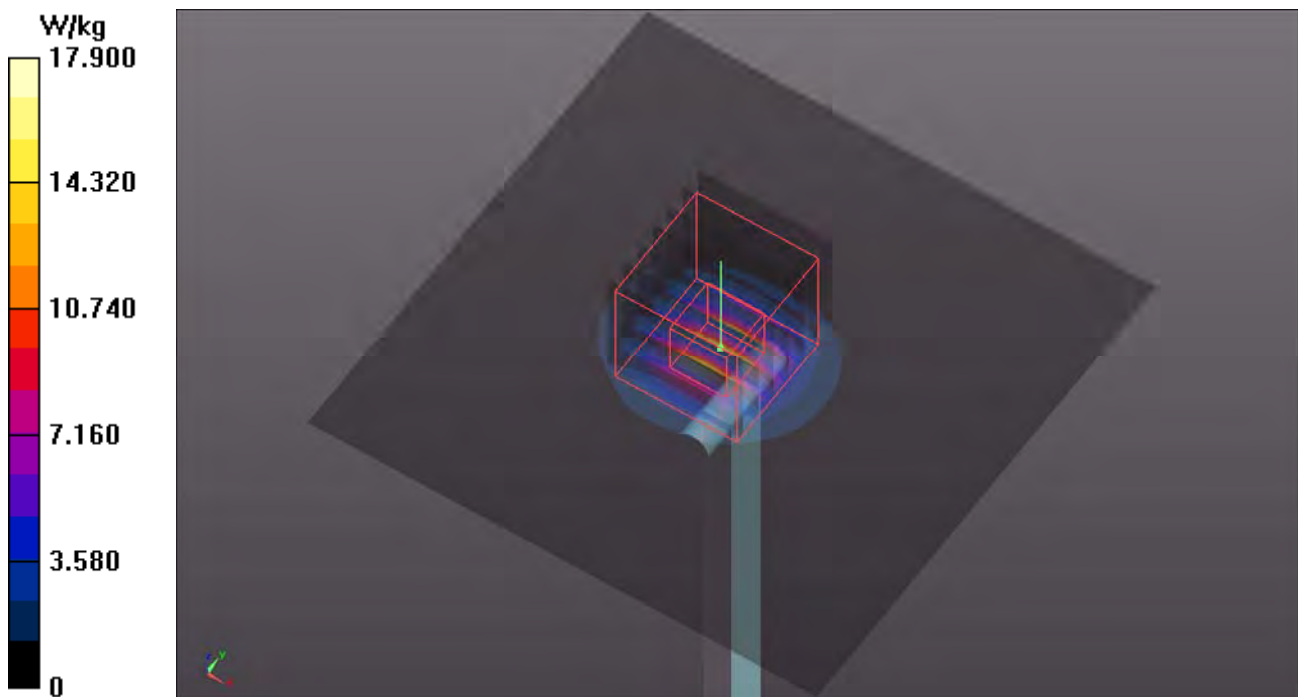



## System Check\_B5800\_150819

**DUT: Dipole 5 GHz; Type: D5GHzV2; SN: 1040**

Communication System: CW; Frequency: 5800 MHz; Duty Cycle: 1:1

Medium: B34T60N3\_0819 Medium parameters used:  $f = 5800$  MHz;  $\sigma = 6.176$  S/m;  $\epsilon_r = 46.237$ ;  $\rho = 1000$  kg/m<sup>3</sup>

Ambient Temperature : 23.6 °C ; Liquid Temperature : 23.4 °C

DASY5 Configuration:

- Probe: EX3DV4 - SN3864; ConvF(4.2, 4.2, 4.2); Calibrated: 2015/07/23;
- Sensor-Surface: 1.4mm (Mechanical Surface Detection)
- Electronics: DAE4 Sn915; Calibrated: 2015/06/11
- Phantom: ELI Phantom\_1039; Type: QDOVA;
- Measurement SW: DASY52, Version 52.8 (8); SEMCAD X Version 14.6.10 (7331)

**Pin=100mW/Area Scan (91x91x1):** Interpolated grid: dx=1.000 mm, dy=1.000 mm  
Maximum value of SAR (interpolated) = 14.2 W/kg

**Pin=100mW/Zoom Scan (7x7x12)/Cube 0:** Measurement grid: dx=4mm, dy=4mm, dz=2mm  
Reference Value = 52.82 V/m; Power Drift = 0.01 dB  
Peak SAR (extrapolated) = 29.8 W/kg  
**SAR(1 g) = 7.01 W/kg; SAR(10 g) = 1.97 W/kg**  
Maximum value of SAR (measured) = 15.1 W/kg

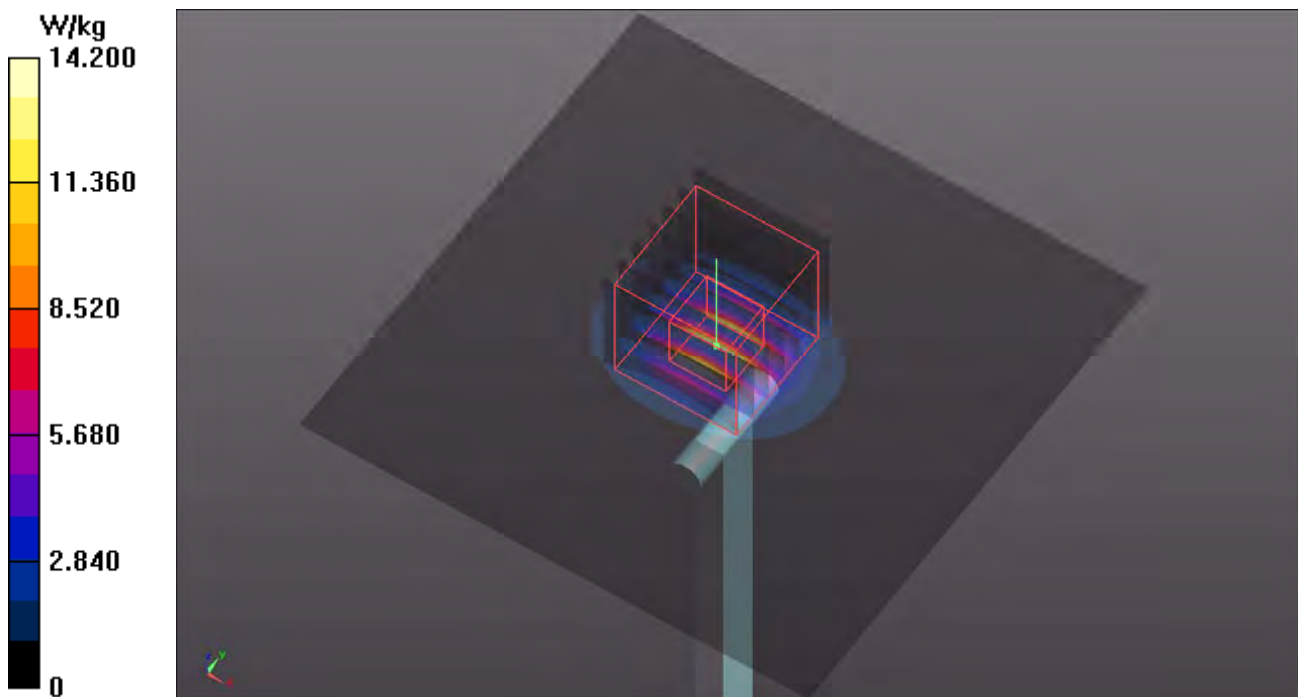



## Appendix B. SAR Plots of SAR Measurement

The SAR plots for highest measured SAR in each exposure configuration, wireless mode and frequency band combination, and measured SAR > 1.5 W/kg are shown as follows.

## P01 2.4G WLAN\_802.11b\_Left Side\_0cm\_Ch6\_Tablet\_Ant1

**DUT: 150722C27**

Communication System: WLAN\_2.4G; Frequency: 2437 MHz; Duty Cycle: 1:1

Medium: B19T27N1\_0819 Medium parameters used:  $f = 2437$  MHz;  $\sigma = 2.005$  S/m;  $\epsilon_r = 50.944$ ;  $\rho = 1000$  kg/m<sup>3</sup>

Ambient Temperature : 23.9 °C ; Liquid Temperature : 23.5 °C

DASY5 Configuration:

- Probe: EX3DV4 - SN3864; ConvF(7.3, 7.3, 7.3); Calibrated: 2015/07/23;
- Sensor-Surface: 1.4mm (Mechanical Surface Detection)
- Electronics: DAE4 Sn915; Calibrated: 2015/06/11
- Phantom: ELI Phantom\_1039; Type: QDOVA;
- Measurement SW: DASY52, Version 52.8 (8); SEMCAD X Version 14.6.10 (7331)

- **Area Scan (71x221x1):** Interpolated grid: dx=1.200 mm, dy=1.200 mm

Maximum value of SAR (interpolated) = 0.496 W/kg

- **Zoom Scan (5x5x7)/Cube 0:** Measurement grid: dx=8mm, dy=8mm, dz=5mm

Reference Value = 2.880 V/m; Power Drift = 0.04 dB

Peak SAR (extrapolated) = 0.584 W/kg

**SAR(1 g) = 0.256 W/kg; SAR(10 g) = 0.119 W/kg**

Maximum value of SAR (measured) = 0.404 W/kg

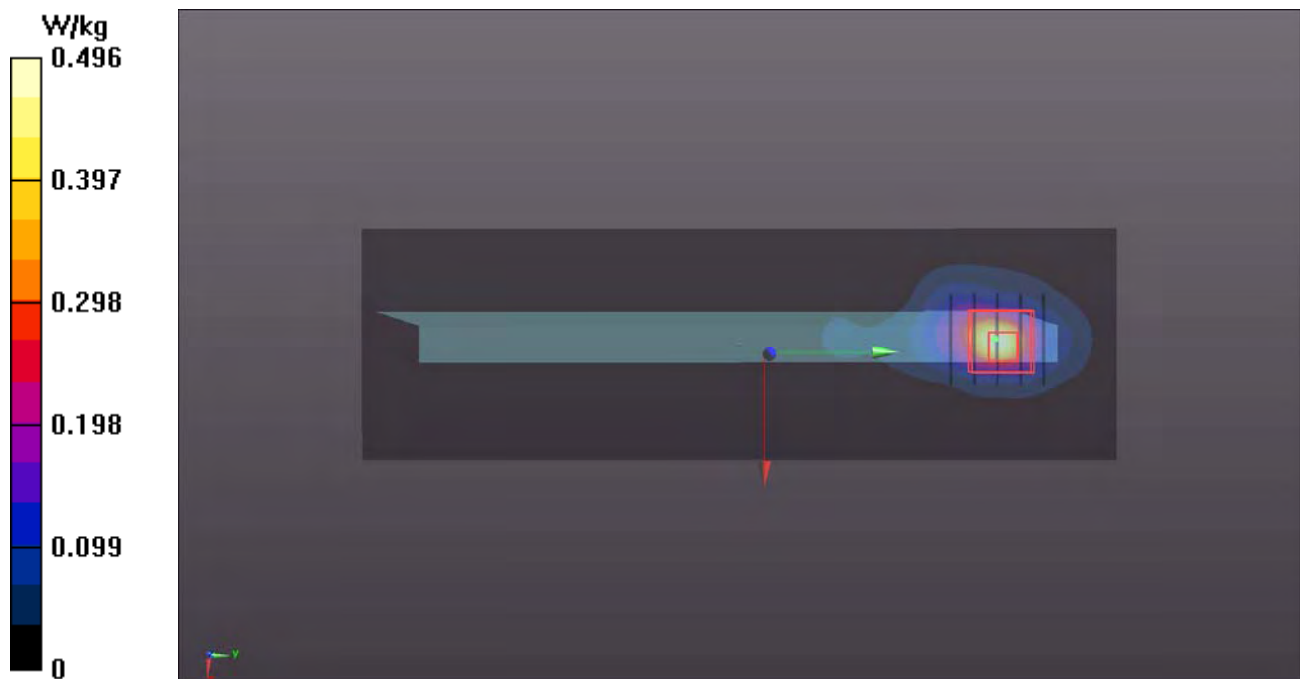

## P02 5.2G WLAN\_802.11n HT20\_Top Side\_0cm\_Ch44\_Tablet\_Ant0+1

**DUT: 150722C27**

Communication System: WLAN\_5G; Frequency: 5220 MHz; Duty Cycle: 1:1.07

Medium: B34T60N3\_0819 Medium parameters used:  $f = 5220$  MHz;  $\sigma = 5.361$  S/m;  $\epsilon_r = 47.305$ ;  $\rho = 1000$  kg/m<sup>3</sup>

Ambient Temperature : 23.9 °C ; Liquid Temperature : 23.5 °C

DASY5 Configuration:

- Probe: EX3DV4 - SN3864; ConvF(4.75, 4.75, 4.75); Calibrated: 2015/07/23;
- Sensor-Surface: 1.4mm (Mechanical Surface Detection)
- Electronics: DAE4 Sn915; Calibrated: 2015/06/11
- Phantom: ELI Phantom\_1039; Type: QDOVA;
- Measurement SW: DASY52, Version 52.8 (8); SEMCAD X Version 14.6.10 (7331)

- **Area Scan (81x341x1):** Interpolated grid: dx=1.000 mm, dy=1.000 mm

Maximum value of SAR (interpolated) = 0.523 W/kg

- **Zoom Scan (6x6x12)/Cube 0:** Measurement grid: dx=5mm, dy=5mm, dz=2mm

Reference Value = 3.708 V/m; Power Drift = -0.05 dB

Peak SAR (extrapolated) = 1.45 W/kg

**SAR(1 g) = 0.366 W/kg; SAR(10 g) = 0.134 W/kg**

Maximum value of SAR (measured) = 0.827 W/kg

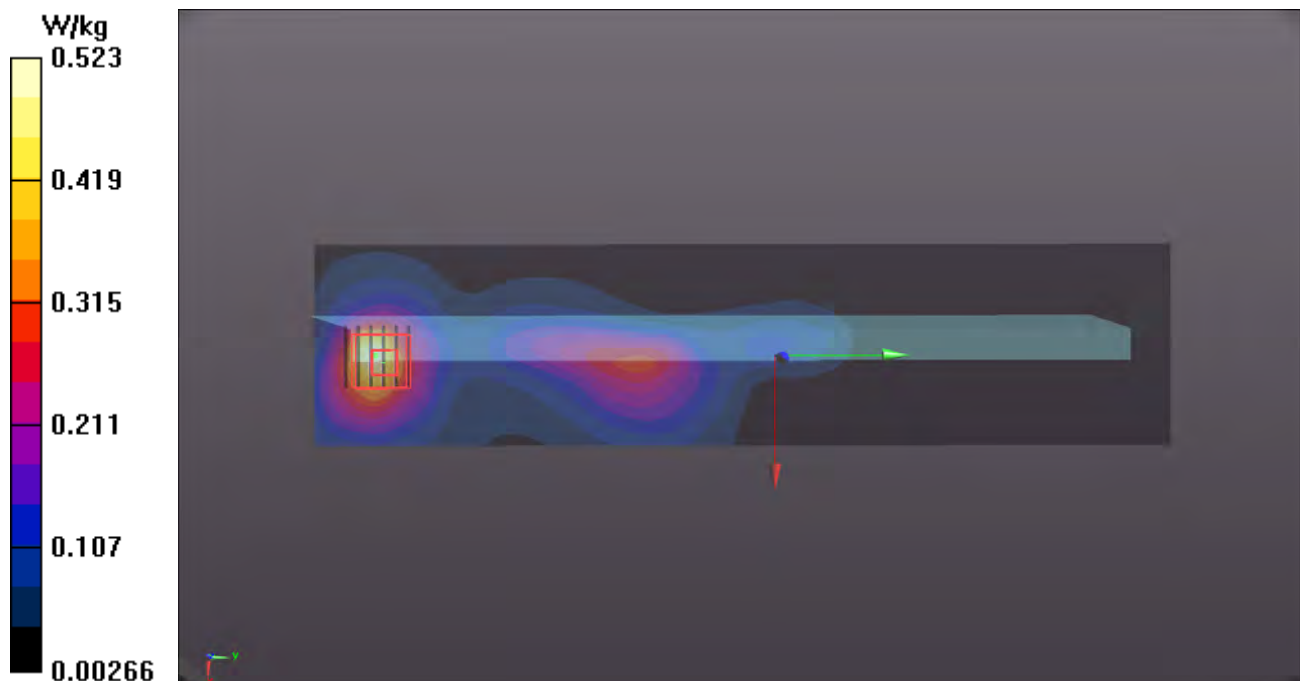

### P03 5.3G WLAN\_802.11a\_Top Side\_0cm\_Ch56\_Tablet\_Ant1

**DUT: 150722C27**

Communication System: WLAN\_5G; Frequency: 5280 MHz; Duty Cycle: 1:1

Medium: B34T60N3\_0819 Medium parameters used:  $f = 5280$  MHz;  $\sigma = 5.437$  S/m;  $\epsilon_r = 47.261$ ;  $\rho = 1000$  kg/m<sup>3</sup>

Ambient Temperature : 23.9 °C; Liquid Temperature : 23.5 °C

DASY5 Configuration:

- Probe: EX3DV4 - SN3864; ConvF(4.41, 4.41, 4.41); Calibrated: 2015/07/23;
- Sensor-Surface: 1.4mm (Mechanical Surface Detection)
- Electronics: DAE4 Sn915; Calibrated: 2015/06/11
- Phantom: ELI Phantom\_1039; Type: QDOVA;
- Measurement SW: DASY52, Version 52.8 (8); SEMCAD X Version 14.6.10 (7331)

- **Area Scan (101x361x1):** Interpolated grid: dx=1.000 mm, dy=1.000 mm

Maximum value of SAR (interpolated) = 0.785 W/kg

- **Zoom Scan (6x6x12)/Cube 0:** Measurement grid: dx=5mm, dy=5mm, dz=2mm

Reference Value = 2.382 V/m; Power Drift = 0.06 dB

Peak SAR (extrapolated) = 1.40 W/kg

**SAR(1 g) = 0.347 W/kg; SAR(10 g) = 0.122 W/kg**

Maximum value of SAR (measured) = 0.824 W/kg

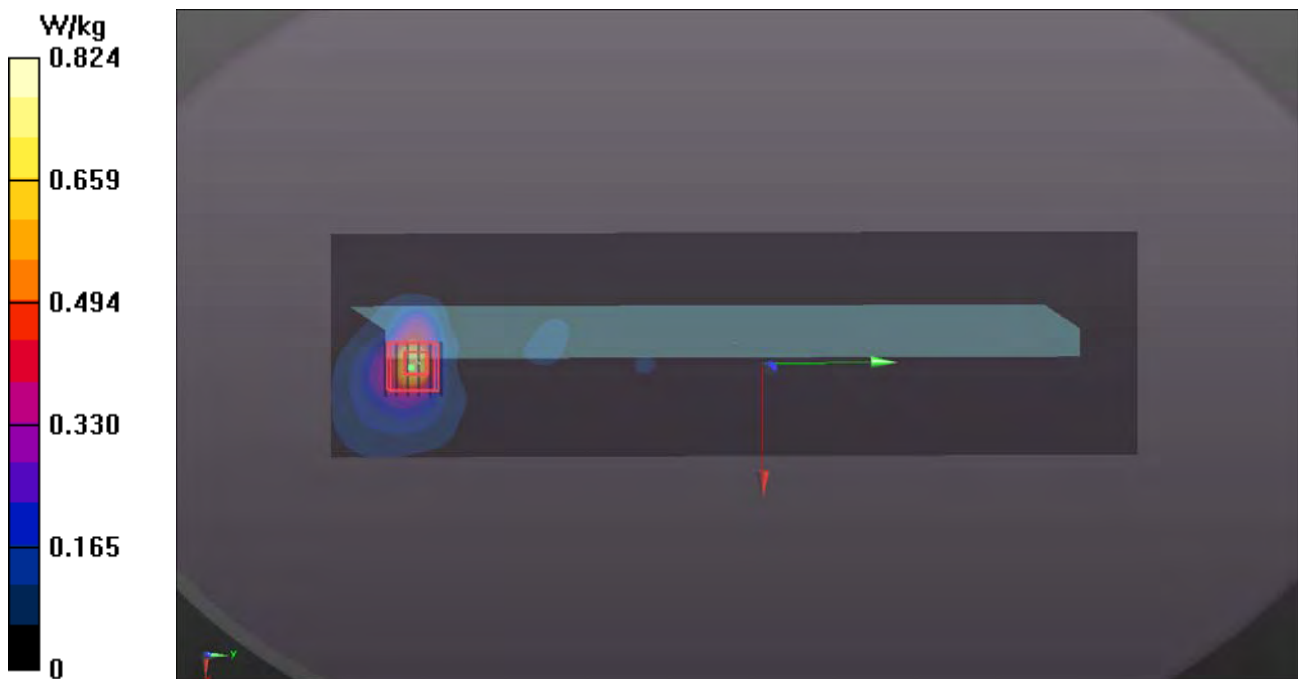

### P04 5.6G WLAN\_802.11n HT20\_Top Side\_0cm\_Ch116\_Tablet\_Ant0+1

**DUT: 150722C27**

Communication System: WLAN\_5G; Frequency: 5580 MHz; Duty Cycle: 1:1.07

Medium: B34T60N3\_0819 Medium parameters used:  $f = 5580$  MHz;  $\sigma = 5.867$  S/m;  $\epsilon_r = 46.645$ ;  $\rho = 1000$  kg/m<sup>3</sup>

Ambient Temperature : 23.9 °C ; Liquid Temperature : 23.5 °C

DASY5 Configuration:

- Probe: EX3DV4 - SN3864; ConvF(3.93, 3.93, 3.93); Calibrated: 2015/07/23;
- Sensor-Surface: 1.4mm (Mechanical Surface Detection)
- Electronics: DAE4 Sn915; Calibrated: 2015/06/11
- Phantom: ELI Phantom\_1039; Type: QDOVA;
- Measurement SW: DASY52, Version 52.8 (8); SEMCAD X Version 14.6.10 (7331)

- **Area Scan (81x361x1):** Interpolated grid: dx=1.000 mm, dy=1.000 mm

Maximum value of SAR (interpolated) = 0.607 W/kg

- **Zoom Scan (6x6x12)/Cube 0:** Measurement grid: dx=5mm, dy=5mm, dz=2mm

Reference Value = 4.112 V/m; Power Drift = -0.03 dB

Peak SAR (extrapolated) = 1.82 W/kg

**SAR(1 g) = 0.429 W/kg; SAR(10 g) = 0.141 W/kg**

Maximum value of SAR (measured) = 0.981 W/kg

- **Zoom Scan (6x6x12)/Cube 1:** Measurement grid: dx=5mm, dy=5mm, dz=2mm

Reference Value = 4.112 V/m; Power Drift = -0.03 dB

Peak SAR (extrapolated) = 1.72 W/kg

**SAR(1 g) = 0.382 W/kg; SAR(10 g) = 0.115 W/kg**

Maximum value of SAR (measured) = 0.915 W/kg

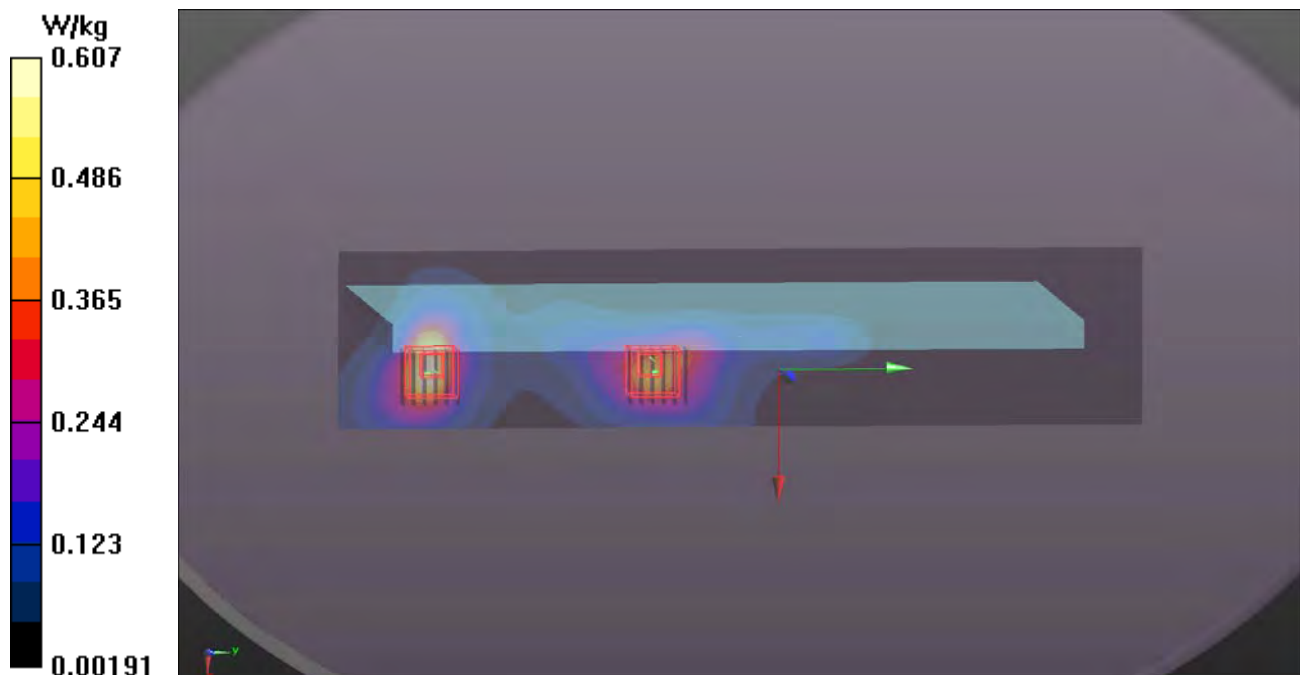

### P05 5.8G WLAN\_802.11n HT20\_Top Side\_0cm\_Ch157\_Tablet\_Ant0+1

**DUT: 150722C27**

Communication System: WLAN\_5G; Frequency: 5785 MHz; Duty Cycle: 1:1.07

Medium: B34T60N3\_0819 Medium parameters used:  $f = 5785$  MHz;  $\sigma = 6.153$  S/m;  $\epsilon_r = 46.248$ ;  $\rho = 1000$  kg/m<sup>3</sup>

Ambient Temperature : 23.6 °C ; Liquid Temperature : 23.4 °C

DASY5 Configuration:

- Probe: EX3DV4 - SN3864; ConvF(4.2, 4.2, 4.2); Calibrated: 2015/07/23;
- Sensor-Surface: 1.4mm (Mechanical Surface Detection)
- Electronics: DAE4 Sn915; Calibrated: 2015/06/11
- Phantom: ELI Phantom\_1039; Type: QDOVA;
- Measurement SW: DASY52, Version 52.8 (8); SEMCAD X Version 14.6.10 (7331)

- **Area Scan (81x341x1):** Interpolated grid: dx=1.000 mm, dy=1.000 mm

Maximum value of SAR (interpolated) = 1.11 W/kg

- **Zoom Scan (6x6x12)/Cube 0:** Measurement grid: dx=5mm, dy=5mm, dz=2mm

Reference Value = 3.881 V/m; Power Drift = 0.06 dB

Peak SAR (extrapolated) = 3.05 W/kg

**SAR(1 g) = 0.652 W/kg; SAR(10 g) = 0.209 W/kg**

Maximum value of SAR (measured) = 1.62 W/kg

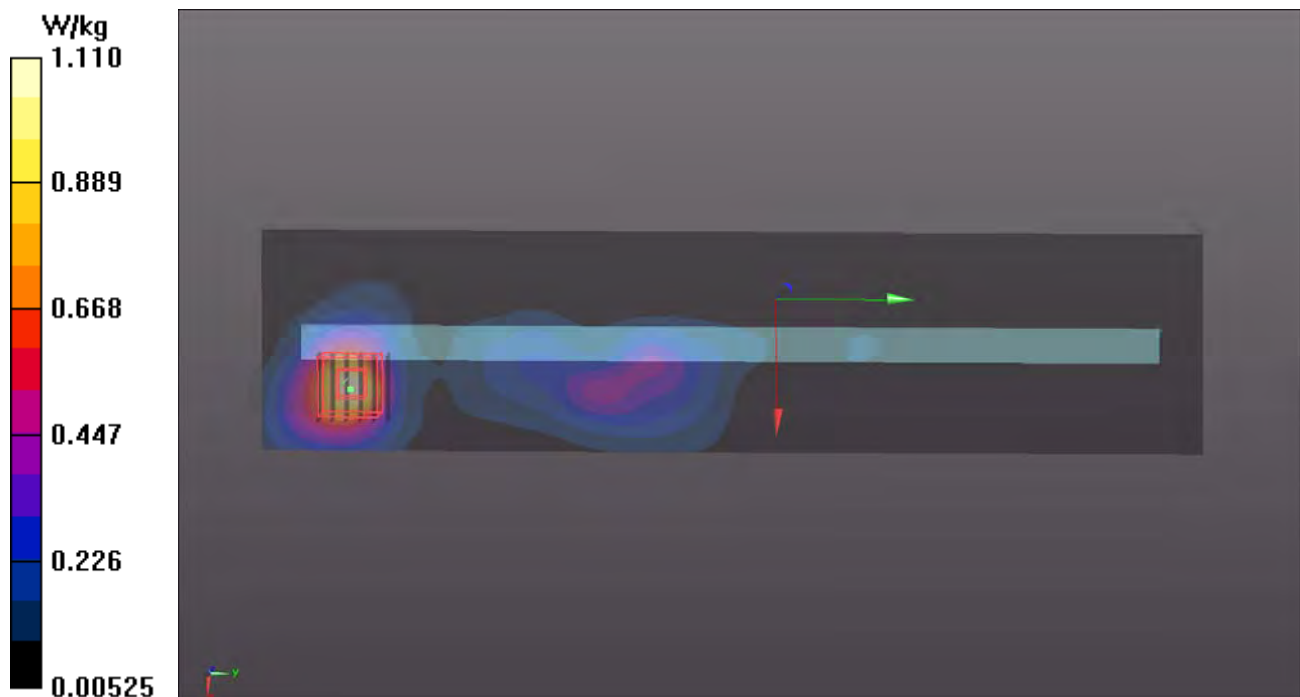

### P06 2.4G WLAN\_802.11b\_Top Side\_2.5cm\_Ch6\_NB\_Ant0

**DUT: 150722C27**

Communication System: WLAN\_2.4G; Frequency: 2437 MHz; Duty Cycle: 1:1

Medium: B19T27N2\_0823 Medium parameters used:  $f = 2437$  MHz;  $\sigma = 1.995$  S/m;  $\epsilon_r = 52.189$ ;  $\rho = 1000$  kg/m<sup>3</sup>

Ambient Temperature : 23.5 °C ; Liquid Temperature : 23.2 °C

DASY5 Configuration:

- Probe: EX3DV4 - SN3864; ConvF(7.3, 7.3, 7.3); Calibrated: 2015/07/23;
- Sensor-Surface: 1.4mm (Mechanical Surface Detection)
- Electronics: DAE4 Sn915; Calibrated: 2015/06/11
- Phantom: ELI Phantom\_1039; Type: QDOVA;
- Measurement SW: DASY52, Version 52.8 (8); SEMCAD X Version 14.6.10 (7331)

- **Area Scan (71x301x1):** Interpolated grid: dx=1.200 mm, dy=1.200 mm

Maximum value of SAR (interpolated) = 0.0436 W/kg

- **Zoom Scan (5x5x7)/Cube 0:** Measurement grid: dx=8mm, dy=8mm, dz=5mm

Reference Value = 2.388 V/m; Power Drift = -0.06 dB

Peak SAR (extrapolated) = 0.0520 W/kg

**SAR(1 g) = 0.029 W/kg; SAR(10 g) = 0.016 W/kg**

Maximum value of SAR (measured) = 0.0431 W/kg

- **Zoom Scan (5x5x7)/Cube 1:** Measurement grid: dx=8mm, dy=8mm, dz=5mm

Reference Value = 2.388 V/m; Power Drift = -0.06 dB

Peak SAR (extrapolated) = 0.0720 W/kg

**SAR(1 g) = 0.021 W/kg; SAR(10 g) = 0.011 W/kg**

Maximum value of SAR (measured) = 0.0295 W/kg

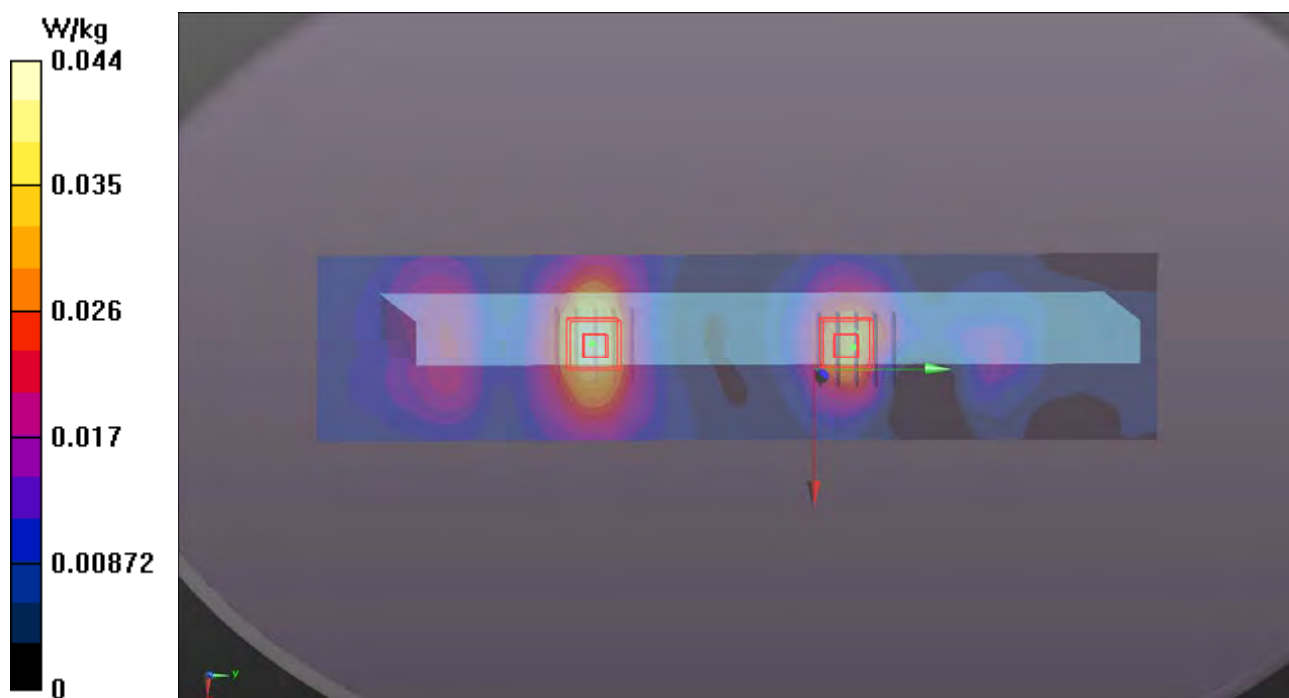



### P07 5.2G WLAN\_802.11n HT20\_Left Side\_2.5cm\_Ch44\_NB\_Ant0+1

**DUT: 150722C27**

Communication System: WLAN\_5G; Frequency: 5220 MHz; Duty Cycle: 1:1.07

Medium: B34T60N3\_0822 Medium parameters used:  $f = 5220$  MHz;  $\sigma = 5.369$  S/m;  $\epsilon_r = 47.624$ ;  $\rho = 1000$  kg/m<sup>3</sup>

Ambient Temperature : 23.7 °C ; Liquid Temperature : 23.3 °C

DASY5 Configuration:

- Probe: EX3DV4 - SN3864; ConvF(4.75, 4.75, 4.75); Calibrated: 2015/07/23;
- Sensor-Surface: 1.4mm (Mechanical Surface Detection)
- Electronics: DAE4 Sn915; Calibrated: 2015/06/11
- Phantom: ELI Phantom\_1039; Type: QDOVA;
- Measurement SW: DASY52, Version 52.8 (8); SEMCAD X Version 14.6.10 (7331)

- **Area Scan (81x281x1):** Interpolated grid: dx=1.000 mm, dy=1.000 mm

Maximum value of SAR (interpolated) = 0.151 W/kg

- **Zoom Scan (6x6x12)/Cube 0:** Measurement grid: dx=5mm, dy=5mm, dz=2mm

Reference Value = 3.113 V/m; Power Drift = -0.04 dB

Peak SAR (extrapolated) = 0.269 W/kg

**SAR(1 g) = 0.070 W/kg; SAR(10 g) = 0.029 W/kg**

Maximum value of SAR (measured) = 0.155 W/kg

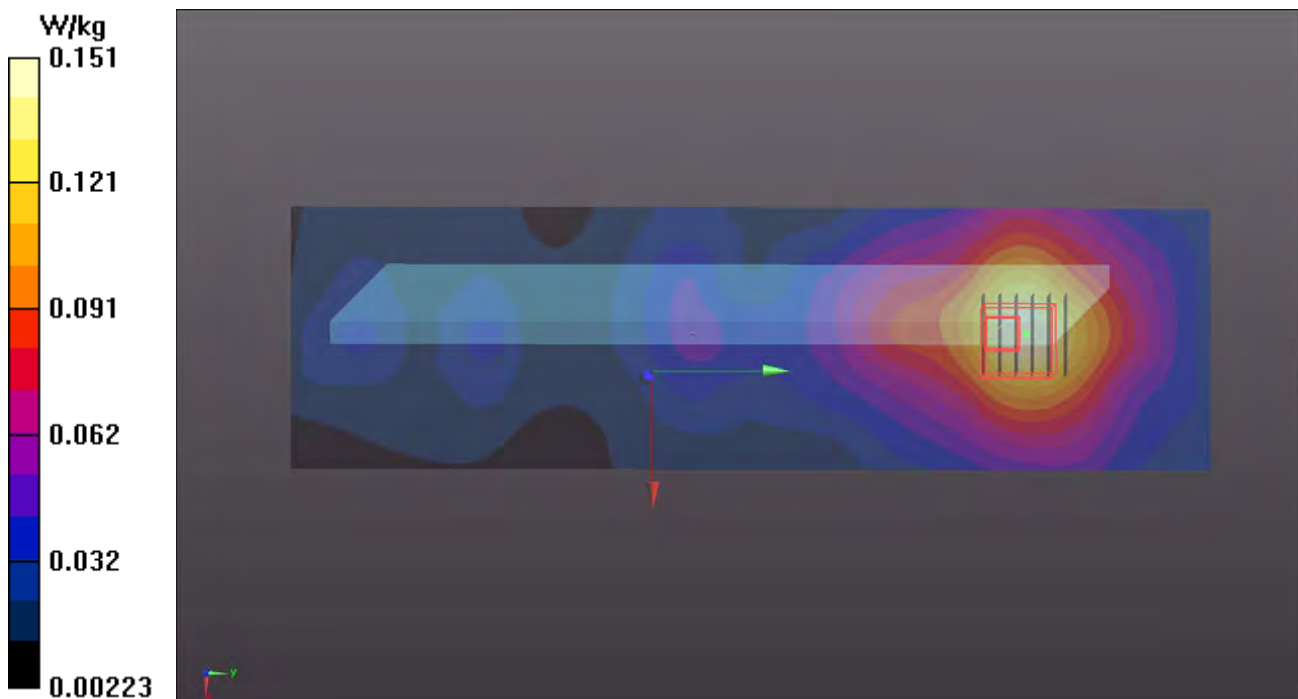

### P08 5.3G WLAN\_802.11a\_Top Side\_2.5cm\_Ch56\_NB\_Ant1

**DUT: 150722C27**

Communication System: WLAN\_5G; Frequency: 5280 MHz; Duty Cycle: 1:1

Medium: B34T60N3\_0822 Medium parameters used:  $f = 5280$  MHz;  $\sigma = 5.454$  S/m;  $\epsilon_r = 47.457$ ;  $\rho = 1000$  kg/m<sup>3</sup>

Ambient Temperature : 23.7 °C; Liquid Temperature : 23.3 °C

DASY5 Configuration:

- Probe: EX3DV4 - SN3864; ConvF(4.41, 4.41, 4.41); Calibrated: 2015/07/23;
- Sensor-Surface: 1.4mm (Mechanical Surface Detection)
- Electronics: DAE4 Sn915; Calibrated: 2015/06/11
- Phantom: ELI Phantom\_1039; Type: QDOVA;
- Measurement SW: DASY52, Version 52.8 (8); SEMCAD X Version 14.6.10 (7331)

- **Area Scan (81x361x1):** Interpolated grid: dx=1.000 mm, dy=1.000 mm

Maximum value of SAR (interpolated) = 0.148 W/kg

- **Zoom Scan (6x6x12)/Cube 0:** Measurement grid: dx=5mm, dy=5mm, dz=2mm

Reference Value = 1.420 V/m; Power Drift = -0.03 dB

Peak SAR (extrapolated) = 0.223 W/kg

**SAR(1 g) = 0.059 W/kg; SAR(10 g) = 0.024 W/kg**

Maximum value of SAR (measured) = 0.131 W/kg



### P09 5.6G WLAN\_802.11n HT20\_Left Side\_2.5cm\_Ch116\_NB\_Ant0+1

**DUT: 150722C27**

Communication System: WLAN\_5G; Frequency: 5580 MHz; Duty Cycle: 1:1.07

Medium: B34T60N3\_0822 Medium parameters used:  $f = 5580$  MHz;  $\sigma = 5.86$  S/m;  $\epsilon_r = 46.89$ ;  $\rho = 1000$  kg/m<sup>3</sup>

Ambient Temperature : 23.7 °C ; Liquid Temperature : 23.3 °C

DASY5 Configuration:

- Probe: EX3DV4 - SN3864; ConvF(3.93, 3.93, 3.93); Calibrated: 2015/07/23;
- Sensor-Surface: 1.4mm (Mechanical Surface Detection)
- Electronics: DAE4 Sn915; Calibrated: 2015/06/11
- Phantom: ELI Phantom\_1039; Type: QDOVA;
- Measurement SW: DASY52, Version 52.8 (8); SEMCAD X Version 14.6.10 (7331)

- **Area Scan (81x281x1):** Interpolated grid: dx=1.000 mm, dy=1.000 mm

Maximum value of SAR (interpolated) = 0.154 W/kg

- **Zoom Scan (6x6x12)/Cube 0:** Measurement grid: dx=5mm, dy=5mm, dz=2mm

Reference Value = 2.382 V/m; Power Drift = -0.03 dB

Peak SAR (extrapolated) = 0.277 W/kg

**SAR(1 g) = 0.069 W/kg; SAR(10 g) = 0.030 W/kg**

Maximum value of SAR (measured) = 0.165 W/kg

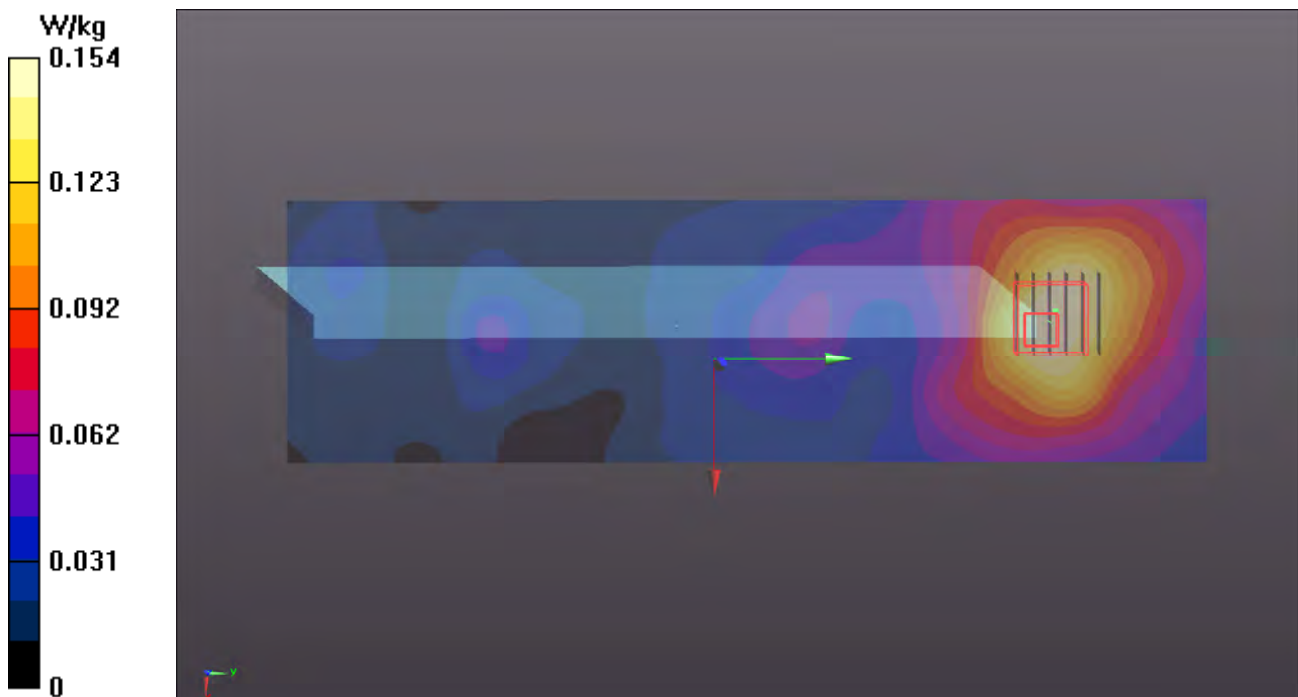

### P10 5.8G WLAN\_802.11n HT20\_Left Side\_2.5cm\_Ch157\_NB\_Ant0+1

**DUT: 150722C27**

Communication System: WLAN\_5G; Frequency: 5785 MHz; Duty Cycle: 1:1.07

Medium: B34T60N3\_0822 Medium parameters used:  $f = 5785$  MHz;  $\sigma = 6.159$  S/m;  $\epsilon_r = 46.545$ ;  $\rho = 1000$  kg/m<sup>3</sup>

Ambient Temperature : 23.7 °C ; Liquid Temperature : 23.3 °C

DASY5 Configuration:

- Probe: EX3DV4 - SN3864; ConvF(4.2, 4.2, 4.2); Calibrated: 2015/07/23;
- Sensor-Surface: 1.4mm (Mechanical Surface Detection)
- Electronics: DAE4 Sn915; Calibrated: 2015/06/11
- Phantom: ELI Phantom\_1039; Type: QDOVA;
- Measurement SW: DASY52, Version 52.8 (8); SEMCAD X Version 14.6.10 (7331)

- **Area Scan (81x281x1):** Interpolated grid: dx=1.000 mm, dy=1.000 mm

Maximum value of SAR (interpolated) = 0.263 W/kg

- **Zoom Scan (6x6x12)/Cube 0:** Measurement grid: dx=5mm, dy=5mm, dz=2mm

Reference Value = 2.967 V/m; Power Drift = -0.09 dB

Peak SAR (extrapolated) = 0.421 W/kg

**SAR(1 g) = 0.102 W/kg; SAR(10 g) = 0.045 W/kg**

Maximum value of SAR (measured) = 0.248 W/kg

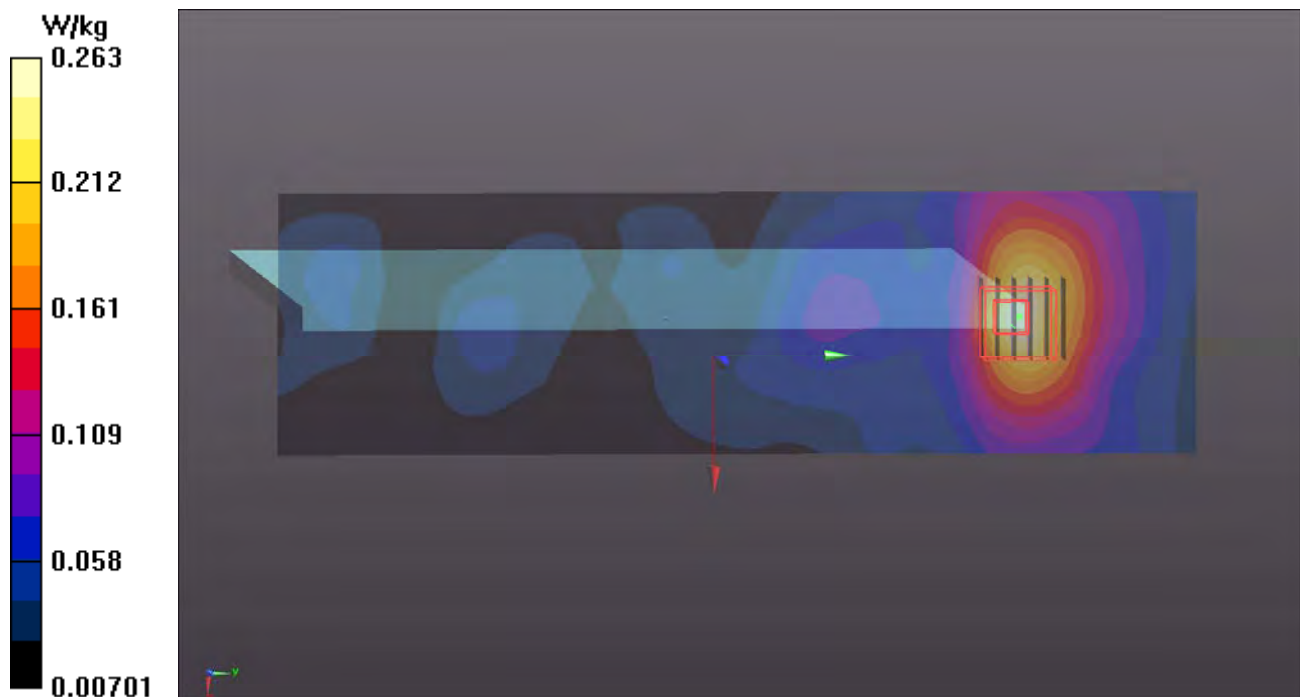

## P11 2.4G WLAN\_802.11b\_Left Side\_0cm\_Ch6\_Tablet\_Ant1

**DUT: 150722C27**

Communication System: WLAN\_2.4G; Frequency: 2437 MHz; Duty Cycle: 1:1

Medium: B19T27N3\_0817 Medium parameters used:  $f = 2437$  MHz;  $\sigma = 1.982$  S/m;  $\epsilon_r = 51.361$ ;  $\rho = 1000$  kg/m<sup>3</sup>

Ambient Temperature : 23.6 °C ; Liquid Temperature : 23.1 °C

DASY5 Configuration:

- Probe: EX3DV4 - SN3971; ConvF(7.12, 7.12, 7.12); Calibrated: 2015/03/26;
- Sensor-Surface: 1.4mm (Mechanical Surface Detection)
- Electronics: DAE4 Sn1431; Calibrated: 2015/03/20
- Phantom: ELI Phantom\_1245; Type: QDOVA;
- Measurement SW: DASY52, Version 52.8 (8); SEMCAD X Version 14.6.10 (7331)

- **Area Scan (71x201x1):** Interpolated grid: dx=1.200 mm, dy=1.200 mm

Maximum value of SAR (interpolated) = 0.977 W/kg

- **Zoom Scan (5x5x7)/Cube 0:** Measurement grid: dx=8mm, dy=8mm, dz=5mm

Reference Value = 4.473 V/m; Power Drift = -0.04 dB

Peak SAR (extrapolated) = 1.51 W/kg

**SAR(1 g) = 0.650 W/kg; SAR(10 g) = 0.340 W/kg**

Maximum value of SAR (measured) = 1.13 W/kg

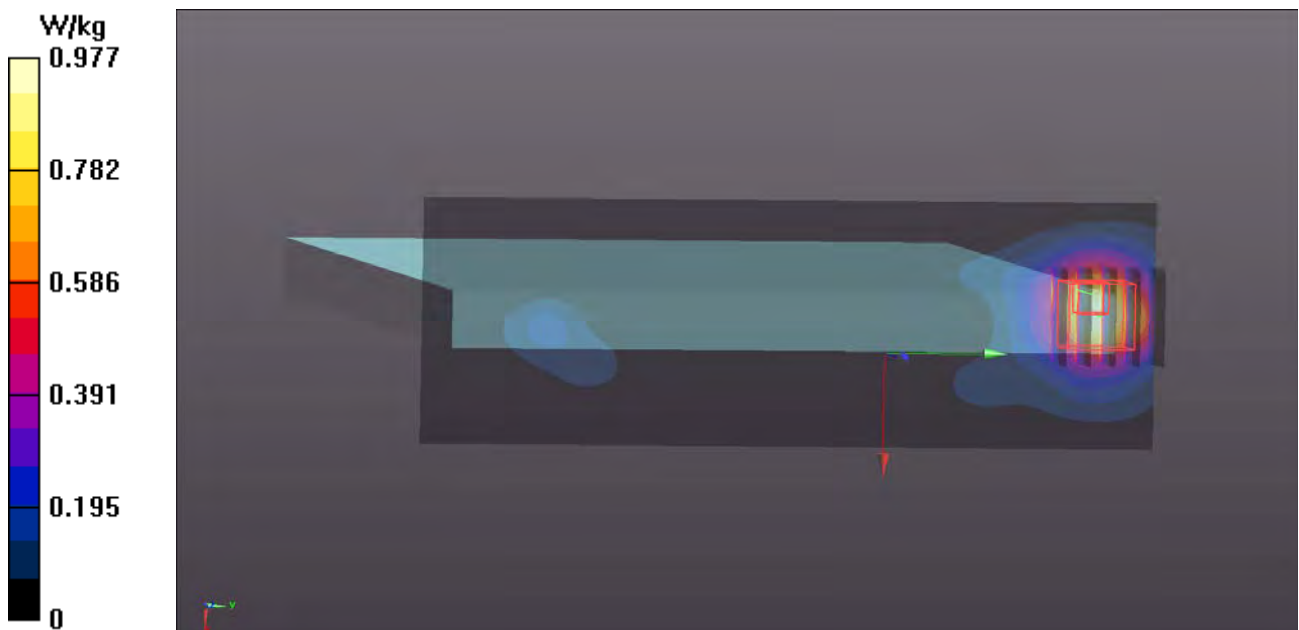

## P12 5.2G WLAN\_802.11n HT20\_Top Side\_0cm\_Ch44\_Tablet\_Ant0+1

**DUT: 150722C27**

Communication System: WLAN\_5G; Frequency: 5220 MHz; Duty Cycle: 1:1.07

Medium: B34T60N2\_0817 Medium parameters used:  $f = 5220$  MHz;  $\sigma = 5.283$  S/m;  $\epsilon_r = 51.088$ ;  $\rho = 1000$  kg/m<sup>3</sup>

Ambient Temperature : 23.5 °C ; Liquid Temperature : 22.8 °C

DASY5 Configuration:

- Probe: EX3DV4 - SN3971; ConvF(4.53, 4.53, 4.53); Calibrated: 2015/03/26;
- Sensor-Surface: 1.4mm (Mechanical Surface Detection)
- Electronics: DAE4 Sn1431; Calibrated: 2015/03/20
- Phantom: ELI Phantom\_1206; Type: QDOVA;
- Measurement SW: DASY52, Version 52.8 (8); SEMCAD X Version 14.6.10 (7331)

- **Area Scan (61x321x1):** Interpolated grid: dx=1.000 mm, dy=1.000 mm

Maximum value of SAR (interpolated) = 1.48 W/kg

- **Zoom Scan (6x6x12)/Cube 0:** Measurement grid: dx=5mm, dy=5mm, dz=2mm

Reference Value = 6.813 V/m; Power Drift = -0.01 dB

Peak SAR (extrapolated) = 3.10 W/kg

**SAR(1 g) = 0.857 W/kg; SAR(10 g) = 0.304 W/kg**

Maximum value of SAR (measured) = 1.96 W/kg

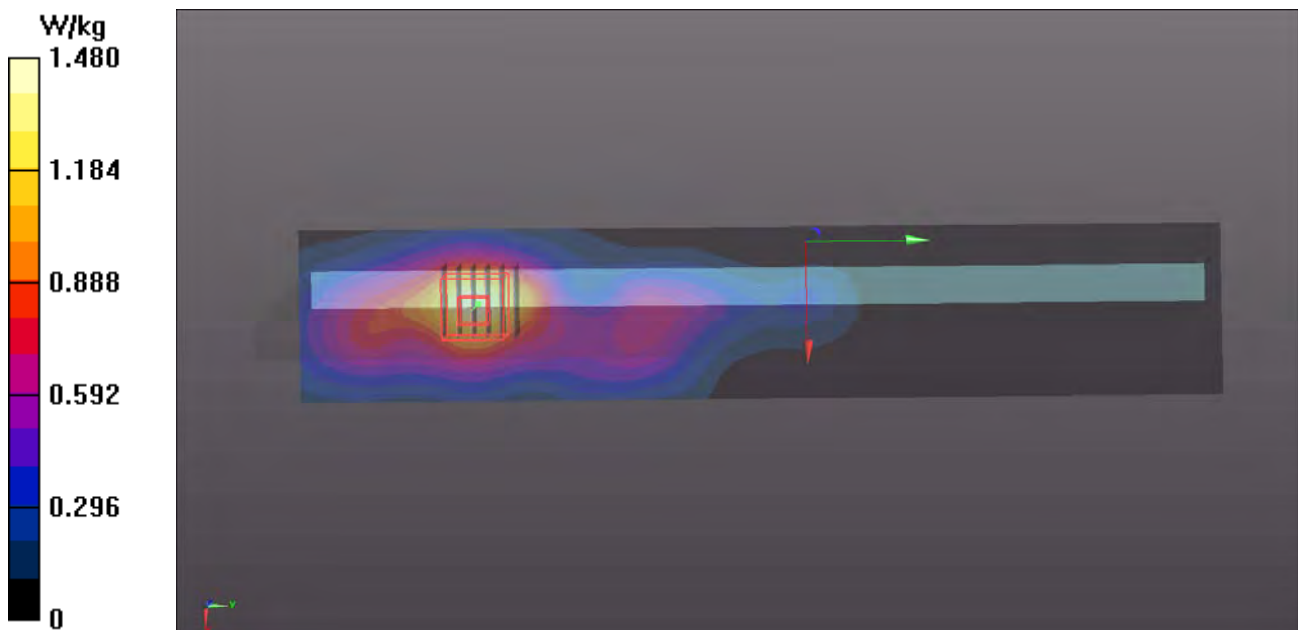

### P13 5.3G WLAN\_802.11a\_Top Side\_0cm\_Ch56\_Tablet\_Ant1

**DUT: 150722C27**

Communication System: WLAN\_5G; Frequency: 5280 MHz; Duty Cycle: 1:1

Medium: B34T60N2\_0817 Medium parameters used:  $f = 5280$  MHz;  $\sigma = 5.385$  S/m;  $\epsilon_r = 51.042$ ;  $\rho = 1000$  kg/m<sup>3</sup>

Ambient Temperature : 23.5 °C ; Liquid Temperature : 22.8 °C

DASY5 Configuration:

- Probe: EX3DV4 - SN3971; ConvF(4.3, 4.3, 4.3); Calibrated: 2015/03/26;
- Sensor-Surface: 1.4mm (Mechanical Surface Detection)
- Electronics: DAE4 Sn1431; Calibrated: 2015/03/20
- Phantom: ELI Phantom\_1206; Type: QDOVA;
- Measurement SW: DASY52, Version 52.8 (8); SEMCAD X Version 14.6.10 (7331)

- **Area Scan (61x321x1):** Interpolated grid: dx=1.000 mm, dy=1.000 mm

Maximum value of SAR (interpolated) = 1.33 W/kg

- **Zoom Scan (6x6x12)/Cube 0:** Measurement grid: dx=5mm, dy=5mm, dz=2mm

Reference Value = 6.010 V/m; Power Drift = -0.02 dB

Peak SAR (extrapolated) = 2.80 W/kg

**SAR(1 g) = 0.781 W/kg; SAR(10 g) = 0.288 W/kg**

Maximum value of SAR (measured) = 1.70 W/kg

- **Zoom Scan (6x6x12)/Cube 1:** Measurement grid: dx=5mm, dy=5mm, dz=2mm

Reference Value = 6.010 V/m; Power Drift = -0.02 dB

Peak SAR (extrapolated) = 3.83 W/kg

**SAR(1 g) = 0.566 W/kg; SAR(10 g) = 0.174 W/kg**

Maximum value of SAR (measured) = 1.37 W/kg

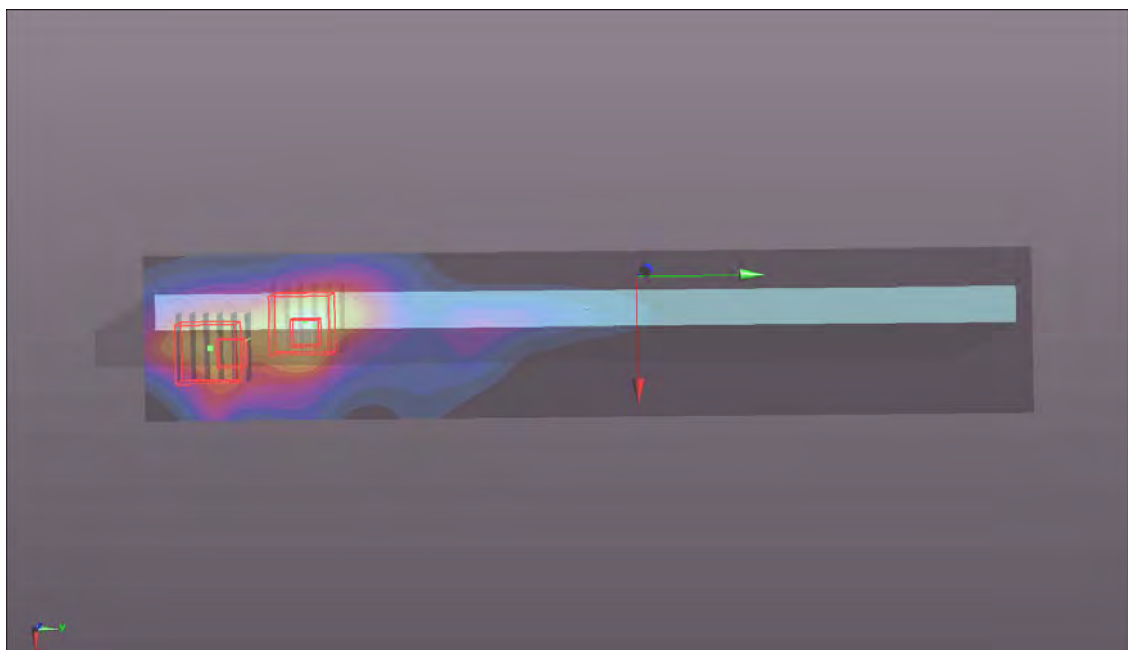
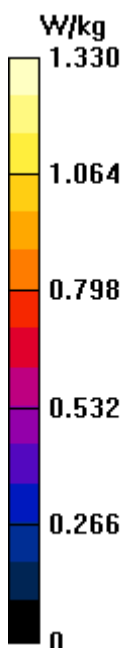

### P14 5.6G WLAN\_802.11a\_Top Side\_0cm\_Ch116\_Tablet\_Ant1

**DUT: 150722C27**

Communication System: WLAN\_5G; Frequency: 5580 MHz; Duty Cycle: 1:1

Medium: B34T60N1\_0818 Medium parameters used:  $f = 5580$  MHz;  $\sigma = 5.919$  S/m;  $\epsilon_r = 47.029$ ;  $\rho = 1000$  kg/m<sup>3</sup>

Ambient Temperature : 23.7 °C ; Liquid Temperature : 23.2 °C

DASY5 Configuration:

- Probe: EX3DV4 - SN3864; ConvF(3.93, 3.93, 3.93); Calibrated: 2015/07/23;
- Sensor-Surface: 1.4mm (Mechanical Surface Detection)
- Electronics: DAE4 Sn915; Calibrated: 2015/06/11
- Phantom: ELI Phantom\_1039; Type: QDOVA;
- Measurement SW: DASY52, Version 52.8 (8); SEMCAD X Version 14.6.10 (7331)

- **Area Scan (81x341x1):** Interpolated grid: dx=1.000 mm, dy=1.000 mm

Maximum value of SAR (interpolated) = 1.48 W/kg

- **Zoom Scan (6x6x12)/Cube 0:** Measurement grid: dx=5mm, dy=5mm, dz=2mm

Reference Value = 5.673 V/m; Power Drift = -0.02 dB

Peak SAR (extrapolated) = 3.52 W/kg

**SAR(1 g) = 0.742 W/kg; SAR(10 g) = 0.249 W/kg**

Maximum value of SAR (measured) = 2.15 W/kg

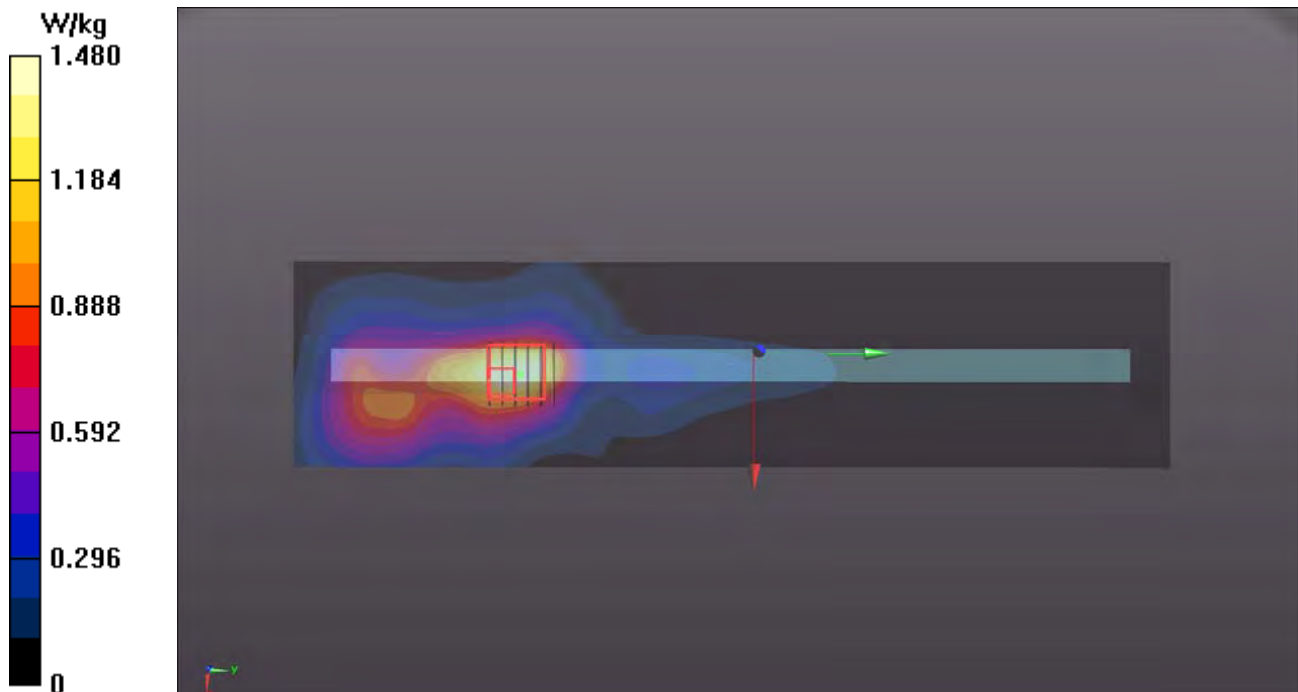



### P15 5.8G WLAN\_802.11n HT20\_Top Side\_0cm\_Ch157\_Tablet\_Ant0+1

**DUT: 150722C27**

Communication System: WLAN\_5G; Frequency: 5785 MHz; Duty Cycle: 1:1.07

Medium: B34T60N1\_0818 Medium parameters used:  $f = 5785$  MHz;  $\sigma = 6.21$  S/m;  $\epsilon_r = 46.627$ ;  $\rho = 1000$  kg/m<sup>3</sup>

Ambient Temperature : 23.7 °C ; Liquid Temperature : 23.2 °C

DASY5 Configuration:

- Probe: EX3DV4 - SN3864; ConvF(4.2, 4.2, 4.2); Calibrated: 2015/07/23;
- Sensor-Surface: 1.4mm (Mechanical Surface Detection)
- Electronics: DAE4 Sn915; Calibrated: 2015/06/11
- Phantom: ELI Phantom\_1039; Type: QDOVA;
- Measurement SW: DASY52, Version 52.8 (8); SEMCAD X Version 14.6.10 (7331)

- **Area Scan (81x341x1):** Interpolated grid: dx=1.000 mm, dy=1.000 mm

Maximum value of SAR (interpolated) = 1.81 W/kg

- **Zoom Scan (6x6x12)/Cube 0:** Measurement grid: dx=5mm, dy=5mm, dz=2mm

Reference Value = 7.430 V/m; Power Drift = -0.08 dB

Peak SAR (extrapolated) = 4.04 W/kg

**SAR(1 g) = 1.02 W/kg; SAR(10 g) = 0.389 W/kg**

Maximum value of SAR (measured) = 2.36 W/kg

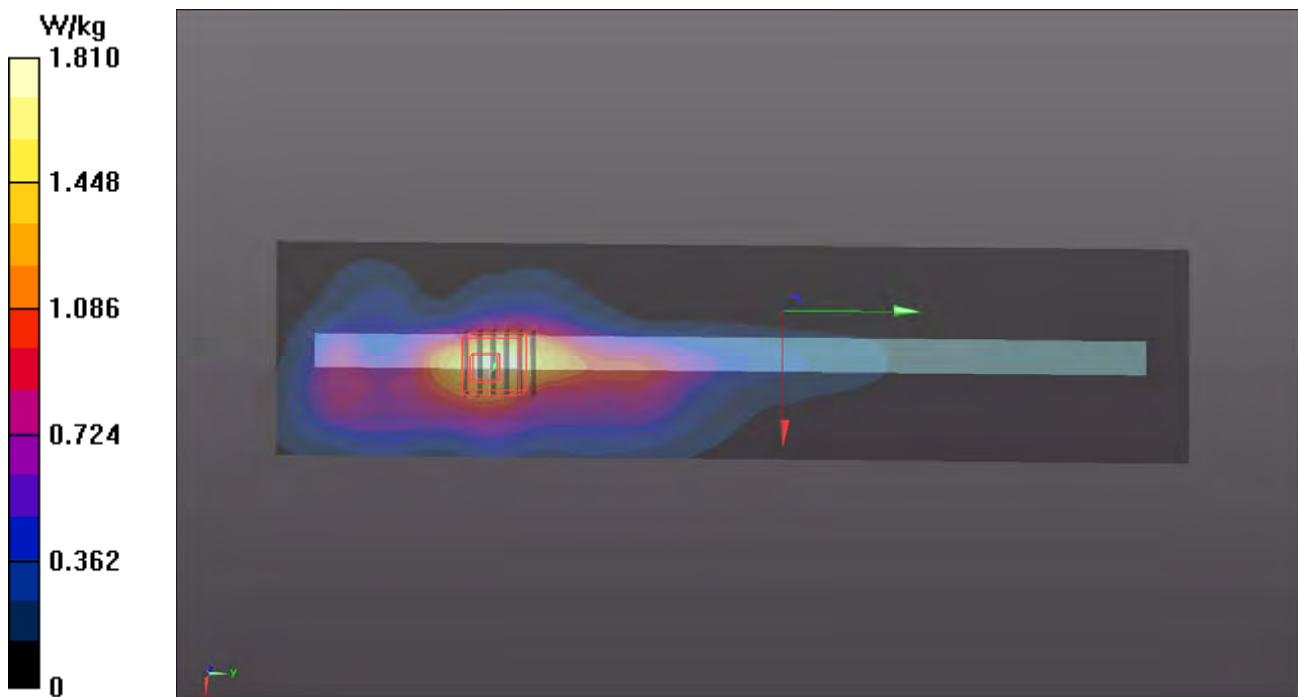

## P16 2.4G WLAN\_802.11b\_Top Side\_2.5cm\_Ch6\_NB\_Ant1

**DUT: 150722C27**

Communication System: WLAN\_2.4G; Frequency: 2437 MHz; Duty Cycle: 1:1

Medium: B19T27N2\_0821 Medium parameters used:  $f = 2437$  MHz;  $\sigma = 2.002$  S/m;  $\epsilon_r = 51.701$ ;  $\rho = 1000$  kg/m<sup>3</sup>

Ambient Temperature : 23.5 °C; Liquid Temperature : 23.0 °C

DASY5 Configuration:

- Probe: EX3DV4 - SN3864; ConvF(7.3, 7.3, 7.3); Calibrated: 2015/07/23;
- Sensor-Surface: 1.4mm (Mechanical Surface Detection)
- Electronics: DAE4 Sn915; Calibrated: 2015/06/11
- Phantom: ELI Phantom\_1039; Type: QDOVA;
- Measurement SW: DASY52, Version 52.8 (8); SEMCAD X Version 14.6.10 (7331)

- **Area Scan (71x301x1):** Interpolated grid: dx=1.200 mm, dy=1.200 mm

Maximum value of SAR (interpolated) = 0.107 W/kg

- **Zoom Scan (5x5x7)/Cube 0:** Measurement grid: dx=8mm, dy=8mm, dz=5mm

Reference Value = 2.868 V/m; Power Drift = 0.06 dB

Peak SAR (extrapolated) = 0.126 W/kg

**SAR(1 g) = 0.068 W/kg; SAR(10 g) = 0.039 W/kg**

Maximum value of SAR (measured) = 0.103 W/kg

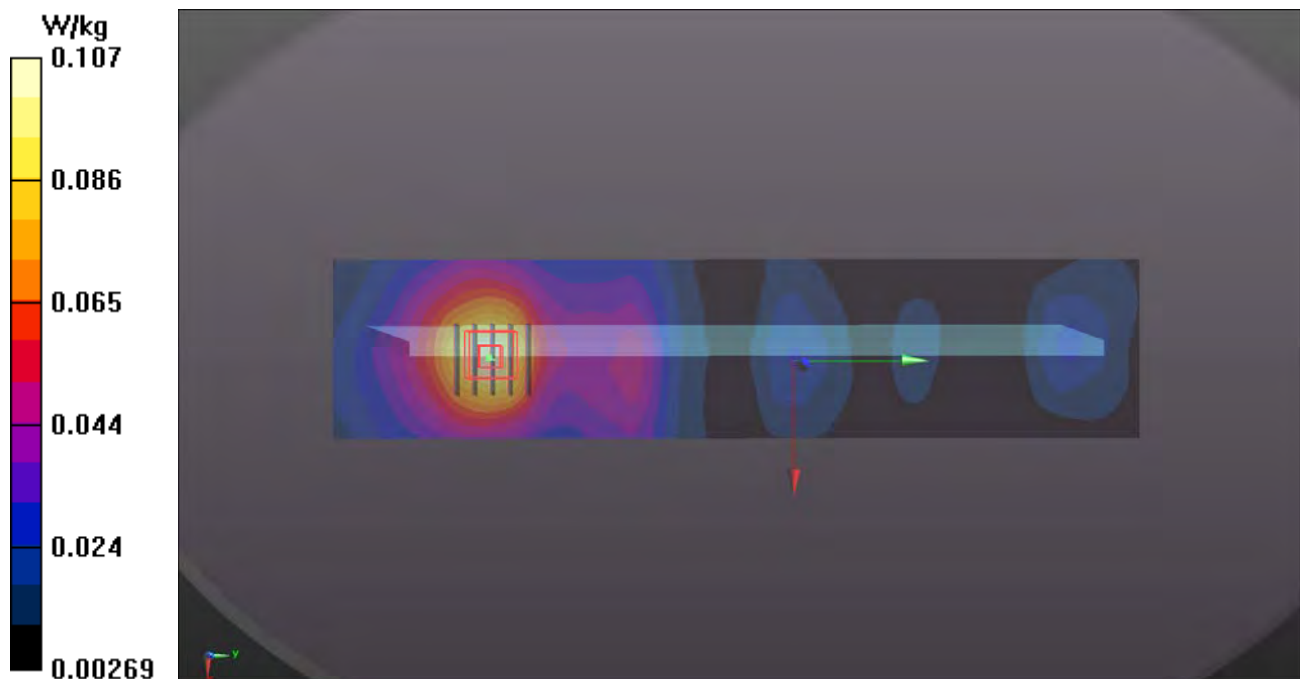

### P17 5.2G WLAN\_802.11n HT20\_Left Side\_2.5cm\_Ch44\_NB\_Ant0+1

**DUT: 150722C27**

Communication System: WLAN\_5G; Frequency: 5220 MHz; Duty Cycle: 1:1.07

Medium: B34T60N2\_0821 Medium parameters used:  $f = 5220$  MHz;  $\sigma = 5.308$  S/m;  $\epsilon_r = 48.991$ ;  $\rho = 1000$  kg/m<sup>3</sup>

Ambient Temperature : 23.5 °C ; Liquid Temperature : 23.0 °C

DASY5 Configuration:

- Probe: EX3DV4 - SN3864; ConvF(4.75, 4.75, 4.75); Calibrated: 2015/07/23;
- Sensor-Surface: 1.4mm (Mechanical Surface Detection)
- Electronics: DAE4 Sn915; Calibrated: 2015/06/11
- Phantom: ELI Phantom\_1039; Type: QDOVA;
- Measurement SW: DASY52, Version 52.8 (8); SEMCAD X Version 14.6.10 (7331)

- **Area Scan (81x281x1):** Interpolated grid: dx=1.000 mm, dy=1.000 mm

Maximum value of SAR (interpolated) = 0.242 W/kg

- **Zoom Scan (6x6x12)/Cube 0:** Measurement grid: dx=5mm, dy=5mm, dz=2mm

Reference Value = 4.077 V/m; Power Drift = -0.04 dB

Peak SAR (extrapolated) = 0.376 W/kg

**SAR(1 g) = 0.109 W/kg; SAR(10 g) = 0.049 W/kg**

Maximum value of SAR (measured) = 0.236 W/kg

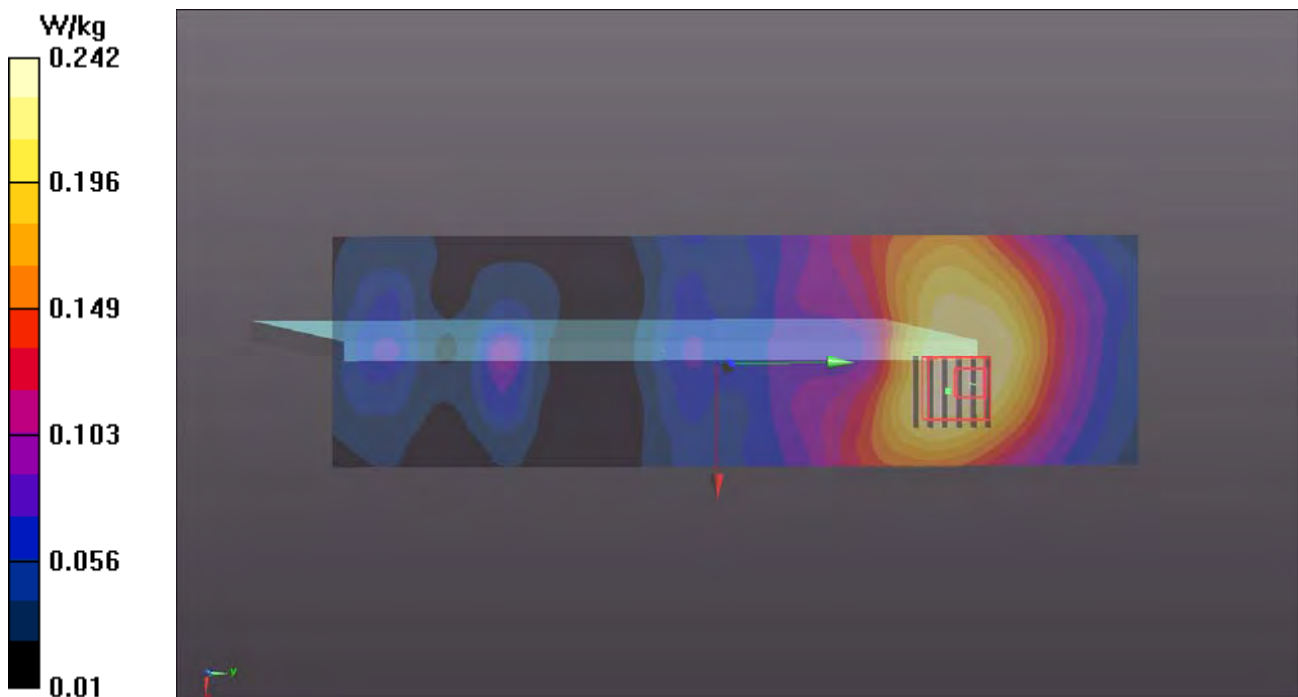

### P18 5.3G WLAN\_802.11a\_Top Side\_2.5cm\_Ch56\_NB\_Ant1

**DUT: 150722C27**

Communication System: WLAN\_5G; Frequency: 5280 MHz; Duty Cycle: 1:1

Medium: B34T60N2\_0821 Medium parameters used:  $f = 5280$  MHz;  $\sigma = 5.404$  S/m;  $\epsilon_r = 48.986$ ;  $\rho = 1000$  kg/m<sup>3</sup>

Ambient Temperature : 23.5 °C ; Liquid Temperature : 23.0 °C

DASY5 Configuration:

- Probe: EX3DV4 - SN3864; ConvF(4.41, 4.41, 4.41); Calibrated: 2015/07/23;
- Sensor-Surface: 1.4mm (Mechanical Surface Detection)
- Electronics: DAE4 Sn915; Calibrated: 2015/06/11
- Phantom: ELI Phantom\_1039; Type: QDOVA;
- Measurement SW: DASY52, Version 52.8 (8); SEMCAD X Version 14.6.10 (7331)

- **Area Scan (81x361x1):** Interpolated grid: dx=1.000 mm, dy=1.000 mm

Maximum value of SAR (interpolated) = 0.254 W/kg

- **Zoom Scan (6x6x12)/Cube 0:** Measurement grid: dx=5mm, dy=5mm, dz=2mm

Reference Value = 4.828 V/m; Power Drift = 0.04 dB

Peak SAR (extrapolated) = 0.423 W/kg

**SAR(1 g) = 0.118 W/kg; SAR(10 g) = 0.052 W/kg**

Maximum value of SAR (measured) = 0.253 W/kg

- **Zoom Scan (6x6x12)/Cube 1:** Measurement grid: dx=5mm, dy=5mm, dz=2mm

Reference Value = 4.828 V/m; Power Drift = 0.04 dB

Peak SAR (extrapolated) = 0.320 W/kg

**SAR(1 g) = 0.087 W/kg; SAR(10 g) = 0.035 W/kg**

Maximum value of SAR (measured) = 0.193 W/kg

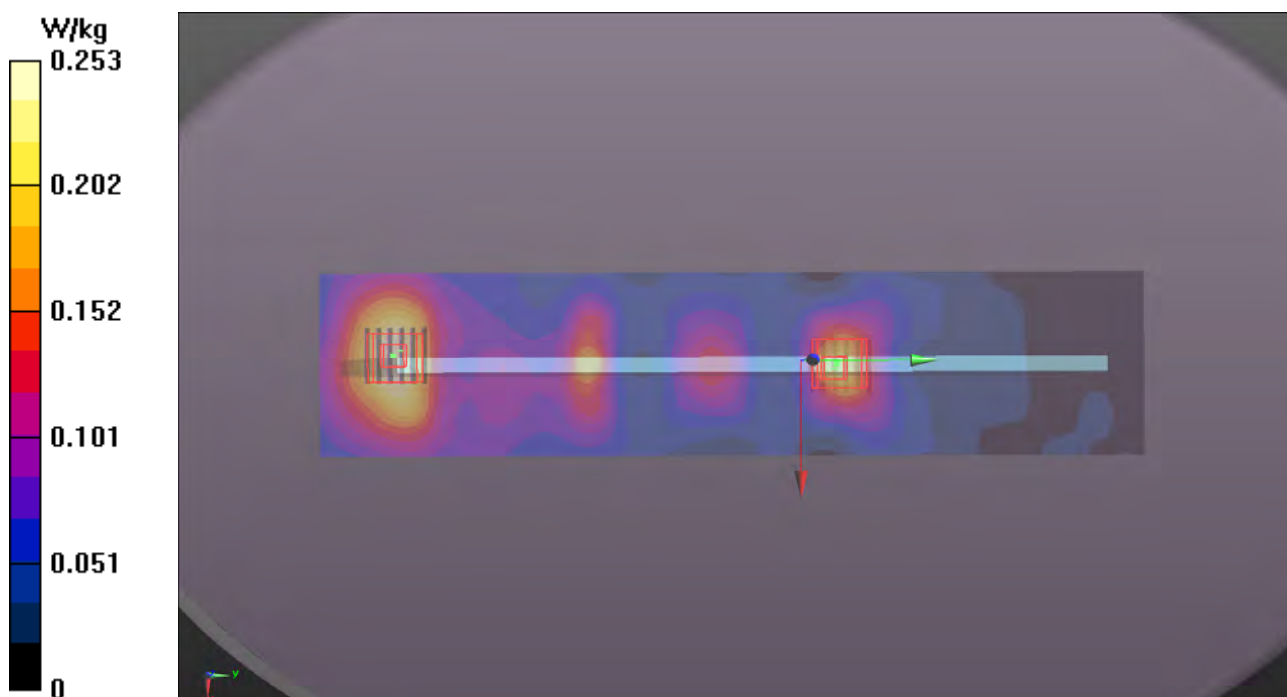

### P19 5.6G WLAN\_802.11n HT20\_Left Side\_2.5cm\_Ch116\_NB\_Ant0+1

**DUT: 150722C27**

Communication System: WLAN\_5G; Frequency: 5580 MHz; Duty Cycle: 1:1.07

Medium: B34T60N3\_0822 Medium parameters used:  $f = 5580$  MHz;  $\sigma = 5.86$  S/m;  $\epsilon_r = 46.89$ ;  $\rho = 1000$  kg/m<sup>3</sup>

Ambient Temperature : 23.7 °C ; Liquid Temperature : 23.3 °C

DASY5 Configuration:

- Probe: EX3DV4 - SN3864; ConvF(3.93, 3.93, 3.93); Calibrated: 2015/07/23;
- Sensor-Surface: 1.4mm (Mechanical Surface Detection)
- Electronics: DAE4 Sn915; Calibrated: 2015/06/11
- Phantom: ELI Phantom\_1039; Type: QDOVA;
- Measurement SW: DASY52, Version 52.8 (8); SEMCAD X Version 14.6.10 (7331)

- **Area Scan (81x261x1):** Interpolated grid: dx=1.000 mm, dy=1.000 mm

Maximum value of SAR (interpolated) = 0.230 W/kg

- **Zoom Scan (6x6x12)/Cube 0:** Measurement grid: dx=5mm, dy=5mm, dz=2mm

Reference Value = 2.949 V/m; Power Drift = -0.08 dB

Peak SAR (extrapolated) = 0.441 W/kg

**SAR(1 g) = 0.113 W/kg; SAR(10 g) = 0.048 W/kg**

Maximum value of SAR (measured) = 0.251 W/kg

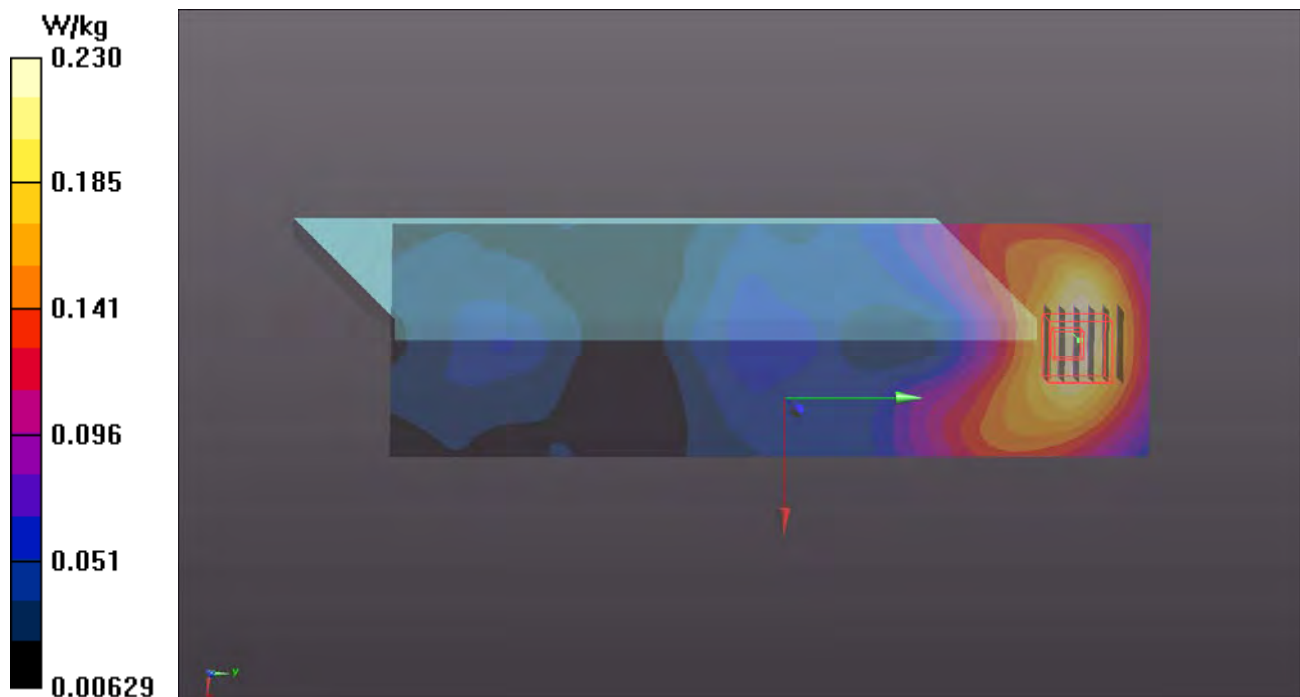

## P20 5.8G WLAN\_802.11n HT20\_Top Side\_2.5cm\_Ch157\_NB\_Ant0+1

**DUT: 150722C27**

Communication System: WLAN\_5G; Frequency: 5785 MHz; Duty Cycle: 1:1.07

Medium: B34T60N3\_0822 Medium parameters used:  $f = 5785$  MHz;  $\sigma = 6.159$  S/m;  $\epsilon_r = 46.545$ ;  $\rho = 1000$  kg/m<sup>3</sup>

Ambient Temperature : 23.7 °C ; Liquid Temperature : 23.3 °C

DASY5 Configuration:

- Probe: EX3DV4 - SN3864; ConvF(4.2, 4.2, 4.2); Calibrated: 2015/07/23;
- Sensor-Surface: 1.4mm (Mechanical Surface Detection)
- Electronics: DAE4 Sn915; Calibrated: 2015/06/11
- Phantom: ELI Phantom\_1039; Type: QDOVA;
- Measurement SW: DASY52, Version 52.8 (8); SEMCAD X Version 14.6.10 (7331)

- **Area Scan (81x361x1):** Interpolated grid: dx=1.000 mm, dy=1.000 mm

Maximum value of SAR (interpolated) = 0.289 W/kg

- **Zoom Scan (6x6x12)/Cube 0:** Measurement grid: dx=5mm, dy=5mm, dz=2mm

Reference Value = 4.532 V/m; Power Drift = -0.07 dB

Peak SAR (extrapolated) = 0.642 W/kg

**SAR(1 g) = 0.158 W/kg; SAR(10 g) = 0.063 W/kg**

Maximum value of SAR (measured) = 0.370 W/kg

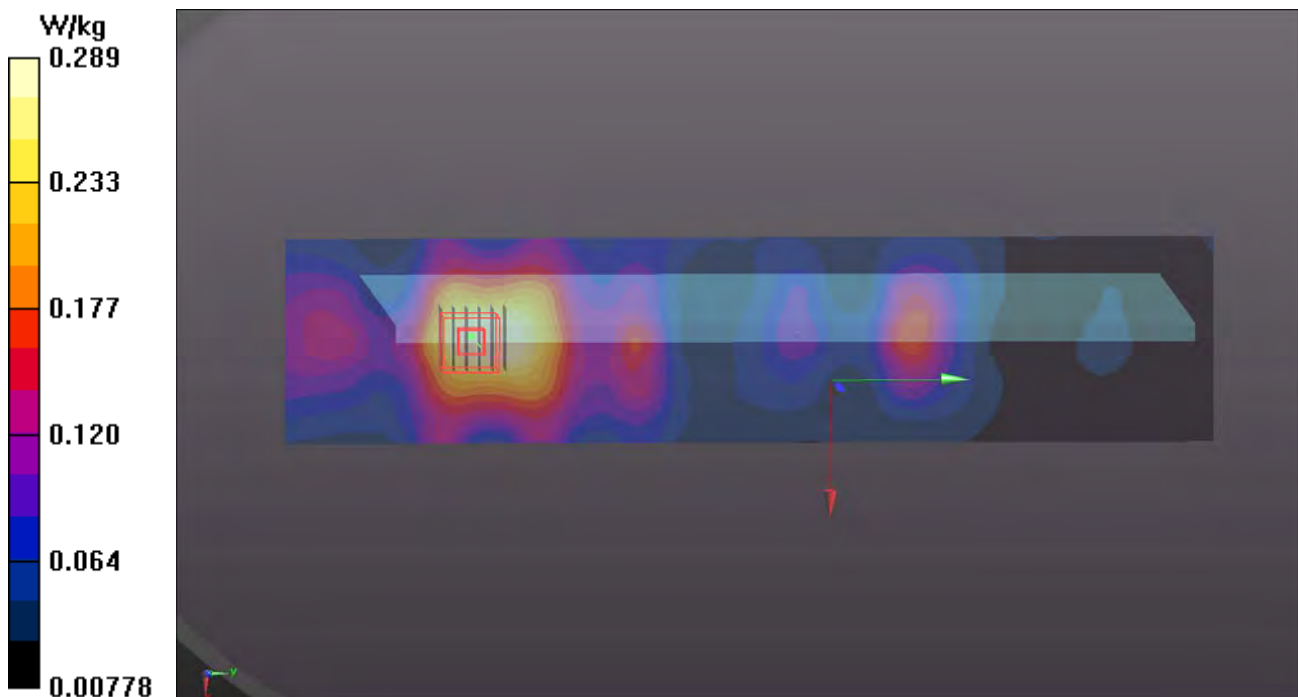



## **Appendix C. Calibration Certificate for Probe and Dipole**

The SPEAG calibration certificates are shown as follows.



In Collaboration with  
**s p e a g**  
 CALIBRATION LABORATORY

Add: No.51 Xueyuan Road, Haidian District, Beijing, 100191, China  
 Tel: +86-10-62304633-2079 Fax: +86-10-62304633-2504  
 E-mail: ctll@chinattl.com [Http://www.chinattl.cn](http://www.chinattl.cn)



Client **AUDEN**

Certificate No: **Z15-97055**

**CALIBRATION CERTIFICATE**

Object **D2450V2 - SN: 835**

Calibration Procedure(s) **FD-Z11-2-003-01**  
**Calibration Procedures for dipole validation kits**

Calibration date: **March 30, 2015**

This calibration Certificate documents the traceability to national standards, which realize the physical units of measurements(SI). The measurements and the uncertainties with confidence probability are given on the following pages and are part of the certificate.

All calibrations have been conducted in the closed laboratory facility: environment temperature(22±3)°C and humidity<70%.

Calibration Equipment used (M&TE critical for calibration)

Primary Standards	ID #	Cal Date(Calibrated by, Certificate No.)	Scheduled Calibration
Power Meter NRP2	101919	01-Jul-14 (CTTL, No.J14X02146)	Jun-15
Power sensor NRP-Z91	101547	01-Jul-14 (CTTL, No.J14X02146)	Jun-15
Reference Probe EX3DV4	SN 3846	24-Sep-14(SPEAG, No.EX3-3846_Sep14)	Sep-15
DAE4	SN 1331	20-Jan-15(CTTL-SPEAG, No. Z15-97011)	Jan-16
Secondary Standards	ID #	Cal Date(Calibrated by, Certificate No.)	Scheduled Calibration
Signal Generator E4438C	MY49071430	02-Feb-15 (CTTL, No.J15X00729)	Feb-16
Network Analyzer E5071C	MY46110673	03-Feb-15 (CTTL, No.J15X00728)	Feb-16

	Name	Function	Signature
Calibrated by:	Zhao Jing	SAR Test Engineer	
Reviewed by:	Qi Dianyuan	SAR Project Leader	
Approved by:	Lu Bingsong	Deputy Director of the laboratory	

Issued: March 31, 2015

This calibration certificate shall not be reproduced except in full without written approval of the laboratory.





In Collaboration with  
**s p e a g**  
CALIBRATION LABORATORY

Add: No.51 Xueyuan Road, Haidian District, Beijing, 100191, China  
Tel: +86-10-62304633-2079 Fax: +86-10-62304633-2504  
E-mail: cttl@chinattl.com Http://www.chinattl.cn

#### Glossary:

TSL	tissue simulating liquid
ConvF	sensitivity in TSL / NORM <sub>x,y,z</sub>
N/A	not applicable or not measured

#### Calibration is Performed According to the Following Standards:

- IEEE Std 1528-2013, "IEEE Recommended Practice for Determining the Peak Spatial-Averaged Specific Absorption Rate (SAR) in the Human Head from Wireless Communications Devices: Measurement Techniques", June 2013
- IEC 62209-1, "Procedure to measure the Specific Absorption Rate (SAR) For hand-held devices used in close proximity to the ear (frequency range of 300MHz to 3GHz)", February 2005
- KDB865664, SAR Measurement Requirements for 100 MHz to 6 GHz

#### Additional Documentation:

- DASY4/5 System Handbook

#### Methods Applied and Interpretation of Parameters:

- Measurement Conditions:* Further details are available from the Validation Report at the end of the certificate. All figures stated in the certificate are valid at the frequency indicated.
- Antenna Parameters with TSL:* The dipole is mounted with the spacer to position its feed point exactly below the center marking of the flat phantom section, with the arms oriented parallel to the body axis.
- Feed Point Impedance and Return Loss:* These parameters are measured with the dipole positioned under the liquid filled phantom. The impedance stated is transformed from the measurement at the SMA connector to the feed point. The Return Loss ensures low reflected power. No uncertainty required.
- Electrical Delay:* One-way delay between the SMA connector and the antenna feed point. No uncertainty required.
- SAR measured:* SAR measured at the stated antenna input power.
- SAR normalized:* SAR as measured, normalized to an input power of 1 W at the antenna connector.
- SAR for nominal TSL parameters:* The measured TSL parameters are used to calculate the nominal SAR result.

The reported uncertainty of measurement is stated as the standard uncertainty of Measurement multiplied by the coverage factor  $k=2$ , which for a normal distribution Corresponds to a coverage probability of approximately 95%.



In Collaboration with  
**s p e a g**  
 CALIBRATION LABORATORY

Add: No.51 Xueyuan Road, Haidian District, Beijing, 100191, China  
 Tel: +86-10-62304633-2079 Fax: +86-10-62304633-2504  
 E-mail: cttl@chinattl.com Http://www.chinattl.cn

### Measurement Conditions

DASY system configuration, as far as not given on page 1.

DASY Version	DASY52	52.8.8.1222
Extrapolation	Advanced Extrapolation	
Phantom	Triple Flat Phantom 5.1C	
Distance Dipole Center - TSL	10 mm	with Spacer
Zoom Scan Resolution	dx, dy, dz = 5 mm	
Frequency	2450 MHz ± 1 MHz	

### Head TSL parameters

The following parameters and calculations were applied.

	Temperature	Permittivity	Conductivity
Nominal Head TSL parameters	22.0 °C	39.2	1.80 mho/m
Measured Head TSL parameters	(22.0 ± 0.2) °C	40.2 ± 6 %	1.81 mho/m ± 6 %
Head TSL temperature change during test	<1.0 °C	—	—

### SAR result with Head TSL

SAR averaged over 1 cm <sup>3</sup> (1 g) of Head TSL	Condition	
SAR measured	250 mW input power	13.3 mW / g
SAR for nominal Head TSL parameters	normalized to 1W	53.4 mW / g ± 20.8 % (k=2)
SAR averaged over 10 cm <sup>3</sup> (10 g) of Head TSL	Condition	
SAR measured	250 mW input power	6.27 mW / g
SAR for nominal Head TSL parameters	normalized to 1W	25.1 mW / g ± 20.4 % (k=2)

### Body TSL parameters

The following parameters and calculations were applied.

	Temperature	Permittivity	Conductivity
Nominal Body TSL parameters	22.0 °C	52.7	1.95 mho/m
Measured Body TSL parameters	(22.0 ± 0.2) °C	53.0 ± 6 %	1.96 mho/m ± 6 %
Body TSL temperature change during test	<1.0 °C	—	—

### SAR result with Body TSL

SAR averaged over 1 cm <sup>3</sup> (1 g) of Body TSL	Condition	
SAR measured	250 mW input power	12.6 mW / g
SAR for nominal Body TSL parameters	normalized to 1W	50.3 mW / g ± 20.8 % (k=2)
SAR averaged over 10 cm <sup>3</sup> (10 g) of Body TSL	Condition	
SAR measured	250 mW input power	5.91 mW / g
SAR for nominal Body TSL parameters	normalized to 1W	23.6 mW / g ± 20.4 % (k=2)



In Collaboration with  
**s p e a g**  
CALIBRATION LABORATORY

Add: No.51 Xueyuan Road, Haidian District, Beijing, 100191, China  
Tel: +86-10-62304633-2079 Fax: +86-10-62304633-2504  
E-mail: cttl@chinatl.com Http://www.chinatl.cn

## Appendix

### Antenna Parameters with Head TSL

Impedance, transformed to feed point	$53.6\Omega + 4.97j\Omega$
Return Loss	- 24.5dB

### Antenna Parameters with Body TSL

Impedance, transformed to feed point	$50.9\Omega + 5.90j\Omega$
Return Loss	- 24.6dB

### General Antenna Parameters and Design

Electrical Delay (one direction)	1.039 ns
----------------------------------	----------

After long term use with 100W radiated power, only a slight warming of the dipole near the feedpoint can be measured.

The dipole is made of standard semirigid coaxial cable. The center conductor of the feeding line is directly connected to the second arm of the dipole. The antenna is therefore short-circuited for DC-signals. On some of the dipoles, small end caps are added to the dipole arms in order to improve matching when loaded according to the position as explained in the "Measurement Conditions" paragraph. The SAR data are not affected by this change. The overall dipole length is still according to the Standard. No excessive force must be applied to the dipole arms, because they might bend or the soldered connections near the feedpoint may be damaged.

### Additional EUT Data

Manufactured by	SPEAG
-----------------	-------



In Collaboration with  
**s p e a g**  
CALIBRATION LABORATORY

Add: No.51 Xueyuan Road, Haidian District, Beijing, 100191, China  
Tel: +86-10-62304633-2079 Fax: +86-10-62304633-2504  
E-mail: ct1@chinattl.com Http://www.chinattl.cn

**DASY5 Validation Report for Head TSL**

Date: 03.30.2015

Test Laboratory: CTTL, Beijing, China

**DUT: Dipole 2450 MHz; Type: D2450V2; Serial: D2450V2 - SN: 835**

Communication System: UID 0, CW; Frequency: 2450 MHz; Duty Cycle: 1:1

Medium parameters used:  $f = 2450$  MHz;  $\sigma = 1.811$  S/m;  $\epsilon_r = 40.22$ ;  $\rho = 1000$  kg/m<sup>3</sup>

Phantom section: Left Section

Measurement Standard: DASY5 (IEEE/IEC/ANSI C63.19-2007)

DASY5 Configuration:

- Probe: EX3DV4 - SN3846; ConvF(6.56, 6.56, 6.56); Calibrated: 9/24/2014;
- Sensor-Surface: 2mm (Mechanical Surface Detection)
- Electronics: DAE4 Sn1331; Calibrated: 2015-01-20
- Phantom: Triple Flat Phantom 5.1C; Type: QD 000 P51 CA; Serial: 1161/1
- Measurement SW: DASY52, Version 52.8 (8); SEMCAD X Version 14.6.10 (7331)

**Dipole Calibration/Zoom Scan (7x7x7) (7x7x7)/Cube 0: Measurement grid: dx=5mm,**

dy=5mm, dz=5mm

Reference Value = 107.2 V/m; Power Drift = 0.02 dB

Peak SAR (extrapolated) = 26.2 W/kg

**SAR(1 g) = 13.3 W/kg; SAR(10 g) = 6.27 W/kg**

Maximum value of SAR (measured) = 20.0 W/kg

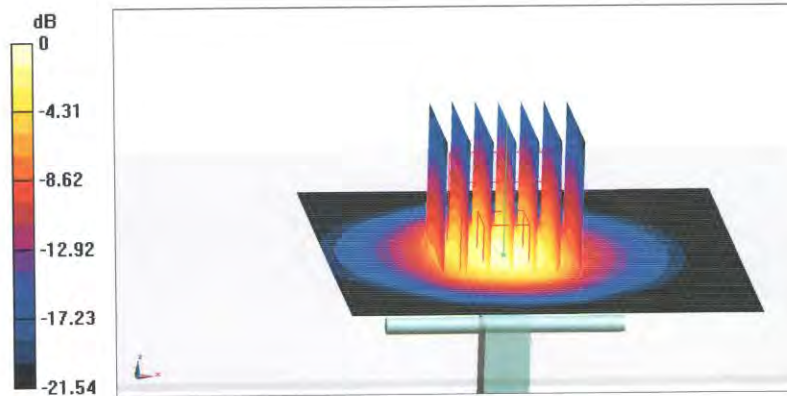

0 dB = 20.0 W/kg = 13.01 dB W/kg



In Collaboration with  
**s p e a g**  
CALIBRATION LABORATORY

Add: No.51 Xueyuan Road, Haidian District, Beijing, 100191, China  
Tel: +86-10-62304633-2079 Fax: +86-10-62304633-2504  
E-mail: cttl@chinattl.com Http://www.chinattl.cn

### Impedance Measurement Plot for Head TSL

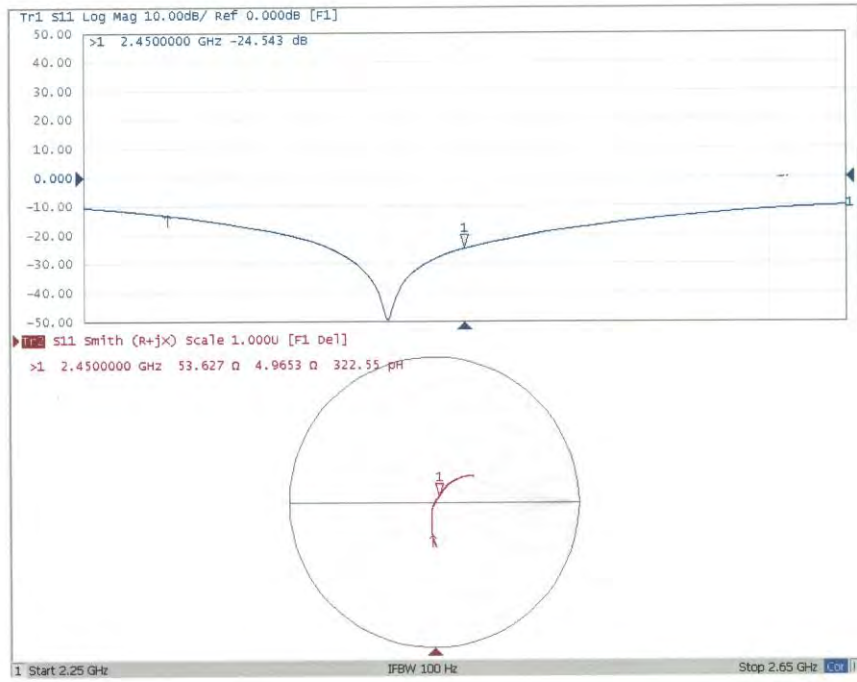



In Collaboration with  
**s p e a g**  
CALIBRATION LABORATORY

Add: No.51 Xueyuan Road, Haidian District, Beijing, 100191, China  
Tel: +86-10-62304633-2079 Fax: +86-10-62304633-2504  
E-mail: cttl@chinatl.com Http://www.chinatl.cn

**DASY5 Validation Report for Body TSL**

Date: 03.30.2015

Test Laboratory: CTTL, Beijing, China

**DUT: Dipole 2450 MHz; Type: D2450V2; Serial: D2450V2 - SN: 835**

Communication System: UID 0, CW; Frequency: 2450 MHz; Duty Cycle: 1:1

Medium parameters used:  $f = 2450$  MHz;  $\sigma = 1.959$  S/m;  $\epsilon_r = 52.95$ ;  $\rho = 1000$  kg/m<sup>3</sup>

Phantom section: Center Section

Measurement Standard: DASY5 (IEEE/IEC/ANSI C63.19-2007)

DASY5 Configuration:

- Probe: EX3DV4 - SN3846; ConvF(6.9, 6.9, 6.9); Calibrated: 9/24/2014;
- Sensor-Surface: 2mm (Mechanical Surface Detection)
- Electronics: DAE4 Sn1331; Calibrated: 2015-01-20
- Phantom: Triple Flat Phantom 5.1C; Type: QD 000 P51 CA; Serial: 1161/1
- Measurement SW: DASY52, Version 52.8 (8); SEMCAD X Version 14.6.10 (7331)

**Dipole Calibration/Zoom Scan (7x7x7) (7x7x7)/Cube 0:** Measurement grid: dx=5mm, dy=5mm, dz=5mm

Reference Value = 99.92 V/m; Power Drift = 0.01 dB

Peak SAR (extrapolated) = 26.0 W/kg

**SAR(1 g) = 12.6 W/kg; SAR(10 g) = 5.91 W/kg**

Maximum value of SAR (measured) = 19.2 W/kg

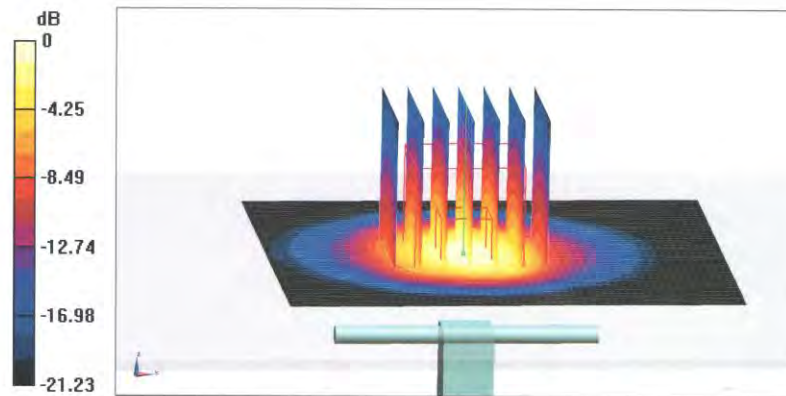

0 dB = 19.2 W/kg = 12.83 dBW/kg



In Collaboration with  
**s p e a g**  
CALIBRATION LABORATORY

Add: No.51 Xueyuan Road, Haidian District, Beijing, 100191, China  
Tel: +86-10-62304633-2079 Fax: +86-10-62304633-2504  
E-mail: cttl@chinattl.com Http://www.chinattl.cn

### Impedance Measurement Plot for Body TSL

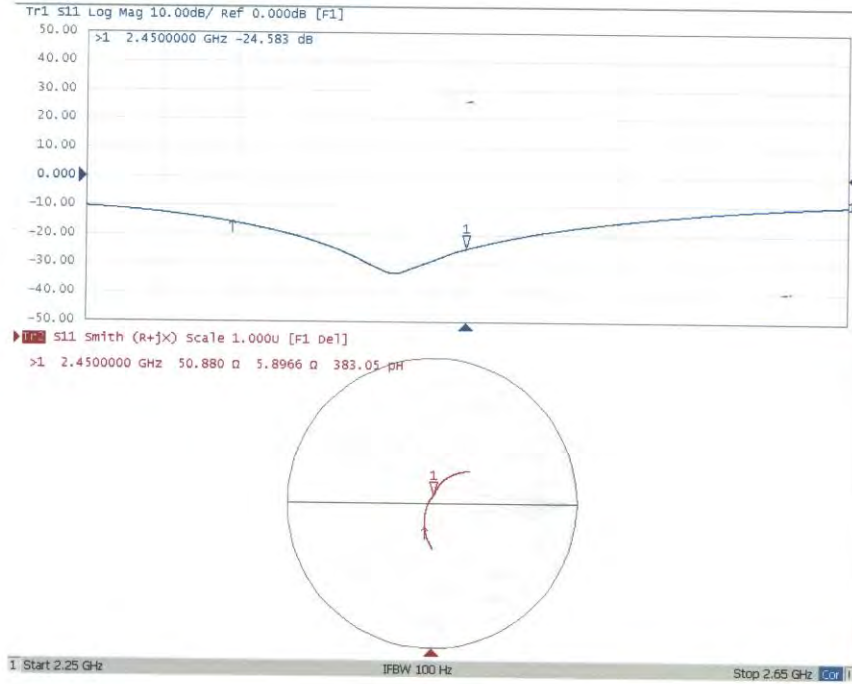

**Acceptable Conditions for SAR Measurements Using Probes and Dipoles  
Calibrated under the SPEAG-CTTL Dual-Logo Calibration Program to  
Support FCC Equipment Certification**

The acceptable conditions for SAR measurements using probes, dipoles and DAEs calibrated by CTTL (*China Telecommunication Technology Labs*), under the Dual-Logo Calibration Certificate program and quality assurance (QA) protocols established between SPEAG (*Schmid & Partner Engineering AG, Switzerland*) and CTTL, to support FCC (*U.S. Federal Communications Commission*) equipment certification are defined and described in the following. The conditions in this KDB are valid until December 31, 2015.

- 1) The agreement established between SPEAG and CTTL is only applicable to calibration services performed by CTTL where its clients (companies and divisions of such companies) are headquartered in the Greater China Region, including Taiwan and Hong Kong. CTTL shall inform the FCC of any changes or early termination to the agreement.
- 2) Only a subset of the calibration services specified in the SPEAG-CTTL agreement, while it remains valid, are applicable to SAR measurements performed using such equipment for supporting FCC equipment certification. These are identified in the following.
  - a) Calibration of dosimetric (SAR) probes EX3DVx, ET3DVx and ES3DVx.
    - i) Free-space E-field and H-field probes, including those used for HAC (hearing aid compatibility) evaluation, temperature probes, other probes or equipment not identified in this document, when calibrated by CTTL, are excluded and cannot be used for measurements to support FCC equipment certification.
    - ii) Signal specific and bundled probe calibrations based on PMR (probe modulation response) characteristics or probe sensor model based linearization methods that are not fully described in SAR standards are excluded and cannot be used for measurements to support FCC equipment certification.
  - b) Calibration of SAR system validation dipoles, excluding HAC dipoles.
  - c) Calibration of data acquisition electronics DAE3Vx, DAE4Vx and DAEasyVx.
  - d) For FCC equipment certification purposes, the frequency range of SAR probe and dipole calibrations is limited to 700 MHz - 6 GHz and provided it is supported by the equipment identified in the CTTL QA protocol (a separate attachment to this document).
  - e) The identical system and equipment setup, measurement configurations, hardware, evaluation algorithms, calibration and QA protocols, including the format of calibration certificates and reports used by SPEAG shall be applied by CTTL. Equivalent test equipment and measurement configurations may be considered only when agreed by both SPEAG and the FCC.
  - f) The calibrated items are only applicable to SPEAG DASY 4 and DASY 5 systems or higher version systems that satisfy the requirements of this KDB.
- 3) The SPEAG-CTTL agreement includes specific protocols identified in the following to ensure the quality of calibration services provided by CTTL under this SPEAG-



CTTL Dual-Logo calibration agreement are equivalent to the calibration services provided by SPEAG. CTTL shall apply the required protocols without modification and, upon request, provide copies of documentation to the FCC to substantiate program implementation.

- a) The Inter-laboratory Calibration Evaluation (ILCE) stated in the CTTL QA protocol shall be performed between SPEAG and CTTL at least once every 12 months. The ILCE acceptance criteria defined in the CTTL QA protocol shall be satisfied for the CTTL, SPEAG and FCC agreements to remain valid.
  - b) Check of Calibration Certificate (CCC) shall be performed by SPEAG for all calibrations performed by CTTL. Written confirmation from SPEAG is required for CTTL to issue calibration certificates under the SPEAG-CTTL Dual-Logo calibration program. Quarterly reports for all calibrations performed by CTTL under the program are also issued by SPEAG.
  - c) The calibration equipment and measurement system used by CTTL shall be verified before each calibration service according to the specific reference SAR<sup>+</sup> probes, dipoles, and DAE calibrated by SPEAG. The results shall be reproducible and within the defined acceptance criteria specified in the CTTL QA protocol before each actual calibration can commence. CTTL shall maintain records of the measurement and calibration system verification results for all calibrations.
  - d) Quality Check of Calibration (QCC) certificates shall be performed by SPEAG at least once every 12 months. SPEAG shall visit CTTL facilities to verify the laboratory, equipment, applied procedures and plausibility of randomly selected certificates.
- 4) A copy of this document shall be provided to CTTL clients that accept calibration services according to the SPEAG-CTTL Dual-Logo calibration program, which should be presented to a TCB (*Telecommunication Certification Body*), to facilitate FCC equipment approval.
  - 5) CTTL shall address any questions raised by its clients or TCBs relating to the SPEAG-CTTL Dual-Logo calibration program and inform the FCC and SPEAG of any critical issues.



Accredited by the Swiss Accreditation Service (SAS)  
The Swiss Accreditation Service is one of the signatories to the EA  
Multilateral Agreement for the recognition of calibration certificates

Accreditation No.: **SCS 0108**

Client **Auden**

Certificate No: **D5GHzV2-1040\_Jun15**

## CALIBRATION CERTIFICATE

Object **D5GHzV2 - SN: 1040**

Calibration procedure(s) **QA CAL-22.v2  
Calibration procedure for dipole validation kits between 3-6 GHz**

Calibration date: **June 22, 2015**

This calibration certificate documents the traceability to national standards, which realize the physical units of measurements (SI).  
The measurements and the uncertainties with confidence probability are given on the following pages and are part of the certificate.

All calibrations have been conducted in the closed laboratory facility: environment temperature ( $22 \pm 3$ )°C and humidity < 70%.

Calibration Equipment used (M&TE critical for calibration)

Primary Standards	ID #	Cal Date (Certificate No.)	Scheduled Calibration
Power meter EPM-442A	GB37480704	07-Oct-14 (No. 217-02020)	Oct-15
Power sensor HP 8481A	US37292783	07-Oct-14 (No. 217-02020)	Oct-15
Power sensor HP 8481A	MY41092317	07-Oct-14 (No. 217-02021)	Oct-15
Reference 20 dB Attenuator	SN: 5058 (20k)	01-Apr-15 (No. 217-02131)	Mar-16
Type-N mismatch combination	SN: 5047.2 / 06327	01-Apr-15 (No. 217-02134)	Mar-16
Reference Probe EX3DV4	SN: 3503	30-Dec-14 (No. EX3-3503_Dec14)	Dec-15
DAE4	SN: 601	18-Aug-14 (No. DAE4-601_Aug14)	Aug-15
Secondary Standards	ID #	Check Date (in house)	Scheduled Check
RF generator R&S SMT-06	100005	04-Aug-99 (in house check Oct-13)	In house check: Oct-16
Network Analyzer HP 8753E	US37390585 S4206	18-Oct-01 (in house check Oct-14)	In house check: Oct-15

Calibrated by: **Michael Weber**      Name: Michael Weber      Function: Laboratory Technician

Signature

Approved by: **Katja Pokovic**      Name: Katja Pokovic      Function: Technical Manager

Issued: June 22, 2015

This calibration certificate shall not be reproduced except in full without written approval of the laboratory.



Accredited by the Swiss Accreditation Service (SAS)

The Swiss Accreditation Service is one of the signatories to the EA Multilateral Agreement for the recognition of calibration certificates

Accreditation No.: **SCS 0108**

### Glossary:

TSL	tissue simulating liquid
ConvF	sensitivity in TSL / NORM x,y,z
N/A	not applicable or not measured

### Calibration is Performed According to the Following Standards:

- IEEE Std 1528-2013, "IEEE Recommended Practice for Determining the Peak Spatial-Averaged Specific Absorption Rate (SAR) in the Human Head from Wireless Communications Devices: Measurement Techniques", June 2013
- IEC 62209-2, "Procedure to determine the Specific Absorption Rate (SAR) for wireless communication devices used in close proximity to the human body (frequency range of 30 MHz to 6 GHz)", March 2010
- KDB 865664, "SAR Measurement Requirements for 100 MHz to 6 GHz"

### Additional Documentation:

- DASY4/5 System Handbook

### Methods Applied and Interpretation of Parameters:

- Measurement Conditions:** Further details are available from the Validation Report at the end of the certificate. All figures stated in the certificate are valid at the frequency indicated.
- Antenna Parameters with TSL:** The dipole is mounted with the spacer to position its feed point exactly below the center marking of the flat phantom section, with the arms oriented parallel to the body axis.
- Feed Point Impedance and Return Loss:** These parameters are measured with the dipole positioned under the liquid filled phantom. The impedance stated is transformed from the measurement at the SMA connector to the feed point. The Return Loss ensures low reflected power. No uncertainty required.
- Electrical Delay:** One-way delay between the SMA connector and the antenna feed point. No uncertainty required.
- SAR measured:** SAR measured at the stated antenna input power.
- SAR normalized:** SAR as measured, normalized to an input power of 1 W at the antenna connector.
- SAR for nominal TSL parameters:** The measured TSL parameters are used to calculate the nominal SAR result.

The reported uncertainty of measurement is stated as the standard uncertainty of measurement multiplied by the coverage factor  $k=2$ , which for a normal distribution corresponds to a coverage probability of approximately 95%.

## Measurement Conditions

DASY system configuration, as far as not given on page 1.

<b>DASY Version</b>	DASY5	V52.8.8
<b>Extrapolation</b>	Advanced Extrapolation	
<b>Phantom</b>	Modular Flat Phantom V5.0	
<b>Distance Dipole Center - TSL</b>	10 mm	with Spacer
<b>Zoom Scan Resolution</b>	dx, dy = 4.0 mm, dz = 1.4 mm	Graded Ratio = 1.4 (Z direction)
<b>Frequency</b>	5200 MHz ± 1 MHz 5300 MHz ± 1 MHz 5500 MHz ± 1 MHz 5600 MHz ± 1 MHz 5800 MHz ± 1 MHz	

## Head TSL parameters at 5200 MHz

The following parameters and calculations were applied.

	<b>Temperature</b>	<b>Permittivity</b>	<b>Conductivity</b>
<b>Nominal Head TSL parameters</b>	22.0 °C	36.0	4.66 mho/m
<b>Measured Head TSL parameters</b>	(22.0 ± 0.2) °C	35.6 ± 6 %	4.56 mho/m ± 6 %
<b>Head TSL temperature change during test</b>	< 0.5 °C	----	----

## SAR result with Head TSL at 5200 MHz

<b>SAR averaged over 1 cm<sup>3</sup> (1 g) of Head TSL</b>	Condition	
SAR measured	100 mW input power	7.85 W/kg
SAR for nominal Head TSL parameters	normalized to 1W	<b>78.3 W/kg ± 19.9 % (k=2)</b>

<b>SAR averaged over 10 cm<sup>3</sup> (10 g) of Head TSL</b>	condition	
SAR measured	100 mW input power	2.26 W/kg
SAR for nominal Head TSL parameters	normalized to 1W	<b>22.5 W/kg ± 19.5 % (k=2)</b>

### Head TSL parameters at 5300 MHz

The following parameters and calculations were applied.

	Temperature	Permittivity	Conductivity
Nominal Head TSL parameters	22.0 °C	35.9	4.76 mho/m
Measured Head TSL parameters	(22.0 ± 0.2) °C	35.5 ± 6 %	4.67 mho/m ± 6 %
Head TSL temperature change during test	< 0.5 °C	----	----

### SAR result with Head TSL at 5300 MHz

SAR averaged over 1 cm <sup>3</sup> (1 g) of Head TSL	Condition	
SAR measured	100 mW input power	8.40 W/kg
SAR for nominal Head TSL parameters	normalized to 1W	<b>83.8 W / kg ± 19.9 % (k=2)</b>

SAR averaged over 10 cm <sup>3</sup> (10 g) of Head TSL	condition	
SAR measured	100 mW input power	2.41 W/kg
SAR for nominal Head TSL parameters	normalized to 1W	<b>24.0 W/kg ± 19.5 % (k=2)</b>

### Head TSL parameters at 5500 MHz

The following parameters and calculations were applied.

	Temperature	Permittivity	Conductivity
Nominal Head TSL parameters	22.0 °C	35.6	4.96 mho/m
Measured Head TSL parameters	(22.0 ± 0.2) °C	35.2 ± 6 %	4.87 mho/m ± 6 %
Head TSL temperature change during test	< 0.5 °C	----	----

### SAR result with Head TSL at 5500 MHz

SAR averaged over 1 cm <sup>3</sup> (1 g) of Head TSL	Condition	
SAR measured	100 mW input power	8.39 W/kg
SAR for nominal Head TSL parameters	normalized to 1W	<b>83.6 W/kg ± 19.9 % (k=2)</b>

SAR averaged over 10 cm <sup>3</sup> (10 g) of Head TSL	condition	
SAR measured	100 mW input power	2.40 W/kg
SAR for nominal Head TSL parameters	normalized to 1W	<b>23.9 W/kg ± 19.5 % (k=2)</b>

### Head TSL parameters at 5600 MHz

The following parameters and calculations were applied.

	Temperature	Permittivity	Conductivity
Nominal Head TSL parameters	22.0 °C	35.5	5.07 mho/m
Measured Head TSL parameters	(22.0 ± 0.2) °C	35.0 ± 6 %	4.98 mho/m ± 6 %
Head TSL temperature change during test	< 0.5 °C	----	----

### SAR result with Head TSL at 5600 MHz

SAR averaged over 1 cm <sup>3</sup> (1 g) of Head TSL	Condition	
SAR measured	100 mW input power	8.24 W/kg
SAR for nominal Head TSL parameters	normalized to 1W	<b>82.1 W/kg ± 19.9 % (k=2)</b>

SAR averaged over 10 cm <sup>3</sup> (10 g) of Head TSL	condition	
SAR measured	100 mW input power	2.35 W/kg
SAR for nominal Head TSL parameters	normalized to 1W	<b>23.4 W/kg ± 19.5 % (k=2)</b>

### Head TSL parameters at 5800 MHz

The following parameters and calculations were applied.

	Temperature	Permittivity	Conductivity
Nominal Head TSL parameters	22.0 °C	35.3	5.27 mho/m
Measured Head TSL parameters	(22.0 ± 0.2) °C	34.7 ± 6 %	5.19 mho/m ± 6 %
Head TSL temperature change during test	< 0.5 °C	----	----

### SAR result with Head TSL at 5800 MHz

SAR averaged over 1 cm <sup>3</sup> (1 g) of Head TSL	Condition	
SAR measured	100 mW input power	8.09 W/kg
SAR for nominal Head TSL parameters	normalized to 1W	<b>80.6 W/kg ± 19.9 % (k=2)</b>

SAR averaged over 10 cm <sup>3</sup> (10 g) of Head TSL	condition	
SAR measured	100 mW input power	2.30 W/kg
SAR for nominal Head TSL parameters	normalized to 1W	<b>22.9 W/kg ± 19.5 % (k=2)</b>

### Body TSL parameters at 5200 MHz

The following parameters and calculations were applied.

	Temperature	Permittivity	Conductivity
Nominal Body TSL parameters	22.0 °C	49.0	5.30 mho/m
Measured Body TSL parameters	(22.0 ± 0.2) °C	47.4 ± 6 %	5.44 mho/m ± 6 %
Body TSL temperature change during test	< 0.5 °C	----	----

### SAR result with Body TSL at 5200 MHz

SAR averaged over 1 cm <sup>3</sup> (1 g) of Body TSL	Condition	
SAR measured	100 mW input power	7.42 W/kg
SAR for nominal Body TSL parameters	normalized to 1W	<b>73.7 W/kg ± 19.9 % (k=2)</b>

SAR averaged over 10 cm <sup>3</sup> (10 g) of Body TSL	condition	
SAR measured	100 mW input power	2.08 W/kg
SAR for nominal Body TSL parameters	normalized to 1W	<b>20.6 W/kg ± 19.5 % (k=2)</b>

### Body TSL parameters at 5300 MHz

The following parameters and calculations were applied.

	Temperature	Permittivity	Conductivity
Nominal Body TSL parameters	22.0 °C	48.9	5.42 mho/m
Measured Body TSL parameters	(22.0 ± 0.2) °C	47.3 ± 6 %	5.57 mho/m ± 6 %
Body TSL temperature change during test	< 0.5 °C	----	----

### SAR result with Body TSL at 5300 MHz

SAR averaged over 1 cm <sup>3</sup> (1 g) of Body TSL	Condition	
SAR measured	100 mW input power	7.56 W/kg
SAR for nominal Body TSL parameters	normalized to 1W	<b>75.2 W/kg ± 19.9 % (k=2)</b>

SAR averaged over 10 cm <sup>3</sup> (10 g) of Body TSL	condition	
SAR measured	100 mW input power	2.13 W/kg
SAR for nominal Body TSL parameters	normalized to 1W	<b>21.1 W/kg ± 19.5 % (k=2)</b>

### Body TSL parameters at 5500 MHz

The following parameters and calculations were applied.

	Temperature	Permittivity	Conductivity
Nominal Body TSL parameters	22.0 °C	48.6	5.65 mho/m
Measured Body TSL parameters	(22.0 ± 0.2) °C	46.9 ± 6 %	5.83 mho/m ± 6 %
Body TSL temperature change during test	< 0.5 °C	----	----

### SAR result with Body TSL at 5500 MHz

SAR averaged over 1 cm <sup>3</sup> (1 g) of Body TSL	Condition	
SAR measured	100 mW input power	8.07 W/kg
SAR for nominal Body TSL parameters	normalized to 1W	<b>80.2 W/kg ± 19.9 % (k=2)</b>

SAR averaged over 10 cm <sup>3</sup> (10 g) of Body TSL	condition	
SAR measured	100 mW input power	2.25 W/kg
SAR for nominal Body TSL parameters	normalized to 1W	<b>22.3 W/kg ± 19.5 % (k=2)</b>

### Body TSL parameters at 5600 MHz

The following parameters and calculations were applied.

	Temperature	Permittivity	Conductivity
Nominal Body TSL parameters	22.0 °C	48.5	5.77 mho/m
Measured Body TSL parameters	(22.0 ± 0.2) °C	46.7 ± 6 %	5.98 mho/m ± 6 %
Body TSL temperature change during test	< 0.5 °C	----	----

### SAR result with Body TSL at 5600 MHz

SAR averaged over 1 cm <sup>3</sup> (1 g) of Body TSL	Condition	
SAR measured	100 mW input power	7.95 W/kg
SAR for nominal Body TSL parameters	normalized to 1W	<b>79.0 W/kg ± 19.9 % (k=2)</b>

SAR averaged over 10 cm <sup>3</sup> (10 g) of Body TSL	condition	
SAR measured	100 mW input power	2.21 W/kg
SAR for nominal Body TSL parameters	normalized to 1W	<b>21.9 W/kg ± 19.5 % (k=2)</b>



### Body TSL parameters at 5800 MHz

The following parameters and calculations were applied.

	Temperature	Permittivity	Conductivity
Nominal Body TSL parameters	22.0 °C	48.2	6.00 mho/m
Measured Body TSL parameters	(22.0 ± 0.2) °C	46.4 ± 6 %	6.26 mho/m ± 6 %
Body TSL temperature change during test	< 0.5 °C	----	----

### SAR result with Body TSL at 5800 MHz

SAR averaged over 1 cm <sup>3</sup> (1 g) of Body TSL	Condition	
SAR measured	100 mW input power	7.71 W/kg
SAR for nominal Body TSL parameters	normalized to 1W	<b>76.6 W/kg ± 19.9 % (k=2)</b>

SAR averaged over 10 cm <sup>3</sup> (10 g) of Body TSL	condition	
SAR measured	100 mW input power	2.13 W/kg
SAR for nominal Body TSL parameters	normalized to 1W	<b>21.1 W/kg ± 19.5 % (k=2)</b>

## Appendix (Additional assessments outside the scope of SCS 0108)

### Antenna Parameters with Head TSL at 5200 MHz

Impedance, transformed to feed point	50.5 $\Omega$ - 7.4 j $\Omega$
Return Loss	- 22.7 dB

### Antenna Parameters with Head TSL at 5300 MHz

Impedance, transformed to feed point	49.1 $\Omega$ - 3.0 j $\Omega$
Return Loss	- 29.9 dB

### Antenna Parameters with Head TSL at 5500 MHz

Impedance, transformed to feed point	50.0 $\Omega$ - 4.6 j $\Omega$
Return Loss	- 26.7 dB

### Antenna Parameters with Head TSL at 5600 MHz

Impedance, transformed to feed point	56.7 $\Omega$ - 3.7 j $\Omega$
Return Loss	- 22.9 dB

### Antenna Parameters with Head TSL at 5800 MHz

Impedance, transformed to feed point	54.5 $\Omega$ - 1.2 j $\Omega$
Return Loss	- 27.1 dB

### Antenna Parameters with Body TSL at 5200 MHz

Impedance, transformed to feed point	49.4 $\Omega$ - 6.5 j $\Omega$
Return Loss	- 23.7 dB

### Antenna Parameters with Body TSL at 5300 MHz

Impedance, transformed to feed point	49.5 $\Omega$ - 2.2 j $\Omega$
Return Loss	- 33.1 dB

### Antenna Parameters with Body TSL at 5500 MHz

Impedance, transformed to feed point	50.6 $\Omega$ - 3.8 j $\Omega$
Return Loss	- 28.4 dB

### Antenna Parameters with Body TSL at 5600 MHz

Impedance, transformed to feed point	56.9 $\Omega$ - 2.7 j $\Omega$
Return Loss	- 23.2 dB

### Antenna Parameters with Body TSL at 5800 MHz

Impedance, transformed to feed point	55.1 $\Omega$ - 0.3 j $\Omega$
Return Loss	- 26.2 dB

### General Antenna Parameters and Design

Electrical Delay (one direction)	1.203 ns
----------------------------------	----------

After long term use with 100W radiated power, only a slight warming of the dipole near the feedpoint can be measured.

The dipole is made of standard semirigid coaxial cable. The center conductor of the feeding line is directly connected to the second arm of the dipole. The antenna is therefore short-circuited for DC-signals. On some of the dipoles, small end caps are added to the dipole arms in order to improve matching when loaded according to the position as explained in the "Measurement Conditions" paragraph. The SAR data are not affected by this change. The overall dipole length is still according to the Standard.

No excessive force must be applied to the dipole arms, because they might bend or the soldered connections near the feedpoint may be damaged.

### Additional EUT Data

Manufactured by	SPEAG
Manufactured on	December 30, 2005

## DASY5 Validation Report for Head TSL

Date: 18.06.2015

Test Laboratory: SPEAG, Zurich, Switzerland

**DUT: Dipole 5GHz; Type: D5GHzV2; Serial: D5GHzV2 - SN: 1040**

Communication System: UID 0 - CW; Frequency: 5200 MHz, Frequency: 5300 MHz, Frequency: 5500 MHz, Frequency: 5600 MHz, Frequency: 5800 MHz

Medium parameters used:  $f = 5200$  MHz;  $\sigma = 4.56$  S/m;  $\epsilon_r = 35.6$ ;  $\rho = 1000$  kg/m<sup>3</sup>, Medium parameters used:  $f = 5300$  MHz;  $\sigma = 4.67$  S/m;  $\epsilon_r = 35.5$ ;  $\rho = 1000$  kg/m<sup>3</sup>, Medium parameters used:  $f = 5500$  MHz;  $\sigma = 4.87$  S/m;  $\epsilon_r = 35.2$ ;  $\rho = 1000$  kg/m<sup>3</sup>, Medium parameters used:  $f = 5600$  MHz;  $\sigma = 4.98$  S/m;  $\epsilon_r = 35$ ;  $\rho = 1000$  kg/m<sup>3</sup>, Medium parameters used:  $f = 5800$  MHz;  $\sigma = 5.19$  S/m;  $\epsilon_r = 34.7$ ;  $\rho = 1000$  kg/m<sup>3</sup>

Phantom section: Flat Section

Measurement Standard: DASY5 (IEEE/IEC/ANSI C63.19-2011)

DASY52 Configuration:

- Probe: EX3DV4 - SN3503; ConvF(5.51, 5.51, 5.51); Calibrated: 30.12.2014, ConvF(5.21, 5.21, 5.21); Calibrated: 30.12.2014, ConvF(5.12, 5.12, 5.12); Calibrated: 30.12.2014, ConvF(4.92, 4.92, 4.92); Calibrated: 30.12.2014, ConvF(4.9, 4.9, 4.9); Calibrated: 30.12.2014;
- Sensor-Surface: 1.4mm (Mechanical Surface Detection)
- Electronics: DAE4 Sn601; Calibrated: 18.08.2014
- Phantom: Flat Phantom 5.0 (front); Type: QD000P50AA; Serial: 1001
- DASY52 52.8.8(1222); SEMCAD X 14.6.10(7331)

**Dipole Calibration for Head Tissue/Pin=100mW, dist=10mm, f=5200 MHz/Zoom Scan, dist=1.4mm (8x8x7)/Cube 0:** Measurement grid: dx=4mm, dy=4mm, dz=1.4mm

Reference Value = 64.89 V/m; Power Drift = 0.01 dB

Peak SAR (extrapolated) = 28.0 W/kg

**SAR(1 g) = 7.85 W/kg; SAR(10 g) = 2.26 W/kg**

Maximum value of SAR (measured) = 17.7 W/kg

**Dipole Calibration for Head Tissue/Pin=100mW, dist=10mm, f=5300 MHz/Zoom Scan, dist=1.4mm (8x8x7)/Cube 0:** Measurement grid: dx=4mm, dy=4mm, dz=1.4mm

Reference Value = 65.58 V/m; Power Drift = 0.06 dB

Peak SAR (extrapolated) = 31.2 W/kg

**SAR(1 g) = 8.4 W/kg; SAR(10 g) = 2.41 W/kg**

Maximum value of SAR (measured) = 19.2 W/kg

**Dipole Calibration for Head Tissue/Pin=100mW, dist=10mm, f=5500 MHz/Zoom Scan, dist=1.4mm (8x8x7)/Cube 0:** Measurement grid: dx=4mm, dy=4mm, dz=1.4mm

Reference Value = 64.47 V/m; Power Drift = 0.06 dB

Peak SAR (extrapolated) = 32.4 W/kg

**SAR(1 g) = 8.39 W/kg; SAR(10 g) = 2.4 W/kg**

Maximum value of SAR (measured) = 19.5 W/kg

**Dipole Calibration for Head Tissue/Pin=100mW, dist=10mm, f=5600 MHz/Zoom Scan, dist=1.4mm (8x8x7)/Cube 0:** Measurement grid: dx=4mm, dy=4mm, dz=1.4mm  
Reference Value = 64.26 V/m; Power Drift = 0.04 dB  
Peak SAR (extrapolated) = 31.9 W/kg  
SAR(1 g) = 8.24 W/kg; SAR(10 g) = 2.35 W/kg

**Dipole Calibration for Head Tissue/Pin=100mW, dist=10mm, f=5800 MHz/Zoom Scan, dist=1.4mm (8x8x7)/Cube 0:** Measurement grid: dx=4mm, dy=4mm, dz=1.4mm  
Reference Value = 62.12 V/m; Power Drift = 0.04 dB  
Peak SAR (extrapolated) = 32.8 W/kg  
SAR(1 g) = 8.09 W/kg; SAR(10 g) = 2.3 W/kg  
Maximum value of SAR (measured) = 19.4 W/kg

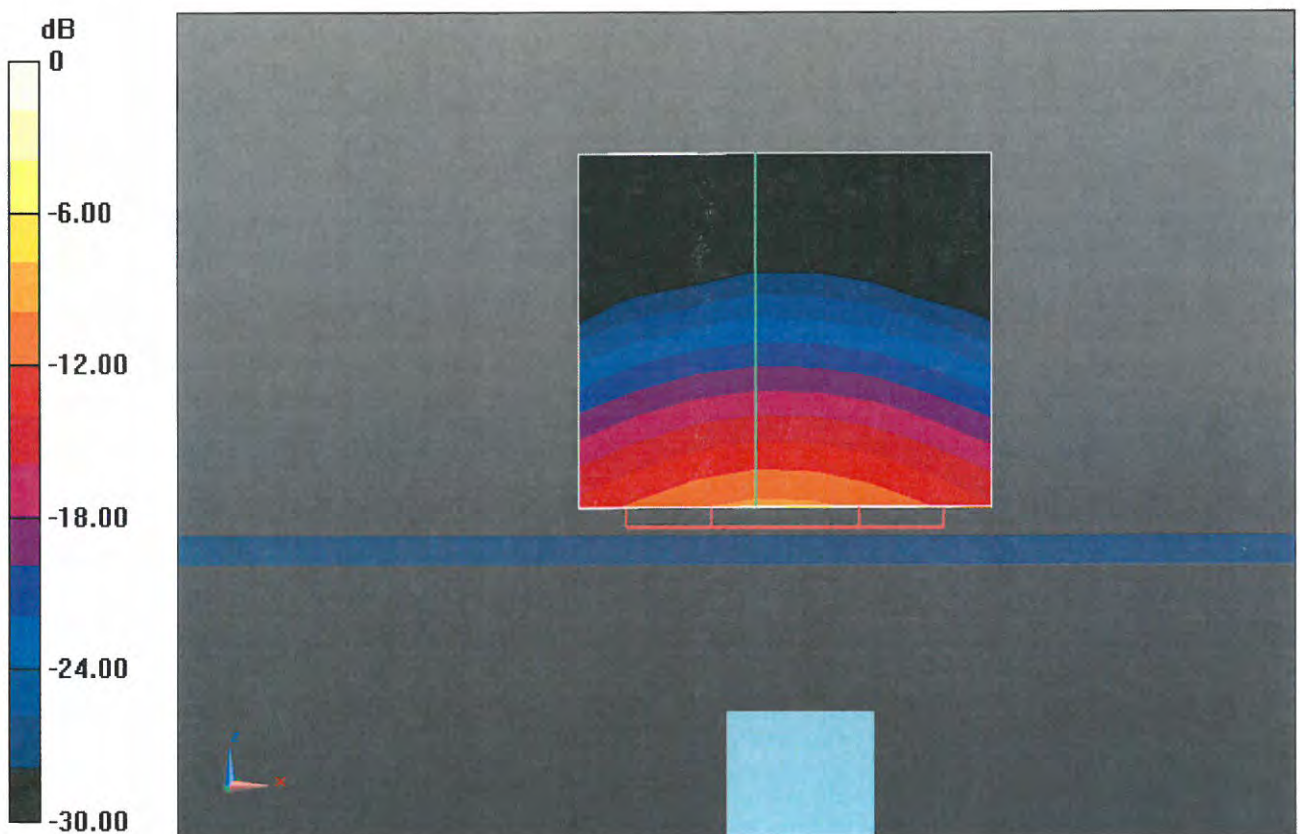

# Impedance Measurement Plot for Head TSL

18 Jun 2015 15:47:44

CH1 S11 1 U FS 1: 50.461  $\Omega$  -7.4043  $\Omega$  4.1336 pF 5 200.000 000 MHz

\*  
Del  
Cor  
Avg  
16  
H1d

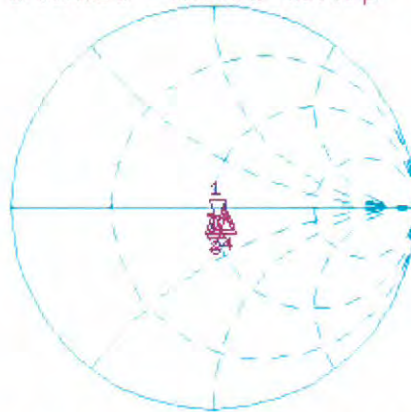

CH1 Markers  
2: 49.078  $\Omega$   
-3.0488  $\Omega$   
5.30000 GHz  
3: 50.027  $\Omega$   
-4.6426  $\Omega$   
5.50000 GHz  
4: 56.734  $\Omega$   
-3.6836  $\Omega$   
5.60000 GHz  
5: 54.475  $\Omega$   
-1.1758  $\Omega$   
5.80000 GHz

CH2 S11 LOG 5 dB/REF -20 dB 1:-22.656 dB 5 200.000 000 MHz

Cor  
Avg  
16  
H1d

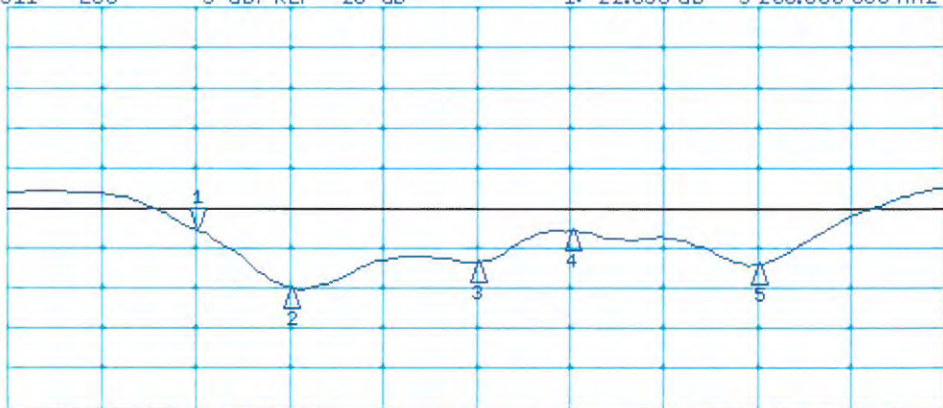

CH2 Markers  
2:-29.856 dB  
5.30000 GHz  
3:-26.672 dB  
5.50000 GHz  
4:-22.866 dB  
5.60000 GHz  
5:-27.082 dB  
5.80000 GHz

START 5 000.000 000 MHz

STOP 6 000.000 000 MHz

## DASY5 Validation Report for Body TSL

Date: 22.06.2015

Test Laboratory: SPEAG, Zurich, Switzerland

**DUT: Dipole 5GHz; Type: D5GHzV2; Serial: D5GHzV2 - SN: 1040**

Communication System: UID 0 - CW; Frequency: 5200 MHz, Frequency: 5300 MHz, Frequency: 5500 MHz, Frequency: 5600 MHz, Frequency: 5800 MHz

Medium parameters used:  $f = 5200$  MHz;  $\sigma = 5.44$  S/m;  $\epsilon_r = 47.4$ ;  $\rho = 1000$  kg/m<sup>3</sup>, Medium parameters used:  $f = 5300$  MHz;  $\sigma = 5.57$  S/m;  $\epsilon_r = 47.3$ ;  $\rho = 1000$  kg/m<sup>3</sup>, Medium parameters used:  $f = 5500$  MHz;  $\sigma = 5.83$  S/m;  $\epsilon_r = 46.9$ ;  $\rho = 1000$  kg/m<sup>3</sup>, Medium parameters used:  $f = 5600$  MHz;  $\sigma = 5.98$  S/m;  $\epsilon_r = 46.7$ ;  $\rho = 1000$  kg/m<sup>3</sup>, Medium parameters used:  $f = 5800$  MHz;  $\sigma = 6.26$  S/m;  $\epsilon_r = 46.4$ ;  $\rho = 1000$  kg/m<sup>3</sup>

Phantom section: Flat Section

Measurement Standard: DASY5 (IEEE/IEC/ANSI C63.19-2011)

DASY52 Configuration:

- Probe: EX3DV4 - SN3503; ConvF(4.95, 4.95, 4.95); Calibrated: 30.12.2014, ConvF(4.78, 4.78, 4.78); Calibrated: 30.12.2014, ConvF(4.45, 4.45, 4.45); Calibrated: 30.12.2014, ConvF(4.35, 4.35, 4.35); Calibrated: 30.12.2014, ConvF(4.32, 4.32, 4.32); Calibrated: 30.12.2014;
- Sensor-Surface: 1.4mm (Mechanical Surface Detection)
- Electronics: DAE4 Sn601; Calibrated: 18.08.2014
- Phantom: Flat Phantom 5.0 (back); Type: QD000P50AA; Serial: 1002
- DASY52 52.8.8(1222); SEMCAD X 14.6.10(7331)

### **Dipole Calibration for Body Tissue/Pin=100mW, dist=10mm, f=5200 MHz/Zoom Scan,**

**dist=1.4mm (8x8x7)/Cube 0:** Measurement grid: dx=4mm, dy=4mm, dz=1.4mm

Reference Value = 58.13 V/m; Power Drift = -0.02 dB

Peak SAR (extrapolated) = 28.4 W/kg

**SAR(1 g) = 7.42 W/kg; SAR(10 g) = 2.08 W/kg**

Maximum value of SAR (measured) = 16.9 W/kg

### **Dipole Calibration for Body Tissue/Pin=100mW, dist=10mm, f=5300 MHz/Zoom Scan,**

**dist=1.4mm (8x8x7)/Cube 0:** Measurement grid: dx=4mm, dy=4mm, dz=1.4mm

Reference Value = 57.99 V/m; Power Drift = 0.06 dB

Peak SAR (extrapolated) = 29.5 W/kg

**SAR(1 g) = 7.56 W/kg; SAR(10 g) = 2.13 W/kg**

Maximum value of SAR (measured) = 17.4 W/kg

### **Dipole Calibration for Body Tissue/Pin=100mW, dist=10mm, f=5500 MHz/Zoom Scan,**

**dist=1.4mm (8x8x7)/Cube 0:** Measurement grid: dx=4mm, dy=4mm, dz=1.4mm

Reference Value = 59.09 V/m; Power Drift = 0.01 dB

Peak SAR (extrapolated) = 33.6 W/kg

**SAR(1 g) = 8.07 W/kg; SAR(10 g) = 2.25 W/kg**

Maximum value of SAR (measured) = 18.9 W/kg

**Dipole Calibration for Body Tissue/Pin=100mW, dist=10mm, f=5600 MHz/Zoom Scan, dist=1.4mm (8x8x7)/Cube 0:** Measurement grid: dx=4mm, dy=4mm, dz=1.4mm  
Reference Value = 57.82 V/m; Power Drift = -0.00 dB  
Peak SAR (extrapolated) = 34.0 W/kg  
**SAR(1 g) = 7.95 W/kg; SAR(10 g) = 2.21 W/kg**

**Dipole Calibration for Body Tissue/Pin=100mW, dist=10mm, f=5800 MHz/Zoom Scan, dist=1.4mm (8x8x7)/Cube 0:** Measurement grid: dx=4mm, dy=4mm, dz=1.4mm  
Reference Value = 55.57 V/m; Power Drift = 0.05 dB  
Peak SAR (extrapolated) = 35.0 W/kg  
**SAR(1 g) = 7.71 W/kg; SAR(10 g) = 2.13 W/kg**  
Maximum value of SAR (measured) = 18.6 W/kg

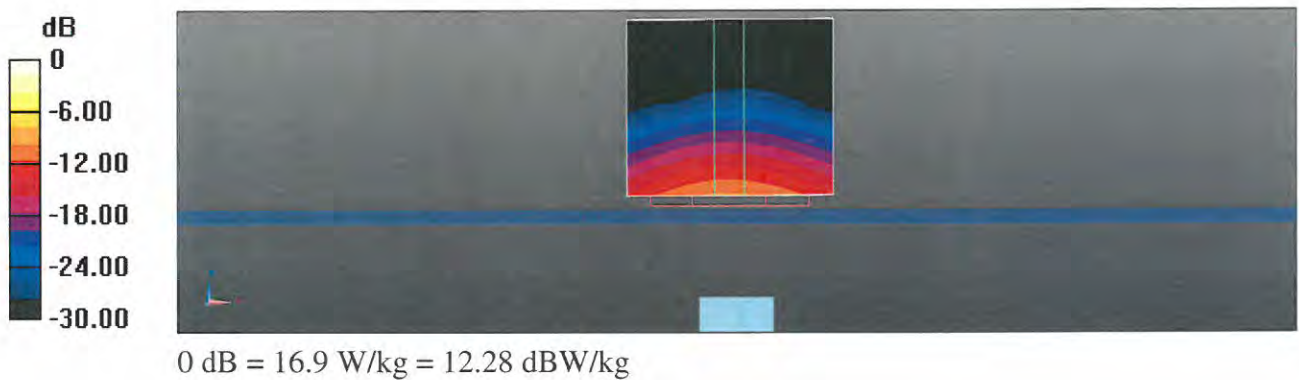



# Impedance Measurement Plot for Body TSL

22 Jun 2015 12:08:57

CH1 S11 1 U FS 1: 49.396  $\Omega$  -6.4512  $\Omega$  4.7444 pF 5 200.000 000 MHz

\*  
De1  
Cor  
Avg  
16  
H1d

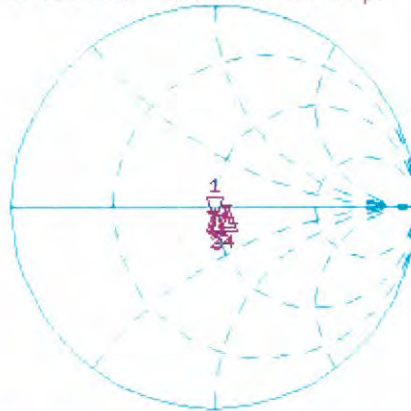

CH1 Markers  
2: 49.537  $\Omega$   
-2.1563  $\Omega$   
5.30000 GHz  
3: 50.641  $\Omega$   
-3.7910  $\Omega$   
5.50000 GHz  
4: 56.937  $\Omega$   
-2.6699  $\Omega$   
5.60000 GHz  
5: 55.143  $\Omega$   
-316.41 m $\Omega$   
5.80000 GHz

CH2 S11 LOG 5 dB/REF -20 dB 1:-23.734 dB 5 200.000 000 MHz

De1  
Cor  
Avg  
16  
H1d

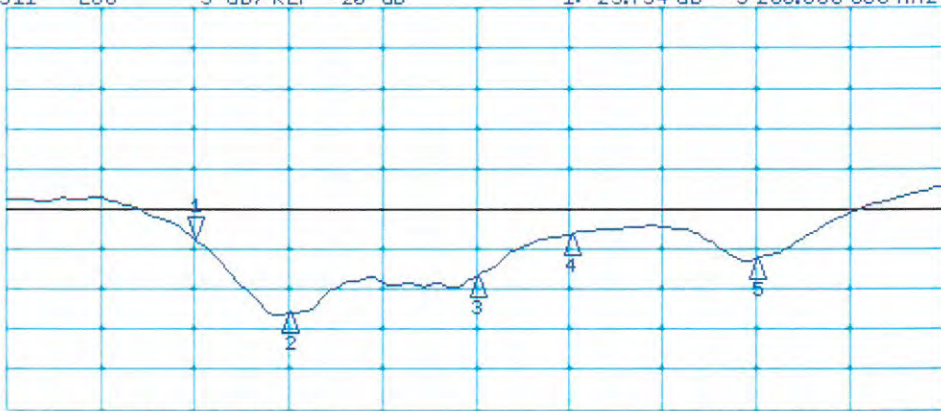

CH2 Markers  
2:-33.000 dB  
5.30000 GHz  
3:-28.363 dB  
5.50000 GHz  
4:-23.159 dB  
5.60000 GHz  
5:-26.194 dB  
5.80000 GHz

START 5 000.000 000 MHz

STOP 6 000.000 000 MHz



Accredited by the Swiss Accreditation Service (SAS)  
The Swiss Accreditation Service is one of the signatories to the EA  
Multilateral Agreement for the recognition of calibration certificates

Accreditation No.: **SCS 0108**

Client **BV ADT (Auden)**

Certificate No: **EX3-3864\_Jul15**

## CALIBRATION CERTIFICATE

Object **EX3DV4 - SN:3864**

Calibration procedure(s) **QA CAL-01.v9, QA CAL-14.v4, QA CAL-23.v5, QA CAL-25.v6  
Calibration procedure for dosimetric E-field probes**

Calibration date: **July 23, 2015**

This calibration certificate documents the traceability to national standards, which realize the physical units of measurements (SI).  
The measurements and the uncertainties with confidence probability are given on the following pages and are part of the certificate.

All calibrations have been conducted in the closed laboratory facility: environment temperature (22 ± 3)°C and humidity < 70%.

Calibration Equipment used (M&TE critical for calibration)

Primary Standards	ID	Cal Date (Certificate No.)	Scheduled Calibration
Power meter E4419B	GB41293874	01-Apr-15 (No. 217-02128)	Mar-16
Power sensor E4412A	MY41498087	01-Apr-15 (No. 217-02128)	Mar-16
Reference 3 dB Attenuator	SN: S5054 (3c)	01-Apr-15 (No. 217-02129)	Mar-16
Reference 20 dB Attenuator	SN: S5277 (20x)	01-Apr-15 (No. 217-02132)	Mar-16
Reference 30 dB Attenuator	SN: S5129 (30b)	01-Apr-15 (No. 217-02133)	Mar-16
Reference Probe ES3DV2	SN: 3013	30-Dec-14 (No. ES3-3013_Dec14)	Dec-15
DAE4	SN: 660	14-Jan-15 (No. DAE4-660_Jan15)	Jan-16
Secondary Standards	ID	Check Date (in house)	Scheduled Check
RF generator HP 8648C	US3642U01700	4-Aug-99 (in house check Apr-13)	In house check: Apr-16
Network Analyzer HP 8753E	US37390585	18-Oct-01 (in house check Oct-14)	In house check: Oct-15

Calibrated by:	Name <b>Claudio Leubler</b>	Function <b>Laboratory Technician</b>	Signature 
Approved by:	Name <b>Katja Pokovic</b>	Function <b>Technical Manager</b>	

Issued: July 24, 2015

This calibration certificate shall not be reproduced except in full without written approval of the laboratory.



Accredited by the Swiss Accreditation Service (SAS)

Accreditation No.: **SCS 0108**

The Swiss Accreditation Service is one of the signatories to the EA Multilateral Agreement for the recognition of calibration certificates

### Glossary:

TSL	tissue simulating liquid
NORM <sub>x,y,z</sub>	sensitivity in free space
ConvF	sensitivity in TSL / NORM <sub>x,y,z</sub>
DCP	diode compression point
CF	crest factor (1/duty_cycle) of the RF signal
A, B, C, D	modulation dependent linearization parameters
Polarization $\varphi$	$\varphi$ rotation around probe axis
Polarization $\vartheta$	$\vartheta$ rotation around an axis that is in the plane normal to probe axis (at measurement center), i.e., $\vartheta = 0$ is normal to probe axis
Connector Angle	information used in DASY system to align probe sensor X to the robot coordinate system

### Calibration is Performed According to the Following Standards:

- IEEE Std 1528-2013, "IEEE Recommended Practice for Determining the Peak Spatial-Averaged Specific Absorption Rate (SAR) in the Human Head from Wireless Communications Devices: Measurement Techniques", June 2013
- IEC 62209-1, "Procedure to measure the Specific Absorption Rate (SAR) for hand-held devices used in close proximity to the ear (frequency range of 300 MHz to 3 GHz)", February 2005
- IEC 62209-2, "Procedure to determine the Specific Absorption Rate (SAR) for wireless communication devices used in close proximity to the human body (frequency range of 30 MHz to 6 GHz)", March 2010
- KDB 865664, "SAR Measurement Requirements for 100 MHz to 6 GHz"

### Methods Applied and Interpretation of Parameters:

- NORM<sub>x,y,z</sub>**: Assessed for E-field polarization  $\vartheta = 0$  ( $f \leq 900$  MHz in TEM-cell;  $f > 1800$  MHz: R22 waveguide). NORM<sub>x,y,z</sub> are only intermediate values, i.e., the uncertainties of NORM<sub>x,y,z</sub> does not affect the E<sup>2</sup>-field uncertainty inside TSL (see below ConvF).
- NORM(f)<sub>x,y,z</sub>** = NORM<sub>x,y,z</sub> \* frequency\_response (see Frequency Response Chart). This linearization is implemented in DASY4 software versions later than 4.2. The uncertainty of the frequency response is included in the stated uncertainty of ConvF.
- DCP<sub>x,y,z</sub>**: DCP are numerical linearization parameters assessed based on the data of power sweep with CW signal (no uncertainty required). DCP does not depend on frequency nor media.
- PAR**: PAR is the Peak to Average Ratio that is not calibrated but determined based on the signal characteristics
- A<sub>x,y,z</sub>; B<sub>x,y,z</sub>; C<sub>x,y,z</sub>; D<sub>x,y,z</sub>; VR<sub>x,y,z</sub>; A, B, C, D** are numerical linearization parameters assessed based on the data of power sweep for specific modulation signal. The parameters do not depend on frequency nor media. VR is the maximum calibration range expressed in RMS voltage across the diode.
- ConvF and Boundary Effect Parameters**: Assessed in flat phantom using E-field (or Temperature Transfer Standard for  $f \leq 800$  MHz) and inside waveguide using analytical field distributions based on power measurements for  $f > 800$  MHz. The same setups are used for assessment of the parameters applied for boundary compensation (alpha, depth) of which typical uncertainty values are given. These parameters are used in DASY4 software to improve probe accuracy close to the boundary. The sensitivity in TSL corresponds to NORM<sub>x,y,z</sub> \* ConvF whereby the uncertainty corresponds to that given for ConvF. A frequency dependent ConvF is used in DASY version 4.4 and higher which allows extending the validity from  $\pm 50$  MHz to  $\pm 100$  MHz.
- Spherical isotropy (3D deviation from isotropy)**: in a field of low gradients realized using a flat phantom exposed by a patch antenna.
- Sensor Offset**: The sensor offset corresponds to the offset of virtual measurement center from the probe tip (on probe axis). No tolerance required.
- Connector Angle**: The angle is assessed using the information gained by determining the NORM<sub>x</sub> (no uncertainty required).

# Probe EX3DV4

## SN:3864

Manufactured: February 2, 2012  
Calibrated: July 23, 2015

Calibrated for DASY/EASY Systems  
(Note: non-compatible with DASY2 system!)

## DASY/EASY - Parameters of Probe: EX3DV4 - SN:3864

### Basic Calibration Parameters

	Sensor X	Sensor Y	Sensor Z	Unc (k=2)
Norm ( $\mu\text{V}/(\text{V}/\text{m})^2$ ) <sup>A</sup>	0.47	0.44	0.49	$\pm 10.1 \%$
DCP (mV) <sup>B</sup>	100.0	96.3	99.5	

### Modulation Calibration Parameters

UID	Communication System Name		A dB	B dB $\sqrt{\mu\text{V}}$	C	D dB	VR mV	Unc <sup>E</sup> (k=2)
0	CW	X	0.0	0.0	1.0	0.00	129.6	$\pm 2.7 \%$
		Y	0.0	0.0	1.0		144.4	
		Z	0.0	0.0	1.0		139.5	

The reported uncertainty of measurement is stated as the standard uncertainty of measurement multiplied by the coverage factor  $k=2$ , which for a normal distribution corresponds to a coverage probability of approximately 95%.

<sup>A</sup> The uncertainties of Norm X,Y,Z do not affect the  $E^2$ -field uncertainty inside TSL (see Pages 5 and 6).

<sup>B</sup> Numerical linearization parameter: uncertainty not required

<sup>E</sup> Uncertainty is determined using the max. deviation from linear response applying rectangular distribution and is expressed for the square of the field value.

## DASY/EASY - Parameters of Probe: EX3DV4 - SN:3864

### Calibration Parameter Determined in Head Tissue Simulating Media

f (MHz) <sup>C</sup>	Relative Permittivity <sup>F</sup>	Conductivity (S/m) <sup>F</sup>	ConvF X	ConvF Y	ConvF Z	Alpha <sup>G</sup>	Depth <sup>G</sup> (mm)	Unc (k=2)
750	41.9	0.89	10.24	10.24	10.24	0.24	1.16	± 12.0 %
835	41.5	0.90	9.90	9.90	9.90	0.22	1.20	± 12.0 %
900	41.5	0.97	9.73	9.73	9.73	0.19	1.59	± 12.0 %
1450	40.5	1.20	8.84	8.84	8.84	0.22	1.22	± 12.0 %
1640	40.3	1.29	8.56	8.56	8.56	0.33	0.80	± 12.0 %
1750	40.1	1.37	8.49	8.49	8.49	0.34	0.80	± 12.0 %
1900	40.0	1.40	8.21	8.21	8.21	0.35	0.80	± 12.0 %
2100	39.8	1.49	8.32	8.32	8.32	0.33	0.85	± 12.0 %
2300	39.5	1.67	7.88	7.88	7.88	0.36	0.83	± 12.0 %
2450	39.2	1.80	7.35	7.35	7.35	0.39	0.82	± 12.0 %
2600	39.0	1.96	7.26	7.26	7.26	0.45	0.83	± 12.0 %
3500	37.9	2.91	6.81	6.81	6.81	0.36	1.01	± 13.1 %
5200	36.0	4.66	5.61	5.61	5.61	0.30	1.80	± 13.1 %
5250	35.9	4.71	5.41	5.41	5.41	0.35	1.80	± 13.1 %
5300	35.9	4.76	5.28	5.28	5.28	0.35	1.80	± 13.1 %
5600	35.5	5.07	4.77	4.77	4.77	0.40	1.80	± 13.1 %
5800	35.3	5.27	4.91	4.91	4.91	0.40	1.80	± 13.1 %

<sup>C</sup> Frequency validity above 300 MHz of ± 100 MHz only applies for DASY v4.4 and higher (see Page 2), else it is restricted to ± 50 MHz. The uncertainty is the RSS of the ConvF uncertainty at calibration frequency and the uncertainty for the indicated frequency band. Frequency validity below 300 MHz is ± 10, 25, 40, 50 and 70 MHz for ConvF assessments at 30, 64, 128, 150 and 220 MHz respectively. Above 5 GHz frequency validity can be extended to ± 110 MHz.

<sup>F</sup> At frequencies below 3 GHz, the validity of tissue parameters ( $\epsilon$  and  $\sigma$ ) can be relaxed to ± 10% if liquid compensation formula is applied to measured SAR values. At frequencies above 3 GHz, the validity of tissue parameters ( $\epsilon$  and  $\sigma$ ) is restricted to ± 5%. The uncertainty is the RSS of the ConvF uncertainty for indicated target tissue parameters.

<sup>G</sup> Alpha/Depth are determined during calibration. SPEAG warrants that the remaining deviation due to the boundary effect after compensation is always less than ± 1% for frequencies below 3 GHz and below ± 2% for frequencies between 3-6 GHz at any distance larger than half the probe tip diameter from the boundary.

## DASY/EASY - Parameters of Probe: EX3DV4 - SN:3864

### Calibration Parameter Determined in Body Tissue Simulating Media

f (MHz) <sup>C</sup>	Relative Permittivity <sup>F</sup>	Conductivity (S/m) <sup>F</sup>	ConvF X	ConvF Y	ConvF Z	Alpha <sup>G</sup>	Depth <sup>G</sup> (mm)	Unc (k=2)
750	55.5	0.96	9.94	9.94	9.94	0.22	1.28	± 12.0 %
835	55.2	0.97	9.83	9.83	9.83	0.25	1.19	± 12.0 %
900	55.0	1.05	9.59	9.59	9.59	0.30	1.03	± 12.0 %
1450	54.0	1.30	8.35	8.35	8.35	0.14	1.99	± 12.0 %
1640	53.8	1.40	8.53	8.53	8.53	0.40	0.80	± 12.0 %
1750	53.4	1.49	8.13	8.13	8.13	0.42	0.82	± 12.0 %
1900	53.3	1.52	7.88	7.88	7.88	0.36	0.80	± 12.0 %
2100	53.2	1.62	8.22	8.22	8.22	0.42	0.80	± 12.0 %
2300	52.9	1.81	7.61	7.61	7.61	0.37	0.90	± 12.0 %
2450	52.7	1.95	7.30	7.30	7.30	0.34	0.90	± 12.0 %
2600	52.5	2.16	7.19	7.19	7.19	0.25	0.99	± 12.0 %
3500	51.3	3.31	6.47	6.47	6.47	0.36	1.16	± 13.1 %
5200	49.0	5.30	4.75	4.75	4.75	0.40	1.90	± 13.1 %
5250	48.9	5.36	4.64	4.64	4.64	0.40	1.90	± 13.1 %
5300	48.9	5.42	4.41	4.41	4.41	0.45	1.90	± 13.1 %
5600	48.5	5.77	3.93	3.93	3.93	0.45	1.90	± 13.1 %
5800	48.2	6.00	4.20	4.20	4.20	0.45	1.90	± 13.1 %

<sup>C</sup> Frequency validity above 300 MHz of ± 100 MHz only applies for DASY v4 4 and higher (see Page 2), else it is restricted to ± 50 MHz. The uncertainty is the RSS of the ConvF uncertainty at calibration frequency and the uncertainty for the indicated frequency band. Frequency validity below 300 MHz is ± 10, 25, 40, 50 and 70 MHz for ConvF assessments at 30, 64, 128, 150 and 220 MHz respectively. Above 5 GHz frequency validity can be extended to ± 110 MHz.

<sup>F</sup> At frequencies below 3 GHz, the validity of tissue parameters ( $\epsilon$  and  $\sigma$ ) can be relaxed to ± 10% if liquid compensation formula is applied to measured SAR values. At frequencies above 3 GHz, the validity of tissue parameters ( $\epsilon$  and  $\sigma$ ) is restricted to ± 5%. The uncertainty is the RSS of the ConvF uncertainty for indicated target tissue parameters.

<sup>G</sup> Alpha/Depth are determined during calibration. SPEAG warrants that the remaining deviation due to the boundary effect after compensation is always less than ± 1% for frequencies below 3 GHz and below ± 2% for frequencies between 3-6 GHz at any distance larger than half the probe tip diameter from the boundary.

### Frequency Response of E-Field (TEM-Cell:ifi110 EXX, Waveguide: R22)

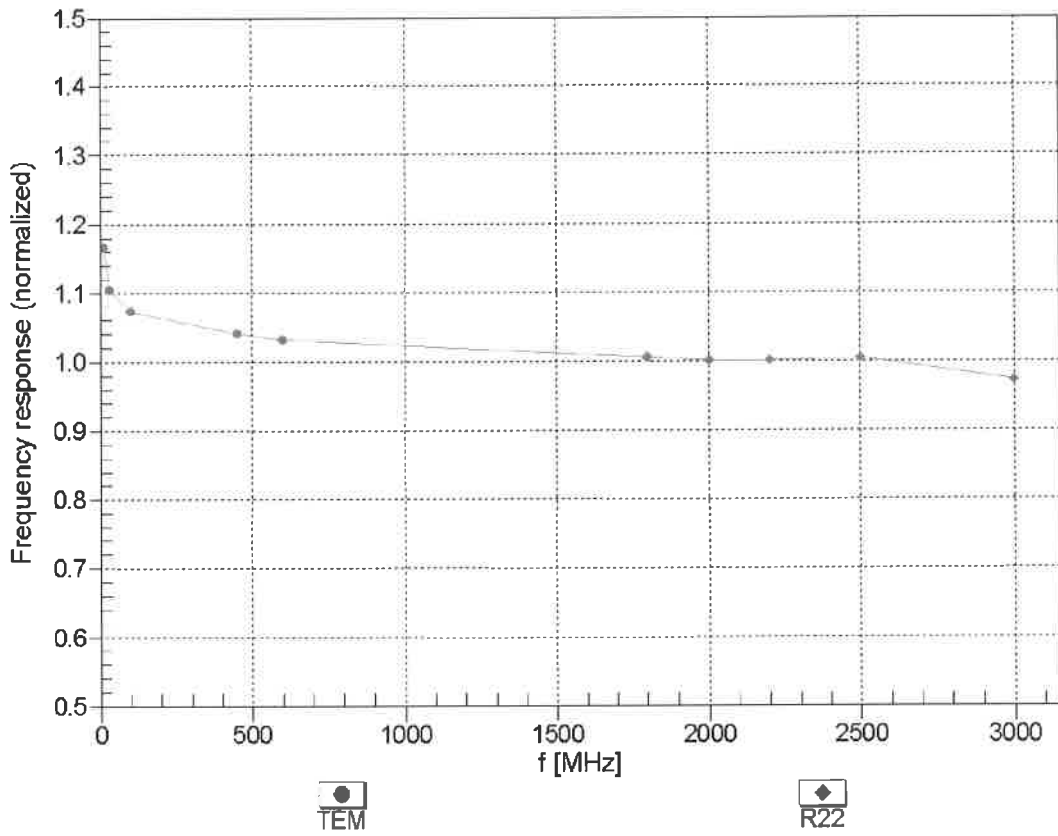

Uncertainty of Frequency Response of E-field:  $\pm 6.3\%$  (k=2)



### Receiving Pattern ( $\phi$ ), $\theta = 0^\circ$

f=600 MHz,TEM

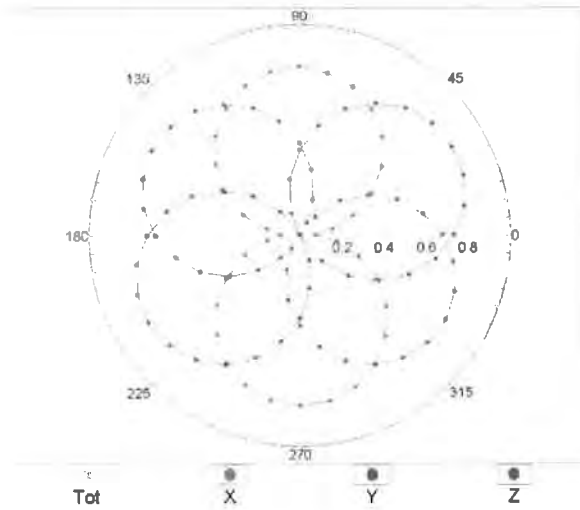

f=1800 MHz,R22

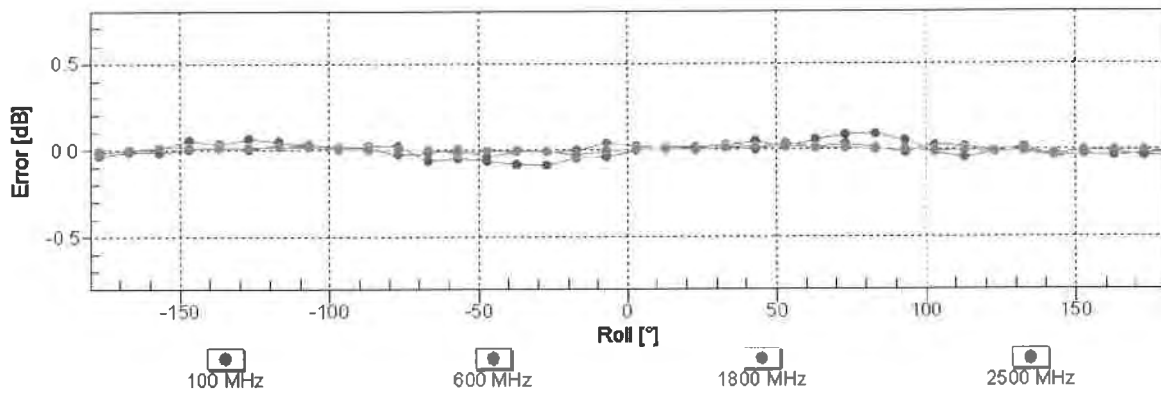
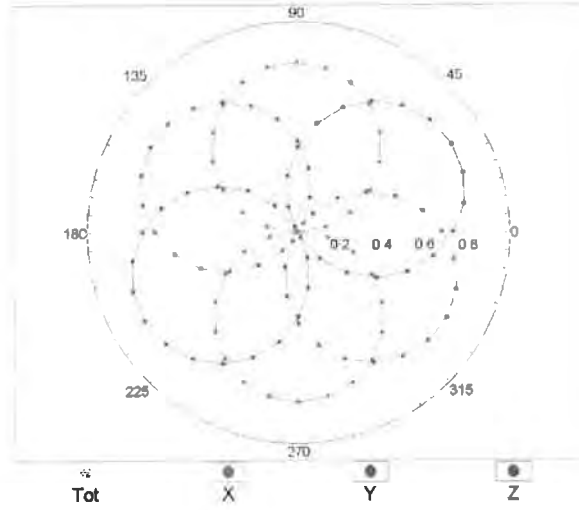

Uncertainty of Axial Isotropy Assessment:  $\pm 0.5\%$  (k=2)

### Dynamic Range $f(SAR_{head})$ (TEM cell , $f_{eval}= 1900$ MHz)

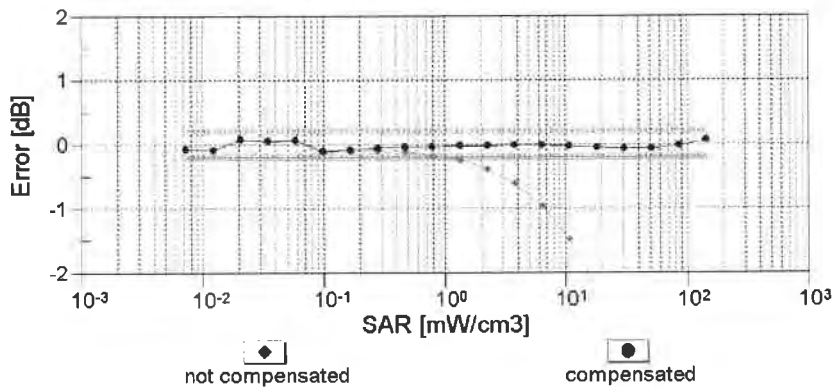
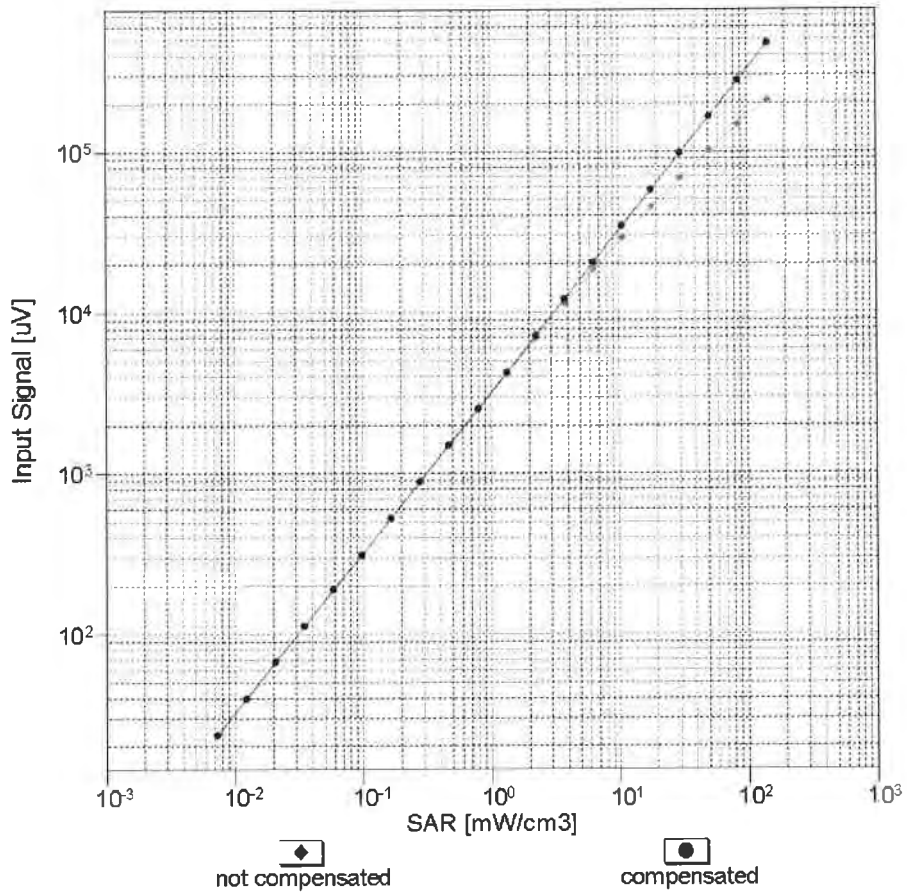

**Uncertainty of Linearity Assessment: ± 0.6% (k=2)**

# Conversion Factor Assessment

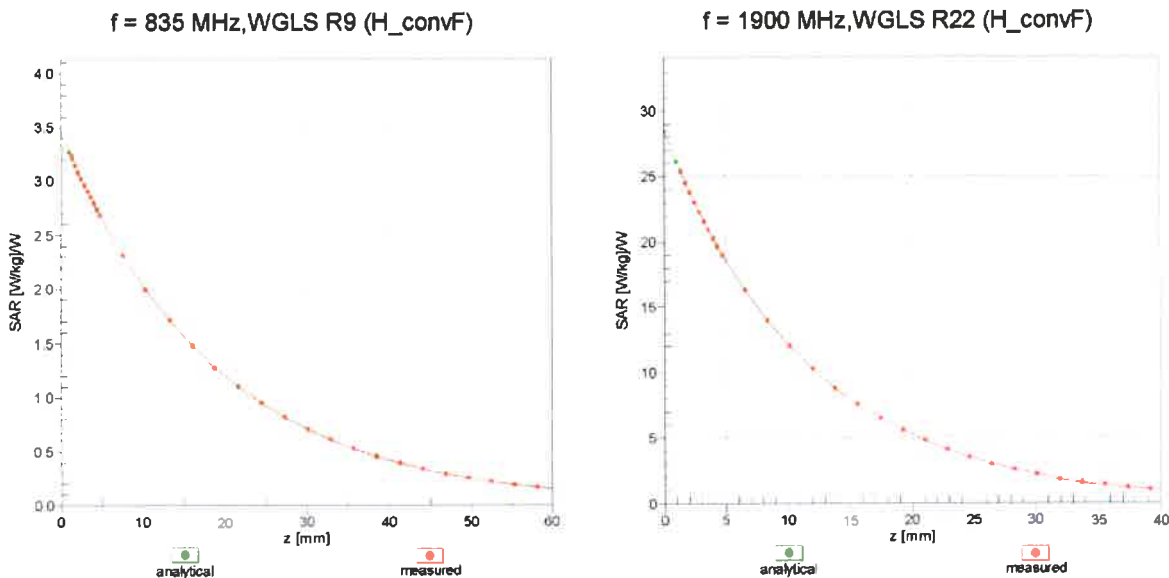

## Deviation from Isotropy in Liquid Error ( $\phi, \vartheta$ ), f = 900 MHz

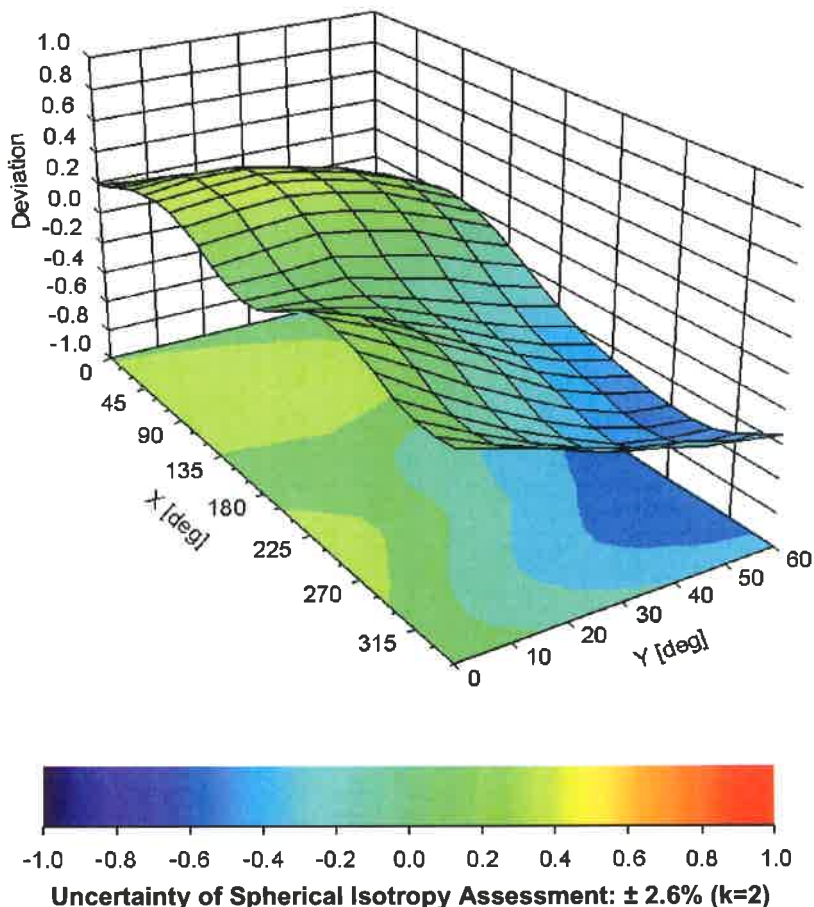

## DASY/EASY - Parameters of Probe: EX3DV4 - SN:3864

### Other Probe Parameters

Sensor Arrangement	Triangular
Connector Angle (°)	63
Mechanical Surface Detection Mode	enabled
Optical Surface Detection Mode	disabled
Probe Overall Length	337 mm
Probe Body Diameter	10 mm
Tip Length	9 mm
Tip Diameter	2.5 mm
Probe Tip to Sensor X Calibration Point	1 mm
Probe Tip to Sensor Y Calibration Point	1 mm
Probe Tip to Sensor Z Calibration Point	1 mm
Recommended Measurement Distance from Surface	1.4 mm



Accredited by the Swiss Accreditation Service (SAS)  
The Swiss Accreditation Service is one of the signatories to the EA  
Multilateral Agreement for the recognition of calibration certificates

Accreditation No.: **SCS 0108**

Client **B.V. ADT (Auden)**

Certificate No: **EX3-3971\_Mar15**

## CALIBRATION CERTIFICATE

Object **EX3DV4 - SN:3971**

Calibration procedure(s) **QA CAL-01.v9, QA CAL-14.v4, QA CAL-23.v5, QA CAL-25.v6  
Calibration procedure for dosimetric E-field probes**

Calibration date: **March 26, 2015**

This calibration certificate documents the traceability to national standards, which realize the physical units of measurements (SI).  
The measurements and the uncertainties with confidence probability are given on the following pages and are part of the certificate.

All calibrations have been conducted in the closed laboratory facility: environment temperature (22 ± 3)°C and humidity < 70%.

Calibration Equipment used (M&TE critical for calibration)

Primary Standards	ID	Cal Date (Certificate No.)	Scheduled Calibration
Power meter E4419B	GB41293874	03-Apr-14 (No. 217-01911)	Apr-15
Power sensor E4412A	MY41498087	03-Apr-14 (No. 217-01911)	Apr-15
Reference 3 dB Attenuator	SN: S5054 (3c)	03-Apr-14 (No. 217-01915)	Apr-15
Reference 20 dB Attenuator	SN: S5277 (20x)	03-Apr-14 (No. 217-01919)	Apr-15
Reference 30 dB Attenuator	SN: S5129 (30b)	03-Apr-14 (No. 217-01920)	Apr-15
Reference Probe ES3DV2	SN: 3013	30-Dec-14 (No. ES3-3013_Dec14)	Dec-15
DAE4	SN: 660	14-Jan-15 (No. DAE4-660_Jan15)	Jan-16
Secondary Standards	ID	Check Date (in house)	Scheduled Check
RF generator HP 8648C	US3642U01700	4-Aug-99 (in house check Apr-13)	In house check: Apr-16
Network Analyzer HP 8753E	US37390585	18-Oct-01 (in house check Oct-14)	In house check: Oct-15

	Name	Function	Signature
Calibrated by:	<b>Leif Klysner</b>	<b>Laboratory Technician</b>	
Approved by:	<b>Katja Pokovic</b>	<b>Technical Manager</b>	
			Issued: March 27, 2015

This calibration certificate shall not be reproduced except in full without written approval of the laboratory.



Accredited by the Swiss Accreditation Service (SAS)

Accreditation No.: **SCS 0108**

The Swiss Accreditation Service is one of the signatories to the EA Multilateral Agreement for the recognition of calibration certificates

### Glossary:

TSL	tissue simulating liquid
NORM <sub>x,y,z</sub>	sensitivity in free space
ConvF	sensitivity in TSL / NORM <sub>x,y,z</sub>
DCP	diode compression point
CF	crest factor (1/duty_cycle) of the RF signal
A, B, C, D	modulation dependent linearization parameters
Polarization $\phi$	$\phi$ rotation around probe axis
Polarization $\vartheta$	$\vartheta$ rotation around an axis that is in the plane normal to probe axis (at measurement center), i.e., $\vartheta = 0$ is normal to probe axis
Connector Angle	information used in DASY system to align probe sensor X to the robot coordinate system

### Calibration is Performed According to the Following Standards:

- IEEE Std 1528-2013, "IEEE Recommended Practice for Determining the Peak Spatial-Averaged Specific Absorption Rate (SAR) in the Human Head from Wireless Communications Devices: Measurement Techniques", June 2013
- IEC 62209-1, "Procedure to measure the Specific Absorption Rate (SAR) for hand-held devices used in close proximity to the ear (frequency range of 300 MHz to 3 GHz)", February 2005

### Methods Applied and Interpretation of Parameters:

- NORM<sub>x,y,z</sub>**: Assessed for E-field polarization  $\vartheta = 0$  ( $f \leq 900$  MHz in TEM-cell;  $f > 1800$  MHz: R22 waveguide). NORM<sub>x,y,z</sub> are only intermediate values, i.e., the uncertainties of NORM<sub>x,y,z</sub> does not affect the E<sup>2</sup>-field uncertainty inside TSL (see below *ConvF*).
- NORM(f)<sub>x,y,z</sub>** = NORM<sub>x,y,z</sub> \* *frequency\_response* (see Frequency Response Chart). This linearization is implemented in DASY4 software versions later than 4.2. The uncertainty of the frequency response is included in the stated uncertainty of *ConvF*.
- DCP<sub>x,y,z</sub>**: DCP are numerical linearization parameters assessed based on the data of power sweep with CW signal (no uncertainty required). DCP does not depend on frequency nor media.
- PAR**: PAR is the Peak to Average Ratio that is not calibrated but determined based on the signal characteristics
- A<sub>x,y,z</sub>; B<sub>x,y,z</sub>; C<sub>x,y,z</sub>; D<sub>x,y,z</sub>; VR<sub>x,y,z</sub>; A, B, C, D** are numerical linearization parameters assessed based on the data of power sweep for specific modulation signal. The parameters do not depend on frequency nor media. VR is the maximum calibration range expressed in RMS voltage across the diode.
- ConvF and Boundary Effect Parameters**: Assessed in flat phantom using E-field (or Temperature Transfer Standard for  $f \leq 800$  MHz) and inside waveguide using analytical field distributions based on power measurements for  $f > 800$  MHz. The same setups are used for assessment of the parameters applied for boundary compensation (alpha, depth) of which typical uncertainty values are given. These parameters are used in DASY4 software to improve probe accuracy close to the boundary. The sensitivity in TSL corresponds to NORM<sub>x,y,z</sub> \* ConvF whereby the uncertainty corresponds to that given for ConvF. A frequency dependent ConvF is used in DASY version 4.4 and higher which allows extending the validity from  $\pm 50$  MHz to  $\pm 100$  MHz.
- Spherical isotropy (3D deviation from isotropy)**: in a field of low gradients realized using a flat phantom exposed by a patch antenna.
- Sensor Offset**: The sensor offset corresponds to the offset of virtual measurement center from the probe tip (on probe axis). No tolerance required.
- Connector Angle**: The angle is assessed using the information gained by determining the NORM<sub>x</sub> (no uncertainty required).

# Probe EX3DV4

## SN:3971

Manufactured: December 30, 2013  
Calibrated: March 26, 2015

Calibrated for DASY/EASY Systems  
(Note: non-compatible with DASY2 system!)

## DASY/EASY - Parameters of Probe: EX3DV4 - SN:3971

### Basic Calibration Parameters

	Sensor X	Sensor Y	Sensor Z	Unc (k=2)
Norm ( $\mu\text{V}/(\text{V}/\text{m})^2$ ) <sup>A</sup>	0.41	0.53	0.50	$\pm 10.1 \%$
DCP (mV) <sup>B</sup>	98.6	96.3	99.4	

### Modulation Calibration Parameters

UID	Communication System Name		A dB	B dB $\sqrt{\mu\text{V}}$	C	D dB	VR mV	Unc <sup>E</sup> (k=2)
0	CW	X	0.0	0.0	1.0	0.00	137.4	$\pm 3.5 \%$
		Y	0.0	0.0	1.0		138.8	
		Z	0.0	0.0	1.0		144.3	

The reported uncertainty of measurement is stated as the standard uncertainty of measurement multiplied by the coverage factor k=2, which for a normal distribution corresponds to a coverage probability of approximately 95%.

<sup>A</sup> The uncertainties of NormX,Y,Z do not affect the E<sup>2</sup>-field uncertainty inside TSL (see Pages 5 and 6).

<sup>B</sup> Numerical linearization parameter: uncertainty not required.

<sup>E</sup> Uncertainty is determined using the max. deviation from linear response applying rectangular distribution and is expressed for the square of the field value.



## DASY/EASY - Parameters of Probe: EX3DV4 - SN:3971

### Calibration Parameter Determined in Head Tissue Simulating Media

f (MHz) <sup>C</sup>	Relative Permittivity <sup>F</sup>	Conductivity (S/m) <sup>F</sup>	ConvF X	ConvF Y	ConvF Z	Alpha <sup>G</sup>	Depth <sup>G</sup> (mm)	Unct. (k=2)
750	41.9	0.89	10.09	10.09	10.09	0.27	1.08	± 12.0 %
835	41.5	0.90	9.88	9.88	9.88	0.19	1.41	± 12.0 %
900	41.5	0.97	9.80	9.80	9.80	0.25	1.37	± 12.0 %
1450	40.5	1.20	8.71	8.71	8.71	0.28	1.12	± 12.0 %
1640	40.3	1.29	8.34	8.34	8.34	0.33	0.80	± 12.0 %
1750	40.1	1.37	8.26	8.26	8.26	0.35	0.80	± 12.0 %
1900	40.0	1.40	8.11	8.11	8.11	0.35	0.80	± 12.0 %
2000	40.0	1.40	8.10	8.10	8.10	0.36	0.80	± 12.0 %
2300	39.5	1.67	7.76	7.76	7.76	0.33	0.80	± 12.0 %
2450	39.2	1.80	7.38	7.38	7.38	0.33	0.80	± 12.0 %
2600	39.0	1.96	7.24	7.24	7.24	0.37	0.85	± 12.0 %
3500	37.9	2.91	6.95	6.95	6.95	0.20	1.50	± 13.1 %
5200	36.0	4.66	5.36	5.36	5.36	0.30	1.80	± 13.1 %
5300	35.9	4.76	5.18	5.18	5.18	0.30	1.80	± 13.1 %
5500	35.6	4.96	5.09	5.09	5.09	0.35	1.80	± 13.1 %
5600	35.5	5.07	4.80	4.80	4.80	0.40	1.80	± 13.1 %
5800	35.3	5.27	4.73	4.73	4.73	0.40	1.80	± 13.1 %

<sup>C</sup> Frequency validity above 300 MHz of ± 100 MHz only applies for DASY v4.4 and higher (see Page 2), else it is restricted to ± 50 MHz. The uncertainty is the RSS of the ConvF uncertainty at calibration frequency and the uncertainty for the indicated frequency band. Frequency validity below 300 MHz is ± 10, 25, 40, 50 and 70 MHz for ConvF assessments at 30, 64, 128, 150 and 220 MHz respectively. Above 5 GHz frequency validity can be extended to ± 110 MHz.

<sup>F</sup> At frequencies below 3 GHz, the validity of tissue parameters ( $\epsilon$  and  $\sigma$ ) can be relaxed to ± 10% if liquid compensation formula is applied to measured SAR values. At frequencies above 3 GHz, the validity of tissue parameters ( $\epsilon$  and  $\sigma$ ) is restricted to ± 5%. The uncertainty is the RSS of the ConvF uncertainty for indicated target tissue parameters.

<sup>G</sup> Alpha/Depth are determined during calibration. SPEAG warrants that the remaining deviation due to the boundary effect after compensation is always less than ± 1% for frequencies below 3 GHz and below ± 2% for frequencies between 3-6 GHz at any distance larger than half the probe tip diameter from the boundary.

## DASY/EASY - Parameters of Probe: EX3DV4 - SN:3971

### Calibration Parameter Determined in Body Tissue Simulating Media

f (MHz) <sup>C</sup>	Relative Permittivity <sup>F</sup>	Conductivity (S/m) <sup>F</sup>	ConvF X	ConvF Y	ConvF Z	Alpha <sup>G</sup>	Depth <sup>G</sup> (mm)	Unct. (k=2)
750	55.5	0.96	9.82	9.82	9.82	0.34	0.99	± 12.0 %
835	55.2	0.97	9.73	9.73	9.73	0.24	1.35	± 12.0 %
900	55.0	1.05	9.49	9.49	9.49	0.19	1.66	± 12.0 %
1450	54.0	1.30	8.14	8.14	8.14	0.25	1.41	± 12.0 %
1640	53.8	1.40	8.56	8.56	8.56	0.44	0.86	± 12.0 %
1750	53.4	1.49	8.04	8.04	8.04	0.45	0.83	± 12.0 %
1900	53.3	1.52	7.85	7.85	7.85	0.26	1.00	± 12.0 %
2000	53.3	1.52	7.77	7.77	7.77	0.31	0.97	± 12.0 %
2300	52.9	1.81	7.29	7.29	7.29	0.36	0.80	± 12.0 %
2450	52.7	1.95	7.12	7.12	7.12	0.32	0.80	± 12.0 %
2600	52.5	2.16	6.77	6.77	6.77	0.24	0.80	± 12.0 %
3500	51.3	3.31	6.59	6.59	6.59	0.20	1.90	± 13.1 %
5200	49.0	5.30	4.53	4.53	4.53	0.50	1.90	± 13.1 %
5300	48.9	5.42	4.30	4.30	4.30	0.50	1.90	± 13.1 %
5500	48.6	5.65	3.88	3.88	3.88	0.55	1.90	± 13.1 %
5600	48.5	5.77	3.81	3.81	3.81	0.55	1.90	± 13.1 %
5800	48.2	6.00	4.07	4.07	4.07	0.55	1.90	± 13.1 %

<sup>C</sup> Frequency validity above 300 MHz of ± 100 MHz only applies for DASY v4.4 and higher (see Page 2), else it is restricted to ± 50 MHz. The uncertainty is the RSS of the ConvF uncertainty at calibration frequency and the uncertainty for the indicated frequency band. Frequency validity below 300 MHz is ± 10, 25, 40, 50 and 70 MHz for ConvF assessments at 30, 64, 128, 150 and 220 MHz respectively. Above 5 GHz frequency validity can be extended to ± 110 MHz.

<sup>F</sup> At frequencies below 3 GHz, the validity of tissue parameters ( $\epsilon$  and  $\sigma$ ) can be relaxed to ± 10% if liquid compensation formula is applied to measured SAR values. At frequencies above 3 GHz, the validity of tissue parameters ( $\epsilon$  and  $\sigma$ ) is restricted to ± 5%. The uncertainty is the RSS of the ConvF uncertainty for indicated target tissue parameters.

<sup>G</sup> Alpha/Depth are determined during calibration. SPEAG warrants that the remaining deviation due to the boundary effect after compensation is always less than ± 1% for frequencies below 3 GHz and below ± 2% for frequencies between 3-6 GHz at any distance larger than half the probe tip diameter from the boundary.

# Frequency Response of E-Field

(TEM-Cell:ifi110 EXX, Waveguide: R22)

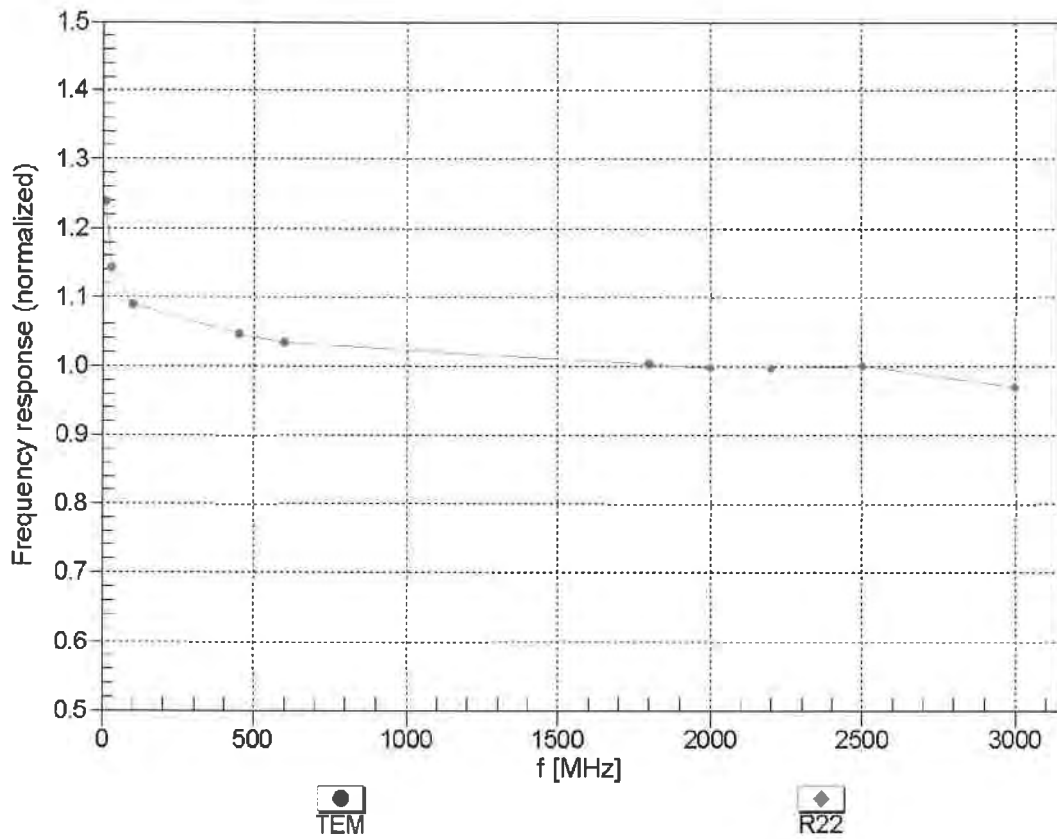

Uncertainty of Frequency Response of E-field:  $\pm 6.3\%$  (k=2)

### Receiving Pattern ( $\phi$ ), $\theta = 0^\circ$

f=600 MHz,TEM

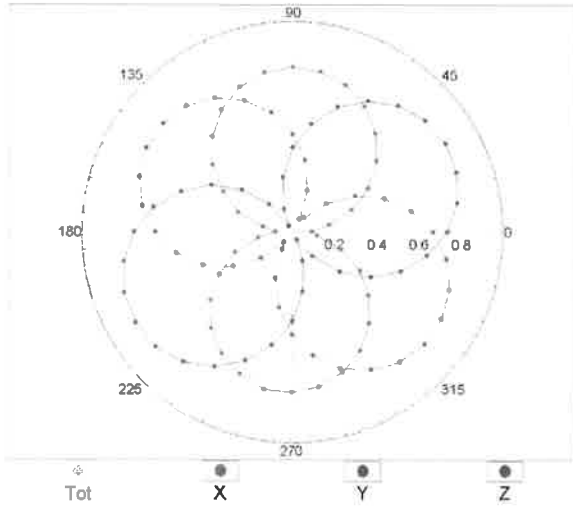

f=1800 MHz,R22

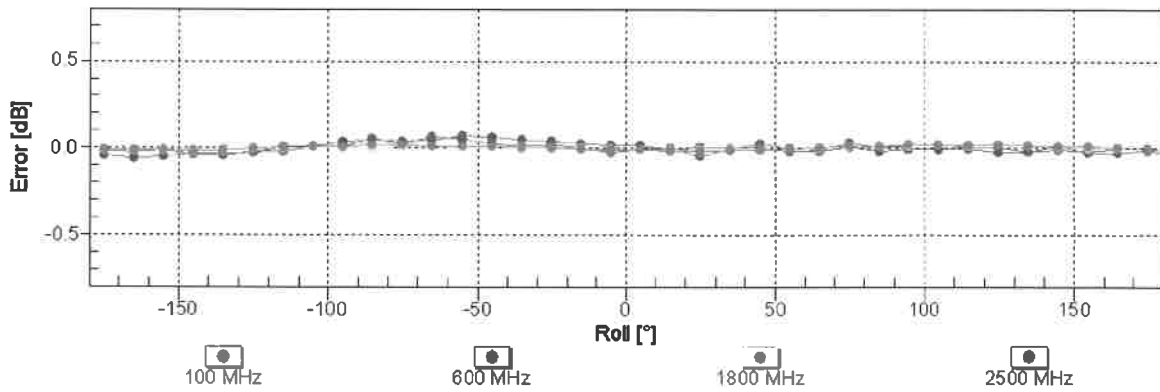
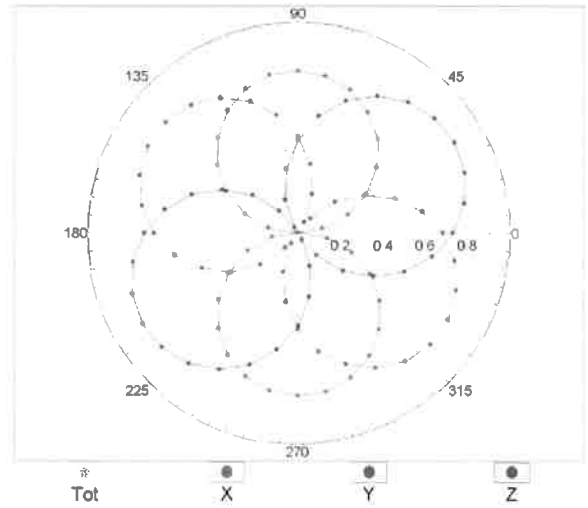

Uncertainty of Axial Isotropy Assessment:  $\pm 0.5\%$  (k=2)

### Dynamic Range f(SAR<sub>head</sub>) (TEM cell , f<sub>eval</sub>= 1900 MHz)

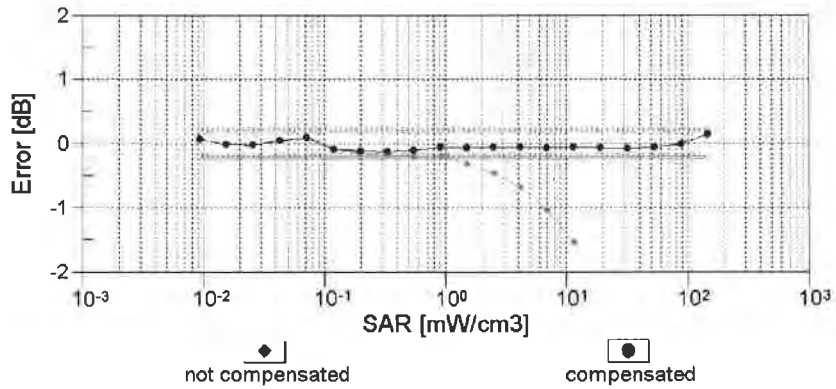
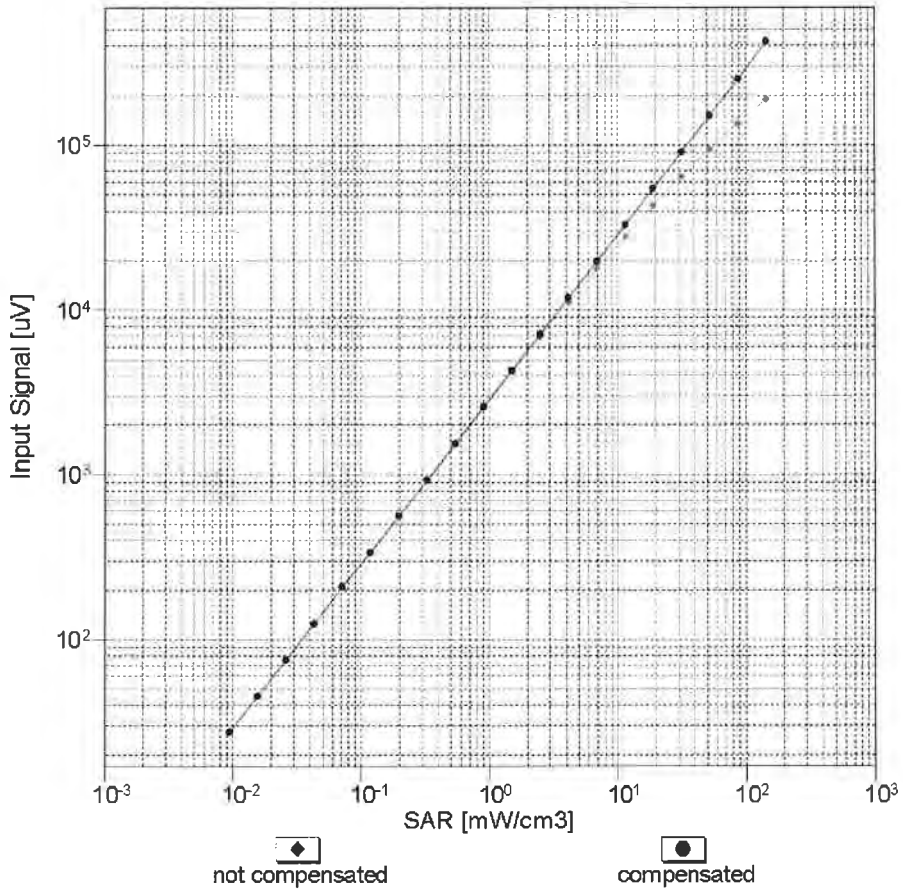

Uncertainty of Linearity Assessment: ± 0.6% (k=2)

# Conversion Factor Assessment

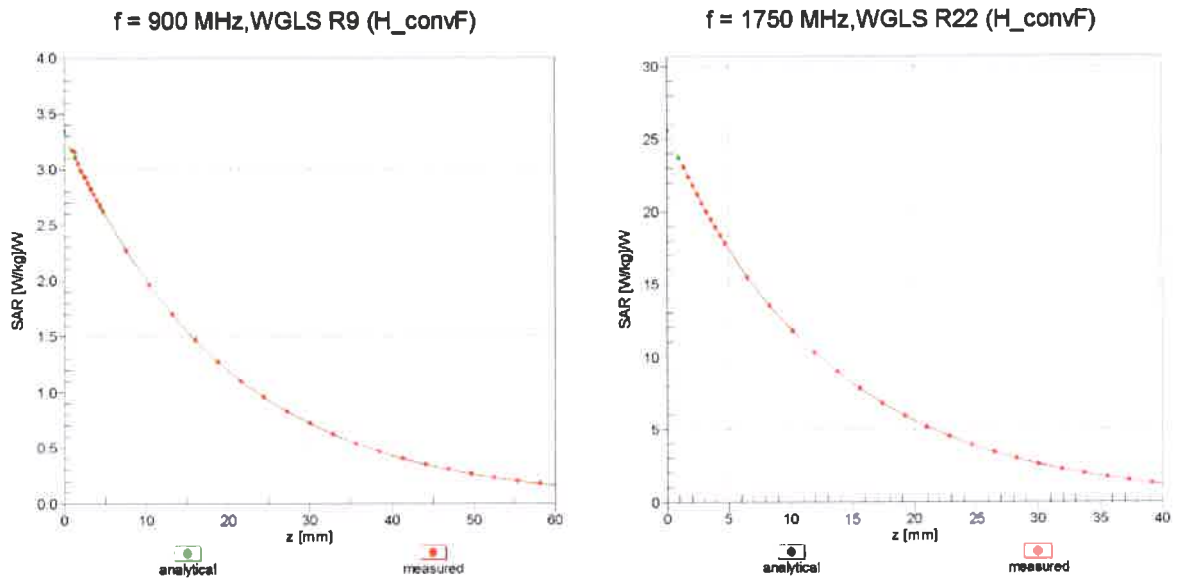

## Deviation from Isotropy in Liquid Error ( $\phi, \theta$ ), f = 900 MHz

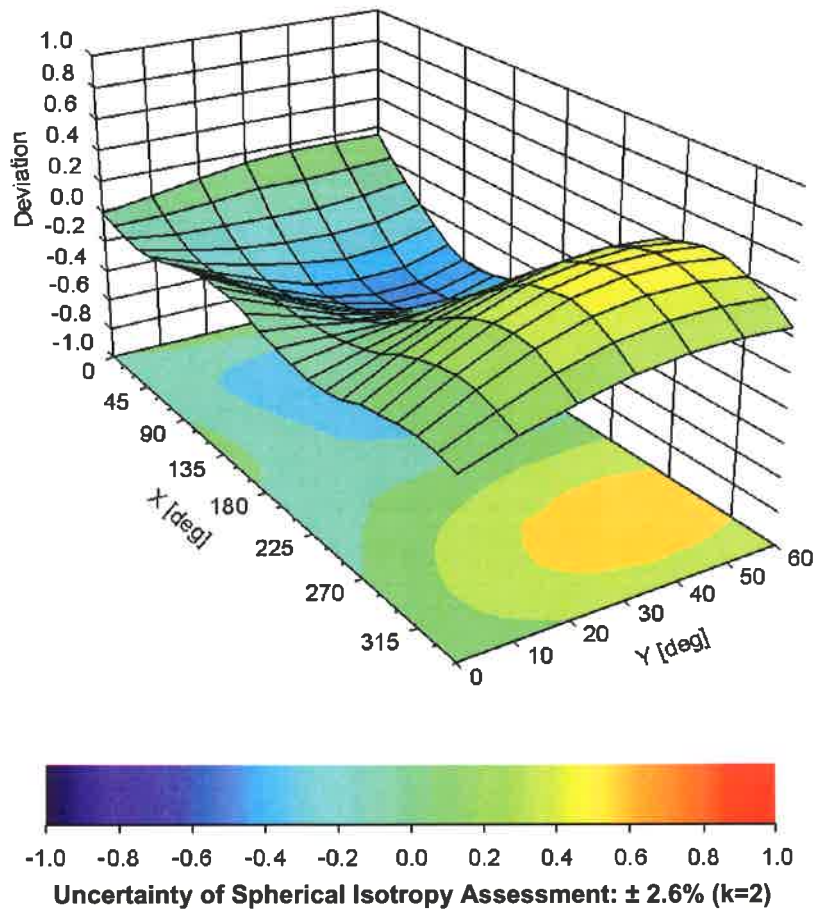

## DASY/EASY - Parameters of Probe: EX3DV4 - SN:3971

### Other Probe Parameters

Sensor Arrangement	Triangular
Connector Angle (°)	74.8
Mechanical Surface Detection Mode	enabled
Optical Surface Detection Mode	disabled
Probe Overall Length	337 mm
Probe Body Diameter	10 mm
Tip Length	9 mm
Tip Diameter	2.5 mm
Probe Tip to Sensor X Calibration Point	1 mm
Probe Tip to Sensor Y Calibration Point	1 mm
Probe Tip to Sensor Z Calibration Point	1 mm
Recommended Measurement Distance from Surface	1.4 mm



## Appendix D. Photographs of EUT and Setup